



US007989173B2

(12) **United States Patent  
Chen**(10) **Patent No.: US 7,989,173 B2**(45) **Date of Patent: Aug. 2, 2011**

- (54) **DETECTION AND DIAGNOSIS OF  
INFLAMMATORY DISORDERS**
- (75) Inventor: **Lieping Chen**, Sparks Glencoe, MD  
(US)
- (73) Assignee: **The Johns Hopkins University**,  
Baltimore, MD (US)
- (\* ) Notice: Subject to any disclaimer, the term of this  
patent is extended or adjusted under 35  
U.S.C. 154(b) by 0 days.

(21) Appl. No.: **12/198,014**(22) Filed: **Aug. 25, 2008**(65) **Prior Publication Data**

US 2009/0011444 A1 Jan. 8, 2009

**Related U.S. Application Data**(63) Continuation-in-part of application No. 11/965,425,  
filed on Dec. 27, 2006.(60) Provisional application No. 60/877,319, filed on Dec.  
27, 2006, provisional application No. 60/949,742,  
filed on Jul. 13, 2007.(51) **Int. Cl.**  
**G01N 33/53** (2006.01)(52) **U.S. Cl.** ..... **435/7.1**(58) **Field of Classification Search** ..... None  
See application file for complete search history.(56) **References Cited**

## U.S. PATENT DOCUMENTS

3,840,513 A 10/1974 Umezawa et al.  
4,272,398 A 6/1981 Jaffe  
4,376,110 A 3/1983 David et al.  
4,634,664 A 1/1987 Oestberg  
4,634,666 A 1/1987 Engleman et al.  
4,650,764 A 3/1987 Temin  
4,704,692 A 11/1987 Ladner  
4,769,330 A 9/1988 Paoletti et al.  
4,853,871 A 8/1989 Pantoliano et al.  
4,861,627 A 8/1989 Mathiowitz et al.  
4,861,719 A 8/1989 Miller  
4,925,673 A 5/1990 Steiner et al.  
4,946,778 A 8/1990 Ladner et al.  
5,013,556 A 5/1991 Woodle et al.  
5,120,727 A 6/1992 Kao et al.  
5,124,263 A 6/1992 Temin et al.  
5,155,020 A 10/1992 Paoletti et al.  
5,162,333 A 11/1992 Failli et al.  
5,175,099 A 12/1992 Wills  
5,202,332 A 4/1993 Hughes et al.  
5,204,243 A 4/1993 Paoletti et al.  
5,225,336 A 7/1993 Paoletti  
5,225,539 A 7/1993 Winter  
5,240,846 A 8/1993 Collins et al.  
5,260,203 A 11/1993 Ladner et al.  
5,278,056 A 1/1994 Bank et al.  
5,284,656 A 2/1994 Platz et al.  
5,304,489 A 4/1994 Rosen  
5,385,908 A 1/1995 Nelson et al.  
5,451,569 A 9/1995 Wong et al.  
5,484,790 A 1/1996 Failli et al.

5,530,006 A 6/1996 Waranis et al.  
5,530,101 A 6/1996 Queen  
5,545,806 A 8/1996 Lonberg  
5,559,112 A 9/1996 Skotnicki et al.  
5,565,332 A 10/1996 Hoogenboom  
5,567,709 A 10/1996 Skotnicki et al.  
5,569,825 A 10/1996 Lonberg  
5,585,089 A 12/1996 Queen  
5,625,126 A 4/1997 Lonberg  
5,633,425 A 5/1997 Lonberg  
5,661,016 A 8/1997 Lonberg  
5,693,761 A 12/1997 Queen  
5,693,762 A 12/1997 Queen  
5,733,743 A 3/1998 Johnson  
5,736,142 A 4/1998 Sette  
5,741,957 A 4/1998 Deboer  
5,770,429 A 6/1998 Lonberg  
5,780,462 A 7/1998 Lee et al.  
5,789,650 A 8/1998 Lonberg  
5,814,318 A 9/1998 Lonberg  
5,837,242 A 11/1998 Holliger  
5,849,992 A 12/1998 Meade  
5,858,657 A 1/1999 Winter  
5,871,907 A 2/1999 Winter  
5,874,299 A 2/1999 Lonberg  
5,877,218 A 3/1999 Herzig  
5,877,397 A 3/1999 Lonberg

(Continued)

## FOREIGN PATENT DOCUMENTS

WO WO 90/07861 7/1990

(Continued)

## OTHER PUBLICATIONS

Huang, "Structural chemistry and therapeutic intervention of protein-  
protein interactions in immune response, human immunodeficiency  
virus entry, and apoptosis," *Pharmacology and Therapeutics*, 86:  
201-15 (2000).Adachi, "Tumoricidal effect of human macrophage-colony-stimulat-  
ing factor against human-ovarian-carcinoma-bearing athymic mice  
and its therapeutic effect when combined with cisplatin", *Cancer  
Immunol. Immunother.* 37(1): 1-6, (1993).Aldovini, "Humoral and cell-mediated immune responses to live  
recombinant BCG-HIV vaccines", *Nature*, 351:479-482 (1991).Alexander, "Development of high potency universal DR-restricted  
helper epitopes by modification of high affinity DR-blocking  
peptides", *Immunity*, 1(9):751-761 (1994).

(Continued)

*Primary Examiner* — Ilia Ouspenski(74) *Attorney, Agent, or Firm* — Pabst Patent Group LLP(57) **ABSTRACT**

Soluble H4 (sH4) levels have been discovered to correlate  
with the stage or severity of inflammatory disorders including  
autoimmune disorders. In particular, circulating levels of sH4  
can be used as a diagnostic for determining the severity of an  
inflammatory disorder or the propensity for developing an  
inflammatory disorder. The severity of an inflammatory dis-  
order can be determined by assaying the levels of sH4 in a  
subject and comparing the levels of sH4 to reference sH4  
concentrations that correlate to specific stages of an inflam-  
matory disorder. The therapeutic efficacy of treatments for  
inflammatory disorders can also be determined by comparing  
levels of sH4 before and during treatment. Methods and  
devices for measuring sH4 are also provided.

**36 Claims, 15 Drawing Sheets**

## U.S. PATENT DOCUMENTS

5,989,591	A	11/1999	Nagi et al.
6,015,809	A	1/2000	Zhu et al.
6,468,546	B1	10/2002	Mitcham et al.
6,537,968	B1	3/2003	Lezdey et al.
6,891,030	B2	5/2005	Chen
6,962,980	B2	11/2005	Mitcham et al.
7,189,563	B2	3/2007	Eaton et al.
7,202,334	B1	4/2007	Mitcham et al.
7,304,149	B2	12/2007	Murphy et al.
7,622,565	B2	11/2009	Chen
2002/0165347	A1	11/2002	Fox et al.
2002/0168762	A1	11/2002	Lieping et al.
2004/0175380	A1	9/2004	Allison et al.
2004/0229795	A1	11/2004	Roemisch et al.
2005/0163772	A1	7/2005	Dong et al.
2005/0202536	A1	9/2005	Chen et al.
2008/0159998	A1	7/2008	Ichim
2008/0160036	A1	7/2008	Chen
2008/0177039	A1	7/2008	Chen
2008/0206235	A1	8/2008	Chen
2009/0022747	A1	1/2009	Chen
2009/0087416	A1	4/2009	Chen
2009/0124573	A1	5/2009	Mazmanian
2009/0142342	A1	6/2009	Chen

## FOREIGN PATENT DOCUMENTS

WO	WO 91/10741	7/1991
WO	WO 91/17271	11/1991
WO	WO 92/01047	1/1992
WO	WO 92/20791	11/1992
WO	WO 93/01222	1/1993
WO	WO 95/04738	2/1995
WO	WO 95/07707	3/1995
WO	WO 95/16691	6/1995
WO	WO 95/22972	8/1995
WO	WO 97/17613	5/1997
WO	WO 97/17614	5/1997
WO	WO 98/23635	6/1998
WO	WO 99/63088	12/1999
WO	WO 00/01385	1/2000
WO	WO 00/12758	3/2000
WO	WO 00/36107	6/2000
WO	0202587	1/2002
WO	2004022594	3/2004
WO	WO 2004/000221	12/2004
WO	WO 2004/113500	12/2004
WO	2006101487	9/2006
WO	2006124667	11/2006
WO	WO 2006/133396	12/2006
WO	2007039150	4/2007
WO	2007067681	6/2007
WO	WO 2008/083239	7/2008
WO	2009089036	7/2009

## OTHER PUBLICATIONS

- Amoura, et al., "Nucleosome-restricted antibodies are detected before anti-dsDNA and/or antihistone antibodies in serum of MRL-Mp lpr/lpr and +/+ mice, and are present in kidney eluates of lupus mice with proteinuria", *Arthritis Rheum.*, 37(11):1684-8 (1994).
- Bird, "Single-chain antigen-binding proteins", *Science*, 242:423-426 (1988).
- Bona, et al., "Immune Response : idiotypic anti-idiotypic network", *CRC Crit. Rev. Immunol.*, 1:33-81 (1981).
- Bonder, et al., "Essential role for neutrophil recruitment to the liver in concanavalin A-induced hepatitis", *J. Immunol.*, 172(1):45-53 (2004).
- Bordignon, "Gene therapy in peripheral blood lymphocytes and bone marrow for ADA-immunodeficient patients", *Science*, 270:470-475 (1995).
- Brown, et al., Treatment of mice with the neutrophil-depleting antibody RB6-8C5 results in early development of experimental lyme arthritis via the recruitment of Fr-I- polymorphonuclear leukocyte-like.
- Cassatella, "The production of cytokines by polymorphonuclear neutrophils", *Immunol. Today*, 16(1):21-6 (1995).
- Chapman, "A phase I trial of intraperitoneal recombinant interleukin 2 in patients with ovarian carcinoma", *Investigational New Drugs*, 6(3):179-188. (1988).
- Chapoval et al., "Immunoglobulin fusion proteins as a tool for evaluation of T-cell costimulatory molecules", *Methods Mol. Med.* 45:247-255(2000).
- Chapoval, "Immunoglobulin fusion proteins as a tool for evaluation of T-cell costimulatory molecules", *Mol. Biotechnol.*, 21:259-64 (2002).
- Chapoval, et al., B7-H3: a costimulatory molecule for T cell activation and IFN-gamma production, *Nat. Immunol.*, 2(3):269-74 (2001).
- Chen, "Co-inhibitory molecules of the B7-CD28 family in the control of T-cell Immunity", *Nat. Rev. Immunol.*, 4(5):33647 (2004).
- Chen, "Impaired glucose homeostasis, neutrophil trafficking and function in mice lacking the glucose-6-phosphate transporter", *Hum. Mol. Genet.*, 12:2547-2558 (2003).
- Chen, "Soluble TNF-alpha receptors are constitutively shed and downregulate adhesion molecule expression in malignant gliomas", *J. Neuropathol. Exp. Neurol.*, 56(5), 541-550 (1997).
- Chicz, "Specificity and promiscuity among naturally processed peptides bound to HLA-DR alleles", *J. Exp. Med.*, 178(1):27-47 (1993).
- Choi, "Genomic organization and expression analysis of B7-H4, an immune inhibitory molecule of the B7 family", *J. Immunol.*, 171:4650-4 (2003).
- Co, "Chimeric and humanized antibodies with specificity for the CD33 antigen", *J. Immunol.* 148(4):1149-1154 (1992).
- Coyle, et al., "The CD28-related molecule ICOS is required for effective T cell-dependent immune responses", *Immunity*, 13(1):95-105 (2000).
- Coyle, et al., "The expanding B7 superfamily: increasing complexity in costimulatory signals regulating T cell function", *Nat. Immunol.*, 2(3):203-9 (2001).
- Crystal, "Gene therapy strategies for pulmonary disease", *Am. J. Med.*, 92(6A):44S-52S (1992).
- Dau, et al., The fundamental basis for therapeutic plasmapheresis in autoimmune diseases, *Transfusion Sci.*, 17(2):235-44 (1996).
- De Oca, et al., "Polymorphonuclear neutrophils are necessary for the recruitment of CD8(+) T cells in the liver in a pregnant mouse model of *Chlamydia abortus* (*Chlamydia psittaci* serotype 1) infection", *Infect. Immun.*, 68(3):1746-51 (2000).
- Dong, "B7-H1 determines accumulation and deletion of intrahepatic CD8(+) T lymphocytes", *Immunity*, 20:327-336 (2004).
- Dong, "Tumor-associated B7-H1 promotes T-cell apoptosis: a potential mechanism of immune evasion", *Nature Med.*, 8:793-800 (2002).
- Dong, et al., "Costimulating aberrant T cell responses by B7-H1 autoantibodies in rheumatoid arthritis", *J. Clin. Invest.*, 111(3):363-70 (2003).
- Edwards, "Comparison of toxicity and survival following intraperitoneal recombinant interleukin-2 for persistent ovarian cancer after platinum: twenty-four-hour versus 7-day infusion", *J. Clin. Oncol.*, 15(11):3399-3407 (1997).
- Edwards, "The formation of a structure with the features of synovial lining by subcutaneous injection of air: an in vivo tissue culture system", *J. Pathol.*, 134:147-156 (1981).
- Eyles, et al., "Granulocyte colony-stimulating factor and neutrophils-forgotten mediators of inflammatory disease", *Nat. Clin. Pract. Rheumatol.*, 2(9):500-10 (2006).
- Faas, et al., "Primary structure and functional characterization of a soluble, alternatively spliced form of B7-1", *J. Immunol.*, 164(12):6340-8 (2000).
- Falk, "Pool sequencing of natural HLA-DR, DQ, and DP ligands reveals detailed peptide motifs, constraints of processing, and general rules", *Immunogenetics*, 39(4):230-242 (1994).
- Falkner, et al., "pUV I: a new vaccinia virus insertion and expression vector", *Nucleic Acids Res.*, 15(17):7192 (1987).
- Fava, et al., "Critical role of peripheral-blood phagocytes and the involvement of complement in tumour necrosis factor enhancement of passive collagen-arthritis", *Clin. Exp. Immunol.*, 94(2): 261-8 (1993).
- Feldmann, "Rheumatoid arthritis", *Cell*, 85(3):307-10 (1996).

- Fink, "Monoclonal antibodies as diagnostic reagents for the identification and characterization of human tumor antigens", *Prog. Clin. Pathol.*, 9:121-133 (1984).
- Freedman, "Intraperitoneal adoptive immunotherapy of ovarian carcinoma with tumor-infiltrating lymphocytes and low-dose recombinant interleukin-2: a pilot trial", *J. of Immunotherapy Emphasis Tumor Immunol.*, 16(3):198-210 (1994).
- Guatelli, "Isothermal, in vitro amplification of nucleic acids by a multienzyme reaction modeled after retroviral replication", *Proc. Natl. Acad. Sci. USA*, 87(5):1874-1878 (1990).
- Halloran, et al., "The role of an epithelial neutrophil-activating peptide-78-like protein in rat adjuvant-induced arthritis", *J. Immunol.*, 162(12):7492-500 (1999).
- Hammer, "Promiscuous and allele-specific anchors in HLA-DR-binding peptides", *Cell*, 74(1):197-203 (1993).
- Henikoff, "Amino acid substitution matrices from protein blocks", *Proc. Natl. Acad. Sci. U.S.A.*, 89:10915-10919 (1992).
- Hickman, "Gene expression following direct injection of DNA into liver", *Hum. Gene Ther.*, 5:1477-1483 (1994).
- Hill, et al., "A field guide to foldamers", *Chem Rev.*, 101(12):3893-4012 (2001).
- Hochman, "An active antibody fragment (Fv) composed of the variable portions of heavy and light chains", *Biochemistry*, 12:1130-1135 (1973).
- Hubbard, et al., "Anti-neutrophil-elastase defenses of the lower respiratory tract in alpha 1-antitrypsin deficiency directly augmented with an aerosol of alpha 1-antitrypsin", *Ann. Intern. Med.*, 111(3):206-12 (1989).
- Huse, "Generation of a large combinatorial library of the immunoglobulin repertoire in phage lambda", *Science*, 246(4935):1275-1281 (1989).
- Huston, "Protein engineering of antibody binding sites: recovery of specific activity in an anti-digoxin single-chain Fv analogue produced in *Escherichia coli*", *Proc. Natl. Acad. Sci. USA*, 85:5879-5883 (1988).
- Ikonomidis, "Delivery of a viral-antigen to the class I processing and presentation pathway by *Listeria monocytogenes*", *J. Exp. Med.*, 180:2209-2218 (1994).
- Jablonska and Peitruska, "Release of soluble tumor necrosis factor receptors from polymorphonuclear cells of breast cancer patients", *Arch. Immunol. Ther. Exp. (Warsz)*, 45(5-6), 449-453 (1997).
- Jeannin, et al., "Soluble CD86 is a costimulatory molecule for human T lymphocytes", *Immunity*, 13(3):303-12 (2000).
- Jerne, "Towards a network theory of the immune system" *Ann. Immunol.*, 125C:373-389 (1974).
- Jost, "Mammalian expression and secretion of functional single-chain Fv molecules", *J Biol Chem.*, 269:26267-26273 (1994).
- Kakimoto, et al., "Suppressive effect of a neutrophil elastase inhibitor on the development of collagen-induced arthritis", *Cell Immunol.*, 165(1):26-32 (1995).
- Kamata, "src homology 2 domain-containing tyrosine phosphatase SHP-1 controls the development of allergic airway inflammation", *J. Clin. Invest.*, 111:109-119 (2003).
- Keir and Sharpe, "The B7/CD28 costimulatory family in autoimmunity", *Immunol. Rev.*, 204:128-43 (2005).
- Kelley and Roths, "Interaction of mutant lpr gene with background strain influences renal disease", *Clin. Immunol. Immunopathol.*, 37(2):220-9 (1985).
- Kikuchi, "Effects of granulocyte-colony-stimulating factor and interleukin-2 on ascites formation and the survival time of nude mice bearing human ovarian cancer cells", *Cancer Immunol. Immunother.*, 43(5): 257-261 (1996).
- Knapp and Liu, "Hydrodynamic delivery of DNA", *Methods Mol. Bio.*, 245:245-50 (2004).
- Kohler and Milstein, "Continuous cultures of fused cells secreting antibody of predefined specificity", *Nature*, 256:495-497 (1975).
- Kotzin, "Systemic lupus erythematosus", *Cell*, 85(3), 303-6 (1996).
- Krambeck, et al., "B7-H4 expression in renal cell carcinoma and tumor vasculature: associations with cancer progression and survival", *Proc. Natl. Acad. Sci. USA*, 103(27):10391-10396 (2006).
- Kryczek, "B7-H4 expression identifies a novel suppressive macrophage population in human ovarian carcinoma", *J. Exp. Med.*, 203:871-881 (2006).
- Kryczek, et al., "Cutting edge: Induction of B7-H4 on APCs through IL-10: Novel suppressive mode for regulatory T cells", *J. Immunol.*, 177(1):40-44 (2006).
- Lewis, "PCRs Competitors Are Alive and Well and Moving Rapidly Towards Commercialization", *Genetic Engineering News* 12:1-3 (1992).
- Li, et al., "Biochemical analysis of the regulatory T cell protein lymphocyte activation gene-3 (LAG-3 CD223)", *J. Immunol.*, 173(11):6806-12 (2004).
- Liang, et al., "Autoantibody responses and pathology regulated by B7-1 and B7-2 costimulation in MRL/lpr lupus", *J. Immunol.*, 165(6):3436-43 (2000).
- Lissoni, "Intracavitary administration of interleukin-2 as palliative therapy for neoplastic effusions", *Tumori*, 78(2):118-120 (1992).
- Liu, "Cationic transfection lipids", *Curr. Med. Chem.*, 10:1307-1315 (2003).
- Lowenstein, "Simultaneous detection of amplicon and HSV-1 helper encoded proteins reveals that neurons and astrocytoma cells do express amplicon-borne transgenes in the absence of synthesis of virus immediate early proteins", *Brain Res. Molec. Brain Res.*, 30:169-175 (1995).
- Malchesky, et al. "Are selective macromolecule removal plasmapheresis systems useful for autoimmune diseases or hyperlipidemia?", *ASAIO J.* 39(4):868-72 (1993).
- Mathiowitz and Langer, "Polyanhydride microspheres as drug carriers. I. Hot-melt microencapsulation", *J. Controlled Release*, 5:13-22 (1987).
- Mathiowitz, "Novel microcapsules for delivery systems", *Reactive Polymers*, 6:275-283 (1987).
- Mathiowitz, "Polyanhydride microspheres as drug carriers: II. microencapsulation by solvent removal", *J. Appl. Polymer Sci.*, 35:755-774 (1988).
- McColl, et al., "Treatment with anti-granulocyte antibodies inhibits the effector phase of experimental autoimmune encephalomyelitis", *J. Immunol.*, 161(11), 6421-6 (1998).
- Medina, et al. "Therapeutic effect of phenantroline in two rat models of inflammatory bowel disease", *Scand. J. Gastroenterol.*, 36(12):1314-9 (2001).
- Metzler, et al., "Solution structure of human CTLA-4 and delineation of a CD80/CD86 binding site conserved in CD28", *Nat. Struct. Biol.*, 4(7):527-31 (1997).
- Michael, et al., "The hematologic aspects of disseminated (systemic) lupus erythematosus", *Blood*, 6(11):1059-72 (1951).
- Moreland, "Treatment of rheumatoid arthritis with a recombinant human tumor necrosis factor receptor (p75)-Fc fusion protein", *N. Engl. J. Med.*, 337:141-7 (1997).
- Moss, "Poxvirus expression vectors", *Curr. Top. Microbiol. Immunol.*, 158:25-38 (1992).
- Moss, "Poxvirus vectors: cytoplasmic expression of transferred genes", *Curr. Opin. Genet. Dev.*, 3:86-90 (1993).
- Moss, "Use of vaccinia virus as an infectious molecular cloning and expression vector", *Gene Amplif. Anal* 3:201-213 (1983).
- Moss, "Vaccinia virus vectors", *Biotechnology*, 20: 345-362 (1992).
- Moss, "Vaccinia virus: a tool for research and vaccine development", *Science*, 252:1662-1667 (1991).
- Murphy, "Long-term correction of obesity and diabetes in genetically obese mice by a single intramuscular injection of recombinant adeno-associated virus encoding mouse leptin", *Proc Natl Acad Sci.*, 94:13921-13926 (1997).
- Nandakumar, et al., "Collagen type II-specific monoclonal antibody-induced arthritis in mice: description of the disease and the influence of age, sex, and genes", *Am. J. Pathol.*, 163(5), 1827-37 (2003).
- Nathan, "Neutrophils and immunity: challenges and opportunities", *Nature Rev. Immunol.*, 6:173-182 (2006).
- Needleman and Wunsch, "A general method applicable to the search for similarities, in the amino acid sequence of two proteins", *J. Mol. Biol.*, 48:443-453 (1970).
- Newmark, et al., Preparation and properties of adducts of streptokinase and streptokinase-plasmin complex with polyethylene glycol and pluronic Polyol F38 *J. Appl. Biochem.* 4: 185-189 (1982).
- O'Brien, "An improved method of preparing microcarriers for biolistic transfection", *Brain Res. Brain Res. Protoc.*, 10:12-15 (2002).

- Ostberg, et al., "Human X (mouse X human) hybridomas stably producing human antibodies", *Hybridoma*, 2:361-367 (1983).
- Oswein, et al., "Aerosolization of Proteins", in *Proceedings of Symposium on Respiratory Drug Delivery II*. (recombinant human growth hormone), Keystone, CO. (1990).
- Ottow, et al., "Immunotherapy of intraperitoneal cancer with interleukin 2 and lymphokine-activated killer cells reduces tumor load and prolongs survival in murine models" *Cellular Immunology*, 104:366-376 (1987).
- Ou, et al., "B7-H4 Ig Inhibits human beta cell destruction mediated by beta cell-specific cytotoxic T cells derived from patients with type 1 diabetes", *Diabetes*, 54(Suppl.1):A311 (2005).
- Parra and Bond, "Inverse agonism: from curiosity to accepted dogma, but is it clinically relevant?", *Curr. Opin. Pharmacol.*, 7(2):146-50 (2007).
- Peplinski, "Vaccinia virus for human gene therapy", *Surgical Oncology Clinics of North America*, 7: 575-588 (1998).
- Piccini, "Vaccinia: virus, vector, vaccine", *Adv. Virus Res.*, 34:43-64 (1988).
- Pillinger and Abramson, "The neutrophil in rheumatoid arthritis", *Rheum. Dis. Clin. North. Am.*, 21(3):691-714 (1995).
- Pluckthun, "Expression of functional antibody Fv and Fab fragments in *Escherichia coli*", *Methods Enzymol.*, 178: 497-515 (1989).
- Poirier, "Protective immunity evoked by oral administration of attenuated aroA *Salmonella typhimurium* expressing cloned streptococcal M protein", *J. Exp. Med.*, 168:25-32 (1988).
- Prasad, et al., "B7S1, a novel B7 family member that negatively regulates T cell activation", *Immunity*, 18(6):863-873 (2003).
- Queen, "A humanized antibody that binds to the interleukin 2 receptor", *Proc. Natl. Acad. Sci. USA*, 86(24):10029-10033 (1989).
- Queen, "Cell-type specific regulation of a kappa immunoglobulin gene by promoter and enhancer elements", *Immunol. Rev.*, 89:49 (1986).
- Quismorio, "Hematologica and lymphoid abnormalities in systemic lupus erythematosus" in *Dubio's Lupus Erythematosus*, (eds. Wallace and Han), Lippincott & Williams: Philadelphia, PA, pp. 793-819 (2002).
- Radsak, "The heat shock protein Gp96 binds to human neutrophils and monocytes and stimulates effector functions", *Blood*, 101:2810-2815 (2003).
- Radsak, "Triggering receptor expressed on myeloid cells-1 in neutrophil inflammatory responses: differential regulation of activation and survival", *J. Immunol.*, 172:4956-4963 (2004).
- Rajewsky, "Genetics, expression, and function of idiotypes", *Ann. Rev. Immunol.*, 1:569-607 (1983).
- Reynolds, "Chimeric viral vectors—the best of both worlds", *Molecular Medicine Today*, 5:25-31 (1999).
- Rousseaux, "Optimal conditions for the preparation of proteolytic fragments from monoclonal IgG of different rat IgG subclasses", *Meth. Enzymol.*, 121:663-69 (1986).
- Sadoff, "Oral *Salmonella typhimurium* vaccine expressing circumsporozoite protein protects against malaria", *Science*, 240:336-338 (1988).
- Salceda, et al. "The immunomodulatory protein B7-H4 is overexpressed in breast and ovarian cancers and promotes epithelial cell transformation", *Exp. Cell Res.*, 306(1):128-41 (2005).
- Samulski, "Targeted integration of adeno-associated virus (AAV) into human chromosome 19", *EMBO J.*, 10:3941-3950 (1991).
- Santos, et al., "Anti-neutrophil monoclonal antibody therapy inhibits the development of adjuvant arthritis", *Clin. Exp. Immunol.*, 107(2):24-53 (1997).
- Scapini, et al., "The neutrophil as a cellular source of chemokines", *Immunol. Rev.*, 177: 195-203 (2000).
- Schafer, "Induction of a cellular immune response to a foreign antigen by a recombinant *Listeria monocytogenes* vaccine", *J. Immunol.*, 149:53-59 (1992).
- Schimmer, et al., "Streptococcal cell wall-induced arthritis. Requirements for neutrophils, P-selectin, intercellular adhesion molecule-1, and macrophage-inflammatory protein-2", *J. Immunol.*, 159(8):4103-8 (1997).
- Sharon, "Preparation of Fv fragment from the mouse myeloma XRPC-25 immunoglobulin possessing anti-dinitrophenyl activity", *Biochemistry*, 15:1591-1594 (1976).
- Sica, "B7-H4, a molecule of the B7 family, negatively regulates T cell immunity", *Immunity*, 18:849-861 (2003).
- Simon, et al., "B7-H4 is a novel membrane-bound protein and a candidate serum and tissue biomarker for ovarian cancer", *Cancer Res.*, 66(3):1570-1575 (2006).
- Sinigaglia, "A malaria T-cell epitope recognized in association with most mouse and human MHC class II molecules", *Nature*, 336(6201):778-780 (1988).
- Skerra, "Assembly of a functional immunoglobulin Fv fragment in *Escherichia coli*", *Science*, 240: 1038-1041 (1988).
- Skolnick, et al., "From genes to protein structure and function: novel applications of computational approaches in the genomic era", *Trends Biotechnol.*, 18(1):34-9 (2000).
- Son, "Cisplatin-based interferon gamma gene therapy of murine ovarian carcinoma", *Cancer Gene Therapy*, 4(6):391-396 (1997).
- Soriano, "Targeted and nontargeted liposomes for in vivo transfer to rat liver cells of a plasmid containing the preproinsulin I gene", *Proc. Natl. Acad. Sci. USA*, 80:7128-7131 (1983).
- Southwood, "Several common HLA-DR types share largely overlapping peptide binding repertoires", *J. Immunology*, 160(7):3363-3373 (1998).
- Sparano, "Phase II trials of high-dose interleukin-2 and lymphokine-activated killer cells in advanced breast carcinoma and carcinoma of the lung, ovary, and pancreas and other tumors", *J. of Immunotherapy Emphasis Tumor Immunol.*, 16(3):216-223 (1994).
- Stone, "Viral vectors for gene delivery and gene therapy within the endocrine system", *J. Endocrinology*, 164:103-118 (2000).
- Stover, "New use of BCG for recombinant vaccines", *Nature*, 351:456-460 (1991).
- Sugaya, "Inhibition of tumor growth by direct intratumoral gene transfer of herpes simplex virus thymidine kinase gene with DNA-liposome complexes", *Hum. Gene Ther.*, 7(2):223-230 (1996).
- Suh, "Generation and characterization of B7-H4/B7S1/B7x-deficient mice", *Mol. Cell. Biol.*, 26:6403-6411 (2006).
- Sun, et al., "B7-H3 and B7-H4 expression in non-small-cell lung cancer", *Lung Cancer*, 53 (2):143-151 (2006).
- Sun, et al., "Costimulatory molecule-targeted antibody therapy of a spontaneous autoimmune disease", *Nat. Med.* 8(12):1405-13 (2002).
- Sutter and Moss, "Nonreplicating vaccinia vector efficiently expresses recombinant genes", *Proc. Natl. Acad. Sci. USA*, 89(22):10847-51 (1992).
- Szala, "The use of cationic liposomes DC-CHOL/DOPE and DDAB/DOPE for direct transfer of *Escherichia coli* cytosine deaminase gene into growing melanoma tumors", *Gene Therapy*, 3(11): 1026-1031 (1996).
- Tada, et al., "CD28-deficient mice are highly resistant to collagen-induced arthritis", *J. Immunol.*, 162(1):203-8 (1999).
- Tamada, "Cutting edge: selective impairment of CD8+ T cell function in mice lacking the TNF superfamily member LIGHT", *J. Immunol.*, 168:4832-4835 (2002).
- Tamada, "Modulation of T-cell-mediated immunity in tumor and graft-versus-host disease models through the LIGHT co-stimulatory pathway", *Nature Med.*, 6:283-289 (2000).
- Tamura, "B7-H1 costimulation preferentially enhances CD28-independent T-helper cell function", *Blood*, 97:1809-1816 (2001).
- Titomirov, "In vivo electroporation and stable transformation of skin cells of newborn mice by plasmid DNA", *Biochim. Biophys. Acta.*, 1088:131-134 (1991).
- Tringler, et al., "B7-H4 is highly expressed in ductal and lobular breast cancer", *Clin. Cancer Res.*, 11(5):1842-1848 (2005).
- Tringler, et al., "B7-H4 overexpression in ovarian tumors", *Gynecol. Oncol.*, 100(1):44-52 (2005).
- Tsushima, "Preferential contribution of B7-H1 to programmed death-1-mediated regulation of hapten-specific allergic inflammatory responses", *Eur. J. Immunol.*, 33:2773-2782 (2003).
- Urbain, "Idiotypes, recurrent idiotypes and internal images", *Ann. Immunol.* 133D(2):179-189 (1982).
- Wahl, "Improved radioimaging and tumor localization with monoclonal F(ab')<sub>2</sub>", *J. Nuc. Med.* 24:316-325 (1983).
- Wan, et al., "Aberrant regulation of synovial T cell activation by soluble costimulatory molecules in rheumatoid arthritis", *J. Immunol.*, 177(12):8844-50 (2006).

- Wang, "pH-sensitive immunoliposomes mediate target-cell-specific delivery and controlled expression of a foreign gene in mouse", *Proc. Natl. Acad. Sci. USA*, 84:78-51 (1987).
- Watanabe, et al., "BTLA is a lymphocyte inhibitory receptor with similarities to CTLA-4 and PD-1", *Nature Immunol.*, 4(7):670-679 (2006).
- Weiss and Taylor, "Retrovirus receptors", *Cell*, 82:531-533 (1995).
- Weiss, "Hot prospect for new gene amplifier", *Science* 254:1292-1293 (1991).
- Wilcox, "Ligation of CD137 receptor prevents and reverses established anergy of CD8+ cytolytic T lymphocytes in vivo", *Blood*, 103 :177-184 (2004).
- Williams, "Synergy between anti-CD4 and anti-tumor necrosis factor in the amelioration of established collagen-induced arthritis", *Proc. Natl. Acad. Sci. U. S. A.*, 91:2762-6 (1994).
- Williams, et al., "Introduction of foreign genes into tissues of living mice by DNA-coated microprojectiles", *Proc. Natl. Acad. Sci. USA*, 88(7):2726-30 (1991).
- Wilson, "Hepatocyte-directed gene transfer in vivo leads to transient improvement of hypercholesterolemia in low density lipoprotein receptor-deficient rabbits", *J. Biol. Chem.*, 267:963-967 (1992).
- Winter, "Man-made antibodies", *Nature*, 349:293-299 (1991).
- Wipke and Allen, "Essential role of neutrophils in the initiation and progression of a murine model of rheumatoid arthritis", *J. Immunol.*, 167(3):1601-8 (2001).
- Wolff, "Direct gene transfer into mouse muscle in vivo", *Science*, 247:1465-1468 (1990).
- Wong, "Human GM-CSF: molecular Cloning of the complementary DNA and purification of the natural and recombinant proteins", *Science*, 228(4701):810-815 (1985).
- Wu, "Receptor-mediated gene delivery and expression in vivo", *J. Biol. Chem.*, 263:14621-14624 (1988).
- Wu, "Targeting genes: delivery and persistent expression of a foreign gene driven by mammalian regulatory elements in vivo", *J. Biol. Chem.*, 264:16985-16987 (1989).
- Yu, "Liposome-mediated in-vivo E1A gene transfer suppressed dissemination of ovarian cancer cells that overexpress HER-2/neu", *Oncogene*, 11(7):1383-1388 (1995).
- Zakaria, et al., "Plasmapheresis in severe autoimmune hepatitis", *Hepatology*, 34(4):A529 (2001).
- Zang, et al., "B7x: A widely expressed B7 family member that inhibits T cell activation", *Proc. Natl. Acad. Sci. USA*, 100(18):10388-10392 (2003).
- Attwood, "The Babel of Bioinformatics", *Science Compass*, 290:471-73 (2000).
- Genbank Accession No. AY280972.1 "Homo sapiens immune costimulatory protein B7-H4 mRNA, complete cds", 2 pages, submitted Apr. 22, 2003, first published Jun. 1, 2003, accessed Feb. 18, 2009.
- Afzali, et al., "The role of T helper 17 (Th17) and regulatory T cells (Treg) in human organ transplantation and autoimmune disease", *Clin Exp Immunol*, 148 (1):32-46 (2007).
- Blazar, et al., "Infusion of anti B7.1 (CD80) and anti-B7.2 (CD86) monoclonal antibodies inhibits murine graft-versus-host disease lethality in part via direct effects on CD4+ and CD8+ T cells", *J. Immunology*, 157: 3250-3259 (1996).

FIG. 1a

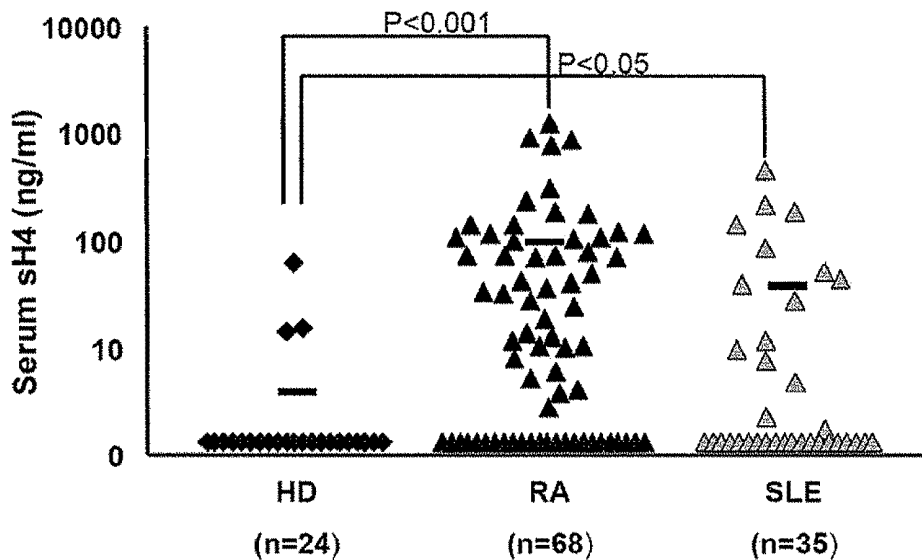

FIG. 1b

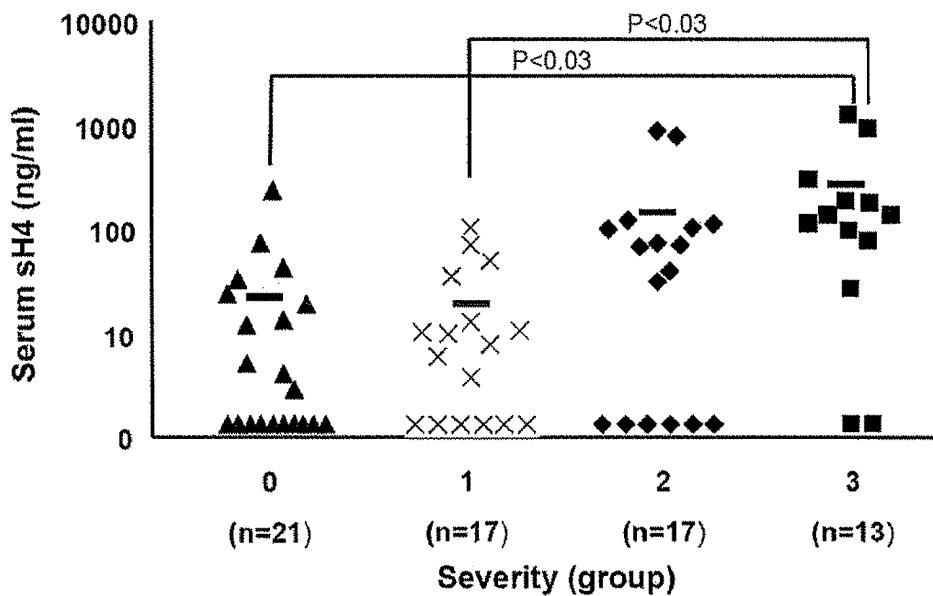

FIG. 2

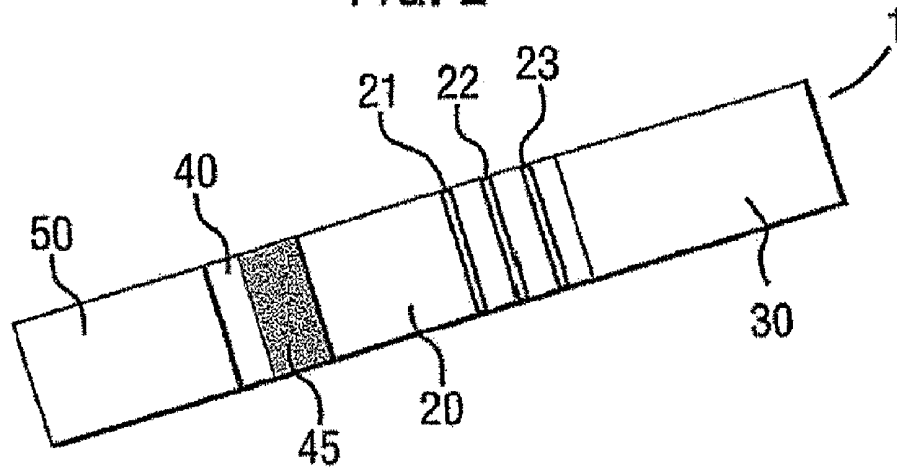

FIG. 3

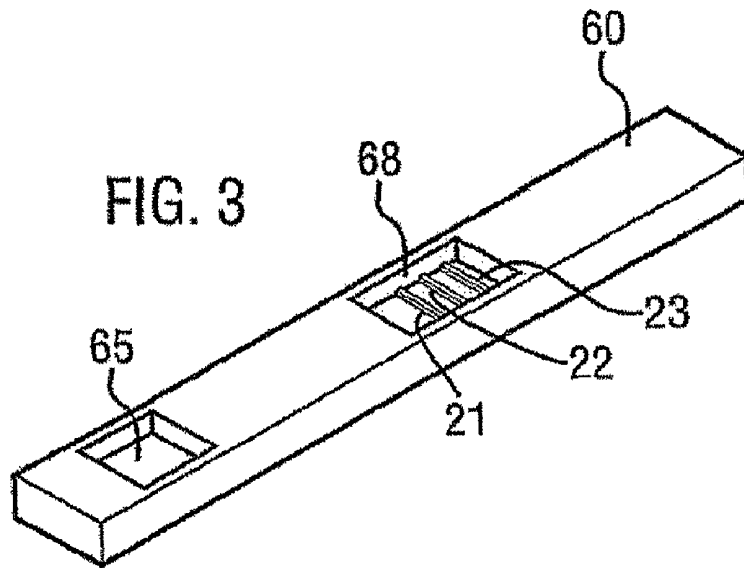

Figure 4a

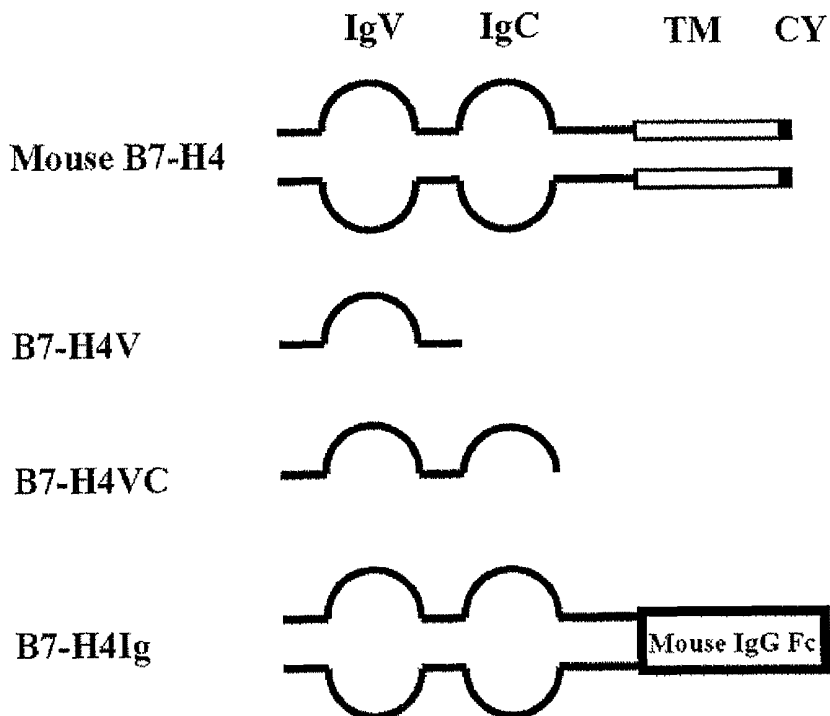

Figure 4b

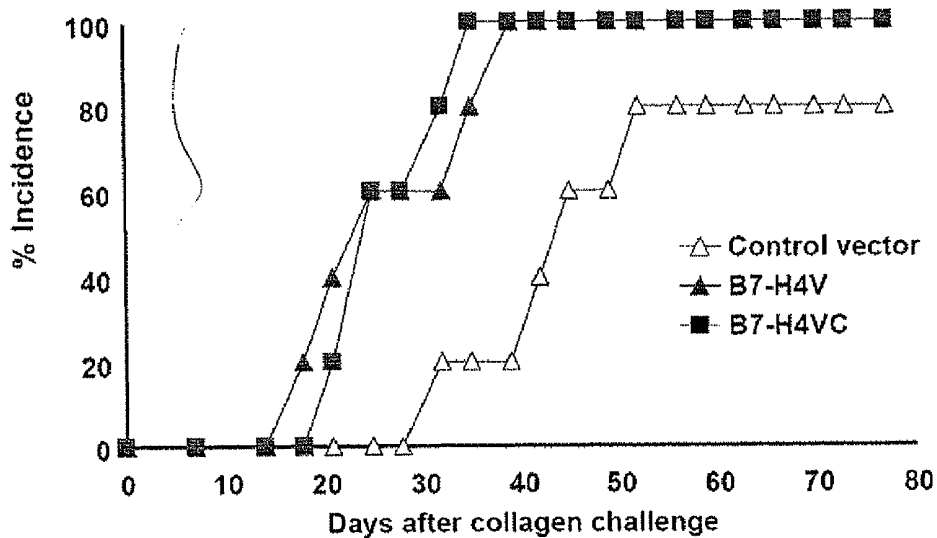

Figure 4c

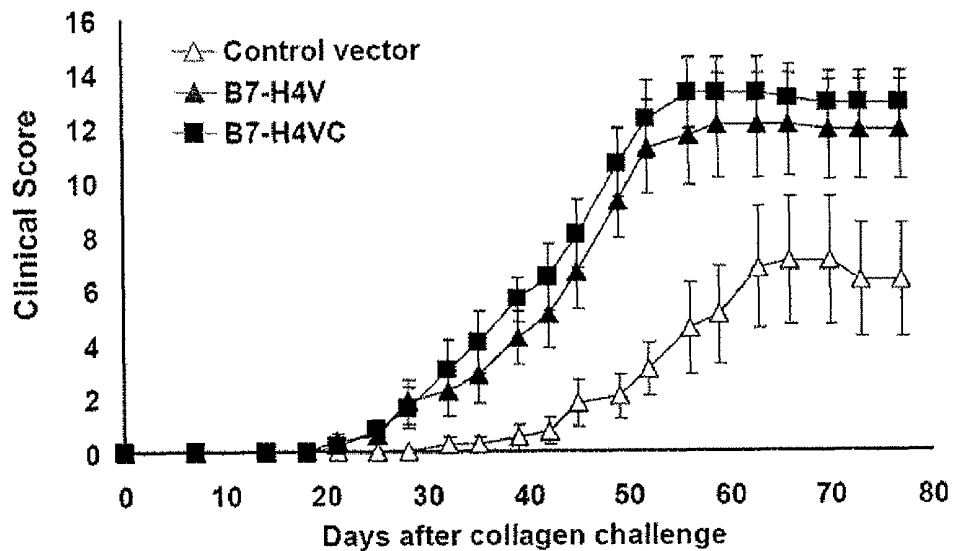

Figure 4d

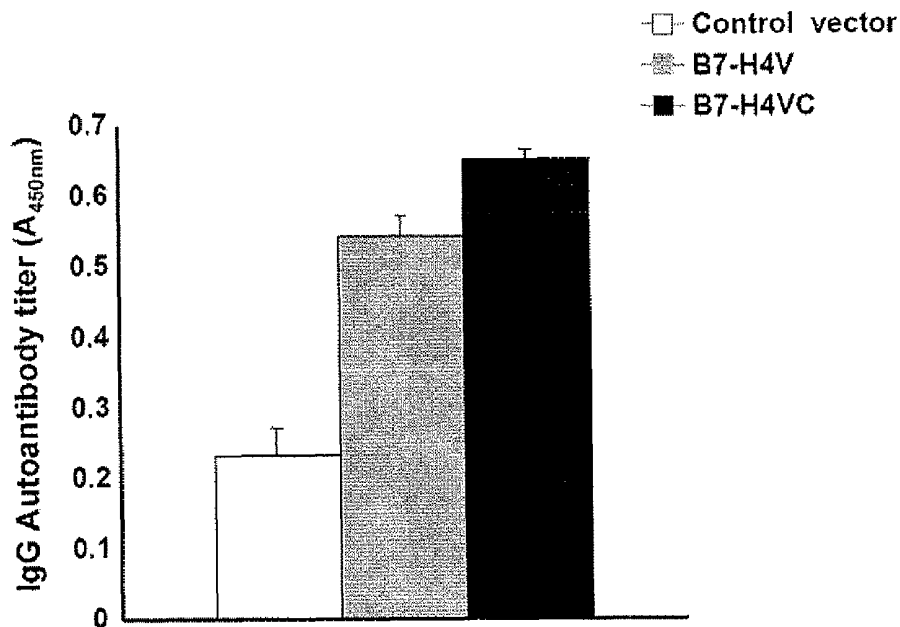

Figure 4e

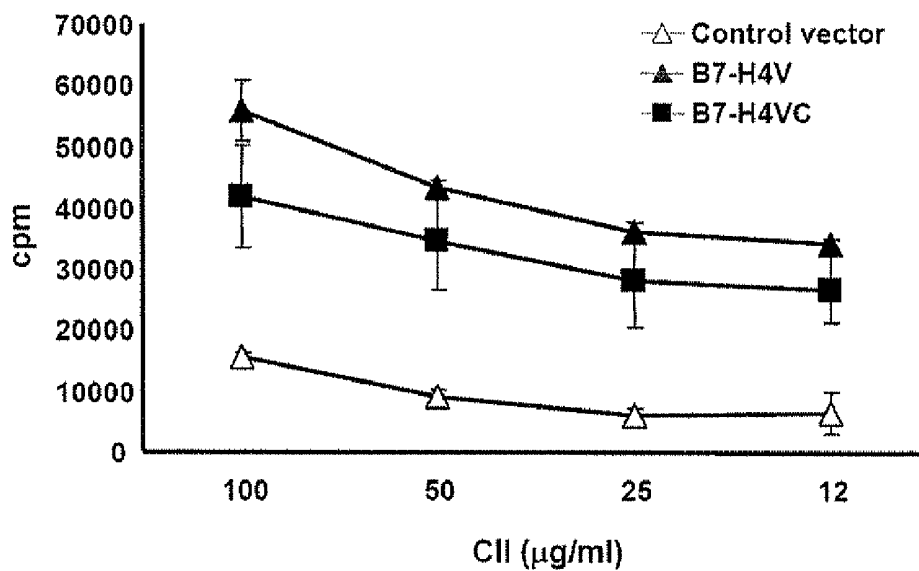

Figure 4f

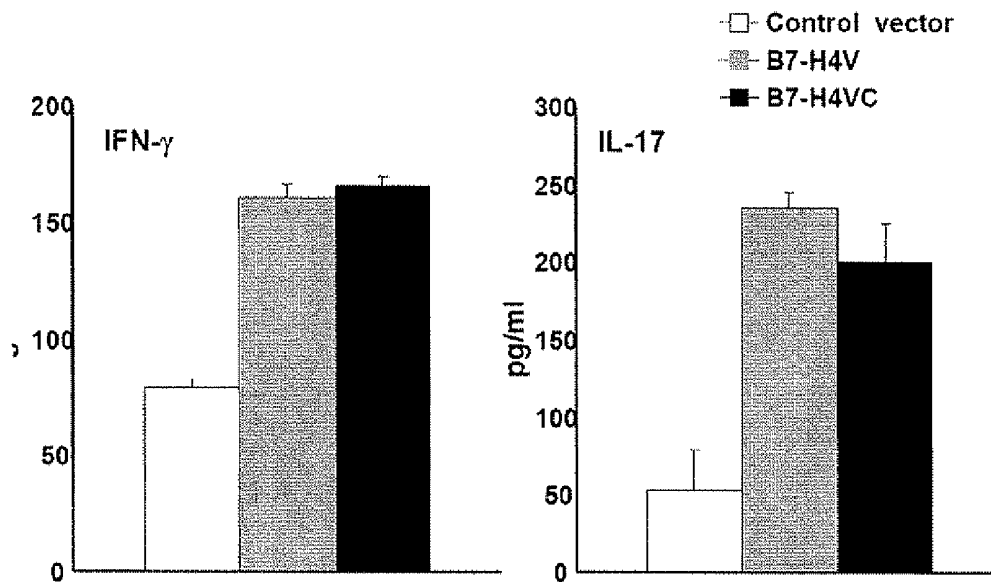

Figure 4g

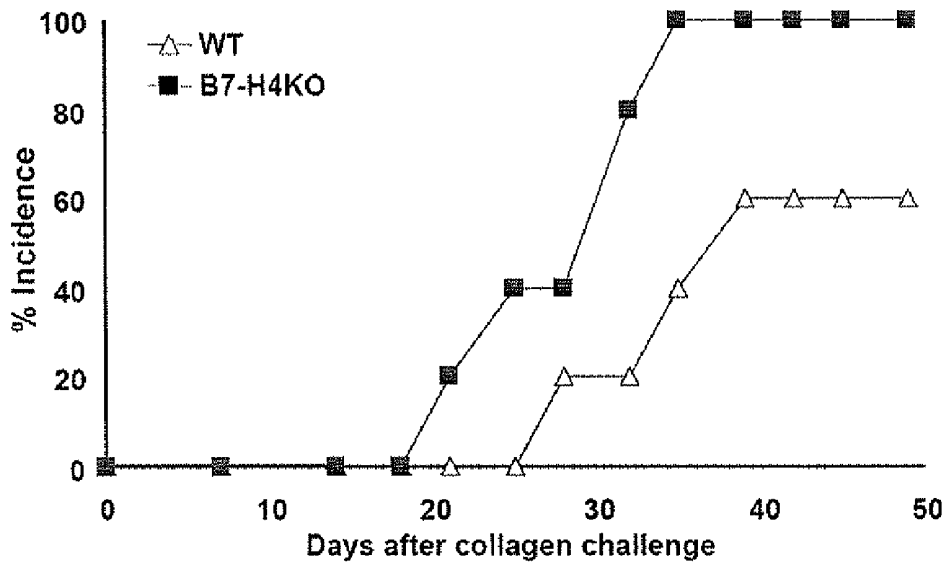

Figure 4h

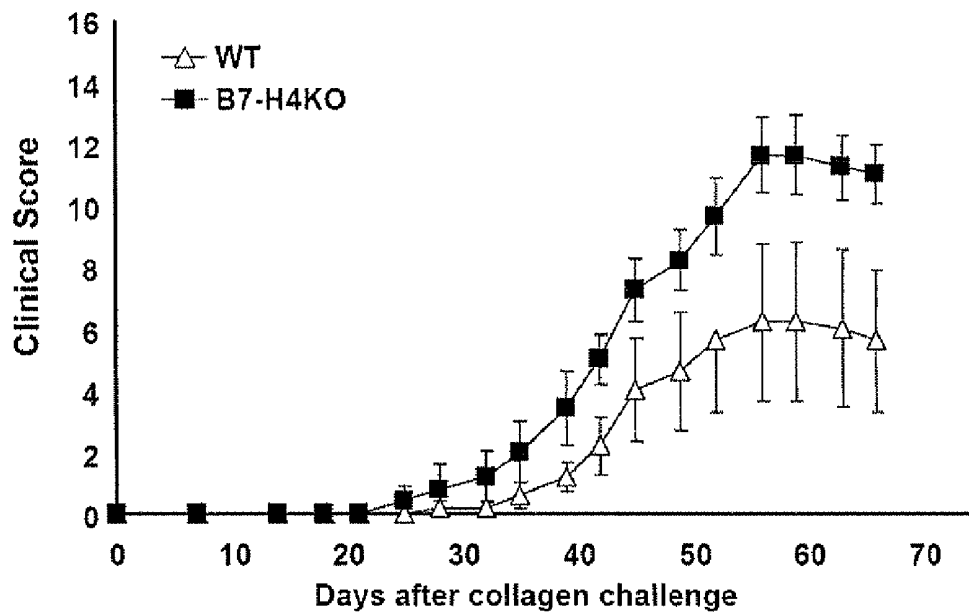

Figure 5a

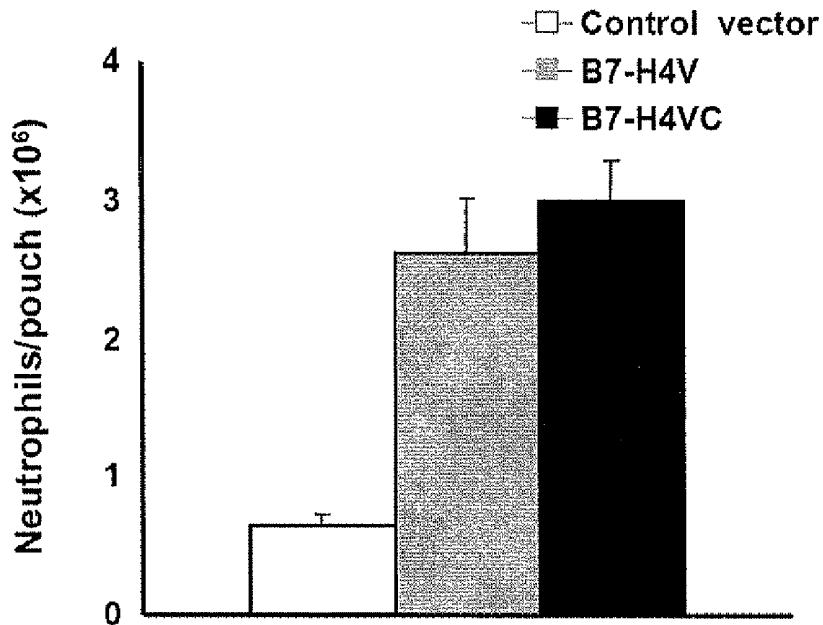

Figure 5b

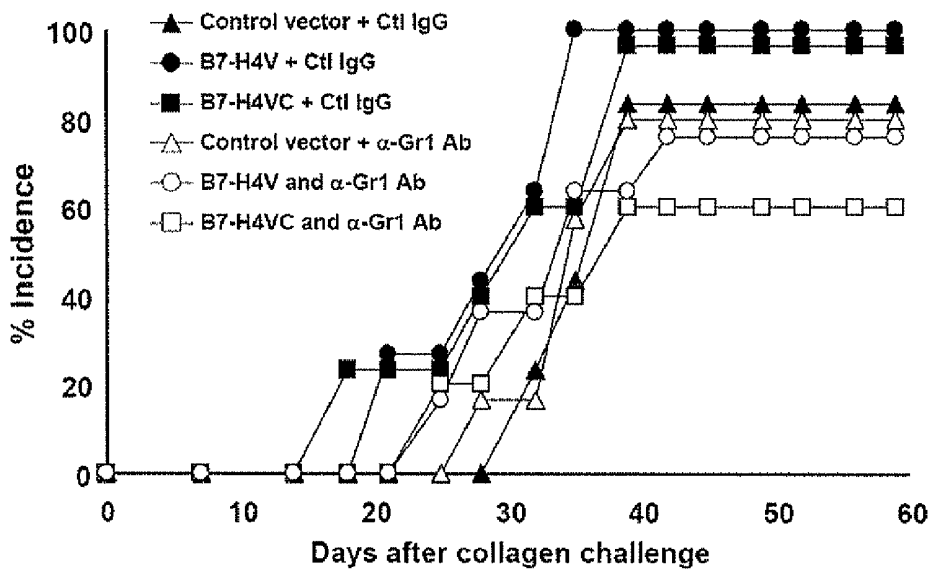

Figure 5c

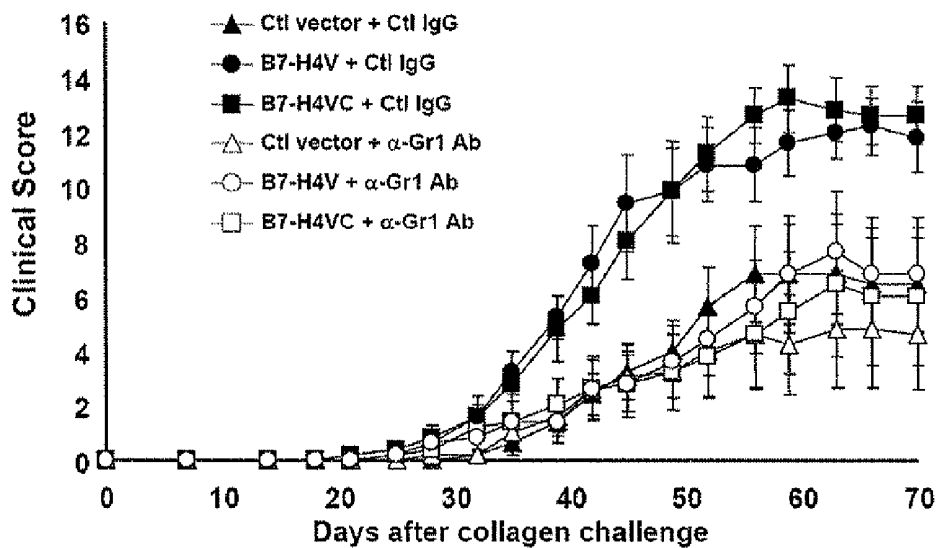

Figure 6a

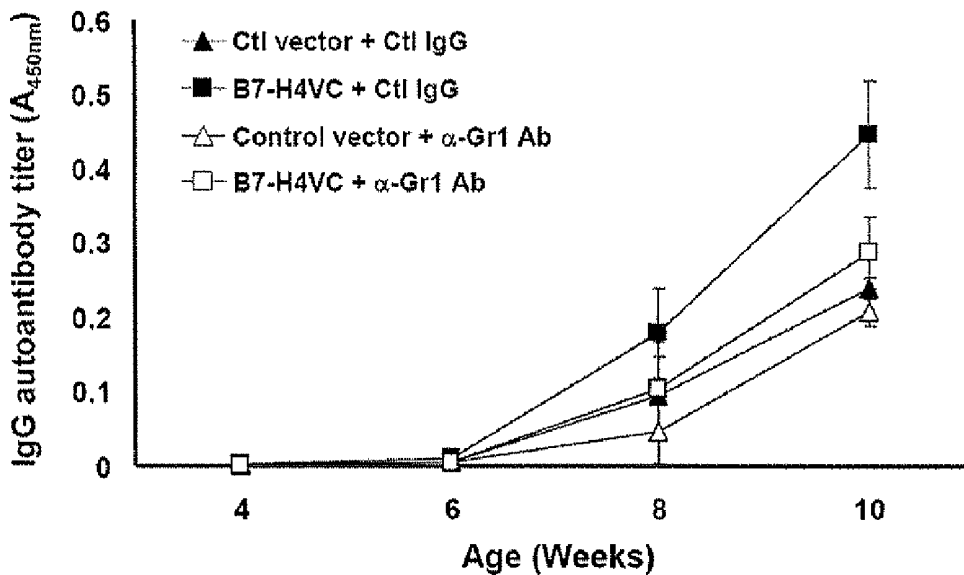

Figure 6b

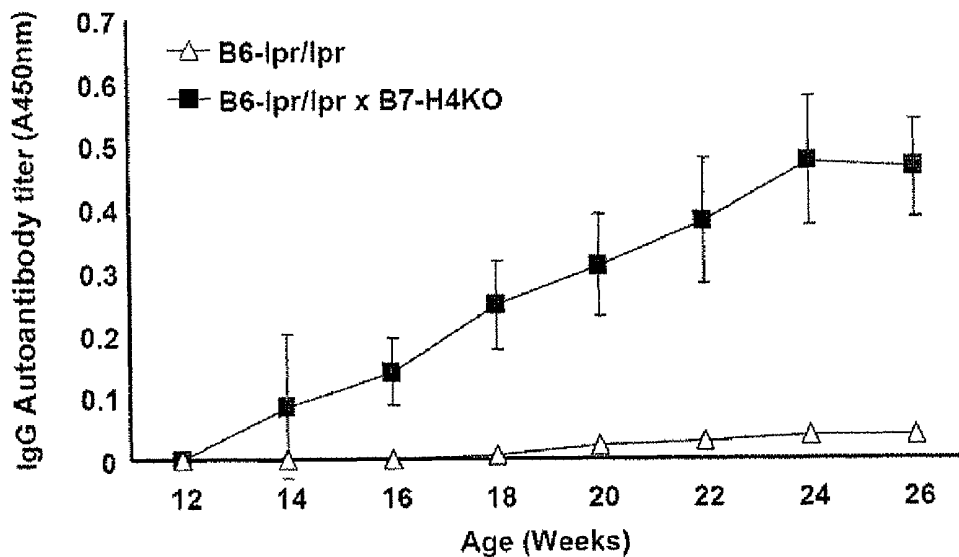

Figure 6c

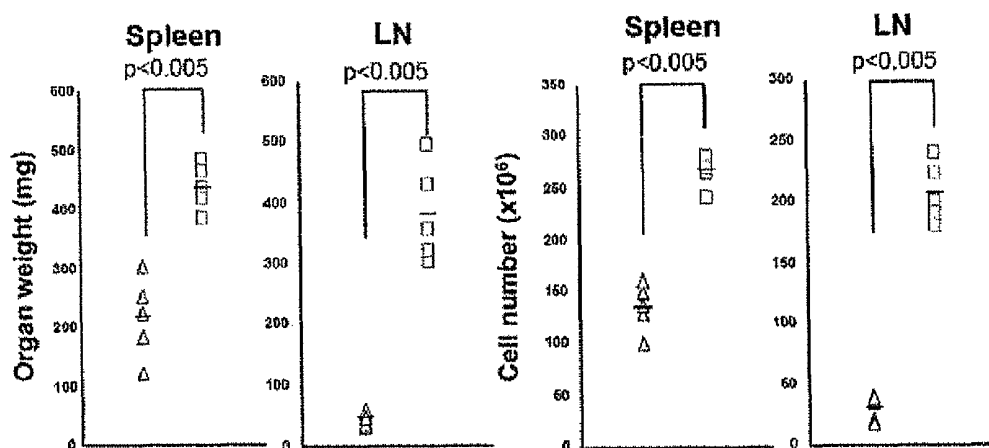

Figure 6d

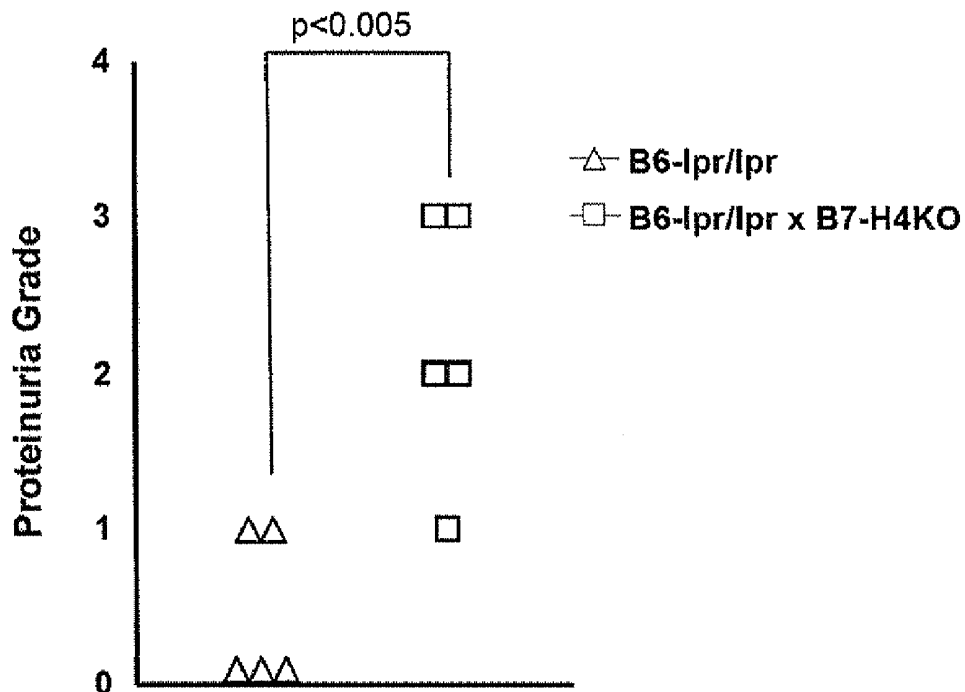

Figure 7a

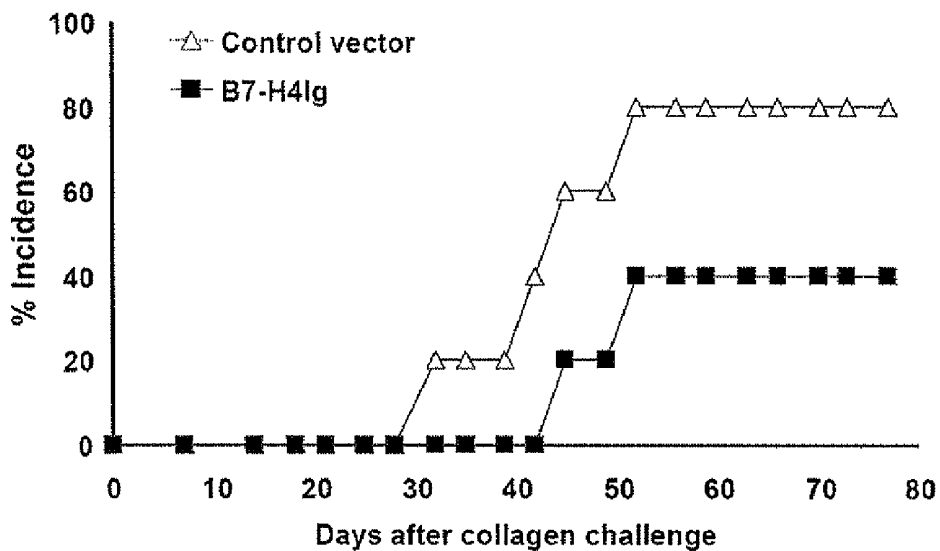

Figure 7b

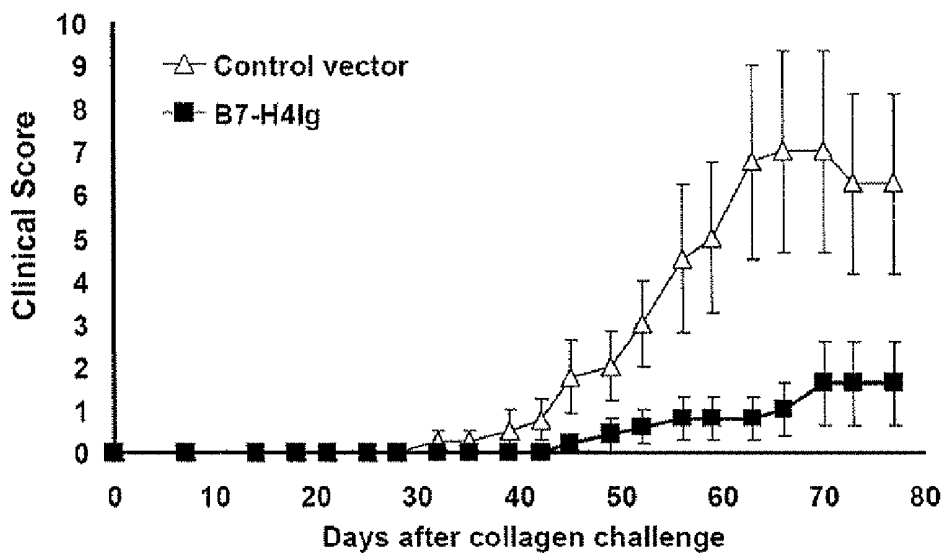

Figure 7c

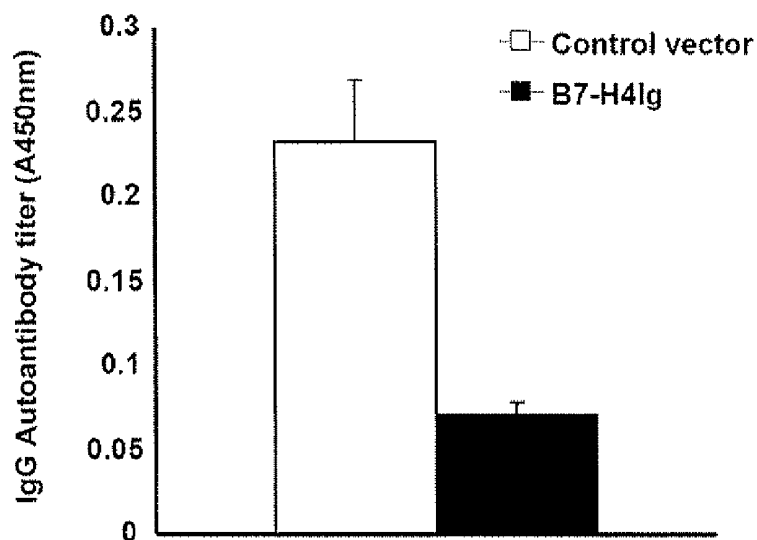

Figure 7d

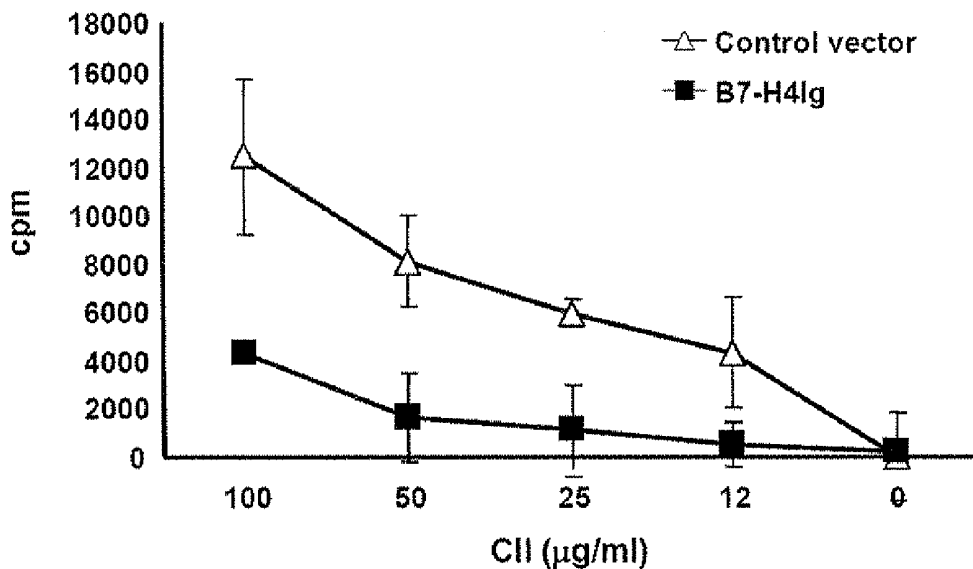

Figure 7e

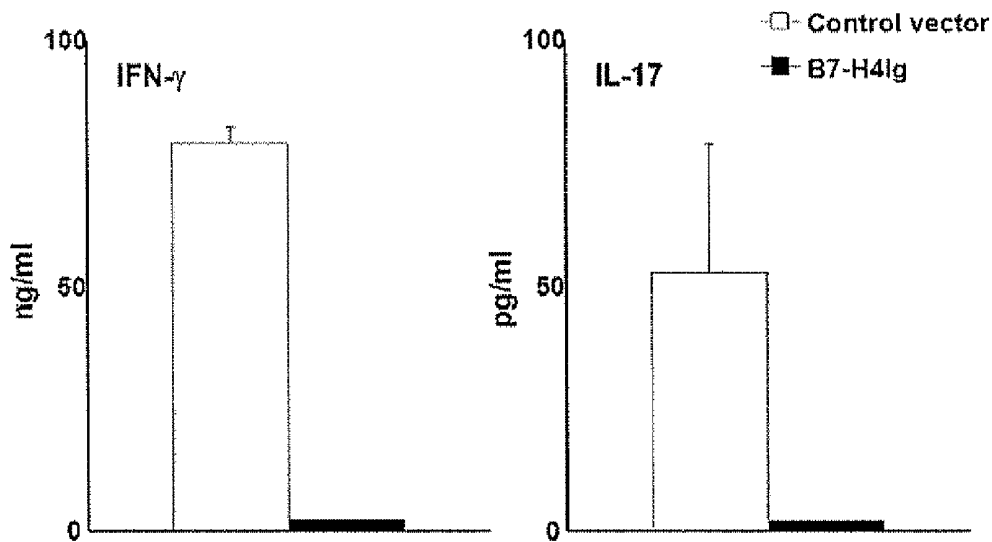

Figure 8

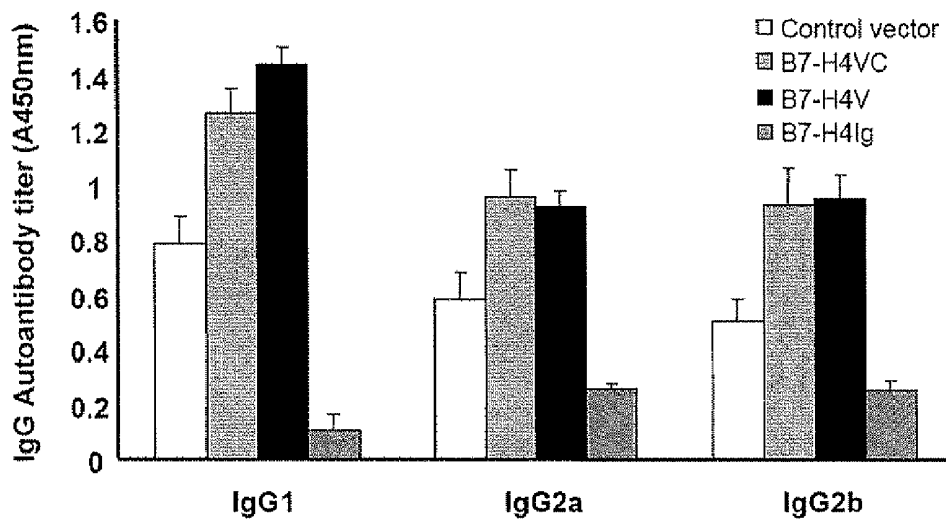

Figure 9

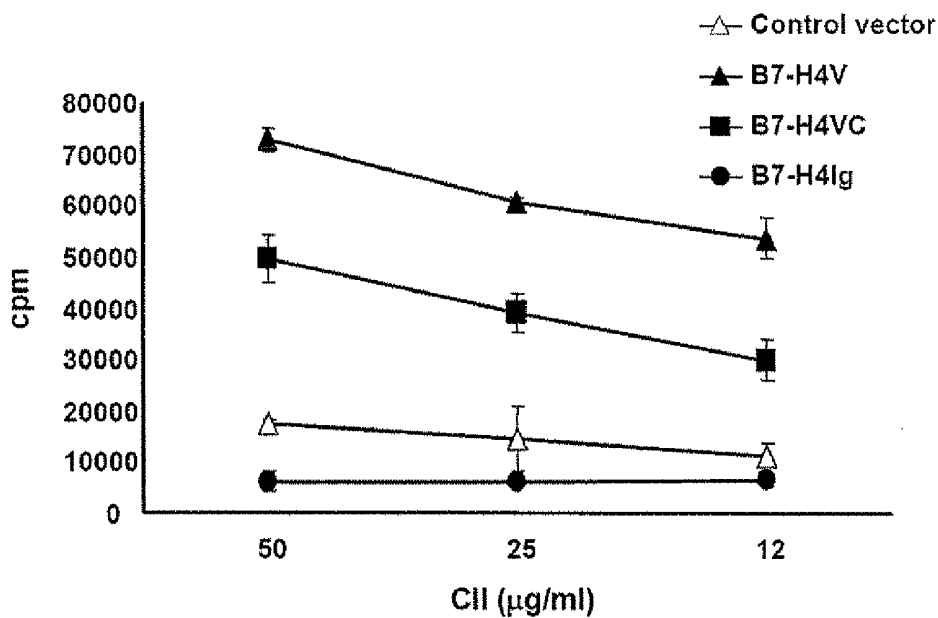

Figure 10

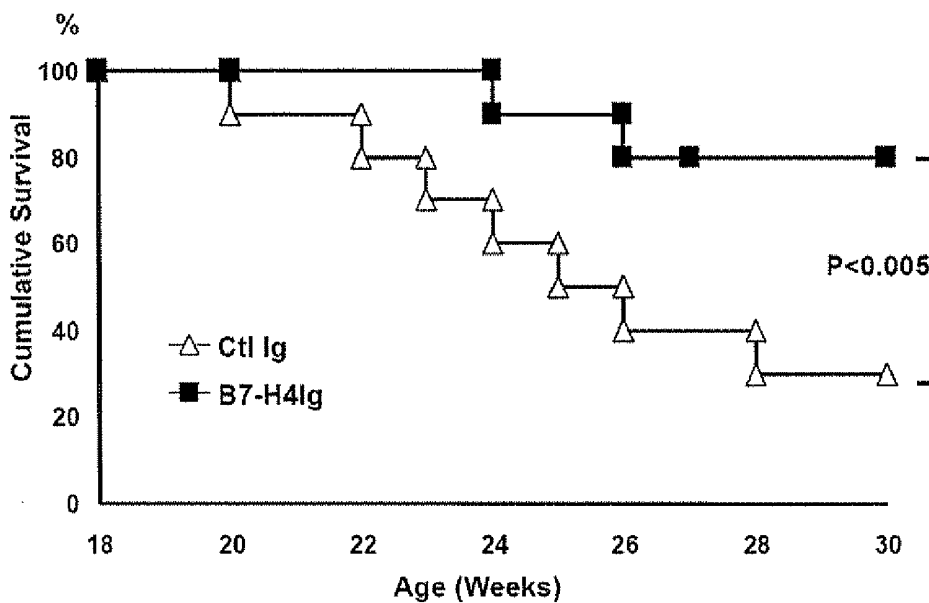

Figure 11

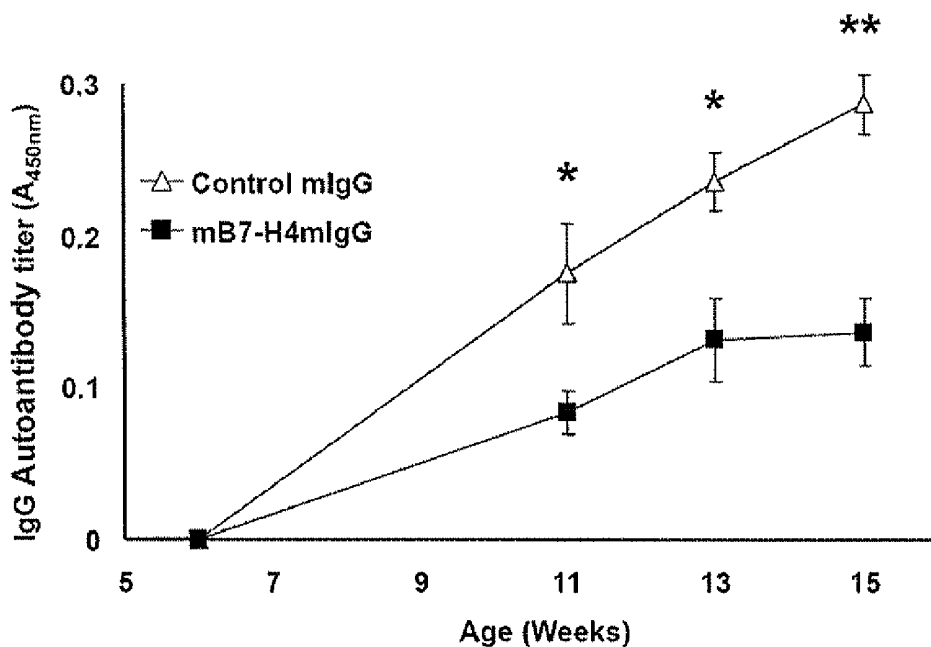
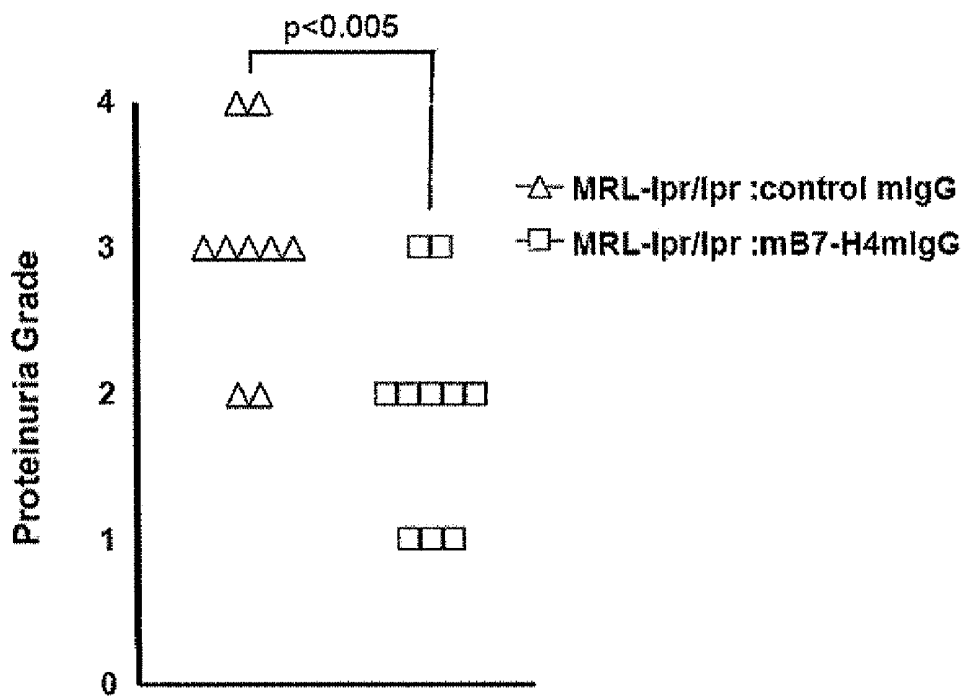

Figure 12



## DETECTION AND DIAGNOSIS OF INFLAMMATORY DISORDERS

### CROSS-REFERENCE TO RELATED APPLICATIONS

This application is a continuation-in-part of pending U.S. patent application Ser. No. 11/965,425 filed on Dec. 27, 2006 which claims benefit of and priority to U.S. Ser. No. 60/877,319 filed on Dec. 27, 2006 and U.S. Ser. No. 60/949,742 filed on Jul. 13, 2007, all of which are incorporated by reference in their entirety.

### GOVERNMENT SUPPORT

The Federal Government has certain rights in this invention by virtue of Grant No. R01 CA98731 awarded by the National Institutes of Health to Lieping Chen.

### FIELD OF THE INVENTION

The invention is generally related to compositions and methods for detecting and assisting in the diagnosis of inflammatory disorders, including but not limited to autoimmune disorders.

### BACKGROUND OF THE INVENTION

Chronic and persistent inflammation is a major cause for the pathogenesis and progression of systemic autoimmune diseases such as rheumatoid arthritis (RA) and systemic lupus erythematosus (SLE). RA is a highly inflammatory polyarthritis often leading to joint destruction, deformity and loss of function. Additive, symmetric swelling of peripheral joints is the hallmark of the disease. Extra-articular features and systemic symptoms can commonly occur and may antedate the onset of joint symptoms. Chronic pain, disability and excess mortality are unfortunate sequelae. During progression of RA, the synovial lining layer of the inflamed joints increases its thickness as a result of synovial hyperplasia and infiltration into synovial stroma by CD4+ T cells, B cells, CD8+ T cells, macrophages, dendritic cells and neutrophils (Feldmann, M. et al., *Cell*, 85:307-10 (1996); Moreland, L. W. et al., *N Engl J Med*, 337:141-7 (1997)). In SLE, the production of autoantibodies results in the deposition of immune complex in many tissues and organs including glomeruli, skin, lungs and synovium, thereby generating rheumatic lesions with characteristic chronic inflammation and tissue damage.

In several arthritis models, depletion of neutrophils resulted in a decrease of arthritis severity. The most common animal model for RA is collagen-induced arthritis (CIA) in which challenge with type II chicken collagen (CII) induces persistent chronic inflammation in all major joints of DBA/1j mice (Williams, R. O., et al., *Proc Natl Acad Sci USA*, 91:2762-6 (1994)). While CD4+ T cells have long been considered to play a central role in the pathogenesis of RA, there is renewed interest in addressing the pivotal role of neutrophils in initiation, progression and maintenance of RA. Massive infiltration of neutrophils in the lesions releases the proinflammatory cytokines including TNF- $\alpha$ , IL-1 and IL-6, which can affect the functions of neutrophils and other inflammatory cells.

An extensively studied murine model for SLE is the lpr strain, in which mutation of Fas apoptotic gene leads to spontaneous autoimmune disorders similar to human SLE. Studies in this strain recapitulate many aspects of human SLE

symptoms. For example, lpr mice develop anti-chromatin, anti-DNA, and anti-IgG serum autoantibodies as well as a polyclonal increase of total immunoglobulin. Disease severity is highly dependent on genetic background. For example, MRL-lpr/lpr mice produce high levels of IgG autoantibodies to DNA and develop a severe glomerulonephritis due to deposition of immune complexes, while C57BL/6(B6)-lpr/lpr mice produce low level autoantibodies with much mild immunopathology.

Co-signal molecules, including those with costimulatory and coinhibitory functions, are important for the induction of effective immune response and for the prevention of unwanted autoimmunity. It has been shown that signals through the B7-CD28 family are major regulators of this balance and play a pivotal role in the regulation of autoimmunity. Persistence of inflammatory responses in systemic autoimmune diseases implies either an impaired coinhibitory or enhanced costimulatory functions, leading to the loss of the balance. In this regard, it is particularly interesting that autoantibodies against B7-H1, a primary coinhibitory molecule after binding to its receptor PD-1, is found in a significant proportion of RA patients and the presence of the autoantibodies is implicated in the progression of RA symptoms.

Soluble forms of B7-CD28 family molecules are also implicated in the progression of rheumatoid diseases. A recent study shows that soluble PD-1 could be detected in RA patients and the levels of soluble PD-1 are correlated with TNF-alpha concentration in synovial fluid. B7-H4 is a more recent addition to the B7 family member. B7-H4 has potent inhibitory effects on T cells through binding to a putative receptor. Cell surface B7-H4 is normally not detectable in normal tissues, although its surface expression could be upregulated on macrophages and tumor cells by inflammatory cytokines, including IL-10 and IL-6. It has been reported that B7-H4 could suppress T cell response in the presence of antigen stimulation. Soluble B7-H4 (sH4) has also been detected in ovarian cancer patients as a potential biomarker, but the mechanism of production and the function of sH4 is unknown. B7-H4 deficient mice were found to mount slightly enhanced T helper 1 type T cell responses against *Leishmania major* infection. Using independently generated B7-H4 knockout mice, it was demonstrated that the lack of B7-H4 led to resistance to *Listeria monocytogenes* infection occurs by direct regulation of growth of neutrophil progenitors. Methods and devices for detecting and quantifying sH4 are needed to explore the role sH4 plays in inflammatory disorders including autoimmune disorders.

It is an object of the invention to provide methods and devices for detecting or quantifying levels of sH4 in a subject.

It is another object of the invention to provide methods and devices for determining the stage or progression of an inflammatory disorder in a subject.

It is still another object of the invention to provide methods and devices to diagnose or to assist in the diagnosis of an inflammatory disorder.

### SUMMARY OF THE INVENTION

Compositions containing soluble B7-H4 (sH4) antagonists in an amount effective to reduce, inhibit, or mitigate an inflammatory response in an individual and methods for the treatment or prophylaxis of inflammatory disorders and autoimmune diseases or disorders have been developed. It has been discovered that soluble H4 ("sH4") interferes with B7-H4 activity, including B7-H4 inhibition of T cell immunity. Thus, interference of sH4 biological activity is believed to be an effective method to restore B7-H4 activity and

thereby provide an effective method for treating inflammatory diseases or disorders, including autoimmune diseases or disorders.

Suitable sH4 antagonists include, but are not limited to, sH4 binding agents such as antibodies and natural ligands of sH4, nucleic acids encoding sH4 antagonists, protease inhibitors, B7-H4 polypeptides, B7-H4 fusion proteins, and inhibitory nucleic acids specific for sH4 encoding nucleic acids. Another method of treating inflammatory responses or autoimmune diseases or disorders is by administering to an individual in need thereof an agent that down-regulates or inhibits expression of sH4, an agent that inactivates sH4 in vivo, an agent that competes for sH4's natural ligand in vivo, or a combination thereof.

In certain embodiments, neutrophil-mediated inflammation is reduced or inhibited. Representative inflammatory diseases or disorders that can be treated with one or more of the sH4 antagonists to reduce, inhibit or mitigate one or more symptoms include, but are not limited to, autoimmune diseases or disorders including rheumatoid arthritis, systemic lupus erythematosus, alopecia areata, ankylosing spondylitis, antiphospholipid syndrome, autoimmune Addison's disease, autoimmune hemolytic anemia, autoimmune hepatitis, autoimmune inner ear disease, autoimmune lymphoproliferative syndrome (ALPS), autoimmune thrombocytopenic purpura (ATP), Behcet's disease, bullous pemphigoid, cardiomyopathy, celiac sprue-dermatitis, chronic fatigue syndrome immune deficiency syndrome (CFIDS), chronic inflammatory demyelinating polyneuropathy, cicatricial pemphigoid, cold agglutinin disease, Crest syndrome, Crohn's disease, Deigo's disease, dermatomyositis, dermatomyositis—juvenile, discoid lupus, essential mixed cryoglobulinemia, fibromyalgia—fibromyositis, grave's disease, guillain-barre, hashimoto's thyroiditis, idiopathic pulmonary fibrosis, idiopathic thrombocytopenia purpura (ITP), Iga nephropathy, insulin dependent diabetes (Type I), juvenile arthritis, Meniere's disease, mixed connective tissue disease, multiple sclerosis, myasthenia gravis, pemphigus vulgaris, pernicious anemia, polyarteritis nodosa, polychondritis, polyglanular syndromes, polymyalgia rheumatica, polymyositis and dermatomyositis, primary agammaglobulinemia, primary biliary cirrhosis, psoriasis, Raynaud's phenomenon, Reiter's syndrome, rheumatic fever, sarcoidosis, scleroderma, Sjogren's syndrome, stiff-man syndrome, Takayasu arteritis, temporal arteritis/giant cell arteritis, ulcerative colitis, uveitis, vasculitis, vitiligo, and Wegener's granulomatosis.

Soluble H4 (sH4) levels have been discovered to correlate with the stage or severity of inflammatory diseases and disorders including autoimmune disorders. In particular, circulating levels of sH4 can be used as a diagnostic for determining the severity of an inflammatory disease or disorder or the propensity for developing an inflammatory disease or disorder. The severity of an inflammatory disease or disorder can be determined by assaying the levels of sH4 in a subject and comparing the levels of sH4 to reference sH4 concentrations that correlate to specific stages of an inflammatory disease or disorder.

Representative inflammatory diseases and disorders include, but are not limited to rheumatoid arthritis, systemic lupus erythematosus, alopecia areata, ankylosing spondylitis, antiphospholipid syndrome, autoimmune Addison's disease, autoimmune hemolytic anemia, autoimmune hepatitis, autoimmune inner ear disease, autoimmune lymphoproliferative syndrome (alps), autoimmune thrombocytopenic purpura (ATP), Behcet's disease, bullous pemphigoid, cardiomyopathy, celiac sprue-dermatitis, chronic fatigue

syndrome immune deficiency, syndrome (CFIDS), chronic inflammatory demyelinating polyneuropathy, cicatricial pemphigoid, cold agglutinin disease, Crest syndrome, Crohn's disease, Deigo's disease, dermatomyositis, dermatomyositis—juvenile, discoid lupus, essential mixed cryoglobulinemia, fibromyalgia—fibromyositis, grave's disease, guillain-barre, hashimoto's thyroiditis, idiopathic pulmonary fibrosis, idiopathic thrombocytopenia purpura (ITP), Iga nephropathy, insulin dependent diabetes (Type I), juvenile arthritis, Meniere's disease, mixed connective tissue disease, multiple sclerosis, myasthenia gravis, pemphigus vulgaris, pernicious anemia, polyarteritis nodosa, polychondritis, polyglanular syndromes, polymyalgia rheumatica, polymyositis and dermatomyositis, primary agammaglobulinemia, primary biliary cirrhosis, psoriasis, Raynaud's phenomenon, Reiter's syndrome, rheumatic fever, sarcoidosis, scleroderma, Sjogren's syndrome, stiff-man syndrome, Takayasu arteritis, temporal arteritis/giant cell arteritis, ulcerative colitis, uveitis, vasculitis, vitiligo, and Wegener's granulomatosis.

One embodiment provides a method for assisting in the diagnosis of an inflammatory disease or disorder or propensity of developing an inflammatory disease or disorder in a subject by obtaining a biological sample from the subject and determining levels of sH4 in the biological sample, wherein elevated levels of sH4 in the biological sample relative to a control is indicative of an inflammatory disease or disorder or an increased propensity for developing an inflammatory disease or disorder.

Still another embodiment provides a method for determining the therapeutic efficacy of a treatment for an inflammatory disease or disorder by obtaining biological samples from a subject at various time intervals during treatment and comparing the levels of sH4 in the samples to levels of sH4 in a biological sample obtained from the subject prior to treatment. Additionally, or alternatively, the levels of sH4 in the biological samples obtained from the subject during treatment can be compared to levels of sH4 indicative of different stages of an inflammatory disease or disorder or autoimmune disease.

Yet another embodiment provides a lateral flow device for determining sH4 concentration in a subject. The device includes an application zone for receiving a fluid sample, a labeling zone containing labeled binding partner for the sH4, and a detection zone having an immobilized capture reagent for the sH4. The device also includes a reference zone having a signal of fixed intensity indicative of the reference concentration of sH4, wherein when the signal in the detection zone is less intense than the signal in the reference zone, the subject has a sH4 level less than the reference concentration, and when the signal in the detection zone is more intense than the signal in the reference zone, the subject has a sH4 level more than the reference concentration.

#### BRIEF DESCRIPTION OF THE DRAWINGS

FIG. 1a is a graph showing sH4 in sera of healthy donors (HD) (◆), rheumatoid arthritis (RA) (▲), and systemic lupus erythematosus (SLE) (□) patients. FIG. 1b is a graph showing the correlation between concentration of the sH4 and the severity groups 0 (▲), 1 (X), 2 (◆), and 3 (■) of RA.

FIG. 2 shows an exemplary lateral flow device.

FIG. 3 shows the lateral flow device in a housing.

FIG. 4a is a schematic of the B7-H4V, B7-H4VC and B7-H4Ig. IgV domain; IgV, IgC domain; IgC. TM; transmembrane domain, CY; cytoplasmic domain. FIG. 4b shows a graph of percent incidence versus days after collagen injection.

tion of mice immunized with chicken type II collagen in CFA on day 0 and day 21. Three groups of mice were hydrodynamic injection with control vector (□), B7-H4V (▲) or B7-H4VC (■) on day -1 and day 20; means±s.e.m. (n=5). FIG. 4c shows a graph of clinical score versus days after collagen injection of mice immunized with chicken type II collagen in CFA on day 0 and day 21. Three groups of mice were hydrodynamically injected with control (□), B7-H4V (▲) or B7-H4VC (■) vector on day -1 and day 20; means±s.e.m. (n=5). FIG. 4d is a bar graph showing serum levels of anti-CII total IgG. white; control vector, gray; B7-H4V, black; B7-H4VC; means±s.d. FIG. 4e shows a line graph of counts per minute versus CII μg/ml. Whole splenocytes from CIA mice injected with control vector (□), B7-H4V (▲) or B7-H4VC (■) on day 30 were cultured in the presence of the indicated amounts of CII for 72 hr; means±s.d. FIG. 4f shows bar graphs of supernatants of whole splenocytes after a 72 hr culture assessed for IFN-γ and IL-17 production by ELISA; means±s.d. FIG. 4g shows a line graph of incidence versus days after collagen injection of mice immunized with chicken type II collagen in CFA on day 0 and day 21. WT mice (□), B7-H4KO mice (■); means±s.e.m. (n=5). FIG. 4h shows a line graph of clinical score of mice immunized with chicken type II collagen in CFA on day 0 and day 21. WT mice (□), B7-H4KO mice (■); means±s.e.m. (n=5).

FIG. 5a shows a bar graph of an air pouch assay showing sH4 activates neutrophils by its dominant-negative activity. Subcutaneous air pouches were injected with LPS (50 μg). After 5 h, Gr-1+ neutrophils were quantified by flow cytometry of cells rinsed from the pouch with sterile saline. Each bar represents the average of six to eight mice in each group; means±s.d. FIG. 5b shows a line graph of incidence versus days after collagen challenge. Six groups of mice were treated with control vector and control rat IgG (▲), control vector and anti-Gr-1 Ab (□), B7-H4V and control rat IgG (●) and B7-H4V and anti-Gr-1 Ab (○), B7-H4VC and control rat IgG (■) and B7-H4VC and anti-Gr-1 Ab (■); means±s.e.m. (n=5) FIG. 5c shows a line graph of clinical score of CIA mice versus days after collagen challenge. Six groups of mice were treated with control vector and control rat IgG (▲), control vector and anti-Gr-1 Ab (□), B7-H4V and control rat IgG (●) and B7-H4V and anti-Gr-1 Ab (○), B7-H4VC and control rat IgG (■) and B7-H4VC and anti-Gr-1 Ab (■); means±s.e.m. (n=5).

FIG. 6a shows a line graph of the serum levels of anti-double strand DNA autoantibody in MRL-lpr/lpr mice. Four groups of mice were treated with control vector and control rat IgG (▲), control vector and anti-Gr-1 Ab (□), B7-H4VC and control rat IgG (■) and B7-H4VC and anti-Gr-1 Ab (□); means±s.e.m. (n=5). FIG. 6b shows a line graph of the serum levels of anti-double strand DNA autoantibody in B6-lpr/lpr mice (□) or B6-lpr/lprxB7-H4KO mice (■); means±s.e.m. FIG. 6c shows a panel of graphs showing weight and total cell number in the spleens and peripheral lymph nodes of 24 weeks old B6-lpr/lpr mice (□) or B6-lpr/lprxB7-H4KO mice (□). (n=5) FIG. 6d shows a graph indicating proteinuria grade of 24 weeks old B6-lpr/lpr mice (□) or B6-lpr/lprxB7-H4KO mice (□). (n=5).

FIG. 7a shows a line graph of incidence of mice immunized with chicken type II collagen in CFA on day 0 and day 21. Three groups of mice were hydrodynamic injection with control vector (□) or B7-H4Ig (■) on day -1 and day 20; means±s.e.m. (n=5) FIG. 7b shows a line graph of clinical score of mice immunized with chicken type II collagen in CFA on day 0 and day 21. Three groups of mice were hydrodynamic injection with control vector (□) or B7-H4Ig (■) on

day -1 and day 20; means±s.e.m. (n=5) FIG. 7c shows a bar graph of serum levels of anti-CII total IgG. white; control vector, black; B7-H4Ig; means±s.d. FIG. 7d shows a line graph of counts per minute versus CII μg/ml of whole splenocytes from CIA mice injected with control vector (□) or B7-H4Ig (■) on day 30 were cultured in the presence or absence of the indicated amounts of CII for 72 hr; means±s.d. FIG. 7e shows bar graphs showing supernatants of whole splenocytes after a 72 hr culture assessed for IFN-γ and IL-17 production by ELISA; means±s.d.

FIG. 8 shows bar graphs of serum levels of anti-CII IgG1, IgG2a and IgG2b in CIA mice treated with control vector, B7-H4V, B7-H4VC or B7-H4Ig were measured by ELISAs in day 30; means±s.d.

FIG. 9 shows line graphs of counts per minute versus CII μg/ml indicating proliferation of splenic CD4 T cells in CIA mice injected with control vector (□), B7-H4V (▲), B7-H4VC (■) or B7-H4Ig (●) on day 30 in the presence of the indicated amounts of CII for 72 hr; means±s.d.

FIG. 10 is a line graph of percent cumulative survival versus age (weeks) in MRL-lpr/lpr mice injected with control mIgG plasmid (□) or B7-H4Ig plasmid (■) at 6, 8, 10 and 12 weeks of age. All phenotypes were analyzed at 19 weeks of age.

FIG. 11 is a line graph of IgG autoantibody titer ( $A_{450nm}$ ) versus age (weeks) in MRL-lpr/lpr mice injected with control mIgG plasmid (□) or B7-H4Ig plasmid (■).

FIG. 12 is a graph of proteinuria grade in MRL-lpr/lpr mice injected with control mIgG plasmid (Δ) or B7-H4Ig plasmid (□).

## DETAILED DESCRIPTION OF THE INVENTION

### I. Definitions

Unless otherwise defined, all technical and scientific terms used herein have the same meaning as commonly understood by one of ordinary skill in the art to which this invention pertains. All publications, patent applications, patents, and other references mentioned herein are incorporated by reference in their entirety. In case of conflict, the present specification, including definitions, will control. In addition, the materials, methods, and examples are illustrative only and not intended to be limiting.

The term "effective amount" or "therapeutically effective amount" means a dosage sufficient to provide treatment of the inflammatory response or autoimmune disease state being treated or to otherwise provide a desired pharmacologic and/or physiologic effect. The precise dosage will vary according to a variety of factors such as subject-dependent variables (e.g., age, immune system health, etc.), the disease, and the treatment being effected.

A "fragment" of a B7-H4 polypeptide is a fragment of the polypeptide that is shorter than the full-length polypeptide. Generally, fragments will be five or more amino acids in length. An antigenic fragment has the ability to be recognized and bound by an antibody.

The terms "individual," "host" "subject," and "patient" are used interchangeably herein, and refer to a mammal, including, but not limited to, humans, rodents, such as mice and rats, and other laboratory animals.

The terms "polypeptide" and "protein" are used interchangeably and mean any peptide-linked chain of amino acids, regardless of length or post-translational modification.

The term "sH4" refers to soluble B7-H4. sH4 includes the extracellular domain of B7-H4 and biologically active fragments thereof. Human and mouse B7 proteins contain short

intracytoplasmic domains, a single transmembrane domain and an extracellular domain. The extracellular domain typically contains two Ig domains; a membrane proximal IgC domain and a membrane distal IgV domain. B7-H4 nucleotide and protein sequence are found in GENBANK under accession number AY280972. Additionally, B7-H4 is described in U.S. Pat. No. 6,891,030 and where permissible, is incorporated by reference in its entirety. As used herein, the terms "soluble B7-H4" and "sH4" encompass any polypeptide fragment of B7-H4 that is shed, secreted or otherwise extracted from the producing cells in vivo. Soluble B7-H4 is typically approximately 50-kDa by Western blot analysis, a size equal to the entire extracellular domain of monomeric B7-H4 molecule in denatured condition.

As used herein, the term "treating" includes alleviating, preventing and/or eliminating one or more symptoms associated with inflammatory responses or an autoimmune disease. Representative inflammatory diseases or disorders include, but are not limited to, autoimmune diseases or disorders including rheumatoid arthritis, systemic lupus erythematosus, alopecia areata, ankylosing spondylitis, antiphospholipid syndrome, autoimmune Addison's disease, autoimmune hemolytic anemia, autoimmune hepatitis, autoimmune inner ear disease, autoimmune lymphoproliferative syndrome (ALPS), autoimmune thrombocytopenic purpura (ATP), Behcet's disease, bullous pemphigoid, cardiomyopathy, celiac sprue-dermatitis, chronic fatigue syndrome immune deficiency syndrome (CFIDS), chronic inflammatory demyelinating polyneuropathy, cicatricial pemphigoid, cold agglutinin disease, Crest syndrome, Crohn's disease, Deigo's disease, dermatomyositis, dermatomyositis—juvenile, discoid lupus, essential mixed cryoglobulinemia, fibromyalgia—fibromyositis, grave's disease, guillain-barre, hashimoto's thyroiditis, idiopathic pulmonary fibrosis, idiopathic thrombocytopenia purpura (ITP), Iga nephropathy, insulin dependent diabetes (Type I), juvenile arthritis, Meniere's disease, mixed connective tissue disease, multiple sclerosis, myasthenia gravis, pemphigus vulgaris, pernicious anemia, polyarteritis nodosa, polycondritis, polyglanular syndromes, polymyalgia rheumatica, polymyositis and dermatomyositis, primary agammaglobulinemia, primary biliary cirrhosis, psoriasis, Raynaud's phenomenon, Reiter's syndrome, rheumatic fever, sarcoidosis, scleroderma, Sjogren's syndrome, stiff-man syndrome, Takayasu arteritis, temporal arteritis/giant cell arteritis, ulcerative colitis, uveitis, vasculitis, vitiligo, and Wegener's granulomatosis.

## II. Anti-Inflammatory Compositions

Compositions for inhibiting, reducing, or blocking the biological activity or expression of soluble B7-H4 (also referred to as "sH4") are provided. In certain embodiments, the compositions include as an active agent a sH4 antagonist in an amount effective to inhibit, reduce, or decrease an inflammatory response. An exemplary inflammatory response includes, but is not limited to, neutrophil-mediated inflammatory responses.

### A. sH4 Antagonists

Soluble B7-H4 antagonists include compounds that inhibit the expression or biological activity of sH4. Soluble B7-H4 is approximately 50-kDa by Western blot analysis, a size equal to entire extracellular domain of monomeric B7-H4 molecule in denatured condition (FIG. 1b).

#### 1. Protease Inhibitors

It is believed that sH4 is generated by enzymatic cleavage of the entire extracellular portion of B7-H4. 293T cells transfected with full length B7-H4 cDNA release sH4 into culture

supernatant, and this secretion can be inhibited by incubation with various proteases inhibitors. Thus, in certain embodiments, sH4 antagonists include protease inhibitors. Exemplary protease inhibitors include, but are not limited to, serine protease inhibitors, cysteine protease inhibitors, aspartic protease inhibitors, and metalloprotease inhibitors. Specific protease inhibitors include leupeptin, PMSF, AEBSE, aprotinin, chymostatin, antithrombin III, 3,4-dichloroisocoumarin, TLCK, TPCK, DIFP, antipain,  $\alpha$ 2-macroglobulin, N-ethylmaleimide, E-64, chymostatin, pepstatin A, 1,10-phenanthroline, phosphoramidon, and bestatin.

#### 2. Inhibitory Nucleic Acids

sH4 containing only the IgV (FIG. 2a) portion of the extracellular domain is sufficient to exacerbate autoimmune diseases. In fact, B7-H4V and B7-H4VC (FIG. 2a) have similar effects in animal models, suggesting that the binding site for its putative receptor is located in the IgV domain, a result supported by a previous study using the B7-H4 IgV structure based on a computer-generated model. A previous report suggests that B7-H4 is a GPI-anchoring protein which could become the soluble form by detaching from an anchoring moiety. However, a recent study indicates that B7-H4 is a transmembrane protein. Several molecules in the immunoglobulin superfamily have been shown to display soluble forms. These soluble molecules including CD80, CD86 and PD-1 are made by splicing variants. Therefore, sH4 could be generated via alternative splicing of B7-H4.

An inhibitory nucleic acid can specifically inhibit RNA splicing that produces a transcript encoding sH4 or specifically inhibit or reduce the expression of RNA encoding sH4. Inhibitory nucleic acids include, but are not limited to, antisense DNA, triplex-forming oligonucleotides, external guide sequences, siRNA, and microRNA. Useful inhibitory nucleic acids include those that reduce the expression of RNA encoding sH4 by at least 20, 30, 40, 50, 60, 70, 80, 90 or 95 percent compared to controls. Inhibitory nucleic acids and methods of producing them are well known in the art. siRNA design software is available for example at <http://i.cs.hku.hk/~sima/software/sirna.php>. Synthesis of nucleic acids is well known see for example *Molecular Cloning: A Laboratory Manual* (Sambrook and Russel eds. 3<sup>rd</sup> ed.) Cold Spring Harbor, N.Y. (2001).

#### 3. Anti-sH4 Antibodies

Antibodies or antibody fragments that specifically bind to sH4 can be used to antagonize the biological activity of sH4. An exemplary antibody is mAb hH4.3 (Choi, I. H. et al., *J Immunol*, 171:4650-4 (2003)). Methods of producing antibodies are well known and within the ability of one of ordinary skill in the art.

For example, monoclonal antibodies (mAbs) and methods for their production and use are described in Kohler and Milstein, *Nature* 256:495-497 (1975); U.S. Pat. No. 4,376,110; Hartlow, E. et al., *Antibodies: A Laboratory Manual*, Cold Spring Harbor Laboratory Press, Cold Spring Harbor, N.Y., 1988); *Monoclonal Antibodies and Hybridomas: A New Dimension in Biological Analyses*, Plenum Press, New York, N.Y. (1980); H. Zola et al., in *Monoclonal Hybridoma Antibodies: Techniques and Applications*, CRC Press, (1982)).

Anti-idiotypic antibodies are described, for example, in *Idiotypy in Biology and Medicine*, Academic Press, New York, 1984; *Immunological Reviews* Volume 79, 1984; *Immunological Reviews* Volume 90, 1986; *Curr. Top. Microbiol., Immunol.* Volume 119, 1985; Bona, C. et al., *CRC Crit. Rev. Immunol.*, pp. 33-81 (1981); Jerne, N K, *Ann. Immunol.* 125C:373-389 (1974); Jerne, N K, *Idiotypes—Antigens on the Inside*, Westen-Schnurr, I., ed., Editiones Roche, Basel,

1982, Urbain, J. et al., *Ann. Immunol.* 133D:179-(1982); Rajewsky, K. et al., *Ann. Rev. Immunol.* 1:569-607 (1983).

Certain embodiments provide antibodies, both polyclonal and monoclonal, reactive with novel epitopes of sH4 that are absent or masked in B7-H4. The antibodies may be xenogeneic, allogeneic, syngeneic, or modified forms thereof, such as humanized, single chain or chimeric antibodies. Antibodies may also be anti-idiotypic antibodies specific for the idiotype of an anti-sH4 antibody. The term "antibody" is also meant to include both intact molecules as well as fragments thereof that include the antigen-binding site and are capable of binding to a sH4 epitope. These include Fab and F(ab')<sub>2</sub> fragments which lack the Fc fragment of an intact antibody, and therefore clear more rapidly from the circulation, and may have less non-specific tissue binding than an intact antibody (Wahl et al., *J. Nuc. Med.* 24:316-325 (1983)). Also included are Fv fragments (Hochman, J. et al., *Biochemistry*, 12:1130-1135 (1973); Sharon, J. et al., *Biochemistry*, 15:1591-1594 (1976)). These various fragments can be produced using conventional techniques such as protease cleavage or chemical cleavage (see, e.g., Rousseaux et al., *Meth. Enzymol.*, 121:663-69 (1986)).

Polyclonal antibodies are obtained as sera from immunized animals such as rabbits, goats, rodents, etc. and may be used directly without further treatment or may be subjected to conventional enrichment or purification methods such as ammonium sulfate precipitation, ion exchange chromatography, and affinity chromatography.

The immunogen may be any immunogenic portion of sH4. Preferred immunogens include all or a part of the extracellular domain of human B7-H4, where these residues contain the post-translation modifications, such as glycosylation, found on the native B7-H4. Immunogens including the extracellular domain are produced in a variety of ways known in the art, e.g., expression of cloned genes using conventional recombinant methods, isolation from cells of origin, cell populations expressing high levels of B7-H4.

The mAbs may be produced using conventional hybridoma technology, such as the procedures introduced by Kohler and Milstein, *Nature*, 256:495-97 (1975), and modifications thereof (see above references). An animal, preferably a mouse is primed by immunization with an immunogen as above to elicit the desired antibody response in the primed animal.

B lymphocytes from the lymph nodes, spleens or peripheral blood of a primed, animal are fused with myeloma cells, generally in the presence of a fusion promoting agent such as polyethylene glycol (PEG). Any of a number of murine myeloma cell lines are available for such use: the P3-NS1/1-Ag4-1, P3-x63-k0Ag8.653, Sp2/0-Ag14, or HL1-653 myeloma lines (available from the ATCC, Rockville, Md.). Subsequent steps include growth in selective medium so that unfused parental myeloma cells and donor lymphocyte cells eventually die while only the hybridoma cells survive. These are cloned and grown and their supernatants screened for the presence of antibody of the desired specificity, e.g. by immunoassay techniques using the B7-H4-Ig fusion protein. Positive clones are subcloned, e.g., by limiting dilution, and the mAbs are isolated.

Hybridomas produced according to these methods can be propagated in vitro or in vivo (in ascites fluid) using techniques known in the art (see generally Fink et al., *Prog. Clin. Pathol.*, 9:121-33 (1984)). Generally, the individual cell line is propagated in culture and the culture medium containing high concentrations of a single mAb can be harvested by decantation, filtration, or centrifugation.

The antibody may be produced as a single chain antibody or scFv instead of the normal multimeric structure. Single

chain antibodies include the hypervariable regions from an Ig of interest and recreate the antigen binding site of the native Ig while being a fraction of the size of the intact Ig (Skerra, A. et al., *Science*, 240: 1038-1041 (1988); Pluckthun, A. et al., *Methods Enzymol.*, 178: 497-515 (1989); Winter, G. et al., *Nature*, 349: 293-299 (1991); Bird et al., *Science* 242:423 (1988); Huston et al. *Proc. Natl. Acad. Sci. USA* 85:5879 (1988); Jost C R et al., *J Biol Chem.* 269:26267-26273 (1994); U.S. Pat. Nos. 4,704,692, 4,853,871,4,94,6778, 5,260,203. In a preferred embodiment, the antibody is produced using conventional molecular biology techniques.

Methods of using the antibodies to detect the presence of the epitope are described in Coligan, J. E. et al., eds., *Current Protocols in Immunology*, Wiley-Interscience, New York 1991 (or current edition); Butt, W. R. (ed.) *Practical Immunoassay: The State of the Art*, Dekker, N.Y., 1984; Bizollon, Ch. A., ed., *Monoclonal Antibodies and New Trends in Immunoassays*, Elsevier, N.Y., 1984; Butler, J. E., *ELISA* (Chapter 29), In: van Oss, C. J. et al., (eds), *IMMUNOCHEMISTRY*, Marcel Dekker, Inc., New York, 1994, pp. 759-803; Butler, J. E. (ed.), *Immunochemistry of Solid-Phase Immunoassay*, CRC Press, Boca Raton, 1991; Weintraub, B., *Principles of Radioimmunoassays*, Seventh Training Course on Radioligand Assay Techniques, The Endocrine Society, March, 1986; Work, T. S. et al., *Laboratory Techniques and Biochemistry in Molecular Biology*, North Holland Publishing Company, NY, (1978) (Chapter by Chard, T., "An Introduction to Radioimmune Assay and Related Techniques").

#### B. B7-H4 Fusion Proteins

B7-H4 fusion polypeptides have a first fusion partner including all or a part of a B7-H4 protein fused (i) directly to a second polypeptide or, (ii) optionally, fused to a linker peptide sequence that is fused to the second polypeptide. An exemplary fusion protein is described in Sica, G. L. et al. B7-H4, a molecule of the B7 family, negatively regulates T cell immunity. *Immunity* 18, 849-61 (2003).

The B7-H4 fusion protein may be fused to a second polypeptide, preferably one or more domains of an Ig heavy chain constant region, preferably having an amino acid sequence corresponding to the hinge, C<sub>H2</sub> and C<sub>H3</sub> regions of a human immunoglobulin C<sub>γ</sub>1 chain.

The B7-H4 fusion proteins can include full-length B7-H4 polypeptides, or can contain a fragment of a full length B7-H4 polypeptide. In one embodiment, the fusion protein contains a fragment of B7-H4. As used herein, a fragment of B7-H4 refers to any subset of the polypeptide that is a shorter polypeptide of the full length protein. Useful fragments are those that retain the ability to bind to their natural ligands. A B7-H4 polypeptide that is a fragment of full-length B7-H4 typically has at least 20 percent, 30 percent, 40 percent, 50 percent, 60 percent, 70 percent, 80 percent, 90 percent, 95 percent, 98 percent, 99 percent, 100 percent, or even more than 100 percent of the ability to bind its natural ligand(s) as compared to full-length B7-H4.

One embodiment provides a fusion protein in which the first fusion partner is the extracellular domain of a B7-H4 protein. B7-H4 nucleotide and protein sequence are found in GENBANK under accession number AY280972. Additionally, B7-H4 is described in U.S. Pat. No. 6,891,030 and where permissible, is incorporated by reference in its entirety. The fusion protein can contain the entire extracellular domain of B7-H4 or a fragment thereof that retains biological activity of B7-H4.

The first fusion partner of the fusion protein includes the membrane distal IgV domain and the membrane proximal IgC domain of B7-H4. The construct can have at least 80%, 85%, 90%, 95%, or 99% sequence identity to:

maslqgiifw siiniiila gaaliigfg isgkhfvtv tftsagnige dgtlscfep diklmgiviq wkegikglv hefkegkddl sqqhemfgrg tafadqvvv gnaslrlknv qltdagtyc yirtskgkgn anleyktgaf smpeinvdyn asseslrcea prwfpqptva wasqvdqgan fsevsntsfelnsenvtmkv vsvlynviti ntyscmiend iakatgdikv tsevkrksq lqllns (SEQ ID NO:1) also referred to as B7-H4VC.

In another embodiment, the first fusion partner of the fusion protein includes the IgV domain of B7-H4. The construct can have at least 80%, 85%, 90%, 95%, or 99% sequence identity to:

maslqgiifw siiniiila gaaliigfg isgkhfvtv tftsagnige dgtlscfep diklmgiviq wkegikglv hefkegkddl sqqhemfgrg tafadqvvv gnaslrlknv qltdagtyc yirtskgkgn anleyktgaf smpein (SEQ ID NO:2) also referred to as B7-H4V.

In a preferred embodiment, the fusion protein includes the extracellular domain of B7-H4 or fragment thereof fused to an Ig Fc constant region. Recombinant B7-H4Ig fusion protein can be prepared by fusing the coding region of the extracellular domain of B7-H4 to the Fc constant region of mouse IgG2a as described previously (Chapoval et al. *Methods Mol. Med.* 45:247-255 (2000)).

The disclosed fusion proteins can be isolated using standard molecular biology techniques. For example, an expression vector containing a DNA sequence encoding B7-H4Ig is transfected into 293 cells by calcium phosphate precipitation and cultured in serum-free DMEM. The supernatant is collected at 72 h and the fusion protein is purified by Protein G SEPHAROSE® columns (Pharmacia, Uppsala, Sweden).

Variants of B7-H4 can also be used to produce a fusion protein that reduces, inhibits or blocks the biological function of sH4. As used herein, a "variant" B7-H4 polypeptide contains at least one amino acid sequence alteration as compared to the amino acid sequence of the corresponding wild-type B7-H4 polypeptide (e.g., a polypeptide having the amino acid sequence set forth in Accession No. AY280972). An amino acid sequence alteration can be, for example, a substitution, a deletion, or an insertion of one or more amino acids.

Variants of B7-H4 can have the same activity, substantially the same activity, or different activity than wildtype B7-H4. Substantially the same activity means that the variant is able to suppress T cell activation.

It will be appreciated that variants of the extracellular domain of B7-H4 can have at least 80% sequence identity with the extracellular domain of wild-type B7-H4 (i.e., Accession No. AY280972), typically at least 85%, more typically, at least 90%, even more typically, at least 95% sequence identity to the extracellular domain of B7-H4. In one embodiment, the fusion protein includes the extracellular domain of B7-H4 that is identical to the extracellular domain of B7-H4 in Accession No. AY280972.

Percent sequence identity can be calculated using computer programs or direct sequence comparison. Preferred computer program methods to determine identity between two sequences include, but are not limited to, the GCG program package, FASTA, BLASTP, and TBLASTN (see, e.g., D. W. Mount, 2001, *Bioinformatics: Sequence and Genome Analysis*, Cold Spring Harbor Laboratory Press, Cold Spring Harbor, N.Y.). The BLASTP and TBLASTN programs are publicly available from NCBI and other sources. The well-known Smith Waterman algorithm may also be used to determine identity.

Exemplary parameters for amino acid sequence comparison include the following: 1) algorithm from Needleman and Wunsch *J. Mol. Biol.*, 48:443-453 (1970); 2) BLOSSUM62 comparison matrix from Hentikoff and Hentikoff *Proc. Natl. Acad. Sci. U.S.A.*, 89:10915-10919 (1992); 3) gap penalty=12; and 4) gap length penalty=4. A program useful with

these parameters is publicly available as the "gap" program (Genetics Computer Group, Madison, Wis.). The aforementioned parameters are the default parameters for polypeptide comparisons (with no penalty for end gaps).

Alternatively, polypeptide sequence identity can be calculated using the following equation: % identity=(the number of identical residues)/(alignment length in amino acid residues)\*100. For this calculation, alignment length includes internal gaps but does not include terminal gaps.

Amino acid substitutions can be made using any amino acid or amino acid analog. For example, substitutions can be made with any of the naturally-occurring amino acids (e.g., alanine, aspartic acid, asparagine, arginine, cysteine, glycine, glutamic acid, glutamine, histidine, leucine, valine, isoleucine, lysine, methionine, proline, threonine, serine, phenylalanine, tryptophan, or tyrosine).

Amino acid substitutions in B7-H4 fusion proteins polypeptides may be conservative substitutions. As used herein, "conservative" amino acid substitutions are substitutions wherein the substituted amino acid has similar structural or chemical properties. "Non-conservative" amino acid substitutions are those in which the charge, hydrophobicity, or bulk of the substituted amino acid is significantly altered. Non-conservative substitutions will differ more significantly in their effect on maintaining (a) the structure of the peptide backbone in the area of the substitution, for example, as a sheet or helical conformation, (b) the charge or hydrophobicity of the molecule at the target site, or (c) the bulk of the side chain. Conservative substitutions typically include substitutions within the following groups: glycine and alanine; valine, isoleucine, and leucine; aspartic acid and glutamic acid; asparagine, glutamine, serine and threonine; lysine, histidine and arginine; and phenylalanine and tyrosine.

The disclosed fusion proteins and variants thereof preferably compete with sH4 to inhibit the biological activity of sH4, for example by binding to a common receptor. The receptor is typically a receptor on an immune cell that binds both sH4 and B7-H4. The variants of the extracellular domain of B7-H4 include conservative variants and non-conservative variants that increase the ability to of the fusion protein to compete with sH4 and thereby reduce the biological activity of sH4.

Also provided is a dimeric or trimeric fusion protein which is a dimer or trimer of the above fusion proteins. Preferably, the chains are tandemly linked via disulfide bonds or other interchain covalent bonds.

In a preferred dimeric fusion protein, the dimer results from the covalent bonding of Cys residue in the CH regions of two of the Ig heavy chains that are the same Cys residues that are disulfide linked in dimerized normal Ig H chains.

Suitable fusion proteins may include a multimer of two or more repeats of the first fusion partner linked end to end, directly or with a linker sequence between one or more monomers.

### C. Pharmaceutical Compositions

Pharmaceutical compositions including sH4 antagonists, and vectors containing the same are provided. The pharmaceutical compositions may be for administration by oral, parenteral (intramuscular, intraperitoneal, intravenous (IV) or subcutaneous injection), transdermal (either passively or using iontophoresis or electroporation), transmucosal (nasal, vaginal, rectal, or sublingual) routes of administration or using bioerodible inserts and can be formulated in dosage forms appropriate for each route of administration.

#### 1. Formulations for Parenteral Administration

In a preferred embodiment, the peptides are administered in an aqueous solution, by parenteral injection. The formula-

tion may also be in the form of a suspension or emulsion. In general, pharmaceutical compositions are provided including effective amounts of a sH4 antagonist, or derivative products, and optionally include pharmaceutically acceptable diluents, preservatives, solubilizers, emulsifiers, adjuvants and/or carriers. Such compositions include diluents sterile water, buffered saline of various buffer content (e.g., Tris-HCl, acetate, phosphate), pH and ionic strength; and optionally, additives such as detergents and solubilizing agents (e.g., TWEEN 20, TWEEN 80, Polysorbate 80), anti-oxidants (e.g., ascorbic acid, sodium metabisulfite), and preservatives (e.g., Thimer-sol, benzyl alcohol) and bulking substances (e.g., lactose, mannitol). Examples of non-aqueous solvents or vehicles are propylene glycol, polyethylene glycol, vegetable oils, such as olive oil and corn oil, gelatin, and injectable organic esters such as ethyl oleate. The formulations may be lyophilized and redissolved/resuspended immediately before use. The formulation may be sterilized by, for example, filtration through a bacteria retaining filter, by incorporating sterilizing agents into the compositions, by irradiating the compositions, or by heating the compositions.

#### 2. Formulations for Enteral Administration

sH4 antagonists can be formulated for oral delivery. Oral solid dosage forms are described generally in Remington's Pharmaceutical Sciences, 18th Ed. 1990 (Mack Publishing Co. Easton Pa. 18042) at Chapter 89. Solid dosage forms include tablets, capsules, pills, troches or lozenges, cachets, pellets, powders, or granules or incorporation of the material into particulate preparations of polymeric compounds such as polylactic acid, polyglycolic acid, etc. or into liposomes. Such compositions may influence the physical state, stability, rate of in vivo release, and rate of in vivo clearance of the present proteins and derivatives. See, e.g., Remington's Pharmaceutical Sciences, 18th Ed. (1990, Mack Publishing Co., Easton, Pa. 18042) pages 1435-1712 which are herein incorporated by reference. The compositions may be prepared in liquid form, or may be in dried powder (e.g., lyophilized) form. Liposomal or proteinoid encapsulation may be used to formulate the compositions (as, for example, proteinoid microspheres reported in U.S. Pat. No. 4,925,673). Liposomal encapsulation may be used and the liposomes may be derivatized with various polymers (e.g., U.S. Pat. No. 5,013,556). See also Marshall, K. In: Modern Pharmaceutics Edited by G. S. Banker and C. T. Rhodes Chapter 10, 1979. In general, the formulation will include the peptide (or chemically modified forms thereof) and inert ingredients which protect peptide in the stomach environment, and release of the biologically active material in the intestine.

The polypeptide antagonists may be chemically modified so that oral delivery of the derivative is efficacious. Generally, the chemical modification contemplated is the attachment of at least one moiety to the component molecule itself, where said moiety permits (a) inhibition of proteolysis; and (b) uptake into the blood stream from the stomach or intestine. Also desired is the increase in overall stability of the component or components and increase in circulation time in the body. PEGylation is a preferred chemical modification for pharmaceutical usage. Other moieties that may be used include: propylene glycol, copolymers of ethylene glycol and propylene glycol, carboxymethyl cellulose, dextran, polyvinyl alcohol, polyvinyl pyrrolidone, polyproline, poly-1,3-dioxolane and poly-1,3,6-tioxocane [see, e.g., Abuchowksi and Davis (1981) "Soluble Polymer-Enzyme Adducts," in Enzymes as Drugs. Hoenberg and Roberts, eds. (Wiley-Interscience: New York, N.Y.) pp. 367-383; and Newmark, et al. (1982) J. Appl. Biochem. 4:185-189].

Another embodiment provides liquid dosage forms for oral administration, including pharmaceutically acceptable emulsions, solutions, suspensions, and syrups, which may contain other components including inert diluents; adjuvants such as wetting agents, emulsifying and suspending agents; and sweetening, flavoring, and perfuming agents.

Controlled release oral formulations may be desirable. The sH4 antagonists can be incorporated into an inert matrix which permits release by either diffusion or leaching mechanisms, e.g., gums. Slowly degenerating matrices may also be incorporated into the formulation. Another form of a controlled release is based on the Oros therapeutic system (Alza Corp.), i.e. the drug is enclosed in a semipermeable membrane which allows water to enter and push drug out through a single small opening due to osmotic effects. For oral formulations, the location of release may be the stomach, the small intestine (the duodenum, the jejunum, or the ileum), or the large intestine. Preferably, the release will avoid the deleterious effects of the stomach environment, either by protection of the peptide (or derivative) or by release of the peptide (or derivative) beyond the stomach environment, such as in the intestine. To ensure full gastric resistance a coating impermeable to at least pH 5.0 is essential. Examples of the more common inert ingredients that are used as enteric coatings are cellulose acetate trimellitate (CAT), hydroxypropylmethylcellulose phthalate (HPMCP), HPMCP 50, HPMCP 55, polyvinyl acetate phthalate (PVAP), Eudragit L30D, Aquateric, cellulose acetate phthalate (CAP), Eudragit L, Eudragit S, and Shellac. These coatings may be used as mixed films.

#### 3. Topical Delivery Formulations

Compositions can be applied topically. This does not work well for most peptide formulations, although it can be effective especially if applied to the lungs, nasal, oral (sublingual, buccal), vaginal, or rectal mucosa. The sH4 antagonists can be delivered to the lungs while inhaling and traverses across the lung epithelial lining to the blood stream when delivered either as an aerosol or spray dried particles having an aerodynamic diameter of less than about 5 microns.

A wide range of mechanical devices designed for pulmonary delivery of therapeutic products can be used, including but not limited to nebulizers, metered dose inhalers, and powder inhalers, all of which are familiar to those skilled in the art. Some specific examples of commercially available devices are the Ultravent nebulizer (Mallinckrodt Inc., St. Louis, Mo.); the Acorn II nebulizer (Marquest Medical Products, Englewood, Colo.); the Ventolin metered dose inhaler (Glaxo Inc., Research Triangle Park, N.C.); and the Spinhaler powder inhaler (Fisons Corp., Bedford, Mass.). Nektar, Alkermes and Mannkind all have inhalable insulin powder preparations approved or in clinical trials where the technology could be applied to the formulations described herein.

Formulations for administration to the mucosa will typically be spray dried drug particles, which may be incorporated into a tablet, gel, capsule, suspension or emulsion. Standard pharmaceutical excipients are available from any formulator. Oral formulations may be in the form of chewing gum, gel strips, tablets or lozenges.

Transdermal formulations may also be prepared. These will typically be ointments, lotions, sprays, or patches, all of which can be prepared using standard technology. Transdermal formulations will require the inclusion of penetration enhancers.

4. Controlled Delivery Polymeric Matrices

Controlled release polymeric devices can be made for long term release systemically following implantation of a polymeric device (rod, cylinder, film, disk) or injection (microparticles). The matrix can be in the form of microparticles such as microspheres, where peptides are dispersed within a solid polymeric matrix or microcapsules, where the core is of a different material than the polymeric shell, and the peptide is dispersed or suspended in the core, which may be liquid or solid in nature. Unless specifically defined herein, microparticles, microspheres, and microcapsules are used interchangeably. Alternatively, the polymer may be cast as a thin slab or film, ranging from nanometers to four centimeters, a powder produced by grinding or other standard techniques, or even a gel such as a hydrogel.

Either non-biodegradable or biodegradable matrices can be used for delivery of sH4 antagonists, although biodegradable matrices are preferred. These may be natural or synthetic polymers, although synthetic polymers are preferred due to the better characterization of degradation and release profiles. The polymer is selected based on the period over which release is desired. In some cases linear release may be most useful, although in others a pulse release or "bulk release" may provide more effective results. The polymer may be in the form of a hydrogel (typically in absorbing up to about 90% by weight of water), and can optionally be crosslinked with multivalent ions or polymers.

The matrices can be formed by solvent evaporation, spray drying, solvent extraction and other methods known to those skilled in the art. Bioerodible microspheres can be prepared using any of the methods developed for making microspheres for drug delivery, for example, as described by Mathiowitz and Langer, *J. Controlled Release* 5, 13-22 (1987); Mathiowitz, et al., *Reactive Polymers* 6, 275-283 (1987); and Mathiowitz, et al., *J. Appl. Polymer Sci.* 35, 755-774 (1988).

The devices can be formulated for local release to treat the area of implantation or injection—which will typically deliver a dosage that is much less than the dosage for treatment of an entire body—or systemic delivery. These can be implanted or injected subcutaneously, into the muscle, fat, or swallowed.

III. Diagnostics

A. Detection of sH4 for Diagnosis of Disease and Disease States

Soluble B7-H4 is found in sera of approximately two-thirds of patients having rheumatoid arthritis (RA) and one-third of the systemic lupus erythematosus (SLE) patients sampled. The concentration of sH4 in an individual correlates closely with the severity, stage and progression of inflammation, particularly in autoimmune diseases (FIGS. 1a and 1b). In an experimental mouse model of RA and SLE, the effect of sH4 was recapitulated, and it was demonstrated that sH4 acts as a decoy to block suppressive functions of endogenous B7-H4, leading to exacerbation of systemic autoimmune diseases. The results demonstrate a role of sH4 in the pathogenesis of systemic autoimmune diseases.

An inflammatory response or condition in an individual can be diagnosed or detected by quantifying the amount of sH4 in a biological sample of the individual, wherein an elevated amount of sH4 in the individual's biological sample compared to a control (single or more preferably pooled or averaged values of normal individuals in the same assay) is indicative of an inflammatory response, preferably an autoimmune disease. A biological sample includes tissue or biological fluid such as a fluid from the individual, for example, blood, plasma, saliva, lymph, cerebrospinal fluid, synovial fluid, urine, or sputum. A control refers to a biological sample from an individual not experiencing an inflammatory response such as an autoimmune disease.

The amount of sH4 in a sample can be determined using conventional techniques such as enzyme-linked immunosorbent assays, mass spectrometry, spectrophotometry, or a combination thereof.

B7-H4 nucleotide and protein sequences are found in GENBANK under accession number AY280972. Additionally, B7-H4 is described in U.S. Pat. No. 6,891,030 and where permissible, is incorporated by reference in its entirety. One of ordinary skill in the art can determine the extracellular domain of B7-H4 based on these sequences.

In one embodiment, the sH4 that can be detected in a sample includes the membrane distal IgV domain and the membrane proximal IgC domain of B7-H4. In another embodiment the sH4 that is detected includes an amino acid sequence that is 80%, 85%, 90%, 95%, or 99% to the following amino acid sequences:

```
GFGISGRHSI TVTTVASAGN IGEDGIQSCT FEPDIKLSDI VIQWLKEGVL GLVHEFKEGK 60
DELSEQDEMF RGRТАVFADQ VIVGNASLRL KNVQLTDAGT YKCYIITSKG KGNANLEYKT 120
GAFSMPENVV DYNASSETLR CEAPRWFPQP TVVWASQVDQ GANFSEVSNT SFELNSENVT 180
MKVVSVLVNV TINNTYSCMI ENDIAKATGD IKVTESEIKR RS 222
```

(SEQ ID NO: 1) or

```
GFGISGRHSI TVTTVASAGN IGEDGILSCT FEPDIKLSDI VIQWLKEGVL GLVHEFKEGK 60
DELSEQDEMF RGRТАVFADQ VIVGNASLRL KNVQLTDAGT YKCYIITSKG KGNANLEYKT 120
GAFSMPENVV DYNASSETLR CEAPRWFPQR TVVWASQVDQ GANFSEVSNT SFELNSENVT 180
MKVVSVLVNV TINNTYSCMI ENDIAKATGD IKVTESEIKR RS 222
```

(SEQ ID NO:2) .

In another embodiment, the sH4 that is detected includes the IgV domain of B7-H4 includes an amino acid sequence that has at least 80%, 85%, 90%, 95%, or 99% sequence identity to:

```
GFGISGRHSI TVTTVASAGN IGEDGIQST FEPDIKLSDI VIQWLKEGVL GLVHEFKEGK 60
DELSEQDEMF RGR TAVFADQ VIVGNASLRL KNVQLTDAGT YKCYIITSKG KGNANLEYKT 120
GAFSMPEVNVN 129
(SEQ ID NO: 3) or
GEGISGRHSI TVTTVASAGN IGEDGILSCT FEPDIKLSDI VIQWLKEGVL GLVHEFKEGK 60
DELSEQDEMF RGR TAVFADQ VIVGNASLRL KNVQLTDAGT YKCYIITSKG KGNANLEYKT 120
GAFSMPEVNVN 129
(SEQ ID NO: 4) .
```

In yet another embodiment, the sH4 that is detected includes a fragment of B7-H4 having an amino acid sequence that has at least 80%, 85%, 90%, 95%, or 99% sequence identity to:

```
GFGISGRHSI TVTTVASAGN IGEDGILSCT FEPDIKLSDI VIQWLKEGVL GLVHEFKEGK 60
DELSEQDEMF RGR TAVFADQ VIVGNASLRL KNVQLTDAGT YKCYIITSKG KGNANLEYKT120
GAFSMPEVNV DYNASSETLR CEAPRWFPQP TVVWASQVDQ GANFSEVSNT SFELNSENVT180
MKVSVLYNV TINNTYSCMI ENDIAKATGD IKVTESEIKR RSHLQLLNSK ASLCVSSFFA240
ISWALLPLSP YLMLK 255
(SEQ ID NO: 5)
```

In still another embodiment, the sH4 that is detected is a fragment of B7-H4 having the following amino acid sequence having an amino acid sequence that has at least 80%, 85%, 90%, 95%, or 99% sequence identity to:

```
GFGISGRHSI TVTTVASAGN IGEDGIQST FEPDIKLSDI VIQWLKEGVL GLVHEFKEGK 60
DELSEQDEMF RGR TAVFADQ VIVGNASLRL KNVQLTDAGT YKCYIITSKG KGNANLEYKT120
GAFSMPEVNV DYNASSETLR CEAPRWFPQP TVVWASQVDQ GANFSEVSNT SFELNSENVT180
MKVSVLYNV TINNTYSCMI ENDIAKATGD IKVTESEIKR RSHLQLLNSK ASLCVSSFFA240
ISWALLPLSP YLMLK 255
(SEQ ID NO: 6)
```

The propensity of the subject developing or having an inflammatory disorder can be determined based on the levels of sH4 in the subject, preferably serum levels of sH4 in the subject. If the levels of sH4 in the subject are higher than the average sH4 levels in subjects without inflammatory disorders, the subject is more likely to develop an inflammatory disorder or to have an inflammatory disorder.

The severity of an inflammatory response or an autoimmune disease can be detected or assessed by quantifying the level of sH4 in an individual's biological sample and correlating the amount of sH4 in the individual's biological sample with amount(s) of sH4 indicative of different stages of an inflammatory response or autoimmune disease. The amounts of sH4 that correlate with different stages of inflammatory disease or different levels of severity can be predetermined by

quantifying sH4 in patients at different stages of inflammatory disease, or with different severity of disease. For example, with RA the following classification for severity is typically employed: Class I: No restriction of ability to per-

form normal activities; Class II: Moderate restriction, but with an ability to perform most activities of daily living; Class III: Marked restriction, with an inability to perform most activities of daily living and occupation; and Class IV: Inca-

pacitation with confinement to bed or wheelchair. Levels of sH4 can be determined in patients from each classification to produce a reference level of sH4 that can be correlated with the specific severity level.

1. Methods of Detecting sH4 in a Biological Sample Using Antibodies

Certain embodiments provide methods for detecting the presence and/or measuring a level of sH4 in a biological sample, using an sH4-specific antibody or an anti-B7-H4 antibody. Preferably the antibody recognizes an epitope on any one of the polypeptides encoded by SEQ ID NOs:1-6. The methods generally include:

- a) contacting the sample with an antibody specific for sH4; and
- b) detecting binding between the antibody and molecules of the sample.

Detection of specific binding of the sH4-specific antibody, when compared to a suitable control, is an indication that sH4 is present in the sample. Suitable controls include a sample known not to contain sH4, and a sample contacted with an

antibody not specific for sH4, e.g., an anti-idiotypic antibody. A variety of methods to detect specific antibody-antigen interactions are known in the art and can be used in the method, including, but not limited to, standard immunohistochemical methods, immunoprecipitation, an enzyme immunoassay, and a radioimmunoassay. In general, the sH4-specific antibody will be detectably labeled, either directly or indirectly. Direct labels include radioisotopes; enzymes whose products are detectable (e.g., luciferase,  $\beta$ -galactosidase, and the like); fluorescent labels (e.g., fluorescein isothiocyanate, rhodamine, phycoerythrin, and the like); fluorescence emitting metals, e.g.,  $^{152}\text{Eu}$ , or others of the lanthanide series, attached to the antibody through metal chelating groups such as EDTA; chemiluminescent compounds, e.g., luminol, isoluminol, acridinium salts, and the like; bioluminescent compounds, e.g., luciferin, aequorin (green fluorescent protein), and the like. The antibody may be attached (coupled) to an insoluble support, such as a polystyrene plate or a bead. Indirect labels include second antibodies specific for sH4-specific antibodies, wherein the second antibody is labeled as described above; and optionally contain members of specific binding pairs, e.g., biotin-avidin, and the like. The biological sample may be brought into contact with and immobilized on a solid support or carrier, such as nitrocellulose, that is capable of immobilizing cells, cell particles, or soluble proteins. The support may then be washed with suitable buffers, followed by contacting with a detectably-labeled sH4-specific antibody.

Still other embodiments provide methods for detecting the presence and/or measuring a level of sH4 in a biological sample. The methods generally include:

a) contacting the sample with an sH4 ligand, for example a B7-H4 receptor or fragment thereof that binds sH4; and

b) detecting binding between the B7-H4 receptor and molecules of the sample.

Detection of specific binding of the B7-H4 receptor is an indication that sH4 polypeptides are present in the sample.

Methods for detecting binding between a B7-H4 receptor and sH4 are known in the art and include immunoprecipitation of B7-H4 receptor-ligand complexes using an antibody specific to the B7-H4 receptor, as long as the antibody does not disrupt B7-H4 receptor sH4 binding. Alternatively, the B7-H4 receptor used may be a fusion protein which provides for specific immunoprecipitation of the fusion partner, an enzymatic detection, a fluorescent signal (e.g., a green fluorescent protein). The B7-H4 receptor can be labeled with any detectable label, as described above. The B7-H4 receptor can be attached, directly or through a linker, to an insoluble support (e.g., polystyrene beads, magnetic beads, and the like), thereby providing a means for separating sH4/receptor complexes from the biological sample, and subsequently detecting the presence of and/or measuring the amount (level) of sH4. The latter method can also be used to identify new proteins that bind to the B7-H4 receptor.

## 2. Methods of Determining Therapeutic Efficacy of Drug Treatment in an Individual

The therapeutic efficacy of a treatment for an inflammatory disease or disorder or an autoimmune disease can be assessed by quantifying the level of sH4 in an individual's biological sample over the course of treatment. Levels of sH4 present in a biological sample from the individual can be determined prior to treatment and subsequently at various time intervals during treatment. The levels of sH4 present in the biological sample of the individual undergoing treatment can be compared to the levels of sH4 present in biological samples from the same individual prior to treatment to determine the efficacy of the treatment in reducing or inhibiting the inflamma-

tory disease or disorder. The levels of sH4 in biological samples of the individual undergoing treatment can additionally or alternatively be compared to amounts of sH4 indicative of different stages of an inflammatory response or autoimmune disease.

## 3. Methods of Determining Neutrophil Levels in a Biological Sample

Alternatively, the amount of sH4 can be correlated to levels of neutrophils. In certain individuals with inflammatory responses or autoimmune disease, sH4 concentration is elevated as are levels of neutrophils. Thus, sH4 levels in an individual can be correlated to neutrophil levels. Levels of sH4 that correspond to specific levels of neutrophils can be predetermined by assaying the levels of sH4 in subjects and assaying the levels of neutrophils in the subjects. Once the reference levels are determined, a biological sample from a subject can be assayed for sH4 levels. The resulting sH4 levels are then compared to the predetermined sH4 levels correlated to specific levels of neutrophils. The resulting sH4 levels are matched to the predetermined levels to determine the neutrophils levels in the subject. The number of neutrophils in a healthy individual ranges from about 15,000 to 20,000 cells/ $\mu\text{L}$ .

## 4. Inflammatory Disorders to be Detected

Representative inflammatory responses or autoimmune diseases that can be detected or assessed for severity include, but are not limited to, rheumatoid arthritis, systemic lupus erythematosus, alopecia areata, ankylosing spondylitis, antiphospholipid syndrome, autoimmune Addison's disease, autoimmune hemolytic anemia, autoimmune hepatitis, autoimmune inner ear disease, autoimmune lymphoproliferative syndrome (alps), autoimmune thrombocytopenic purpura (ATP), Behcet's disease, bullous pemphigoid, cardiomyopathy, celiac sprue-dermatitis, chronic fatigue syndrome immune deficiency, syndrome (CFIDS), chronic inflammatory demyelinating polyneuropathy, cicatricial pemphigoid, cold agglutinin disease, Crest syndrome, Crohn's disease, Deigo's disease, dermatomyositis, dermatomyositis—juvenile, discoid lupus, essential mixed cryoglobulinemia, fibromyalgia—fibromyositis, grave's disease, guillain-barre, hashimoto's thyroiditis, idiopathic pulmonary fibrosis, idiopathic thrombocytopenia purpura (ITP), Iga nephropathy, insulin dependent diabetes (Type I), juvenile arthritis, Meniere's disease, mixed connective tissue disease, multiple sclerosis, myasthenia gravis, pemphigus vulgaris, pernicious anemia, polyarteritis nodosa, polychondritis, polyglanular syndromes, polymyalgia rheumatica, polymyositis and dermatomyositis, primary agammaglobulinemia, primary biliary cirrhosis, psoriasis, Raynaud's phenomenon, Reiter's syndrome, rheumatic fever, sarcoidosis, scleroderma, Sjogren's syndrome, stiff-man syndrome, Takayasu arteritis, temporal arteritis/giant cell arteritis, ulcerative colitis, uveitis, vasculitis, vitiligo, and Wegener's granulomatosis.

## B. Kits and Detection Devices

A lateral flow device for indicating the presence or concentration of sH4 in a sample is provided. The device can be a component of a kit. The components of the kit are typically packaged in a container suitable for shipping. The kit can include reagents, buffers, and instructions for using the lateral flow device.

An exemplary lateral flow device includes a solid support having an application zone for receiving a fluid sample from a subject, a labeling zone containing label which binds to sH4 in the sample, and a detection zone where sH4-bound label is retained. Label retained in the detection zone gives a signal, and the signal differs depending on whether sH4 levels are

lower than or equal to/greater than a given reference concentration. FIGS. 1a and 1b show exemplary ranges of the concentrations of sH4 detected in samples from patients. The mean concentration of 0-14 in patients having RA or SLE is approximately 100 ng/ml.

The application zone in the device is suitable for receiving a fluid sample. It is typically formed from absorbent material such as blotting paper. The labeling zone contains label which binds to any sH4 in the fluid sample. For reasons of specificity, the label is typically antibody. For ease of detection, the label is preferably visible to the naked eye e.g. it is tagged with a fluorescent tag or, preferably, a colored tag such as conjugated colloidal gold, which is visible as a pink color.

The detection zone retains sH4 to which label has bound. This will typically be achieved using an immobilized capture reagent, such as an antibody. Where the capture reagent and the label are both antibodies, they will recognize different epitopes on sH4. This allows the formation of a "sandwich" comprising antibody-sH4-antibody.

The detection zone is downstream of the application zone, with the labeling zone typically located between the two. A fluid sample will thus migrate from the application zone into the labeling zone, where any sH4 in the sample binds to the label. sH4-label complexes continue to migrate into the detection zone together with excess label. When the sH4-label complex encounters the capture reagent, the complex is retained while the sample and excess label continue to migrate. As sH4 levels in the sample increase, the amount of label (in the form of sH4-label complex) retained in the detection zone increases proportionally.

One type of device includes a reference zone which includes a signal of fixed intensity against which the amount of label retained in the detection zone can be compared—when the signal in the detection zone equals the signal in the reference zone, the sample is a threshold sample; when the signal in the detection zone is less intense than the reference zone, the sample contains less sH4 than a threshold sample; when the signal in the detection zone is more intense than the reference zone, the sample contains more sH4 than a threshold sample. A suitable reference zone can be prepared and calibrated without difficulty. For this type of device, label will generally be present in excess to sH4 in the sample, and the reference zone may be upstream or, preferably, downstream of the detection zone. It is apparent that the signal in the reference zone will be of the same type as the signal in the detection zone i.e. they will typically both be visible to the naked eye e.g. they will use the same tag. A preferred reference zone in a device of this type includes immobilized protein (e.g., bovine serum albumin) which is tagged with colloidal gold.

In another device, the reference zone is downstream of the detection zone and includes a reagent which captures label (e.g. an immobilized anti-label antibody). Label which flows through the device is not present in excess, but is at a concentration such that 50% of it is bound by a sample having sH4 at the threshold concentration. In a threshold sample, therefore, 50% of the label will be retained in the detection zone and 50% in the reference zone. If the sH4 level in the sample is greater than in a threshold sample, less than 50% of the label will reach the reference zone and the detection zone will give a more intense signal than the reference zone; conversely, if the sH4 level in the sample is less than in a threshold sample, less than 50% of the label will be retained in the detection zone and the reference zone will give a more intense signal than the detection zone.

In another embodiment, the reference zone is downstream of the detection zone and includes a limiting amount of a

reagent which captures label (e.g. an immobilized anti-label antibody). The reagent is present at a level such that it retains the same amount of label which would bind to detection zone for a threshold sample, with excess label continuing to migrate beyond the reference zone.

In these three types of device, therefore, a comparison between the detection zone and the reference zone is used to compare the sample with the threshold concentration. The detection:reference binding ratio can preferably be determined by eye. Close juxtaposition of the detection and reference zones is preferred in order to facilitate visual comparison of the signal intensities in the two zones.

In a fourth type of device, no reference zone is needed, but the detection zone is configured such that it gives an essentially on/off response i.e. no signal is given below the threshold concentration but, at or above the threshold, signal is given.

In a fifth type of device, no reference zone is needed, but an external reference is used which corresponds to the threshold concentration. This can take various forms e.g. a printed card against which the signal in the detection zone can be compared, or a machine reader which compares an absolute value measured in the detection zone (e.g. a calorimetric signal) against a reference value stored in the machine.

In some embodiments, the device includes a control zone downstream of the detection zone. This will generally be used to capture excess label which passes through the detection and/or reference zones (e.g. using immobilized anti-label antibody). When label is retained at the control zone, this confirms that mobilization of the label and migration through the device have both occurred. It will be appreciated that this function may be achieved by the reference zone.

The detection, reference and control zones are preferably formed on nitrocellulose.

Migration from the application zone to the detection zone will generally be assisted by a wick downstream of the detection zone to aid capillary movement. This wick is typically formed from absorbent material such as blotting or chromatography paper.

The device can be produced simply and cheaply, conveniently in the form of a dipstick.

FIG. 2 shows an exemplary lateral flow device. The test strip (1) of can be constructed on a plastic backing sheet. A strip of nitrocellulose membrane (20) (Millipore Corporation, Product Code HF135) is optionally placed onto the backing sheet. An upper wick (30) formed from blotting paper grade material (Ahlstrom Filtration, Product Code 222) is placed on top of the nitrocellulose at one end, with a partial overlap. At the other end, a polyester pad (40) is placed over the nitrocellulose (20), and a piece of absorbent paper (50) is placed on top of the pad (40). Paper (50) and pad (40) can overlap.

One end (45) is sprayed with colloidal gold (40 nm) conjugated to murine monoclonal antibody to B7-H4 or sH4. 3 microliters of OD10 gold conjugate is applied per test strip. To measure the concentration of gold particles in a given reagent sample, the conjugate under test is diluted to give an  $OD_{520nm}$  of about 1.0, and this is multiplied by the dilution factor to give an equivalent OD for the original reagent sample.

The end (45) containing the antibody is not covered by paper (50) and overlaps nitrocellulose (20).

The nitrocellulose strip (20) contains three stripes of reagents. The first stripe (21) is downstream of area (45) and includes monoclonal anti-B7-H4 or anti sH4, applied by striping (1  $\mu$ l/cm of 0.75 mg/ml antibody). The second and optional stripe (22) is downstream of area (45) and includes

colloidal gold (40 nm) conjugated to BSA, applied by striping (1  $\mu$ l/cm, target OD 3.5). The third stripe (23) is 17 mm downstream of area (45) and includes goat anti-mouse antibody (Jackson Immunoresearch Labs Inc., Product Code 115-005-062), applied by striping (1  $\mu$ l/cm of 1.5 mg/ml antibody). The device thus has excess free label.

The assembled strip (1) can be mounted in a plastic housing (60; Advanced Microdevices 8 mm cassette) having a window (65) through which a fluid sample can be applied to absorbent paper (50) and a window (68) through which stripes (21), (22) and (23) are visible.

During use of the device, a fluid sample is applied to absorbent paper (50). Lateral flow along the device (1) commences and the sample passes into pad (40) and through area (45), where any sH4 in the sample binds to labeled anti-B7-H4 or anti-sH4. Flow continues into nitrocellulose strip (20). At stripe (21), sH4-antibody complex is retained by immobilized antibodies to sH4 that recognize a different epitope on sH4 than the labeled antibody, but free labeled antibody continues to stripe (23), where it is bound and retained by immobilized goat-anti-mouse antibodies.

#### IV. Methods of Treating Inflammatory Responses

Chronic and persistent inflammation is a major cause of the pathogenesis and progression of systemic autoimmune diseases such as rheumatoid arthritis (RA) and systemic lupus erythematosus (SLE). sH4 acts as a decoy molecule to block endogenous B7-H4. B7-H4 inhibits cell cycle progression of T cells in the presence of antigen stimulation. B7-H4 can inhibit innate immunity by suppressing proliferation of neutrophil progenitors. It is believed that elevated levels of sH4 block the inhibitory effect of endogenous B7-H4.

Therefore, an inflammatory response can be treated by interfering with the biological activity of sH4 *in vivo*, for example, by administering to an individual in need thereof an effective amount of a sH4 antagonist to inhibit or decrease one or more symptoms of the disease, which may be indicated by a decrease in neutrophil levels. Interference of sH4 biological activity can be accomplished by down regulating expression of sH4, removing sH4, conjugating sH4 with a binding agent *in vivo*, for example an antibody, increasing the endogenous levels of B7-H4, administering B7-H4 fusion proteins, or a combination thereof.

##### A. Down-Regulation of sH4 Expression

One method for treating a inflammatory response or autoimmune disease is by administering to an individual in need thereof an amount of inhibitory nucleic acid specific for a nucleic acid encoding sH4 effective to reduce or inhibit the inflammatory response. The inhibitory nucleic acid can be antisense DNA, siRNA, microRNA, or a combination thereof. Alternatively, the inhibitory nucleic acid can be specific for a protease that cleaves B7-H4 to produce sH4. In a preferred embodiment, the inhibitory nucleic acid downregulates sH4 expression without having a statistically significant effect on B7-H4 expression. In certain aspects, the downregulation of sH4 causes a decrease in the neutrophil population.

##### B. Removal of sH4

Another method for treating an inflammatory response or autoimmune disorder in an individual is by removing sH4 from an individual's blood or plasma. Soluble B7-H4 can be removed using well known techniques such as ultrapheresis, apheresis, or dialysis. In one embodiment, blood or plasma is removed from an individual. Soluble B7-H4 is selectively removed from the blood or plasma *ex vivo*. Selective removal

of sH4 can be achieved using filters having specific molecular weight cutoffs that allow sH4 to pass while other components are retained.

Alternatively, the blood or plasma can be contacted with binding agents specific for sH4. The binding agents can be immobilized on a substrate. Suitable binding agents include, but are not limited to antibodies or antigen-binding antibody fragments specific for sH4 or natural ligands of sH4. The binding agents specifically bind sH4 and capture the sH4, thereby removing it from the blood or plasma. The treated blood or plasma is then returned to the individual.

##### C. Inactivation of sH4

Another method for treating an inflammatory response or autoimmune disease is by administering to an individual in need thereof, a sH4 binding agent in an amount effective to reduce or inhibit the inflammatory response. A representative binding agent includes, but is not limited to an antibody or antigen-binding fragment thereof that inhibits or reduces a biological activity of sH4. A representative antibody is mAb hH4.3. It will be appreciated that small molecules can be used to bind and inactivate sH4 *in vivo*.

##### D. Over-Expression of B7-H4

Over-expression of B7-H4 can be used to compete with endogenous sH4 and can therefore be an effective means for treating inflammatory responses and autoimmune diseases or disorders. Overexpression of B7-H4 can be accomplished by stimulating endogenous B7-H4 to increase expression. Alternatively, B7-H4 can be administered as a bolus to an individual in need thereof to temporarily increase serum levels of B7-H4.

Another method for treating an inflammatory response or autoimmune disease is by administering to an individual in need thereof a nucleic acid construct encoding B7-H4, or a functional fragment thereof. Functional fragment means a B7-H4 fragment that interferes with, inhibits or reduces sH4 biological activity.

In another embodiment, B7-H4 fusion protein can be administered to an individual in need thereof in an amount effective to reduce or inhibit sH4-mediated inflammation or a symptom thereof. The B7-H4 fusion proteins are discussed above. Alternatively, a nucleic acid construct encoding the B7-H4 fusion can be administered to an individual in need thereof wherein the nucleic acid construct is expressed in the individual and produces B7-H4 fusion protein in amounts effective to reduce or inhibit sH4 biological function.

##### E. Gene Delivery

Nucleic acids encoding sH4 antagonists can be administered to an individual in need thereof in an amount effective to treat an inflammatory response or autoimmune disease. DNA delivery involves introduction of a "foreign" DNA into a cell and ultimately, into a live animal. Gene delivery can be achieved using viral vectors or non-viral vectors. One approach includes nucleic acid transfer into primary cells in culture followed by autologous transplantation of the *ex vivo* transformed cells into the individual, either systemically or into a particular organ or tissue.

Nucleic acid therapy can be accomplished by direct transfer of a functionally active DNA into mammalian somatic tissue or organ *in vivo*. DNA transfer can be achieved using a number of approaches described below. These systems can be tested for successful expression *in vitro* by use of a selectable marker (e.g., G418 resistance) to select transfected clones expressing the DNA, followed by detection of the presence of the B7-H4 expression product (after treatment with the inducer in the case of an inducible system) using an antibody to the product in an appropriate immunoassay. Efficiency of the procedure, including DNA uptake, plasmid integration

and stability of integrated plasmids, can be improved by linearizing the plasmid DNA using known methods, and co-transfection using high molecular weight mammalian DNA as a "carrier".

Retroviral-mediated human therapy utilizes amphotropic, replication-deficient retrovirus systems (Weiss and Taylor, *Cell*, 82:531-533 (1995)). Such vectors have been used to introduce functional DNA into human cells or tissues, for example, the adenosine deaminase gene into lymphocytes, the NPT-II gene and the gene for tumor necrosis factor into tumor infiltrating lymphocytes. Retrovirus-mediated gene delivery generally requires target cell proliferation for gene transfer (Bordignon et al. *Science* 270:470-475 (1995)). This condition is met by certain of the preferred target cells into which the present DNA molecules are to be introduced, i.e., actively growing tumor cells. Gene therapy of cystic fibrosis using transfection by plasmids using any of a number of methods and by retroviral vectors has been described by Collins et al., U.S. Pat. No. 5,240,846.

The DNA molecules encoding the B7-H4 polypeptides or fusion proteins may be packaged into retrovirus vectors using packaging cell lines that produce replication-defective retroviruses, as is well-known in the art (see, for example Stone, D. et al. *J. Endocrinology*, 164:103-118 (2000)). Additional viruses for gene delivery are described in Reynolds et al. *Molecular Medicine Today*, 5:25-31 (1999).

Other virus vectors may also be used, including recombinant adenoviruses (Murphy et al. *Proc Natl Acad Sci* 94:13921-13926 (1997)), herpes simplex virus (HSV) for neuron-specific delivery and persistence (Lowenstein et al. *Brain Res. Molec. Brain Res*, 30:169-175 (1995)). Advantages of adenovirus vectors for human gene therapy include the fact that recombination is rare, no human malignancies are known to be associated with such viruses, the adenovirus genome is double stranded DNA which can be manipulated to accept foreign genes of up to 7.5 kb in size, and live adenovirus is a safe human vaccine organisms. Adeno-associated virus is also useful for human therapy (Samulski, R. J. et al., *EMBO J.* 10:3941 (1991)).

Another vector which can express the disclosed DNA molecule and is useful in the present therapeutic setting, particularly in humans, is vaccinia virus, which can be rendered non-replicating (Peplinkski, G. R. et al. *Surgical Oncology Clinics of North America*, 7575-588 (1998)). Descriptions of recombinant vaccinia viruses and other viruses containing heterologous DNA and their uses in immunization and DNA therapy are reviewed in: Moss, B., *Curr. Opin. Genet. Dev.* 3:86-90 (1993); Moss, B., *Biotechnology* 20: 345-362 (1992); Moss, B., *Curr Top Microbial Immunol* 158:25-38 (1992); Moss, B., *Science* 252:1662-1667 (1991); Piccini, A et al., *Adv. Virus Res.* 34:43-64 (1988); Moss, B. et al., *Gene Amplif Anal* 3:201-213 (1983).

In addition to naked DNA or RNA, or viral vectors, engineered bacteria may be used as vectors. A number of bacterial strains including *Salmonella*, BCG and *Listeria monocytogenes* (LM) (Hoiseh & Stocker, *Nature* 291, 238-239 (1981); Poirier, T P et al. *J. Exp. Med.* 168, 25-32 (1988); (Sadoff, J. C., et al., *Science* 240, 336-338 (1988); Stover, C. K., et al., *Nature* 351, 456-460 (1991); Aldovini, A. et al., *Nature* 351, 479-482 (1991); Schafer, R., et al., *J. Immunol.* 149, 53-59 (1992); Ikonomidis, G. et al., *J. Exp. Med.* 180, 2209-2218 (1994)). These organisms display two promising characteristics for use as vaccine vectors: (1) enteric routes of infection, providing the possibility of oral vaccine delivery; and (2) infection of monocytes/macrophages thereby targeting antigens to professional APCs.

In addition to virus-mediated gene transfer in vivo, physical means well-known in the art can be used for direct transfer of DNA, including administration of plasmid DNA (Wolff et al., *Science*, 247:1465-1468 (1990); Hickman, M. A., et al. *Hum. Gene Ther.*, 5:1477-1483 (1994)) and particle-bombardment mediated gene transfer (O'Brien, J. et al. *Brain Res Brain Res Protoc*, 10:12-15 (2002)). Furthermore, electroporation, a well-known means to transfer genes into cell in vitro, can be used to transfer DNA molecules to tissues in vivo (Titimirov, A. V. et al., *Biochim. Biophys. Acta* 1088:131 ((1991)).

"Carrier mediated gene transfer" has also been described (Wu, C. H. et al., *J. Biol. Chem.* 264:16985 (1989); Wu, G. Y. et al., *J. Biol. Chem.* 263:14621 (1988); Soriano, P. et al., *Proc. Natl. Acad. Sci. USA* 80:7128 (1983); Wang, C-Y. et al., *Proc. Natl. Acad. Sci. USA* 84:7851 (1982); Wilson, J. M. et al., *J. Biol. Chem.* 267:963 (1992)). Preferred carriers are targeted liposomes (Liu et al. *Curr Med Chem*, 10:1307-1315 (2003)) such as immunoliposomes, which can incorporate acylated mAbs into the lipid bilayer. Polycations such as asialoglycoprotein/polylysine (Wu et al., 1989, supra) may be used, where the conjugate includes a molecule which recognizes the target tissue (e.g., asialoorosomucoid for liver) and a DNA binding compound to bind to the DNA to be transfected. Polylysine is an example of a DNA binding molecule which binds DNA without damaging it. This conjugate is then complexed with plasmid DNA for transfer.

Plasmid DNA used for transfection or microinjection may be prepared using methods well-known in the art, for example using the Quiagen procedure (Quiagen), followed by DNA purification using known methods, such as the methods exemplified herein.

#### F. Combination Therapy

The disclosed compositions can be administered to a subject in need thereof alone or in combination with one or more additional therapeutic agents including, but not limited to immunosuppressive agents, e.g., antibodies against other lymphocyte surface markers (e.g., CD40) or against cytokines, other fusion proteins, e.g., CTLA41g, or other immunosuppressive drugs (e.g., cyclosporin A, FK506-like compounds, rapamycin compounds, or steroids), anti-proliferatives, cytotoxic agents, or other compounds that may assist in immunosuppression.

As used herein the term "rapamycin compound" includes the neutral tricyclic compound rapamycin, rapamycin derivatives, rapamycin analogs, and other macrolide compounds which are thought to have the same mechanism of action as rapamycin (e.g., inhibition of cytokine function). The language "rapamycin compounds" includes compounds with structural similarity to rapamycin, e.g., compounds with a similar macrocyclic structure, which have been modified to enhance their therapeutic effectiveness. Exemplary Rapamycin compounds are known in the art (See, e.g. WO 95122972, WO 95116691, WO 95104738, U.S. Pat. Nos. 6,015,809; 5,989,591; U.S. Pat. Nos. 5,567,709; 5,559,112; 5,530,006; 5,484,790; 5,385,908; 5,202,332; 5,162,333; 5,780,462; 5,120,727).

The language "FK506-like compounds" includes FK506, and FK506 derivatives and analogs, e.g., compounds with structural similarity to FK506, e.g., compounds with a similar macrocyclic structure which have been modified to enhance their therapeutic effectiveness. Examples of FK506-like compounds include, for example, those described in WO 00101385. Preferably, the language "rapamycin compound" as used herein does not include FK506-like compounds.

Other suitable therapeutics include, but are not limited to, anti-inflammatory agents. The anti-inflammatory agent can

be non-steroidal, steroidal, or a combination thereof. One embodiment provides oral compositions containing about 1% (w/w) to about 5% (w/w), typically about 2.5% (w/w) or an anti-inflammatory agent. Representative examples of non-steroidal anti-inflammatory agents include, without limitation, oxicams, such as piroxicam, isoxicam, tenoxicam, sudoxicam; salicylates, such as aspirin, disalcid, benorylate, trilisate, safapryn, soiprin, diflunisal, and fendosal; acetic acid derivatives, such as diclofenac, fenclofenac, indomethacin, sulindac, tolmetin, isoxepac, furofenac, tiopinac, zidometacin, acemetacin, fentiazac, zomepirac, clindanac, oxepinac, felbinac, and ketorolac; fenamates, such as mefenamic, meclofenamic, flufenamic, niflumic, and tolfenamic acids; propionic acid derivatives, such as ibuprofen, naproxen, benoxaprofen, flurbiprofen, ketoprofen, fenoprofen, fenbufen, indoprofen, piroprofen, carprofen, oxaprozin, pranoprofen, miroprofen, tiroxaprofen, suprofen, alminoprofen, and tiaprofenic; pyrazoles, such as phenylbutazone, oxyphenbutazone, feprazone, azapropazone, and trimethazone. Mixtures of these non-steroidal anti-inflammatory agents may also be employed.

Representative examples of steroidal anti-inflammatory drugs include, without limitation, corticosteroids such as hydrocortisone, hydroxyl-triamcinolone, alpha-methyl dexamethasone, dexamethasone-phosphate, beclomethasone dipropionates, clobetasol valerate, desonide, desoxymethasone, desoxycorticosterone acetate, dexamethasone, dichlorisone, diflorasone diacetate, diflucortolone valerate, fludrenolone, flucorolone acetonide, fludrocortisone, flumethasone pivalate, fluosinolone acetonide, fluocinonide, flucortine butylesters, fluocortolone, fluprednidene (fluprednylidene) acetate, flurandrenolone, halcinonide, hydrocortisone acetate, hydrocortisone butyrate, methylprednisolone, triamcinolone acetonide, cortisone, cortodoxone, flucetonide, fludrocortisone, difluorosone diacetate, fluradrenolone, fludrocortisone, difluorosone diacetate, fluradrenolone acetonide, medrysone, amcinafel, amcinafide, betamethasone and the balance of its esters, chloroprednisone, chlorprednisone acetate, clocortelone, clescinolone, dichlorisone, diflurprednate, flucorolone, flunisolid, fluoromethalone, fluperolone, fluprednisolone, hydrocortisone valerate, hydrocortisone cyclopentylpropionate, hydrocortamate, meprednisone, paramethasone, prednisolone, prednisone, beclomethasone dipropionate, triamcinolone, and mixtures thereof.

## EXAMPLES

### Example 1

#### Soluble B7-H4 in the Sera of Rheumatoid Arthritis Patients Correlates with Disease Severity

##### Patients and Healthy Donors:

Sera samples were obtained from 68 patients with diagnosed RA, 35 patients with diagnosed SLE and 24 normal healthy donors under approval of the Internal Review Board of Mayo Clinic. RA patients were classified to 4 groups as follows: 0: no active disease, 1: 1-4 active joints, 2: 5-9 active joints, 3: more than 10 active joints with or without extra-articular disease.

Detection of Soluble B7-H4, Collagen-Specific Autoantibodies and Anti-dsDNA Autoantibody:

For detection of human sH4, specific mAb hH4.3 (2 µg/ml) and hH4.1 (2 µg/ml) against human B7-H4 was used as capture and detection, respectively, in ELISA. To remove Rheumatoid Factor, the sera were treated with human IgG agarose

(Sigma-Aldrich, St. Louis, Mo.) before detection in ELISA. For measurement of collagen-specific autoantibodies, chicken collagen (1 µg/ml) was coated on the plate overnight at 4° C., and biotin conjugated anti-mouse IgG, IgG1, IgG2a and IgG2b Ab (BD, San Jose, Calif.) as detection antibodies. To measure anti-dsDNA autoantibody levels, dsDNA from salmon testes at 10 µg/ml in PBS was coated on the plate overnight at 4° C., and HRP conjugated anti-mouse IgG, (BD, San Jose, Calif.).

##### Western Blot:

The sera was mixed with 2× sample buffer (4% SDS, 0.2% bromophenol blue, 20% glycerol in 100 mM Tris buffered saline) and boiled for 5 min. The samples were electrophoresed under reducing conditions on a 10% Ready gel (Bio-Rad, Richmond, Calif.) and the proteins electroblotted onto Protran BA85 (Whatman, Florham Park, N.J.). The Immobilon-P sheet was blocked in 5% nonfat dry milk in PBS for 1 h and incubated with the antibody at 4° C. overnight. After repeated washing (five times 5 min), bound antibody was detected with horseradish peroxidase (HRP)-labeled.

##### Results

To detect sH4, sera from individual patients with diagnosis of rheumatoid arthritis based on American Rheumatism Association criteria were analyzed by enzyme-linked immunosorbent assays (ELISA) using two specific monoclonal antibodies (mAb) binding to different epitopes on human B7-H4. In this assay, 65% (44 out of 68) samples from patients with RA and 43% (15/35) from patients with SLE were above background and therefore positive. Evaluation of sH4 in healthy donors (HD) showed only 13% (3/24) were positive (FIG. 1a). sH4 is significantly higher in RA and SLE patients than healthy donors ( $P < 0.05$ ). In addition, the mean concentration of sH4 in RA (96.1 ng/ml) and SLE (36.9 ng/ml) was significantly higher than those of the healthy donors (3.8 ng/ml). The results indicate that sH4 is elevated in a significant portion of RA and SLE patients.

Western blot analysis was used to validate the presence of sH4 in sera from 3 patients with rheumatoid arthritis. Using specific mAb against B7-H4, the sera from 3 RA patients, who have detectable sH4 in ELISA, showed a single 50-kDa band. This matched the size of predicted extracellular domain of human B7-H4. In contrast, no band was observed in sera from three healthy donors. The data support the presence of sH4 in the sera of RA patients.

The association of elevated concentration of sH4 with the severity of RA was investigated. Based on severity of diseases, 68 RA patients were classified into 4 groups (0-3) with most severe diseases in group 3 as described in Methods. The mean concentration of sH4 in group 3 (260.7 ng/ml) was significantly higher than those of group 0 (22.0 ng/ml) or Group 1 (18.8 ng/ml). However, there was no significant difference among group 0-2 by Scheffé test (FIG. 1b). The data thus indicate that RA patients in group 3 have highest level sH4 and suggest that sH4 might play a role in the progression of severe RA.

### Example 2

#### Soluble B7-H4 Exacerbates Collagen-Induced Arthritis in a Mouse Model

##### Mice:

Male DBA/1j mice, MRL-lpr/lpr mice and C57BL/6-lpr/lpr (B6-lpr/lpr) were obtained from the Jackson Laboratory (Bar Harbor, Me.). Age-matched mice, 4-10 weeks old, were used for all experiments. B7-H4KO mice were generated in this laboratory as described above and have been backcrossed

to B6 background for 10 generations. DBA/1jxB7-H4KO mice were generated by backcrossed B7-H4KO mice into DBA/1j backgrounds for 5 generations. B6-lpr/lprxB7-H4KO mice were obtained by backcrossing between B6-lpr/lpr and B7-H4KO mice. All mice were maintained in the Animal Facility at Johns Hopkins Hospital under approval protocol by the Institutional Animal Care and Use Committee.

#### Induction of Collagen-Induced Arthritis:

CIA was induced in 8-10 weeks old male DBA/1j mice by intradermal tail base injection of 0.2 mg chicken collagen (Sigma-Aldrich, St. Louis, Mo.) in 0.05 M acetate acid, supplemented with 4.0 mg/ml *Mycobacterium tuberculosis* (DIFCO, Detroit, Mich.) emulsified in complete Freund adjuvant. Fourteen days after first primary immunization, the mice were identically boosted once. Severity of disease was evaluated by visual inspection of the paws. Each paw was scored for the degree of inflammation on a scale from 0 to 4: 0, no evidence of erythema and swelling; 1, erythema and mild swelling confined to the midfoot (tarsals) or ankle joint; 2, erythema and mild swelling extending from ankle to the midfoot; 3, erythema and mild swelling extending from ankle to metatarsal joints; 4, erythema and severe swelling encompassing the ankle, foot, and digits. Scores from all four paws were added to give the total for each animal.

#### Murine B7-H4 Constructs:

B7-H4Ig construct was prepared as described by Sica, G. L. et al. B7-H4, a molecule of the B7 family, negatively regulates T cell immunity. *Immunity* 18, 849-61 (2003)). To generate B7-H4V and B7-H4VC plasmids, 2 flanking 5' and 3' primers were designed with XhoI and EcoRI restriction sites, respectively (5' primer; 5'-ccgctcgagccaccatggcttcttggggcag-3' (SEQ ID NO:6), 3' primer for B7-H4V; 5'-cggaattccgctaattatctctggcatact-3' (SEQ ID NO:7), 3' primer for B7-H4VC; 5'-cggaattccgctaagagttcagcaactcgag-3' (SEQ ID NO:8)). Appropriate regions of cDNA were amplified using primers. PCR product was digested with XhoI and EcoRI and ligated into XhoI/EcoRI-digested pcDNA3.1 vectors (Invitrogen, Carlsbad, Calif.).

#### Collagen-Specific T Cell Proliferation and Cytokine Production:

The spleen was removed on day 14 after the last immunization. CD4+ T cells were purified by using magnetic beads (Miltenyi Biotec, Auburn, Calif.). Whole splenocytes or purified CD4+ T cells were stimulated with denatured (60° C., 30 min) chicken type II collagen (CII) in 96 well flat bottom microtiter plates for 72 hr, and pulsed with [<sup>3</sup>H] thymidine (1 μCi/well) (Amersham Pharmacia Biotech, Piscataway, N.J.) for the last 12 hr. In the culture of purified CD4+ T cells, irradiated (50Gy) splenocytes from the syngeneic mice were added as antigen-presenting cells. Supernatants from the cultures were collected after 48 hr and assayed for mouse IFN-γ (BD, San Jose, Calif.) and IL-17A (eBioscience) using ELISA kit according to the protocols recommended by manufacturer.

#### Results

To recapitulate and explore possible role of sH4 in the pathogenesis of RA, a mouse model of collagen-induced arthritis (CIA) was used. CIA is a well-characterized mouse model for human arthritis, in which injection of collagen into DBA/1j mice induces swelling and progressive inflammation in large joints and lead to arthritis. To express sH4 in vivo, an expression vector, B7-H4VC, was constructed in which the transmembrane and intracellular domains of mouse B7-H4 cDNA were deleted, and the truncated gene encoding both IgV and IgC domains were placed under the control of CMV immediate early promoter. Another vector, B7-H4V, contain-

ing only IgV domain of B7-H4 was also produced (FIG. 4a). Upon expression, these truncated proteins/polypeptides are expected to compete with endogenous B7-H4 on the cell surface to bind its putative receptor. Parental vector is included as the control. By a hydrodynamic expression procedure known in the art, injection of these plasmids led to expression of sH4 up to 2 μg/ml in the sera, based on specific capture sandwich ELISA using two anti-murine B7-H4 mAb.

In the CIA model, immunization of DBA/1j mice with collagen led to appearance of arthritic symptom starting around 28 days. Control vector-treated mice developed arthritis beginning at day 32 and 80% of mice developed disease on day 60 after first immunization. Injection of B7-H4VC led to earlier development of disease (17 days) and 100% mice developed arthritis around 30 days. Similar results were also seen in the mice injected with B7-H4V (FIG. 4b). Furthermore, treatment by either B7-H4V or B7-H4VC significantly increase severity of arthritis as indicated by increased clinical score (FIG. 4e), increased swelling of footpad and increased infiltration of inflammatory cells in joints as shown in histopathology analysis.

Assessment of cellular and humoral immune responses revealed that increased incidence and severity of arthritis was accompanied with elevated total IgG autoantibodies (FIG. 8d) as well as other subtypes including IgG<sub>1</sub>, IgG<sub>2a</sub> and IgG<sub>2b</sub> to collagen CII at day 30 after immunization and B7-H4VC or B7-H4V treatment (FIG. 12). Stimulation of total spleen cells or purified CD4+ T cells from mice, which were treated with B7-H4VC or B7-H4V, by CII also induced much higher level of proliferation in comparison with mice treated with control vector (FIG. 4e and FIG. 9). Importantly, IFN-γ and IL-17, two major cytokines responsible for CIA progression, also increase significantly in the cultures (FIG. 41). Taken together, the data demonstrate that sH4 enhance autoimmune responses against CII and exacerbate autoimmune CIA.

If B7-H4VC and B7-H4V act as a decoy to block the effect of endogenous B7-H4 on the cell surface, a similar exacerbation effect that should also be observed in B7-H4 deficient mice (B7-H4KO). To test this, B7-H4KO phenotype mice were backcrossed to DBA/1j background for 5 generations. B7-H4KO-DBA/1j mice develop normally and do not have obvious abnormality in gross appearance and development of immune system. These mice, however, developed much more severe CIA, showing higher incidence (FIG. 4g) and clinical score (FIG. 4h) than B7-H4+/+ control mice, results similar to those from B7-H4VC or B7-H4V-treated mice. Therefore, the data support that sH4 functions as a decoy molecule to increase autoimmune responses and exacerbate CIA.

#### Example 3

##### Increased Neutrophils are Responsible for Exacerbation of CIA by sH4

##### Air Pouch Assay for Neutrophils:

The air pouch assay was performed as described by Edwards, J. C. et al., *J Pathol*, 134:147-56 (1981). Briefly, mice were anesthetized with 2, 2, 2-Tribromoethanol (Sigma-Aldrich, St. Louis, Mo.) and subcutaneous dorsal pouches were created by injection of 5 ml of sterile air. After 3 day, pouches were re-injected with 3 ml air. On day 6 after the first injection, 50 μg LPS in 1 ml PBS was injected into the pouches. Five hours later, mice were anesthetized and pouches were lavaged with 3 ml PBS to collect infiltrating cells.

## Results

B7-H4KO mice are resistant to *Listeria* infection due to rapid increase of neutrophils. Further experiments demonstrated that B7-H4 could directly inhibit growth of neutrophil progenitors. Therefore, sH4 may block endogenous B7-H4 and thereby exacerbate CIA via neutrophil-mediated inflammation, a hypothesis which may provide an interpretation for progressive inflammation of RA. Whether or not expression of sH4 increases neutrophils in murine peripheral tissues was explored. Due to difficulty to directly access neutrophil number in RA lesions in mouse, an air pouch assay in which neutrophils could be collected from subcutaneous air pouches upon induction of inflammation were used. As shown in FIG. 5a, mice injected with B7-H4V or B7-H4VC had significantly more neutrophils in each air pouch than that of control vector. Together with previous studies in B7-H4KO mice, the results indicate that sH4 induce a rapid increase of neutrophils in peripheral tissues *in vivo*.

Neutrophils were depleted to investigate whether the effect of sH4 in CIA exacerbation could be eliminated. CIA-mice were treated with B7-H4VC or B7-H4V and subsequently treated with anti-Gr-1 antibody every other day to deplete neutrophils. Enhanced effect of B7-H4V or B7-H4VC in both CIA incidence (FIG. 5b) and clinical score (FIG. 5c) was completely eliminated by anti-Gr-1 antibody treatment. The results thus support that neutrophils are responsible for the effect of sH4 in the progression of CIA.

## Example 4

Soluble B7-H4 Exacerbates SLE-Like Diseases in *lpr* Mice and Enhances Autoimmune Responses

## Urine Protein Excretion:

Urinary protein excretion was determined by dipstick analysis (GERMANE, San Antonio, Tex.). The proteinuria grade was scored from 0 to 4 as follows: grade 0, normal; grade 1, 30 mg/dl; grade 2, 100 mg/dl; grade 3, 300 mg/dl; grade 4, 2000 mg/dl.

## Histological Assessments of Arthritis and Nephritis:

CIA mice were sacrificed at day 35. The hind paws were removed, fixed in Formalin, decalcified in 10% EDTA, embedded in paraffin, sectioned, and stained with H&E. For histological evaluation of renal disease, mice were sacrificed at 6 months of age. Kidneys were either fixed in formalin or snap-frozen in Tissue Tek (Sakura Finetek, Torrance, Calif.) for cryostat sectioning. Formalin-fixed tissue was embedded in paraffin, sectioned, and stained by the periodic acid-Schiff (PAS) method. Frozen sections were fixed in acetone and 1% paraformaldehyde, and stained with FITC-conjugated anti-mouse IgG Ab or C3 Ab (ICN/Cappel, Aurora, Ohio).

A significant fraction of SLE patients also have detectable sH4 in sera. It is possible that sH4 may also play a role in the progression of SLE. To test this, sH4 was investigated to determine whether it could promote autoimmunity in MRL-*lpr/lpr* mice, in which the mice spontaneously develop progressive SLE-like symptoms largely due to the effects of autoantibodies and lymphoproliferation. MRL-*lpr/lpr* mice were treated with the B7-H4VC plasmid and anti-dsDNA autoantibodies in sera were evaluated. As shown in FIG. 6a upon treatment by the B7-H4VC, concentration of anti-dsDNA autoantibodies in sera elevated significantly higher than the mice treated with control plasmid at 10 weeks. Depletion of neutrophils by injection of anti-Gr-1 antibody completely eliminated this effect, a result similar to the observation in the CIA model. This initial study suggests that sH4 also plays a role in promoting autoimmune responses in this SLE model.

To facilitate analysis of the immune responses and the role of sH4 in the pathogenesis of SLE, B7-H4<sup>-/-</sup> phenotype mice were backcrossed to B6-*lpr/lpr* mice, a strain with similar but less aggressive SLE-like symptoms as the MRL-*lpr* strain. As expected, anti-dsDNA IgG autoantibodies were developed much earlier and in much higher titers in B6-*lpr/lpr*×B7-H4KO mice than the control B6-*lpr/lpr* mice (FIG. 6b). Importantly, B6-*lpr/lpr*×B7-H4KO mice rapidly developed severe splenomegaly and lymphadenopathy with significantly increased weight (FIG. 6c) compared with control B6-*lpr/lpr* mice. The spleen and lymph nodes were much larger and cellularity of these organs increased significantly in B6-*lpr/lpr*×B7-H4KO mice than the controls (FIG. 6c). The major cell components, which are increased significantly upon sH4 treatment in these organs, are neutrophils (Gr-1+ CD11b+) and T cells (CD3+ CD8+, CD3+ CD4+ and CD3+ CD4-CD8-B220+). B6-*lpr/lpr*×B7-H4KO mice developed severe glomerulonephritis with interstitial inflammatory cells infiltrates, hypercellular glomerulus and increased mesangial cells. In addition, the mice also developed vasculitis with perivascular cell infiltration, the glomerular deposition of total IgG and C3 as well as increased proteinuria (FIG. 6d) within 30 weeks. In contrast, control B6-*lpr/lpr* mice have normal kidneys without any visible pathology up to 24 months. Taken together, the results demonstrate that sH4 exacerbates SLE-like diseases in *lpr* mice by enhancing antibody and cell-mediated autoimmune responses and pathology.

## Example 5

## Inhibition of CIA Progression by B7-H4Ig

While the data show that sH4 in RA and SLE murine models promotes progression of diseases, these data also support that endogenous B7-H4 is a checkpoint molecule in suppressing autoimmune responses. Therefore, a potential approach to suppress these autoimmune diseases is to increase the expression of B7-H4 in agonist fowl in order to engage its putative receptor. The effect of B7-H4Ig fusion protein in which B7-H4 extracellular domain was fused to murine IgG2a Fc portion was described by Sica, G. L. et al. B7-H4, a molecule of the B7 family, negatively regulates T cell immunity. *Immunity* 18, 849-61 (2003); Chapoval, A. I., Zhu, G. & Chen, L. Immunoglobulin fusion proteins as a tool for evaluation of T-cell costimulatory molecules. *Mol Biotechnol* 21, 259-64 (2002). The Fc portion of B7-H4Ig could bind Fc receptor to facilitate agonist effect *in vivo*. The effect of B7-H4Ig in the progression of CIA was then tested. In comparison with control plasmid, B7-H4Ig plasmid treatment one day before CII challenge significantly decreased arthritis incidence and clinical score, as well as delayed the onset of CIA (FIG. 7a & b). Furthermore, B7-H4Ig plasmid treatment suppressed the production of total IgG (FIG. 7c) and IgG<sub>1</sub>, IgG<sub>2a</sub> and IgG<sub>2b</sub> autoantibodies to CII (FIG. 8). Proliferation of splenocytes and CD4+ T cells (FIG. 7d and FIG. 9) as well as IFN- $\gamma$  and IL-17 production in response to CII were also significantly suppressed upon B7-H4Ig treatment (FIG. 7e). Collectively, the results demonstrate that B7-H4Ig could work as an agonist to suppress both humoral and cellular autoimmunity. In addition, this method should also be effective in suppressing pathogenesis of CIA.

## Example 6

Expression of B7-H4Ig in MRL-*lpr/lpr* Mice Increases Survival

MRL-*lpr/lpr* mice were injected with control mIgG plasmid or B7-H4Ig plasmid at 6, 8, 10 and 12 weeks of age. All

phenotypes were analyzed at 19 weeks of age. Each group contained 5-10 mice and each set of experiments were repeated at least twice. FIG. 10 is a line graph of percent cumulative survival versus age (weeks) in MRL-lpr/lpr mice injected with control mIgG plasmid (□) or B7-H4lg plasmid (■) at 6, 8, 10 and 12 weeks of age. FIG. 10 shows that treatment by B7-H4lg (murine) vector increases survival of MRL-lpr/lpr mice. All phenotypes were analyzed at 19 weeks of age.

FIG. 11 is a line graph of IgG autoantibody titer ( $A_{450nm}$ ) versus age (weeks) in MRL-lpr/lpr mice injected with control mIgG plasmid (□) or B7-H4lg plasmid (■). FIG. 11 shows that treatment by B7-H4lg (murine) vector inhibits autoantibodies (anti-DNA) in MRL-lpr/lpr mice. FIG. 12 is a graph of proteinuria grade in MRL-lpr/lpr mice injected with control mIgG plasmid (□) or B7-H4lg plasmid (□). FIG. 12 shows

that treatment by B7-H4lg (murine) vector inhibits kidney damage in MRL-lpr/lpr mice.

Statistical analysis. Statistical analysis was performed with the Mann-Whitney U test for single comparison and ANOVA followed by the Scheffe test for multiple comparisons. In all statistical analyses, significance was accepted at  $P < 0.05$ .

Unless defined otherwise, all technical and scientific terms used herein have the same meanings as commonly understood by one of skill in the art to which the disclosed invention belongs. Publications cited herein and the materials for which they are cited are specifically incorporated by reference.

Those skilled in the art will recognize, or be able to ascertain using no more than routine experimentation, many equivalents to the specific embodiments of the invention described herein. Such equivalents are intended to be encompassed by the following claims.

## SEQUENCE LISTING

<160> NUMBER OF SEQ ID NOS: 6

<210> SEQ ID NO 1

<211> LENGTH: 222

<212> TYPE: PRT

<213> ORGANISM: Homo sapiens

<400> SEQUENCE: 1

Gly Phe Gly Ile Ser Gly Arg His Ser Ile Thr Val Thr Thr Val Ala  
1 5 10 15

Ser Ala Gly Asn Ile Gly Glu Asp Gly Ile Gln Ser Cys Thr Phe Glu  
20 25 30

Pro Asp Ile Lys Leu Ser Asp Ile Val Ile Gln Trp Leu Lys Glu Gly  
35 40 45

Val Leu Gly Leu Val His Glu Phe Lys Glu Gly Lys Asp Glu Leu Ser  
50 55 60

Glu Gln Asp Glu Met Phe Arg Gly Arg Thr Ala Val Phe Ala Asp Gln  
65 70 75 80

Val Ile Val Gly Asn Ala Ser Leu Arg Leu Lys Asn Val Gln Leu Thr  
85 90 95

Asp Ala Gly Thr Tyr Lys Cys Tyr Ile Ile Thr Ser Lys Gly Lys Gly  
100 105 110

Asn Ala Asn Leu Glu Tyr Lys Thr Gly Ala Phe Ser Met Pro Glu Val  
115 120 125

Asn Val Asp Tyr Asn Ala Ser Ser Glu Thr Leu Arg Cys Glu Ala Pro  
130 135 140

Arg Trp Phe Pro Gln Pro Thr Val Val Trp Ala Ser Gln Val Asp Gln  
145 150 155 160

Gly Ala Asn Phe Ser Glu Val Ser Asn Thr Ser Phe Glu Leu Asn Ser  
165 170 175

Glu Asn Val Thr Met Lys Val Val Ser Val Leu Tyr Asn Val Thr Ile  
180 185 190

Asn Asn Thr Tyr Ser Cys Met Ile Glu Asn Asp Ile Ala Lys Ala Thr  
195 200 205

Gly Asp Ile Lys Val Thr Glu Ser Glu Ile Lys Arg Arg Ser  
210 215 220

<210> SEQ ID NO 2

<211> LENGTH: 222

<212> TYPE: PRT

<213> ORGANISM: Homo sapiens

-continued

&lt;400&gt; SEQUENCE: 2

Gly Phe Gly Ile Ser Gly Arg His Ser Ile Thr Val Thr Thr Val Ala  
 1 5 10 15  
 Ser Ala Gly Asn Ile Gly Glu Asp Gly Ile Leu Ser Cys Thr Phe Glu  
 20 25 30  
 Pro Asp Ile Lys Leu Ser Asp Ile Val Ile Gln Trp Leu Lys Glu Gly  
 35 40 45  
 Val Leu Gly Leu Val His Glu Phe Lys Glu Gly Lys Asp Glu Leu Ser  
 50 55 60  
 Glu Gln Asp Glu Met Phe Arg Gly Arg Thr Ala Val Phe Ala Asp Gln  
 65 70 75 80  
 Val Ile Val Gly Asn Ala Ser Leu Arg Leu Lys Asn Val Gln Leu Thr  
 85 90 95  
 Asp Ala Gly Thr Tyr Lys Cys Tyr Ile Ile Thr Ser Lys Gly Lys Gly  
 100 105 110  
 Asn Ala Asn Leu Glu Tyr Lys Thr Gly Ala Phe Ser Met Pro Glu Val  
 115 120 125  
 Asn Val Asp Tyr Asn Ala Ser Ser Glu Thr Leu Arg Cys Glu Ala Pro  
 130 135 140  
 Arg Trp Phe Pro Gln Pro Thr Val Val Trp Ala Ser Gln Val Asp Gln  
 145 150 155 160  
 Gly Ala Asn Phe Ser Glu Val Ser Asn Thr Ser Phe Glu Leu Asn Ser  
 165 170 175  
 Glu Asn Val Thr Met Lys Val Val Ser Val Leu Tyr Asn Val Thr Ile  
 180 185 190  
 Asn Asn Thr Tyr Ser Cys Met Ile Glu Asn Asp Ile Ala Lys Ala Thr  
 195 200 205  
 Gly Asp Ile Lys Val Thr Glu Ser Glu Ile Lys Arg Arg Ser  
 210 215 220

&lt;210&gt; SEQ ID NO 3

&lt;211&gt; LENGTH: 129

&lt;212&gt; TYPE: PRT

&lt;213&gt; ORGANISM: Homo sapiens

&lt;400&gt; SEQUENCE: 3

Gly Phe Gly Ile Ser Gly Arg His Ser Ile Thr Val Thr Thr Val Ala  
 1 5 10 15  
 Ser Ala Gly Asn Ile Gly Glu Asp Gly Ile Gln Ser Cys Thr Phe Glu  
 20 25 30  
 Pro Asp Ile Lys Leu Ser Asp Ile Val Ile Gln Trp Leu Lys Glu Gly  
 35 40 45  
 Val Leu Gly Leu Val His Glu Phe Lys Glu Gly Lys Asp Glu Leu Ser  
 50 55 60  
 Glu Gln Asp Glu Met Phe Arg Gly Arg Thr Ala Val Phe Ala Asp Gln  
 65 70 75 80  
 Val Ile Val Gly Asn Ala Ser Leu Arg Leu Lys Asn Val Gln Leu Thr  
 85 90 95  
 Asp Ala Gly Thr Tyr Lys Cys Tyr Ile Ile Thr Ser Lys Gly Lys Gly  
 100 105 110  
 Asn Ala Asn Leu Glu Tyr Lys Thr Gly Ala Phe Ser Met Pro Glu Val  
 115 120 125

Asn

-continued

---

```

<210> SEQ ID NO 4
<211> LENGTH: 129
<212> TYPE: PRT
<213> ORGANISM: Homo sapiens

<400> SEQUENCE: 4
Gly Phe Gly Ile Ser Gly Arg His Ser Ile Thr Val Thr Thr Val Ala
1          5          10          15
Ser Ala Gly Asn Ile Gly Glu Asp Gly Ile Leu Ser Cys Thr Phe Glu
20          25          30
Pro Asp Ile Lys Leu Ser Asp Ile Val Ile Gln Trp Leu Lys Glu Gly
35          40          45
Val Leu Gly Leu Val His Glu Phe Lys Glu Gly Lys Asp Glu Leu Ser
50          55          60
Glu Gln Asp Glu Met Phe Arg Gly Arg Thr Ala Val Phe Ala Asp Gln
65          70          75          80
Val Ile Val Gly Asn Ala Ser Leu Arg Leu Lys Asn Val Gln Leu Thr
85          90          95
Asp Ala Gly Thr Tyr Lys Cys Tyr Ile Ile Thr Ser Lys Gly Lys Gly
100         105         110
Asn Ala Asn Leu Glu Tyr Lys Thr Gly Ala Phe Ser Met Pro Glu Val
115         120         125

Asn

```

```

<210> SEQ ID NO 5
<211> LENGTH: 255
<212> TYPE: PRT
<213> ORGANISM: Homo sapiens

<400> SEQUENCE: 5
Gly Phe Gly Ile Ser Gly Arg His Ser Ile Thr Val Thr Thr Val Ala
1          5          10          15
Ser Ala Gly Asn Ile Gly Glu Asp Gly Ile Leu Ser Cys Thr Phe Glu
20          25          30
Pro Asp Ile Lys Leu Ser Asp Ile Val Ile Gln Trp Leu Lys Glu Gly
35          40          45
Val Leu Gly Leu Val His Glu Phe Lys Glu Gly Lys Asp Glu Leu Ser
50          55          60
Glu Gln Asp Glu Met Phe Arg Gly Arg Thr Ala Val Phe Ala Asp Gln
65          70          75          80
Val Ile Val Gly Asn Ala Ser Leu Arg Leu Lys Asn Val Gln Leu Thr
85          90          95
Asp Ala Gly Thr Tyr Lys Cys Tyr Ile Ile Thr Ser Lys Gly Lys Gly
100         105         110
Asn Ala Asn Leu Glu Tyr Lys Thr Gly Ala Phe Ser Met Pro Glu Val
115         120         125
Asn Val Asp Tyr Asn Ala Ser Ser Glu Thr Leu Arg Cys Glu Ala Pro
130         135         140
Arg Trp Phe Pro Gln Pro Thr Val Val Trp Ala Ser Gln Val Asp Gln
145         150         155         160
Gly Ala Asn Phe Ser Glu Val Ser Asn Thr Ser Phe Glu Leu Asn Ser
165         170         175
Glu Asn Val Thr Met Lys Val Val Ser Val Leu Tyr Asn Val Thr Ile
180         185         190
Asn Asn Thr Tyr Ser Cys Met Ile Glu Asn Asp Ile Ala Lys Ala Thr
195         200         205

```

-continued

---

Gly Asp Ile Lys Val Thr Glu Ser Glu Ile Lys Arg Arg Ser His Leu  
 210 215 220

Gln Leu Leu Asn Ser Lys Ala Ser Leu Cys Val Ser Ser Phe Phe Ala  
 225 230 235 240

Ile Ser Trp Ala Leu Leu Pro Leu Ser Pro Tyr Leu Met Leu Lys  
 245 250 255

<210> SEQ ID NO 6  
 <211> LENGTH: 255  
 <212> TYPE: PRT  
 <213> ORGANISM: Homo sapiens

<400> SEQUENCE: 6

Gly Phe Gly Ile Ser Gly Arg His Ser Ile Thr Val Thr Thr Val Ala  
 1 5 10 15

Ser Ala Gly Asn Ile Gly Glu Asp Gly Ile Gln Ser Cys Thr Phe Glu  
 20 25 30

Pro Asp Ile Lys Leu Ser Asp Ile Val Ile Gln Trp Leu Lys Glu Gly  
 35 40 45

Val Leu Gly Leu Val His Glu Phe Lys Glu Gly Lys Asp Glu Leu Ser  
 50 55 60

Glu Gln Asp Glu Met Phe Arg Gly Arg Thr Ala Val Phe Ala Asp Gln  
 65 70 75 80

Val Ile Val Gly Asn Ala Ser Leu Arg Leu Lys Asn Val Gln Leu Thr  
 85 90 95

Asp Ala Gly Thr Tyr Lys Cys Tyr Ile Ile Thr Ser Lys Gly Lys Gly  
 100 105 110

Asn Ala Asn Leu Glu Tyr Lys Thr Gly Ala Phe Ser Met Pro Glu Val  
 115 120 125

Asn Val Asp Tyr Asn Ala Ser Ser Glu Thr Leu Arg Cys Glu Ala Pro  
 130 135 140

Arg Trp Phe Pro Gln Pro Thr Val Val Trp Ala Ser Gln Val Asp Gln  
 145 150 155 160

Gly Ala Asn Phe Ser Glu Val Ser Asn Thr Ser Phe Glu Leu Asn Ser  
 165 170 175

Glu Asn Val Thr Met Lys Val Val Ser Val Leu Tyr Asn Val Thr Ile  
 180 185 190

Asn Asn Thr Tyr Ser Cys Met Ile Glu Asn Asp Ile Ala Lys Ala Thr  
 195 200 205

Gly Asp Ile Lys Val Thr Glu Ser Glu Ile Lys Arg Arg Ser His Leu  
 210 215 220

Gln Leu Leu Asn Ser Lys Ala Ser Leu Cys Val Ser Ser Phe Phe Ala  
 225 230 235 240

Ile Ser Trp Ala Leu Leu Pro Leu Ser Pro Tyr Leu Met Leu Lys  
 245 250 255

---

55

I claim:

1. A method for determining the severity of an inflammatory disorder in a subject having or suspected of having an inflammatory disorder comprising

- (a) determining the level of soluble B7-H4 in a biological sample from a subject; and
- (b) comparing the level of soluble B7-H4 in the biological sample to reference levels of soluble B7-H4 that correlate with disease severity of an inflammatory disorder to determine the severity of the inflammatory disorder of the subject.

60

2. The method of claim 1 wherein the inflammatory disorder is selected from the group consisting of rheumatoid arthritis, systemic lupus erythematosus, alopecia areata, ankylosing spondylitis, antiphospholipid syndrome, autoimmune Addison's disease, autoimmune hemolytic anemia, autoimmune hepatitis, autoimmune inner ear disease, autoimmune lymphoproliferative syndrome (alps), autoimmune thrombocytopenic purpura (ATP), Behcet's disease, bullous pemphigoid, cardiomyopathy, celiac sprue-dermatitis, chronic fatigue syndrome immune deficiency, syndrome (CFIDS), chronic inflammatory demyelinating polyneuropathy, cicatricial pemphigoid, cold agglutinin disease, Crest syndrome,

65

Crohn's disease, Deigo's disease, dermatomyositis, dermatomyositis—juvenile, discoid lupus, essential mixed cryoglobulinemia, fibromyalgia—fibromyositis, grave's disease, guillain-barre, hashimoto's thyroiditis, idiopathic pulmonary fibrosis, idiopathic thrombocytopenia purpura (ITP), Iga nephropathy, insulin dependent diabetes (Type I), juvenile arthritis, Meniere's disease, mixed connective tissue disease, multiple sclerosis, myasthenia gravis, pemphigus vulgaris, pernicious anemia, polyarteritis nodosa, polychondritis, polyglanular syndromes, polymyalgia rheumatica, polymyositis and dermatomyositis, primary agammaglobulinemia, primary biliary cirrhosis, psoriasis, Raynaud's phenomenon, Reiter's syndrome, rheumatic fever, sarcoidosis, scleroderma, Sjogren's syndrome, stiff-man syndrome, Takayasu arteritis, temporal arteritis/giant cell arteritis, ulcerative colitis, uveitis, vasculitis, vitiligo, and Wegener's granulomatosis.

3. The method of claim 1 wherein the soluble B7-H4 levels are determined from a fluid sample obtained from the subject.

4. The method of claim 3 wherein the fluid sample is selected from the group consisting of blood, plasma, saliva, lymph, cerebrospinal fluid, synovial fluid, urine, and sputum.

5. The method of claim 1 wherein levels of soluble B7-H4 are determined using mass spectroscopy, immunohistological methods, immunoprecipitation, an enzyme immunoassay, and a radioimmunoassay.

6. A method for assisting in the diagnosis of an inflammatory disorder or assessing the propensity for developing an inflammatory disorder in a subject comprising

determining the level of soluble B7-H4 in a biological sample from a subject, wherein an elevated level of soluble B7-H4 in the biological sample relative to the level of soluble B7-H4 in a control is indicative of an inflammatory disorder or an increased propensity for developing an inflammatory disorder.

7. The method of claim 6 wherein the biological sample is selected from the group consisting of blood, plasma, saliva, lymph, cerebrospinal fluid, synovial fluid, urine, and sputum.

8. The method of claim 6 wherein levels of soluble B7-H4 are determined using mass spectroscopy, immunohistological methods, immunoprecipitation, an enzyme immunoassay, and a radioimmunoassay.

9. A method for determining the efficacy of a treatment for an inflammatory disorder in a subject comprising

determining the level of soluble B7-H4 from one or more biological samples obtained from the subject before or during the course of the treatment, wherein a decrease in the level of soluble B7-H4 in samples obtained from the subject over time is indicative that the treatment is efficacious.

10. The method of claim 6 wherein the biological sample is selected from the group consisting of blood, plasma, saliva, lymph, cerebrospinal fluid, synovial fluid, urine, and sputum.

11. The method of claim 6 wherein levels of soluble B7-H4 are determined using mass spectroscopy, immunohistological methods, immunoprecipitation, an enzyme immunoassay, and a radioimmunoassay.

12. A method for determining neutrophil levels of a subject comprising

(a) determining the level of soluble B7-H4 in a biological sample obtained from the subject;

(b) comparing the level of soluble B7-H4 in the biological sample to reference levels of soluble B7-H4 wherein the reference levels correlate with levels of neutrophils; and

(c) selecting the level of neutrophils that matches the level of soluble B7-H4 in the biological sample.

13. The method of claim 12 wherein elevated levels of soluble B7-H4 relative to a control are indicative of elevated levels of neutrophils relative to a control.

14. A method for selecting a subject for treatment of an inflammatory disorder comprising

(a) determining the level of soluble B7-H4 in a biological sample obtained from the subject;

(b) comparing the level of soluble B7-H4 in the biological sample to the level of soluble B7-H4 in a control;

and

(c) selecting the subject for treatment when the level of soluble B7-H4 in the biological sample is higher than the level of soluble B7-H4 in the control.

15. The method of claim 14 wherein the inflammatory disorder is selected from the group consisting of rheumatoid arthritis, systemic lupus erythematosus, alopecia areata, ankylosing spondylitis, antiphospholipid syndrome, autoimmune Addison's disease, autoimmune hemolytic anemia, autoimmune hepatitis, autoimmune inner ear disease, autoimmune lymphoproliferative syndrome (alps), autoimmune thrombocytopenic purpura (ATP), Behcet's disease, bullous pemphigoid, cardiomyopathy, celiac sprue-dermatitis, chronic fatigue syndrome immune deficiency, syndrome (CFIDS), chronic inflammatory demyelinating polyneuropathy, cicatricial pemphigoid, cold agglutinin disease, Crest syndrome, Crohn's disease, Deigo's disease, dermatomyositis, dermatomyositis—juvenile, discoid lupus, essential mixed cryoglobulinemia, fibromyalgia—fibromyositis, grave's disease, guillain-barre, hashimoto's thyroiditis, idiopathic pulmonary fibrosis, idiopathic thrombocytopenia purpura (ITP), Iga nephropathy, insulin dependent diabetes (Type I), juvenile arthritis, Meniere's disease, mixed connective tissue disease, multiple sclerosis, myasthenia gravis, pemphigus vulgaris, pernicious anemia, polyarteritis nodosa, polychondritis, polyglanular syndromes, polymyalgia rheumatica, polymyositis and dermatomyositis, primary agammaglobulinemia, primary biliary cirrhosis, psoriasis, Raynaud's phenomenon, Reiter's syndrome, rheumatic fever, sarcoidosis, scleroderma, Sjogren's syndrome, stiff-man syndrome, Takayasu arteritis, temporal arteritis/giant cell arteritis, ulcerative colitis, uveitis, vasculitis, vitiligo, and Wegener's granulomatosis.

16. The method of claim 14 wherein the biological sample is a fluid sample.

17. The method of claim 16 wherein the fluid sample is selected from the group consisting of blood, plasma, saliva, lymph, cerebrospinal fluid, synovial fluid, urine, and sputum.

18. The method of claim 14 wherein the level of soluble B7-H4 in the biological sample is determined using a method selected from the group consisting of mass spectroscopy, immunohistological methods, immunoprecipitation, enzyme immunoassays, or a radioimmunoassay.

19. The method of claim 3 wherein the fluid is serum and the inflammatory disorder is rheumatoid arthritis or systemic lupus erythematosus.

20. The method of claim 19 wherein the inflammatory disease is rheumatoid arthritis and wherein a serum reference level of less than about 100 ng/ml is indicative of less than 4 active joints and a reference level of greater than about 100 ng/ml is indicative of 5 or more active joints.

21. The method of claim 6 wherein the control is the level of soluble B7-H4 in a biological sample from a subject without an inflammatory disorder.

22. The method of claim 21 wherein the control is pooled or averaged from more than one subject without an inflammatory disorder.

43

23. The method of claim 6 wherein the biological sample is serum and the inflammatory disorder is rheumatoid arthritis or systemic lupus erythematosus.

24. The method of claim 9 wherein the biological sample is serum and the inflammatory disorder is rheumatoid arthritis or systemic lupus erythematosus.

25. The method of claim 13 wherein the control is the level of soluble B7-H4 in a biological sample from a subject without an inflammatory disorder.

26. The method of claim 25 wherein the control is pooled or averaged from more than one subject without an inflammatory disorder.

27. The method of claim 14 wherein the control is level of soluble B7-H4 in a biological sample from a subject without an inflammatory disorder.

28. The method of claim 27 wherein the control is pooled or averaged from more than one subject without an inflammatory disorder.

29. The method of claim 16 wherein the fluid is serum and the inflammatory disease is rheumatoid arthritis or systemic lupus erythematosus.

30. A method for determining the efficacy of a treatment for an inflammatory disorder in a subject comprising determining the levels of soluble B7-H4 in a first biological sample and a second biological sample taken after the first sample, wherein the samples are obtained from the subject over the course of the treatment, and wherein a decrease in the level of soluble B7-H4 in the second sample compared to the first sample is indicative that the treatment is efficacious.

44

31. The method of claim 30 wherein the biological samples are selected from the group consisting of blood, plasma, saliva, lymph, cerebrospinal fluid, synovial fluid, urine, and sputum.

32. The method of claim 30 wherein levels of soluble B7-H4 are determined using mass spectroscopy, immunohistological methods, immunoprecipitation, an enzyme immunoassay, and a radioimmunoassay.

33. The method of claim 30 wherein the biological samples are serum and the inflammatory disorder is rheumatoid arthritis or systemic lupus erythematosus.

34. A method for assisting in the diagnosis of an inflammatory disorder or assessing the propensity for developing an inflammatory disorder in a subject comprising determining the levels of soluble B7-H4 in a first biological sample and a second biological sample taken after the first sample, wherein an increase in the level of soluble B7-H4 in the second sample compared to the first sample is indicative of development or worsening of an autoimmune disease.

35. A method for selecting a subject for treatment of an inflammatory disorder comprising determining the levels of soluble B7-H4 in a first biological sample and a second biological sample taken after the first sample, and selecting the subject for treatment when the level of soluble B7-H4 in the second biological sample is higher than the level of soluble B7-H4 in the first sample.

36. The method of claim 35 wherein the treatment comprises administering to the subject an effective amount of an antagonist of soluble B7-H4 or an agonist of B7-H4.

\* \* \* \* \*

UNITED STATES PATENT AND TRADEMARK OFFICE  
**CERTIFICATE OF CORRECTION**

PATENT NO. : 7,989,173 B2  
APPLICATION NO. : 12/198014  
DATED : August 2, 2011  
INVENTOR(S) : Lieping Chen

Page 1 of 1

It is certified that error appears in the above-identified patent and that said Letters Patent is hereby corrected as shown below:

- Claim 2, column 40, line 62, replace “(alps)” with --(ALPS)--.
- Claim 2, column 40, line 65, replace “deficiency, syndrome” with --deficiency syndrome--.
- Claim 2, column 41, line 3, replace “grave’s disease” with --Graves’ disease--.
- Claim 2, column 41, line 4, replace “guillain-barre” with --Guillain-barre--.
- Claim 2, column 41, line 4, replace “hashimoto’s thyroiditis” with --Hashimoto’s thyroiditis--.
- Claim 15, column 42, line 21, replace “(alps)” with --(ALPS)--.
- Claim 15, column 42, line 24, replace “deficiency, syndrome” with --deficiency syndrome--.
- Claim 15, column 42, line 29, replace “grave’s disease” with --Graves’ disease--.
- Claim 15, column 42, line 30, replace “guillain-barre” with --Guillain-barre--.
- Claim 15, column 42, line 30, replace “hashimoto’s thyroiditis” with --Hashimoto’s thyroiditis--.
- Claim 27, column 43, line 13, replace “the control is level” with --the control is the level--.

Signed and Sealed this  
Twenty-first Day of February, 2012

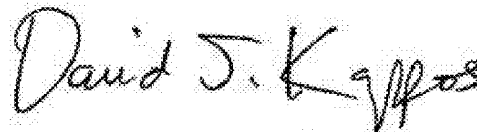

David J. Kappos  
*Director of the United States Patent and Trademark Office*

专利名称(译)	检测和诊断炎症性疾病		
公开(公告)号	<a href="#">US7989173</a>	公开(公告)日	2011-08-02
申请号	US12/198014	申请日	2008-08-25
[标]申请(专利权)人(译)	约翰霍普金斯大学		
申请(专利权)人(译)	约翰斯·霍普金斯大学		
当前申请(专利权)人(译)	约翰·霍普金斯大学		
[标]发明人	CHEN LIEPING		
发明人	CHEN, LIEPING		
IPC分类号	G01N33/53		
CPC分类号	G01N33/6875 G01N2800/10 A61P19/02 A61P25/00 A61P27/16 A61P29/00		
优先权	60/877319 2006-12-27 US 60/949742 2007-07-13 US		
其他公开文献	US20090011444A1		
外部链接	<a href="#">Espacenet</a> <a href="#">USPTO</a>		

摘要(译)

已发现可溶性H4 ( sH4 ) 水平与包括自身免疫疾病在内的炎性疾病的阶段或严重程度相关。特别地，sH4的循环水平可以用作诊断用于确定炎性病证的严重性或发展炎性病证的倾向。炎性病证的严重程度可以通过测定受试者中sH4的水平并比较sH4与参考sH4浓度的水平来确定，所述参考sH4浓度与炎性病证的特定阶段相关。治疗炎性疾病的治疗功效也可以通过比较治疗前和治疗期间的sH4水平来确定。还提供了用于测量sH4的方法和装置。

FIG. 1a

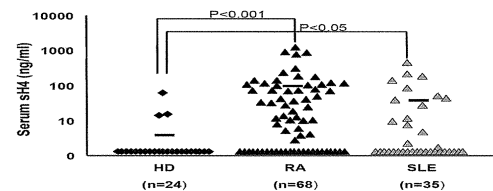

FIG. 1b

