



INTERNATIONAL APPLICATION PUBLISHED UNDER THE PATENT COOPERATION TREATY (PCT)

(51) International Patent Classification ⁷ : A61K 9/127, 9/133	A1	(11) International Publication Number: WO 00/69412 (43) International Publication Date: 23 November 2000 (23.11.00)
(21) International Application Number: PCT/US00/12962 (22) International Filing Date: 12 May 2000 (12.05.00) (30) Priority Data: 60/134,140 14 May 1999 (14.05.99) US (71) Applicant (for all designated States except US): TALARIA THERAPEUTICS, INC. [US/US]; Suite 1350, 1 Tower Bridge, 100 Front Street, West Conshohocken, PA 19428 (US). (72) Inventors; and (75) Inventors/Applicants (for US only): GOLDBERG, Dennis, I. [US/US]; 109 Bent Road, Sudbury, MA 01776 (US). WILLIAMS, Kevin, Jon [US/US]; 425 Wister Road, Wyn- newood, PA 19096 (US). (74) Agent: ZIARNO, Witold, A.; Michael Best and Friedrich LLP, 100 East Wisconsin Avenue, Milwaukee, WI 53202-4108 (US).		(81) Designated States: AE, AL, AM, AT, AU, AZ, BA, BB, BG, BR, BY, CA, CH, CN, CR, CU, CZ, DE, DK, DM, EE, ES, FI, GB, GD, GE, GH, GM, HR, HU, ID, IL, IN, IS, JP, KE, KG, KP, KR, KZ, LC, LK, LR, LS, LT, LU, LV, MA, MD, MG, MK, MN, MW, MX, NO, NZ, PL, PT, RO, RU, SD, SE, SG, SI, SK, SL, TJ, TM, TR, TT, TZ, UA, UG, US, UZ, VN, YU, ZA, ZW, ARIPO patent (GH, GM, KE, LS, MW, SD, SL, SZ, TZ, UG, ZW), Eurasian patent (AM, AZ, BY, KG, KZ, MD, RU, TJ, TM), European patent (AT, BE, CH, CY, DE, DK, ES, FI, FR, GB, GR, IE, IT, LU, MC, NL, PT, SE), OAPI patent (BF, BJ, CF, CG, CI, CM, GA, GN, GW, ML, MR, NE, SN, TD, TG). Published <i>With international search report.</i>
(54) Title: METHOD OF TREATING ANGINA AND/OR ANGINAL EQUIVALENTS, AND PHARMACEUTICAL COMPOSITIONS AND KIT RELATED THERETO		
(57) Abstract <p>The present invention provides a method of treating angina, e.g. stable angina, unstable angina and variant angina, and/or an anginal equivalent comprising administering a therapeutically effective amount of a multiplicity of liposomes, and preferably, large liposomes comprised of phospholipids substantially free of sterol to a subject for a treatment period. The method also includes administering an effective amount of an anti-anginal drug other than the liposomes. The invention also provides a method of treating claudication comprising administering a therapeutically effective amount of liposomes. In yet another variant, the invention provides a method of perioperative and/or pre-operative conditioning of a subject comprising administering liposomes. Several other inventions are also described herein.</p>		

FOR THE PURPOSES OF INFORMATION ONLY

Codes used to identify States party to the PCT on the front pages of pamphlets publishing international applications under the PCT.

AL	Albania	ES	Spain	LS	Lesotho	SI	Slovenia
AM	Armenia	FI	Finland	LT	Lithuania	SK	Slovakia
AT	Austria	FR	France	LU	Luxembourg	SN	Senegal
AU	Australia	GA	Gabon	LV	Latvia	SZ	Swaziland
AZ	Azerbaijan	GB	United Kingdom	MC	Monaco	TD	Chad
BA	Bosnia and Herzegovina	GE	Georgia	MD	Republic of Moldova	TG	Togo
BB	Barbados	GH	Ghana	MG	Madagascar	TJ	Tajikistan
BE	Belgium	GN	Guinea	MK	The former Yugoslav Republic of Macedonia	TM	Turkmenistan
BF	Burkina Faso	GR	Greece	ML	Mali	TR	Turkey
BG	Bulgaria	HU	Hungary	MN	Mongolia	TT	Trinidad and Tobago
BJ	Benin	IE	Ireland	MR	Mauritania	UA	Ukraine
BR	Brazil	IL	Israel	MW	Malawi	UG	Uganda
BY	Belarus	IS	Iceland	MX	Mexico	US	United States of America
CA	Canada	IT	Italy	NE	Niger	UZ	Uzbekistan
CF	Central African Republic	JP	Japan	NL	Netherlands	VN	Viet Nam
CG	Congo	KE	Kenya	NO	Norway	YU	Yugoslavia
CH	Switzerland	KG	Kyrgyzstan	NZ	New Zealand	ZW	Zimbabwe
CI	Côte d'Ivoire	KP	Democratic People's Republic of Korea	PL	Poland		
CM	Cameroon	KR	Republic of Korea	PT	Portugal		
CN	China	KZ	Kazakstan	RO	Romania		
CU	Cuba	LC	Saint Lucia	RU	Russian Federation		
CZ	Czech Republic	LI	Liechtenstein	SD	Sudan		
DE	Germany	LK	Sri Lanka	SE	Sweden		
DK	Denmark	LR	Liberia	SG	Singapore		
EE	Estonia						

***METHOD OF TREATING ANGINA AND/OR ANGINAL EQUIVALENTS, AND
PHARMACEUTICAL COMPOSITIONS AND KIT RELATED THERETO***

Patent Application

TO ALL WHOM IT MAY CONCERN:

Be it known that we, Dennis I. Goldberg, a citizen of the United States, residing at 109 Bent Road, Sudbury, Massachusetts 01776, and Kevin Jon Williams, a citizen of the United States, residing at 425 Wister Road, Wynnewood, Pennsylvania 19096, have invented a new and useful ***“METHOD OF TREATING ANGINA AND/OR ANGINAL EQUIVALENTS, AND PHARMACEUTICAL COMPOSITIONS AND KIT RELATED THERETO”*** of which the following is a specification.

*METHOD OF TREATING ANGINA AND/OR ANGINAL EQUIVALENTS, AND
PHARMACEUTICAL COMPOSITIONS AND KIT RELATED THERETO*

BACKGROUND OF THE INVENTION

Chest pain can result from many causes, e.g. gastric discomfort, pulmonary distress, pulmonary embolism, musculoskeletal pain, pneumothorax, cardiac non-coronary conditions, and ischemic coronary syndromes. Ischemic coronary syndromes include stable angina, unstable angina, variant angina, anginal equivalents, myocardial infarction, and related functional impairments, such as arrhythmias, low cardiac output, heart failure, infarct extension, infarct expansion, reperfusion injury, and coronary thrombosis.

Stable angina is angina that recurs in a regular and characteristic pattern. A person recognizes that he/she is having angina only after several episodes have occurred, and a pattern has evolved. There is a certain level of activity or stress that provokes the angina and the pattern generally changes slowly.

Unstable angina is angina that appears as a very severe episode or as frequently recurring bouts of angina. In unstable angina, an established pattern of angina may change sharply. That is, the angina may appear at rest or may be provoked by far less exercise than in the past.

Variant angina pectoris is also known as Prinzmetal's angina. It differs from typical angina in that it occurs almost exclusively when a person is at rest. Attacks can be very painful and usually occur between midnight and 8 a.m. Variant angina pectoris, like other forms of angina and anginal equivalents, can be associated with acute myocardial infarction,

severe cardiac arrhythmias, including ventricular tachycardia, fibrillation, and even sudden death. Variant angina is due to coronary artery spasms, which can occur in close proximity to an atherosclerotic obstruction. Many of the people with angina go through an acute active phase. Anginal and cardiac events may occur frequently for six months or more.

Angina pectoris is defined as chest pain or discomfort of cardiac origin that usually results from a temporary imbalance between myocardial oxygen supply and myocardial oxygen demand. The discomfort is often induced by exercise, emotion, eating, or cold weather. Pain is more likely to occur when the subject is outdoors, especially when the temperature is extremely high or low and when the patient is walking uphill against the wind. Angina commonly occurs when a subject has eaten a heavy meal or when the subject is excited, angry or tense.

The normal coronary circulation is dominated and controlled by the myocardial requirements for oxygen. This need is met by the heart's ability to vary coronary vascular resistance (and therefore blood flow) considerably while the myocardium extracts a high and relatively fixed percentage of oxygen (*Harrison's Principles of Internal Medicine*, 12th edition, 1991, Chap. 16). Normally, intramyocardial resistance arterioles demonstrate an immense capacity for dilation. With exercise and emotional stress, the changing oxygen needs affect coronary vascular resistance and in this manner regulate the supply of blood and oxygen (metabolic regulation). These same vessels adapt to physiologic alterations in blood pressure in order to maintain coronary blood flow at levels appropriate to myocardial needs (autoregulation). Although the large epicardial coronary arteries are capable of constriction and relaxation, in healthy persons they serve as conduits and are referred to as

“conductance vessels,” while the intramyocardial arterioles normally exhibit striking changes in tone and are therefore referred to as “resistance vessels.” *Id.*

Once severe stenosis of a proximal epicardial artery has reduced the cross-sectional area by more than approximately 70 percent, the distal resistance vessels will dilate to reduce vascular resistance and maintain coronary blood flow. A pressure gradient develops across the proximal stenosis, and poststenotic pressure falls. When the resistance vessels are maximally dilated, myocardial blood flow becomes dependent on the pressure in the coronary artery distal to the obstruction. In these circumstances, alterations in myocardial oxygenation can be caused by changes in myocardial oxygen demand and changes in the caliber of the stenosed coronary artery due to physiologic baso-motion, pathologic spasm, or small platelet plugs. All these transient events can upset the critical balance between oxygen supply and demand and thus presipitate myocardial ischemia.

The effects of ischemia are many. The inadequate oxygenation induced by coronary atherosclerosis may cause transient disturbances of the mechanical, biochemical, and electrical function of the myocardium. The abrupt development of ischemia usually affects a segment of left ventricular myocardium with almost instantaneous failure of normal muscle relaxation and contraction. The relatively poor perfusion of the subendocardium causes more intense ischemia of this portion of the wall. Ischemia of large segments of the ventricle will cause transient left ventricular failure, and if the papillary muscles are involved, mitral regurgitation can complicate this event. When ischemic events are transient, they may be associated with angina pectoris; if prolonged, they can lead to

myocardial necrosis and scarring with or without the clinical picture of acute myocardial infarction. See, *Harrison's Principles of Internal Medicine*, 12th edition, 1991 Chap. 189.

Underlying these mechanical disturbances are a wide range of abnormalities in cell metabolism, function, and structure. When oxygenated, the normal myocardium metabolizes fatty acids and glucose to carbon dioxide and water. With severe oxygen deprivation, fatty acids cannot be oxidized, and glucose is broken down to lactate; intracellular pH is reduced as are the myocardial stores of high-energy phosphates, adenosine triphosphate (ATP), and creatine phosphate. Impaired cell membrane function leads to potassium leakage and the uptake of sodium by myocytes. The severity and duration of the imbalance between myocardial oxygen supply and demand will determine whether the damage is reversible or whether it is permanent, with subsequent myocardial necrosis. *Harrison's Principles of Internal Medicine*, 12th edition, 1991.

Ischemia also causes characteristic electrocardiographic changes such as repolarization abnormalities, as evidenced by inversion of the T wave and later by displacement of the ST segment (*Harrison's Principles of Internal Medicine*, 12th edition, 1991, Chap. 176). Transient ST-segment depression often reflects subendocardial ischemia, while transient ST-segment elevation is thought to be caused by more severe transmural ischemia. Another important consequence of myocardial ischemia is electrical instability, since this may lead to ventricular tachycardia or ventricular fibrillation (*Harrison's Principles of Internal Medicine*, 12th edition, 1991, Chap. 185). Most patients who die suddenly from ischemic heart disease do so as a result of ischemia-induced malignant

ventricular arrhythmias. (*Harrison's Principles of Internal Medicine*, 12th edition, 1991, Chap. 40).

It is an object of the present invention to solve the problems associated with the conventional therapies used to treat these various forms of angina, anginal equivalents and acute coronary syndromes.

SUMMARY OF THE INVENTION

The present invention provides a method of treating angina that includes administering a therapeutically effective amount of liposomes to a subject. Stable angina, unstable angina, variant angina and/or anginal equivalents are treated utilizing the method described herein. The liposomes are selected from the group consisting of large liposomes, small liposomes, and combinations thereof, and administered such that LDL levels in the subject do not substantially rise.

Where large liposomes are used, the large liposomes are chemical compositions of liposomes of a size, function, composition, or administration method or schedule so that the liposomes do not harmfully disturb cholesterol homeostasis. Administering the liposomes includes slowly infusing the liposomes into a subject in one variant of the invention. In another variant of the invention, small doses of the liposomes are administered, separated in time, to avoid increasing the LDL concentration.

The method also includes periodically assaying the plasma LDL concentrations with an assay to obtain an assayed LDL concentration. The assay is selected from the group consisting of an assay of plasma esterified cholesterol, an assay of plasma apolipoprotein-B, a gel filtration assay of plasma, an ultracentrifugal assay of plasma, and a precipitation

assay having a component, the component selected from the group consisting of polyanions, divalent cations, and antibodies, an ultracentrifugal assay of plasma, a precipitation assay, an immuno-turbidimetric assay, and an electrophoretic assay to determine the level of a therapeutically effective amount of each of the liposomes.

The method uses therapeutically effective amounts of liposomes in the range of about 10 mg to about 1600 mg phospholipid per kg body weight per dose. The liposomes are given periodically during the treatment period in one embodiment, and are selected from the group consisting of uni-lamellar liposomes, pauci-lamellar, and multi-lamellar liposomes.

Preferably, the liposomes have diameters larger than about 50 nm, diameters larger than about 80 nm, and/or diameters larger than about 100 nm. The liposomes can also have diameters in the range of about 100 nm to about 150 nm, about 150 nm to about 200 nm, about 250 nm to 300 nm and/or about 300 nm to about 400 nm. Other preferred ranges of liposomes are described herein.

In another embodiment of the invention, the liposomes are given to a subject by intravenous bolus administration, intravenous infusion, and/or intra-peritoneal administration. Other routes are also contemplated, such as intramuscular, subcutaneous, intranasal, by inhalation, rectal, and by encapsulation into an orally or enterally absorbed form.

The method also includes a variant in which there is monitoring of a subject's cardiac function. A typical cardiac function that is monitored includes an EKG abnormality, an S-T segment change, an arrhythmia, an assessment of segmental wall

motion, blood viscosity, exercise tolerance, ambulatory EKG monitoring, and/or a cardiac wall motion abnormality.

In yet another variant of the invention, the method includes administering an effective amount of an anti-anginal drug other than the empty liposomes. "Empty" is standard terminology to indicate absence of an encapsulated drug within a liposome, or that no encapsulated drug is essential for one or more functions of the liposomes. The anti-anginal drugs include nitrates, beta blockers, calcium channel antagonists, coronary vasodilators, lipid lowering drugs, afterload reducing agents, inotropic agents, pre-load reducing agents and opiates.

A nitrate can include, by way of example, nitroglycerine, sublingually administered nitroglycerine, a long acting nitrate, an insublingual nitrate preparation, a buccal nitrate preparation, an oral nitrate preparation, a spray nitrate preparation, an oral nitroglycerin spray, an isosorbide dinitrate preparation, an isosorbide-5-Mononitrate preparation, a sustained-release preparation of isosorbide-5-mononitrate, a topical nitroglycerin, a nitroglycerin ointment, a nitroglycerin containing transdermal patch, and a silicone gel or polymer matrix impregnated with nitroglycerin.

A beta blocker can, by way of example, include a nonselective beta-blocking drug, propranolol, nadolol, penbutolol, pindolol, sotalol, timolol, carteolol, a drug that blocks both beta1 and beta2 receptors, a cardioselective beta blocker, acebutolol, atenolol, betaxolol, bisoprolol, esmolol, metoprolol, and a drug that blocks a beta1 receptor while having a lesser effect on a beta2 receptor.

In one variant of the invention, a calcium channel antagonist is selected from the group consisting of a calcium antagonist, a compound that inhibits calcium ion movement through a slow channel in cardiac and smooth muscle membranes by noncompetitive blockade of a voltage-sensitive L-type calcium channel, a dihydropyridine, nifedipineTM, a phenylalkylamine, verapamilTM, a benzothiazepine, diltiazemTM, nicardipineTM, amlodipineTM, and bepridilTM, a second-generation calcium antagonist, nicardipineTM, isradipineTM, amlodipineTM, felodipineTM and a dihydropyridine derivative.

Yet other aspects of the invention involve administering an angiotensin-converting enzyme (ACE) inhibitor to the subject in combination with the liposomes, administering an anti-arrhythmic drug to the subject in combination with the liposomes, and/or effecting a positive life style change in the subject. Typical positive life style changes include weight loss, reduction of cigarette smoking, elimination of cigarette smoking, exercise, supervised exercise, reduced salt intake, reduced intake of saturated fatty acids, reduced intake of cholesterol, a reduction in total fat intake, avoidance of physical stress, avoidance of emotional stress, and reduced intake of calories.

Yet a further aspect of the invention includes, effecting an anti-anginal therapy in combination with the liposome administration. The anti-anginal therapy comprises treatment of a co-existing aggravating condition such as a treatment for hypertension, a treatment for hyperthyroidism, a treatment for pulmonary disease, a treatment for heart failure, and a treatment for anemia.

Another embodiment of the invention includes administering an anti-thrombotic therapy in combination with the empty liposome administration. Anti-thrombotic therapies

are selected from the group consisting of administering a therapeutically effective amount of an anti-platelet drug, administering a therapeutically effective amount of a drug that interferes with formation of a fibrin clot, and a thrombolytic therapy.

Another embodiment of the invention comprises a method of treating claudication comprising administering a therapeutically effective amount of liposomes. As above, the liposomes are selected from the group consisting of large liposomes, small liposomes, and combinations thereof, and the method can be combined with the other method steps described above and below.

Still another aspect of the invention includes a pharmaceutical kit for treating angina comprising: a first container having a liposome; and a second container having an anti-anginal drug other than the liposome.

The invention is also directed to a method of preoperative and/or perioperative conditioning of a subject comprising administering liposomes, alone or in combination with the administration of an anesthetic or sedative and/or a preoperative evaluation or perioperative evaluation of a subject's cardiac function.

The objects and features of the present invention, other than those specifically set forth above, will become apparent in the detailed description of the invention set forth below.

BRIEF DESCRIPTION OF THE DRAWINGS

FIG. 1 is a side cross-sectional view of a lipoprotein and a liposome;

FIG. 2 illustrates a table of hepatic mRNA content (pg/ μ g) for CETP, HMG-CoAR, LDL receptors, and 7 α -hydroxylase; and LDL ChE;

FIGS. 3 and 4 illustrate plasma LDL cholesterol ester concentrations in response to injections of LUVs, SUVs or saline over time in one variant;

FIG. 5 illustrates LDL receptor mRNA levels in liver in response to injections of LUVs, SUVs or saline over time;

FIG. 6 illustrates HMG-CoA reductase mRNA levels in liver in response to injection of LUVs, SUVs, or saline;

FIG. 7 Illustrates cholesterol ester transfer protein mRNA levels in liver in response to injection of LUVs, SUVs, or saline;

FIG. 8 illustrates 7-alpha hydroxylase mRNA levels in liver in response to injections of LUVs, SUVs, or saline;

FIG. 9 illustrates key points about LUVs and atherosclerosis;

FIG. 10 illustrates plasma LDL unesterified cholesterol concentrations in response to injections of LUVs, SUVs or saline over time;

FIG. 11 illustrates plasma LDL esterified cholesterol concentrations in response to injections of LUVs, SUVs or saline over time;

FIG. 12 illustrates LDL esterified cholesterol concentrations in response to injections of LUVs, SUVs or saline;

FIG. 13 illustrates plasma VLDL esterified cholesterol concentrations in response to injections of LUVs, SUVs or saline;

FIGS. 14 and 15 illustrate HDL esterified cholesterol concentrations in response to injections of LUVs, SUVs or saline;

FIG. 16 illustrates the time course of cholesterol mobilization following an LUV injection into control or apoE KO mice;

FIG. 17 illustrates the time course of LUV clearance in control mice and apoE mice;

FIG. 18 illustrates that the compositions and methods of the present invention are effective in humans;

FIG. 19 illustrates a perspective view of an improved hemodialysis system of the present invention and improved method of hemodialysis;

FIG. 20 illustrates a perspective view of an improved peritoneal dialysis system 2000 and method of peritoneal dialysis;

FIG. 21 illustrates a perspective view of a variant of an improved peritoneal dialysis system with assaying means 2100 and method of peritoneal dialysis and analysis of spent fluid;

FIG. 22 illustrates a perspective view of an improved cardiac catheterization and/or angioplasty system 2200 and method of cardiac catheterization and/or angioplasty;

FIG. 23 illustrates a perspective view of a variant of an improved cardiac catheterization and/or angioplasty system 2300 and method of cardiac catheterization and/or angioplasty;

FIG. 24 illustrates a graph of hepatic lipid contents in response to injections of LUVs, SUVs, or saline;

FIG. 25 illustrates plasma free cholesterol concentrations following repeated injections of SUVs or LUV (300 mg/kg) in NZW rabbits;

FIG. 26 illustrates plasma cholesterol ester concentrations following repeated injections of SUVs or LUV (300 mg/kg) in NZW rabbits;

FIG. 27 illustrates alternations in plasma components after repeated injections of SUVs; and,

FIG. 28 illustrates an agarose gel electrophoresis of whole plasma following repeated injections of LUVs, SUVs, or saline.

DETAILED DESCRIPTION OF THE INVENTION

FIG. 1 illustrates a schematic illustration of the structure of a normal lipoprotein 100 and a unilamellar liposome 200. Lipoprotein 100 and liposome 200 are comprised of a phospholipid molecule 300. Phospholipid molecules generally have polar head 500 and a fatty acyl chains 400. Molecule 600 represents a molecule of unesterified cholesterol. Lipoprotein 100 is comprised of a hydrophobic core 102 composed mainly of triglycerides and cholesterol esters surrounded by a monolayer of phospholipid molecules 300 with their fatty acyl side chains 400 facing the hydrophobic core 102 and their polar heads 500 facing the surrounding aqueous environment (not shown). Unesterified cholesterol 600 is found largely within the phospholipid monolayer. Apolipoprotein 700 is disposed within phospholipid molecules 300. Artificial triglyceride emulsion particles have essentially identical structures, either with or without protein.

Liposome 200 is comprised of phospholipid molecules 300 forming a phospholipid bilayer, e.g. one lamella, either with or without protein, in which fatty acyl side chains 400 face each other, the polar head groups 500 of the outer leaflet face outward to the surrounding aqueous environment (not shown), and the polar head groups 500 of the inner

leaflet face inward to the aqueous core 202 of the particle 200. Depending on the composition of particle 200, phospholipid bilayers can have a large capacity for unesterified cholesterol and other exchangeable material and components thereof. As illustrated in FIG. 1 there is no sterol. Typically, such liposomes can pick up unesterified cholesterol from other lipid bilayers, such as cell membranes, and from lipoproteins. Liposomes also pick up proteins and donate phospholipids and other exchangeable material and components thereof. Liposomes can also have multilamellar structures, in which the bilayers are contained within the environment encapsulated by an outer bilayer to form multiple lamellae. The multiple lamellae can be arranged concentrically, like the layers of an onion, or in another variant non-concentrically.

The liposomes described above are used in a method of treating angina and anginal equivalents. The types of angina that can be treated using the method include stable angina, unstable angina and/or variant angina. In particular, the invention is effective in treating angina pectoris.

The method includes the step of administering a therapeutically effective amount of a multiplicity of large liposomes comprised of phospholipids substantially free of sterol to a subject for a treatment period. In one variant of the invention the large liposomes are of a size and shape larger than fenestrations of an endothelial layer lining hepatic sinusoids in a liver. Preferably, the large liposomes have diameters larger than about 50 nm, diameters larger than about 80 nm, or diameters larger than about 100 nm. Particularly effective liposomes have diameters in the range of about 100 nm to about 200 nm. In a variant of the

invention, the liposomes are selected from the group consisting of large liposomes, small liposomes, and combinations thereof.

The therapeutically effective amount of the liposome administration is in the range of about 10 mg to about 1600 mg phospholipid per kg body weight per dose, and the liposomes are given periodically during said treatment period. The therapeutically effective dosage of liposomes can be given in a variety of manners, including by way of example, intravenous bolus administration, intravenous infusion, and intra-peritoneal administration.

The method of administering the liposomes can be coupled with steps to determine the efficacy of the treatments. For example, the method includes monitoring a cardiac function of a subject prior to, during, or subsequent to the administration of liposomes. A pre-treatment cardiac function measurement is taken prior to administration of the liposomes. After administration of the liposomes the improvement in cardiac function of the patient can also be determined to show the efficacy of the treatment and to determine if subsequent treatments are required or to determine the time period between subsequent treatments or the appropriate dosage of subsequent treatments.

There are many cardiac functions that can be analyzed in the invention. These functions include an EKG abnormality, an S-T segment change, an arrhythmia, an assessment of segmental wall motion, blood viscosity, exercise tolerance, ambulatory EKG monitoring, and a cardiac wall motion abnormality.

The liposome administration can also be beneficially coupled with the administration of an effective amount of an anti-anginal drug other than the liposomes, or an anti-anginal procedure, e.g. LDL phoresis, angioplasty, or other revascularization.

These anti-anginal drugs include, by way of example, a nitrate, a beta blocker, a calcium channel antagonist, a coronary vasodilator, a lipid lowering drug, an afterload reducing agent, an inotropic agent, a pre-load reducing agent, oxygen, an opiate and derivatives and/or combinations thereof. It is also understood that liposomal administration is particularly desirable in patients in whom conventional antianginal therapies are marginally effective or ineffective, such as diabetics.

Exemplary nitrates used in this invention include nitroglycerine, sublingually administered nitroglycerine, a long acting nitrate, an insublingual nitrate preparation, a buccal nitrate preparation, an oral nitrate preparation, a spray nitrate preparation, an oral nitroglycerin spray, an isosorbide dinitrate preparation, an isosorbide-5-mononitrate preparation, a sustained-release preparation of isosorbide-5-mononitrate, a topical nitroglycerin, a nitroglycerin ointment, a nitroglycerin containing transdermal patch, and a silicone gel or polymer matrix impregnated with nitroglycerin.

Exemplary beta blockers used in the invention include nonselective beta-blocking drugs, propranolol, nadolol, penbutolol, pindolol, sotalol, timolol, carteolol, a drug that blocks both beta1 and beta2 receptors, a cardioselective beta blocker, acebutolol, atenolol, betaxolol, bisoprolol, esmolol, metoprolol, and a drug that blocks a beta1 receptor while having a lesser effect on a beta2 receptor.

Exemplary calcium channel antagonists include a compound that inhibits calcium ion movement through a slow channel in cardiac and smooth muscle membranes by noncompetitive blockade of a voltage-sensitive L-type calcium channel, a dihydropyridine, nifedipineTM, a phenylalkylamine, verapamilTM, a benzothiazepine, diltiazemTM,

nicardipineTM, amlodipineTM, and bepridilTM, a second-generation calcium antagonist, nicardipineTM, isradipineTM, amlodipineTM, felodipineTM, a dihydropyridine derivative, combinations thereof, and derivatives thereof.

The invention can also include the step of administering an angiotensin-converting enzyme (ACE) inhibitor to the subject and/or administering an anti-arrhythmic drug to the subject to achieve beneficial results for the subject. Different types of ACE inhibitors are described below. It is also possible to effect a positive life style change in the subject to obtain beneficial results. These life style changes include weight loss, reduction of cigarette smoking, elimination of cigarette smoking, exercise, supervised exercise, reduced salt intake, reduced intake of saturated fats and fatty acids, reduced intake of cholesterol, a reduction in total fat intake, avoidance of physical stress, avoidance of emotional stress, and reduced intake of calories.

Yet another variant of the invention includes the step of administering a therapeutically effective amount of a multiplicity of large liposomes (e.g. empty liposomes) comprised of phospholipids substantially free of sterol to a subject for a treatment period in combination with effecting an anti-anginal therapy. An exemplary anti-anginal therapy includes treatment of a co-existing aggravating condition. Treatment of a coexisting aggravating condition includes, by way of example, a treatment for hypertension, a treatment for hyperthyroidism, a treatment for pulmonary disease, a treatment for heart failure, a treatment for anemia, a treatment for a hypermetabolic state, and a treatment for diabetes mellitus.

Yet another aspect of the invention includes the step of administering a therapeutically effective amount of a multiplicity of large liposomes (e.g. empty liposomes) comprised of phospholipids substantially free of sterol to a subject for a treatment period in combination with administering an anti-thrombotic therapy. Various types of anti-thrombotic therapies are used in the invention including administering a therapeutically effective amount of an anti-platelet drug (described below), administering a therapeutically effective amount of a drug that interferes with formation of a fibrin clot, and/or a thrombolytic therapy.

It is appreciated that the use of the large liposomes described herein (or in a variant the small liposomes described herein if administered in a way to substantially eliminate the detrimental effects of the administration) provides for substantial LDL level control and/or control of other atherogenic lipoproteins. The methods described herein can be combined with the monitoring of LDL levels of a subject. In the variant where liposomes are selected from the group consisting of large liposomes, small liposomes, and/or combinations thereof it is desirable to monitor a subject's LDL levels, and more importantly to administer the small liposomes in such a way that LDL levels in said subject to not substantially rise. This can be accomplished by slowly infusing the liposomes, and/or administering small doses of the liposomes, separated in time, to avoid increasing the LDL concentration, or by administration of cholesterol lowering agents, or by coadministration of large liposomes.

To monitor the LDL concentrations one periodically assays the plasma LDL concentrations with an assay to obtain an assayed LDL concentration. The assay can

include an assay of plasma esterified cholesterol, an assay of plasma apolipoprotein-B, a gel filtration assay of plasma, an ultracentrifugal assay of plasma, and a precipitation assay having a component by way of example, the component is selected from the group consisting of polyanions, divalent cations, and antibodies, other assays used herein include an ultracentrifugal assay of plasma, a precipitation assay, a immuno-turbidimetric assay, and/or an electrophoretic assay to determine the level of a therapeutically effective amount of each of the liposomes.

It is also appreciated that the other method steps described above can be utilized with the combination of liposomes of different sizes, and that a particularly useful type of liposome comprises POPC. Liposomes comprised of phospholipids that are liquid crystalline at body temperature yet resistant to oxidation are desirable. It is understood that liposomes mobilize cholesterol and other exchangeable material and donate phospholipid in part through cooperation with HDL and with transfer proteins such as phospholipid transfer protein and cholesterylestertransfer protein. These can be endogenous or exogenous.

In another aspect of the invention a pharmaceutical kit for treating angina is also described herein. The kit includes a first container having liposomes; and a second container having anti-angina drug other than the liposomes. Exemplary anti-anginal drugs are described above.

Yet another particularly useful aspect of the invention includes a method of preoperative or perioperative conditioning of a subject comprising administering liposomes. There are many subjects who are at risk for complications when undergoing surgery. Many of these risks can be decreased with the administration of liposomes at some

effective, empirically determined time period prior to a surgical procedure in which the patient's body runs the risk of being stressed. The method of preoperative conditioning of a subject can be combined with other known preoperative steps and treatments such that the patient's risk of complication and/or stress related to the surgical procedure can be minimized. These other pre-operative steps include, by way of example, administration of an anesthetic or sedative, a preoperative evaluation of a subject's cardiac function, and the like.

The liposomes of the present invention are advantageously and efficiently manufactured using the novel method(s) and system(s) described herein. Producing liposomes of a desired, substantially uniform size range, e.g. 125nm-250 nm, is particularly slow using conventional methods since upon initial creation, the first passage the liposomes/liposome precursors is difficult since large particles pass through conventional extrusion devices glacially slowly.

Hence, the invention includes a commercial method of manufacturing large quantities of liposomes within a desired size range. The method includes hydrating phospholipids. The hydration step generates large particles that are difficult to pass through an extruder the first time with a pore size in the desired range. Hence, the method includes preconditioning the hydrated liposomes by utilizing a high throughput apparatus to bring the particles into a size range that readily passes through an extruder with filters to generate the desired particle size (about 200 nm to about 400 nm), and then subsequently passing the pre-conditioned particles through an extruder fitted with filters of a desired size, e.g. a size of about 100 nm or other desired size. Exemplary high throughput apparatus include a

microfluidizer, a homogenizer, a shear based device, and/or an extruder with a large pore size (500 nm or other appropriate large pore size). It is appreciated that using the method described above cuts down considerably on manufacturing and/or processing time to obtain liposomes in a desired size range. The problem of a production rate bottle neck is eliminated by the preconditioning step described above.

There are populations of LDL that are thought to be particularly harmful, e.g. small dense LDL which is also known as pattern β LDL. Pattern β LDL is commonly seen in diabetes, hypertriglyceridemia, low HDL conditions, hypertension, insulin resistance, hyperinsulinemia, and/or syndrome X conditions. Small dense LDL is characterized by being lipid poor, particularly in regard to surface lipids, including unesterified cholesterol and phospholipid. LDL can acquire phospholipid from liposomes. Treatment of a subject with phospholipid liposomes enriches small dense LDL, restores it to a normal phospholipid content, reduces its atherogenicity, and/or normalizes its carbohydrate content and/or its size. Treatment with the compositions described herein changes the surface charge density of the small dense LDL, and brings it towards normal surface charge density. Lipoproteins in subjects who have small dense LDL show enhanced binding to proteoglycans (the most avidly binding of their lipoproteins is IDL). The compositions and treatments described herein will ameliorate harmful properties of small dense LDL and other lipoproteins commonly found in subjects who have small dense LDL.

Examples of harmful properties that are ameliorated with the treatments disclosed herein include, but are not limited to, avid binding to arterial matrix, ready oxidability, ease of penetration into the arterial wall, and impaired LDL receptor binding.

The present invention further provides a method of treating accelerated syndromes of vascular dysfunction. Accelerated syndromes of vascular dysfunction include renal disease, transplant atherosclerosis, silent ischemia and manifestations thereof for all body parts (particularly the brain, legs, sexual organs, and the heart), ischemia, vein grafts, diabetes mellitus, diabetes mellitus with nephropathy, and diabetes mellitus with proteinuria. The present invention also provides a method to treat other perfusion abnormalities, such as hyperviscosity syndrome, sickling disorder, a condition involving impaired wound healing, and/or a condition involving blood cell or platelet aggregation.

Organ perfusion can be determined herein by tests such as a PET scan, a Doppler assessment, an assessment using contrast agents, and plethysmography.

After-load reducing agents used herein include anti-hypertensive drugs and peripheral vasodilators, such as nitrates, and calcium channel antagonists.

The invention also provides a treatment for male and/or female sexual dysfunction, acute coronary syndromes, stable coronary syndromes, claudication, transient ischemic attacks, stroke, heart attacks, myocardial infarctions, myocardial ischemia, ischemia to any body part, organ dysfunction from ischemia, and/or organ infarction from ischemia.

Administration of liposomes facilitates angiogenesis, for example formation of collateral blood vessels. Collateral blood vessel formation is impaired in hypercholesterolemia and influenced by LDL or related particles that contain apo-B. Hence, use of the method is a beneficial treatment for a subject who may benefit from enhanced angiogenesis, including collateral blood vessel formation

FIGS. 3 and 4 illustrate plasma LDL cholesterol ester concentrations in response to injections of LUVs, SUVs or saline over time. Rabbits were intravenously injected on days 1, 3 and 5 as indicated by arrows 302, 304, and 306 respectively, with a bolus of 300 mg of phosphatidylcholine per kg of body weight or a matched volume of saline. The phosphatidylcholine was pharmaceutical grade egg PC, in the form of either large unilamellar vesicles (LUVs) having diameters of approximately 100 NM (preferably \sim 120 NM) prepared by extrusion (LUVs were measured by a Nicomp™ model 370 submicron laser particle sizer at about 120 NM (123 ± 35 NM and the extrusion membrane had pores of about 100 NM in diameter) or small unilamellar vesicles with diameters of approximately 30 NM (preferably 35 NM) prepared by sonication. (SUVs were measured in the range of 34 ± 30 NM.) Blood was drawn just before each injection and on the sixth day at sacrifice. Plasma LDL cholesterol ester concentrations were determined by a gel filtration assay of the plasma with an in-line enzymatic assay for cholesterol ester. Means \pm SEMs are shown in FIG. 3. Animals infused with SUVs showed significantly higher plasma concentrations of LDL cholesterol ester at days 3, 5, and 6 compared to either LUV-infused or saline infused animals. FIGS. 2-8, 10-15, 24 and 28 illustrate data from the same experiment in which injections were made on days 1, 3, and 5 and then livers were taken. Gel filtration was done of plasma to measure lipid contents of individual lipoprotein classes. FIG. 2 illustrates a table of hepatic mRNA content (pg/ μ g) for CETP, HMG-CoA R (hydroxy methylglutaryl coenzyme A reductase), LDL receptors, and cholesterol 7- alpha-hydroxylase; and LDL ChE (low density lipoprotein cholesterol ester) for the rabbits given

saline (HEPES buffered saline) (rabbits 1-4), LUVs (rabbits 5-8), and SUVs (rabbits 10-12) for the experiment described for FIGS. 3 and 4. Rabbit 13 is the "Mix" rabbit.

FIG. 4 shows an animal labeled as mix. "Mix" refers to a single animal that received SUVs on day 1, 3 and 5, but also one injection of LUVs on day 3. Before this injection of LUVs, the plasma concentration of LDL cholesterol ester rose, but after the injection of LUVs, the LDL concentration fell, despite continued injections of SUVs.

FIG. 5 illustrates LDL receptor mRNA levels in liver in response to injections of LUVs, SUVs or saline over time. The rabbits described above were sacrificed at day 6, and samples of liver were snap-frozen in liquid nitrogen. mRNA was extracted, and rabbit mRNA for the LDL receptor was quantified by an internal standard/RNase protection assay (Rea T.J. et al. *J. Lipid Research* 34:1901-1910, 1993 and Pape M.E., *Genet. Anal.* 8:206-312, 1991). Means \pm SEMs are shown in FIG. 5. Animals infused with SUVs showed significant suppression of hepatic LDL receptor mRNA compared to LUV-infused or saline-infused animals. Suppression of hepatic LDL receptor mRNA reflects parenchymal cell overload with sterol, and is a potentially harmful alteration from normal hepatic cholesterol homeostasis. In contrast, LUV-infused animals showed the highest levels of hepatic LDL receptor mRNA, though the increase above that seen in the saline-infused animals did not reach statistical significance. The liver from the "Mix" animal described above showed a value of 5.28 pg LDL receptor mRNA/microgram which is closer to the average value in the saline group than in the SUV group. Thus, LDL receptor mRNA was stimulated by the single injection of LUVs despite repeated injections of SUVs.

FIG. 6 illustrates HMG-CoA reductase mRNA levels in liver in response to injections of LUVs, SUVs, or saline. The experimental details are those as referenced above. Animals infused with SUVs showed significant suppression of hepatic HMG-CoA reductase mRNA compared to LUV-infused or saline infused animals. Suppression of hepatic HMG-CoA reductase mRNA reflects parenchymal cell overload with sterol, which can be a potentially harmful alteration from normal hepatic cholesterol homeostasis. In contrast, LUV-infused animals showed the highest levels of hepatic HMG-CoA reductase mRNA, though the increase above that seen in the saline-infused animals did not reach statistical significance.

The "mix" animal showed a value of 0.50 pg HMG-CoA reductase mRNA/microgram, which is essentially identical to the average value in the saline group (0.51) and substantially higher than the value in the SUV group (0.27). Thus, HMG-CoA reductase mRNA was stimulated to its normal value by the single injection of LUVs, despite repeated injections of SUVs.

FIG. 7 illustrates cholesterol ester transfer protein mRNA levels in liver in response to injection of LUVs, SUVs, or saline. The experimental details are those as referenced above. Animals infused with LUVs showed significant suppression of hepatic CETP mRNA compared to SUV infused or saline infused animals. Suppression of CETP mRNA produce changes in the plasma lipoprotein profile usually associated with reduced risk of atherosclerosis. The "mix" animal showed a value of 3.18 pg CETP mRNA/microgram, which is closer to the average value in the LUV group than in the SUV or saline groups.

Thus, CETP mRNA was suppressed by the single injection of LUV's despite repeated injections of SUVs.

FIG. 8 illustrates cholesterol 7-alpha hydroxylase mRNA levels in liver in response to injections of LUVs, SUVs, or saline. The experimental details are those as reference above. Animals infused with SUVs showed suppression of hepatic 7-alpha hydroxylase mRNA compared to LUV infused or saline infused animals. Suppression of 7-alpha hydroxylase can be a potentially harmful alteration from normal hepatic homeostasis. In contrast, LUV-infused animals showed the highest levels of hepatic 7-alpha hydroxylase mRNA, though the increase above that seen in the saline infused animals did not reach statistical significance. The "mix" animal showed a value of 0.51 pg 7-alpha hydroxylase mRNA/microgram, which is higher than the average value in the SUV group. Thus, 7-alpha-hydroxylase mRNA was stimulated by the single injection of LUVs, despite repeated injections of SUVs.

FIG. 10 illustrates unesterified cholesterol concentrations in whole plasma in response to injections of LUVs, SUVs, or saline over time. The experimental details are those as referenced above. As indicated by this figure, LUVs and SUVs significantly raised the plasma concentrations of unesterified cholesterol indicating mobilization of tissue stores. The LUVs raised the concentration of unesterified cholesterol more than did the SUVs.

FIG. 11 illustrates esterified cholesterol concentrations in whole plasma in response to injections of LUVs, SUVs or saline over time. The experimental details are those as referenced above. SUVs raised the plasma concentrations of cholesterol ester on days 3, 5, and 6. FIG. 12 duplicates the information contained in FIG. 3.

FIG. 13 illustrates plasma VLDL esterified cholesterol concentrations in response to injections of LUVs, SUVs, or saline. SUVs increased the plasma concentration of VLDL cholesterol ester over that seen in the saline or LUV treated groups. The "mix" animal showed a plasma VLDL cholesterol ester concentration at day 6 of 2.4 mg/dl, which is lower than the average value in the SUV group. The experimental details are those as referenced above.

FIGS. 14 and 15 illustrate HDL esterified cholesterol concentrations in response to injections of LUVs, SUVs, or saline. The experimental details are those as referenced above as in FIG. 2. Suitable phospholipid can be obtained from Avanti Polar Lipids, Nippon Oil and Fat in Japan and Princeton Lipids, as well as other suppliers. LUVs are made through an extruder that is commercially available. SUVs caused a small but statistically significant rise in HDL cholesterol ester concentrations on days five and six.

FIG. 16 illustrates the time course of cholesterol mobilization following an LUV injection into control or apoE KO (knock-out) mice commercially available from Jackson Laboratories, in Bar Harbor, Maine. Control (C57/BL6) and apolipoprotein E knock-out mice were injected at time zero with a single bolus of 300 mg LUV phospholipid/kg body weight. The LUVs contained a tracer amount of labeled cholesterol hexadecylether, which remains on the liposomes after injection into a mouse. Displayed data are for concentrations of total cholesterol, i.e. esterified plus unesterified, in whole plasma. The rise in both sets of animals indicated that LUVs mobilize cholesterol into the plasma, even in the presence of a severe genetic hyperlipidemia.

FIG. 17 illustrates the time course of LUV clearance in control mice and apoE mice. The experimental details are as described in FIG. 16. The clearance of LUVs from the plasma is unimpaired in the apoE knock-out mice, indicating mobilization (FIG. 16) and disposal (FIG. 17) of cholesterol even in the presence of a severe genetic hyperlipidemia. This indicates the usefulness of this preparation in hyperlipidemias.

FIG. 18 illustrates other applications for the compositions and methods of the present invention in humans.

FIG. 19 illustrates a perspective view of an improved hemodialysis system of the present invention and improved method of hemodialysis. Among other advantages, this improved method allows the treatment of angina, anginal equivalents, claudication, and related conditions, and preoperative conditioning during or around the time of dialysis. Blood is taken from a site for circulatory access (shown here as arm 1900) and transported into a cell-plasma separator 1910. The plasma is then transported to a dialysis chamber 1920 and is divided into at least two compartments that are separated by a semi-permeable membrane 1930. One side of the membrane 1930 is the patient's plasma 1940 and on the other side is the dialysate 1950. Selected molecules exchange across the membrane 1930 depending on the characteristics of the membrane (charge, pore size, etc.). The device 1960 comprises a device for adding lipid acceptors to the dialysate and for sampling the dialysate to allow assays of cholesterol, phospholipid, and other components, such as acceptors, specific lipoproteins, specific components, and to monitor treatment. Extraction of plasma cholesterol or other extractable material comprises several possibilities: 1) acceptors are disposed in the dialysate that do not cross membrane 1930 into plasma; 2) the acceptors do

cross membrane 1930 and are either left in the plasma and returned to the patient or are separated from plasma before it is returned to the patient; and/or 3) immobilized acceptors on a sheet (such as membrane 1930 itself), on beads, and/or on the walls of the chamber 1920. Plasma thus treated is returned to the patient, usually after having being re-mixed with the blood cells. As noted, cholesterol acceptors can be added at any stage, as an example, a device 1970 comprises acceptors and for adding acceptors to plasma shortly before its return into the patient is also illustrated in FIG. 19. It is further understood that contaminating cellular material, such as platelets, in the plasma will also become cholesterol depleted in endogenous lipids and enriched in phospholipid. It is further understood that all acceptors mentioned throughout this application may accept molecules in addition to cholesterol and may donate material as well.

The cellular concentrate from the cell-plasma separator 1910 can then be treated in any of several ways before being returned to the patient: 1) returned to the patient with no further treatment (this includes being mixed with plasma that has been treated as above); 2) transferred to a second dialysis chamber (not shown) in which the dialysate contains cholesterol acceptors to lipid deplete the cells of endogenous lipids, such as cholesterol, before their return to the patient; 3) mixed with a suspension or solution of lipid acceptors to lipid deplete the cells of endogenous lipids, then either returned to the patient with the acceptors or option 1) and option 2) above can be performed with all cell types together, or after further separation into specific cell types (for example, purified platelets could be lipid depleted of endogenous lipids, such as cholesterol, and enriched in liposomal lipids). Options 2) and 3) can be performed with periodic assays of cellular cholesterol,

phospholipid, fluidity, viscosity, fragility, cell composition and/or cell function. Devices 1960, 1970 include an apparatus that allows for the periodic sampling of cells during treatment. As with plasma, lipid acceptors can be added at any stage of the treatment. All fluids, e.g. plasma and concentrated cells, are moved by gravity, mechanically, by manual manipulation (a syringe), or with pumps as needed. Of course, it is understood that blood can be drawn for processing from any appropriate part of the body.

FIG. 20 illustrates a perspective view of an improved peritoneal dialysis system 2000 and method of peritoneal dialysis. Among other advantages, this improved method allows the treatment of angina, anginal equivalents, claudication, and related conditions, and preoperative conditioning during or around the time of dialysis. Patient's abdomen 2010 (FIGS. 20-21) receives peritoneal dialysate 2020 stored in container 2030 into the peritoneal cavity through incision 2040 by way of channel 2050. Lipid acceptors and/or cholesterol acceptors 2060 are optionally disposed in container 2070. In another variant, lipid acceptors are added to dialysate 2020; added to container 2030 in concentrated form shortly before infusion; added as shown to the stream of fluid entering the peritoneal cavity; or infused by a separate portal of entry into the patient by any effective route. Throughout this application, it is understood that all acceptors may accept molecules in addition to cholesterol and may donate material such as phospholipids and anti-oxidants.

FIG. 21 illustrates a perspective view of a variant of an improved peritoneal dialysis system with assaying means 2100 and method of peritoneal dialysis and analysis of spent fluid. Container 2110 accepts spent fluid from abdomen 2010 by way of channel 2120. The device 2110 provides access to diagnostic samples of spent dialysate to allow for assay

of cholesterol, phospholipid, and other parameters as described herein showing the efficacy of the treatments described. Optionally, assay syringe 2130 is inserted by way of access portal 2140 into channel or tube 2120, or into container 2110, and optional pumps (not shown) are used to move the various fluids to appropriate locations for assay thereof.

FIG. 22 illustrates a perspective view of an improved cardiac catheterization and/or angioplasty system 2200 and method of cardiac catheterization and/or angioplasty, in the context of angina or anginal equivalents or related ischemic disorders. Patient 2210 undergoes cardiac catheterization and/or angioplasty. The patient intravenously receives effective doses of lipid acceptors or cholesterol acceptors 2230 co-administered with the treatment(s) from container 2220. Intraarterial access of a catheter for coronary angiography and/or angioplasty allows for ready co-administration of cholesterol acceptors and administration of diagnostic agents such as cholinergic agents, to assess vascular function.

FIG. 23 illustrates a perspective view of a variant of an improved cardiac catheterization and/or angioplasty system 2300 and method of cardiac catheterization and/or angioplasty in the context of angina, anginal equivalents or other ischemic disorders. Catheterization and/or angioplasty catheter 2310 has apertures 2320 that allow for the egress of cholesterol acceptors therefrom. In a variant, catheter 2310 has a permeable membrane that allow for the egress for cholesterol acceptors therefrom. Phantom arrows 2330 indicate egress sites for cholesterol acceptors and/or diagnostic agents. Sites 2340 indicate entry sites for the acceptors or agents. The balloon on the device 2300 can be replaced or supplemented with other devices or can form an inner balloon layer disposed within an

outer balloon layer. The acceptors are disposed between the inner and outer flexible balloon layers. Upon expansion of the inner balloon layer a force is exerted against the fluid or gel-like acceptors forcing the acceptors out of the sites 2320, and into direct contact (forcefully) against arterial lesions more locally directing the treatment. It will be appreciated that this variant of the invention provides for maximal penetration of the acceptors into the arterial sites. The infusions can be accomplished by gravity, manual manipulation of a syringe, or by mechanical infusion pump 2350. The same method and system can be utilized with standard vascular imaging techniques or vessels that include the femorals, carotids, and mesenteric vessels by way of example.

Patient 2210 undergoes cardiac catheterization and/or angioplasty. The patient intravenously receives effective doses of cholesterol or lipid acceptors 2230 co-administered with the treatments(s) from container 2220. Intraarterial access of a catheter for coronary angiography and/or angioplasty allows for ready co-administration of lipid or cholesterol acceptors and administration of diagnostic agents such as cholinergic agents, to assess vascular function, an/or agents to assess organ perfusion.

Container 2110 accepts spent fluid from abdomen 2010 by way of channel 2120. The device 2110 provides access to diagnostic samples of spent dialysate to allow for assay of cholesterol, phospholipid, and other parameters as described herein showing the efficacy of the treatments described. Optionally, assay syringe 2130 is inserted by way of access portal 2140 into channel or tube 2120, and optional pumps (not shown) are used to move the various fluids to appropriate locations for assay thereof.

FIG. 24 illustrates a graph of hepatic lipid contents in response to injections of LUVs, SUVs, or saline. The experimental details are as outlined above. Liver samples were assayed for contents of several lipids: cholesterol ester (CE); triglyceride (TG); unesterified cholesterol (Chol); phosphatidylethanolamine (PE); and phosphatidylcholine (PC), which are displayed in units of μg (micrograms) lipid/mg. Lower values of PE and PC in the SUV-treated animals were produced; thus, the Chol:phospholipid ratios in these animals was higher than in the other groups.

FIG. 25 illustrates cholesterol ester concentrations following repeated injections of SUVs or LUVs (300 mg/kg) in NZW rabbits (New Zealand White rabbits). The arrows indicate times of phospholipid injection here on days 0, 3 and 5. For a given phospholipid dose, LUVs promote a greater rise in plasma free cholesterol concentrations.

FIG. 26 illustrates plasma free cholesterol concentrations following repeated injections of SUV or LUV (300 mg/kg) in NZW rabbits in the same experiment as in FIG. 25, arrows indicate times of phospholipid injection. Repeated injections of LUV, unlike SUV, do not provoke a dramatic rise in CE concentrations in plasma.

The rise in plasma CE concentrations that results from the delivery of excess cholesterol to the liver may be the consequence of two processes. It may involve an over production of CE-rich particles or an impaired clearance of CE-rich lipoproteins. Over production of CE-rich particles that occurs following SUV infusions may result in the plasma or in the liver. In plasma, LCAT acts on small unilamellar phospholipid vesicles (empty or with encapsulated drug) or on phospholipid enriched HDL generating CE which may be subsequently transferred by CETP onto LDL. The results with gel filtration of

plasma from animals treated with SUVs indicate that CE is carried mostly or substantially on LDL. Also, in plasma, removal of apoE from VLDL by SUVs will slow the clearance of VLDL, thereby favoring a more efficient conversion into LDL. In the liver, the increased delivery of cholesterol to hepatocytes during cholesterol mobilization from peripheral tissues stimulates an over secretion of apoB, CE-rich lipoproteins.

In a variant, the rise in plasma CE concentrations observed is the result of an impaired clearance of CE rich atherogenic lipoproteins. Intravenously administered liposomes that acquire apoE compete with LDL for LDL-receptor mediated uptake. The delivery of excess cholesterol to particular regulatory pools within the liver down regulates LDL receptors, which impedes hepatic uptake of atherogenic lipoproteins from plasma. For example, LDL removal from plasma is reduced; VLDL removal is also impaired, favoring its conversion to IDL and LDL. The processes responsible for an increase in plasma CE concentrations are different between the two liposome preparations. LUVs, unlike SUVs, do not provoke a rise in plasma CE concentrations. LUVs are superior preparations for mobilizing tissue cholesterol and other exchangeable material, but without causing harmful side effects.

The method and composition of the present invention also provides enrichment of HDL cholesterol esters by SUVs. One contributing process is the stimulation of lecithin cholesterol acyl transferase (LCAT) and other processes related thereto. The ability of SUVs to increase HDL cholesterol ester is the result of stimulation of LCAT and other processes related thereto. LCAT need phospholipid and cholesterol to generate cholesterol ester and lysophosphatidylcholine; liposomes can supply extra phospholipid. The present

invention also provides for alterations in lipoprotein (LDL, HDL, etc.) composition and function by LUVs and/or SUVs and/or other acceptors.

The liposome compositions described herein and methods utilizing same also include the liposomes picking up endogenous apoE and hence blocking cellular uptake of LDL. The liposomes pick up apolipoproteins, such as apoE and apoA-I, and that this alters or enhances their functions. For example, the uptake of endogenous apoA-I enhances the ability of liposomal derived phospholipid to pick up cholesterol, and the uptake of endogenous apoE would allow the liposomes to block certain pathways for arterial uptake of lipoproteins. All of this is in the context of controlling LDL levels and hepatic gene expression and cholesterol homeostasis.

LUVs and SUVs deliver cholesterol to different regulatory pools within the liver. This conclusion is supported by the differences in hepatic gene responses and CETP mRNA is suppressed: the LDL receptor mRNA is unaffected or increased by LUVs but suppressed by SUVs; and CETP is suppressed by LUVs, but unaffected by SUVs.

The key points about LUVs are illustrated in FIG. 9. The practical benefits of using LUVs as a treatment for angina, anginal equivalents and other ischemic disorders are that they are straight forward to manufacture, allergen-free, synthetic and non-toxic even at very high doses. Mechanistically, LUVs promote reverse cholesterol transport *in vivo* without provoking a rise in LDL concentration, and LUVs are an optimal preparation. Although these particles are often referred to as "empty" vesicles, it is understood that incorporation of a drug into the aqueous interior or into the bilayer(s) of phospholipid vesicles can also be performed, without disrupting at least one essential action of the vesicles.

The compositions that are used herein can direct clearance away from hepatic parenchymal cells. And the various methods described herein are utilized with slow infusions of the compositions described, so that hepatic cells are not cholesterol overloaded even if clearance by parenchymal cells occurs. Further, HDL is also controlled by CETP gene suppression.

As described herein assays are performed by: assaying fasting plasma triglyceride to estimate VLDL concentrations; assaying plasma cholesterol (free ester, or total minus free = ester); precipitating LDL (& VLDL) with polyanions-cations; assaying the supernatant which is HDL; and computing LDL's (whole plasma value minus VLDL - HDL) sterol (or sterol ester) in whole plasma. Liposomes will precipitate with polyanions-cations; or optionally assaying the ester which liposomes mostly lack. Other assays include electrophoresis, chromatography, immune assays, electron microscopic assays, functional assays, structural assays, and compositional assays.

In the dialysate of the present invention, any liposomes or emulsions could be used as long as it's a cholesterol acceptor and either it does not raise LDL or it is not returned to the patient's circulation. In either case, one would need to assay plasma LDL and the plasma concentration of the acceptors, and plasma concentrations of other atherogenic lipoproteins.

With respect to the methods that require delivering the cholesterol to the liver at a slow rate, or in low doses administration might permit small acceptors, such as SUVs, to be used without LUVs provided LDL levels as levels of other atherogenic lipoproteins are monitored and regulated. To avoid disrupting hepatic cholesterol homeostasis, the

entrapped drug as described herein need not be given at low doses, but rather the encapsulating liposome or emulsion is given in low doses; the drug could be present at high amounts within a small number of liposomes or a small mass of liposomal lipid.

Alterations in HDL size, composition and function can be accomplished by administering high or even truly low doses of large and/or small liposomes that have little or no sterol. Liposomes without sterol, when given in low doses are easily broken apart by HDL and HDL apolipoproteins and then pieces are incorporated into the HDL fraction of plasma enriching it in phospholipid. Such small doses, e.g. 10-100 mg/kg/dose, even of SUVs without LUVs or drugs to lower LDL levels, are unlikely to raise plasma LDL levels, although periodic monitoring would be prudent.

Also, the method as disclosed herein of altering LDL composition without increasing LDL concentration would be to enrich the composition with phospholipids, like POPC (palmitoyl-oleoyl-phosphatidylcholine), that are resistant to oxidation, enrich the composition with anti-oxidants, deplete unesterified cholesterol, and reduce cellular or arterial uptake of oxidized LDL by phospholipid enrichment.

Liposomes up to about 1000 NM or so would work in the present invention. Larger liposomes would also work but extraction of tissue lipoprotein may be less efficient. It is further possible to concentrate or dry compositions of the present invention. These preparations are then diluted or reconstituted at the time of therapy or administration. In this variant, a two component kit comprising the active material and a diluent is provided. Inclusion of phosphatidyl glycerol (PG) to make the liposomes negatively charged, or

charge other components of the composition, to prevent aggregation during storage is also provided.

Figure 27 illustrates alterations in plasma components after repeated injections of SUVs. Watanabe Heritable Hyperlipidemic (WHHL) rabbits were given intravenously 1000 mg of SUV phospholipid per kg of body weight, or the equivalent volume of saline, on Monday, Wednesday, & Friday of each week for three weeks (nine doses total). Three days after the final dose, blood samples were taken, and plasma components were fractionated by size by passage over a Superose-6 gel-filtration column. Eluents were read by an in-line spectrophotometer. The tracing on the right is from a saline-injected rabbit, and shows VLDL around fractions #17-18, and LDL around fraction #27. The tracing on the left is from an SUV-injected rabbit, and shows VLDL with persistent liposomes around fraction #16, and LDL-sized particles around fraction #25. The tracings indicate an increase in the amount of LDL-sized particles after repeated injections of SUVs, consistent with an increase in LDL, which is a harmful effect. Because WHHL rabbits have a genetic lack of LDL receptors, this result indicates that SUVs disrupt hepatic cholesterol homeostasis not just by suppressing LDL receptors (Figure 5), but also by mechanisms independent of LDL receptors (Figure 27). LUVs avoid both LDL receptor-dependent and - independent disruptions.

Figure 28 illustrates an agarose gel electrophoresis of whole plasma following repeated injections of LUVs, SUVs, or saline. Experimental details are referenced in Figures 2-8 & elsewhere herein. Four- μ L plasma samples from two rabbits in each group at day 6 were electrophoresed through 1 % agarose then stained for lipids with Sudan black.

O: origin. β : migration of an LDL standard. The SUV-mediated increase in LDL concentration is illustrated by the darker but otherwise unremarkable β -band in those lanes.

SUVs in plasma exhibited a mobility ahead of LDL, owing to their acquisition of plasma proteins, chiefly from HDL. In contrast, plasma LUVs exhibited essentially the same mobility as freshly prepared, protein-free vesicles, i.e., just above the origin (O), indicating a substantial absence or reduction of acquired proteins on the LUVs.

Based on the electrophoretic mobilities in Figure 28, quantification of the acquisition of protein by LUVs versus SUVs was obtained. LUVs and SUVs were incubated with human HDL in vitro for 4 hours at 37°C, then separated from the HDL by gel filtration chromatography and assayed for protein and phospholipid. LUVs acquired 1.09 μg of protein per mg of liposomal phospholipid, whereas SUVs acquired 40.4 $\mu\text{g}/\text{mg}$, i.e., almost 40 times as much. Thus, the two types of liposomes exhibit a striking quantitative difference in protein adsorption. SUVs, but not LUVs, avidly strip apoE from VLDL, thereby slowing its clearance from plasma and favoring its conversion to LDL. In addition, adsorbed proteins play a role in directing the SUVs into a hepatic metabolic pool that disrupts hepatic cholesterol homeostasis, whereas LUVs are not directed into such a pool. Liposomes, emulsions, or any other particles or compounds that extract tissue lipids but do not acquire large amounts of plasma proteins behave similarly to LUVs in these regards.

Specific vascular genes affected by cholesterol loading of cells include genes for prolyl-4-hydroxylase; hnRNP-K; osteopontin (there may be a role for oxidized lipids in provoking arterial calcifications); and Mac-2. The methods of regulating these genes

described herein effect restoration of normal vascular or arterial function. Elevated expression of prolyl-4-hydroxylase (an enzyme in the synthesis of collagen, a component of fibrotic plaques) and hnRNP-K (identified in pre-mRNA metabolism and cell cycle progression) messages were found in aortic smooth muscle cells after cholesterol feeding. These would normalize after the liposome treatments described herein. Other genes or enzymes that are abnormal with cholesterol-loading and should normalize with liposome treatment as described herein include osteopontin, nitric oxide synthase (NOS), adhesion molecules, chemoattractants, tissue factor, PAI-1 (plasminogen activator inhibitor), tPA (tissue plasminogen activator) and Mac-2 (Ramaley et al. 1995). Other genes affected by cholesterol, cholesterol loading, oxidized lipids would also be corrected.

Many examples of small acceptors such as SUVs, apolipoprotein-phospholipid disks, and HDL are commercially available and can be used in the invention. Kilsdonk EP et al. Cellular cholesterol efflux mediated by cyclodextrins, *J. Biol. Chem.* 270:17250-17256, 1995. By way of further example, another small acceptor includes the cyclodextrins. Small acceptors (specifically HDL) shuttle cholesterol from cells to liposomes. Cyclodextrins and also other small acceptors can shuttle cholesterol and other exchangeable material from cultured cells to LUVs, which substantially increases the removal and donation of material between cells and LUVs. Apolipoprotein-phospholipid disks include, by way of example, a wild type apoprotein, an apoprotein mutant, an apoprotein variant, an apoprotein derivative, and a recombinant apoprotein.

Examples of anti-hyperlipidemic drugs include fibric acid derivatives, HmG CoA reductase inhibitors, Niacin, probucol, bile acid binders, other drugs and combinations

thereof. Anti-hyperlipidemic treatments also include LDL apheresis, ileal bypass, liver transplantation and gene therapy.

The data presented in this application support three possible explanations for the difference in metabolic response to LUVs *versus* SUVs. The three mechanisms act separately or in combination. First, LUVs are taken up largely by Kupffer cells, whereas SUVs are primarily directed towards hepatic parenchymal cells. This is partly a mechanical consequence of hepatic architecture: hepatic endothelial fenestrae are oval openings of about 100x115nm, through which SUVs of 30-nm diameter or so can readily pass and gain access to parenchymal cells. Large particles, such as large liposomes, of sufficient diameter will not pass easily, and are cleared instead by the macrophage Kupffer cells that line the liver sinusoids. While SUVs also have access to Kupffer cells, their sheer number (~ 10 times as many SUVs as LUVs per mg of phospholipid) appears to saturate the reticuloendothelial system, and so parenchymal cells predominate in their clearance. Other methods to direct artificial particles away from parenchymal cells are also available, such as by changing the particle structure or composition, including charge and specific ligands for cell-specific binding.

Cholesterol clearance pathways mediated by parenchymal *versus* Kupffer cells have distinct metabolic consequences. Direct delivery of cholesterol to parenchymal cells by SUVs suppresses sterol-responsive messages (Figures 5, 6, & 8). Delivery of cholesterol to Kupffer cells can be followed by gradual transfer of lipid to parenchymal cells, for example, via the extensions of Kupffer cells that reach down through the space of Disse to make physical contact with parenchymal cells. The rate of sterol delivery to the parenchymal

cells by transfer from Kupffer cells can be slower than by direct uptake of liposomes by parenchymal cells; the chemical form of the sterol may be altered by the Kupffer cells before transfer; there is other cell-cell communication; and, based on other pathways for lipid transfer amongst liver cells, the process of transfer from Kupffer to parenchymal cells may be regulated, whereas SUV clearance does not appear to be.

The second contributing explanation for the difference in metabolic response to LUVs *versus* SUVs is based solely on differences in the kinetics of their delivery of cholesterol to the liver. LUVs are cleared from plasma somewhat more slowly than are SUVs, and thereby produce a relatively constant delivery of cholesterol mass to the liver from the time of injection until the bulk of injected material is cleared. SUVs are cleared more rapidly, thereby delivering a large bolus of cholesterol mass to the liver several hours after each injection, which is followed by the sustained rise in plasma concentrations of cholesterol ester and atherogenic lipoproteins. The slow, steady delivery by LUVs avoids disrupting hepatic cholesterol homeostasis, while the more rapid uptake of SUV cholesterol overwhelms the ability of the liver to maintain homeostasis, thereby provoking suppression of hepatic LDL receptors. Other methods to deliver artificial particles or their components to the liver at a proper rate are also available, such as by changing the particle structure or composition, including charge and specific ligand for cell-specific binding.

The third contributing explanation is based on the striking quantitative difference in protein adsorption between the two types of vesicles (Figure 28), which, in that particular experiment, was a result of their distinct surface curvatures. Thus, SUVs, but not LUVs, would avidly strip apoE from VLDL, thereby showing its clearance from plasma and

favoring its conversion to LDL. SUVs that acquire apoE will compete with VLDL, LDL, and other particles for receptor mediated uptake by the liver. Also, adsorbed apoproteins can play a role in directing phospholipid vesicles to different hepatic metabolic pools. Other methods to reduce protein uptake by artificial particles are also available, such as by changing the particle structure or composition, including charge and specific ligands for cell-specific binding.

Overall, given the observation that cholesterol ester and LDL concentrations do not increase after delivery of large amounts of cholesterol and other exchangeable material to the liver by LUVs, it was apparent that delivery was to a specific metabolic pool or pools with unique properties that do not increase plasma concentrations of atherogenic lipoproteins or harmfully disturb hepatic cholesterol homeostasis, including the regulation of genes and other functions. Thus, these inventions can be regarded in part as a unique delivery system that brings original particle components, such as phospholipid, plus material acquired by the particles, such as cholesterol, to a specific delivery site for harmless disposal and other additional benefits. The delivery system with these characteristics will be useful in any situation whatsoever in which control of hepatic cholesterol homeostasis, hepatic phospholipid homeostasis, and hepatic metabolism in general is advantageous.

For example, in a situation in which it is desirable to modify erythrocyte lipids, a straightforward approach would be to administer artificial particles that can donate and remove the appropriate lipids. If SUVs are used for this purpose, however, they will transport cholesterol and other material to the liver in a harmful manner, to the wrong pool

and/or at the wrong rate, and this will cause increases in plasma concentrations of atherogenic lipoproteins, which is an undesirable side-effect that would preclude this approach. In contrast, the use of large liposomes or other particles with similar properties will result in the proper delivery of original and acquired material, to the proper pool(s) at a proper rate, so that the desired effect (modification of erythrocyte lipids) can be achieved without harmful increases in plasma concentrations of atherogenic lipoproteins.

As another example, it can be desirable to modify infectious agents, such as bacteria, fungi, and viruses, using the compositions and method described herein. Administration of large liposomes or other particles with similar properties will remove and donate exchangeable materials to and from these infectious agents, and then the administered particles will be delivered to the proper pool(s), so that the desired effect can be achieved without harmful increases in plasma concentrations of atherogenic lipoproteins.

It is understood, by way of example, that said modifications of said infectious agents will reduce their virulence, invasiveness, infectivity, transmissibility, reproduction, and/or resistance to the immune system.

As another example, a valuable therapy may provoke an increase in plasma concentrations of atherogenic lipoproteins as an unwanted side-effect. Administration of large liposomes or other particles with similar properties will alter this response through the delivery of lipids and other material to the proper hepatic metabolic pool. The data with the "Mix" animal provides a specific example of this effect (Figure 4).

There are several mechanisms for affecting arterial uptake, accumulation, and retention of lipoproteins. Liposomes can pick up apoE from atherogenic lipoproteins,

thereby reducing lipoprotein binding to arterial cells and also competing for binding to arterial cells. Finally, alterations in LDL size and/or composition affect its binding to extracellular matrix and affect subsequent, harmful alterations within the arterial wall, for example, susceptibility to oxidation or enzymatic modifications.

The action or mode of operation of large acceptors, such as large liposomes, can be aided by small acceptors, and *vice-versa*, and this applies to both endogenous (*e.g.*, HDL) and exogenous (*e.g.*, apoprotein-phospholipid complexes) small acceptors. Large acceptors penetrate poorly into the interstitial space and appear to inefficiently approach the cell surface under certain circumstances. These effects impede their uptake and donation of exchangeable material from membranes, cells, tissues, organs, and extracellular regions and structures. Small acceptors do penetrate well into the interstitial space and are able to approach the cell surface, thereby allowing efficient uptake of exchangeable material. Small acceptors have major disadvantages, however. They have a very limited capacity to acquire or donate material (even though the initial rate of acquisition or donation is rapid, until their capacity becomes saturated) and, once they have acquired material, they deliver it to the liver in a way that disrupts hepatic cholesterol homeostasis.

Large acceptors and small acceptors together, however, synergistically overcome each other's drawbacks through at least three mechanisms. First, the large acceptors act as a sink (or supply) for exchangeable material, while the small acceptors act as a shuttle that siphons material from peripheral stores to the large acceptors and in the other direction. Thus, for example, the small acceptors penetrate tissue, acquire (and/or donate) material from the tissue, and their capacity becomes at least partly saturated. They leave the tissue

and encounter the large acceptors in the plasma, at which point the small acceptors are stripped of tissue lipids. The capacity of the small acceptors is thereby restored, so that when they return to the tissue, they can acquire (and/or donate) more material. This cycle can continue many times. Second, the large acceptors can re-model some small acceptors. For example, large acceptors can donate phospholipid to HDL, which increases the capacity of HDL acquire tissue cholesterol and other material. Third, as noted elsewhere, the presence of large acceptors can block or reduce the harmful disruptions in hepatic cholesterol homeostasis caused by the small acceptors.

Large liposomes avoid raising plasma concentrations of atherogenic lipoproteins in general, not just LDL. This list includes all lipoproteins that contain apolipoprotein B (apoB), such as LDL, IDL, VLDL, Lp(a), β -VLDL, and remnant lipoproteins.

Immune cells are also the targets for depletion using the methods and modes of operation disclosed herein. It is understood that administration of an HMG-CoA reductase inhibitor, pravastatin, to cardiac transplant recipients reduced their natural-killer-cell cytotoxicity *in vitro*, reduced episodes of rejection accompanied by hemodynamic compromise, reduced coronary vasculopathy, reduced plasma LDL levels (and increased HDL levels), and significantly enhanced one-year survival. The effect on survival was dramatic: in the control group, 22% died in the first year, whereas only 6% died in the pravastatin-treated group.

Immunologic effects of HMG-CoA reductase inhibitors have been reported *in vitro*. These reported immunologic effects include the regulation of DNA in cycling cells, the inhibition of chemotaxis by monocytes, the regulation of natural-killer-cell cytotoxicity, and

the inhibition of antibody-dependent cellular cytotoxicity. Regulation of such inhibitors results from changes in circulating lipids or other effects and by utilization of the methods and modes of operation disclosed herein.

HMG-CoA reductase catalyzes an early step in cholesterol biosynthesis and is crucial in the synthesis of molecules besides cholesterol. Adding cholesterol to immune cells treated with HMG-CoA reductase inhibitors does not restore function, although the addition of mevalonate does. Although this suggests that cholesterol depletion is not directly responsible for the immune effects, the use of liposomes or other acceptors to remove cholesterol from cells increases endogenous consumption of mevalonate, as the cells try to make more cholesterol. To impede the ability of the immune or other cells to make up their cholesterol loss by picking up more LDL or other lipoproteins, the methods and treatment described herein are also be done in conjunction with therapies to lower plasma cholesterol concentrations (including HMG-CoA reductase inhibitors, fibric acids, niacin, bile acid binders, LDL-pheresis, etc.).

These processes include enhancement of cholesterol removal and reduction of cholesterol influx. Levels of HDL, the apparent natural mediator of cholesterol removal from peripheral cells, increased in a treated group of patients, and LDL levels were decreased. The administration of HMG-CoA reductase inhibitors *in vivo* usually causes very tiny changes in reductase enzyme activity: cells simply make more enzyme to overcome the presence of the inhibitor. They also make more LDL receptors (especially in the liver) and so LDL levels fall.

The invention further provides for additives to PD (peritoneal dialysis solutions) that reduce the accelerated atherosclerosis that occurs in renal failure. The invention further provides therapy for vasospastic disorders, by way of example, Raynaud's phenomenon, and associated syndromes, and Prinzmetal's angina and associated syndromes. The invention also provides therapy for a hyper-coagulable state, by way of example, TTP, other platelet disorders, DIC, so called anti-phospholipid antibody syndromes, a protein C abnormality, a protein S abnormality, factor V-Leiden, Livedoid vasculitis, lipodermatosclerosis, and related or associated syndromes.

Chemotaxis of monocytes is an important early event in atherial disorders: monocytes become attracted to abnormal arterial lipid deposits, and to cellular products made in response to the presence of these deposits, enter the vessel wall, transform into macrophages. Thus, inhibition of monocyte chemotaxis and/or chemotaxis of other inflammatory cells can be accomplished using the methods disclosed herein. Both cellular and humoral immunity seem to be affected by reductase inhibition: cardiac rejection accompanied by hemodynamic compromise has often been associated with humoral rejection (i.e., that occurring without producing marked lymphocytic infiltration in endomyocardial-biopsyspecimens).

Pravastatin may interact with cyclosporine [an important immunosuppressive drug], which blocks the synthesis of interleukin-2 in stimulated T-lymphocytes. The addition of interleukin-2 restored the natural-killer-cell cytotoxicity and partly restored the antibody-dependent cytotoxicity that were inhibited in lovastatin-treated in vitro cell cultures. A synergy between cyclosporine and pravastatin explains increased immunosuppression in

recipients of cardiac transplants, whereas patients without transplants who receive HMG-CoA reductase inhibitors for hypercholesterolemia do not have clinical immunosuppression.

Thus, the use of safe cholesterol acceptors with other immunosuppressives, such as cyclosporine &/or glucocorticoids (which can also suppress IL-2) is also contemplated by this invention.

It is also appreciated that the invention utilizes derivatives of various compounds described herein.

Pathological specimens from patients with cardiac transplants who have severe coronary vasculopathy have been reported to have a high cholesterol content. Therefore, early cholesterol lowering with pravastatin may play a part in decreasing the incorporation of cholesterol into the coronary arteries of the donor heart. Large liposomes or other cholesterol acceptors are used to accomplish the same effect, quickly and directly, alone or in combination, therewith.

Immune modulations is important in many conditions, not just cardiac transplantation. Areas in which the above approaches could be used also include transplantations of other organs, autoimmune diseases (in which the body's immune system mistakenly attacks the body's own tissues), some infections (in which the immune reaction becomes harmful), and any other situation in which immune modulation would be helpful.

With respect to infections, modification of the lipid content and composition of foreign objects in the body (such as infectious agents) while maintaining normal hepatic cholesterol homeostasis should also be mentioned.

Oxidized lipids alter tissue function and cause damage, including decreased EDRF, and increased adhesion molecules, cell damage, and macrophage chemotaxis.

There are interactions between LUVs and small acceptors, such as HDL, apoprotein phospholipid complexes, and cyclodextrins. Liposomes remodel HDL into a better acceptor by donating extra phospholipid, and the small acceptors act as a shuttle, carrying cholesterol efficiently from cells to liposomes. LUVs do not elevate LDL concentrations and do not suppress hepatic LDL receptor gene expression. The medical utility for LUVs includes restoring EDRF secretion by endothelial cells. High cholesterol levels inhibit endothelial release of EDRF not through cholesterol, but through an oxidized derivative of cholesterol. Because HDL itself restores EDRF release, perhaps through the removal of cholesterol or of oxidized lipids, then liposomes would be able to do the same (the HDL ferries cholesterol and/or oxidized lipids to liposomes, for example).

The invention provides a method and mode of operation for modifying cellular lipids, including oxidized lipids, without provoking a rise in LDL concentrations or harmfully disturbing hepatic homeostasis. Thus, the LUVs, presumably acting in concert with endogenous (or exogenous) small acceptors of cholesterol (such as HDL), pull oxidized lipids out of peripheral tissues and deliver them to the liver for disposal. Oxidized lipids have a wide range of harmful biological effects, including suppression of EDRF release, induction of cell adhesion molecules, cellular damage, chemotaxis of macrophages, and so forth. As induced are an inflammatory cytokine, a growth factor, a lipolytic enzymes, a proteolytic enzyme, and/or nuclear factor kappa B (NF-kB), any of which is modulated by the liposomes described herein.

Oxidized lipids and their harmful effects include decrease endothelial C-type ANF; increased endothelial PAI-1 and decreased tPA and decreased endothelial thrombomodulin. Liposomes enhance or participate in this effect. These changes impair the body's ability to dissolve clots. The methods disclosed herein assist in ameliorating these harmful effects of oxidized lipids. HDL acts in part by transporting enzymes that inactivate biologically active oxidized lipids.

It is understood that oxidized LDL inhibits endothelial secretion of C-type natriuretic peptide (CNP). It is the lipid component of oxidized LDL that mediates this effect. Most importantly, HDL blocks the action of oxidized LDL, presumably by picking up oxidized lipids (e.g., oxidized cholesterol). Coincubation with high-density lipoprotein (HDL), which alone had no effect on CNP release, significantly prevented Ox-LDL-induced inhibition of CNP secretion by endothelial cells (ECs). Analysis by thin-layer chromatography demonstrated that oxysterols, including 7-ketocholesterol, in Ox-LDL were transferred from Ox-LDL to HDL during coincubation of these two lipoproteins. These results indicate that Ox-LDL suppresses CNP secretion from ECs by 7-ketocholesterol or other transferable hydrophilic lipids in Ox-LDL, and the suppressive effect of Ox-LDL is reversed by HDL.

Whatever molecule HDL picks up, the presence of liposomes or other acceptors around as described herein will allow it to do a better job, because of remodeling of HDL by liposomes & shuttling of oxidized lipids by HDL from tissues to liposomes (i.e., the liposomes continuously strip the HDL). Liposomes with an exogenous small acceptor will also work.

It is further understood that transferable lipids in oxidized low-density lipoprotein stimulate plasminogen activator inhibitor-1 and inhibit tissue-type plasminogen activator release from endothelial cells. As above, it is the lipids in oxidized LDL, such as oxidized forms of cholesterol, that produce the effect. It is understood that oxidized low density lipoprotein reduced thrombomodulin transcription in cultured human endothelial cells. It is appreciated that oxidized lipids play a role in atherosclerosis, and enzymes on HDL that inactivate oxidized lipids may contribute to a protective effect. It is contemplated that the methods and compositions disclosed herein will help this proposed mechanism as well, for example, by removing end-products of these enzymes, by otherwise altering HDL, and by providing an additional platform for enzyme transport and action. By way of example, both paraoxonase and oxidized lipid become transferred onto liposomes, where inactivation of the oxidized material can then occur.

As such the use of large liposomes to remove harmful lipids in general (here, oxidized lipids) from peripheral tissues, either directly or via HDL, which would extract the lipids first, possibly inactivate them, then deliver them or their break-down products to liposomes in the circulation is described. Direct methods to assess oxidation and oxidative damage in vivo include for lipids, assays for 8-epiPGF₂α; for DNA, assess 8-oxo-2' deoxyguanosine; generally assess anti-oxidant enzymes in tissues; and assess anti-oxidants levels, such as vitamin E, vitamin C, urate, and reduced/oxidized glutathione.

Methods relating to and modes for effecting the reverse lipid transport, from cells, organs, & tissues, including transport of extracellular material, and any exchangeable material in general are described herein. This covers not just cholesterol, but also

sphingomyelin, oxidized lipids, lysophosphatidylcholine, proteins, and also phospholipid donation. Some effects of oxidized material include increased calcification in arterial cells as described above and below.

Three potential differences between large versus small liposome to explain their different effects on LDL and apoB levels include: fenestral penetration (LUV \ll SUV); rate of clearance (LUV $<$ SUV, so that LUVs produce a slow, sustained cholesterol delivery to the liver that may be less disruptive); and protein adsorption (LUV \ll SUV). It is understood that unilamellar vesicles provide some advantage over multilamellar vesicles for example, because inner bilayers of phospholipid are somewhat shielded and must rely on flip-flop and internal diffusion to acquire or donate exchangeable material from outside the particle.

Unesterified cholesterol increases tissue factor expression by macrophages. This is extremely important, because it is macrophage-derived tissue factor that makes the material released by unstable, rupturing plaques such a powerful stimulus for a clot to form that then blocks the vessel leading to a heart attack. The methods and modes of operation and compositions of the invention act upon the expression of tissue factor, through alteration in unesterified cholesterol and/or other relevant factors.

Poor absorption of proteins by large liposomes affects LDL levels and/or atherosclerosis by the following mechanisms: 1) acquisition of apoE from VLDL by small liposomes impairs the removal of VLDL from the circulation, thereby allowing it to be more efficiently converted into atherogenic LDL; ii) absorbed proteins on small liposomes direct these particles into the wrong metabolic pool within the liver. Polyacrylamide gel

electrophoresis shows that liposomes (actually small liposomes) increase the size of LDL. Liposomes are used to alter LDL size, composition and structure to decrease its atherogenicity.

Other properties of LDL could be changed by administration of liposomes. For example, liposomes reduce surface unesterified cholesterol; reduce surface sphingomyelin; replace surface phospholipids with POPC which is poorly oxidized; supplement the LDL with antioxidants that were added to the liposomes before administration. These changes would substantially alter arterial entry, retention, modification and atherogenicity of LDL.

The side-effects controlled are focused on hepatic cholesterol metabolism, hepatic expression of genes involved in cholesterol metabolism, and plasma concentrations of cholesterol-rich atherogenic lipoproteins that contain apolipoprotein B (chiefly, LDL). Reverse transport of sphingomyelin, for example, changes hepatic cholesterol metabolism (cellular sphingomyelin affects the intracellular distribution of cholesterol, and hence its regulatory effects; also sphingomyelin is a precursor to ceramide, which mediates intracellular signaling), though large liposomes appear to avoid any problems in the area. The same holds true for reverse transport of oxidized forms of cholesterol (they are even more potent than unoxidized cholesterol in suppressing LDL receptor gene expression). Cyclodextrins do not pick up phospholipids.

Liposomes pick up any exchangeable lipid (actually, any exchangeable amphipathic or hydrophobic material, which includes lipid or protein or anything else with these characteristics). This includes sphingomyelin, oxidized or modified lipids, such as oxidized sterols and phospholipids. Typically, such liposomes can pick up unesterified cholesterol

and other exchangeable material from other lipid bilayers, such as cell membranes, and from lipoproteins. Liposomes also pick up proteins and donate phospholipids. By way of example, liposomes lower the SM:PC ratio in lipoproteins, including atherogenic lipoproteins thereby reducing their atherogenicity. During and after these modifications of cell membranes, lipoproteins, etc., the liposomes are removed from the plasma, chiefly by the liver. Throughout this application, we will refer to this general process as "reverse lipid transport", although it is understood that any exchangeable material in tissues, blood, the extracellular milieu, or liposomes could participate. Specific examples of exchangeable material include unesterified cholesterol, oxidized forms of cholesterol, sphingomyelin, and other hydrophobic or amphipathic material.

These molecules accumulate in vascular dysfunction and mediate harmful effects (e.g., cholesterol, oxidized cholesterol, sphingomyelin, and other material, such as lysophospholipids) or in aging (e.g. sphingomyelin). For example, oxidized lipids, particularly sterols, alter many peripheral tissue functions, including stimulating calcification by arterial cells in atherosclerosis & stimulating endothelial plasminogen activator inhibitor-1 release by endothelial cells; other oxidized lipid products include lysophospholipids that stimulate endothelial expression of adhesion molecules that attract macrophages into lesions, and sphingomyelin accumulates in some cell-culture models of aging and, with cholesterol, may account for some of the cellular changes. Other changes, such as oxidation, may also mediate or accelerate aging. Many of these molecules have been shown to be picked up by liposomes in vitro (e.g., cholesterol, sphingomyelin, & probably oxidized cholesterol) and many by HDL (cholesterol, oxidized cholesterol,

oxidized lipids) but it is likely that they pick up these other molecules as well. In terms of total mass, however, the bulk of the acquired material is unesterified cholesterol, with proteins in second place. Alternatively, by acquiring unesterified cholesterol, the liposomes may reduce the amount of oxidized cholesterol that develops, because there will be less starting material.

The effective periods of time described herein should not be interpreted to exclude very long courses of treatment, lasting years, for example. Nor should it exclude repeated courses of treatment separated by weeks, months, or years.

Side effects include overload of the liver with cholesterol or other materials acquired by the liposomes; with subsequent alterations in hepatic function, such as suppression of LDL receptors, stimulation of intrahepatic cholesterol esterification, stimulation of hepatic secretion of atherogenic lipoproteins that contain apolipoprotein-B, and impaired uptake of atherogenic lipoproteins by the liver from plasma.

As used herein the word, "endogenous" indicates that the HDL arises from within the body, and is not itself administered. HDL and related acceptors can, however, be administered.

The data indicate another difference between large and small liposomes in vivo. Before injection, the liposomes that are used in our experiments were essentially electrically neutral, indicated by a failure to migrate rapidly through a gel of agarose when an electric field is applied. (This does not imply that charged liposomes or other particles could not be used. The small liposomes pick up proteins and other material, and become electrically charged: they now rapidly migrate through agarose gels when an electric field is applied.

Agarose gels of plasma samples we had obtained from the three groups of rabbits were run. The small liposomes became more mobile in these gels. The large liposomes remained substantially less mobile, indicating a lower charge density, reflecting a lower protein content.

Two explanations for the difference between large and small liposomes exist: 1) small ones penetrate through hepatic endothelial fenestrae while large ones do not (thus, large ones go to Kupffer cells and small ones go to hepatic parenchymal cells and cause problems); 2) large liposomes are known to be cleared by the liver somewhat more slowly than are small liposomes (the reason is not known), and so may not overwhelm the liver as easily. The data on charge density provides an explanation in part: less protein, therefore slower or altered hepatic uptake.

The delivery of cholesterol to the liver by LUVs is actually more efficient than by SUVs, per mg of phospholipid. One difference is that the delivery by LUVs is steady over a long period after the injection, whereas the delivery by SUVs peaks then falls.

Some of the composition described herein include egg phosphatidylcholine; synthetic phosphatidylcholines that are not crystalline at body temperature (e.g., they contain at least one double bond) yet are resistant to oxidation (e.g., they do not have many double bonds, such as 1-palmitoyl, 2-oleoyl phosphatidylcholine, abbreviated POPC); other natural or synthetic phospholipids alone or in mixtures; any of the preceding supplemented or replaced with hydrophobic or amphipathic material that still allows a liposomal or micellar structure. An extruder is certainly not the only conceivable method for making large liposomes or even particularly LUVs. Other methods known to practitioners in the

field are available or can be adapted to make large liposomes in general and LUVs in particular. It is understood that differences in the starting lipids for manufacturing liposomes will often require modification in the details of manufacture, to obtain particles of a desired size, lamellarity, and other characteristics for these applications. It is also understood that the movement of cholesterol and other exchangeable molecules into or out of the inner bilayers of multilamellar or pauci-lamellar vesicles is not instantaneous, and so unilamellar or pauci-lamellar vesicles will be a preferred formulation.

As used herein, a dose includes from 10 to 1600 mg of phospholipid, in the form of large liposomes, per kg of body weight. Other acceptable rates and doses described herein can be determined empirically by the response of plasma LDL concentrations, lipid mobilization, and biologic responses, such as endothelial function, organ perfusion and/or function, and coronary or cerebral events.

Where there is a change in membrane composition, as well as function, one can use an assay of membrane composition or an assay of tissue composition. Compositional assays should include lipids, proteins, and other components.

HDL can pick up oxidized material, and HDL-associated enzymes may inactivate oxidized material. Transfer of oxidized material to liposomes will allow disposal as the liposomes are cleared from the circulation, and by enzymes that inactivate oxidized material and that also move onto the liposomes, such as paraoxonase.

The separations in time will depend on the actual dose of material, its effects on hepatic cholesterol homeostasis, and whether cholesterol-lowering agents are being concurrently administered. Thus, for doses of about 300 mg of small liposomes per kg of

body weight, slight disruptions will occur after even a single dose, and single administrations of higher doses may cause even more disruptions. Exemplary separations in time include one day to one month, but the precise schedules would have to be determined by monitoring hepatic cholesterol metabolism and plasma levels of LDL and other atherogenic lipoproteins.

The major macrophages that would be involved in liposomal clearance would be Kupffer cells in the liver and macrophages in the bone marrow or spleen. The catabolism here would be the so-called alternative pathway for initiating the conversion of cholesterol into bile acids (macrophages are known to have at least one cholesterol-catabolizing enzyme), or would be transfer of sterol (enzymatically altered or not) to other cells, such as hepatic parenchymal cells that would then dispose of the molecules, including but not limited to, direct secretion of cholesterol, and/or phospholipid into bile and the classical pathway of bile acid synthesis.

The methods described herein also control effects of cellular aging.

The invention includes means for assessing the efficacy of liposomal therapy by performing assays of oxidation in vitro and in vivo, assays of oxidative susceptibility of plasma components, and assays of the ability of altered HDL to inhibit oxidation (by binding oxidative products and/or through its paraoxonase or other anti-oxidant components), and the ability of HDL or plasma or serum or blood to mobilize cholesterol and other exchangeable material.

Large liposomes may cause the mobilization of some material that is trapped between cells as well (this is the extracellular space). This extracellular material causes

problems a) when it contacts cells or platelets, altering their function and b) by simply taking up space.

Rates of cholesterol mobilization can be empirically determined. It is appreciated that the kinetics of liposomal clearance is different in different species (the $t_{1/2}$ of LUVs in mice is about 8h, but in rabbits it is about 27 hours, and in humans it is longer). Thus, rates calculated may vary from species to species. Based on data on injection of 300mg of SUVs into rabbits, the peak rate of liposomal cholesterol removal from plasma was between 3h and 6h after the injection. At that point, the liposomes had raised plasma unesterified cholesterol by just over 2mmol/L; assuming a total plasma volume of 90mL in a 3-kg rabbit, the total liposomal cholesterol at that point was 180 μ moles; the $t_{1/2}$ for SUVs in these rabbits was about 20 hours, so roughly 10% is removed in 3h; thus, the peak rate of liposomal cholesterol removal was about 2 μ moles/h/kg, and this caused a subsequent rise in plasma cholesterol ester concentrations. Notice that at other time periods after the injection, the rate of liposomal cholesterol removal from plasma was less. Note also that the liver is the predominant organ for clearance, but not the sole organ for clearance.

It has been calculated that a single injection of 300 mg LUVs/kg into 20-22-g mice mobilized about 2400 nmoles of cholesterol in the first 24h after injection. In contrast to the data with SUVs in rabbits, the mobilization of cholesterol during the first 24h in the mice injected with LUVs was quite steady. This calculates to about 4.7 μ moles/h/kg over this first 24-h period, which is actually more than the above figure of 2 μ moles/h/kg, which was a peak rate. It is not a fair comparison, because the clearance of LUVs in mice is three times as fast as in rabbits. If we take 4.7 divided by 3, we get 1.6 μ moles/h/kg, which is

less than 2, but these are imperfect estimates. Human rates can be empirically determined. It is clear, however, that LUVs deliver their cholesterol at a steady rate, whereas SUVs make a brief, rapid push of lipid into the liver.

At body temperature, the most desirable liposomes are fluid within the confines of the bilayer, which is called the liquid crystalline state. Less desirable are liposomes in the gel state, which is less fluid.

It is understood that unesterified cholesterol stimulates macrophages to express more tissue factor, a substance known to provoke blood clots. This explains the presence of abundant tissue factor in rupture-prone plaques, which, when they rupture, expose tissue factor to plasma and provoke a clot that can occlude the vessel, causing a heart attack. This would be another example of an abnormal cellular function that may be reversed by removal of cholesterol by liposomes.

Several human conditions are characterized by distinctive lipid compositions of tissues, cells, membranes and/or extracellular regions. For example, in atherosclerosis, cholesterol (unesterified, esterified, and oxidized forms) and other lipids accumulated in cells and in extracellular areas of the arterial wall and elsewhere. These lipids have potentially harmful biologic effects, for example, by changing cellular functions and by narrowing the vessel lumen, obstructing the flow of blood. Removal of the lipids would provide numerous, substantial benefits. Moreover, cells, membranes, tissues and extracellular structures would benefit from composition and alteration that include increasing resistance to oxidation and oxidative damages, such as by increasing the content and types of anti-oxidants, removing oxidized material, and increasing the content of

material that is resistant to oxidation. In aging, cells have been shown to accumulate sphingomyelin and cholesterol, which alter cellular functions. These functions can be restored *in vitro* by removal of these lipids and replacement with phospholipid from liposomes. A major obstacle to performing similar lipid alterations *in vivo* has been disposition of the lipids mobilized from tissues, cells, extracellular areas, and membranes. Natural (*e.g.*, high-density lipoproteins) and synthetic (*e.g.*, small liposomes) particles that could mobilize peripheral tissue lipids have a substantial disadvantage: they deliver their lipids to the liver in a manner that disturbs hepatic cholesterol homeostasis, resulting in elevations in plasma concentrations of harmful lipoproteins, such as low-density lipoprotein (LDL), a major atherogenic lipoprotein.

The invention described herein provides methods and compositions related to the "reverse" transport of cholesterol and other materials and compounds from peripheral tissues to the liver *in vivo* while controlling plasma LDL concentration.

Agarose gel electrophoreses of plasma samples from the last a set of rabbits injected with LUVs, SUVs, or saline (these agarose gels separate particles by their charge, which is not the same from one type of particle to another) were performed. Freshly made SUVs migrate very slowly through agarose, which indicates that freshly made liposomes have very little charge. After injection into animals or after co-incubation with plasma or lipoproteins, SUVs pick up proteins from lipoproteins. These proteins give more charge to the SUVs and substantially enhance their migration through agarose gels. SUVs after exposure to plasma migrate faster through these gels than does LDL.

The gels showed a substantial difference between LUVs and SUVs. As expected, the SUVs migrated ahead of LDL in these gels. The LUVs, however, migrated almost exactly where freshly made, protein-free liposomes migrate. This result indicates that LUVs, unlike SUVs, do not readily pick up proteins from circulating lipoproteins.

There is a direct verification of this difference between the liposomes. Human HDL (which has most of the proteins that liposomes pick up) was incubated with either LUVs or SUVs, then the liposomes were reisolated, and assayed their protein-to-phospholipid ratios. Per amount of liposomal phospholipid, the SUVs picked up about 40 times as much protein as did the LUVs. This difference appears to arise because of the difference in surface curvature: SUVs are smaller, so their surface is more tightly curved, thus under greater strain, and so proteins can more easily insert.

There are two most likely metabolic effects of the difference in protein uptake between the two types of liposomes are as follows:

1. VLDL has two metabolic fates: it can be removed from plasma before it is fully converted to LDL by lipolytic enzymes, or it can be fully converted into circulating LDL. SUVs strip apoE off VLDL, thereby slowing its clearance from plasma and favoring its conversion to LDL. In contrast, LUVs leave apoE on VLDL, and so LDL concentrations in plasma would not rise.
2. Absorbed apoproteins might play a role in directing liposomes to different hepatic metabolic pools, and/or at different rates.

Here are some ways to assay effects on oxidation in vivo: Catella F, Reilly MP, Delanty N, Lawson JA, Moran N, Meagher E, FitzGerald GA. Physiological formation of

8-epi-PGF₂ alpha in vivo is not affected by cyclooxygenase inhibition. Adv Prostaglandin Thromboxane Leukot Res. 23:233-236, 1995. These authors describes 8-epi-PGF₂alpha, which is an end-product of lipid oxidation. This molecule can be used, they suggest, as a measure of lipid oxidative flux in an animal. It is superior to other commonly used measure of oxidation in vivo, such as anti-oxidant levels (which are affected by diet), thiobaritric acid reactive substances (some sugars interfere with this assay), and short-lived oxidative intermediates (these do not indicate total flux of material being oxidized). Administration of LUVs, by removing oxidized lipids from the periphery, would lower total oxidative flux in vivo, and 8-epi-PGF₂alpha would be a suitable way to measure this; Cadet J, Ravanat JL, Buchko GW, Yeo HC, Ames BN. Singlet oxygen DNA damage: chromatographic and mass spectrometric analysis of damage products. Methods Enzymol. 234:79-88, 1994. they describe 8-oxo-2'-deoxyguanosine, which is an end-product of DNA oxidation. As above, this molecule can be used as a measure of DNA oxidative flux in an animal. Administration of LUVs would lower DNA oxidative flux in vivo, and this is a suitable way to measure this; and, Xia E, Rao G, Van Remmen H, Heydari AR, Richardson A. Activities of antioxidant enzymes in various tissues of male Fischer 344 rats are altered by food restriction. J Nutr. 125(2):195-201, 1995. Antioxidant enzymes in tissues were measured, to indicate de-oxidant capacity. LUVs help this. Anti-oxidant levels (vitamin E, ascorbate, urate); oxidized and reduced glutathione; and many other measures can be used to assess peripheral oxidation and oxidative damage. Again, these and other measures would be coupled with LUV administration, to assess efficacy of the therapy.

Other particles that mimic the properties of large liposomes will act similarly, to mobilize peripheral lipids and other exchangeable materials, and deliver exchangeable materials, while avoiding harmful disruptions in hepatic cholesterol homeostasis. For example, these would include emulsion particles that are too large to penetrate hepatic endothelial fenestrae, of a composition and structure that is taken up by the liver slowly, and/or a composition and structure that does not readily acquire specific endogenous proteins. Such emulsions could be made with or without proteins, and could be made from phospholipid and a neutral lipid, such as triglycerides or another neutral lipid.

The invention also provides a pharmaceutical composition comprised or consisting essentially of liposomes dimensioned and of a composition so that the liposomes are taken up slowly by the liver.

The invention also includes a method of forcing the reverse transport of cholesterol from peripheral tissues to the liver *in vivo* while controlling plasma LDL concentrations comprising the step of parenterally administering a therapeutically effective amount of a multiplicity of large liposomes comprised of phospholipids substantially free of sterol for a treatment period, whereby the liposomes pick-up the cholesterol during the treatment period. The method includes the optional step of enhancing tissue penetration of a cholesterol acceptor and increasing extraction of tissue cholesterol and other exchangeable material by co-administration of an effective amount of a compound. The compound is selected from the group consisting of a small acceptor of cholesterol and a drug that increases endogenous small acceptors of cholesterol. In a variant, co-administration of the compound is simultaneous with the parenteral administration of the large liposomes. In

another variant, co-administration of the compound is separated in time from the parenteral administration of the therapeutically effective amount of a multiplicity of the large liposomes by an effective time period. The effective time period is in the range of about 1 minute to about two weeks.

In another aspect the invention includes an improved method of reducing the lipid content of arterial lesions comprising the steps of inducing the reverse transport of cholesterol from peripheral tissues to the liver *in vivo* by administering a therapeutically effective amount of an agent to a subject. The agent is selected from the group consisting of large liposomes comprised of phospholipids substantially free of sterol and small acceptors; periodically monitoring plasma LDL concentrations of the subject to obtain an LDL concentration profile; adjusting the therapeutically effective amount of the agent responsive to the LDL concentration profile; and, administering a pharmaceutical agent to the subject. The agent is selected from the group consisting of compounds to lower LDL concentrations, small acceptors, and compounds to raise HDL concentrations, responsive to the LDL concentration profile, whereby the reduction in lipid content of the arterial lesions is effectively treated and monitored over a treatment period. The arterial lesions comprise lipid rich, rupture prone, type IV and type V arterial lesions. Plaque rupture, thrombosis, and tissue infarction are greatly reduced.

In yet another aspect the invention provides for an improved method of assessing the efficiency of a treatment for reducing the lipid content of arterial lesions. the lesions coming into contact with plasma and a component thereof comprising the steps of inducing the reverse transport of cholesterol from peripheral tissues to the liver *in vivo* by

administering a therapeutically effective amount of an agent to a subject. The agent is selected from the group consisting of large liposomes comprised of phospholipids substantially free of sterol and small acceptors; and, periodically monitoring the plasma component with an assay. The assay is selected from the group consisting of an assay for plasma unesterified cholesterol and phospholipid, an assay of bile acids and cholesterol in stool, an assay of bile acids and cholesterol in bile, an assay of hepatic gene expression in a liver biopsy, an assay of gene expression in peripheral blood leukocytes, the gene comprising a gene involved in cholesterol metabolism, an assay of plasma LDL concentration, and a vascular imaging technique. The vascular imaging technique is selected from the group consisting of cardiac catheterization, magnetic resonance imaging, ultrasound, ultrafast CT, a radionuclide assay which optionally includes a stress-thalium scan, any perfusion assay (such as PET scan), and any functional assay such as ECHO.

The invention also includes a method of beneficially altering arterial function, blood platelet function, and controlling plasma LDL concentrations and hepatic cholesterol homeostasis *in vivo* comprising the step of parenterally administering a therapeutically effective amount of a multiplicity of large liposomes comprised of phospholipids substantially free of sterol for a treatment period with or without administration of other agents. The other agents optionally include small acceptors and LDL lowering agents. Optionally the method includes the step of taking a measurement of arterial function. The measurement is selected from the group consisting of a measurement of blood flow, oxygen delivery, endothelial-derived relaxing factor, a measurement of intracellular calcium concentration in arterial cells, a measurement of arterial cell proliferation, an assay of

arterial enzymes, an assay in the presence of calcium channel blockers, an assay of arterial uptake, accumulation and retention of lipoproteins, an assay of arterial accumulation of liposomes, an assay of arterial retention of liposomes, an assay of gene products, and an assay of arterial cell functions. The measurement of endothelial-derived relaxing factor is selected from the group consisting of a functional determination of endothelial-dependent arterial relaxation, chemical determination of production of the endothelial relaxing factor, and an assay of nitric oxide synthase.

A method of beneficially altering blood platelet function while controlling plasma LDL concentrations, arterial function, hepatic cholesterol homeostasis and the platelet function *in vivo* is also included. The method comprises the step of parenterally administering a therapeutically effective amount of a multiplicity of large liposomes comprised of phospholipids substantially free of sterol for a treatment period, the liposomes administered with or without other agents. The method optionally includes the step of taking a measurement of arterial function. The measurement selected from the group consisting of a measurement of endothelial-derived relaxing factor, a measurement of intracellular calcium concentration in arterial cells, a measurement of arterial cell proliferation, an assay of arterial enzymes, and an assay of gene products. The measurement of endothelial relaxing factor is selected from the group consisting of a functional determination of endothelial-dependant arterial relaxation and chemical determination of production of the endothelial relaxing factor.

Also included is a method of catabolizing cholesterol with macrophages *in vivo* (such as hepatic macrophages), and also affecting a plasma component or structural aspects

of an artery, comprising the step of administering an effective amount of liposomes to a subject, the liposomes, are substantially free of cholesterol and being of a size and composition such that the liposomes are capable of being taken up by the macrophages and capable of being catabolized by the macrophages. The cholesterol is mobilized by the liposomes resulting in the liposomes being taken up by the macrophages and catabolized. The method also can include the step of periodically monitoring the plasma component with an assay. The assay is selected from the group consisting of an assay for plasma unesterified cholesterol and phospholipid, an assay of plasma cholesterol ester transfer protein activity, an assay of bile acids and cholesterol in stool, an assay of hepatic gene expression in a liver biopsy, an assay of gene expression in a peripheral blood leukocytes, the gene comprising a gene involved in cholesterol metabolism, an assay of plasma LDL concentration, and a vascular imaging technique.

In yet another aspect the invention includes a method of delivering a drug *in vivo* and avoiding harmful disruptions of hepatic cholesterol homeostasis, comprising the steps of entrapping the drug with an agent. The agent is selected from the group consisting of a cholesterol poor liposome, a cholesterol free liposome, an emulsion, a liposome primarily taken up slowly by hepatic parenchymal cells, an emulsion primarily taken up slowly by hepatic parenchymal cells. The agent is selected from the group consisting of an agent with a protein and an agent without protein to obtain an entrapped drug. The method also includes the step of administering a therapeutically effective amount of the entrapped drug for a treatment period. The step of administering comprises the step of slowly infusing the entrapped drug. In variants, the step of administering comprises the step of administering

small doses of the agent, appropriately separated in time, to avoid harmful disruptions in hepatic cholesterol homeostasis, and includes using low doses of the agent, whereby disrupting hepatic cholesterol homeostasis is avoided.

A method of controlling plasma LDL levels, hepatic cholesterol homeostasis, arterial enzymes, arterial function, and platelet function, and altering platelet hormone production is also provided. The method includes the step of parenterally administering a therapeutically effective amount of a multiplicity of large liposomes comprised of phospholipids substantially free of sterol for a treatment period. The effective amount is administered in a dosage and the dosage is selected from a single dose and repeated doses. The method optionally includes the step of diagnosing the efficacy of the administration by taking a measurement of the hormone production and regulating the effective amount in response to the measurement. The measurement of hormone production is an assay selected from the group consisting of an assay for thromboxanes, an assay for prostacyclines, an assay of prostaglandins, an assay for leukotrienes, and an assay for derivatives thereof.

In yet a further aspect the invention provides a method of increasing plasma HDL concentrations, while controlling plasma LDL levels, hepatic cholesterol homeostasis, and hepatic gene expression. The method comprises the step of parenterally administering a therapeutically effective amount of a first agent. The first agent comprising a multiplicity of small liposomes to raise HDL concentrations for a treatment period. The method then includes the step of co-administering a second agent. The second agent includes large liposomes comprised of phospholipids substantially free of sterol for a treatment period. The effective amount is administered in a dosage selected from a single dose and repeated

doses. The co-administration acts to prevent the small liposomes from stimulating harmful changes in hepatic cholesterol homeostasis and an increase in plasma LDL. In a variant, the first agent consists essentially of small liposomes and the second agent consists essentially of large liposomes. The method also includes the step of diagnosing the efficacy of the administration by taking a measurement of plasma HDL and LDL levels before, during and after the treatment period.

A method of controlling plasma LDL levels, and hepatic cholesterol homeostasis *in vivo* while altering cell membrane composition and function is also described herein. The method includes the step of parenterally administering a therapeutically effective amount of a multiplicity of large liposomes comprised of phospholipids substantially free of sterol for a treatment period. The effective amount administered in a dosage selected from a single dose and repeated doses. The method includes the step of co-administering a small acceptor selected from the group consisting of a small acceptor of cholesterol, an acceptor of sphingomyelin, an acceptor of lysophosphatidylcholine, and an acceptor of a lipid. The method can optionally include the step of diagnosing the efficacy of the administration by performing a measurement selected from the group consisting of a measurement of membrane fluidity, a measurement of transmembrane ion flux, the ions selected from the group consisting of calcium ions, sodium ions, and potassium ions, an assay of membrane fragility, and an assay of membrane function.

In a further embodiment, the invention includes a pharmaceutical composition for treating angina that enters the liver of a subject consisting essentially of liposomes selected from the group of uni-lamellar liposomes, multi-lamellar liposomes, combinations thereof

and derivatives thereof. The particles are selected from the group of particles substantially free of cholesterol and particles free of cholesterol.

Non-liposomal particles are selected from the group consisting of triglyceride-phospholipid emulsions. The emulsions include emulsions that are not taken up rapidly by hepatic parenchymal cells, emulsions that are not taken up to a large extent by parenchymal cells, and triglyceride-phospholipid-protein emulsions.

Also included in the invention is a pharmaceutical composition for reducing the size of arterial lesions that enters the liver of a subject consisting essentially of a drug entrapped within an agent. The agent is selected from the group consisting of a cholesterol poor liposome, a cholesterol free liposome, an emulsion, a liposome primarily taken up slowly by hepatic parenchymal cells, and an emulsion primarily taken up slowly by hepatic parenchymal cells. The agent is selected from the group consisting of an agent with a protein and an agent without protein.

The invention also provides for a pharmaceutical composition for increasing plasma HDL concentrations, while controlling plasma LDL levels, hepatic cholesterol homeostasis, and hepatic gene expression, comprising a first agent which comprises a multiplicity of small liposomes to raise HDL concentrations, and a second agent which comprises large liposomes comprised of phospholipids substantially free of sterol.

In yet another aspect a method of controlling cholesterol metabolism in hepatic parenchymal cells in a subject in vivo through cell-cell communication from Kupffer cells to the parenchymal cells is included. The method includes the steps of administering a liposome composition to the subject. The liposome composition is selected from the group

consisting of large unilamellar liposomes and large multilamellar liposomes. The liposomes have an average diameter of about 100-180 nanometers. The LDL levels in the subject do not increase. The method also includes the step of diagnosing the efficacy of the control of cholesterol metabolism by assaying an indicator in the subject. The indicator is selected from the group consisting of plasma LDL concentrations of the subject, hepatic gene expression of the subject, sterol excretion controlling cholesterol metabolism in hepatic parenchymal cells in the subject, and sterol excretion in bile of the subject; and adjusting the administration in response to the assay.

The present invention further provides a mode of operation of atherogenic lipoproteins, cellular structures, and extracellular structures that is altered by the compositions described herein through which beneficial physiological effects are obtained.

Diseases or conditions involving endothelial function or dysfunction in general are treatable using the methods disclosed herein. By way of example some of these conditions or diseases include hypertension, eclampsia, hyperviscosity syndromes, pre-eclampsia, and inflammation. Inflammation includes autoimmune and non-autoimmune conditions.

The methods of rapidly and substantially treating angina disclosed herein are operational owing to at least three synergistic beneficial effects of the liposomal treatments (e.g. using large "empty" phospholipid vesicles - "LEVs" - where "empty" refers to conventional terminology to indicate that encapsulated drugs are not essential.). These three beneficial effects include (1) amelioration of endothelial dysfunction, (2) amelioration of platelet hyper-reactivity, and (3) reduction in whole blood viscosity. All three of these are relatively rapid and substantial effects of the treatment. These effects are particularly

important where there are obstructive, fibrotic, lipid poor arterial lesions that are unlikely to rapidly or substantially disappear with alterations in lipid transport. In the case of the heart, the *in vivo* methods will help alleviate angina and its associated signs and symptoms, e.g. shortness of breath, reduced exercise tolerance, cardiac wall motion abnormalities, arrhythmias, and cardiac function in general. In the case of the brain, the treatments disclosed herein will help ameliorate transient ischemic attacks, and their associated signs and symptoms, e.g. neurologic dysfunction. In the case of the lower limbs, the treatments disclosed herein will improve claudication, and its associated signs and symptoms. Perfusion to and function of generative organs will also be assisted.

Intravenous routes of administration would also include co-administration with red blood cells and other blood products either pre-mixed ahead of time, co-administered simultaneously, or administered shortly before or shortly after administration of blood products (up to one week). Hence, the invention also contemplates use of the liposomes with blood transfusion products.

The approaches described herein can be used in conjunction with other therapies directed toward the arterial wall including vasodilators, agents that interfere with cell adhesion molecules, anti-inflammatory agents, agents that modify cytokines, antioxidant therapies, and inhibitors of arterial-wall enzymes, e.g., Acyl-CoA: cholesterol acyltransferase, lipases, myeloperoxidase, lipoxygenases, and phospholipases. It is contemplated that use of the liposomes herein will create synergistic effects with each of these compounds, others described herein, and therapies in part because liposomes act by a mechanism distinct from the mechanism used by these therapies.

Various cardiovascular agents are also used in the methods of the present invention. These agents include blood modifiers, anticoagulants, antiplatelet agents, thrombolytic agents, adrenergic blockers, adrenergic stimulants, alpha/beta adrenergic blockers, angiotensin converting enzyme (ACE) Inhibitors, e.g. Quinapril (Accupril®, Parke-Davis), Ramipril (Altace®, Hoechst), Captopril, Benazepril (Lotensin®, Novartis), Trandolapril (Mavik®, Knoll), Fosinopril (Monopril®, Bristol-Myers), Lisinopril (Prinivil®, Merck), Moexipril (Univasc®, Schwarz), Enalapril (Vasotec® tablets, Merck), Enalaprilat (Vasotec® i.v., Merck), Lisinopril (Zestril®, Zeneca), active metabolites thereof, and/or derivatives thereof.

ACE inhibitors with calcium channel blockers and ACE inhibitors with diuretics are also used with the present invention.

Angiotensin II Receptor Antagonists including selective AT-I subtype angiotensin II receptor antagonists are also used with the present invention, e.g. Candesartan cilexetil (Atacand®, Astra), Irbesartan (Avapro®, Bristol-Myers Squibb or Sanofi), Losartan (Cozaar®, Merck), Valsartan (Diovan™, Novartis), angiotensin II receptor antagonists with diuretics, active metabolites thereof, and/or derivatives thereof.

Group I-IV antiarrhythmics are also used in the present invention. Group I antiarrhythmics include, by way of example, Cardioquin™ (the generic name is quinidine), Ethmozine™, Mexitil™, Norpace™ (generic name is disopyramide), Procanbid™ (the generic name is procainamide), Quniaglute™, Quinidex™, Rythmol™, Tambacor™, and Tonocard™. Group II antiarrhythmics include, by way of example, Betapace™ (generic name is sotalol), Brevibloc™ (generic name is esmolol), Inderal™ (generic name is

propranolol), and Sectral™ (generic name is acebutolol). Group III antiarrhythmics include, by way of example, Betapace™, Cordarone™, Corvert™ and Pacerone™. Group IV antiarrhythmics include, by way of example, Calan™ (generic name is verapamil) and Cardizem™ (generic name is diltiazem). Miscellaneous antiarrhythmics used in the present invention include Adenocard (generic name is adenosine), Lanoxicaps™ (generic name is digoxin), and Lanoxin™ (generic name is digoxin).

Antilipidemic agents used in the present invention include Bile Acid Sequestrants, Fibric Acid Derivatives, HMG-CoA Reductase Inhibitors, and Nicotinic Acid.

Other agents used in the present invention include Beta Adrenergic Blocking Agents, Beta Adrenergic Blocking Agents with Diuretics, Calcium Channel Blockers, Diuretics, e.g. Carbonic Anhydrase Inhibitors, combination Diuretics, Loop Diuretics, Potassium-Sparing Diuretics and Thiazides & Related Diuretics, Hypertensive Emergency Agents, Inotropic Agents, Miscellaneous Cardiovascular Agents, e.g. Metyrosine (Demser®, Merck), Mecamylamine (Inversine®, Merck), Phentolamine (Regitine®, Novartis), Abciximab (Reopro®, Centocor & Lilly), Rauwolfia Derivatives and Combinations, Vasodilators, Coronary Vasodilators and Peripheral Vasodilators & Combinations, and Vasopressors.

The present invention described herein also provides methods of treatment of vascular dysfunction, including but not limited to dysfunction of resistance vessels, dysfunction of intramyocardial arterioles, dysfunction of conductance vessels, and dysfunction of epicardial coronary arteries.

The various anginal equivalents discussed herein (i.e., effects of transient myocardial ischemia besides classic angina pectoris, e.g. substernal discomfort: heaviness, pressure, squeezing, smothering, or choking) include, by way of example, disturbances of the mechanical, biochemical, and electrical function of the myocardium, failure of normal muscle relaxation and contraction, transient left ventricular failure (a classic sign of this is shortness of breath or reduced exercise tolerance), papillary muscle dysfunction (including mitral regurgitation, focal disturbances of ventricular contractility, causing, by way of example, segmental bulging or dyskinesia and/or greatly reduced efficiency of myocardial pump function, a wide range of abnormalities in myocardial cell metabolism, function, and structure, failure to oxidize fatty acids, conversion of glucose into lactate, leading to a drop in intracellular pH and myocardial stores of high-energy phosphates, adenosine triphosphate (ATP), and creatine phosphate, impaired cell membrane function, leading to potassium leakage and the uptake of sodium by myocytes, characteristic electrocardiographic changes such as repolarization abnormalities, as evidenced by inversion of the T wave and later by displacement of the ST segment, electrical instability, which may lead to ventricular tachycardia or ventricular fibrillation, sudden death as a result of ischemia-induced malignant ventricular arrhythmias, radiated pain to other areas, such as to the left shoulder, both arms, ulnar surfaces of the forearm and hand, the back, the neck, the jaw, the teeth, and/or the epigastrium.

The present invention also has beneficial effects in the treatment of conditions affecting the vascular anatomy, including by way of example, the vasa vasorum (vessels of the vessel), post capillary venules, venules, arterioles, capillaries, a cavernous sinus, an

artery, a vein, any vascular structure normally lined with endothelium, and/or any vascular structure normally lined with endothelium but that has become denuded.

It is understood that the invention disclosed herein also includes treatment for a wide range of conditions related to cholesterol metabolism, lipid metabolism, and/or aging. Additional exemplary conditions include cancer and predisposition to cancer, such as colon cancer, which may also be prevented with aspirin or related compounds an cholesterol synthesis inhibitors, and breast cancer; alopecia, including male-pattern baldness; cutaneous wrinkling, including prevention and reversal of wrinkling; canities, including premature graying; chemical or radiation toxicity, for example, from scavenging lipophilic toxins such as oxidative products; and a condition associated with a sign or symptom of accelerated aging. The treatments apply to human and non-human animals, including pets.

The treatments, compositions, and methods disclosed herein are also useful in the treatment of Tangier disease and associated conditions. It was recently discovery that Tangier disease, an inherited disorder in which patients have abnormally low levels of plasma high density lipoprotein cholesterol, accompanied by enlarged and yellowed tonsils and spleen, is associated with a defect in the gene that encodes for the protein ATP-cassette binding protein 1 (ABC1). ABC1 has been shown to bind intracellular cholesterol and transport it to the cell membrane receptors responsible for transferring the cholesterol to extracellular acceptors. Cells with defective ABC1 are unable to unload cholesterol, even in the presence of surplus extracellular acceptor. In contrast, cells with excessive levels of ABC1 will unload so much cholesterol to extracellular acceptors that the cells die of cholesterol deficiency.

ABC1 is the first intracellular cholesterol transport protein identified to play a role in the first step of the reverse cholesterol transport process. The identification of this protein creates the opportunity to identify drugs that will stimulate this process and enhance the intracellular movement of cholesterol to the cell membrane. At this point, the rate at which cells are ultimately capable of unloading cholesterol will be dependent on the presence of sufficient extracellular acceptor molecules. The present invention is also useful in combination with drugs that enhance the intracellular movement of cholesterol to the cell membrane

HDL, and particular HDL1, is known to act as an acceptor of cellular cholesterol. However, HDL has a limited capacity for acquiring cholesterol and acts as a much more efficient acceptor of cholesterol in the presence of other molecules capable of serving as a cholesterol reservoir or sink. A particularly efficient and synergistic method of enhancing cellular cholesterol efflux is through the combination of HDL and empty phospholipid liposomes described herein. In this situation, the small, HDL molecules shuttle cholesterol from the cell membrane and transfer the cholesterol to the liposomes, which are much larger and have a greater capacity for cholesterol. The HDL is then free to bind more cellular cholesterol and continue the shuttle function. In this situation, a limited amount of HDL lipoprotein is capable of facilitating the removal of far more cellular cholesterol.

When defects in ABC1 limit the ability of cells to transport cholesterol to the cell membrane, the capacity of extracellular acceptors will never be the rate limiting step in the cholesterol efflux process. However, in the presence of pharmaceutical agents that

stimulate the intracellular transport of cholesterol through AbC1 or other intracellular cholesterol transport proteins, the capacity of HDL to accept all of the mobilized cholesterol may become a limiting factor in the reverse cholesterol transport process.

The instant invention, therefore, calls for the intravenous administration of empty phospholipid vesicles with a mean diameter sufficiently large as to exclude these vesicles from penetrating the hepatic fenestrae, which are openings of approximately 100 nm, in combination with drugs that stimulate the function of ABC1, or similar intracellular cholesterol transport proteins. Of course, other liposome compositions described herein can also be used. The result of the combination will be extracellular cholesterol acceptor particles with enhanced capacity for cellular cholesterol. The size of the phospholipid liposome acceptor particles will prevent uptake of the effluxed cholesterol by the hepatic parenchymal cells. This prevents the cholesterol from interfering with hepatic cholesterol homeostasis. The particles are instead cleared by the Kupffer cells, where the cholesterol is ultimately eliminated in the bile.

This invention will be particularly useful in the treatment of patients suffering from any number of inherited conditions that result in extremely low levels of HDL cholesterol. Many of these conditions predispose the patients to accelerated atherosclerosis and heart disease.

While only a few, preferred embodiments of the invention have been described herein above, those of ordinary skill in the art will recognize that the embodiment may be modified and altered without departing from the central spirit and scope of the invention.

Thus, the preferred embodiment described herein above is to be considered in all respects as illustrative and not restrictive, the scope of the invention being indicated by the appended claims, rather than by the foregoing description, and all changes which come within the meaning and range of equivalency of the claims are intended to be embraced herein.

CLAIMS**WE CLAIM:**

1. A method of treating angina and/or an anginal equivalent comprising administering a therapeutically effective amount of a multiplicity of large liposomes comprised of phospholipids substantially free of sterol to a subject for a treatment period.
2. The method in accordance with claim 1 in which said angina is selected from the group consisting of stable angina, unstable angina and variant angina.
3. The method in accordance with claim 1 in which said angina is angina pectoris.
4. The method in accordance with claim 1 in which the large liposomes are selected from the group consisting of large liposomes of a size and shape larger than fenestrations of an endothelial layer lining hepatic sinusoids in a liver, large liposomes that do not harmfully disrupt hepatic cholesterol homeostasis, large liposomes that do not substantially raise concentrations of plasma LDL, and large liposomes that do not substantially raise concentrations of plasma atherogenic lipoproteins.

5. The method in accordance with claim 1 in which the therapeutically effective amount is in the range of about 10 mg to about 1600 mg phospholipid per kg body weight per dose.
6. The method in accordance with claim 1 in which the liposomes are given periodically during said treatment period.
7. The method in accordance with claim 1 in which the large liposomes are selected from the group consisting of uni-lamellar liposomes, pauci-lamellar liposomes, and multi-lamellar liposomes.
8. The method in accordance with claim 1 in which the liposomes have diameters larger than about 50 nm.
9. The method in accordance with claim 1 in which the liposomes have diameters larger than about 80 nm.
10. The method in accordance with claim 1 in which the liposomes have diameters larger than about 100 nm.
11. The method in accordance with claim 1 in which the liposomes have diameters in the range of about 100 nm to about 150 nm.

12. The method in accordance with claim 1 in which the liposomes have diameters in the range of about 150 nm to about 200 nm.
13. The method in accordance with claim 1 in which the liposomes have diameters in the range of about 200 nm to about 250 nm.
14. The method in accordance with claim 1 in which administration is selected from the group of intravenous bolus administration, intravenous infusion, and intraperitoneal administration.
15. The method in accordance with claim 1 further comprising monitoring a cardiac function.
16. The method in accordance with claim 15 in which said cardiac function is selected from the group consisting of an EKG abnormality, an S-T segment change, an arrhythmia, an assessment of segmental wall motion, blood viscosity, exercise tolerance, and ambulatory EKG monitoring.
17. The method in accordance with claim 1 further comprising administering an effective amount of an anti-anginal drug other than said large liposomes.

18. The method in accordance with claim 17 in which said anti-anginal drug is selected from the group consisting of a nitrate, a beta blocker, a calcium channel antagonist, a coronary vasodilator, a lipid lowering drug, an afterload reducing agent, an inotropic agent, a pre-load reducing agent and an opiate.

19. The method in accordance with claim 17 in which said nitrate is selected from the group consisting of nitroglycerine, sublingually administered nitroglycerine, a long acting nitrate, an insublingual nitrate preparation, a buccal nitrate preparation, an oral nitrate preparation, a spray nitrate preparation, an oral nitroglycerin spray, an isosorbide dinitrate preparation, an isosorbide-5-Mononitrate preparation, a nonsublingual nitrate preparation, a sustained-release preparation of isosorbide-5-mononitrate, a topical nitroglycerin, a nitroglycerin ointment, a nitroglycerin containing transdermal patch, and a silicone gel or polymer matrix impregnated with nitroglycerin.

20. The method in accordance with claim 17 in which said beta blocker is selected from the group consisting of a nonselective beta-blocking drug, propranolol, nadolol, penbutolol, pindolol, sotalol, timolol, carteolol, a drug that blocks both beta1 and beta2 receptors, a cardioselective beta blocker, acebutolol, atenolol, betaxolol, bisoprolol, esmolol, metoprolol, and a drug that blocks a beta1 receptor while having a lesser effect on a beta2 receptor.

21. The method in accordance with claim 17 in which said calcium channel antagonist is selected from the group consisting of a calcium antagonist, a compound that inhibits calcium ion movement through a slow channel in cardiac and smooth muscle membranes by noncompetitive blockade of a voltage-sensitive L-type calcium channel, a dihydropyridine, nifedipineTM, a phenylalkylamine, verapamilTM, a benzothiazepine, diltiazemTM, nicardipineTM, amlodipineTM, and bepridilTM, a second-generation calcium antagonist, nicardipineTM, isradipineTM, amlodipineTM, felodipineTM and a dihydropyridine derivative.
22. The method in accordance with claim 1 further comprising administering an angiotensin-convertingenzyme (ACE) inhibitor to said subject.
23. The method in accordance with claim 1 further comprising administering an anti-arrhythmic drug to said subject.
24. The method in accordance with claim 1 further comprising effecting a positive life style change in said subject.
25. The method in accordance with claim 24 in which said positive life style change is selected from the group consisting of weight loss, reduction of cigarette smoking, elimination of cigarette smoking, exercise, supervised exercise, reduced salt intake, reduced intake of saturated fatty acids, reduced intake of cholesterol, a

reduction in total fat intake, avoidance of physical stress, avoidance of emotional stress, and reduced intake of calories.

26. The method in accordance with claim 1 further comprising effecting an anti-anginal therapy.
27. The method in accordance with claim 26 in which said anti-anginal therapy comprises treatment of a co-existing aggravating condition.
28. The method in accordance with claim 27 in which said treatment of said coexisting aggravating condition is selected from the group consisting of a treatment for hypertension, a treatment for hyperthyroidism, a treatment for pulmonary disease, a treatment for heart failure, a treatment for a hypermetabolic state, and a treatment for anemia.
29. The method in accordance with claim 1 further comprising administering an anti-thrombotic therapy.
30. The method of claim 29 in which said anti-thrombotic therapy is selected from the group consisting of administering a therapeutically effective amount of an anti-platelet drug, administering a therapeutically effective amount of a drug that interferes with formation of a fibrin clot, and a thrombolytic therapy.

31. The method of claim 1 in which a level of a plasma atherogenic lipoprotein is controlled.
32. The method of claim 1 further comprising monitoring a level of a plasma atherogenic lipoprotein.
33. A method of treating angina and/or an anginal equivalent comprising administering a therapeutically effective amount of liposomes to a subject.
34. The method of claim 33 in which said liposomes are selected from the group consisting of large liposomes, small liposomes, and combinations thereof.
36. The method of claim 34 in which said liposomes are administered such that a plasma atherogenic lipoprotein level in said subject does not substantially rise.
37. The method in accordance with claim 33 in which the liposomes are chemical compositions of liposomes of a size, function or composition so that said liposomes are cleared slowly by the liver.
38. The method in accordance with claim 33 in which the step of administering comprises slowly infusing said liposomes.

39. The method in accordance with claim 33 in which the step of administering comprises administering small doses of said liposomes, separated in time, to avoid increasing a plasma concentration of an atherogenic lipoprotein.
40. The method in accordance with claim 33 further comprising the step of periodically assaying a plasma concentration of an atherogenic lipoprotein with an assay to obtain an assayed plasma concentration of an atherogenic lipoprotein, said assay selected from the group consisting of an assay of plasma esterified cholesterol, an assay of plasma apolipoprotein-B, a gel filtration assay of plasma, an ultracentrifugal assay of plasma, and a precipitation assay having a component, said component selected from the group consisting of polyanions, divalent cations, and antibodies; an ultracentrifugal assay of plasma, a precipitation assay, a immunoturbidimetric assay, an assay using an antibody, an assay using an antibody fragment, and an electrophoretic assay to determine the level of a therapeutically effective amount of each of said liposomes.
41. The method in accordance with claim 33 in which said angina is selected from the group consisting of stable angina, unstable angina and variant angina.
42. The method in accordance with claim 33 in which said angina is angina pectoris.

43. The method in accordance with claim 33 in which the liposomes are of a size and shape larger than fenestrations of an endothelial layer lining hepatic sinusoids in said liver.
44. The method in accordance with claim 33 in which the therapeutically effective amount is in the range of about 10 mg to about 1600 mg phospholipid per kg body weight per dose.
45. The method in accordance with claim 33 in which the liposomes are given periodically during said treatment period.
46. The method in accordance with claim 33 in which the liposomes are selected from the group consisting of uni-lamellar liposomes, pauci-lamellar, and multi-lamellar liposomes.
47. The method in accordance with claim 33 in which the liposomes have diameters larger than about 50 nm.
48. The method in accordance with claim 33 in which the liposomes have diameters larger than about 80 nm.

49. The method in accordance with claim 33 in which the liposomes have diameters larger than about 100 nm.
50. The method in accordance with claim 33 in which the liposomes have diameters in the range of about 100 nm to about 150 nm.
51. The method in accordance with claim 33 in which the liposomes have diameters in the range of about 150 nm to about 200 nm.
52. The method in accordance with claim 33 in which the liposomes have diameters in the range of about 200 nm to about 250 nm.
53. The method in accordance with claim 33 in which administration is selected from the group of intravenous bolus administration, intravenous infusion, and intra-peritoneal administration.
54. The method in accordance with claim 33 further comprising monitoring a cardiac function.

55. The method in accordance with claim 54 in which said cardiac function is selected from the group consisting of an EKG abnormality, an S-T segment change, an arrhythmia, an assessment of segmental wall motion, blood viscosity, exercise tolerance, ambulatory EKG monitoring, cardiac perfusion, perfusion of a body part other than the heart, and a cardiac wall motion abnormality.
56. The method in accordance with claim 33 further comprising administering an effective amount of an anti-anginal drug other than said liposomes.
57. The method in accordance with claim 56 in which said anti-anginal drug is selected from the group consisting of a nitrate, a beta blocker, a calcium channel antagonist, a coronary vasodilator, a lipid lowering drug, an afterload reducing agent, an inotropic agent, a pre-load reducing agent and an opiate.
58. The method in accordance with claim 57 in which said nitrate is selected from the group consisting of nitroglycerine, sublingually administered nitroglycerine, a long acting nitrate, an insublingual nitrate preparation, a buccal nitrate preparation, an oral nitrate preparation, a spray nitrate preparation, an oral nitroglycerin spray, an isosorbide dinitrate preparation, an isosorbide-5-Mononitrate preparation, a nonsublingual nitrate preparation, a sustained-release preparation of isosorbide-5-mononitrate, a topical nitroglycerin, a nitroglycerin ointment, a

nitroglycerin containing transdermal patch, and a silicone gel or polymer matrix impregnated with nitroglycerin.

59. The method in accordance with claim 57 in which said beta blocker is selected from the group consisting of a nonselective beta-blocking drug, propranolol, nadolol, penbutolol, pindolol, sotalol, timolol, carteolol, a drug that blocks both beta1 and beta2 receptors, a cardioselective beta blocker, acebutolol, atenolol, betaxolol, bisoprolol, esmolol, metoprolol, and a drug that blocks a beta1 receptor while having a lesser effect on a beta2 receptor.
60. The method in accordance with claim 57 in which said calcium channel antagonist is selected from the group consisting of a calcium antagonist, a compound that inhibits calcium ion movement through a slow channel in cardiac and smooth muscle membranes by noncompetitive blockade of a voltage-sensitive L-type calcium channel, a dihydropyridine, nifedipineTM, a phenylalkylamine, verapamilTM, a benzothiazepine, diltiazemTM, nicardipineTM, amlodipineTM, and bepridilTM, a second-generation calcium antagonist, nicardiopineTM, isradipineTM, amlodipineTM, felodipineTM and a dihydropyridine derivative.
61. The method in accordance with claim 33 further comprising administering an angiotensin-convertingenzyme (ACE) inhibitor to said subject.

62. The method in accordance with claim 33 further comprising administering an anti-arrhythmic drug to said subject.
63. The method in accordance with claim 33 further comprising effecting a positive life style change in said subject.
64. The method in accordance with claim 63 in which said life style change is selected from the group consisting of weight loss, reduction of cigarette smoking, elimination of cigarette smoking, exercise, supervised exercise, reduced salt intake, reduced intake of saturated fatty acids, reduced intake of cholesterol, a reduction in total fat intake, avoidance of physical stress, avoidance of emotional stress, and reduced intake of calories.
65. The method in accordance with claim 33 further comprising effecting an anti-anginal therapy.
66. The method in accordance with claim 65 in which said anti-anginal therapy comprises treatment of a co-existing aggravating condition.

67. The method in accordance with claim 66 in which said treatment of said coexisting aggravating condition is selected from the group consisting of a treatment for hypertension, a treatment for hyperthyroidism, a treatment for pulmonary disease, a treatment for heart failure, a treatment for a hypermetabolic state, and a treatment for anemia.
68. The method in accordance with claim 33 further comprising administering an anti-thrombotic therapy.
69. The method of claim 68 in which said anti-thrombotic therapy is selected from the group consisting of administering a therapeutically effective amount of an anti-platelet drug, administering a therapeutically effective amount of a drug that interferes with formation of a fibrin clot, and a thrombolytic therapy.
70. The method of claim 33 in which a plasma atherogenic lipoprotein is controlled.
71. The method of claim 33 further comprising monitoring a plasma LDL a plasma concentration of a subject.
72. A method of treating claudication comprising administering a therapeutically effective amount of liposomes.

73. The method of claim 72 in which said liposomes are selected from the group consisting of large liposomes, small liposomes, and combinations thereof.
74. The method of claim 73 in which said liposomes are administered such that a plasma atherogenic lipoprotein level in said subject does not substantially rise.
75. The method in accordance with claim 72 in which the liposomes are selected from the group consisting of liposomes of a size and shape larger than fenestrations of an endothelial layer lining hepatic sinusoids in a liver, liposomes that do not harmfully disrupt hepatic cholesterol homeostasis, liposomes that do not substantially raise concentrations of plasma LDL, liposomes that do not substantially raise concentrations of plasma atherogenic lipoproteins, and liposomes of a size, function or composition so that said liposomes are cleared slowly by the liver.
76. The method in accordance with claim 72 in which the step of administering comprises slowly infusing said liposomes.
77. The method in accordance with claim 72 in which the step of administering comprises administering small doses of said liposomes, separated in time, to avoid increasing an atherogenic lipoprotein concentration.

78. The method in accordance with claim 72 further comprising the step of periodically assaying said plasma LDL concentrations with an assay to obtain an assayed LDL concentration, said assay selected from the group consisting of an assay of plasma esterified cholesterol, an assay of plasma apolipoprotein-B, a gel filtration assay of plasma, an ultracentrifugal assay of plasma, and a precipitation assay having a component, said component selected from the group consisting of polyanions, divalent cations, and antibodies, an ultracentrifugal assay of plasma, a precipitation assay, a immuno-turbidimetric assay, an assay using an antibody, an assay using an antibody fragment, and an electrophoretic assay to determine the level of a therapeutically effective amount of each of said liposomes.
79. The method in accordance with claim 72 in which the liposomes are of a size and shape larger than fenestrations of an endothelial layer lining hepatic sinusoids in said liver.
80. The method in accordance with claim 72 in which the therapeutically effective amount is in the range of about 10 mg to about 1600 mg phospholipid per kg body weight per dose.
81. The method in accordance with claim 72 in which the liposomes are given periodically during said treatment period.

82. The method in accordance with claim 72 in which the liposomes are selected from the group consisting of uni-lamellar liposomes, pauci-lamellar, and multi-lamellar liposomes.
83. The method in accordance with claim 72 in which the liposomes have diameters larger than about 50 nm.
84. The method in accordance with claim 72 in which the liposomes have diameters larger than about 80 nm.
85. The method in accordance with claim 72 in which the liposomes have diameters larger than about 100 nm.
86. The method in accordance with claim 72 in which the liposomes have diameters in the range of about 100 nm to about 150 nm.
87. The method in accordance with claim 72 in which the liposomes have diameters in the range of about 150 nm to about 200 nm.
88. The method in accordance with claim 72 in which the liposomes have diameters in the range of about 200 nm to about 250 nm.

89. The method in accordance with claim 72 in which administration is selected from the group of intravenous bolus administration, intravenous infusion, and intra-peritoneal administration.
90. The method in accordance with claim 72 further comprising monitoring a cardiac function.
91. The method in accordance with claim 90 in which said cardiac function is selected from the group consisting of an EKG abnormality, an S-T segment change, an arrhythmia, an assessment of segmental wall motion, blood viscosity, exercise tolerance, ambulatory EKG monitoring, cardiac perfusion, perfusion of a body part other than the heart, and a cardiac wall motion abnormality.
92. The method in accordance with claim 72 further comprising administering an effective amount of an anti-anginal drug other than said liposomes.
93. The method in accordance with claim 92 in which said anti-anginal drug is selected from the group consisting of a nitrate, a beta blocker, a calcium channel antagonist, a coronary vasodilator, a lipid lowering drug, an afterload reducing agent, an inotropic agent, a pre-load reducing agent and an opiate.

94. The method in accordance with claim 93 in which said nitrate is selected from the group consisting of nitroglycerine, sublingually administered nitroglycerine, a long acting nitrate, an insublingual nitrate preparation, a buccal nitrate preparation, an oral nitrate preparation, a spray nitrate preparation, an oral nitroglycerin spray, an isosorbide dinitrate preparation, an isosorbide-5-Mononitrate preparation, a nonsublingual nitrate preparation, a sustained-release preparation of isosorbide-5-mononitrate, a topical nitroglycerin, a nitroglycerin ointment, a nitroglycerin containing transdermal patch, and a silicone gel or polymer matrix impregnated with nitroglycerin.
95. The method in accordance with claim 93 in which said beta blocker is selected from the group consisting of a nonselective beta-blocking drug, propranolol, nadolol, penbutolol, pindolol, sotalol, timolol, carteolol, a drug that blocks both beta1 and beta2 receptors, a cardioselective beta blocker, acebutolol, atenolol, betaxolol, bisoprolol, esmolol, metoprolol, and a drug that blocks a beta1 receptor while having a lesser effect on a beta2 receptor.
96. The method in accordance with claim 93 in which said calcium channel antagonist is selected from the group consisting of a calcium antagonist, a compound that inhibits calcium ion movement through a slow channel in cardiac and smooth muscle membranes by noncompetitive blockade of a voltage-sensitive L-type calcium channel, a dihydropyridine, nifedipineTM, a phenylalkylamine,

verapamilTM, a benzothiazepine, diltiazemTM, nicardipineTM, amlodipineTM, and bepridilTM, a second-generation calcium antagonist, nicardipineTM, isradipineTM, amlodipineTM, felodipineTM and a dihydropyridine derivative.

97. The method in accordance with claim 72 further comprising administering an angiotensin-converting enzyme (ACE) inhibitor to said subject.
98. The method in accordance with claim 72 further comprising administering an anti-arrhythmic drug to said subject.
99. The method in accordance with claim 72 further comprising effecting a positive lifestyle change in said subject.
100. The method in accordance with claim 99 in which said life style change is selected from the group consisting of weight loss, reduction of cigarette smoking, elimination of cigarette smoking, exercise, supervised exercise, reduced salt intake, reduced intake of saturated fatty acids, reduced intake of cholesterol, a reduction in total fat intake, avoidance of physical stress, avoidance of emotional stress, and reduced intake of calories.
101. The method in accordance with claim 72 further comprising effecting an anti-anginal therapy.

102. The method in accordance with claim 101 in which said anti-anginal therapy comprises treatment of a co-existing aggravating condition.
103. The method in accordance with claim 102 in which said treatment of said coexisting aggravating condition is selected from the group consisting of a treatment for hypertension, a treatment for hyperthyroidism, a treatment for a hypermetabolic state, a treatment for pulmonary disease, a treatment for heart failure, and a treatment for anemia.
104. The method in accordance with claim 72 further comprising administering an anti-thrombotic therapy.
105. The method of claim 104 in which said anti-thrombotic therapy is selected from the group consisting of administering a therapeutically effective amount of an anti-platelet drug, administering a therapeutically effective amount of a drug that interferes with formation of a fibrin clot, and a thrombolytic therapy.
106. The method of claim 72 in which a plasma atherogenic lipoprotein is controlled.

107. The method of claim 72 further comprising monitoring a plasma atherogenic lipoprotein level of a subject.
108. The method of claim 72 further in which said liposomes comprise POPC.
109. A pharmaceutical kit for treating angina and/or an anginal equivalent comprising: a first container having a liposomes; and
a second container having anti-anginal drug other than said liposomes.
110. A method of pre-operative conditioning of a subject comprising administering liposomes.
111. The method of claim 110 further comprising administration of an anesthetic or sedative.
112. The method of claim 110 further comprising a preoperative evaluation of a subject's cardiac function.
113. The method of claim 1 in which said anginal equivalent is selected from the group consisting of an ischemic wall motion abnormality, dyspnea, impaired exercise tolerance, an arrhythmia, a reduced cardiac function, and referred pain.

114. The method of claim 33 in which said anginal equivalent is selected from the group consisting of an ischemic wall motion abnormality, dyspnea, impaired exercise tolerance, an arrhythmia, a reduced cardiac function, and referred pain.
115. The method in accordance with claim 72 in which the liposomes have diameters in the range of about 200 nm to about 250 nm.
116. The method in accordance with claim 72 in which the liposomes have diameters in the range of about 90 nm to about 300 nm.
117. The method in accordance with claim 1 in which the size distribution of said liposomes exhibits a single peak.
118. The method in accordance with claim 1 in which the size distribution of said liposomes exhibits a single peak at about 210 nm.
119. The method in accordance with claim 1 in which the liposomes have diameters in the range of about 250 nm to about 400 nm.
120. The method of claim 1 further in which said liposomes comprise POPC.
121. The method of claim 33 further in which said liposomes comprise POPC.

122. The method in accordance with claim 22 in which said angiotensin-converting enzyme (ACE) inhibitor is selected from the group consisting of Quinapril, Accupril®, Ramipril, Altace®, Captopril, Benazepril, Lotensin®, Trandolapril, Mavik®, Fosinopril, Monopril®, Lisinopril, Prinivil®, Moexipril, Univasc®, Enalapril, Vasotec®, Enalaprilat, Lisinopril, Zestril®, active metabolites thereof, and derivatives thereof.
123. The method in accordance with claim 23 in which said anti-arrhythmic drug is selected from the group consisting of quinidine, ethmozine, mexitil, disopyramide, procainamide, quiniaglute, quinidex, rythmol, tambocor, tonocard, sotalol, esmolol, propranolol, acebutolol, betapace, cordarone, convert, calan, verapamil, diltiazem, adenosine, digoxin, active metabolites thereof, derivatives thereof, and combinations thereof.
124. The method in accordance with claim 31 in which said atherogenic lipoprotein is selected from the group consisting of LDL, Lp(a), a lipoprotein comprising apo-B, VLDL, Beta-VLDL, and a remnant lipoprotein.
125. The method in accordance with claim 32 in which said atherogenic lipoprotein is selected from the group consisting of LDL, Lp(a), a lipoprotein comprising apo-B, VLDL, Beta-VLDL, and a remnant lipoprotein.

126. The method in accordance with claim 70 in which said atherogenic lipoprotein is selected from the group consisting of LDL, Lp(a), a lipoprotein comprising apo-B, VLDL, Beta-VLDL, and a remnant lipoprotein.
127. The method in accordance with claim 33 in which the large liposomes are selected from the group consisting of large liposomes of a size and shape larger than fenestrations of an endothelial layer lining hepatic sinusoids in a liver, large liposomes that do not harmfully disrupt hepatic cholesterol homeostasis, large liposomes that do not substantially raise concentrations of plasma LDL, and large liposomes that do not substantially raise concentrations of plasma atherogenic lipoproteins.
128. The method in accordance with claim 39 in which said atherogenic lipoprotein is selected from the group consisting of LDL, Lp(a), a lipoprotein comprising apo-B, VLDL, Beta-VLDL, and a remnant lipoprotein.
129. The method in accordance with claim 40 in which said atherogenic lipoprotein is selected from the group consisting of LDL, Lp(a), a lipoprotein comprising apo-B, VLDL, Beta-VLDL, and a remnant lipoprotein.

130. The method in accordance with claim 33 in which the liposomes have diameters in the range of about 250 nm to about 400 nm.
131. The method in accordance with claim 33 in which the liposomes have diameters in the range of about 90 nm to about 300 nm.
132. The method in accordance with claim 33 in which the size distribution of said liposomes exhibits a single peak.
133. The method in accordance with claim 33 in which the size distribution of said liposomes exhibits a single peak at about 150 nm.
134. The method in accordance with claim 61 in which said angiotensin-converting enzyme (ACE) inhibitor is selected from the group consisting of Ramipril, Captopril, Benazepril, Trandolapril, Fosinopril, Lisinopril, Moexipril, Enalapril, Enalaprilat, Lisinopril, ACE inhibitors with calcium channel blockers, ACE inhibitors with diuretics, active metabolites thereof, and derivatives thereof.
135. The method in accordance with claim 62 in which said anti-arrhythmic drug is selected from the group consisting of a Group I antiarrhythmic, a Group II antiarrhythmic, a Group III antiarrhythmic, a Group IV antiarrhythmic, a combination thereof, and a derivative thereof.

136. The method in accordance with claim 74 in which said atherogenic lipoprotein is selected from the group consisting of LDL, Lp(a), a lipoprotein comprising apo-B, VLDL, Beta-VLDL, and a remnant lipoprotein.
137. The method in accordance with claim 77 in which said atherogenic lipoprotein is selected from the group consisting of LDL, Lp(a), a lipoprotein comprising apo-B, VLDL, Beta-VLDL, and a remnant lipoprotein.
138. The method in accordance with claim 78 in which said atherogenic lipoprotein is selected from the group consisting of LDL, Lp(a), a lipoprotein comprising apo-B, VLDL, Beta-VLDL, and a remnant lipoprotein.
139. The method in accordance with claim 72 in which the liposomes have diameters in the range of about 90 nm to about 300 nm.
140. The method in accordance with claim 72 in which the size distribution of said liposomes exhibits a single peak.
141. The method in accordance with claim 72 in which the size distribution of said liposomes exhibits a single peak at about 150 nm.

142. The method in accordance with claim 72 in which the liposomes have diameters in the range of about 250 nm to about 400 nm.
143. The method in accordance with claim 97 in which said angiotensin-converting enzyme (ACE) inhibitor is selected from the group consisting of Ramipril, Captopril, Benazepril, Trandolapril, Fosinopril, Lisinopril, Moexipril, Enalapril, Enalaprilat, Lisinopril, ACE inhibitors with calcium channel blockers, ACE inhibitors with diuretics, active metabolites thereof, and derivatives thereof.
144. The method in accordance with claim 98 in which said anti-arrhythmic drug is selected from the group consisting of a Group I antiarrhythmic, a Group II antiarrhythmic, a Group III antiarrhythmic, a Group IV antiarrhythmic, a combination thereof, and a derivative thereof.
145. The method in accordance with claim 106 in which said atherogenic lipoprotein is selected from the group consisting of LDL, Lp(a), a lipoprotein comprising apo-B, VLDL, Beta-VLDL, and a remnant lipoprotein.
146. The method in accordance with claim 107 in which said atherogenic lipoprotein is selected from the group consisting of LDL, Lp(a), a lipoprotein comprising apo-B, VLDL, Beta-VLDL, and a remnant lipoprotein.

147. The method in accordance with claim 110 in which said liposomes are administered to said subject in that range of about one month to about two minutes to said surgery.
148. A method of perioperative conditioning of a subject comprising administering liposomes.
149. The method in accordance with claim 148 in which said liposomes are administered to said subject in the range of about one day prior to said surgery to about two weeks after surgery.
150. The method in accordance with claim 112 in which said cardiac function is selected from the group consisting of an EKG abnormality, an S-T segment change, an arrhythmia, an assessment of segmental wall motion, blood viscosity, exercise tolerance, and an ambulatory EKG monitor.
151. The method of claim 148 further comprising administering of an anesthetic or sedative.
152. The method of claim 148 further comprising a perioperative evaluation of a subject's cardiac function.

153. The method in accordance with claim 152 in which said cardiac function is selected from the group consisting of an EKG abnormality, an S-T segment change, an arrhythmia, an assessment of segmental wall motion, blood viscosity, exercise tolerance, and an ambulatory EKG monitor.
154. The method in accordance with claim 1 or claim 33 in which said anginal equivalent is selected from the group consisting of shortness of breath, fatigue, and abdominal distress.

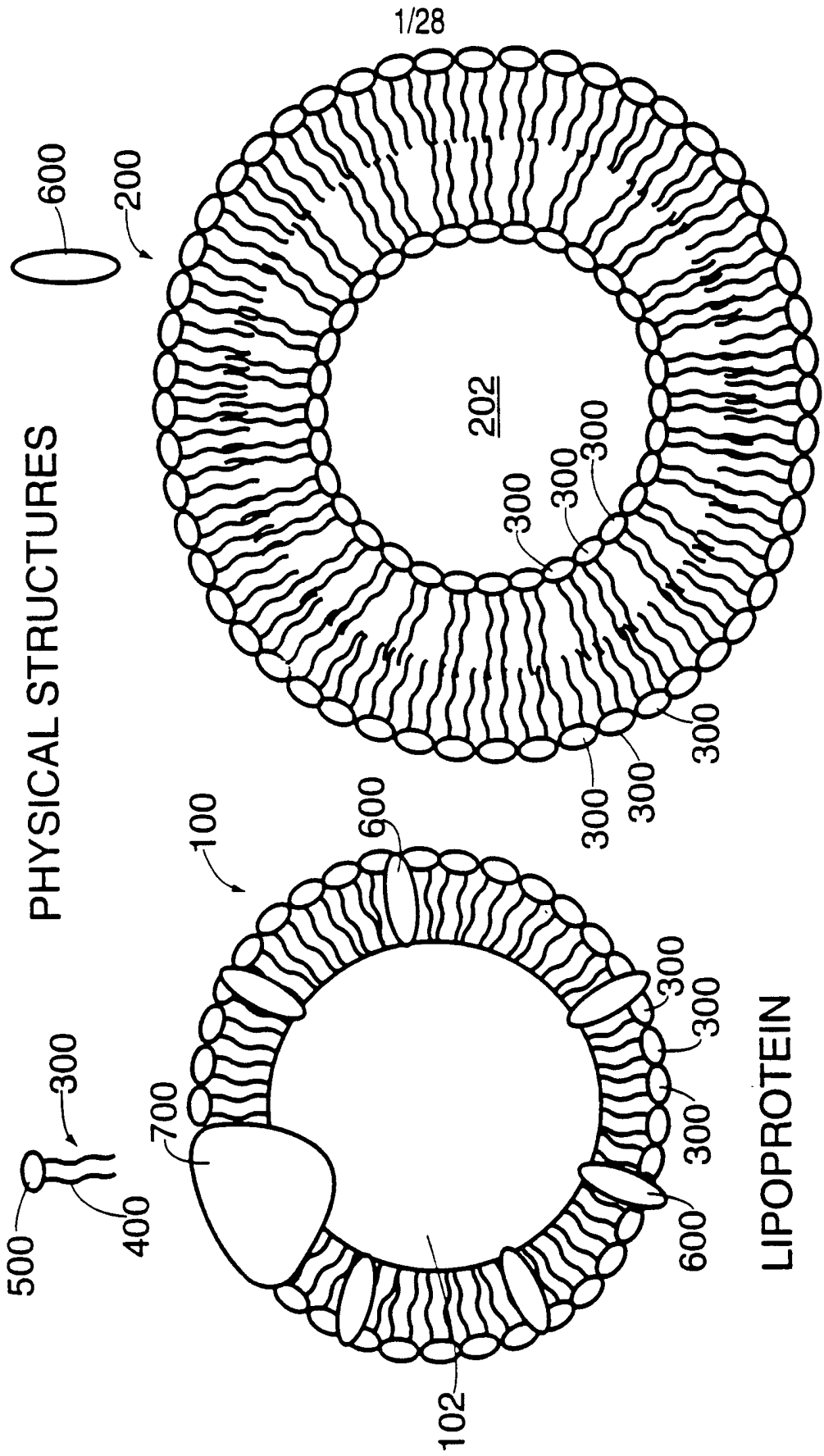

LIPOSOME

FIG. 1

LIPOPROTEIN

LUV-SUV #2		Hepatic mRNA content (pg/ug)									
Rabbit #	Treatment	CETP	HMG-CoA R	LDL R	7a-hydroxylase	LDL ChE, day 1	LDL ChE, day 3	LDL ChE, day 5	LDL ChE, day 6		
1	(A) PBS	2.87	0.54	4.27	0.56	7.4	7.1	5.2	6.5		
2	(A) PBS	5.63	0.55	5.38	0.39	18.1	11.8	6.2	9.7		
3	(A) PBS	5.34	0.39	8.93	0.74	8.5	8.9	4.4	8.7		
4	(A) PBS	5.04	0.55	5.49	0.82	14.1	14.1	6.8	8.6		
	Mean	4.72	0.51	6.02	0.83	11.53	10.48	6.15	8.38		
	SEM	0.63	0.04	1.01	0.10	2.12	1.55	0.98	0.67		
5	(B) LUV	3.15	0.58	7.23	0.63	25.3	14.9	13.6	10.5		
6	(B) LUV	3.02	0.47	8.15	0.58	14.0	15.9	10.8	8.2		
7	(B) LUV	2.52	0.58	4.81	0.83	28.3	22.5	21.3	22.4		
8	(B) LUV	2.68	0.58	7.37	0.94	17.5	21.8	13.4	9.5		
	Mean	2.84	0.55	8.69	0.75	21.28	16.78	14.78	12.85		
	SEM	0.15	0.03	0.72	0.08	3.33	1.96	2.27	3.28		
	1 vs. PBS	2.910	0.939	0.703	0.919	2.473	3.318	3.506	1.275		
13	SUV + LUV	3.18	0.50	5.28	0.51	11.9	34.0	20.1	22.2		
10	(C) SUV	5.64	0.38	3.98	0.30	21.1	45.3	15.3	46.3		
11	(C) SUV	3.39	0.29	3.67	0.42	10.0	36.3	59.6	42.7		
12	(C) SUV	3.00	0.13	3.34	0.63	17.8	31.8	45.5	22.3		
	Mean w/o #13	4.01	0.27	3.66	0.45	16.30	37.80	40.13	37.10		
	SEM w/o #13	0.02	0.07	0.18	0.10	3.28	3.97	13.07	7.47		
	1 vs. PBS	0.686	2.903	2.295	1.304	1.220	6.414	2.594	3.628		
	1 vs. LUV	1.397	3.660	4.328	2.301	1.963	4.296	1.912	2.98		
	Mean w/ #13	3.80	0.33	4.07	0.47	15.20	38.86	35.13	33.38		
	SEM w/ #13	0.62	0.06	0.42	0.07	2.57	2.96	10.51	8.48		
	1 vs. PBS	1.041	2.091	1.781	1.369	1.103	7.890	2.748	3.848		
	1 vs. LUV	1.512	2.763	3.369	2.554	1.445	8.085	1.893	2.856		

FIG. 2

3/28

Plasma LDL cholesteryl ester concentrations
in response to injections of LUVs, SUVs, or saline

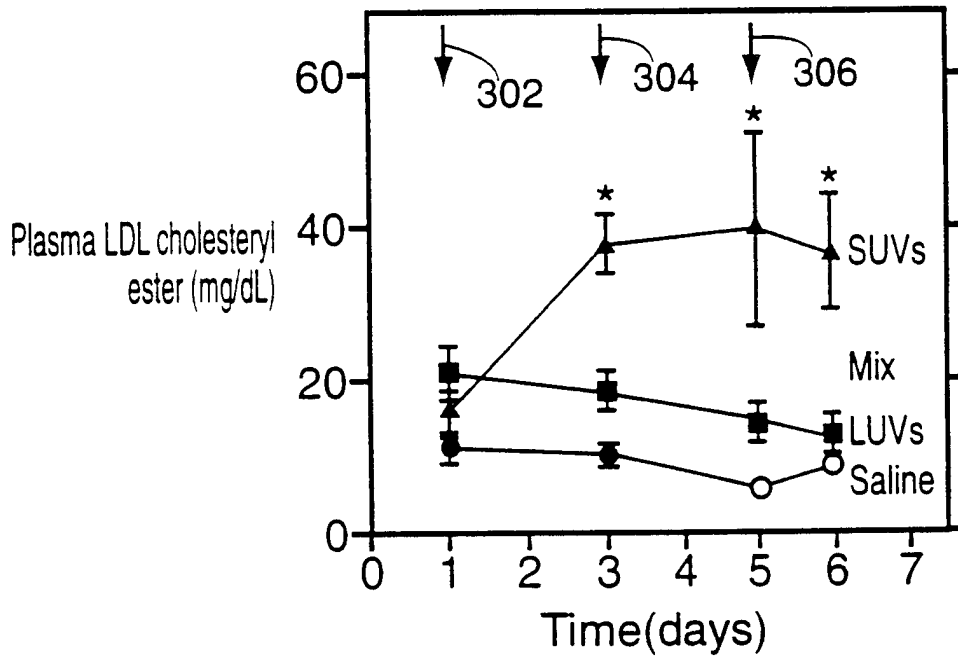
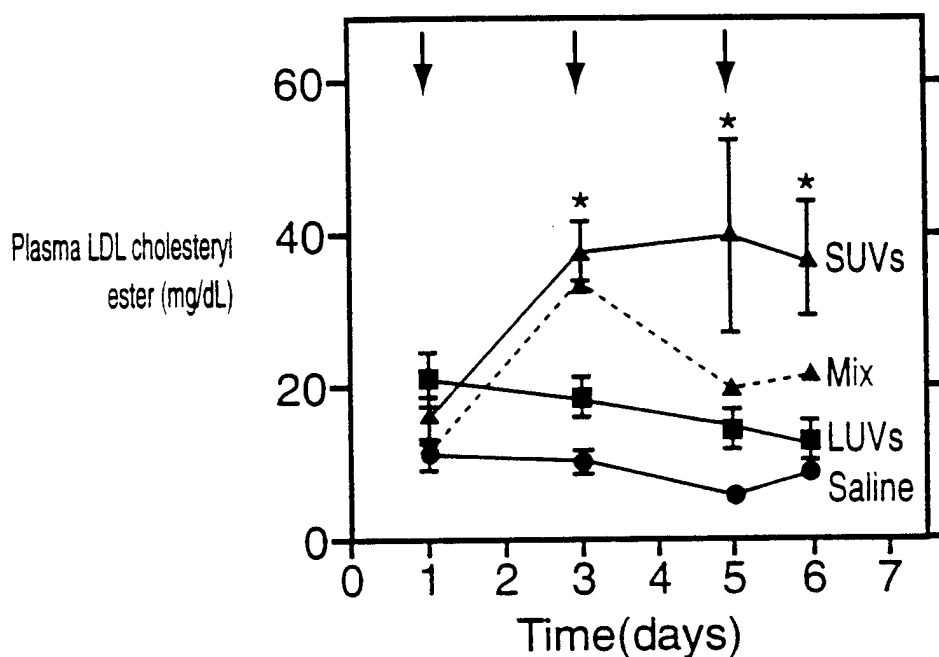

FIG. 3

4/28

Plasma LDL cholesteryl ester concentrations in response to injections of LUVs, SUVs, or saline



"Mix" received SUVs on days 1,3 & 5, but also a dose of LUVs on day 3. All other animals received single injections on days 1,3 & 5 (indicated by arrows).

FIG. 4

5/28

LDL receptor mRNA levels in liver in response to injections of LUVs, SUVs, or saline

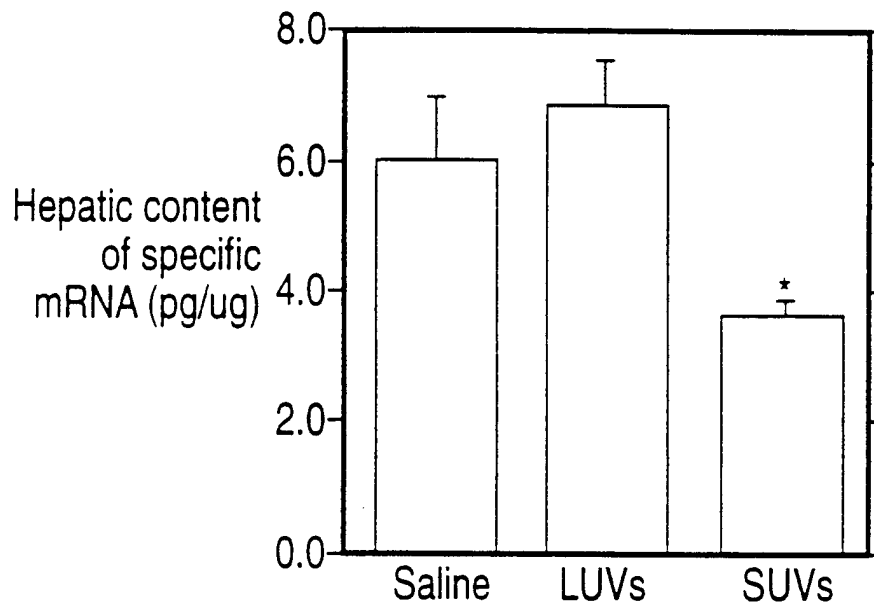

FIG. 5

6/28

LDL receptor mRNA levels in liver in response to injections of LUVs, SUVs, or saline

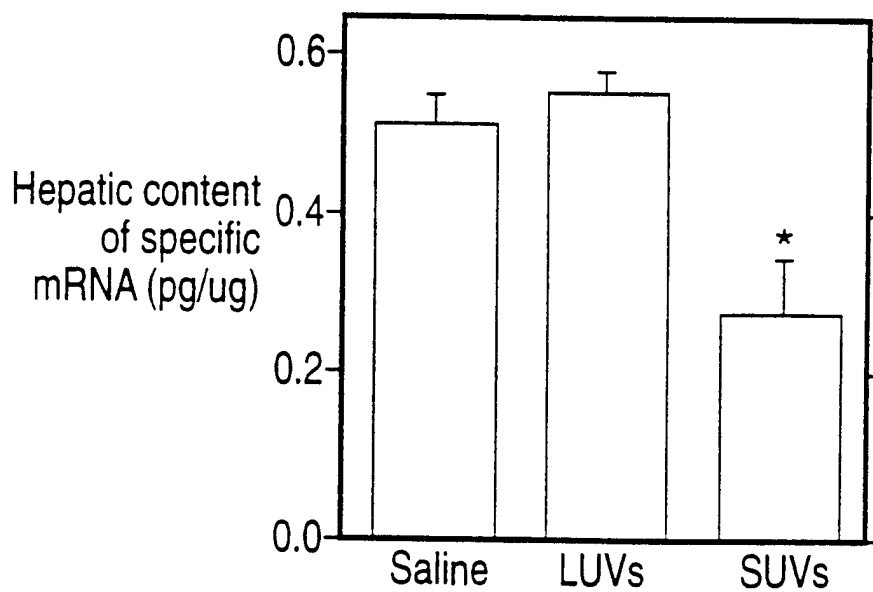

FIG. 6

7/28

Cholesteryl ester transfer protein mRNA levels in liver
in response to injections of LUVs, SUVs, or saline

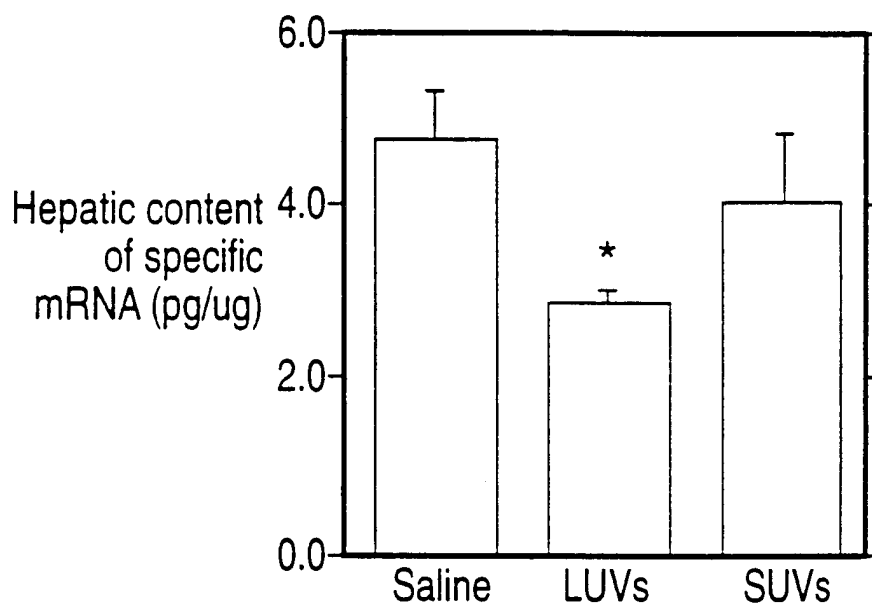

FIG. 7

8/28

7-alpha hydroxylase mRNA levels in liver in response to injections of LUVs, SUVs, or saline

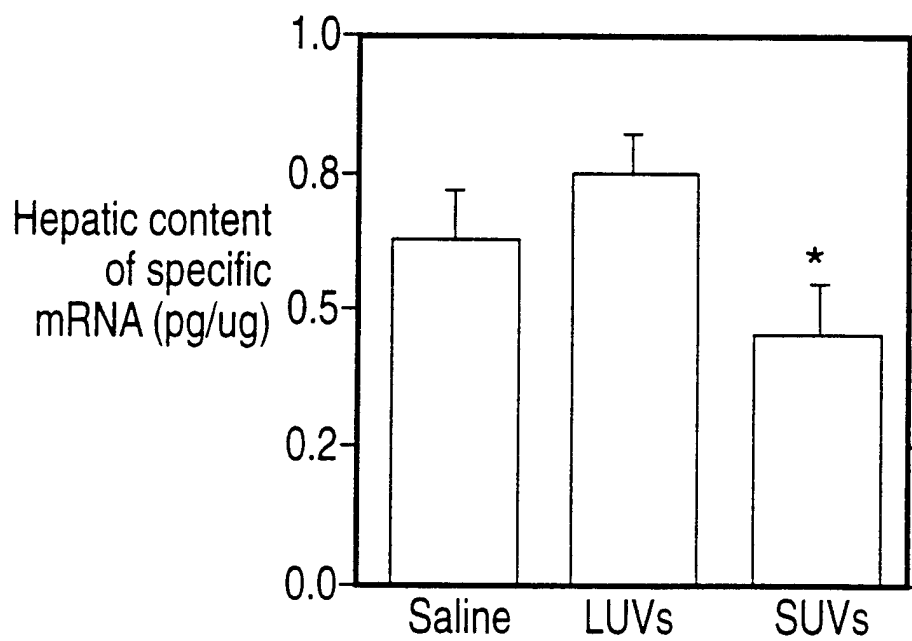

FIG. 8

*Indicates column of interest

9/28

Key points about LUV and atherosclerosis

1) Practical: Straight forward to manufacture
 Non-toxic at very high doses

2) Mechanistic: Liposomes promote reverse
 cholesterol transport *in vivo*

LUV are the optimal preparation

FIG. 9

10/28

Plasma unesterified cholesterol concentrations
in response to injections of LUV, SUV, or saline

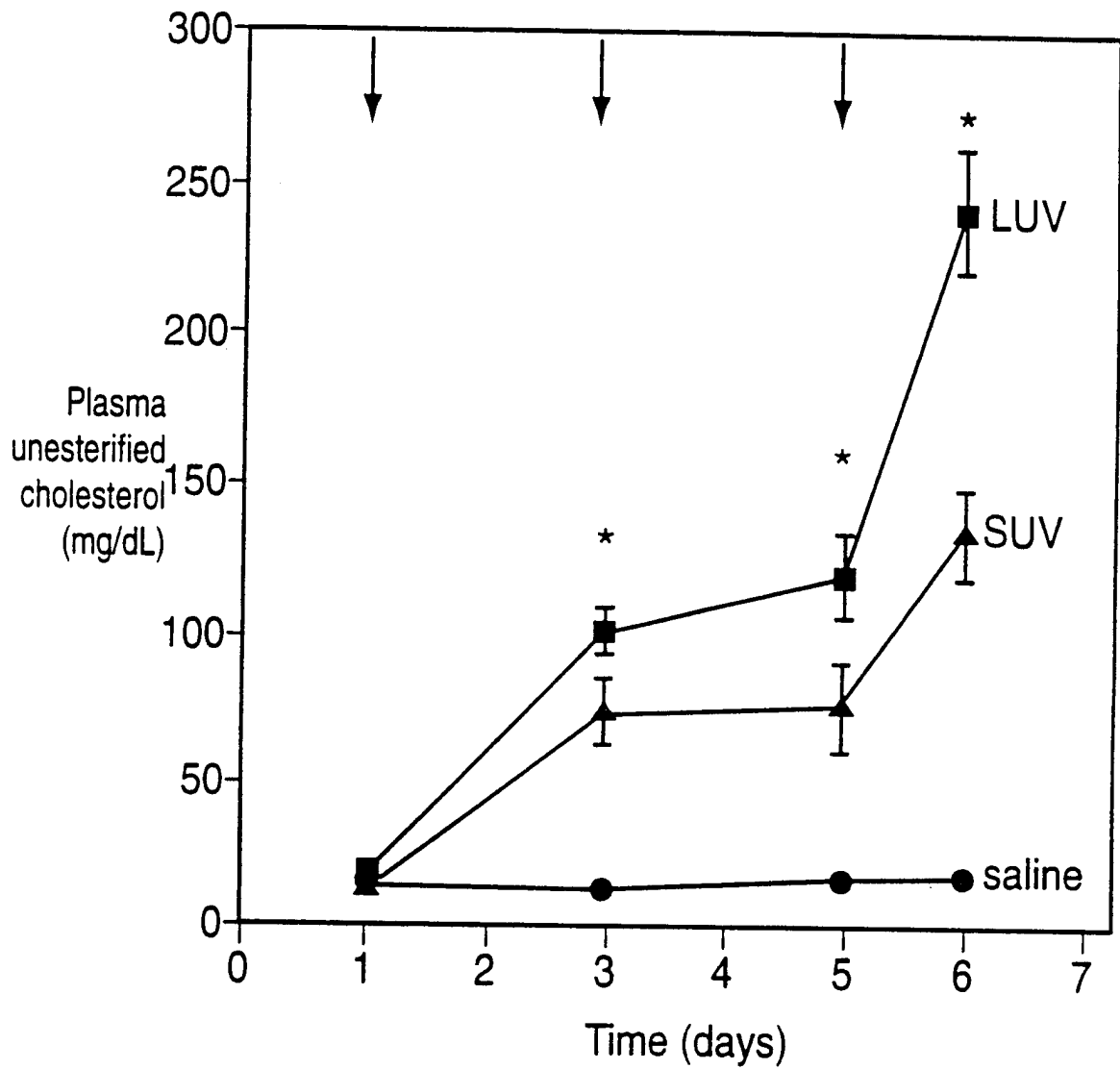

FIG. 10

11/28

Plasma esterified cholesterol concentrations
in response to injections of LUV, SUV, or saline

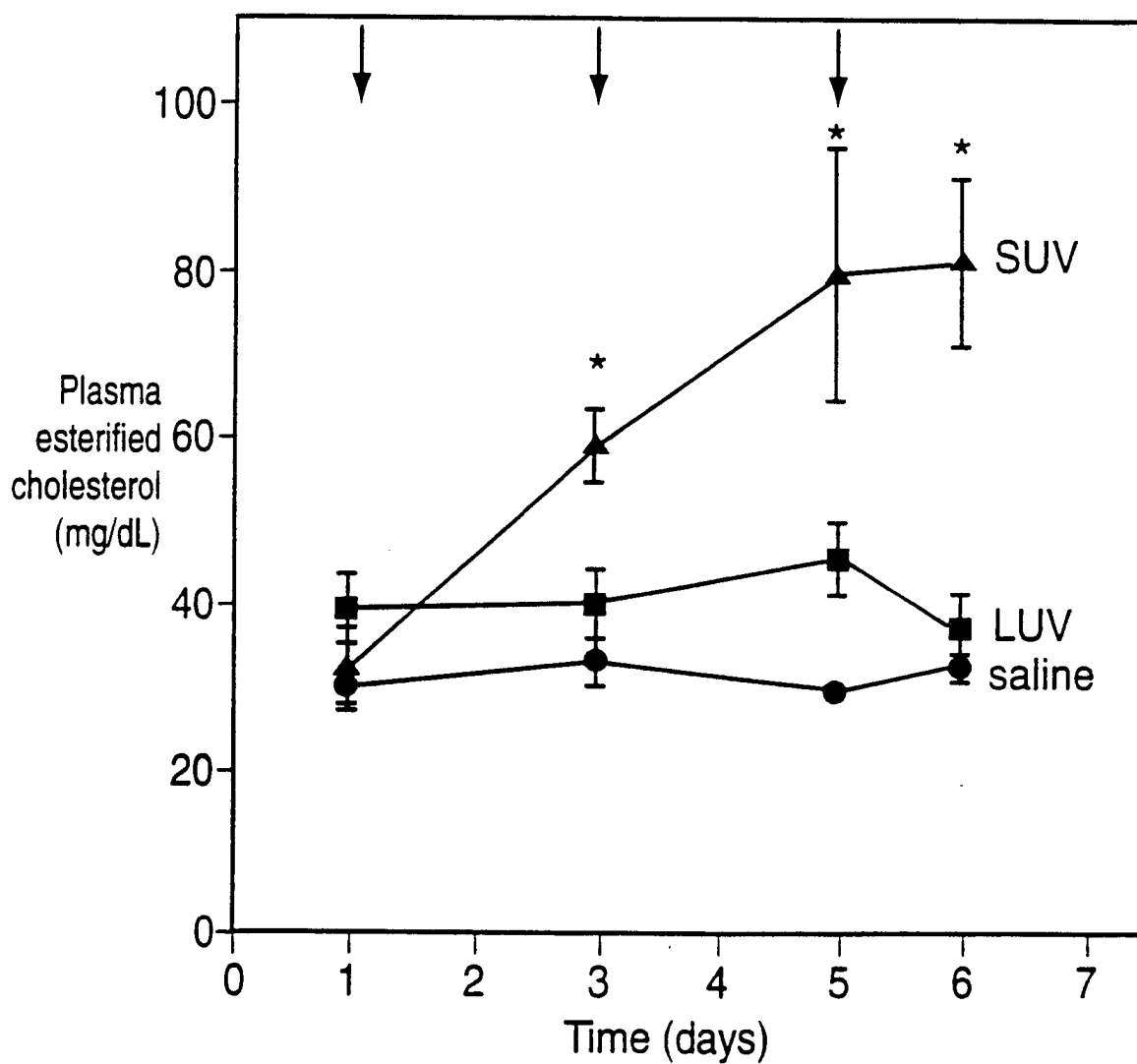

FIG. 11

12/28

LDL esterified cholesterol concentrations
in response to injections of LUV, SUV, or saline

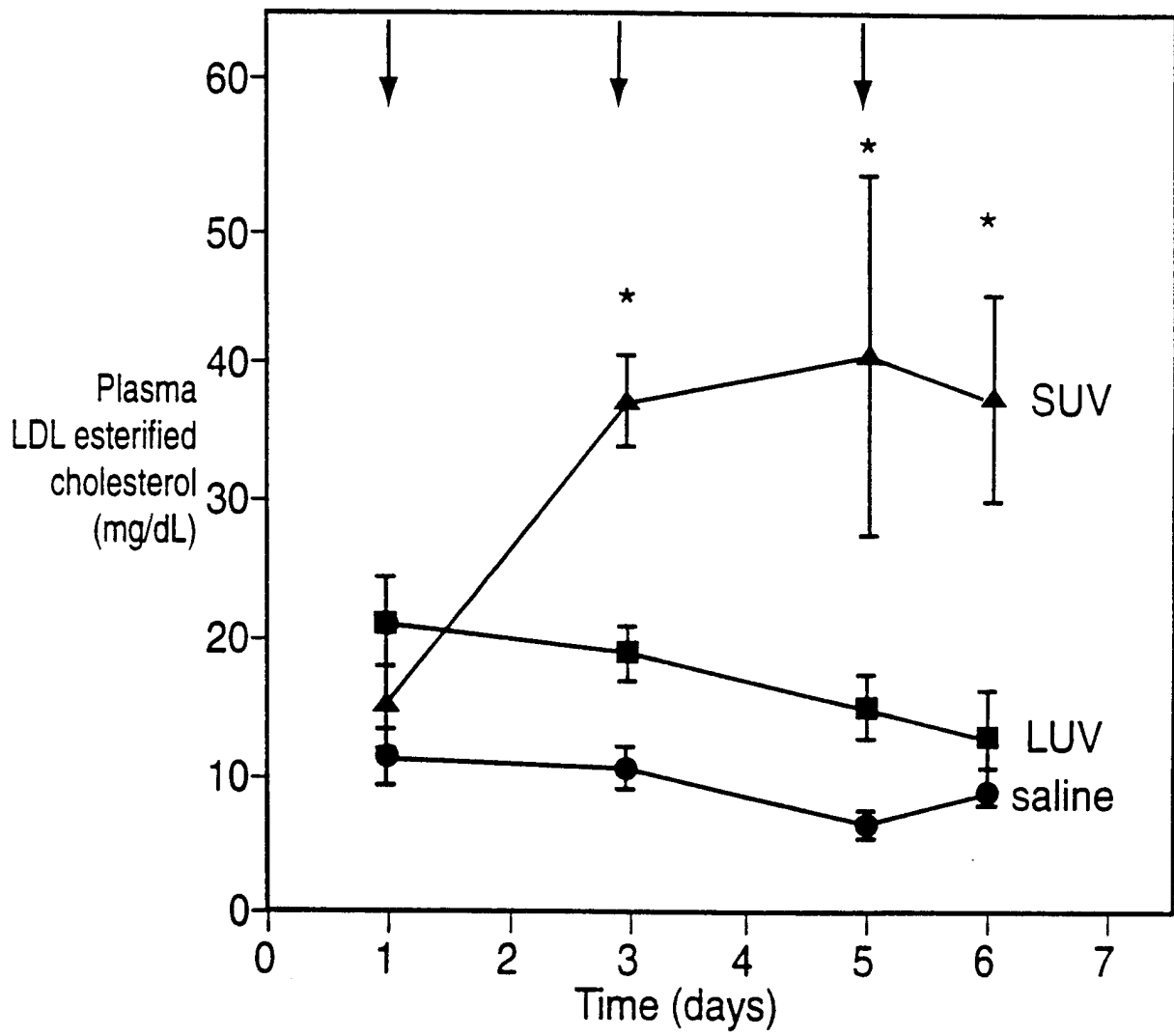

FIG. 12

13/28

VLDL esterified cholesterol concentrations
in response to injections of LUV, SUV, or saline

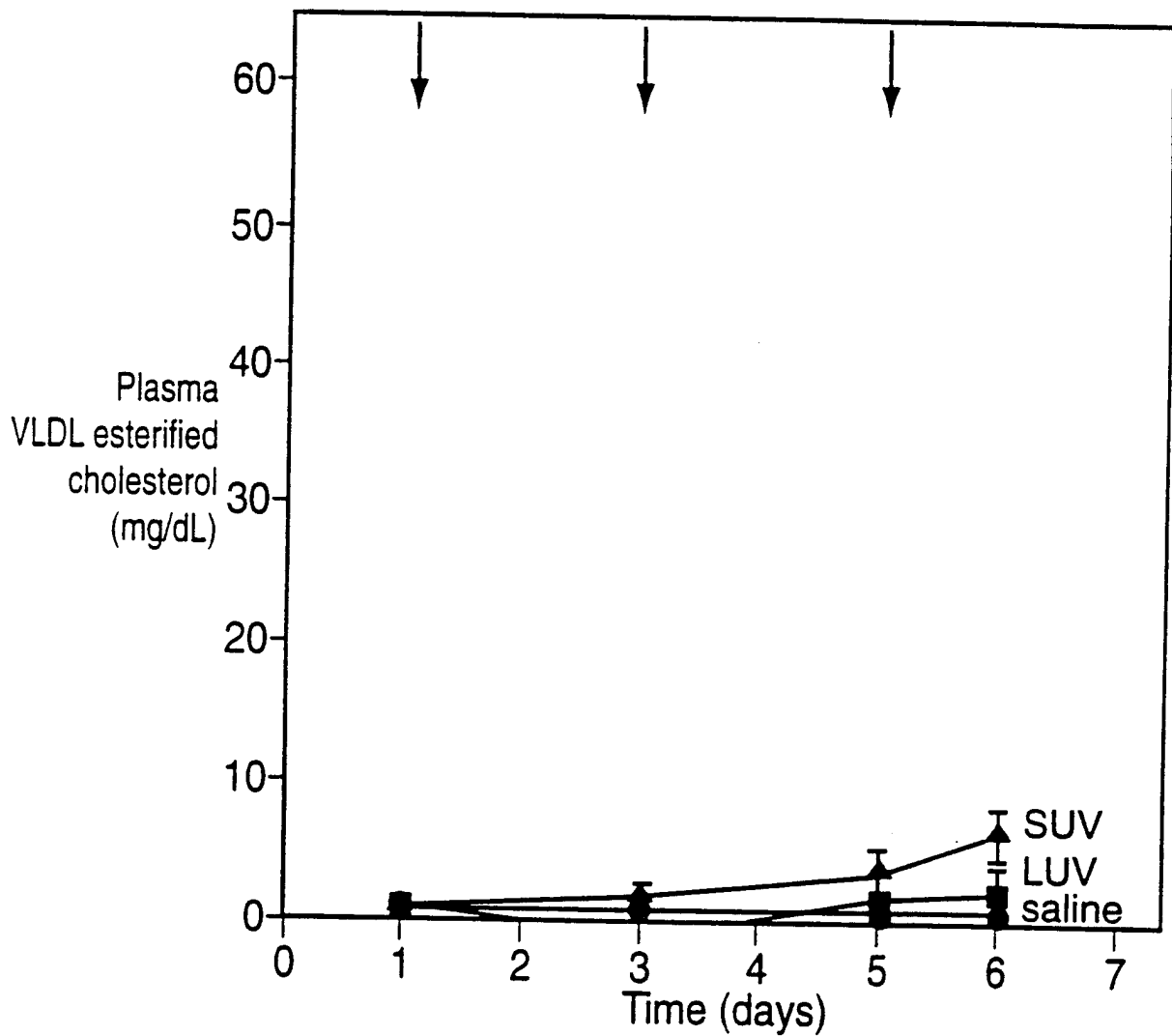

FIG. 13

14/28

HDL esterified cholesterol concentrations
in response to injections of LUV, SUV, or saline

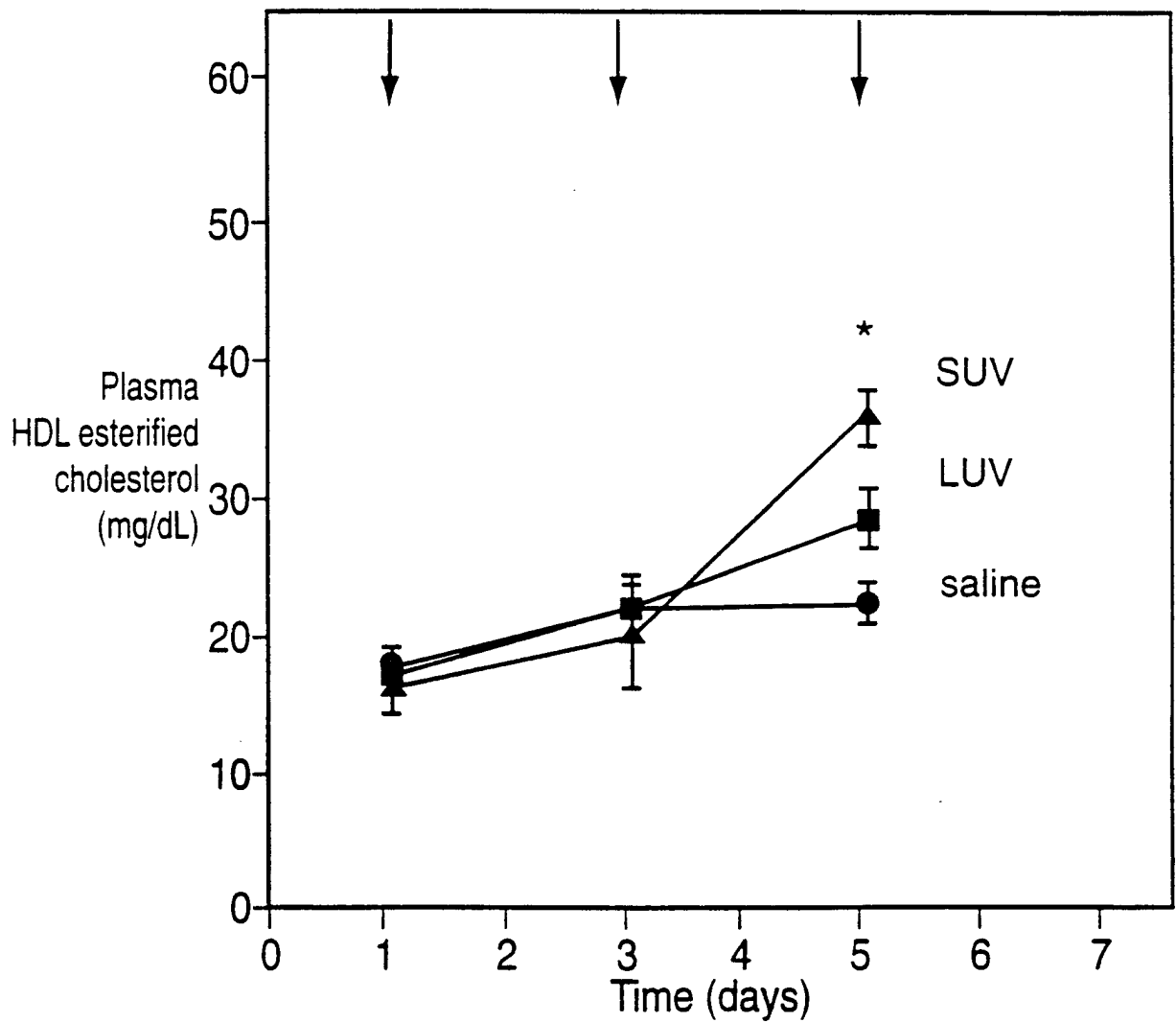

FIG. 14

15/28

HDL esterified cholesterol concentrations
in response to injections of LUV, SUV, or saline

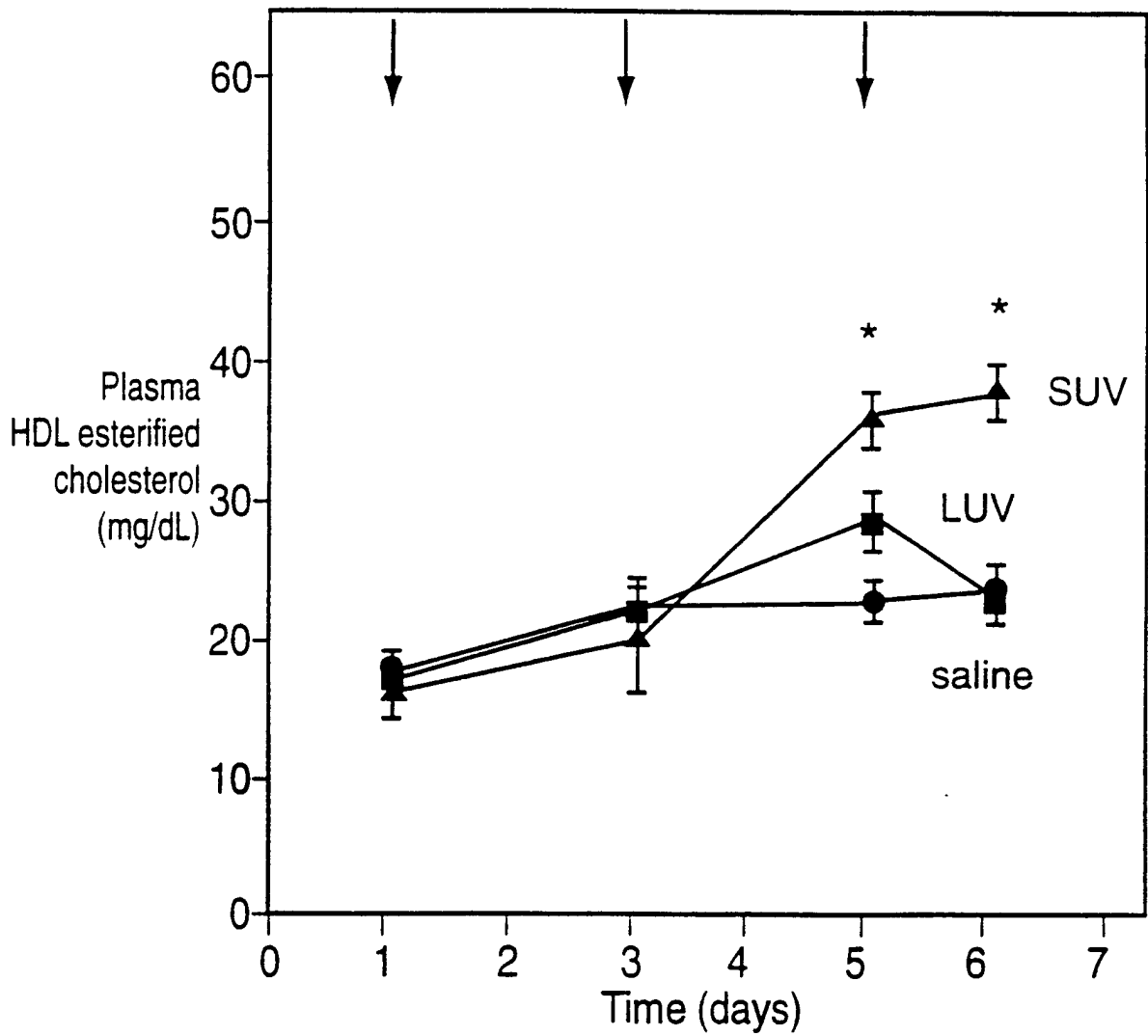

FIG. 15

16/28

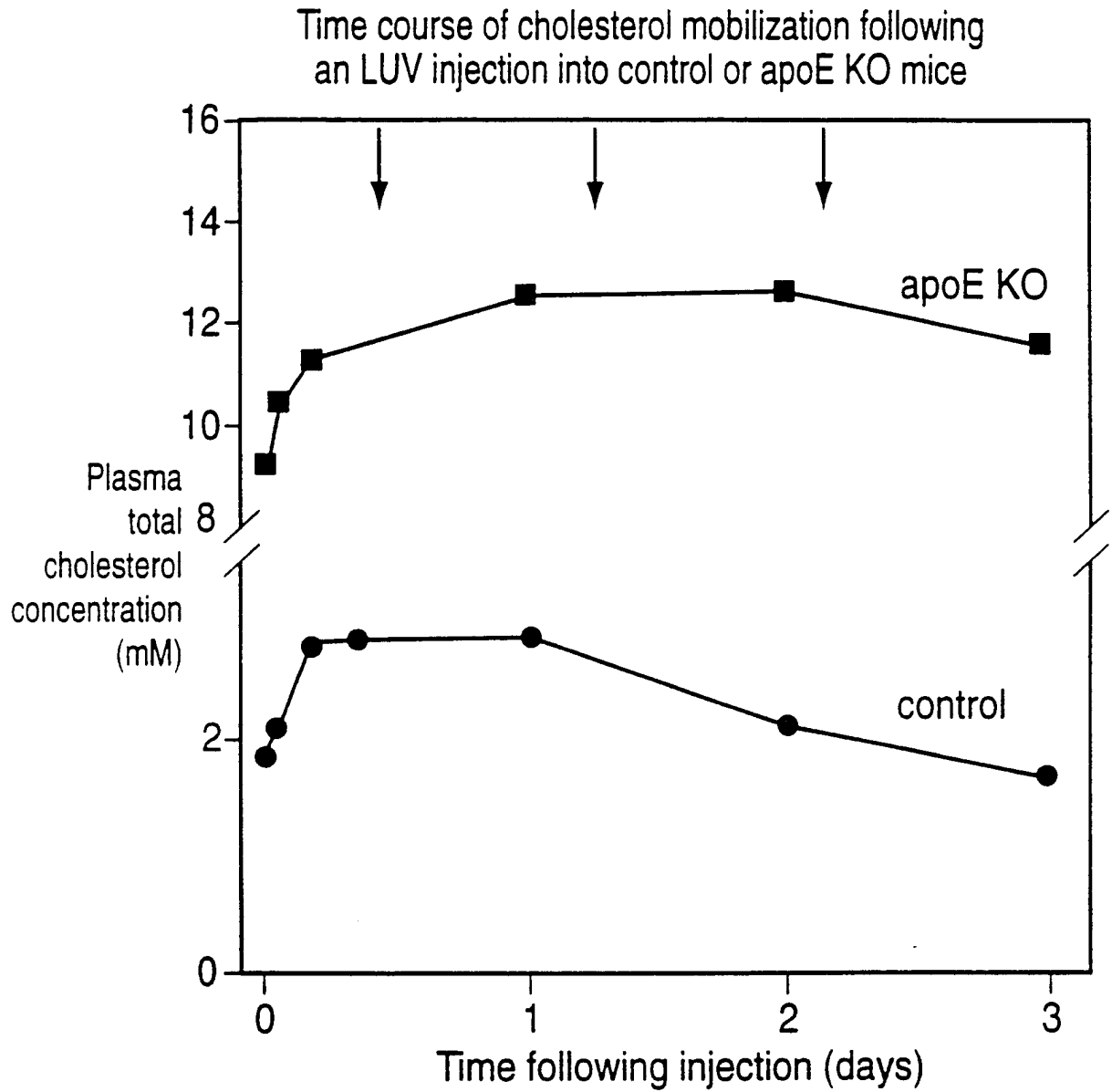

FIG. 16

Time course of LUV clearance in control C57BL6 and ApoE KO mice

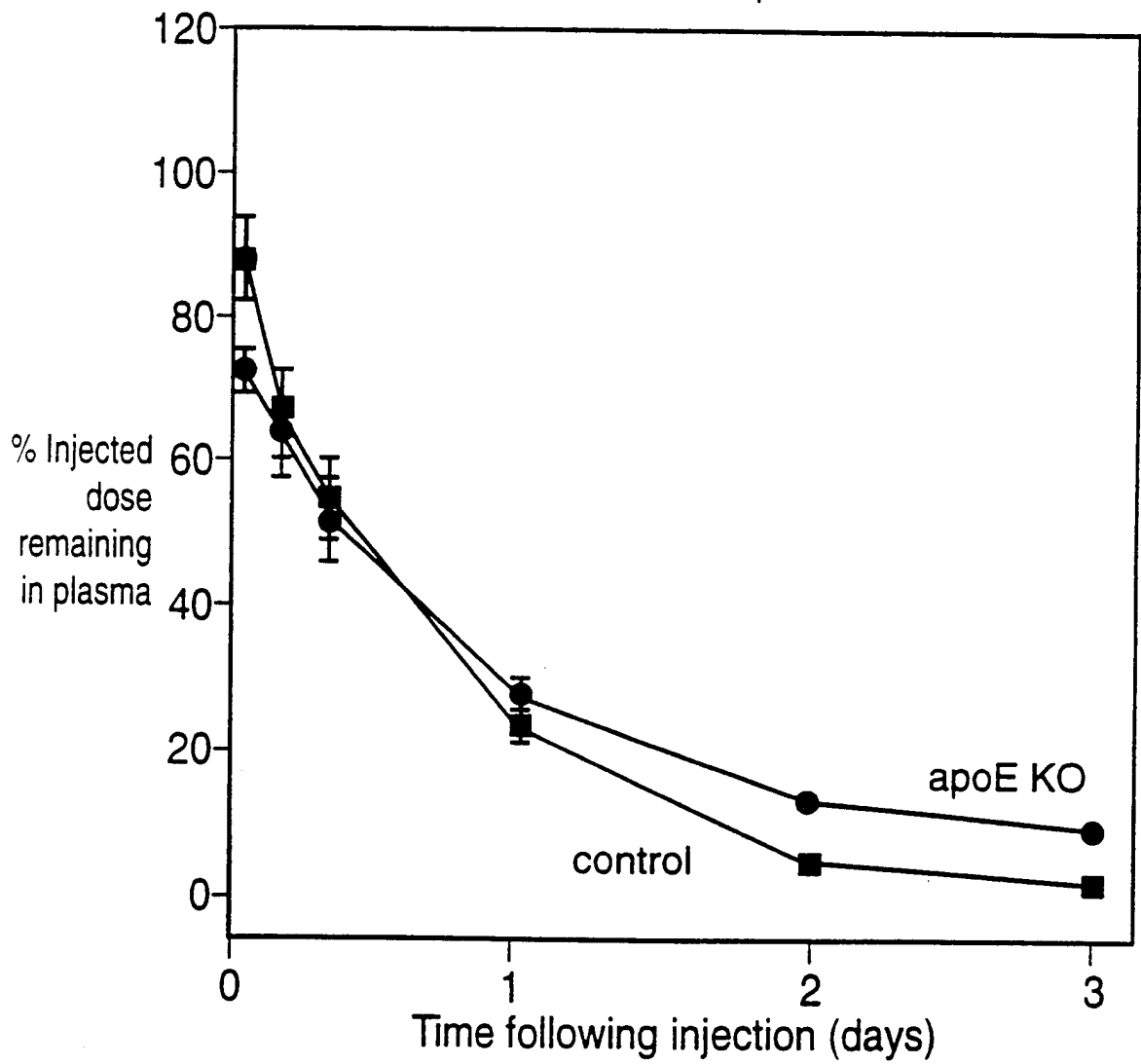

FIG. 17

18/28

- Effectiveness in humans

- Therapeutic targets

Lipid-rich, rupture-prone plaques
Critical Stenosis
Post-angioplasty re-stenosis
Atherosclerosis in general

FIG. 18

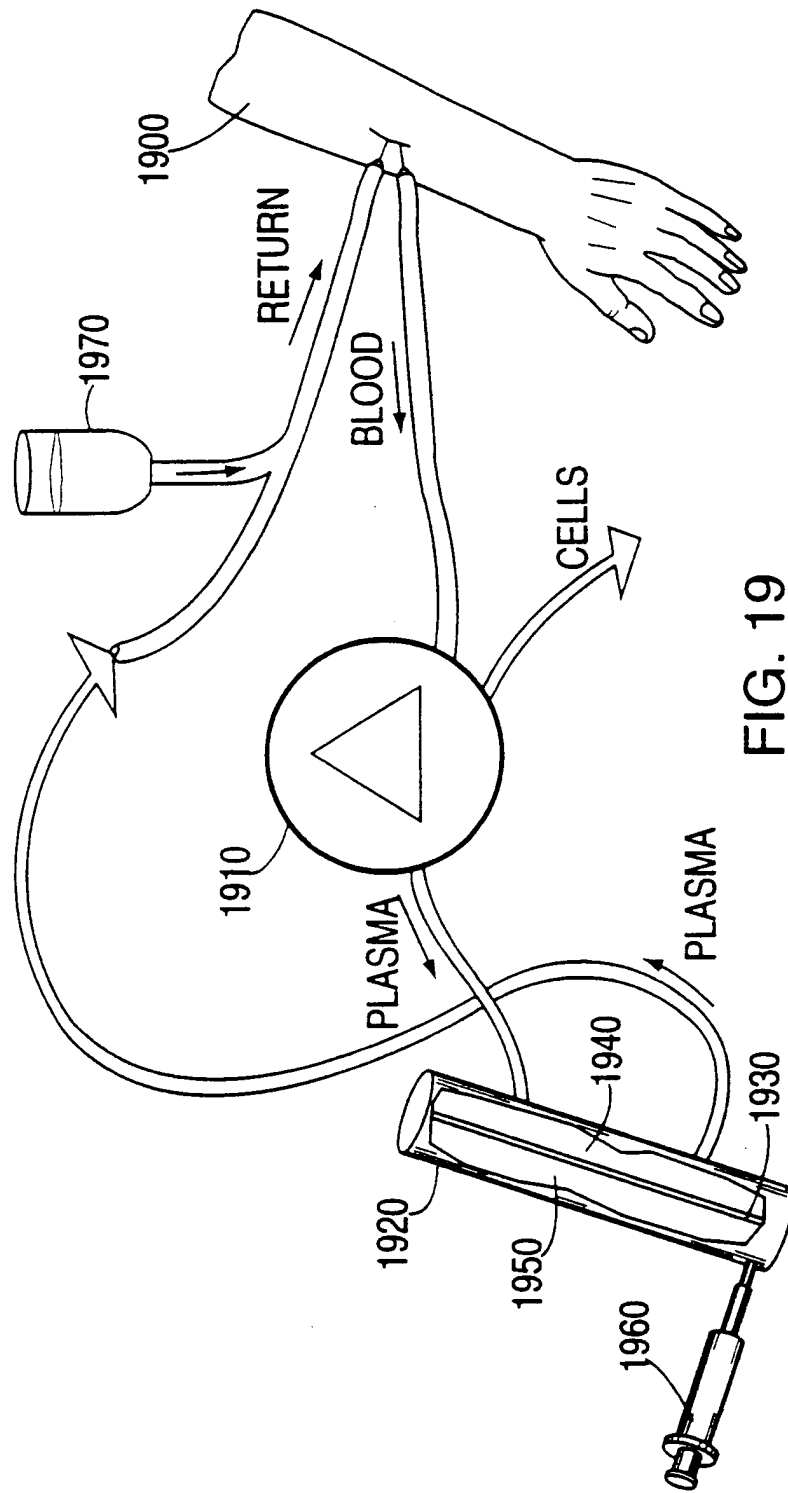

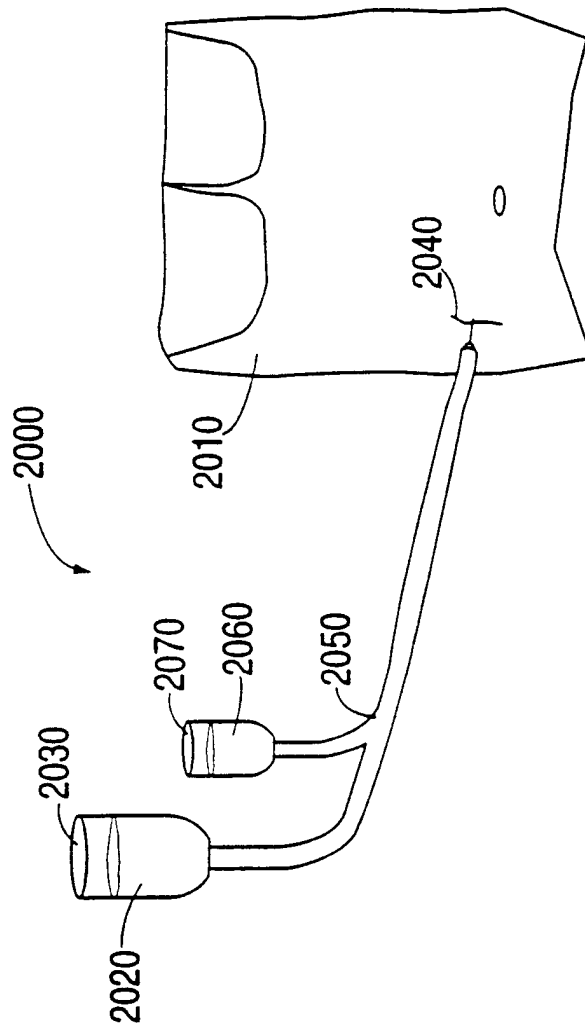

FIG. 20

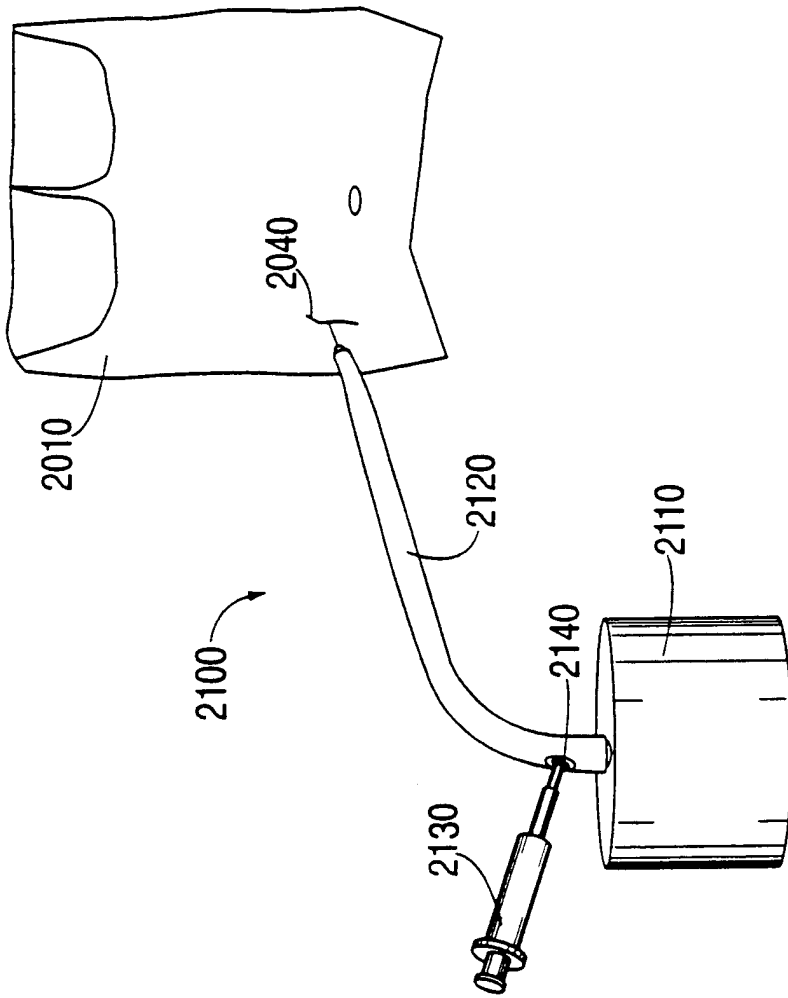

FIG. 21

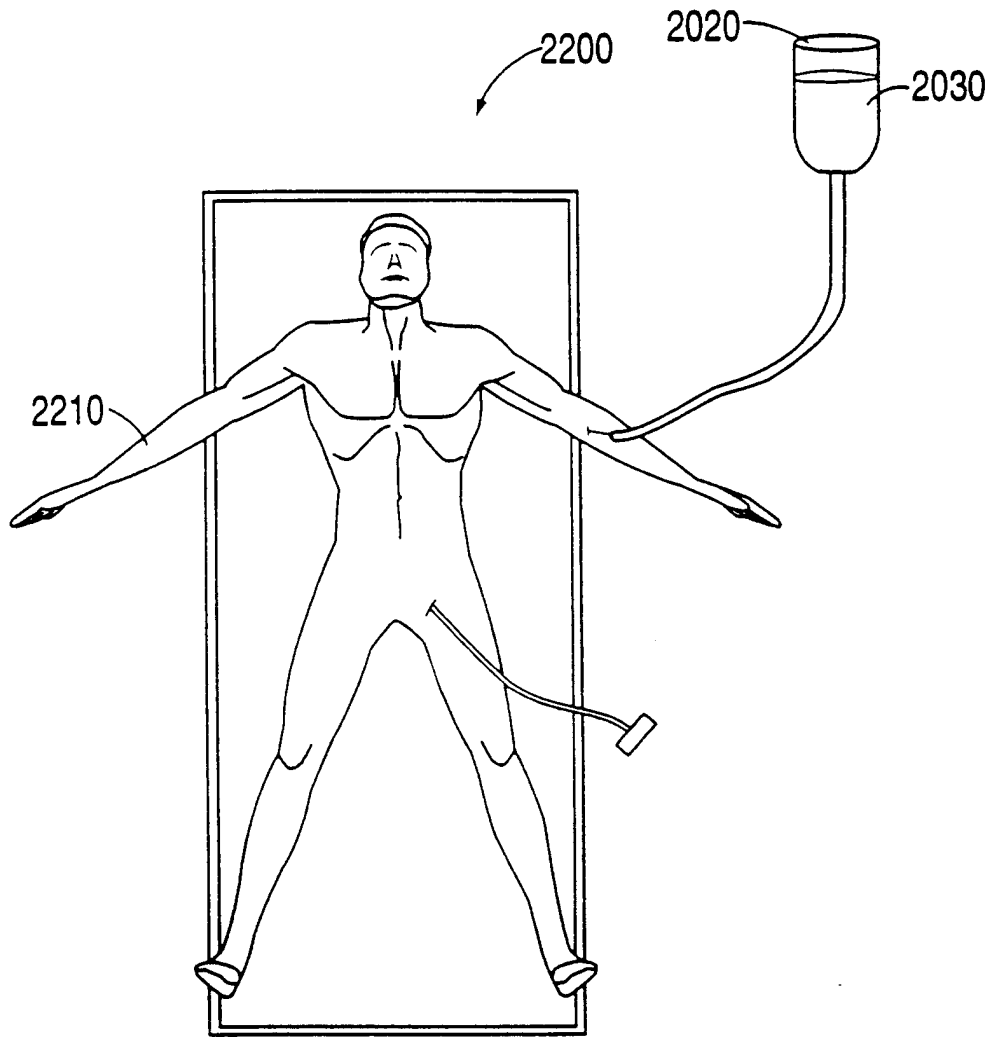

FIG. 22

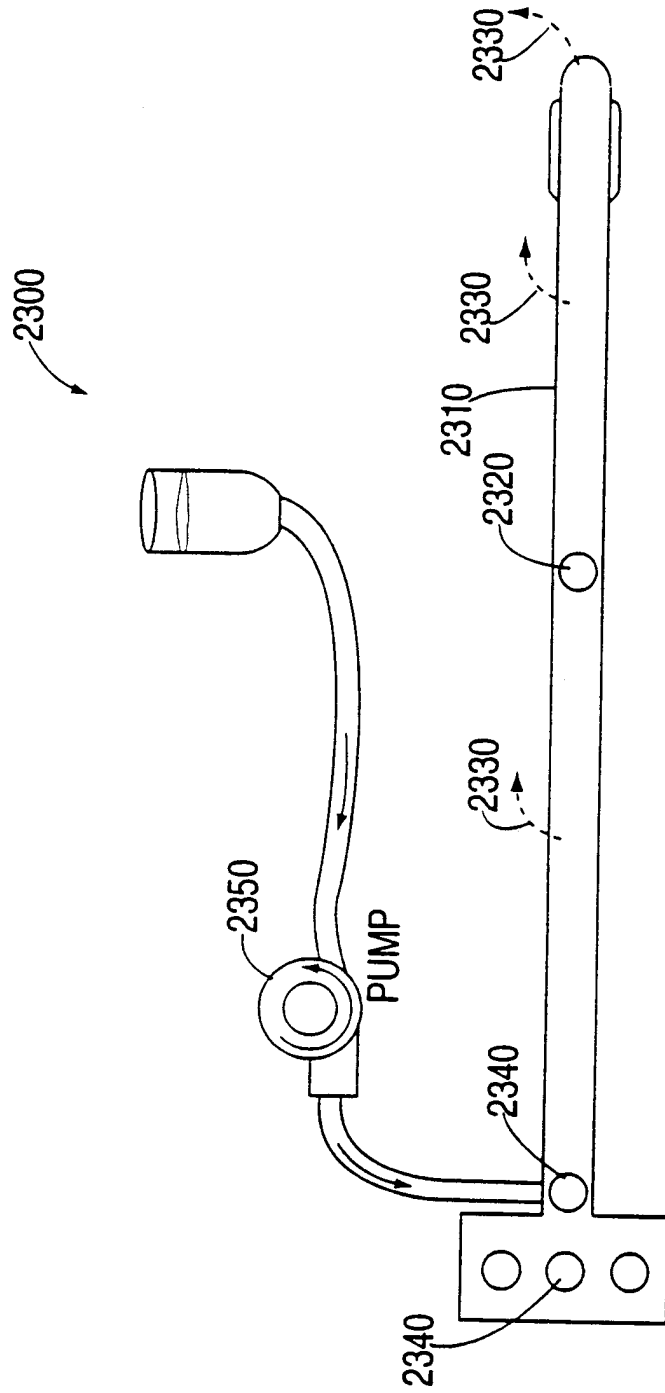

FIG. 23

Hepatic lipid contents in response to injections of LUVs, SUVs, or saline

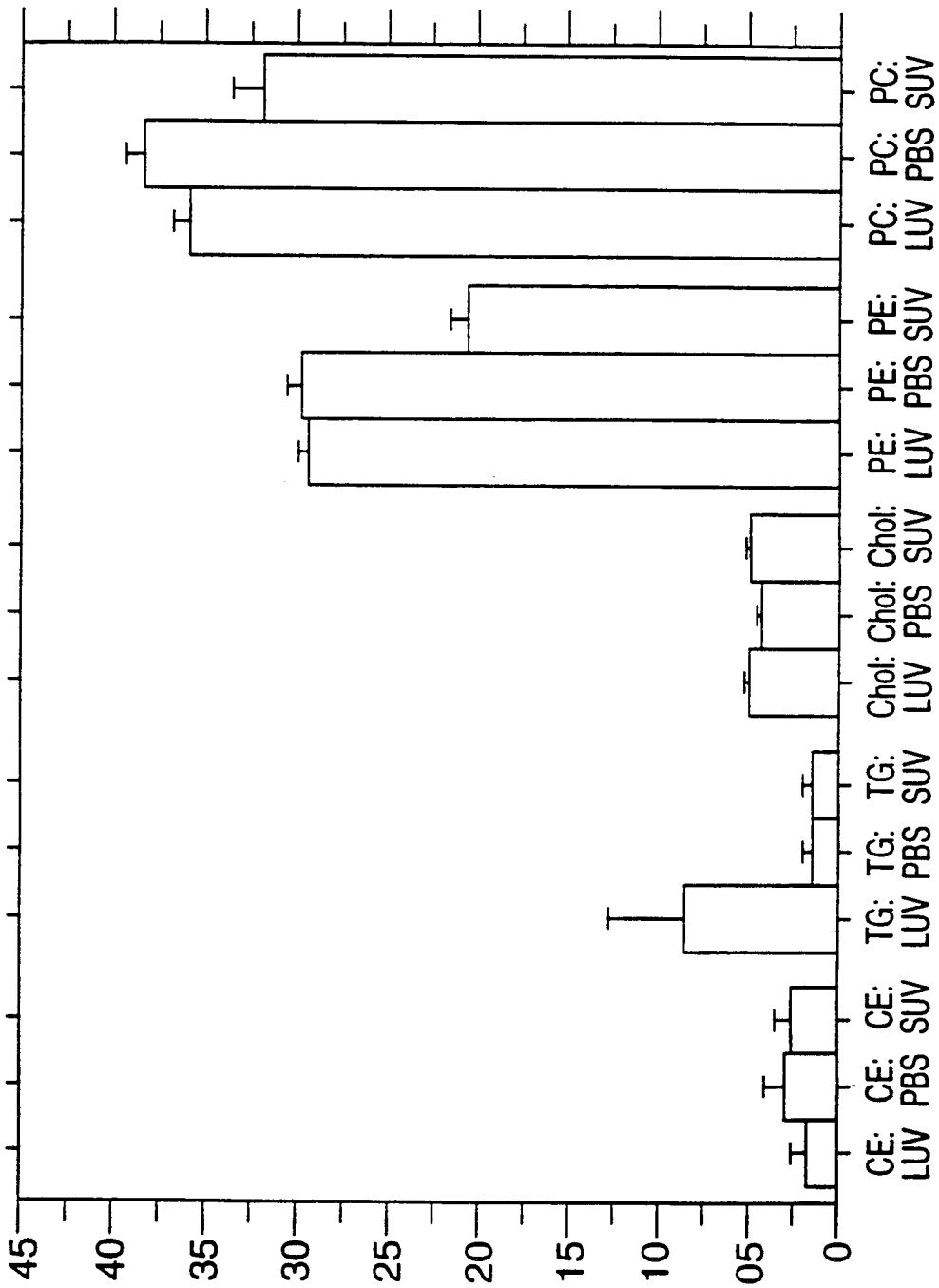

FIG. 24

25/28

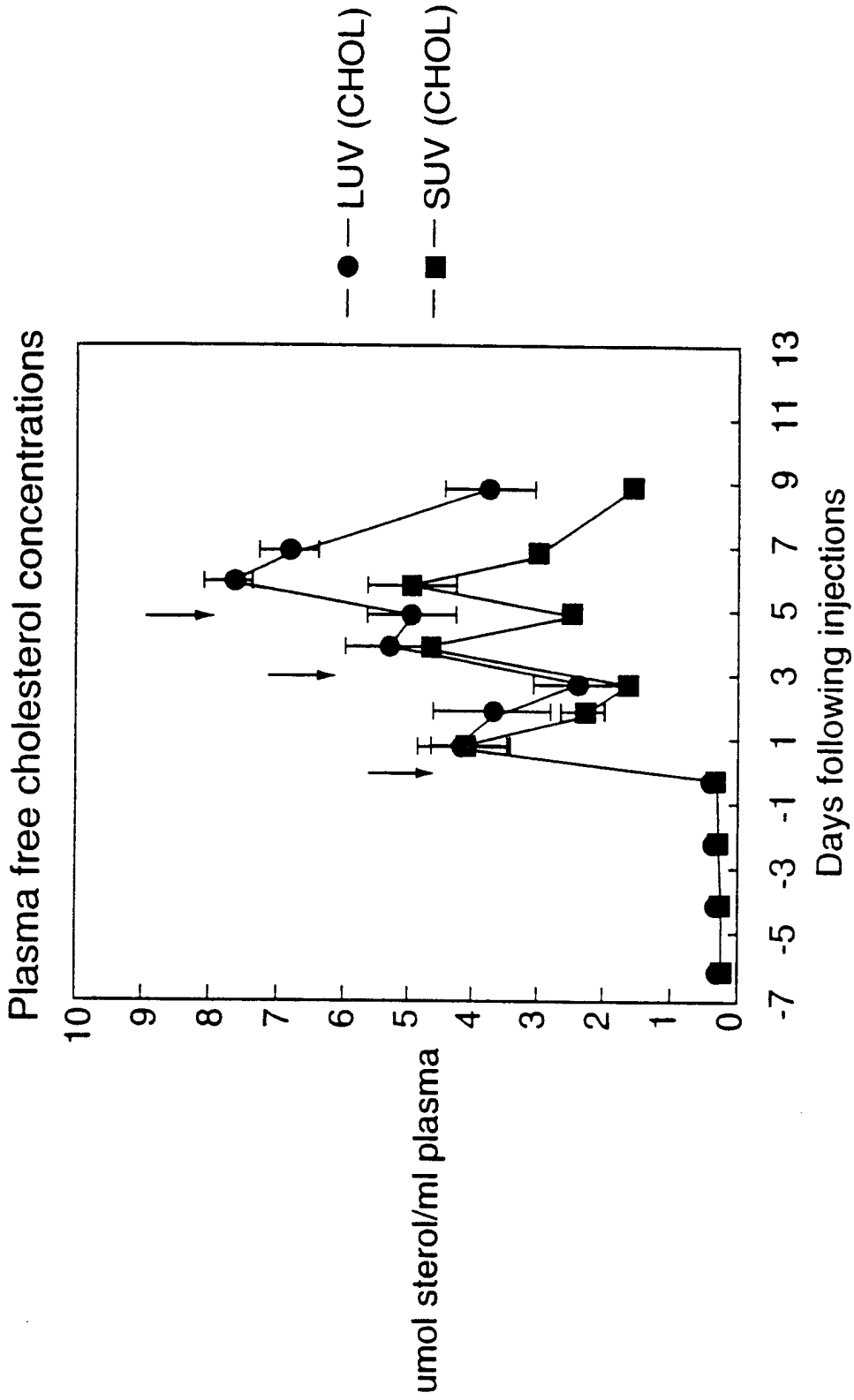

FIG. 25

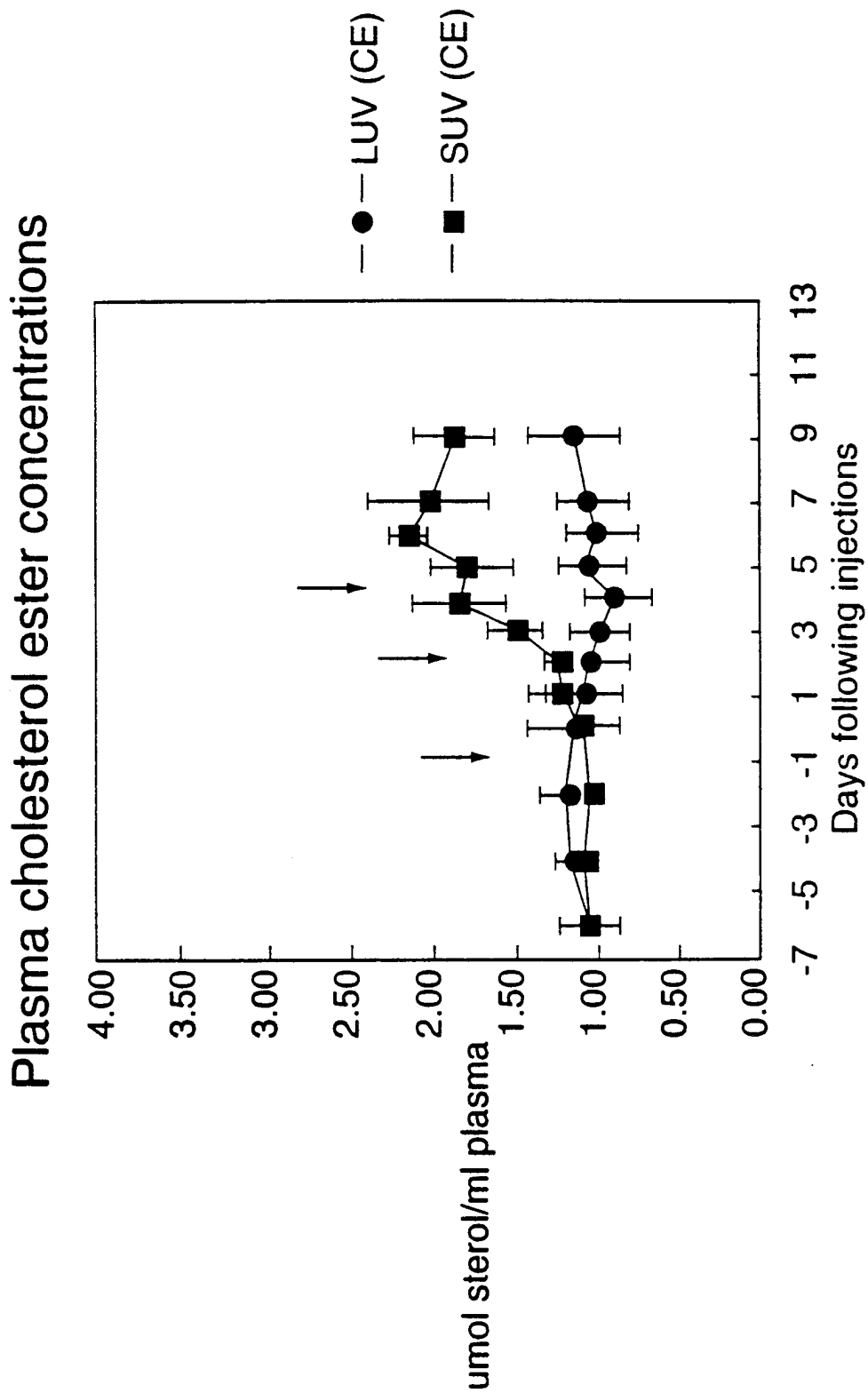

FIG. 26

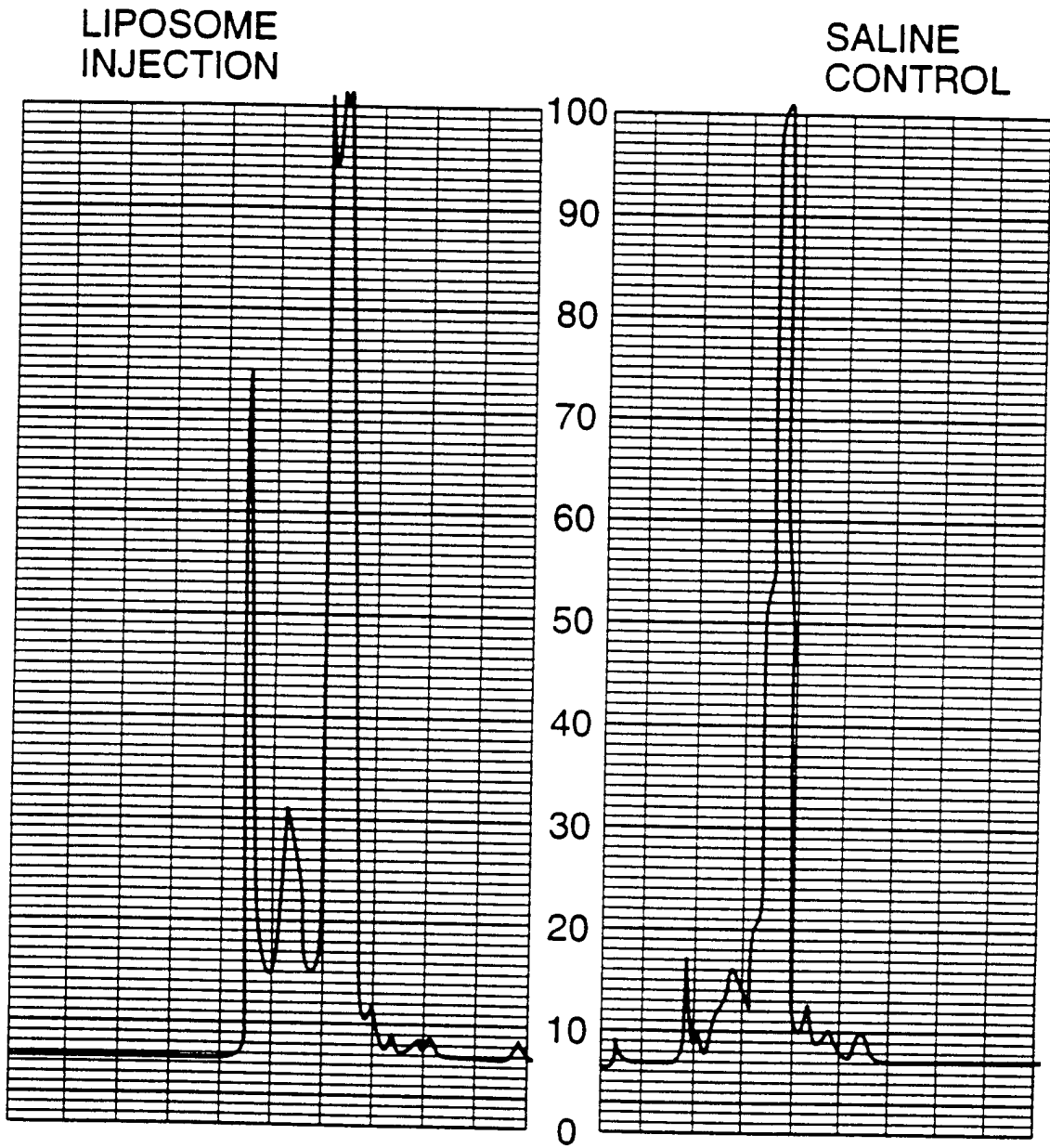

FIG. 27

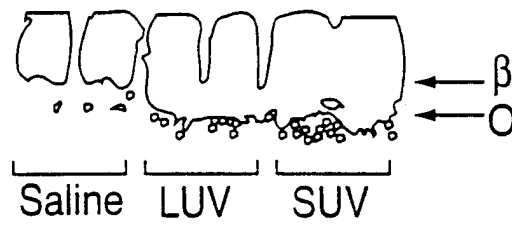
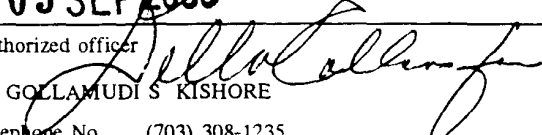

FIG. 28

INTERNATIONAL SEARCH REPORT

International application No.
PCT/US00/12962

A. CLASSIFICATION OF SUBJECT MATTER IPC(7) : A61K 9/127, 133 US CL : 424/450 According to International Patent Classification (IPC) or to both national classification and IPC		
B. FIELDS SEARCHED Minimum documentation searched (classification system followed by classification symbols) U.S. : 424/450 Documentation searched other than minimum documentation to the extent that such documents are included in the fields searched Electronic data base consulted during the international search (name of data base and, where practicable, search terms used) WEST: angina, liposomes, claudication.		
C. DOCUMENTS CONSIDERED TO BE RELEVANT		
Category*	Citation of document, with indication, where appropriate, of the relevant passages	Relevant to claim No.
Y	WO 95/23592 A (THE UNIVERSITY OF BRITISH COLUMBIA) 08 September 1995, abstract, examples and claims.	1-154
Y	US 5,843,474 A (WILLIAMS) 01 December 1998, abstract, col. 1, line 21 through col. 2, line 31, Examples and claims.	1-154
Y	US 5,674,488 A (REICH) 07 October 1997, abstract, col. 1, lines 57-59.	1-154
Y	US 4,895,719 A (RADHAKRISHNAN et al) 23 January 1990, abstract, col. 16, 31-43 and claims.	1-154
<input type="checkbox"/> Further documents are listed in the continuation of Box C. <input type="checkbox"/> See patent family annex.		
* Special categories of cited documents:	*T* later document published after the international filing date or priority date and not in conflict with the application but cited to understand the principle or theory underlying the invention	
A document defining the general state of the art which is not considered to be of particular relevance	*X* document of particular relevance, the claimed invention cannot be considered novel or cannot be considered to involve an inventive step when the document is taken alone	
E earlier document published on or after the international filing date	*Y* document of particular relevance, the claimed invention cannot be considered to involve an inventive step when the document is combined with one or more other such documents, such combination being obvious to a person skilled in the art	
L document which may throw doubts on priority claim(s) or which is cited to establish the publication date of another citation or other special reason (as specified)	*&* document member of the same patent family	
O document referring to an oral disclosure, use, exhibition or other means		
P document published prior to the international filing date but later than the priority date claimed		
Date of the actual completion of the international search 02 AUGUST 2000	Date of mailing of the international search report 05 SEP 2000	
Name and mailing address of the ISA/US Commissioner of Patents and Trademarks Box PCT Washington, D.C. 20231 Facsimile No. (703) 305-3230	Authorized officer  GOLLAMUDI S. KISHORE Telephone No. (703) 308-1235	

专利名称(译)	治疗心绞痛和/或心绞痛等效物的方法，以及与其相关的药物组合物和试剂盒		
公开(公告)号	EP1183011A1	公开(公告)日	2002-03-06
申请号	EP2000932314	申请日	2000-05-12
[标]申请(专利权)人(译)	ESPERION MERGERCO		
申请(专利权)人(译)	ESPERION MERGERCO公司		
当前申请(专利权)人(译)	ESPERION MERGERCO公司		
[标]发明人	GOLDBERG DENNIS I WILLIAMS KEVIN JON		
发明人	GOLDBERG, DENNIS, I. WILLIAMS, KEVIN, JON		
IPC分类号	G01N33/53 A61K9/06 A61K9/12 A61K9/127 A61K9/133 A61K9/70 A61K31/138 A61K31/165 A61K31/166 A61K31/167 A61K31/18 A61K31/21 A61K31/216 A61K31/277 A61K31/40 A61K31/401 A61K31/404 A61K31/4402 A61K31/4422 A61K31/4439 A61K31/4458 A61K31/4704 A61K31/49 A61K31/5377 A61K31/55 A61K31/66 A61K31/661 A61K31/675 A61K31/7048 A61K31/7076 A61K38/55 A61K45/00 A61K45/06 A61K47/30 A61K47/34 A61P3/00 A61P5/16 A61P7/02 A61P7/06 A61P9/04 A61P9/06 A61P9/10 A61P9/12 A61P11/00 A61P23/00 A61P25/20 G01N33/543		
CPC分类号	A61K9/127 A61K31/66 A61K31/685 A61K45/06 A61P3/00 A61P11/00 A61P23/00 A61P25/20 A61K31/00 A61K2300/00		
代理机构(译)	巴塞特RICHARD SIMON		
优先权	60/134140 1999-05-14 US		
其他公开文献	EP1183011A4		
外部链接	Espacenet		

摘要(译)

本发明提供治疗心绞痛的方法，例如治疗心绞痛。稳定性心绞痛，不稳定型心绞痛和变异型心绞痛，和/或心绞痛等效物，包括给予受试者治疗有效量的多种脂质体，优选包含基本上不含甾醇的磷脂的大脂质体治疗期。该方法还包括给予有效量的除脂质体之外的抗心绞痛药物。本发明还提供治疗跛行的方法，包括给予治疗有效量的脂质体。在又一个变体中，本发明提供了对象的围手术期和/或术前调理的方法，包括给予脂质体。本文还描述了若干其他发明。