



(11) **EP 3 024 397 B1**

(12) **EUROPEAN PATENT SPECIFICATION**

(45) Date of publication and mention of the grant of the patent:
20.12.2017 Bulletin 2017/51

(51) Int Cl.:
A61B 8/06 (2006.01) A61B 8/08 (2006.01)
A61B 8/00 (2006.01) G01S 15/89 (2006.01)

(21) Application number: **14771366.3**

(86) International application number:
PCT/IB2014/063077

(22) Date of filing: **14.07.2014**

(87) International publication number:
WO 2015/011599 (29.01.2015 Gazette 2015/04)

(54) **METHOD FOR ALIGNING SPATIALLY DIFFERENT SUBVOLUMES OF ULTRASONIC DATA OF A BLOOD VESSEL**

VERFAHREN ZUM AUSRICHTEN VON RÄUMLICH UNTERSCHIEDLICHEN SUBVOLUMINA VON ULTRASCHALLDATEN EINES BLUTGEFÄSSES

PROCÉDÉ POUR L'ALIGNEMENT SPATIAL DE SOUS-VOLUMES DE DONNÉES ULTRASONORES D'UN VAISSEAU SANGUIN

(84) Designated Contracting States:
AL AT BE BG CH CY CZ DE DK EE ES FI FR GB GR HR HU IE IS IT LI LT LU LV MC MK MT NL NO PL PT RO RS SE SI SK SM TR

(30) Priority: **24.07.2013 US 201361857833 P**

(43) Date of publication of application:
01.06.2016 Bulletin 2016/22

(73) Proprietor: **Koninklijke Philips N.V.**
5656 AE Eindhoven (NL)

(72) Inventors:
• **GOVINAHALLISATHYANARAYANA, Sushanth**
5656 AE Eindhoven (NL)
• **SISODIA, Rajendra, Singh**
5656 AE Eindhoven (NL)
• **BUSSA, Nagaraju**
5656 AE Eindhoven (NL)
• **PALANISAMY, Krishnamoorthy**
5656 AE Eindhoven (NL)

- **BASAWARAJ PATIL OKALY, Vikram**
5656 AE Eindhoven (NL)
- **SETHURAMAN, Shriram**
5656 AE Eindhoven (NL)
- **PETRUZZELLO, John**
5656 AE Eindhoven (NL)
- **ZHOU, Shiwei**
5656 AE Eindhoven (NL)
- **ANAND, Ajay**
5656 AE Eindhoven (NL)
- **ERKAMP, Ramon, Quido**
5656 AE Eindhoven (NL)
- **VENKATESAN, Shankar, Mosur**
5656 AE Eindhoven (NL)

(74) Representative: **Steffen, Thomas**
Philips Intellectual Property & Standards
High Tech Campus 5
5656 AE Eindhoven (NL)

(56) References cited:
WO-A1-00/72756 WO-A1-2013/088320

EP 3 024 397 B1

Note: Within nine months of the publication of the mention of the grant of the European patent in the European Patent Bulletin, any person may give notice to the European Patent Office of opposition to that patent, in accordance with the Implementing Regulations. Notice of opposition shall not be deemed to have been filed until the opposition fee has been paid. (Art. 99(1) European Patent Convention).

Description

[0001] This invention relates to medical diagnostic ultrasound systems and, in particular, to a non-imaging Doppler probe system for automated screening of carotid stenosis.

[0002] Stroke is the third leading cause of death worldwide. According to the World Health Organization, stroke accounted for more than 5.5 million deaths in 2002 with about 50% of those deaths occurring in China and India. Although the incidence is declining in developed countries, stroke nevertheless accounts for a mortality of 163,000 in the United States. A significant portion of these deaths are believed to be a result of disease in the carotid bifurcation. The carotid artery bifurcation, where the common carotid artery (CCA) branches into the internal (ICA) and external (ECA) carotid arteries, is a common site of atherosclerotic disease. Stenosis or narrowing of the ICA, the branch which supplies blood to the brain, has long been known to be related to the incidence of ischemic stroke. The use of the severity of carotid stenosis has evolved as a surrogate measure of the risk of stroke.

[0003] The incidence of carotid atherosclerosis and mortality associated with stroke is an increasing problem in the developing world. In these countries, a carotid artery screening device that can be used in low resource settings would address this growing problem by offering several features. First, there is often a lack of skilled personnel in these settings, and so the device should be able to be used with minimal training and instruction. Second, the device should be inexpensive so as to be affordable in these settings. Third, the device should be able to classify the degree of stenosis in the carotid arteries in a highly automated way without the use of high-end duplex ultrasound scanners that may not be available in the rural setting. WO 2013/088320 A1 discloses a closest prior art method, namely a method for generating a three dimensional blood vessel map comprising: acquiring temporally discrete signals of a blood vessel in a first subvolume with independently operated elements of a two dimensional array of ultrasonic transducer elements from spatially different depths of scanning opposed by each transducer element, said array being located in a first position with respect to the blood vessel during the acquiring; Doppler processing the temporally discrete signals received from each transducer element to produce spectral Doppler data of the scanning depth in the first subvolume opposed by each transducer element; producing a first three dimensional map of the spectral Doppler data in spatial relationship to the position of the array with respect to the blood vessel in the first subvolume. In accordance with the principles of the present invention, a diagnostic ultrasound system for carotid artery diagnosis includes a simple, non-imaging Doppler ultrasound probe. The probe has a two dimensional array of transducer elements with a low count of elements of relatively large size which can cover an area of the carotid artery at its bifurcation. The large sized elements are operated independently with no phasing, thereby reducing the cost of the Doppler system. The probe and system of the present invention can produce a representation of carotid blood flow in two or three dimensions and can assemble an extended view of the flow by matching segments of the carotid flow as the probe is moved over the vessel. Once the carotid artery has been localized, the degree of stenosis is assessed by automated measurements of peak systolic velocity and blood flow turbulence.

[0004] In the drawings:

FIGURE 1 illustrates in block diagram form an ultrasound system constructed in accordance with the principles of the present invention.

FIGURE 2 illustrates the size and dimensions of the elements of an array transducer of a probe of the present invention.

FIGURE 2a illustrates the angling of the transducer elements of the array of FIGURE 2 for good Doppler reception.

FIGURE 3 illustrates a probe placement display of an ultrasound system of the present invention which guides an operator in proper probe placement over the carotid artery.

FIGURE 4 illustrates the operation of a Doppler probe of the present invention in discrete rows of elements.

FIGURE 5 illustrates a two dimensional vessel map produced by an ultrasound system of the present invention.

FIGURE 6 illustrates a three dimensional vessel map produced by an ultrasound system of the present invention.

FIGURE 7 illustrates the progressive assembly of a three dimensional vessel map produce by scanning with a probe and system of the present invention.

FIGURE 8 illustrates spectral Doppler displays of flow conditions encountered in the carotid artery.

FIGURE 9 is a flow chart of the automated assessment of turbulence and peak systolic velocity in a system of the present invention.

FIGURE 10 is a diagram of the basic steps of flow analysis in accordance with the present invention.

FIGURE 11 illustrates a Doppler spectrum with the upper and lower extremes of its envelope traced.

[0005] Referring first to FIGURE 1, an ultrasound system constructed in accordance with the principles of the present invention is shown in block diagram form. An ultrasound probe 10 contains a transducer array 12 of transducer elements which transmit ultrasound waves into the body and receive returning echo signals for Doppler processing. Control and timing of ultrasound transmission and reception is provided by a beamformer controller 16 which controls system beam-

former 14. The beamformer 14 is not a conventional delay-and-sum beamformer as the transducer array is not operated in a phased manner. Instead, each element is separately actuated to transmit ultrasound waves directly into the body from its front surface and receive reflections from the waves individually. The beamformer controls the timing of successive transmit-receive intervals (the pulse repetition interval or PRI) by each transducer so that an ensemble of temporally spaced echoes is received by each transducer element at successive depths over a depth range of interest, which is the nominal depth at which the carotid artery is located. Each ensemble of echo samples can then be Doppler-processed to detect the flow condition in front of every transducer element. A quadrature bandpass filter 18 processes the echo signals into quadrature I and Q components. The separate components are used by a Doppler angle estimator 20 to estimate the phase or frequency shift of a Doppler signal at the depths in front of each transducer element where Doppler interrogation is to be performed. Alternatively Doppler power may be estimated. The Doppler frequencies or intensities at depths in front of each transducer which are produced by the Doppler angle estimator 20 can be mapped directly to velocity values of flow or Doppler power at those depth locations.

This Doppler data is coupled to a flow image processor 30 which spatially processes the data into a two or three dimensional image format, in which the velocity values are color- or intensity-coded. This spatial Doppler vessel map is processed by a display processor 36 and displayed on display 52 to illustrate the locations in the anatomy beneath the array transducer where flow is taking place and the velocity and direction of that flow by the color coding or Doppler power by intensity modulation. Doppler data is also coupled to a spectral Doppler processor 32 which produces a spectral analysis of the Doppler data for peak systolic velocity and turbulence analysis as described below. A Doppler angle processor 40 conditions the process for the angle of Doppler interrogation which is preferably set by inclining the direction of wave transmission by the transducer elements as described below. A graphics processor 34 is provided to overlay vessel map coordinates and other graphical data such as patient name on the displayed image. A volume renderer 24 performs volume rendering of three dimensional vessel map data for the production of three dimensional vessel maps as described below. The entire system is operated by user controls 50.

[0006] FIGURE 2 illustrates a transducer array 12 for a probe 10 of the present invention. This embodiment is an array for a probe with a total of 80 elements, each measuring 3 mm by 3 mm arranged in a two dimensional matrix containing 10 rows by 8 columns. In such a configuration, the area of coverage is 30 mm by 24 mm. Transducer arrays with this small number of elements and elements of this relatively large individual size are easier to dice than fine-pitched array elements, making this array simple to fabricate with high yields and hence relatively inexpensive to make. The factors to consider in selecting the number of element include coverage, resolution, and a number which provides acceptable accuracy as compared to a standard ultrasound probe. Element sizes ranging from 3mm by 3mm to 6mm by 6mm have been found to be acceptable for unfocused elements used with nominal depths of the carotid artery. An array size of around 40mm has been found suitable for covering the branches of the carotid artery. As FIGURE 2 illustrates, the probe is intended to be placed against the neck of a patient over the carotid artery. When the probe aperture is longitudinally in line with the carotid artery and the bifurcation of the artery is within the field of view, the transducer will cover an appreciable area of the carotid artery with the common carotid artery (CCA) at one end and the internal (ICA) and external (ECA) branches at the other end. The elements in the probe are placed at an angle to provide a Doppler angle of 30-60 degrees. As is well known, no Doppler signal can be obtained when the direction of blood flow is orthogonal to the direction of the ultrasound waves, and maximal signals are obtained when the wave are directed in line with the flow. Thus, if the elements of the array 12 were aimed straight into the body, little or no Doppler signals would be realized from the carotid flow immediately beneath the array. To account for this directional sensitivity the elements of the array 12 are angled at an angle of 30-60 degrees away from normal as illustrated in FIGURE 2a. A tilt of around 30 degrees has been found to yield acceptable results. Additional angulation can be provided by tilting the probe in relation to the skin surface during scanning. This drawing shows the end elements 12-1, 12-2, 12-3 and 12-4 of the first four rows of elements canted at the selected Doppler angle and retained in position by an overlying layer of transducer lens material layer 11 which is generally a polymeric rubber-like material such as RTV. The thickness of the RTV lens can be uniform across the array transducer, or can be tapered in thickness to provide some or all of the tilt for setting the nominal Doppler angle. The Doppler angle at which the elements are angled can be entered into the ultrasound system automatically from the probe's personality chip or manually from the user controls to condition the system to account for the proper angle correction to be used for the Doppler angle of the probe elements. The system may desirably also include a Doppler angle feedback indicator controlled by an algorithm that processes the strength of the Doppler return signals and detects unfavorable Doppler angles, which suggests that the user manually reposition the probe at a more favorable angle.

[0007] The elements of the array transducer are excited with excitation pulses to work in the pulsed wave mode. In the pulsed wave mode, it is possible to provide depth resolution of the Doppler signals. For instance, an element size of 3 mm by 3 mm generally provides enough resolution to sample and obtain the velocity in a narrow region of the high speed jet produced in carotid arteries with stenosis. The elements of the non-phased transducer array 12 are fired simultaneously or independently in a customizable firing sequence under control by the beamformer 14.

[0008] Operation of a probe and system of the present invention proceeds as follows. A sequence of elements (a

small sub-section of the entire probe) is fired simultaneously. The sample volume for Doppler flow interrogation in front of each element is increased sequentially to cover a range of depths. In the embodiment of FIGURE 4, in which the probe contains an array of 96 elements, 4 rows could be activated simultaneously, e.g., rows #1, #5, #8 and #12 as shown in this drawing. The Doppler spectrum is acquired continuously from each of the 8 elements in each of these rows. After at least 3 cycles of Doppler flow data are acquired, the flow image processor 30 computes a sum-plot (integration of Doppler power in a specified frequency band, e.g. 300 Hz to 1500 Hz). The magnitudes of the sum-plot values enable the elements that are directly above the vessel to be identified. For instance, transducer element 12-25 is not over a portion of the carotid artery and will sense no flow (will produce a negligible power Doppler signal.) Transducer element 12-61, on the other hand, is directly above the carotid artery and will produce a significant power Doppler signal. The flow image processor 30 can then produce a grid-like map of the location and position of the carotid artery branches beneath the probe as indicated in FIGURES 4 and 5. Each box in an 8 by 12 display grid is filled in with a brightness or color when a significant Doppler signal is detected by a corresponding transducer element, and is not illuminated when substantially no Doppler signal is detected. In FIGURE 4, for instance, the third, fourth, seventh and eighth boxes in the first row of the grid are illuminated in response to the detection of flow in the ICA and ECA by those elements in that row which are over those carotid branches. A similar result is obtained from elements 34, 35, 38 and 39 in row 5. Boxes corresponding to elements 59-63 of row 8 are illuminated because they detected flow in the CCA below the carotid bifurcation, as is also the case for boxes corresponding to elements 92-94 in row 12. As FIGURE 4 illustrates, this will present a simple two dimensional grid vessel map of the flow in the carotid artery beneath the array transducer. A similar result can also be obtained in the depth dimension as shown in FIGURE 5. This shows the results from depth-gating the Doppler signal samples from six discrete depths below the elements in the top and bottom rows of the array 12. The transverse maps to the right of the array illustration shows faintly illuminated blocks at six depths where the second, third, seventh and eighth elements in the top row have detected flow in the ICA and the ECA. The lower map shows a wider, more illuminated set of depth blocks where the center three elements of the bottom row of elements have detected the stronger flow in the CCA which is beneath that row of elements. The values of these vertical depth block in each column can be combined in various ways to obtain a display value for a box in the longitudinal display shown to the left of the transverse maps, if desired.

[0009] An object of an implementation of the present invention is to provide real-time feedback to the user such that the user is guided in placing the probe on the neck so that it covers the bifurcation of the carotid artery. Since this is a non-image based system, feedback can be given to the user through a set of indicators on the screen that guides the user to move the probe in the appropriate direction. In this example, the ideal placement of the probe is when the flow image detector detects a single vessel branch (CCA) at rows 8 & 12 of the grid display and two separate vessel branches (ICA and ECA) in rows 1 & 5 of the grid as shown in FIGURE 4. The elements in these rows are continuously fired and the flow image processor computes the accumulated Doppler power of the signals received by each element in real time. The grid blocks which are illuminated in response to significant Doppler signal returns inform the system of the placement adjustment needed to obtain good probe placement. If the placement is good, the "OK" indicator is highlighted in the probe guidance display of FIGURE 3. If not, appropriate one of the arrows in the guidance display are highlighted to guide the user in probe placement. An optimal positioning of the probe is achieved when the display grid showing the depth accumulated Doppler power (FIGURE 4) indicates a separation of the vessel segments in the carotid bifurcation. The "Probe placement" and "Vessel Mapping" display buttons at the bottom of the guidance display tell the user the current mode of operation, either probe placement or vessel mapping. If the user is in the Vessel Mapping mode and wants to readjust the positioning of the probe over the carotid artery, the user taps the Probe placement display button to return the system to that mode and the Probe placement button responds by illuminating. Since approximately 3 seconds worth of Doppler data is required for a single iteration, a guidance indication can be determined and updated in a time of 3 seconds. The maximum time to achieve acceptable placement of the probe over the carotid artery depends on the number of iterations required to successfully place the probe in the proper position for carotid artery stenosis detection.

[0010] Once the probe is placed, the next step is to obtain ultrasound Doppler data from all the elements in the probe array and map the vessels in accordance with the elements which detect flow. The accumulated Doppler power is computed as described above in conjunction with FIGURE 5 for the depths of interest to generate a 3D representation of the carotid vessels. The 3D representation is produced from the depth values detected by all of the elements and processed by the volume renderer 24 into a 3D display map. As shown in FIGURE 6, a 3D display map 60 of the bifurcated vessel is displayed.

[0011] Following vessel mapping in either two (FIGURE 4) or three (FIGURE 6) dimensions, Doppler data is acquired from all of the elements to extract the peak systolic velocity which can aid in classification of a stenosis. Additionally if desired a Doppler spectrum can be extracted at a suspected point of stenosis to further aid the diagnosis as described below.

[0012] When the probe 10 has a small aperture, it may not be possible to acquire a sufficiently sized portion of the carotid, its branches and bifurcation in a single acquisition. In such a case multiple volume acquisition is employed to

acquire segments of the carotid artery in sub-areas or sub-volumes by movement of the probe along the neck, then stitching the smaller segments together to form the desired vessel map. Manual movement of probe implies that there is no calibration, the overlap region may vary among two consecutive acquisitions, and there is also potential variation in the angle and quality of signal acquisition. Thus, instead of all the data being acquired in one volume, data is acquired in multiple sub-volumes to cover the entire carotid anatomy. From the multiple acquisitions, the carotid vascular anatomy must be reconstructed to verify if the entire carotid anatomy was scanned, and so the sub-volumes must be stitched together. This is done by "stitching" together successively acquired, spatially different but overlapping subvolumes by aligning their matching data in the overlapping region. The overlapping region of each subvolume is determined from a match of the time domain Doppler obtained from the individual transducer elements. As a simple example, one subvolume may have a column of voxels with flow velocity values of 0, 3, 5, 3, and 0 cm/sec. When a matching column of voxels in an overlapping subvolume is found with the same or similar Doppler values, the subvolumes are aligned on the basis of this identity of sequential voxel values. Other Doppler spectral characteristic instead of or in addition to velocity can be used to make the match. This stitching is performed purely based on the signal characteristics because relative position of the probe with reference to the neck is not easy to obtain.

[0013] Accurate vessel stitching is essential in order to reconstruct the vascular anatomy to estimate the angle of insonation across multiple volumes at one sweep of the probe. This enables the determination of peak systolic velocity across the anatomy. Peak systolic velocity is a clinically accepted diagnostic indicator to grade stenosis according to the following consensus criteria:

Degree of stenosis	PSV (cm/s)
Normal or <50 %	<125
50% - 69%	125-230
>70%	>230
Total occlusion	No flow

[0014] Since the probe is non imaging, it is difficult for the user to understand how much of the artery cluster under investigation has been covered by a sweep of the probe. It is difficult to interpret from the reconstruction of any of the typical sampled sub-volumes, e.g., (a) (b) or (c) of FIGURE 7, whether the artery structure has been covered with anatomical cues from a single volume. Therefore, the data from multiple volumes is stitched together to completely reconstruct the vascular anatomy and provide an anatomical basis for artery identification. Anatomical cues from the generated vessel map of the sub-volumes are used as well as signal characteristics to complete the vascular anatomy reconstruction. When the Doppler signal is of sufficient signal to noise ratio to obtain a complete anatomical reconstruction in pulsatile flow, and the probe is moved uniformly over the artery structure under investigation, the following steps may be employed in accordance with the present invention to reconstruct the full anatomy. First, the probe is placed in a location L1 resulting in acquisition of sample volume V1. The probe is manually moved to location L2, adjacent to L1 such that the resulting new acquisition sample volume V2 is partially overlapped with V1. Each volume in this example is a three dimensional matrix containing returned ultrasound echo data. Next, further sample volumes Vn are acquired in the same manner, such that the vessel structure of interest is fully covered. Since this is a non-imaging approach, it may not be feasible to know the completion of vessel map reconstruction until the end of the process.

[0015] Next, for each volume Vi, signal in the volume is identified by highlighting the different segments in the 3D space of the vessel as shown in FIGURE 7. Vessel map identification is used to identify a vessel segment in a given volume. Let VM = a list of unique vessel segments identified using the previous step. The number of vessel segments VM_i is compared among the sample volumes. This helps to clearly identify the region of overlap in the sample volume where the number of regions is non uniform, such as the volume containing the bifurcation point of the carotid artery, using anatomical information from the reconstruction. It also gives an indication of where to search for matching signal data, e.g., the overlap between FIGURE 7(b) and FIGURE 7(c) can only be where there are two distinct vessels in FIGURE 7(b).

[0016] The data of all the good spectra from the top most row of each column of one sample volume is extracted in order, and correlated with the data of each of the rows of the subsequent (adjacent) volume. A spike in correlation at row k indicates that all the data from row k to the last row of the probe are in the overlapping region. Since the effects of noise are unpredictable on the signal, it may happen that one of the acquisitions of the overlapping volumes is more contaminated by noise than the other. In this case, the overlapping area is assigned to the volume where this area has more analyzable spectra. In the event that the number of such spectra is equal, the overlapping region can be assigned to either volume.

[0017] Let there be p rows matching the anatomical cues (or number of regions in the slice). Let the signals of each

transducer on these p rows at all depths showing pulsatile flow (signal from blood flow) be T_{ij} . Let the pulsatile signal of the ith row of transducers be R_i :

$$R_i = \sum_{j=1}^c T_{ij} \quad (i)$$

where c is the number of columns. The matrix of row signals RM is obtained as:

$$RM = [R_1 \ R_2 \ R_3 \ \dots \ R_k \ \dots \ R_p] \quad (ii)$$

Let the signal on the first row of the previous volume be FS:

$$FS = \sum_{j=1}^c T_{1j} \quad (iii)$$

where c is the number of columns. The start of the overlap region is obtained by cross-correlating the row signal matrix with FS as follows:

$$CV = \text{CrossCorr} (RM, FS)$$

$$CV = \sum_{n=-inf}^{inf} RM(i+n)'FS(k) \quad (iv)$$

Where $RM(i+k)$ is $\begin{bmatrix} R_1(i+k) \\ R_2(i+k) \\ R_3(i+k) \\ \vdots \\ R_p(i+k) \end{bmatrix}$ CV is the vector of cross correlations

$$k = \text{Max}(|(CV)|) \quad (v)$$

and R_k is the row corresponding to index k. Since the direction of motion is assumed to be uniform and correlation is performed to find the start of the overlapping region we know that R_k to R_p is the overlapping region. Volume data from R_k to R_p is assigned to the corresponding volume. This yields the volumes to be stitched as S_1 , S_2 and S_3 . The volumes to be stitched are stacked in the direction of motion and connected by interpolation and/or smoothing.

[0018] Blood flow in the carotid artery can be laminar or turbulent. Laminar flow is uniform, with all blood cells moving at relatively the same speed and in the same direction. Turbulent flow is characterized by random chaotic swirling, in which blood cells within the vessel are moving in many directions but typically have a net forward flow. Doppler spectra of laminar flow appear as broadening of the spectral line and filling of the spectral window. A turbulent flow pattern appears as spectral broadening with components below the baseline. Spectral broadening is a term applied to waveform alterations that are representative of turbulent flow. It is defined as the increased distribution of the frequencies present in a Doppler spectrum as illustrated by the Doppler flow spectrograms of FIGURE 8. In the carotid artery, this type of turbulence is present at the bifurcation point (i.e., the carotid bulb, equivalent from the point of view of flow characteristics) and at a narrowing or stenosis of the vessel.

[0019] The main way of distinguishing these two cases of turbulence is through the measurement of the peak systolic velocity (PSV). The presence of stenosis is usually characterized by an elevated PSV accompanying turbulence. The criteria for dangerous levels of plaque are generally related to percentage of stenosis; also, the degree of stenosis is determined by the peak velocity of the blood as follows:

Degree of stenosis	PSV (cm/s)	Turbulence (Spectral Broadening)
Normal	<125	Normal & High at carotid bulb
<50%	<125	High
50% - 69%	125-230	High
>70%	>230	High
Total occlusion	No flow	Nil

Detecting the Doppler shift caused by increased velocity can determine whether there is dangerous plaque present.

[0020] Distinguishing the characteristics of the bifurcation of the carotid artery from the characteristics of a stenosis can be done as follows:

Condition/Feature	PSV	Turbulence (Spectral Broadening)
Bifurcations (Carotid bulb)	Normal	High
Stenosis	High	High

This relationship shows that by estimating the turbulence in terms of spectral broadening and the PSV one can easily identify the segments of interest (like bifurcation and a stenosis jet) with the help of suitable thresholds for PSV and spectral broadening. The present invention uses this information to detect the segments of interest without any imaging of the carotid artery. Further, the present invention provides an automated method to characterize the turbulence present in the carotid cluster with differentiated degrees of stenosis. Experimental results have shown this estimation of stenosis in a segment of interest, together with a combination of turbulence with peak systolic velocity, provide a robust technique for evaluating stenosis.

[0021] Spectral Doppler ultrasound velocimetry involves the systematic analysis of the spectrum of frequencies that constitute the Doppler signal. The Doppler signal obtained for clinical use is composed of a range of frequencies with varying amplitude content. Therefore, systematic processing is required before the Doppler shift frequencies are computed. The systematic process of FIGURE 9 estimates the two most important parameters to be estimated for stenosis evaluation, the PSV and turbulence.

[0022] In block 72 Doppler signals are acquired from the volumetric region of the carotid artery as described above and the Doppler signals is pre-processed (74) to remove unwanted noisy signal components. The vessel localization step 76 identifies whether the acquired Doppler signals contain vessel information (CCA, ICA, ECA or bifurcation point) or not. This is done with the help of a predefined power threshold for the Doppler power. The power in the time domain (the sum of the square of all the values divided by signal length) is computed for all of the sample volumes of the carotid artery. Then the average power is computed from all the sample volumes. Finally the sample volume that exhibits the highest power above the average value is considered as a segment having vessel information.

[0023] The spectral profile extraction at step 82 involves two steps: (i) computing a spectrogram using the spectral Doppler processor 32 and (ii) processing the spectrogram (smoothing, thresholding, noise removal, etc.) to obtain a good spectral profile. The spectrogram is obtained using a Fast Fourier Transform (FFT) based power spectrum with a 20 millisecond Hamming window using 256 data points and 50% overlap. After this a smooth and reproducible maximum frequency envelope is extracted from the generated spectrogram. To obtain a high quality maximum frequency envelop a first order Infinite Impulse Response (IIR) filter is initially applied to the obtained spectrogram. Next, a 2D median filter is applied to the pulse waveform obtained from the IIR filter. The output of the median filter is used to extract the spectral frequency envelope.

[0024] To estimate PSV in step 88, first a 3D vessel map is created in step 78 from the identified vessel information as described previously. From the vessel map the Doppler angle is estimated in step 86 by piecewise linear fit of the geometrical centroids of the carotid vessel structure obtained from the vessel map. The maximum Doppler shift frequency is also computed from the estimated spectral profile.

[0025] The peak systolic velocity is estimated in step 88 from the Doppler angle and the maximum Doppler shift using the standard Doppler equation

$$v = (F_s \times c) / (2 \times F_t \times \cos \theta),$$

where F_s is the Doppler frequency shift, c is the speed of sound in body (assumed to be nominally 1540 m/s), F_t is the

frequency of the incident beam and θ is the angle of beam incidence to the flow direction.

[0026] The turbulence is characterized by the spectral broadening which is normally seen in the presence of high flow velocity at the branching of a vessel or in small-diameter vessels. Spectral broadening can be estimated by estimating the bandwidth of the spectrum, also referred to as the spectral width. Turbulence is characterized by estimating the spectral width and therefore extracting both an upper and a lower trace of the envelope of the spectrogram. In an implementation of the present invention, the turbulence was estimated by using the area between the upper and lower spectral traces as a proportion of the area under the upper spectral trace as described by FIGURE 10. This drawing 5 illustrates the computation steps involved and an illustration of a traced Doppler spectrogram is shown in FIGURE 11. This criterion has the added advantage of placing the three arteries, the common, internal and external carotid, on an equal footing with respect to their peaks. It negates the effect of peak height on the estimate of spectral width. If only the width between the upper and lower envelope traces is used, this can lead to erroneous estimates owing to the external and common carotid having higher peaks than the internal carotid. Accordingly, turbulence is estimated by:

$$\text{Turbulence Criterion} = \frac{\text{Area Under Upper Trace} - \text{Area Under Lower trace}}{\text{Area Under Upper trace}}$$

[0027] The concluding determinations of the method of FIGURE 9 are to report the finding of the carotid bifurcation point (92), indication of stenosis (90), or a normal carotid (96) to the user. These determinations are made by comparing the turbulence estimate of spectral width SW from step 84 and the PSV estimate from step 88 to a turbulence threshold T_s and a velocity threshold T_p in comparison steps 98a, 98b, and 98c. A nominal velocity threshold T_p is 125 cm/sec, and a nominal turbulence criteria is 0.5. The results of these comparisons are then presented to the user on the display screen.

[0028] In summary, an implementation of the present invention provides a method for detecting and characterizing the segments of interest in a carotid artery without any imaging of the vessel. The inventive technique makes use of the non-imaging two dimensional array Doppler probe described above and the method of vessel localization previously described, together with Doppler angle estimation for detecting a stenosis and estimating its severity. Major elements of the invention include computing the turbulence at various points in the carotid structure and characterizing turbulence with differentiated degrees of stenosis; combining the estimates of turbulence and PSV to identify the segments of interest in a carotid artery; and combining the turbulence and PSV estimates to automatically characterize the stenosis of vessel segments in terms of the degree of stenosis.

Claims

1. A method for aligning spatially different subvolumes of ultrasonic data of a blood vessel comprising:

acquiring temporally discrete signals of a blood vessel in a first subvolume with independently operated elements of a two dimensional array (12) of ultrasonic transducer elements from spatially different depths of scanning opposed by each transducer element, said array being located in a first position with respect to the blood vessel during the acquiring;

Doppler processing the temporally discrete signals received from each transducer element to produce spectral Doppler data of the scanning depth in the first subvolume opposed by each transducer element;

producing a first three dimensional map of the spectral Doppler data in spatial relationship to the position of the array with respect to the blood vessel in the first subvolume;

acquiring temporally discrete signals of the blood vessel in a second subvolume with independently operated elements of the two dimensional array of ultrasonic transducer elements from spatially different depths of scanning opposed by each transducer element, said array being located in a second position with respect to the blood vessel during the acquiring, wherein the second subvolume has at least one partially overlapping region with the first subvolume;

Doppler processing the temporally discrete signals received from each transducer element to produce spectral Doppler data of the scanning depth in the second subvolume opposed by each transducer element;

producing a second three dimensional map of the spectral Doppler data in spatial relationship to the position of the array with respect to the blood vessel in the second subvolume;

aligning the first three dimensional map with the second three dimensional map on the basis of one or more identified regions of matching spectral Doppler data of the two three dimensional maps corresponding to the partially overlapping regions; and

producing a combined three dimensional map of the blood flow of the vessel from the aligned first and second

three dimensional maps.

2. The method of Claim 1, further comprising:

5 acquiring additional temporally discrete signals of the blood vessel in additional subvolumes with the two dimensional array when the array is located in additional positions with respect to the blood vessel wherein each additional subvolume has a partially overlapping region with at least one other subvolume;
 Doppler processing the additional temporally discrete signals to produce additional spectral Doppler data of scanning depth in the additional subvolumes opposed by each transducer element;
 10 producing additional three dimensional maps of the additional spectral Doppler data in spatial relationship to the additional positions of the array with respect to the blood vessel in the additional subvolumes;
 aligning each of the additional three dimensional maps with at least one other three dimensional map on the basis of the identified regions of matching spectral Doppler data of the two three dimensional maps corresponding to the partially overlapping regions; and
 15 producing a combined three dimensional map from the first, second and additional three dimensional maps.

3. The method of Claim 1, wherein the matching spectral Doppler data further comprises time domain Doppler data.

4. The method of Claim 3, wherein the time domain Doppler data further comprises peak systolic velocity data.

20 5. The method of Claim 1, wherein each three dimensional map comprises a plurality of voxels extending in the depth dimension in front of each transducer element.

25 6. The method of Claim 5, wherein a plurality of voxels extending in the depth dimension further comprises a column of voxels, each having a Doppler flow value.

7. The method of Claim 6, wherein aligning further comprises matching a column of voxels having Doppler flow values of one three dimensional map with a column of voxels having similar Doppler flow values of another three dimensional map.

30 8. The method of Claim 6, wherein the Doppler flow values further comprise flow velocity values.

9. The method of Claim 1, wherein aligning three dimensional maps further comprises correlating the data of one three dimensional map with the data of another three dimensional map on a spatial basis.

35 10. The method of Claim 1, wherein acquiring further comprising acquiring temporally discrete signals of a blood vessel with elements of a two dimensional array configured to be operated in a non-phased manner.

40 11. The method of Claim 1, wherein producing first and second three dimensional maps further comprises producing partially spatially overlapping first and second three dimensional maps.

45 12. The method of Claim 1, further comprising interpolating or smoothing aligned first and second three dimensional maps.

Patentansprüche

1. Verfahren zum Ausrichten von räumlich unterschiedlichen Subvolumina von Ultraschalldaten eines Blutgefäßes, umfassend:

50 Erfassen von zeitlich diskreten Signalen eines Blutgefäßes in einem ersten Subvolumen mit unabhängig betriebenen Elementen eines zweidimensionalen Arrays (12) von Ultraschallwandlerelementen aus räumlich unterschiedlichen Scantiefen gegenüber jedem Wandlerelement, wobei sich das genannte Array während der Erfassung in einer ersten Position in Bezug auf das Blutgefäß befindet;
 55 Durchführen einer Doppler-Verarbeitung der von jedem Wandlerelement empfangenen zeitlich diskreten Signale, um spektrale Doppler-Daten der Scantiefe in dem ersten Subvolumen gegenüber jedem Wandlerelement zu erzeugen;
 Erzeugen einer ersten dreidimensionalen Karte der spektralen Doppler-Daten in räumlicher Beziehung zu der

Position des Arrays in Bezug auf das Blutgefäß in dem ersten Subvolumen;
 Erfassen von zeitlich diskreten Signalen des Blutgefäßes in einem zweiten Subvolumen mit unabhängig be-
 triebenen Elementen des zweidimensionalen Arrays von Ultraschallwandlerelementen aus räumlich unter-
 5 verschiedenen Scantiefen gegenüber jedem Wandlerelement, wobei sich das genannte Array während der Er-
 fassung in einer zweiten Position in Bezug auf das Blutgefäß befindet, wobei das zweite Subvolumen mindestens
 eine sich teilweise mit dem ersten Volumen überlappende Region aufweist;
 Durchführen einer Doppler-Verarbeitung der von jedem Wandlerelement empfangenen zeitlich diskreten Sig-
 nale, um spektrale Doppler-Daten der Scantiefe in dem zweiten Subvolumen gegenüber jedem Wandlerelement
 10 zu erzeugen;
 Erzeugen einer zweiten dreidimensionalen Karte der spektralen Doppler-Daten in räumlicher Beziehung zu der
 Position des Arrays in Bezug auf das Blutgefäß in dem zweiten Subvolumen;
 Ausrichten der ersten dreidimensionalen Karte auf die zweite dreidimensionale Karte basierend auf einer oder
 mehreren identifizierten Regionen von übereinstimmenden spektralen Doppler-Daten der beiden dreidimensi-
 onalen Karten, welche den sich teilweise überlappenden Regionen entsprechen; und
 15 Erzeugen einer kombinierten dreidimensionalen Karte der Blutströmung in dem Gefäß anhand der ausgerich-
 teten ersten und zweiten dreidimensionalen Karten.

2. Verfahren nach Anspruch 1, weiterhin umfassend:

20 Erfassen von zusätzlichen zeitlich diskreten Signalen des Blutgefäßes in zusätzlichen Subvolumina mit dem
 zweidimensionalen Array, wenn sich das Array in zusätzlichen Positionen in Bezug auf das Blutgefäß befindet,
 wobei jedes zusätzliche Subvolumen eine sich teilweise mit mindestens einem anderen Subvolumen überlap-
 pende Region aufweist;
 Durchführen einer Doppler-Verarbeitung der zusätzlichen zeitlich diskreten Signale, um zusätzliche spektrale
 25 Doppler-Daten der Scantiefe in den zusätzlichen Subvolumina gegenüber jedem Wandlerelement zu erzeugen;
 Erzeugen zusätzlicher dreidimensionaler Karten der zusätzlichen spektralen Doppler-Daten in räumlicher Be-
 ziehung zu den zusätzlichen Positionen des Arrays in Bezug auf das Blutgefäß in den zusätzlichen Subvolumina;
 Ausrichten von jeder der zusätzlichen dreidimensionalen Karten auf mindestens eine andere dreidimensionale
 Karte basierend auf den identifizierten Regionen von übereinstimmenden spektralen Doppler-Daten der beiden
 30 dreidimensionalen Karten, welche den sich teilweise überlappenden Regionen entsprechen; und
 Erzeugen einer kombinierten dreidimensionalen Karte anhand der ersten, zweiten und zusätzlichen dreidimen-
 sionalen Karten.

3. Verfahren nach Anspruch 1, wobei die übereinstimmenden spektralen Doppler-Daten weiterhin Zeitbereichs-Dopp-
 35 ler-Daten umfassen.

4. Verfahren nach Anspruch 3, wobei die Zeitbereichs-Doppler-Daten weiterhin Daten bezüglich der maximalen systo-
 lischen Geschwindigkeit umfassen.

5. Verfahren nach Anspruch 1, wobei jede dreidimensionale Karte eine Vielzahl von Voxeln umfasst, die sich in der
 40 Tiefendimension vor jedem Wandlerelement erstrecken.

6. Verfahren nach Anspruch 5, wobei eine Vielzahl von Voxeln, die sich in der Tiefendimension erstrecken, weiterhin
 eine Spalte von Voxeln umfasst, die jeweils einen Doppler-Strömungswert haben.

7. Verfahren nach Anspruch 6, wobei das Ausrichten weiterhin das Abgleichen einer Spalte von Voxeln mit Doppler-
 45 Strömungswerten einer dreidimensionalen Karte auf eine Spalte von Voxeln mit ähnlichen Doppler-Strömungswerten
 einer anderen dreidimensionalen Karte umfasst.

8. Verfahren nach Anspruch 6, wobei die Doppler-Strömungswerte weiterhin Strömungsgeschwindigkeitswerte um-
 50 fassen.

9. Verfahren nach Anspruch 1, wobei das Ausrichten von dreidimensionalen Karten weiterhin das Korrelieren der
 55 Daten von einer dreidimensionalen Karte mit den Daten von einer anderen dreidimensionalen Karte auf einer räum-
 lichen Basis umfasst.

10. Verfahren nach Anspruch 1, wobei das Erfassen weiterhin das Erfassen von zeitlich diskreten Signalen eines
 Blutgefäßes mit Elementen eines zweidimensionalen Arrays umfasst, die dafür konfiguriert sind, auf eine nicht-

phasengesteuerte Weise betrieben zu werden.

11. Verfahren nach Anspruch 1, wobei das Erzeugen erster und zweite dreidimensionaler Karten weiterhin das Erzeugen von sich teilweise räumlich überlappenden ersten und zweiten dreidimensionalen Karten umfasst.

12. Verfahren nach Anspruch 1, weiterhin umfassend das Interpolieren oder Glätten ausgerichteteter erster und zweiter dreidimensionaler Karten.

Revendications

1. Procédé pour l'alignement spatialement différent de sous-volumes de données ultrasonores d'un vaisseau sanguin comprenant :

l'acquisition sur le plan temporel de signaux discrets d'un vaisseau sanguin dans un premier sous-volume avec des éléments actionnés indépendamment d'un ensemble bidimensionnel (12) d'éléments de transducteur ultrasonores à partir de profondeurs de balayage spatialement différentes auxquelles s'opposent chaque élément de transducteur, ledit ensemble étant situé dans une première position par rapport au vaisseau sanguin pendant l'acquisition ;

le traitement Doppler des signaux discrets sur le plan temporel reçus de chaque élément de transducteur pour produire des données spectrales Doppler de la profondeur de balayage dans le premier sous-volume auquel s'oppose chaque élément de transducteur ;

la production d'une première carte tridimensionnelle des données spectrales Doppler en relation spatiale avec la position de l'ensemble par rapport au vaisseau sanguin dans le premier sous-volume ;

l'acquisition de signaux discrets sur le plan temporel du vaisseau sanguin dans un deuxième sous-volume avec des éléments actionnés indépendamment de l'ensemble bidimensionnel des éléments de transducteur ultrasonores à partir des profondeurs de balayage spatialement différentes auxquelles s'oppose chaque élément de transducteur, ledit ensemble étant situé dans une deuxième position par rapport au vaisseau sanguin pendant l'acquisition, dans lequel le deuxième sous-volume a au moins une région partiellement chevauchante avec le premier sous-volume ;

le traitement Doppler des signaux discrets sur le plan temporel reçus de chaque élément de transducteur pour produire des données spectrales Doppler de la profondeur de balayage dans le deuxième sous-volume auquel s'oppose chaque élément de transducteur ;

la production d'une deuxième carte tridimensionnelle des données spectrales Doppler en relation spatiale avec la position de l'ensemble par rapport au vaisseau sanguin dans le deuxième sous-volume ;

l'alignement de la première carte tridimensionnelle avec la deuxième carte tridimensionnelle sur la base d'une ou plusieurs régions identifiées d'appariement de données spectrales Doppler des deux cartes tridimensionnelles correspondant aux régions partiellement chevauchantes ; et

la production d'une carte tridimensionnelle combinée du flux sanguin du vaisseau à partir des première et deuxième cartes tridimensionnelles alignées.

2. Procédé selon la revendication 1, comprenant en outre :

l'acquisition de signaux discrets sur le plan temporel supplémentaires du vaisseau sanguin dans des sous-volumes supplémentaires avec l'ensemble bidimensionnel lorsque l'ensemble est situé sur des positions supplémentaires par rapport au vaisseau sanguin, dans lequel chaque sous-volume supplémentaire a une région partiellement chevauchante comportant au moins un autre sous-volume ;

le traitement Doppler des signaux discrets sur le plan temporel supplémentaires pour produire des données Doppler spectrales supplémentaires de la profondeur de balayage dans les sous-volumes supplémentaires auxquels s'oppose chaque élément de transducteur ;

la production de cartes tridimensionnelles supplémentaires des données spectrales Doppler supplémentaires en relation spatiale avec les positions supplémentaires de l'ensemble par rapport au vaisseau sanguin dans les sous-volumes supplémentaires ;

l'alignement de chacune des cartes tridimensionnelles supplémentaires avec au moins une autre carte tridimensionnelle sur la base des régions identifiées d'appariement de données spectrales Doppler des deux cartes tridimensionnelles correspondant aux régions partiellement chevauchantes ; et

la production d'une carte tridimensionnelle combinée à partir des première, deuxième et autres cartes tridimensionnelles supplémentaires.

EP 3 024 397 B1

3. Procédé selon la revendication 1, dans lequel les données spectrales Doppler appariées comprennent en outre des données Doppler de domaine temporel.
- 5 4. Procédé selon la revendication 3, dans lequel les données Doppler de domaine temporel comprennent en outre des données de vitesse systolique de pic.
5. Procédé selon la revendication 1, dans lequel chaque carte tridimensionnelle comprend une pluralité de voxels s'étendant dans la dimension de profondeur devant chaque élément de transducteur.
- 10 6. Procédé selon la revendication 5, dans lequel une pluralité de voxels s'étendant dans la dimension de profondeur comprend en outre une colonne de voxels, chacun ayant une valeur de flux Doppler.
- 15 7. Procédé selon la revendication 6, dans lequel l'alignement comprend en outre l'appariement d'une colonne de voxels ayant des valeurs de flux Doppler d'une carte tridimensionnelle avec une colonne de voxels ayant des valeurs de flux Doppler similaires d'une autre carte tridimensionnelle.
- 20 8. Procédé selon la revendication 6, dans lequel les valeurs de flux Doppler comprennent en outre des valeurs de vitesse de flux.
- 25 9. Procédé selon la revendication 1, dans lequel l'alignement de cartes tridimensionnelles comprend en outre la corrélation des données d'une carte tridimensionnelle avec les données d'une autre carte tridimensionnelle sur une base spatiale.
- 30 10. Procédé selon la revendication 1, dans lequel l'acquisition comprend en outre l'acquisition sur le plan temporel de signaux discrets d'un vaisseau sanguin avec des éléments d'un ensemble bidimensionnel configuré pour être utilisé de manière non phasée.
- 35 11. Procédé selon la revendication 1, dans lequel la production des première et deuxième cartes tridimensionnelles comprend en outre la production partiellement chevauchante spatialement des première et deuxième carte tridimensionnelles chevauchantes.
- 40 12. Procédé selon la revendication 1, comprenant en outre l'interpolation ou le lissage des première et deuxième cartes tridimensionnelles alignées.
- 45
- 50
- 55

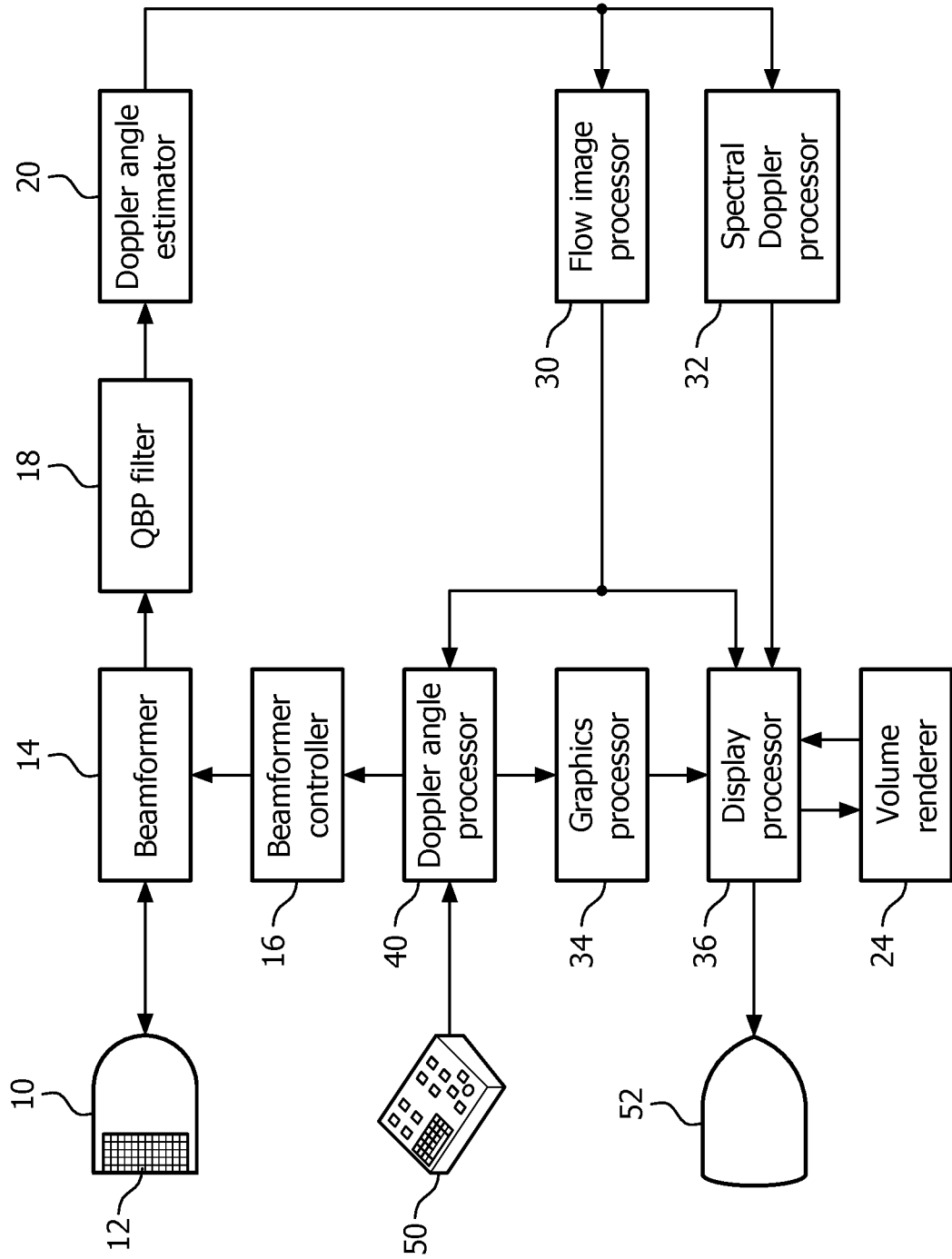

FIG. 1

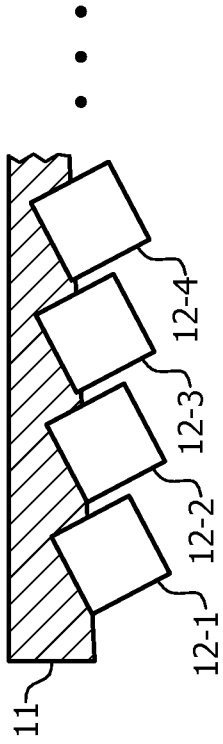

FIG. 2a

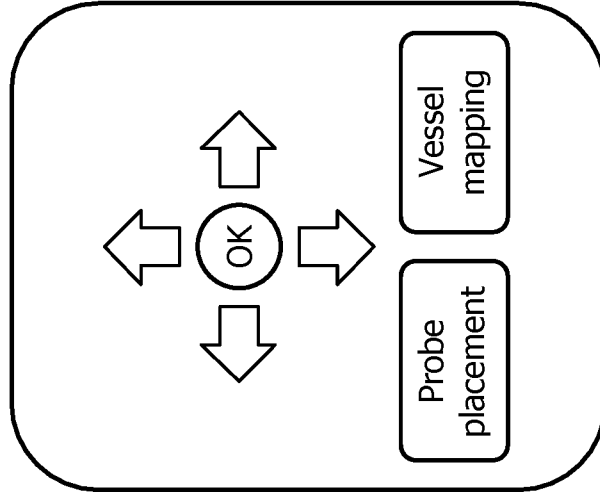

FIG. 3

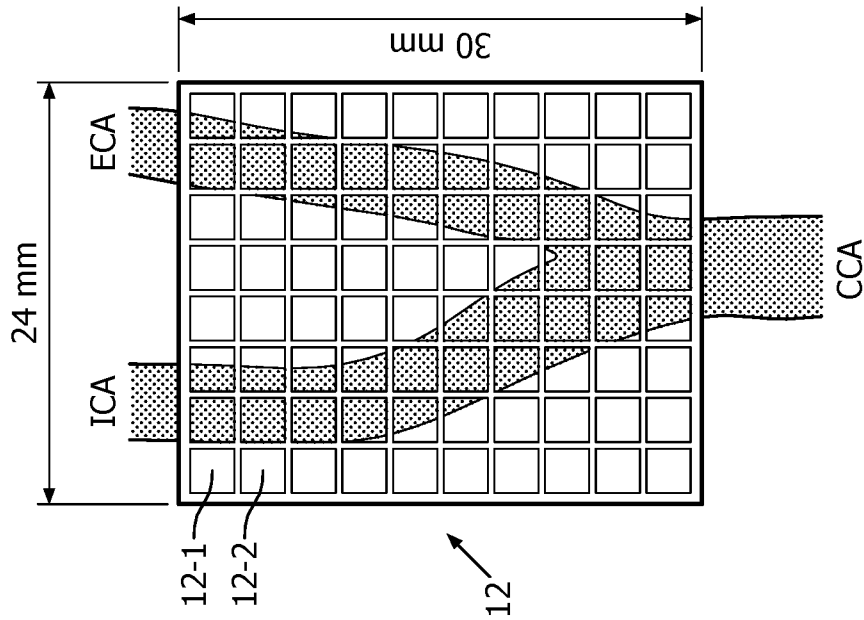

FIG. 2

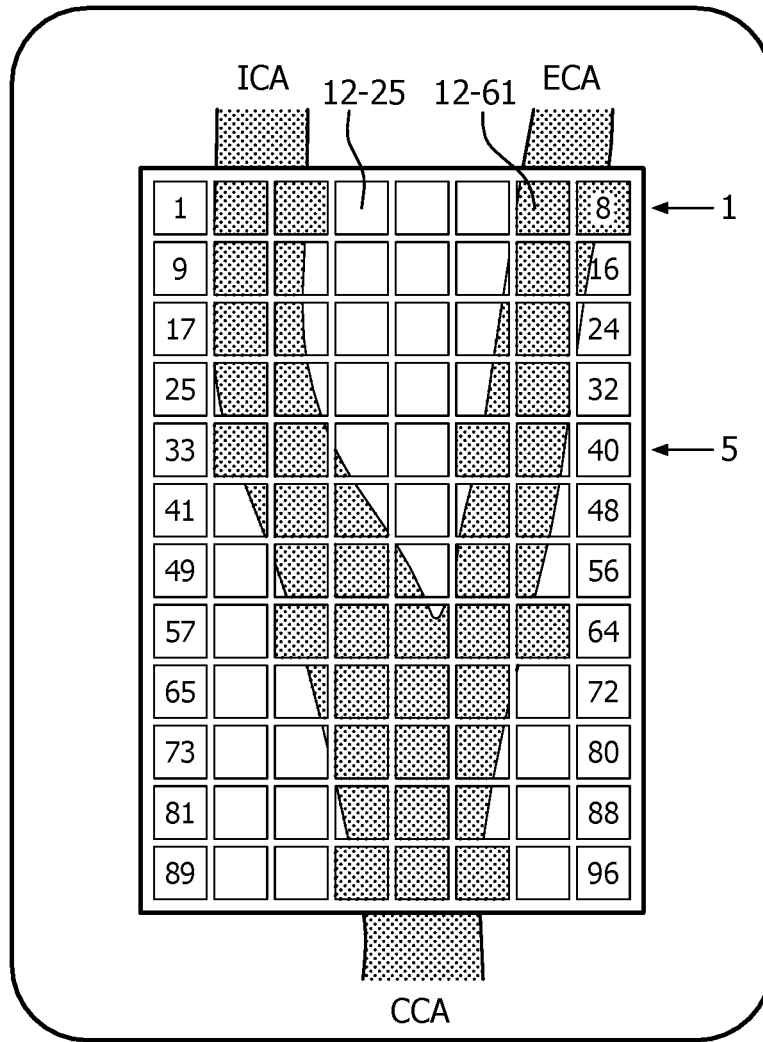

FIG. 4

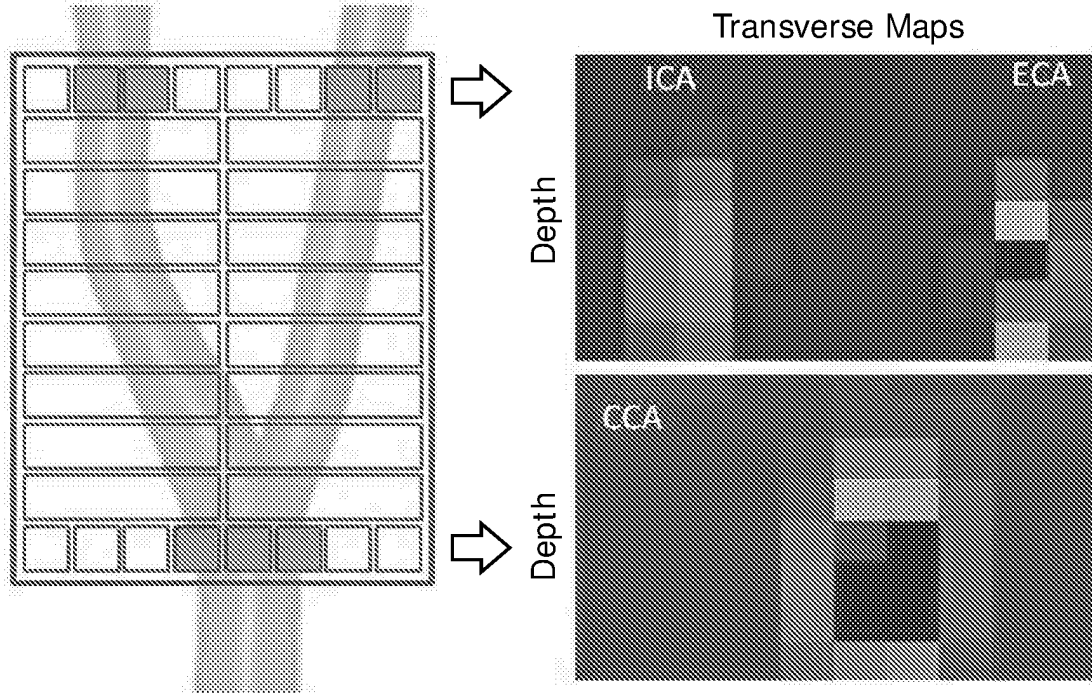

FIG. 5

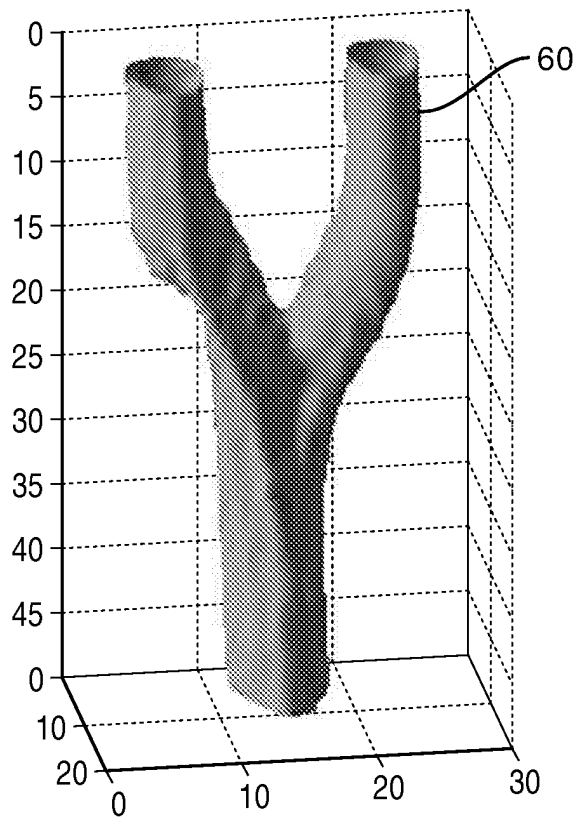

FIG. 6

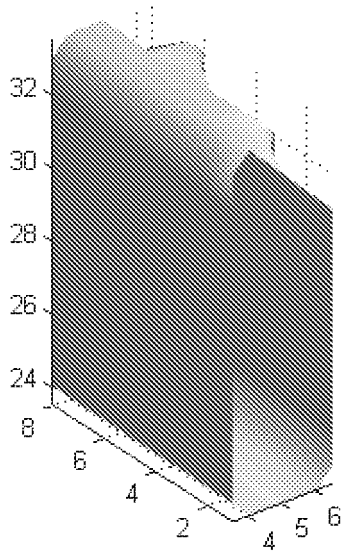

FIG. 7a

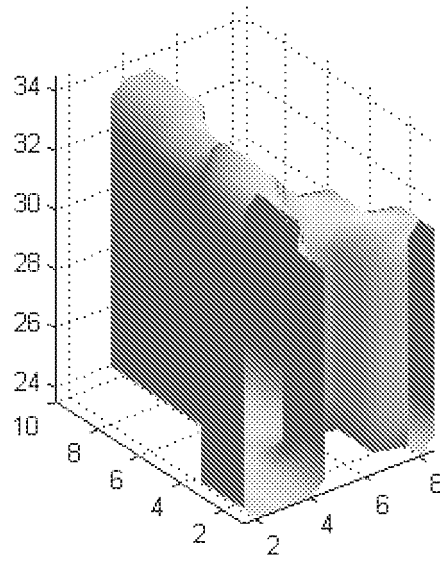

FIG. 7b

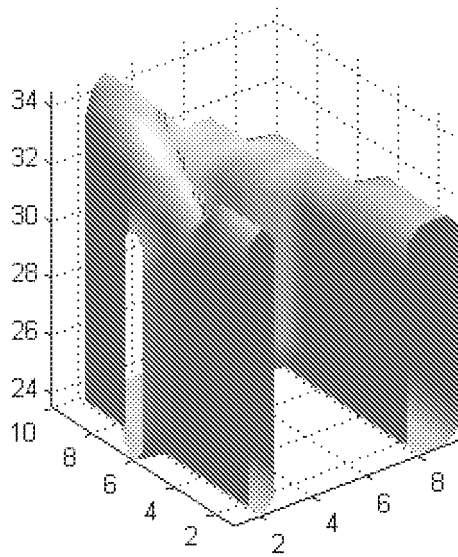

FIG. 7c

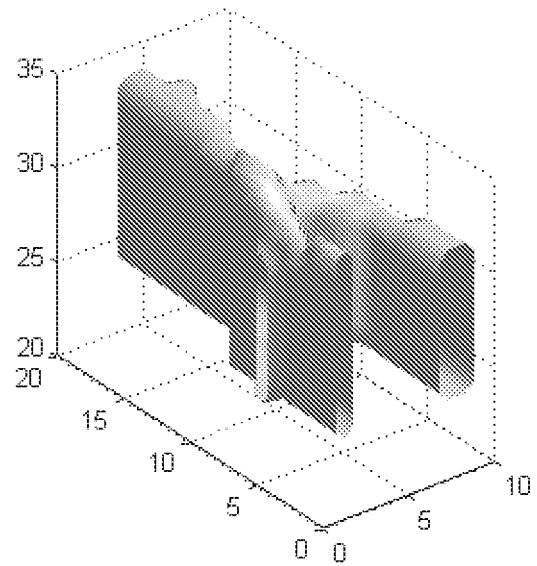

FIG. 7d

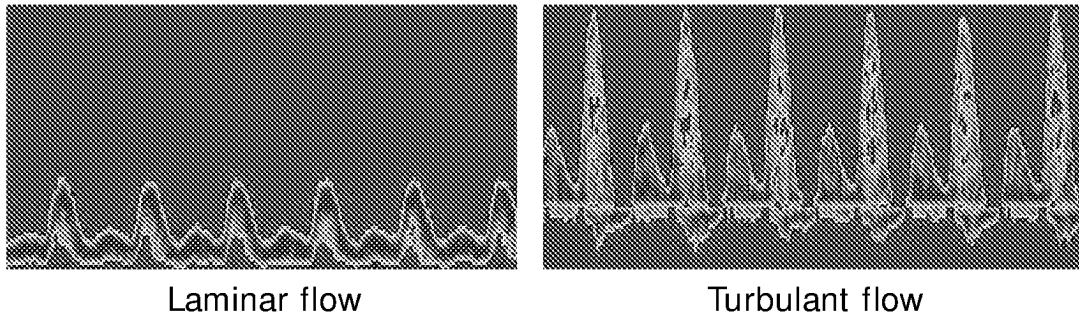

FIG. 8

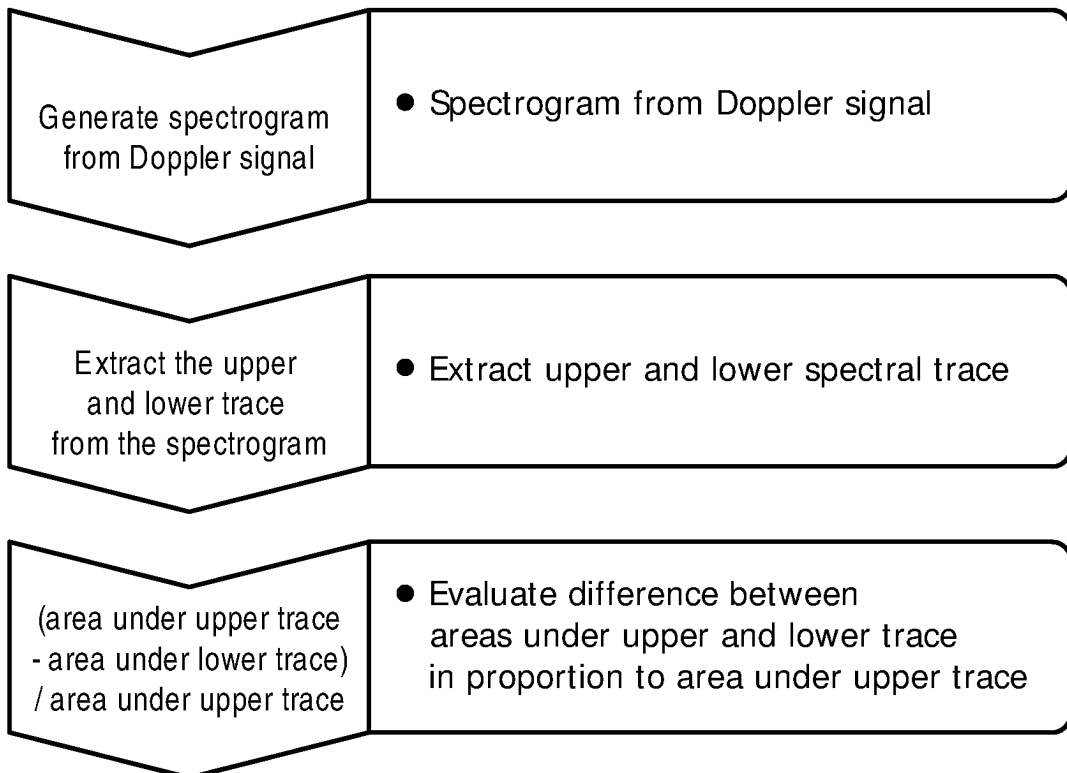

FIG. 10

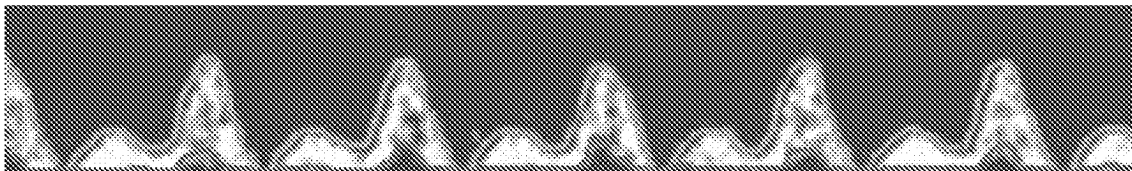

FIG. 11

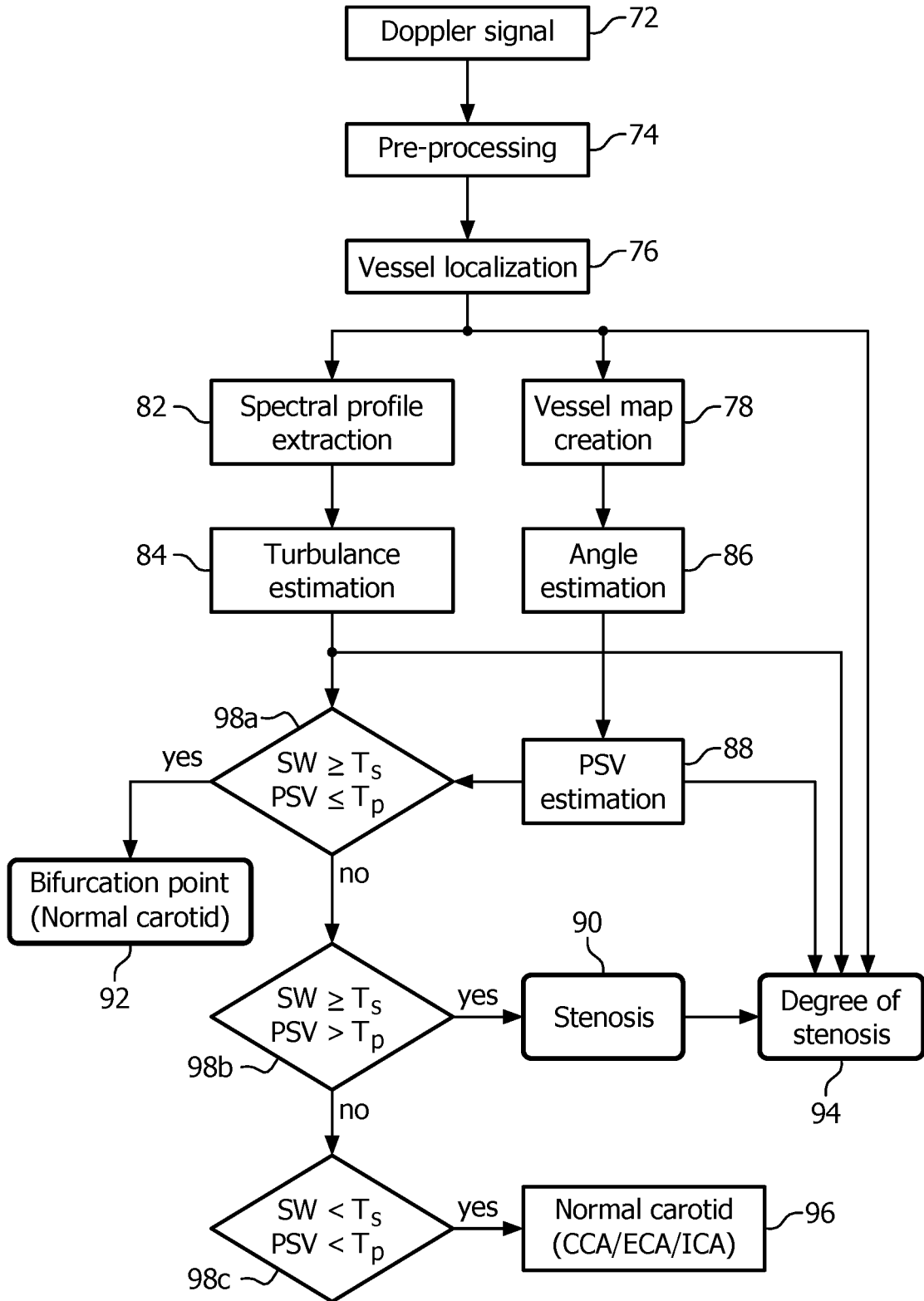

FIG. 9

REFERENCES CITED IN THE DESCRIPTION

This list of references cited by the applicant is for the reader's convenience only. It does not form part of the European patent document. Even though great care has been taken in compiling the references, errors or omissions cannot be excluded and the EPO disclaims all liability in this regard.

Patent documents cited in the description

- WO 2013088320 A1 [0003]

专利名称(译)	用于对准血管的超声数据的空间不同子体积的方法		
公开(公告)号	EP3024397A1	公开(公告)日	2016-06-01
申请号	EP2014771366	申请日	2014-07-14
[标]申请(专利权)人(译)	皇家飞利浦电子股份有限公司		
申请(专利权)人(译)	皇家飞利浦N.V.		
当前申请(专利权)人(译)	皇家飞利浦N.V.		
[标]发明人	GOVINAHALLISATHYANARAYANA SUSHANTH SISODIA RAJENDRA SINGH BUSSA NAGARAJU PALANISAMY KRISHNAMOORTHY BASAWARAJ PATIL OKALY VIKRAM SETHURAMAN SHRIRAM PETRUZZELLO JOHN ZHOU SHIWEI ANAND AJAY ERKAMP RAMON QUIDO VENKATESAN SHANKAR MOSUR		
发明人	GOVINAHALLISATHYANARAYANA, SUSHANTH SISODIA, RAJENDRA, SINGH BUSSA, NAGARAJU PALANISAMY, KRISHNAMOORTHY BASAWARAJ PATIL OKALY, VIKRAM SETHURAMAN, SHRIRAM PETRUZZELLO, JOHN ZHOU, SHIWEI ANAND, AJAY ERKAMP, RAMON, QUIDO VENKATESAN, SHANKAR, MOSUR		
IPC分类号	A61B8/06 A61B8/08 A61B8/00 G01S15/89		
CPC分类号	A61B8/06 A61B8/0891 A61B8/466 A61B8/483 A61B8/488 G01S7/52065 G01S15/8925 G01S15/8979 G01S15/8993		
代理机构(译)	STEFFEN , THOMAS		
优先权	61/857833 2013-07-24 US		
其他公开文献	EP3024397B1		
外部链接	Espacenet		

摘要(译)

一种用于对准血管的超声数据的空间不同子体积的方法，包括：利用由每个换能器元件相对的空间不同扫描深度的超声换能器元件的二维阵列的元件获取血管的时间离散信号，所述阵列在获取期间位于相对于血管的第一位置；多普勒处理从每个换能器元件接收的时间上离散的信号，以产生每个换能器元件相对的扫描深度的频谱多普勒数据；产生频谱多普勒数据的第一个三维图，其与阵列相对于血管的位置成空间关系；利用每个换能器元件相对的空间不同扫描深度的超声换能器元件的二维阵列的元件获取血管的时间离散信号，所述阵列位于第二获得期间相对于血管的位置；多普勒处理从每个换能器元件接收的时间上离散的信号，以产生每个换能器元件相对的扫描深度的频谱多普勒数据；产生频谱多普勒数据的第二个三维图，其与阵列相对于血管的位置成空间关系；基于两个地图

的匹配频谱多普勒数据的一个或多个区域，将第一三维地图与第二三维地图对齐;从对齐的第一和第二三维图产生血管血流的组合三维图。