



2 1

3a 3b

4a (PPG)

4b

5a 2 3 (ECG)

5b 5d R-peak

6 Burg

7a (EDA)

7b (EDA)  
(SCR)

8

9a (ICA)

9b ICA

10a (EGG)

10b (time-varying spectrum)

11

12

2000 가 가 200

가

가

2000-041437

2001-28961

(RF tag)

2001-3479 'Animal's intention translational method'

,가

가

가

가  
가

, US 5046453, 'Animal training apparatus'

가  
(cold fluid)가

US 5054428, 'Method and apparatus for remote conditioned cue control of animal training stimulus'

가  
가  
(duration)

가

, WO99/42968 'Pet locator system'

(Pet)

(movable

object)

WO96/30882 'Wireless pet containment system'

가

가

가

, (a)

; (b)

; (c)

(a)

; (b)

; (c)

(SVM)

1

ography, ECG), (photoplethysmography, PPG), (skin temperature, SKT), (electrocardi  
lectromyogram, EMG) (electrogastrogram, EGG) (electrodermal activity, EDA), (e  
(110 ), (100 ),

(120 ).

(130 ).

가  
120 가  
가

100

2 1

(200)

(200),

(210)

(220),

(230),

(240)

(230)

(240)

(250)

(250)

(260)

(260)

(200)

(250)

1

2

가

(Human-computer interaction, HCI)

가

가  
(Heart rate variability),

(  
(electrodermal activity),

)  
(skin temperature)

(intenti

on)

3a

3b  
, 3b

3a

가

(200)

3b

3a

가

가

PPG),

(EDA),

(EMG)

(200)

(EGG)

(SKT),

(ECG),  
(100 ).

(

RF

, A/D  
(210)

(220)  
(signal recovery)

(210)

RF

(200)

(230)

(230)

(add-on)

(230)

(pacemaker)

sinoatrial node(SA node)

가

가

(electrocardiography, ECG),

(phonocardiography),

(photoplethysmography, PPG)

가

가

3a (200)

Medical instrumentation (J. G. Webster, 1999)

3b 2 3

(PPG) 가 4a

4b

PPG (lowpass filter, 400) (median filter)(410) (matched filter)(420) (peak) (baseline movement)

5a 2 3 (ECG) , 5b 5d  
R-peak

5b

5a (bandpass filter)(500) QRS complex (510) 5c  
(510)

(Teager's energy operator, TEO)(520) : Kyung Hwan Kim et al., 'Neural spike sorting under nearly 0 dB signal-to-noise ratio using nonlinear energy operator and artificial neural network classifier, IEEE Transactions on biomedical engineering, 2000) 가

가 R-peak R-R (time series)

5d (520)

g) (smoothing), 가 (downsampling)

'An efficient algorithm for spectral analysis of heart rate variability,' IEEE Trans. Biomed. Eng., vol. 33, 1986 ( R. D. Berger et. al)

6 Burg

Burg (autoregressive modeling)  
0.0043-0.04 Hz ( , very low frequency, VLF), 0.04-0.15 Hz ( , low frequency, LF) 0.15-0.4 Hz ( , high frequency, HF) 3 . Burg  
Statistical digital signal processing and modeling ( : M. Hayes), Wiley, 1996

R-peak , 10 %

7a 3a, 3b (EDA) . 3a  
3b  
(electrodermal activity, EDA)

7a EDA (level) (skin conduc  
tance response, SCR ) ( SCR ) (duration),  
SCR

7b (EDA) (SCR)

EDA 256 Hz (700) 10  
-12 1 (710) (720)  
, 20 Bartlett window( : Statistical digital signal processing and modeling (  
: M. Hayes), Wiley, 1996) (convolution) (smoothing) SCR (730)  
(threshold) 2 SCR

(SKT) (thermistor)

가

(230)

, EDA SCR , SCR , SKT ( 10% ), SKT 9

(250)

(230)

가 가 가

(240)

(240)

(250)

Bayes' rule (Pattern classification, 2nd ed., ( : R. O. Duda, P. E. Hart, D. G. Stock), 2000  
, Wiley )

s' rule 가 Baye  
Parzen window classifier, multilayer perceptron

가  
(generalization)

(Linear projection)

Wiley) 'Fisher projection Pattern classification, 2nd ed.'( : R. O. Duda, P. E. Hart, D. G. Stock, 2000,  
2 (projection)

가

가

ne, SVM ) (support vector machi

SVM (mapping) 가 Vapnik  
(statistical learning theory) (generalization performance)

(classification error)

(mapping)

SVM V. Vapnik, 'An overview of statistical learning theory,' IEEE Transactions on neural network, vol. 10, no. 5, pp. 988-999, 1999

8 (252) SVM (230)  
(degree of happiness), (degree of sadness), (degree of stress), (degree of anger), (240)  
(254)

가  
9a (independent component analysis, ICA) (post-processing) 9b ICA  
(200)

(electrogastrogram, EGG) 3b

(200) (200) ICA (blind source separation) (instrumentation noise) ICA  
(motion artifact)  
(post-processing)  
Aapo Hyvarinen, Independent component analysis, Wiley, 2001

10a (EGG) 10b  
(time-varying spectrum) 9  
50 , 10 가 10a 10b

Burg (autoregressive model)

J. Chen IEEE Transactions on Biomedical Engineering 1993 "Spectral analysis of episodic rhythmic variations in the cutaneous electrogastrogram"  
가

(230) (peak)  
(spectral width) 2 (spectral width) 10b  
(peak)  
(250) (240)

11

가  
( ) 가





4.

- 1                    2                    ,
- (b)                    ,                    (a)                    ,
- (b1')                    ;
- (b2')                    ;
- (b3')                    (b1)                    ;                    (b2)
- (b4')                    (b3')                    가                    가                    (R-peak)                    (Teager's energy operator, TEO) ;
- (b5')                    ;
- (b6') deling)                    (Burg algorithm)                    (autoregressive mo

5.

- 4                    ,
- (b)                    ,

6.

- 1                    2                    ,
- (b)                    ,                    (a)                    ,
- (b1'')                    ;
- (b2'')                    (b1)                    ;
- (b3'')                    (b2)                    (smoothing)                    ;                    (Bartlett window)                    (convolution)
- (b4'')                    (threshold)                    가                    2

7.

- 1                    2                    ,                    (c)                    (a)

8.

- 7                    ,
- (b)                    ,                    (a)                    (independent component analysis)
- (blind source separation)
- (autoregressive modeling)                    (Burg algorithm)
- (time-varying spectrum)

(c) , (b)

(support vector machine)<sup>2</sup>

1 **9.** 2 , (c)  
(a) ,

1 **10.** 2 , (c) (a)

1 **11.** 2 ,  
(d) (c)

1 **12.** 2 ,  
(e) (a) (c)  
;

(f) 가

**13.**  
;  
;  
;  
;

**14.**  
;  
;  
;  
;  
;  
;  
;  
;

13 15. 14

13 16. 14

가

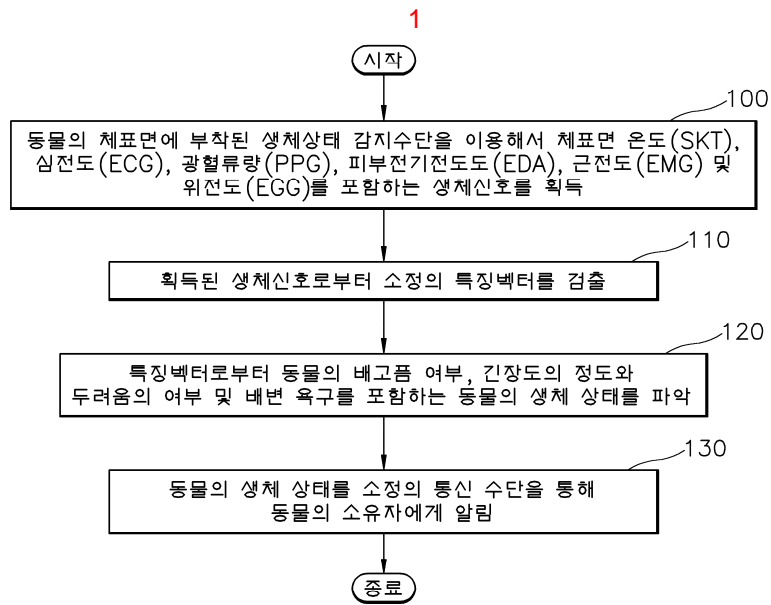

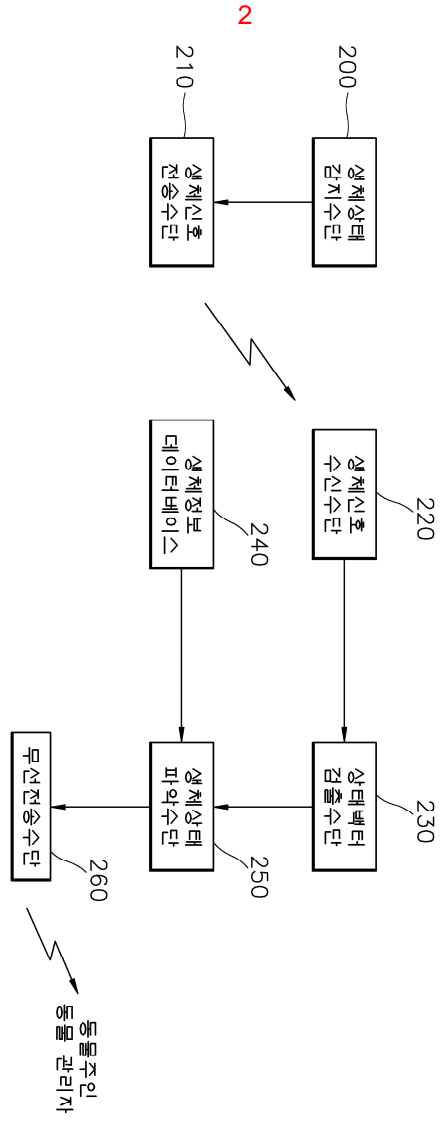

3a

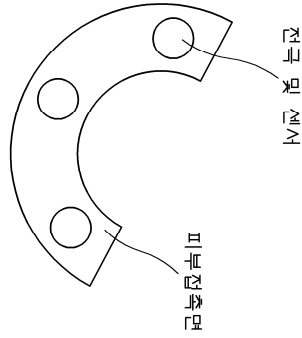
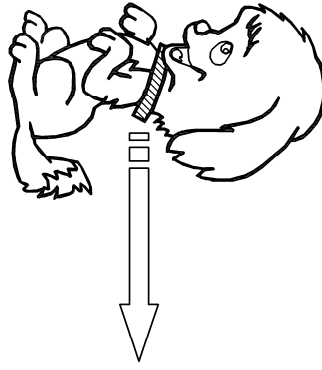

3b

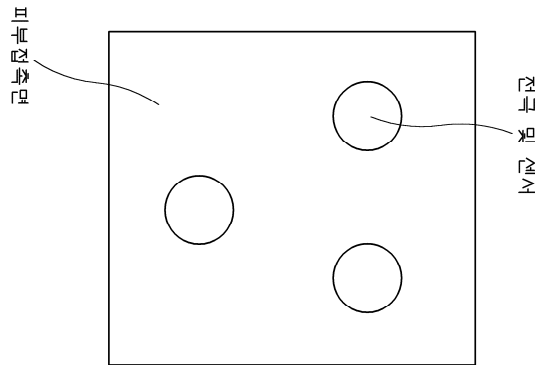
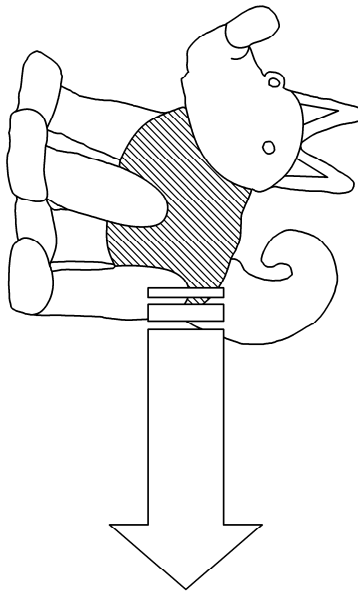

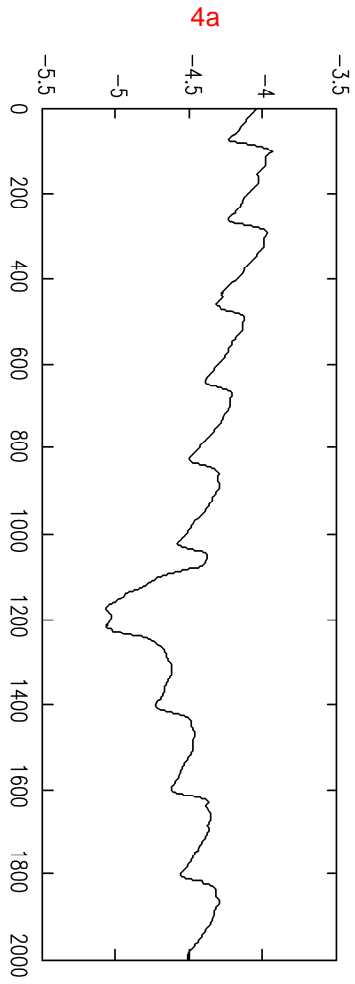

4b

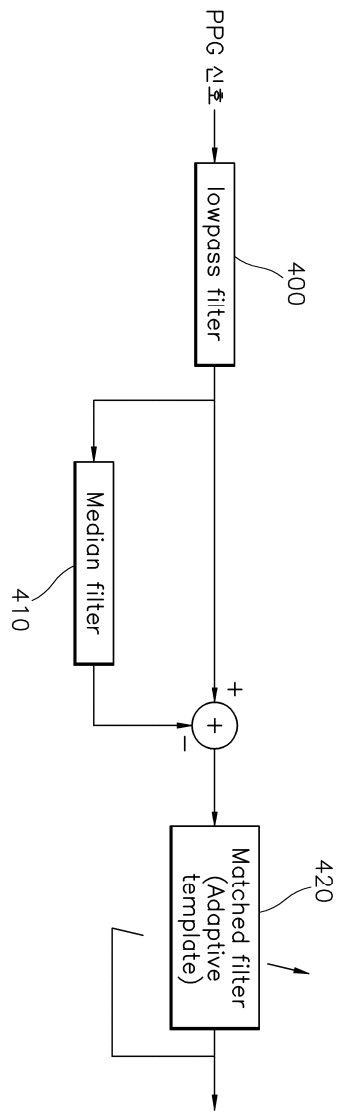

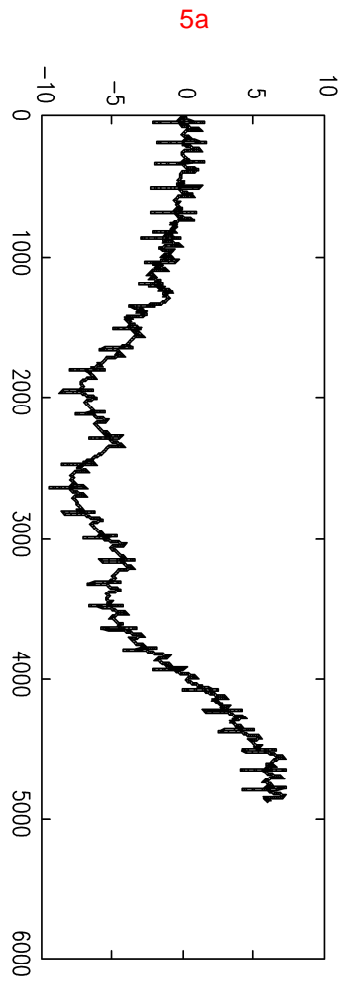

5b

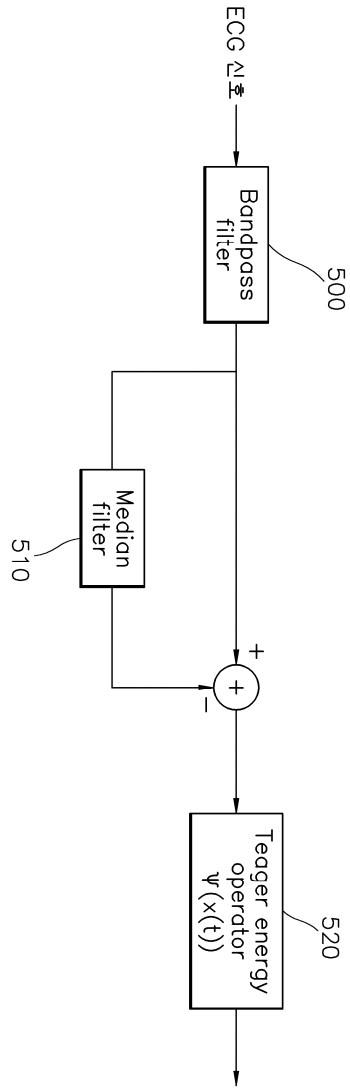

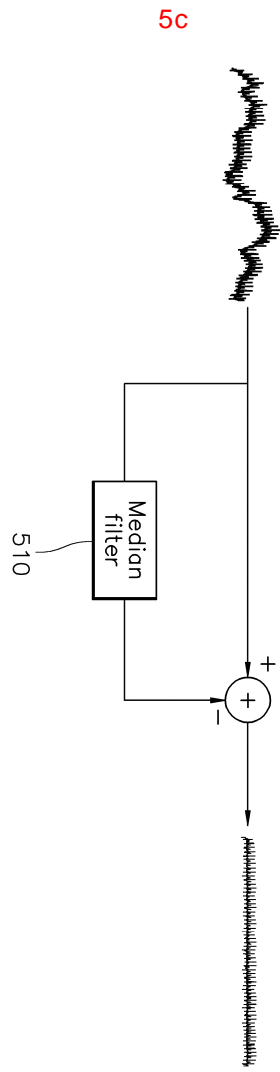

5d

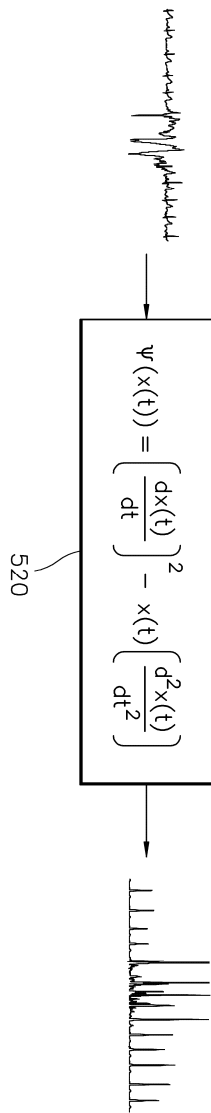

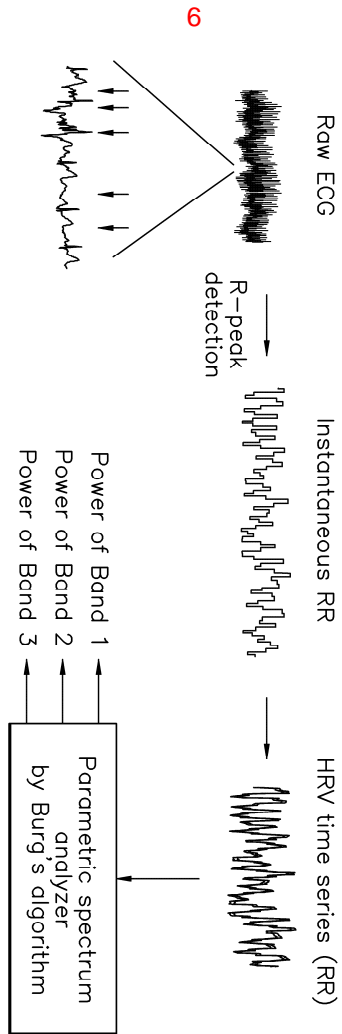

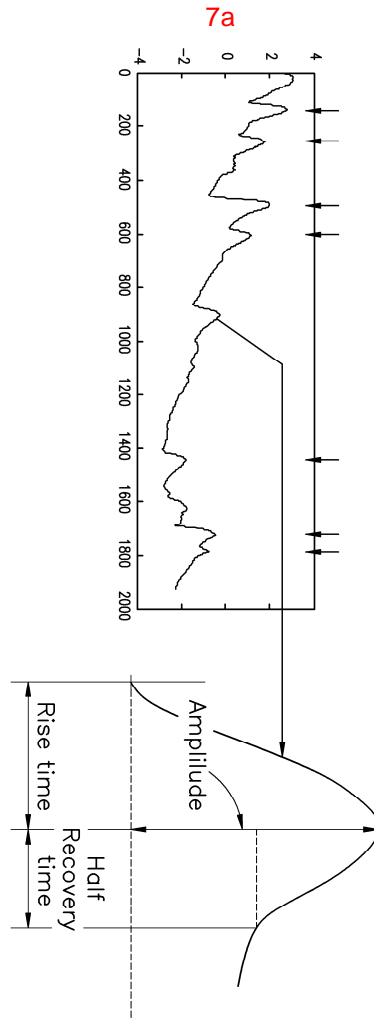

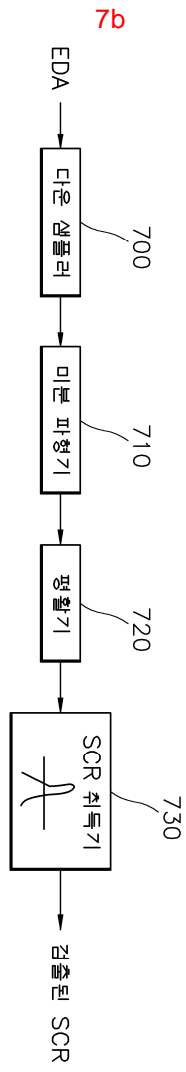

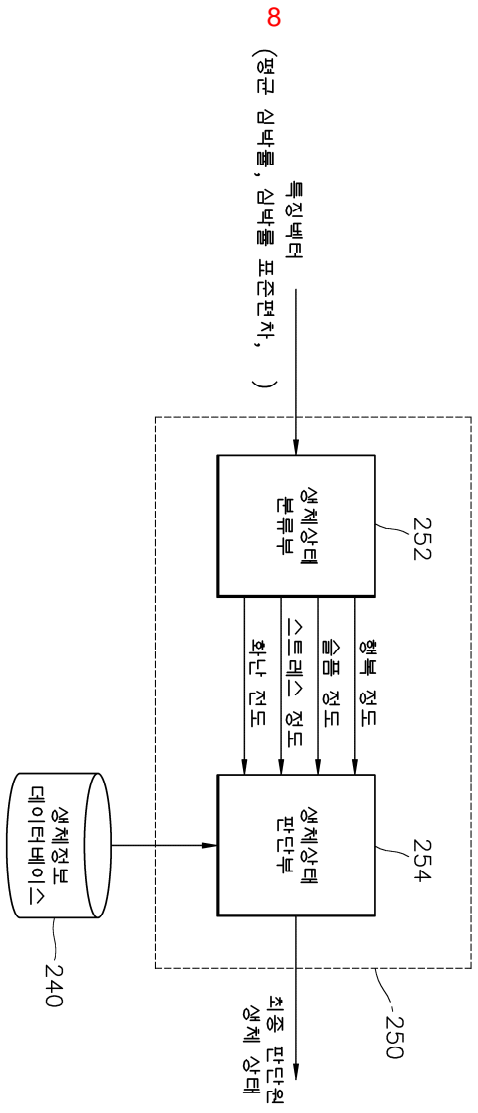

8 (평균 심박률, 심박률 표준편차, )

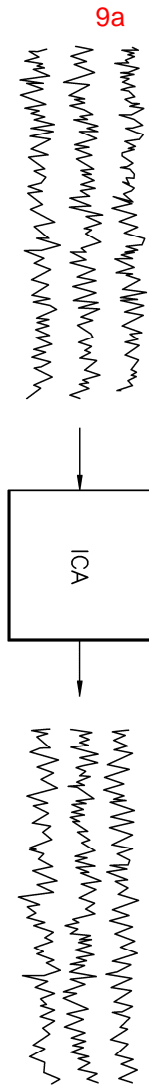

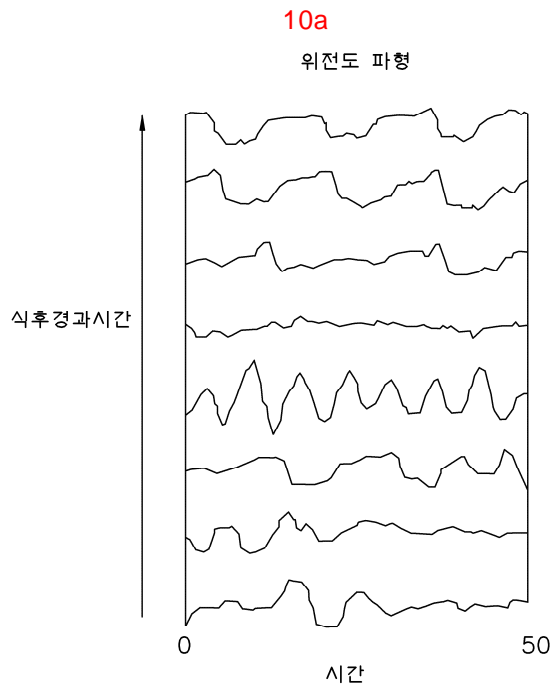
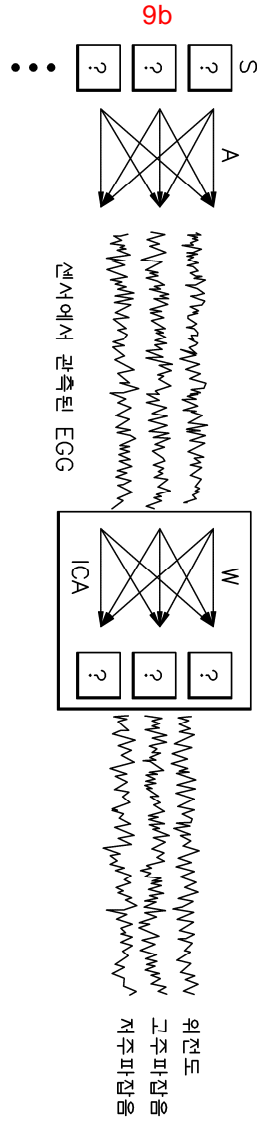

10b

스펙트럼

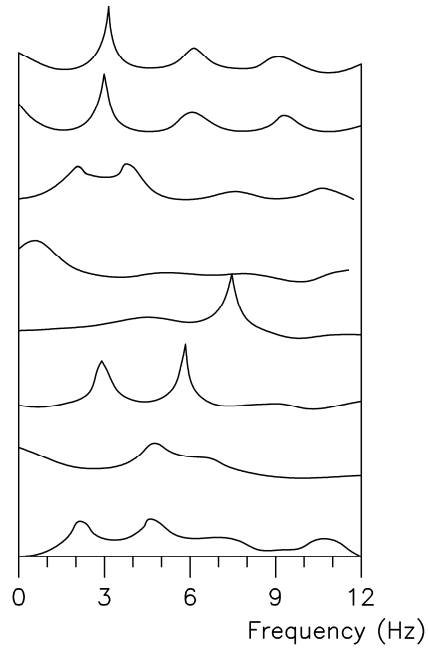

11

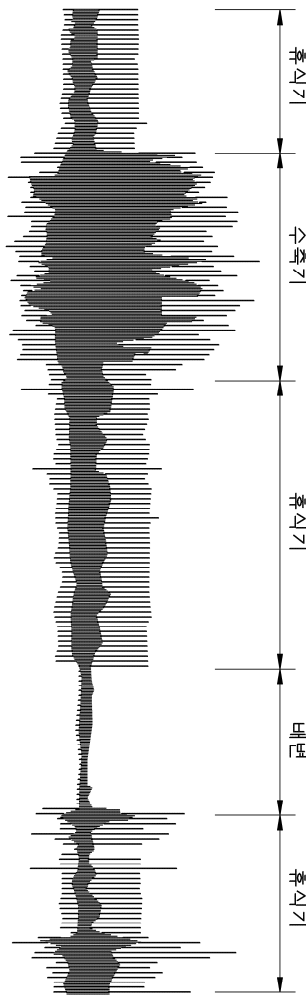

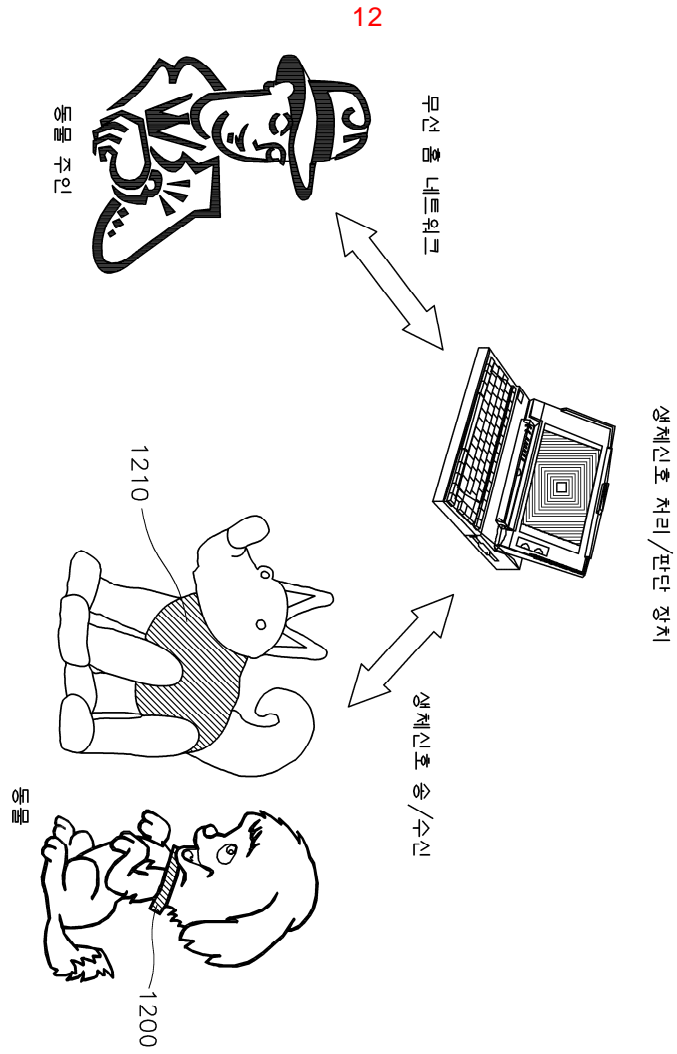

专利名称(译)	使用生理信号获取和分析来理解动物状态的方法和装置		
公开(公告)号	<a href="#">KR1020030061157A</a>	公开(公告)日	2003-07-18
申请号	KR1020020001696	申请日	2002-01-11
[标]申请(专利权)人(译)	三星电子株式会社		
申请(专利权)人(译)	三星电子有限公司		
当前申请(专利权)人(译)	三星电子有限公司		
[标]发明人	KIM KYUNGHWAN 김경환 BANG SEOKWON 방석원 LEE HYOUNGKI 이형기		
发明人	김경환 방석원 이형기		
IPC分类号	G06F19/00 A61B5/0488 A61B5/024 A61B5/0402 A61B5/01 A01K67/00 A61B5/026 A61B5/16 A61B5/0452 A61B5/04 A61D13/00 A61B5/05 A61B5/0245 A01K29/00 A61B5/0456 G06Q50/22 A61B5/00		
CPC分类号	A61B5/7264 Y10S128/92 A61B5/04 A61B5/024 A01K29/00 A61B5/16 A61B5/0456 A61B5/0488 A61B5/165		
代理人(译)	LEE, YOUNG PIL 李, 杨HAE		
其他公开文献	KR100455286B1		
外部链接	<a href="#">Espacenet</a>		

摘要(译)

本发明公开了利用生理信号的获取和解释的动物的状态掌握方法和装置。根据本发明，生物信号包括使用附着于动物体表的生物手感测装置，体表温度 (SKT)，心电图 (ECG)，光电容积描记器 (PPG)，皮肤电热活动 (EDA)，肌电图 (EMG) 和\*\*\* (EGG) 动物的有机体状态，包括恐惧和排便欲望是否被掌握。以这种方式，用语言学方法自动掌握不可能与人交流的动物的有机体状态。饲养宠物并提出有效的管理方法。

