



US 20180192883A1

(19) **United States**

(12) **Patent Application Publication**

Asao et al.

(10) **Pub. No.: US 2018/0192883 A1**

(43) **Pub. Date: Jul. 12, 2018**

(54) **BIOLOGICAL INFORMATION IMAGING APPARATUS AND BIOLOGICAL INFORMATION IMAGING METHOD**

(71) Applicant: **CANON KABUSHIKI KAISHA, Tokyo (JP)**

(72) Inventors: **Yasufumi Asao, Atsugi-shi (JP); Kazuhiko Fukutani, Yokohama-shi (JP)**

(21) Appl. No.: **15/912,849**

(22) Filed: **Mar. 6, 2018**

Related U.S. Application Data

(60) Continuation of application No. 14/481,984, filed on Sep. 10, 2014, which is a division of application No. 12/544,834, filed on Aug. 20, 2009, now Pat. No. 8,864,667.

Foreign Application Priority Data

Aug. 20, 2008 (JP) 2008-211993

Publication Classification

(51) **Int. Cl.**
A61B 5/00 (2006.01)
A61B 5/024 (2006.01)
A61B 5/021 (2006.01)
(52) **U.S. Cl.**
CPC *A61B 5/0095* (2013.01); *A61B 5/742* (2013.01); *A61B 5/7253* (2013.01); *A61B 5/7257* (2013.01); *A61B 5/024* (2013.01); *A61B 5/02133* (2013.01); *A61B 5/0073* (2013.01)

(57) **ABSTRACT**

A biological information imaging method includes a first measurement step to measure an acoustic wave (54) generated by light (53) with which a living body (51) is irradiated from a light source (50) and which is absorbed by tissue (52) in the living body, a storage step to store first information obtained in the first measurement step, a second measurement step to measure an acoustic wave (54) generated by light (53) with which the living body (51) is irradiated from the light source (50) and which is absorbed by the tissue (52) in the living body, and a processing step to generate an image of information of the tissue in the living body by using second information obtained in the second measurement step, and the first information stored in the storage step.

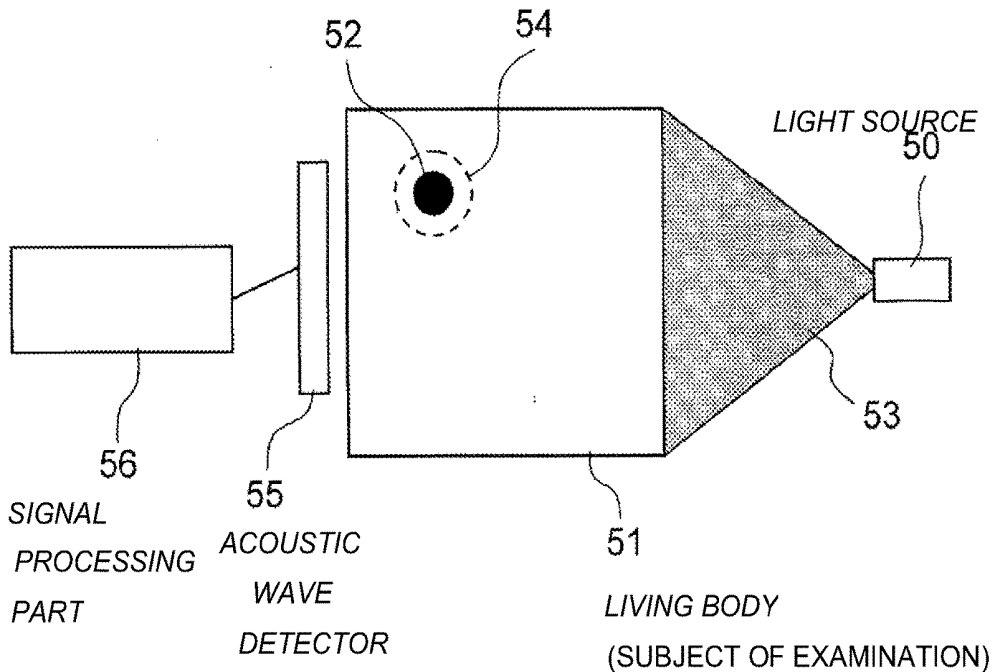

FIG. 1

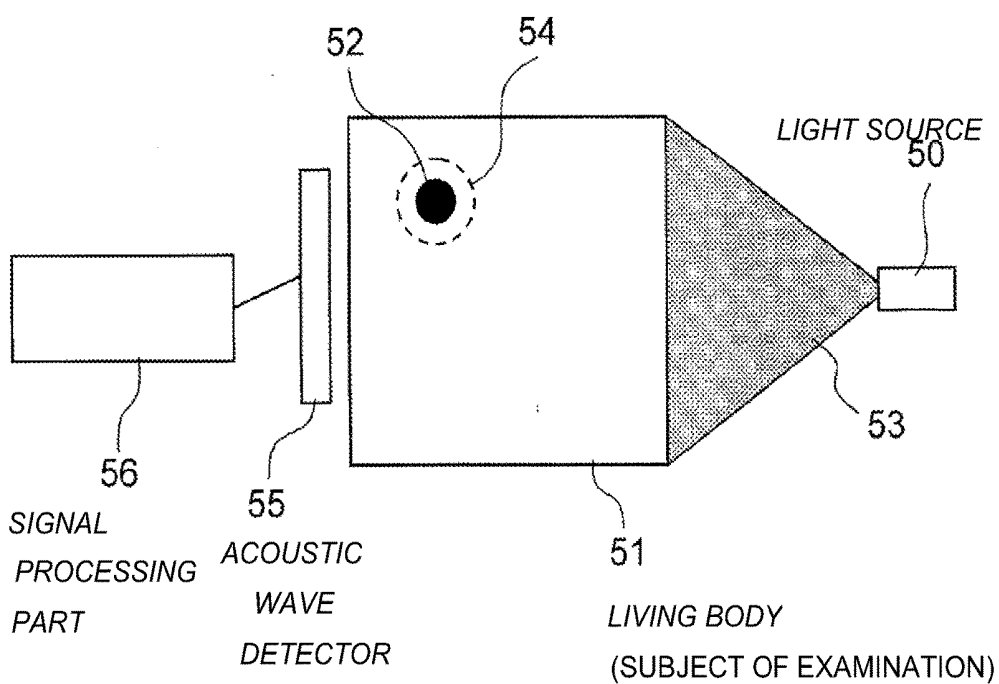

FIG.2A

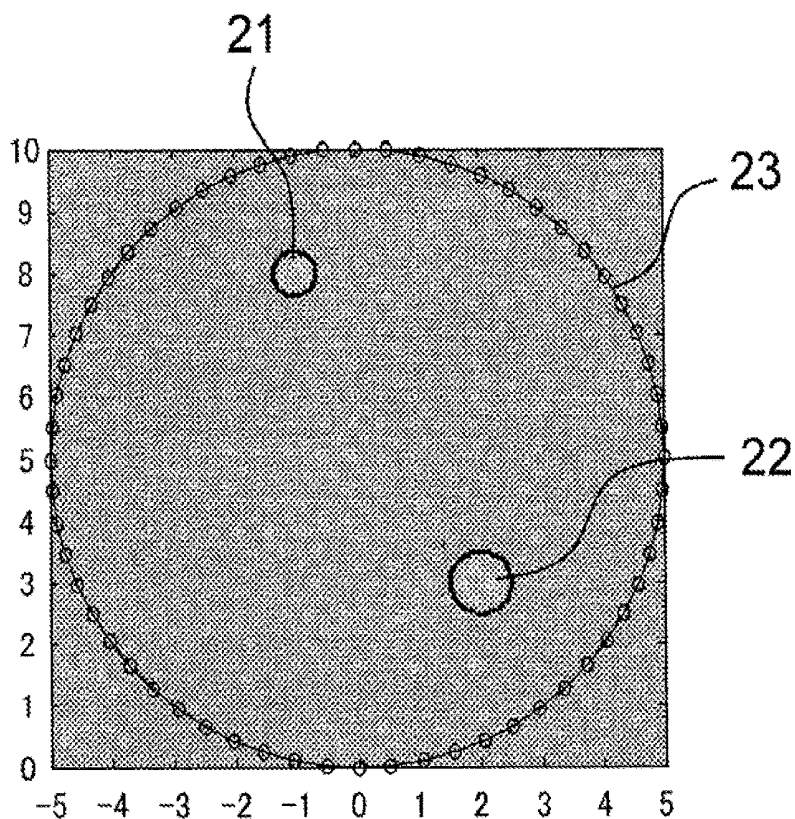

FIG.2B

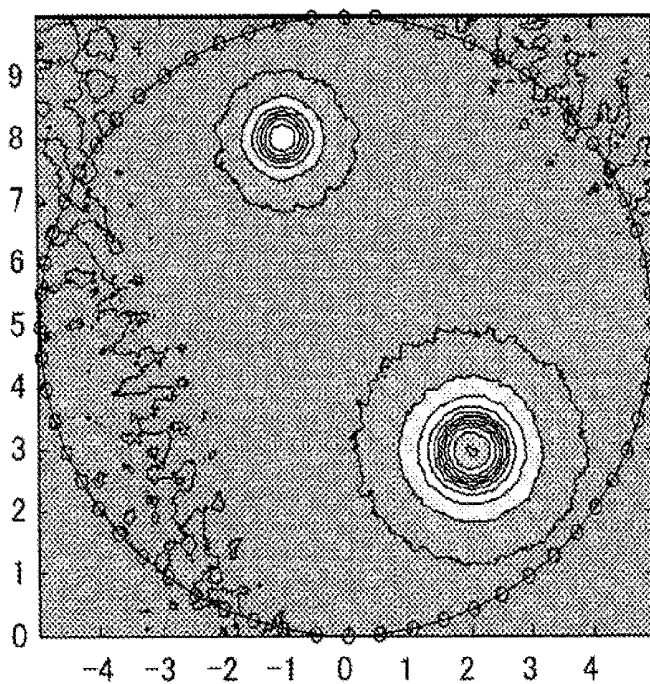

FIG.3A

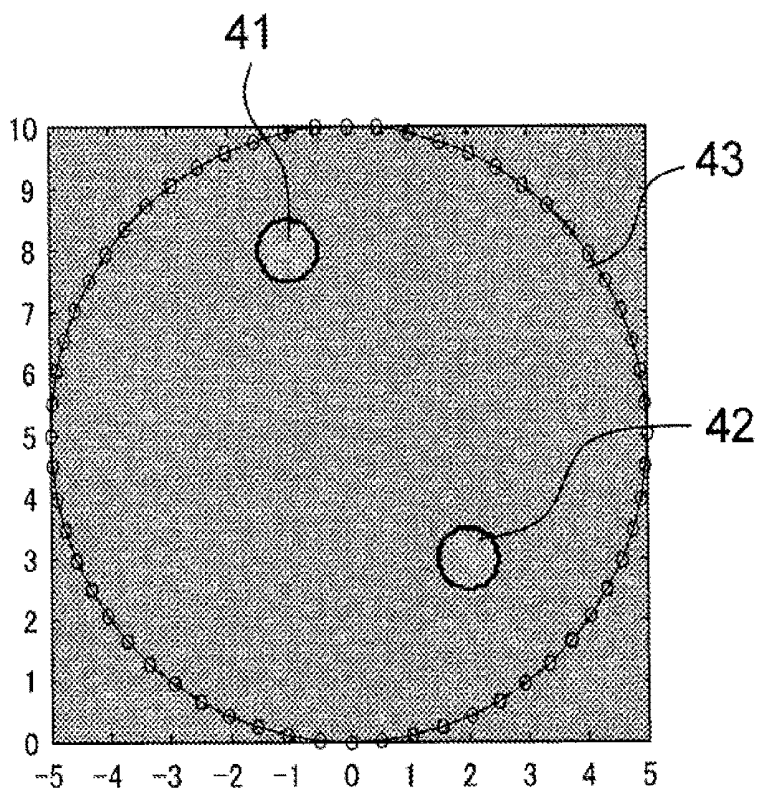

FIG.3B

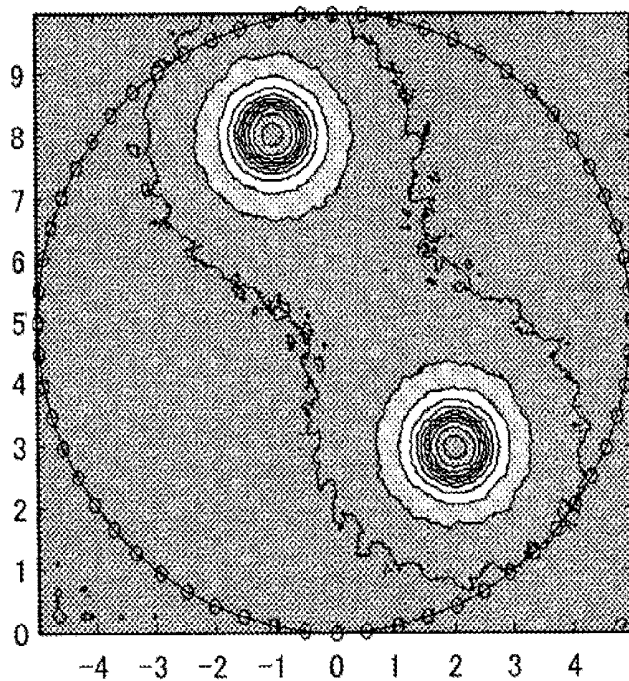

FIG.4

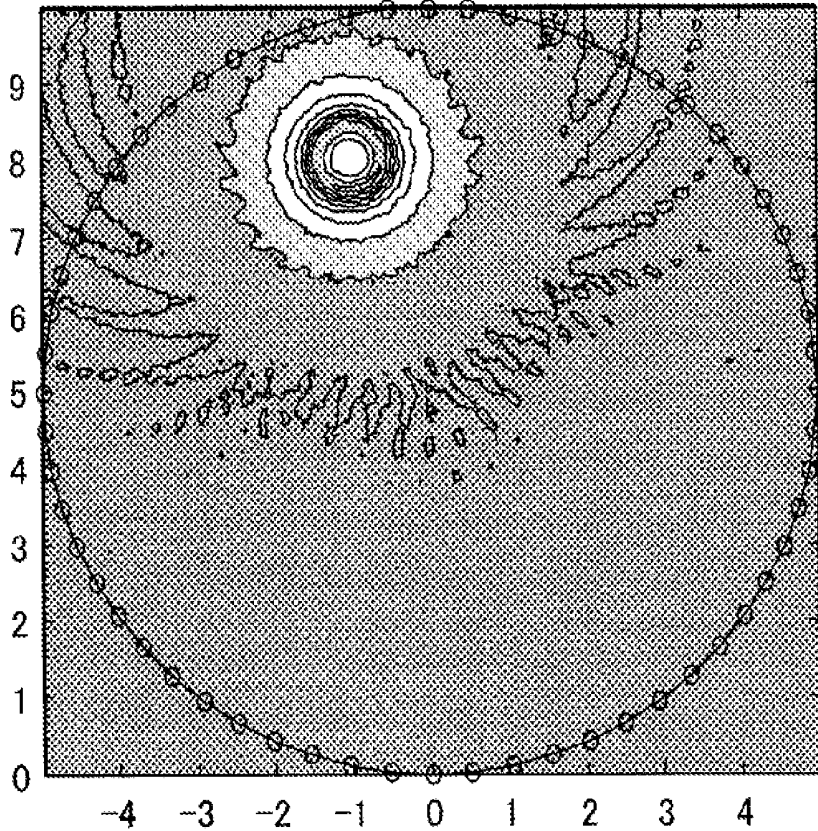

FIG.5A

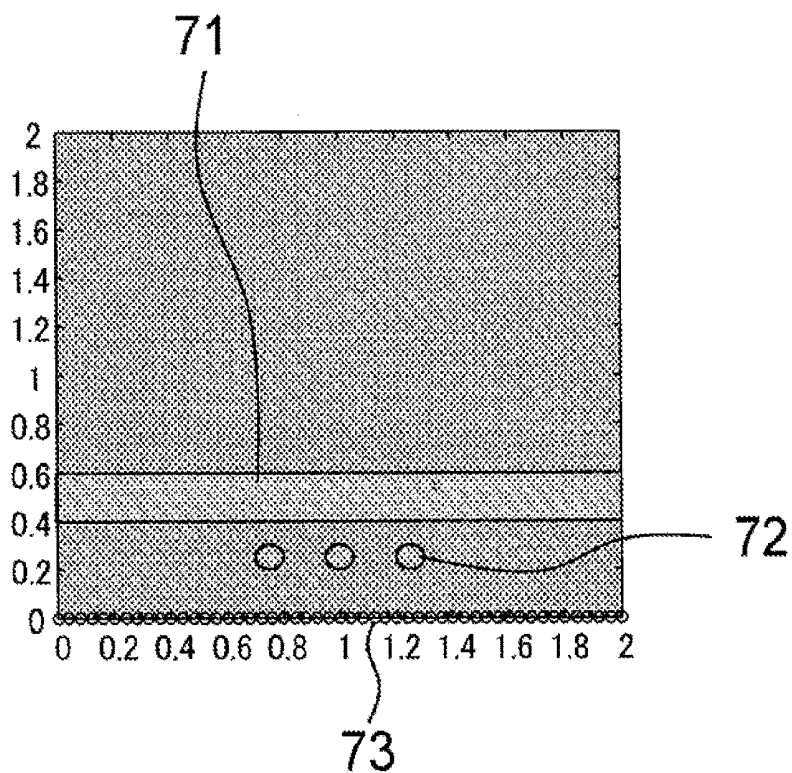

FIG.5B

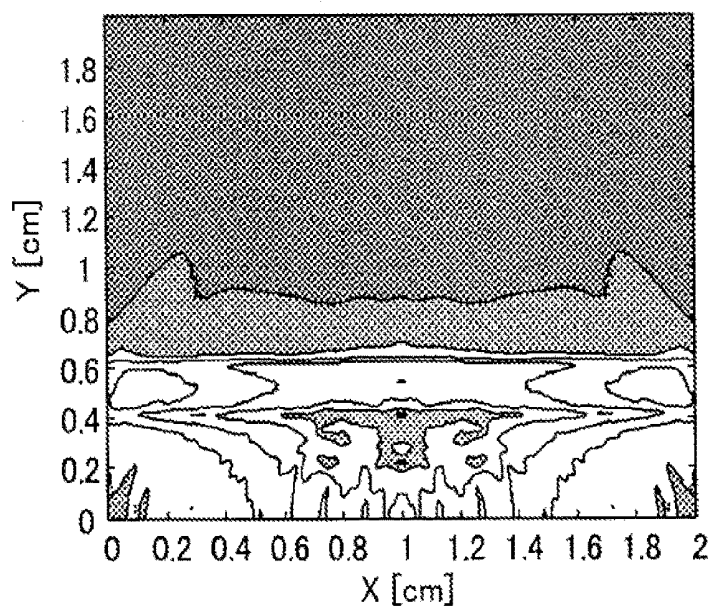

FIG.6A

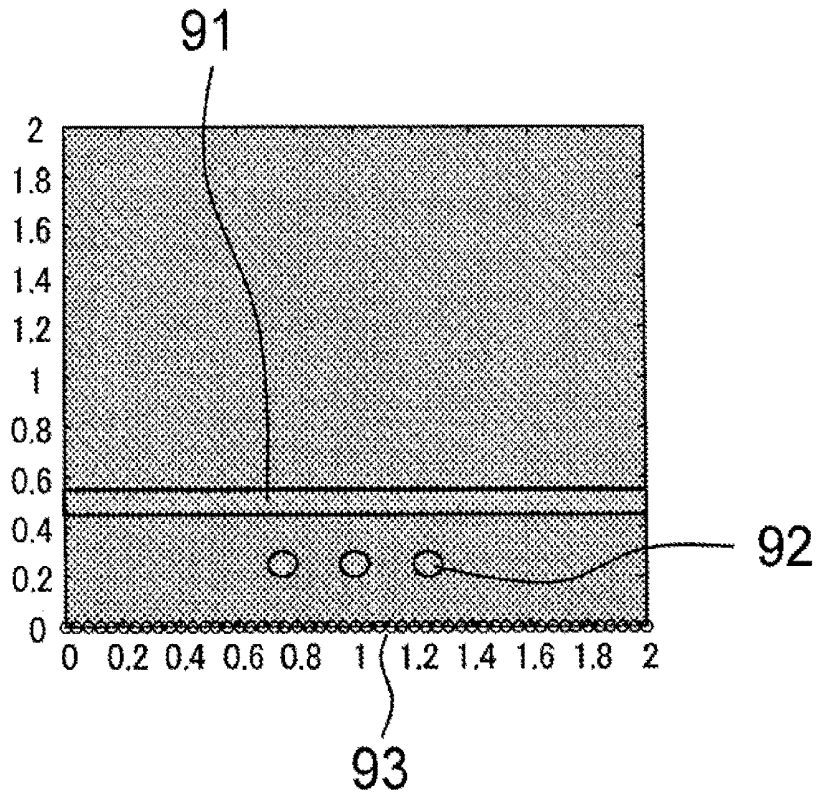

FIG.6B

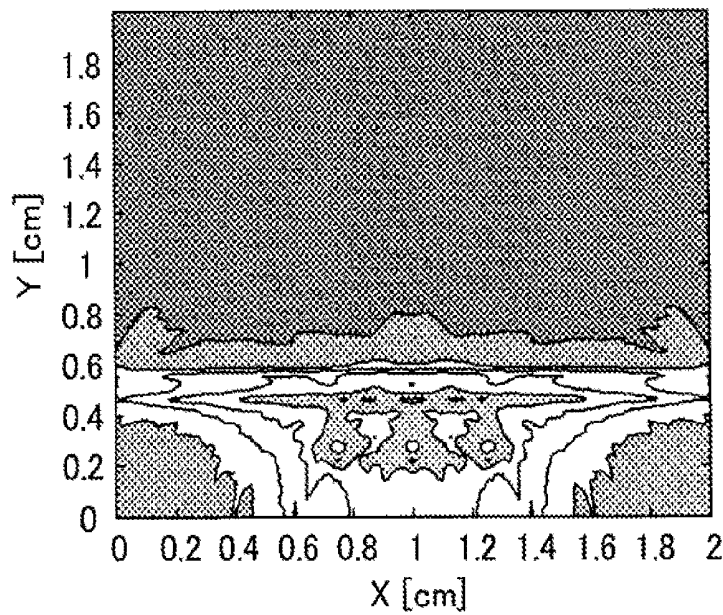

FIG.7

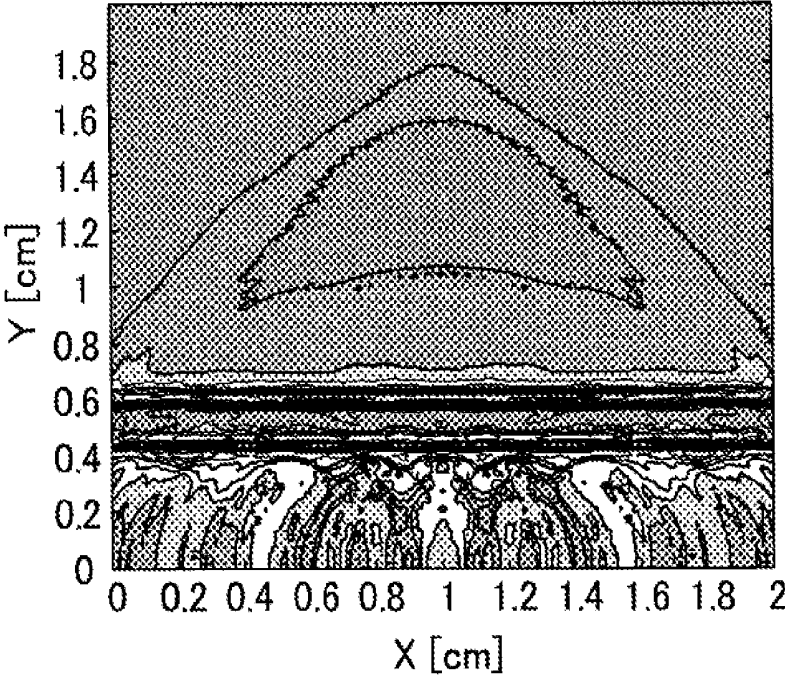

FIG.8

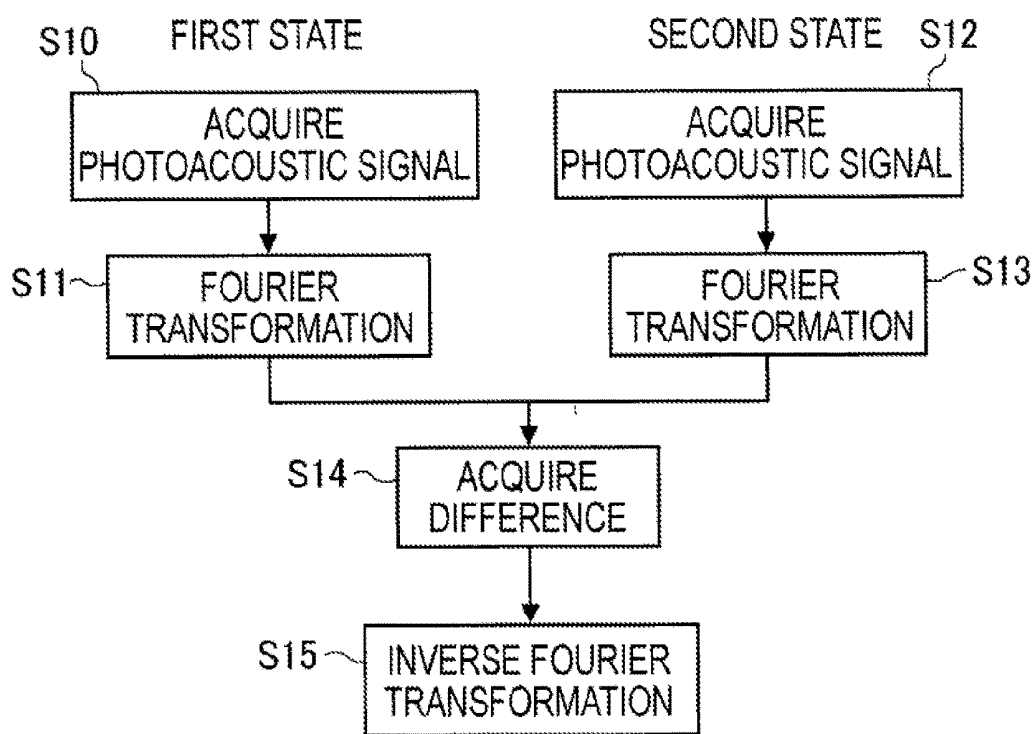

FIG.9A

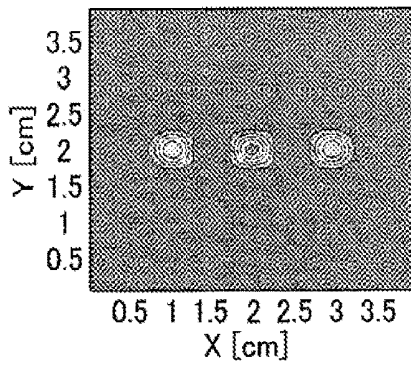

FIG.9B

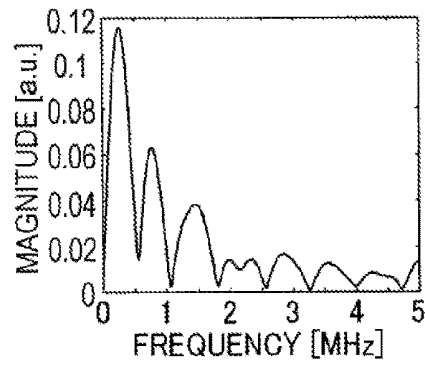

FIG.9C

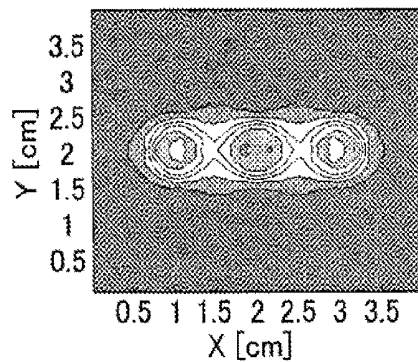

FIG.9D

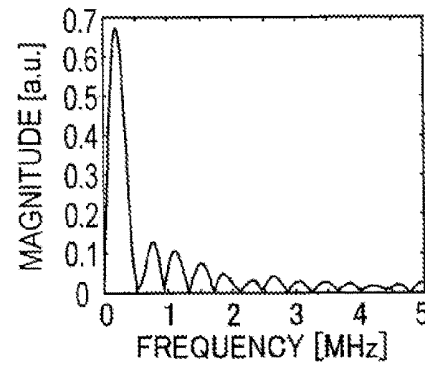

FIG.9E

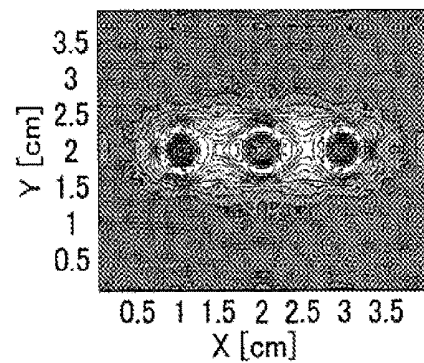
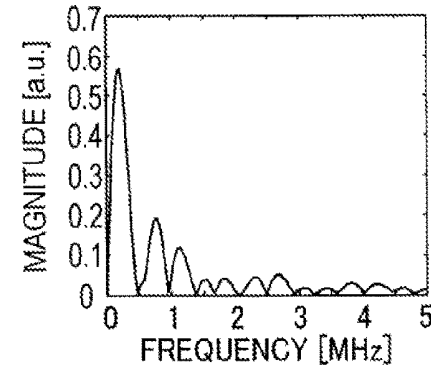

FIG.9F



↓ (DIFFERENCE)

FIG.10

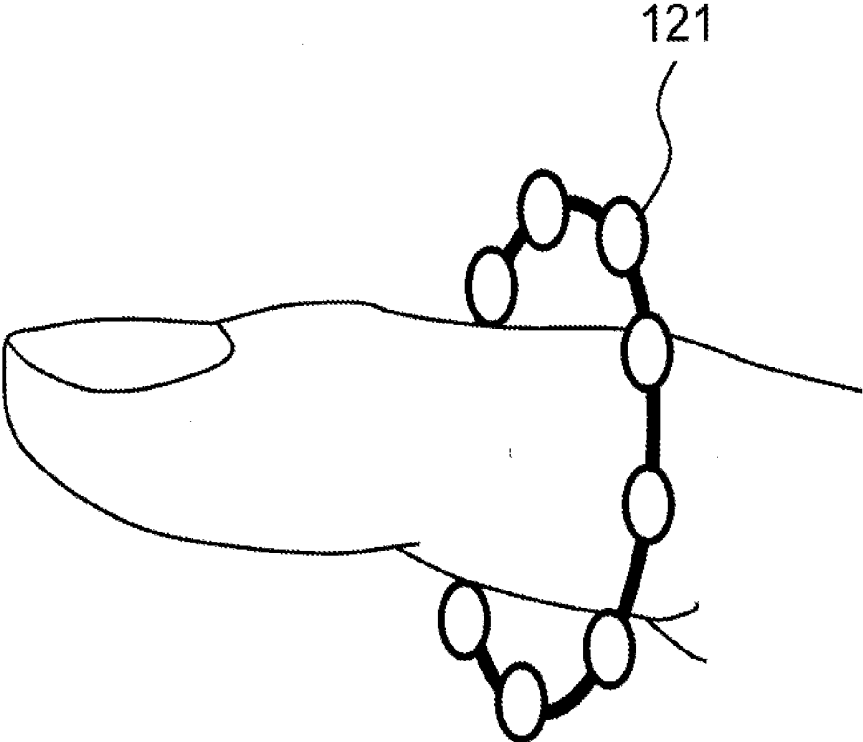
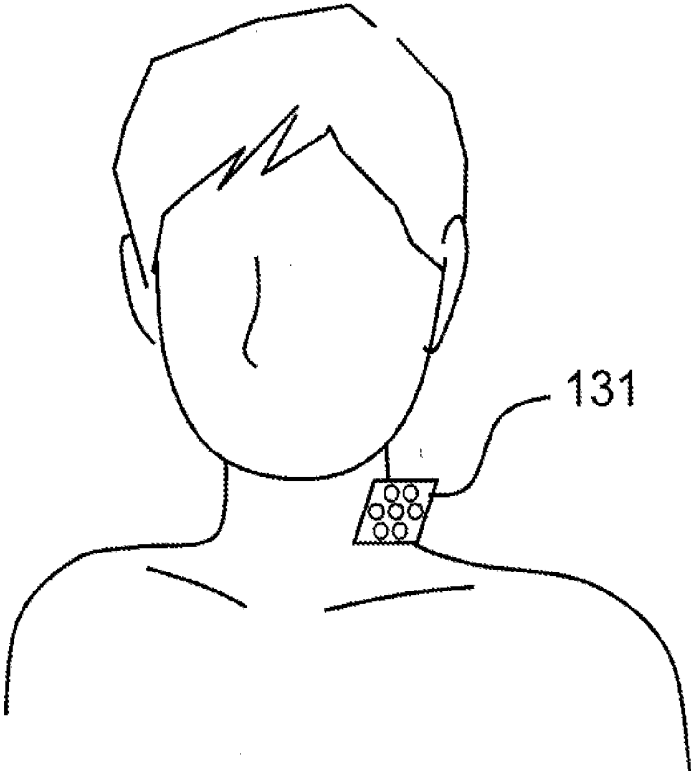

FIG.11



BIOLOGICAL INFORMATION IMAGING APPARATUS AND BIOLOGICAL INFORMATION IMAGING METHOD

RELATED APPLICATIONS

[0001] This application is a continuation of application Ser. No. 14/481,984, filed Sep. 10, 2014, which is a divisional of application Ser. No. 12/544,834, filed Aug. 20, 2009, claims benefit of those filing dates under 35 U.S.C. § 120, and claims the benefit of Japanese Patent Application No. 2008-211993, filed on Aug. 20, 2008; the entire contents of all mentioned earlier applications are incorporated herein by reference.

BACKGROUND OF THE INVENTION

Field of the Invention

[0002] The present invention relates to a biological information imaging apparatus and a biological information imaging method.

Description of the Related Art

[0003] Many imaging apparatuses using X-rays, ultrasonic waves, MRI (Magnetic Resonance Imaging), or the like are adopted as apparatuses acquiring biological information in a medical field, and are used for diagnosis.

[0004] With respect to an ultrasonic diagnostic imaging apparatus among these, Japanese patent application laid-open No. S62-189054 describes a method of diagnosing the heart, etc., using difference images of ultrasonic tomographic images that are taken at a high frame rate. The apparatus of this Japanese patent application laid-open No. S62-189054 once stores in a memory a plurality of time series tomographic images that are acquired by means of a probe by transmitting and receiving ultrasonic waves to and from a sample or object to be inspected, generates a difference image by subtracting the corresponding pixels of tomographic images for two frames sequentially stored, and displays the difference image thus generated on a screen.

SUMMARY OF THE INVENTION

[0005] In an ultrasonic diagnostic imaging apparatus, it is difficult to acquire a difference image in an entire region of a range (a part to be diagnosed) in which a diagnose diagnosis is intended to be made, due to the principles of diagnosis by means of ultrasonic waves. That is, in an ultrasonic diagnostic imaging apparatus, first of all, an operator sets up an ultrasonic transmission/reception direction towards a part the condition of which is to be diagnosed, such as for example a moving tissue part in a sample such as a heart, a blood vessel, etc., or a part having a blood flow, and places an ultrasonic probe in abutment with the sample. Then, ultrasonic wave pulses are transmitted from the ultrasonic probe to the interior of the sample. The ultrasonic wave propagated into the sample is reflected on a boundary where the acoustic impedence in the sample varies. The reflected wave (echo) is received by the ultrasonic probe. The echo thus received by this probe is subjected to various processing such as amplification, phasing, detection, etc., by means of a reception circuit, and then, it is digitally converted by an analog/digital converter, and stored into one of

line memories in a buffer memory circuit. As a result, data for one line of ultrasonic scanning is stored in the buffer memory circuit.

[0006] Subsequently, a CPU controls a transmission circuit so that an ultrasonic wave is caused to be transmitted in a direction different from that of a first transmission/reception wave, e.g., a direction contiguous to the first transmission/reception wave direction. An echo is taken in by making its direction of reception identical to that of this transmission/reception. In synchronization with this second transmission/reception, a first echo signal is read from the buffer memory circuit, and transmitted and stored in a first image memory. On the other hand, a second echo signal is stored into the other line memory of the buffer memory circuit. Thus, the transmission and reception of an ultrasonic wave is performed by changing the direction thereof in a sequential manner, and when the scanning of one image is completed, the transmission/reception direction is returned to the initial direction, and the transmission/reception of an ultrasonic wave are carried out in a repeated manner. Then, a plurality of tomographic images are taken in a manner like a first image, a second image, a third image, . . . , an n-th image.

[0007] Thus, in an ultrasonic diagnostic imaging apparatus, a plurality of line images acquired in line sequential order have to be arranged in order to form one tomographic image. That is, a tomographic image obtained by the ultrasonic diagnostic imaging apparatus does not correctly represent the shape of a certain momentary image, but becomes an image containing a shape distortion resulting from the difference in acquisition time of the line images. For example, in cases where a tomographic image of moving tissue such as a heart is acquired, there arises a shift or difference in phase of a motion on the right and the left of the tomographic image. Accordingly, in conventional ultrasonic images, a comparison in image shape between the images of different frames has not been able to be correctly made.

[0008] In view of the aforementioned problems, the present invention has for its object to provide a biological information imaging apparatus and a biological information imaging method which are capable of performing comparison between images of different frames in a correct manner.

[0009] The present invention in a first aspect provides a biological information imaging apparatus comprising: a measurement unit that measures an acoustic wave emitted from a tissue in a living body at a time when the tissue absorbs light irradiated onto the living body; a storage unit that stores first information obtained in a first measurement by the measurement unit; and an information processing unit that generate an image of information of the tissue in the living body by using second information obtained in a second measurement by the measurement unit and the first information stored in the storage unit.

[0010] The present invention in a second aspect provides a biological information imaging method comprising: a first measurement step to measures an acoustic wave emitted from a tissue in a living body at a time when the tissue absorbs light irradiated onto the living body; a storage step to store first information obtained in the first measurement step; a second measurement step to measures an acoustic wave emitted from the tissue in the living body at a time when the tissue absorbs light irradiated onto the living body; and a processing step to generate an image of information of

the tissue in the living body by using second information obtained in the second measurement step and the first information stored in the storage step.

[0011] According to the present invention, a comparison between images of different frames can be performed in a correct manner. By doing so, it becomes possible to correctly catch a change of a moving tissue, such as a motion of visceral including a heart, a change in thickness or size of a blood vessel due to a blood flow, etc.

[0012] Further features of the present invention will become apparent from the following description of exemplary embodiments with reference to the attached drawings.

BRIEF DESCRIPTION OF THE DRAWINGS

[0013] FIG. 1 is a view showing the construction of a biological information imaging apparatus in an embodiment of the present invention.

[0014] FIG. 2A is a view showing the arrangement of a sample in a first state in the first example, FIG. 2B is a view showing a reconstructed image in the first state.

[0015] FIG. 3A is a view showing the arrangement of the sample in a second state in the first example, and FIG. 3B is a view showing the reconstructed image in the second state.

[0016] FIG. 4 is a view showing a difference image between the images in the first state and the second state in the first example.

[0017] FIG. 5A is a view showing the arrangement of a sample in a first state in a second example, and FIG. 5B is a view showing a reconstructed image in the first state.

[0018] FIG. 6A is a view showing the arrangement of the sample in a second state in the second example, and FIG. 6B is a view showing a reconstructed image in the second state.

[0019] FIG. 7 is a view showing a difference image between the images in the first state and the second state in the second example.

[0020] FIG. 8 is a flow chart of a third example.

[0021] FIG. 9A is a view showing a reconstructed image in a first state in the third example, FIG. 9B is a view showing Fourier transformation data for the image in the first state, FIG. 9C is a view showing a reconstructed image in a second state, FIG. 9D is a view showing Fourier transformation data for the image in the second state, FIG. 9E is a view showing an image which is obtained by performing inverse Fourier transform on difference data, and FIG. 9F is a view showing the difference data between the images in the first and second state.

[0022] FIG. 10 is a view showing an example in which an ultrasonic probe is arranged around an entire circumference of a living body.

[0023] FIG. 11 is a view showing an example in which an ultrasonic probe is arranged at one side of a living body.

DESCRIPTION OF THE EMBODIMENTS

[0024] The present invention provides a biological information imaging apparatus that is constructed in the following manner.

[0025] The biological information imaging apparatus of the present invention is a biological information imaging apparatus using a photoacoustic tomography (PAT). This biological information imaging apparatus is provided with a measurement unit that measures an acoustic wave emitted from a tissue in a living body at a time when the tissue absorbs light irradiated onto the living body. The measure-

ment unit comprises, for example, a light source, and an acoustic wave detector that detects acoustic waves (elastic waves, ultrasonic waves) generated from a light absorber (optical absorber) which has absorbed a part of the energy of light irradiated to the living body, and transduces them into electric signals. In addition, the biological information imaging apparatus is provided with a storage unit (memory) that stores first information acquired in a first measurement by the measurement unit. It is desirable that the storage unit have a capacity capable of storing the information acquired in at least one measurement (e.g., a reconstructed image for one frame). Also, the biological information imaging apparatus is provided with an information processing unit, and this information processing unit generates an image of the information of the tissue in the living body by using second information acquired in a second measurement by the measurement unit and the first information stored in the storage unit. Specifically, the second measurement is carried out at a timing at which the shape of the tissue is different from that at the timing of the first measurement, and the information processing unit generates a difference image representing a difference between the first information and the second information. Here, "the shape of the tissue is different" means that at least either of the shape, position and size of the tissue differs. The tissue, which is a target of imaging, is a blood vessel, for example.

(Basic Principles of PAT)

[0026] PAT is a technique that irradiates a living body with pulsed light generated from a light source, detects acoustic waves emitted from a living tissue which absorbed the energy of the light propagated and diffused in the living body, and performs analytic processing of their signals. With this technology, because of the use of light, it can be found how the light is absorbed in the living tissue, and at the same time, because of performing detection by acoustic waves (elastic waves, typically ultrasonic waves), an optical property distribution in the living body can be obtained at a resolution substantially equivalent to that in an ultrasonic diagnostic imaging apparatus.

[0027] In PAT, a sound pressure P of the acoustic waves obtained from a light absorber in the living body due to the light absorption is given by the following formula (1).

$$P = \Gamma \mu_a \Phi \quad (1)$$

Here Γ is a Grüneisen parameter which is an elastic property value, and which is obtained by dividing the product of a volume expansion coefficient β and the square of a speed of sound c by a specific heat C_p . In addition, μ_a is an optical absorption coefficient of the absorber, and Φ is a quantity of light in a local region (a quantity of localized light irradiated to the absorber).

[0028] Since it is known that Γ will take an almost constant value if the tissue is decided, the product of μ_a and Φ , i.e., an optical energy absorption density, can be estimated by measuring the sound pressure P , which is the magnitude of the acoustic waves, in a time sharing manner. In addition, by measuring this at multipoints, a spatial distribution of the absorber in the living body can be acquired.

[0029] The basic principle of image picking-up by the PAT technique is briefly as follows.

[0030] (1) A sample is irradiated with light from the outside thereof.

[0031] (2) The light propagates through the interior of the sample.

[0032] (3) A part (light absorber) of a large optical absorption coefficient existing in the interior of the sample absorbs the light.

[0033] (4) The part concerned is heated due to the above-mentioned optical absorption.

[0034] (5) The part thus heated expands.

[0035] (6) An acoustic wave (ultrasonic wave) is generated (emitted) in accordance with the expansion of the heated part.

[0036] (7) The acoustic wave propagates through the interior of the sample.

[0037] (8) The propagating acoustic wave is received by the use of an acoustic wave detector (an ultrasonic probe).

[0038] (9) Time difference of the arrival acoustic wave, etc., is analyzed to reconstruct tomographic images or three-dimensional images of the sample.

[0039] As stated in the above-mentioned problems, one frame period is required for the conventional ultrasonic diagnostic imaging apparatus to form one image. That is, in general, in cases where a video of 30 frames per second is displayed, images at time points different by $\frac{1}{30}$ second from each other will be displayed at the first line and the last line, respectively, in one frame.

[0040] On the other hand, in cases where the PAT technique is used, ultrasonic waves can be simultaneously generated from a desired diagnostic region by irradiating it with light. For example, if the diagnostic region is a square area with each side of 10 centimeter, the arrival time differences of the light are about a maximum of 0.3 picoseconds. This is equivalent to an error of 0.5 micrometers when it is assumed that the propagation speed of ultrasonic waves in the living body is 1,500 meters per second. In view of the fact that the resolution required in the PAT technique is on the order of from submillimeters to several millimeters, such an error can be completely disregarded. That is, in the PAT technique, it is possible to acquire an image (image shape) at substantially the same time.

(Example of the Construction of the Biological Information Imaging Apparatus)

[0041] FIG. 1 shows a view explaining an example of the construction of the biological information imaging apparatus in this embodiment. The biological information imaging apparatus is provided with a light source (including an optical control part) **50**, an acoustic wave detector **55**, and a signal processing part (information processing unit) **56**.

[0042] The light source **50** is a unit for irradiating a living body **51** with pulsed light **53**. An optical waveguide such as an optical fiber for guiding the light to the living body **51** may be provided as needed. The light source **50** irradiates light of a specific wave length that can be absorbed by a specific component existing in the living body. As the light source, there is provided at least one pulsed light source that can generate pulsed light on the order of from several to hundreds nanoseconds. A laser is desirable as the light source, but it is also possible to use a light emitting diode or the like instead of the laser. As a laser, there can be used various kinds of laser such as a solid-state laser, a gas laser, a dye laser, a semiconductor laser, and so on. In addition, although in this embodiment, an example of a single light source is shown, a plurality of light sources can be used. In the case of the plurality of light sources, in order to raise the

irradiation intensity of the light to be irradiated on the living body, there can be used two or more light sources which oscillate at the same wave length, or in order to measure differences in the optical property value distribution according to the wave lengths, two or more light sources having different oscillation wavelengths can be used. Here, note that if a dye of which the oscillating wave length is convertible and OPO (Optical Parametric Oscillators) can be used as the light source, it will also become possible to measure the difference in the optical property value distributions depending upon the wave lengths. It is preferable that the wave lengths to be used be in a range of from 700 to 1,100 nm in which there is little absorption in the living body. However, in cases where an optical property value distribution of the living body tissue relatively near a living body surface thereof, it is also possible to use a wave length range, such as for example a range of from 400 to 1,600 nm, wider than the above-mentioned wavelength range.

[0043] The acoustic wave detector **55** is a unit for detecting an acoustic wave **54** emitted from the light absorber **52** which absorbed a part of the energy of light irradiated to the living body **51**, and transducing (changing) it into an electric signal. The electric signal outputted from the acoustic wave detector **55** is inputted into the signal processing part **56**. As the acoustic wave detector **55**, there can be used a transducer using a piezo-electric phenomenon, a transducer using the resonance of light, a transducer using a change of capacitance, and so on. As the light absorber **52**, it corresponds, for example, to a blood vessel, a tumor, or like other tissues similar to these. Here, note that this embodiment is suitable in particular for imaging a light absorber in motion.

[0044] The signal processing part **56** is a function to analyze the electric signal outputted from the acoustic wave detector **55**, and to obtain optical property value distribution information on the living body. In addition, the signal processing part **56** has an image memory (frame memory) that stores image information (image data of tomographic images or three dimensional images) for at least one screen. Moreover, the signal processing part **56** also has a function to compare a first image acquired in a first state at one timing and stored in this image memory with a second image acquired in a second state at another timing, and to calculate a difference between them. The signal processing part **56** can also take any construction and arrangement as long as functions, such as inputting of electric signals, storage and operation of data (including image information), outputting of the results of the operation, and so on, can be achieved. For example, the signal processing part **56** can be comprised of a computer with an analysis program. Here, note that the optical property value distribution information, the difference image information, etc., which are the results of operations of the signal processing part **56**, are outputted to a display device (not shown).

(Generation Processing of the Difference Image)

[0045] The image picking-up by the PAT technique in this embodiment is performed in the following flow. Here, note that a mechanism in which acoustic waves are emitted from the light absorber by irradiation of light is the same as that in the flow of the basic principle as mentioned above.

[0046] (1) Light is irradiated to the sample in its first state from the outside thereof.

- [0047] (2) A first acoustic wave (ultrasonic wave) is emitted from a part having a large optical absorption coefficient.
- [0048] (3) The first acoustic wave having propagated through the interior of the sample is received by the use of the acoustic wave detector (the ultrasonic probe) in the outside of the sample (a first measurement step).
- [0049] (4) The time difference of the arrival acoustic wave, etc., is analyzed and the first image (tomographic image or three-dimensional image) of the sample is reconstructed.
- [0050] (5) The first image thus acquired is stored in the image memory (a storage step).
- [0051] (6) Light is irradiated to the sample from the outside thereof in its second state different from the first state.
- [0052] (7) A second acoustic wave (ultrasonic wave) is emitted from the part having the large optical absorption coefficient.
- [0053] (8) The second acoustic wave having propagated through the interior of the sample is received by the use of the acoustic wave detector (the ultrasonic probe) in the outside of the sample (a second measurement step).
- [0054] (9) The time difference of the arrival acoustic wave, etc., is analyzed and the second image (tomographic image or three-dimensional image) of the sample is reconstructed.
- [0055] (10) A difference is acquired by comparing the second image acquired in (9) with the first image stored in the image memory in (5) (a processing step).
- [0056] According to the above-mentioned flow, after performing the first measurement and the second measurement at different timings and reconstructing the images in the two different states, it is possible to extract only those parts which have changed by acquiring the difference between these two images. Here, note that the first measurement and the second measurement are performed at timings at which tissues (a blood vessel, a lesion part, etc.) to be measured are mutually different in shape from each other.

(Advantages of the Embodiment)

[0057] According to this embodiment of the present invention as described above, a comparison between frames becomes able to be correctly made, so it is possible to extract only those parts which are changing by acquiring the difference between the frames. That is, in the conventional ultrasonic diagnostic apparatus which acquires an image in line sequential order, it is impossible to make a comparison between frames in a correct manner as shown in the aforementioned problems, but in contrast, with the construction of this embodiment, photoacoustic tomography is used upon imaging. Since this method performs imaging by irradiating light without scanning in a line sequential fashion unlike the conventional ultrasonic diagnostic imaging apparatus, it becomes possible to acquire simultaneous information on different places inside the living body. As a result, it becomes possible from the difference images between the frames to grasp how the state of the tissue changes in a correct manner. By making use of this, it will become possible to take a vivid or clear image of a moving tissue such as for example a blood vessel figure, a lesion part that has changed over time, etc.

FIRST EXAMPLE

[0058] A first example of the present invention will be described below. The first example is an example in which image reconstruction is carried out from ultrasonic waves detected in the entire circumference of the sample. Here, reference will be made to a simulation that was performed under the condition that a situation at the time of actual measurement is simulated while using drawings. Although a three-dimensional space has to be taken into consideration in actual measurement or diagnosis, computations on a two-dimensional plane are shown in this computation process.

[0059] FIG. 2A and FIG. 3A illustrate implementation conditions for the simulation employed in the first example, and indicate an arrangement of the sample. FIG. 2A indicates a first state and FIG. 3A indicates a second state. Here, for example, in FIG. 2A, reference numerals 21 and 22 denote light absorbers, respectively. Uniform light is irradiated to this sample from an arbitrary place (not shown), so that acoustic waves emitted from the light absorbers 21, 22 are detected by an ultrasonic probe 23 which is an acoustic wave detector. This ultrasonic probe 23 takes a substantially circular shape that encloses the entire circumferences of the light absorbers 21, 22. Sixty small circles drawn on the circle indicate ultrasonic wave receiving elements, respectively. That is, the ultrasonic waves emitted from the light absorbers 21, 22 are detected by the sixty ultrasonic wave receiving elements that are arranged on the entire circumference. In FIG. 3A, reference numerals 41 and 42 denote light absorbers, respectively, and a reference numeral 43 denotes an ultrasonic probe. A difference between FIG. 2A and FIG. 3A is that the shapes of the light absorbers (21, 41) lying in the upper left in these figures are different from each other.

[0060] It is known that, as for an acoustic wave generated due to a photoacoustic effect, an acoustic wave emitted from an absorber, if its shape is spherical, can be analytically calculated through calculation, and that the acoustic wave thus calculated is in match with that obtained through experiments. In a calculation limited on a two-dimensional plane, if the shape of an absorber is circular, an acoustic wave emitted from the absorber can be calculated in a similar manner. That is, it is known that the profile of the ultrasonic wave exhibits a change of "N" shape in which the change of its amplitude once rises from zero to a positive pressure, then falls to a negative pressure, and thereafter returns to zero. It is also known that the width of this N shape is proportional to the size of the light absorber, and that the height (amplitude) of the N shape is proportional to the product of an amount of light arrived and an optical absorption coefficient, as shown by the above-mentioned formula (1).

[0061] The acoustic waves generated in the light absorbers spread in an isotropic manner, propagate through the interior of the living body, and arrive at the ultrasonic wave receiving elements. The arrival acoustic waves, which have been measured at a plurality of points, can be imaged by using a well-known analysis method. In this example, image reconstruction was performed using a well-known circular back-projection method (CBP method), and a first image was obtained from acoustic wave signals detected at sixty points in the sample of FIG. 2A. FIG. 2B shows the first image. On the other hand, image reconstruction was performed with the sample of FIG. 3A as in the case of FIG. 2A, whereby a second image was obtained. FIG. 3B shows the second image.

[0062] Even if the image of FIG. 2B and the image of FIG. 3B are juxtaposed and compared with each other, two circular-shaped things only exist in both of these images, so it is difficult to distinguish differences between these two images immediately.

[0063] Accordingly, in this example, a difference between the image of FIG. 2B and the image of FIG. 3B (a density difference between pixels) is calculated, and a difference image thus obtained is outputted. FIG. 4 shows the difference image. In the difference image, parts of an identical shape (light absorbers 22, 42) are eliminated, and parts of different shapes (light absorbers 21, 41) are extracted. Thus, by calculating a difference between two images acquired in their different states, it becomes possible to obtain an image in which only those parts of which the shapes, the positions, the sizes, etc., are changing are emphasized.

SECOND EXAMPLE

[0064] A second example of the present invention will be described below. The second example is an example in which image reconstruction is carried out from ultrasonic waves detected at one side of a sample. That is, in the first example, the ultrasonic wave receiving elements are arranged so as to surround the two light absorbers, but in contrast, in the second example, ultrasonic wave receiving elements are arranged only at one side with respect to a light absorber. Here, reference will be made to a simulation that was performed under the condition that a situation at the time of actual measurement is simulated while using drawings. Although a three-dimensional space has to be taken into consideration in actual measurement or diagnosis, computations on a two-dimensional plane are shown in this computation process.

[0065] FIG. 5A and FIG. 6A indicate the arrangements of the sample used for the second example. FIG. 5A indicates a first state of the sample, and FIG. 6A indicates a second state thereof. Here, in FIG. 5A, a reference numeral 71 denotes a light absorber of a rod shape, and a reference numeral 72 denotes light absorbers each of a circular shape. These light absorbers are irradiated with uniform light from arbitrary places (not shown), and acoustic waves emitted from the light absorbers 71, 72 are detected by an ultrasonic probe 73 which is an acoustic wave detector. Here, note that a difference between FIG. 5A and FIG. 6A is that the sizes of rod-shaped light absorbers (71, 91) are different from each other. The diameters of circular-shaped light absorbers (72, 92) are the same.

[0066] In such arrangements, image reconstruction was carried out by using the CBP method, as in the first example. The first image, which is the result reconstructed from ultrasonic signals detected in the sample arrangement of FIG. 5A is shown in FIG. 5B. Also, the second image, which is the result reconstructed from ultrasonic signals detected in the sample arrangement of FIG. 6A is shown in FIG. 6B.

[0067] Thus, in both FIG. 5B and FIG. 6B, parts of reconstructed images of the rod-shaped light absorber and the circular-shaped light absorbers overlap with one another, and good reconstructed images can not be obtained. As a result, it is difficult to distinguish the difference in size of the rod-shaped light absorbers.

[0068] In contrast to these, FIG. 7 shows that differences between these image data are calculated. In FIG. 7, the image of a circular-shaped light absorber is eliminated by means of difference calculation between the image data.

Although the image is disturbed a little due to the influence of the rod-shaped light absorber and the shortage in the amount of information resulting from receiving the ultrasonic signals only at one side of the rod-shaped light absorber, it is understood that a rod-shaped part, being different in shape from others, has been extracted. Thus, by calculating a difference between two images acquired in their different states, it becomes possible to obtain an image in which only those parts of which the shapes, the positions, the sizes, etc., are changing are emphasized.

THIRD EXAMPLE

[0069] A third example of the present invention will be described below. In the first and second examples, those parts which have changed in their state are extracted by generating a difference image between image data after performing image reconstruction. That is, difference calculation is performed in real space. In contrast to this, in the third example, a difference image is generated from data that is obtained by transforming acoustic wave signals into corresponding signals in a frequency domain, taking a difference between signal data in the frequency domain, and performing inverse transformation of the difference to a space domain.

[0070] FIG. 8 is a flow chart which shows the flow of processing of the third example. First, in the first state, light irradiation and acoustic wave detection are performed (step S10), and the thus detected acoustic wave signals are Fourier-transformed (step S11). The Fourier-transformed signal data for one image are stored in the image memory. Then, in the second state, light irradiation and acoustic wave detection are performed (step S12), and the thus detected acoustic wave signals are Fourier-transformed (step S13). Thereafter, a difference between the signal data acquired in the first state and the signal data acquired in the second state is taken (step S14), and inverse Fourier transformation of the difference data is carried out (step S15). Image reconstruction is performed from the difference data of the acoustic wave signals obtained by the inverse Fourier transformation.

[0071] Hereafter, the result of a simulation of the third example will be explained by using FIG. 9A through FIG. 9F. In the third example, there is employed a sample in which three light absorbers each of a circular shape are arranged at intervals of 1 cm at locations apart by 2 cm from an ultrasonic probe. FIG. 9A shows an image reconstructed from the acoustic wave signals acquired in the first state, and FIG. 9B shows the data obtained by Fourier-transforming the acoustic wave signals acquired in the first state. In addition, FIG. 9C shows an image reconstructed from the acoustic wave signals acquired in the second state, and FIG. 9D shows the data obtained by Fourier-transforming the acoustic wave signals acquired in the second state. A difference between the first state and the second state is that in the first state, the diameter of each light absorber is 2 mm, whereas in the second state, the diameter of each light absorber is 4 mm.

[0072] FIG. 9E shows the difference data between the signal data shown in FIG. 9B and the signal data shown in FIG. 9D. FIG. 9F shows what was obtained by imaging the difference data of FIG. 9E through inverse Fourier transformation. Thus, even if the difference is acquired in a frequency space, it is possible to extract those parts which have been changed in their states.

OTHER EXAMPLES

[0073] A blood vessel can be imaged by using the methods according to the above-mentioned examples. For example, the method of the first example can be used in cases where an ultrasonic probe 121 is arranged around a finger for measuring ultrasonic waves, as shown in FIG. 10. Also, the method of the second example can be used in cases where an ultrasonic probe 131 is arranged at one side face with respect to a blood vessel in such a manner as to be pressed against a carotid artery for measuring ultrasonic waves, for example, as shown in FIG. 11.

[0074] Here, note that, in either of the above cases, it is desirable to use a matching agent or the like which is arranged between the ultrasonic probe and the living body for taking the matching of acoustic impedance therebetween.

[0075] The blood vessel is momentarily changing its size in accordance with the flow of blood therein. That is, the blood vessel contracts and expands its size to cause blood to flow therein in synchronization with the heart beat. Thus, the biological information imaging apparatus monitors the heart beat, and performs light irradiation in synchronization with the heart beat, whereby it becomes possible for the apparatus to acquire the state at that timing as an image. Specifically, when blood pressure is substantially systolic blood pressure (first state), a first measurement is carried out, and when the blood pressure is substantially diastolic blood pressure (second state), a second measurement is carried out. Thereby, an image of the blood vessel in a high blood pressure state and an image of the blood vessel in a low blood pressure state are obtained. Then, by performing a comparison between these images, it becomes possible to represent only those parts in which the diameter of the blood vessel has changed following the blood pressure change.

[0076] Now, in cases where a part in which the heart beat is measured and a part which is to be diagnosed are separated from each other, a synchronized image can not necessarily be obtained. In this case, if a measurement is made in a rest state as the first state and a measurement is then made in a high heart rate as the second state, a blood vessel figure can be imaged in a correct manner. That is, the timing at which the size of a blood vessel in the first state coincides with that in the second state in which the heart rate is different from that in the first state is very rare, and hence, if a difference is taken between such states, it will become possible to image the blood vessel. In cases where such a difference can not be taken well, the probability at which the blood vessel can be imaged well will be increased if a measurement is performed again in a high heart rate state.

[0077] Here, note that, in order to create these two states, a state in which the measurement is carried out after one takes a rest such as sleeping on a bed or sitting on a chair is made the first state, and a state in which the measurement is carried out after one is put into a high heart rate state by doing exercise spontaneously or by being given a stimulus or stress from the outside is made the second state. Thus, the blood vessel can be imaged from a difference image between the two states.

[0078] Alternatively, a device with a function to cause such a high heart rate state (e.g., a stress applying function) may also be built into the above-mentioned biological information imaging apparatus. In addition, the biological information imaging apparatus may have a function to measure the heart rate, so that it can automatically determine

whether one is in a high heart rate state, and decide the timing at which a second measurement is made.

[0079] In addition, a compare may be made between different blood pressure states. For example, an early morning hypotensive state is assumed to be the first state, and a measurement at this time is assumed as the first measurement. Subsequently, a high blood pressure state in an active time zone is assumed to be the second state, and a measurement at this time is assumed as the second measurement. By acquiring a difference between these two states, it becomes possible to image a blood vessel. Also, the biological information imaging apparatus may have a function to measure the blood pressure, so that it can automatically determine whether one is in a low blood pressure state or in a high blood pressure state.

[0080] Moreover, it is known that a difference between tissues can be observed by using two kinds of light of different wave lengths. For example, since the degree of oxidation of hemoglobin changes with the wave length of light, it is known that an artery and a vein can be imaged by performing measurements while changing the wave length of light.

[0081] When imaging the above-mentioned blood vessels, the change in the size of the blood vessel in the artery is large, whereas in the vein, the size of its blood vessel is little changed even due to the flow of blood therein. That is, it can be considered that the vein is a reference tissue of which the state does not change. By making use of this, at the time of acquiring a difference between the two states, it becomes possible to obtain a difference image with substantially no occurrence of a positional shift by performing registration in such a manner that the reference tissues, i.e., veins, of which the states do not change, are in register with each other.

[0082] In order to perform imaging according to a vein(s), imaging in the first state and imaging in the second state are carried out in a wavelength band (700 through 800 nm) in which a lot of hemoglobin uncombined with oxygen can be absorbed. Subsequently, imaging in the first state and imaging in the second state are carried out in a wavelength band (800 through 1,000 nm) in which a lot of oxygenated hemoglobin can be absorbed. The reconstruction of images thus obtained is carried out in such a manner that a reconstructed image in the wavelength band in which a lot of hemoglobin uncombined with oxygen can be absorbed is taken to be a venous image, and registration is performed in such a manner that a venous image in the first state and a venous image in the second state are in match with each other. Thereafter, in that position thus registered, a difference between the reconstructed images at the wave length at which the oxygenated hemoglobin is absorbed is acquired.

[0083] It becomes possible to image the artery in a more accurate manner by obtaining a difference image with such a procedure.

[0084] While the present invention has been described with reference to exemplary embodiments, it is to be understood that the invention is not limited to the disclosed exemplary embodiments. The scope of the following claims is to be accorded the broadest interpretation so as to encompass all such modifications and equivalent structures and functions.

1. (canceled)
2. A biological information imaging method comprising: obtaining first image data based on a first acoustic wave generated by irradiating a sample with first light having

a first wavelength, the first wavelength including a wavelength which is from 700 nm to 800 nm;

obtaining second image data based on a second acoustic wave generated by irradiating the sample with second light having a second wavelength different from the first wavelength, the second wavelength including a wavelength which is from 800 nm to 1000 nm;

obtaining third image data based on a third acoustic wave generated by irradiating the sample with third light having the first wavelength at a time point different from a time point when the sample is irradiated with the first light;

obtaining fourth image data based on a fourth acoustic wave generated by irradiating the sample with fourth light having the second wavelength at a time point different from a time point when the sample is irradiated with the second light;

performing registration between the first image data and the third image data; and

obtaining difference image data by calculating a difference between the second image data and the fourth image data which are in positions registered between the first image data and the third image data.

3. The biological information imaging method according to claim 2, wherein the first, second, third and fourth image data are obtained in two-dimensional space or three-dimensional space.

4. The biological information imaging method according to claim 2, wherein the registration between the first image data and the third image data is performed in such a manner that a venous image in the first image data and a venous image in the third image data are in register with each other.

5. The biological information imaging method according to claim 2, further comprising storing the second image data in a storage unit,

wherein the difference image data is obtained by calculating the difference between the second image data stored in the storage unit and the fourth image data.

6. The biological information imaging method according to claim 3, wherein the first image data in two-dimensional space or three-dimensional space is obtained by single irradiation of the sample with the first light,

wherein the second image data in two-dimensional space or three-dimensional space is obtained by single irradiation of the sample with the second light,

wherein the third image data in two-dimensional space or three-dimensional space is obtained by single irradiation of the sample with the third light, and

wherein the fourth image data in two-dimensional space or three-dimensional space is obtained by single irradiation of the sample with the fourth light.

7. The biological information imaging method according to claim 2, wherein a blood pressure of the sample at the time point when the sample is irradiated with the first light and the third light is different from the blood pressure of the sample at the time point when the sample is irradiated with the second light and the fourth light.

8. The biological information imaging method according to claim 2, wherein the time point when the sample is irradiated with the first light and the third light is a time point when a blood pressure of the sample is a systolic blood pressure, and the time point when the sample is irradiated

with the second light and the fourth light is a time point when the blood pressure of the sample is a diastolic blood pressure.

9. The biological information imaging method according to claim 2, wherein a heart rate of the sample at the time point when the sample is irradiated with the first light and the third light is different from the heart rate of the sample at the time point when the sample is irradiated with the second light and the fourth light.

10. A biological information imaging apparatus comprising a light source, an optical controlling unit, an acoustic wave detector, and an information processing unit,

wherein said optical controlling unit is configured to control said light source to irradiate a sample with first light having a first wavelength, the first wavelength including a wavelength which is from 700 nm to 800 nm;

wherein said acoustic wave detector is configured to detect a first acoustic wave generated by irradiation of the sample with the first light and convert the first acoustic wave into a first electric signal,

wherein said information processing unit is configured to obtain first image data based on the first electric signal, wherein said optical controlling unit is configured to control said light source to irradiate the sample with second light having a second wavelength, the second wavelength including a wavelength which is from 800 nm to 1000 nm;

wherein said acoustic wave detector is configured to detect a second acoustic wave generated by irradiation of the sample with the second light and convert the second acoustic wave into a second electric signal,

wherein said information processing unit is configured to obtain second image data based on the second electric signal,

wherein said optical controlling unit is configured to control said light source to irradiate the sample with third light having the first wavelength at a time point different from a time point when the sample is irradiated with the first light,

wherein said acoustic wave detector is configured to detect a third acoustic wave generated by irradiation of the sample with the third light and convert the third acoustic wave into a third electric signal,

wherein said information processing unit is configured to obtain third image data based on the third electric signal,

wherein said optical controlling unit is configured to control said light source to irradiate the sample with fourth light having the second wavelength at a time point different from a time point when the sample is irradiated with the second light,

wherein said acoustic wave detector is configured to detect a fourth acoustic wave generated by irradiation of the sample with the fourth light and convert the fourth acoustic wave into a fourth electric signal,

wherein said information processing unit is configured to obtain fourth image data based on the fourth electric signal,

wherein said information processing unit is configured to perform registration between the first image data and the third image data, and

wherein said information processing unit is configured to obtain difference image data by calculating a difference

between the second image data and the fourth image data which are in positions registered between the first image data and the third image data.

11. The biological information imaging apparatus according to claim 10, wherein said light source is a laser or a light emitting diode.

12. The biological information imaging apparatus according to claim 10, wherein said acoustic wave detector includes a transducer using a piezo-electric phenomenon, a transducer using the resonance of light, or a transducer using a change of capacitance.

13. The biological information imaging apparatus according to claim 10, wherein said information processing unit is configured to obtain the first, second, third and fourth image data in two-dimensional space or three-dimensional space.

14. The biological information imaging apparatus according to claim 10, wherein said information processing unit is configured to perform the registration between the first image data and the third image data in such a manner that a venous image in the first image data and a venous image in the third image data are in register with each other.

15. The biological information imaging apparatus according to claim 10, further comprising a storage unit configured to store the second image data, wherein said information processing unit is configured to obtain the difference image data by calculating the difference between the second image data stored in the storage unit and the fourth image data.

16. The biological information imaging apparatus according to claim 10, wherein said information processing unit is configured to:

obtain the first image data in two-dimensional space or three-dimensional space based on the first electric signal obtained by single irradiation of the sample with the first light,

obtain the second image data in two-dimensional space or three-dimensional space based on the second electric signal obtained by single irradiation of the sample with the second light,

obtain the third image data in two-dimensional space or three-dimensional space based on the third electric signal obtained by single irradiation of the sample with the third light, and

obtain the fourth image data in two-dimensional space or three-dimensional space based on the fourth electric signal obtained by single irradiation of the sample with the fourth light.

17. The biological information imaging apparatus according to claim 10, wherein a blood pressure of the sample at the time point when the sample is irradiated with the first light and the third light is different from the blood pressure of the sample at the time point when the sample is irradiated with the second light and the fourth light.

18. The biological information imaging apparatus according to claim 10, wherein the time point when the sample is irradiated with the first light and the third light is a time point when a blood pressure of the sample is a systolic blood pressure, and the time point when the sample is irradiated with the second light and the fourth light is a time point when the blood pressure of the sample is a diastolic blood pressure.

19. The biological information imaging apparatus according to claim 10, wherein a heart rate of the sample at the time point when the sample is irradiated with the first light and the third light is different from the heart rate of the sample

at the time point when the sample is irradiated with the second light and the fourth light.

20. An information processing apparatus for processing image data obtained by a biological information imaging apparatus including a light source, an optical controlling unit, and an acoustic wave detector, wherein the information processing apparatus is configured to:

obtain first image data based on a first acoustic wave generated by irradiating a sample with first light having a first wavelength, the first wavelength including a wavelength which is from 700 nm to 800 nm;

obtain second image data based on a second acoustic wave generated by irradiating the sample with second light having a second wavelength different from the first wavelength, the second wavelength including a wavelength which is from 800 nm to 1000 nm;

obtain third image data based on a third acoustic wave generated by irradiating the sample with third light having the first wavelength a time point different from a time point when the sample is irradiated with the first light;

obtain fourth image data based on a fourth acoustic wave generated by irradiating the sample with fourth light having the second wavelength a time point different from a time point when the sample is irradiated with the second light;

perform registration between the first image data and the third image data; and

obtain difference image data by calculating a difference between the second image data and the fourth image data which are in positions registered between the first image data and the third image data.

21. The information processing apparatus according to claim 20, wherein the information processing apparatus is configured to obtain the first, second, third and fourth image data in two-dimensional space or three-dimensional space.

22. The information processing apparatus according to claim 20, wherein the information processing apparatus is configured to perform the registration between the first image data and the third image data in such a manner that a venous image in the first image data and a venous image in the third image data are in register with each other.

23. The information processing apparatus according to claim 20, wherein the information processing apparatus is configured to:

obtain the first image data in two-dimensional space or three-dimensional space based on the first electric signal obtained by single irradiation of the sample with the first light,

obtain the second image data in two-dimensional space or three-dimensional space based on the second electric signal obtained by single irradiation of the sample with the second light,

obtain the third image data in two-dimensional space or three-dimensional space based on the third electric signal obtained by single irradiation of the sample with the third light, and

obtain the fourth image data in two-dimensional space or three-dimensional space based on the fourth electric signal obtained by single irradiation of the sample with the fourth light.

24. The information processing apparatus according to claim 20, wherein a blood pressure of the sample at the time point when the sample is irradiated with the first light and

the third light is different from the blood pressure of the sample at the time point when the sample is irradiated with the second light and the fourth light.

25. The information processing apparatus according to claim 20, wherein the time point when the sample is irradiated with the first light and the third light is a time point when a blood pressure of the sample is a systolic blood pressure, and the time point when the sample is irradiated with the second light and the fourth light is a time point when the blood pressure of the sample is a diastolic blood pressure.

26. The information processing apparatus according to claim 20, wherein a heart rate of the sample at the time point when the sample is irradiated with the first light and the third light is different from the heart rate of the sample at the time point when the sample is irradiated with the second light and the fourth light.

* * * * *

专利名称(译)	生物信息成像设备和生物信息成像方法		
公开(公告)号	US20180192883A1	公开(公告)日	2018-07-12
申请号	US15/912849	申请日	2018-03-06
[标]申请(专利权)人(译)	佳能株式会社		
申请(专利权)人(译)	佳能株式会社		
当前申请(专利权)人(译)	佳能株式会社		
[标]发明人	ASAO YASUFUMI FUKUTANI KAZUHIKO		
发明人	ASAO, YASUFUMI FUKUTANI, KAZUHIKO		
IPC分类号	A61B5/00 A61B5/024 A61B5/021		
CPC分类号	A61B5/742 A61B5/7253 A61B5/024 A61B5/0073 A61B5/7257 A61B5/0095 A61B5/02133		
优先权	2008211993 2008-08-20 JP		
外部链接	Espacenet USPTO		

摘要(译)

生物信息成像方法包括第一测量步骤，以测量由活体 (53) 产生的声波 (54) 51) 从光源 (50) 照射并被生物体内的组织 (52) 吸收，存储步骤以存储在生物体中获得的第一信息。第一测量步骤，第二测量步骤，用于测量由活体 (53) 产生的声波 (54) 51) 从光源照射 (50) 并被生物体内的组织 (52) 吸收，并产生处理步骤，以生成信息的图像。通过使用在第二测量步骤中获得的第二信息和存储在存储步骤中的第一信息来生物体中的组织。

