



US 20150119654A1

(19) **United States**
(12) **Patent Application Publication**
MARTIN et al.

(10) **Pub. No.: US 2015/0119654 A1**
(43) **Pub. Date: Apr. 30, 2015**

(54) **SYSTEM AND METHOD FOR OBTAINING BODILY FUNCTION MEASUREMENTS USING A MOBILE DEVICE**

A61B 5/02 (2006.01)
A61B 5/00 (2006.01)

(52) **U.S. CI.**
CPC *A61B 5/021* (2013.01); *A61B 5/0059* (2013.01); *A61B 5/0402* (2013.01); *A61B 5/02028* (2013.01); *A61B 5/681* (2013.01); *A61B 5/6898* (2013.01); *A61B 5/742* (2013.01); *A61B 5/7278* (2013.01)

(71) Applicant: **QUALCOMM Incorporated**, San Diego, CA (US)

(72) Inventors: **Russel Allyn MARTIN**, Menlo Park, CA (US); **Leonid Sheynblat**, Hillsborough, CA (US); **Douglas Wayne Hoffman**, San Diego, CA (US)

(57) **ABSTRACT**

Methods, systems, computer-readable media, and apparatuses for obtaining at least one bodily function measurement are presented. A mobile device includes an outer body sized to be portable for user, a processor contained within the outer body, and a plurality of sensors physically coupled to the outer body. The sensors are configured to obtain a first measurement indicative of blood volume and a second measurement indicative of heart electrical activity in response to a user action. A blood pressure measurement is determined based on the first measurement and the second measurement. The sensors also include electrodes where a portion of a user's body positioned between the electrodes completes a circuit and a measurement to provide at least one measure of impedance associated with the user's body. A hydration level measurement is determined based on the measure of impedance.

(21) Appl. No.: **14/523,588**

(22) Filed: **Oct. 24, 2014**

Related U.S. Application Data

(63) Continuation-in-part of application No. 14/278,062, filed on May 15, 2014.

(60) Provisional application No. 61/895,995, filed on Oct. 25, 2013.

Publication Classification

(51) **Int. Cl.**
A61B 5/021 (2006.01)
A61B 5/0402 (2006.01)

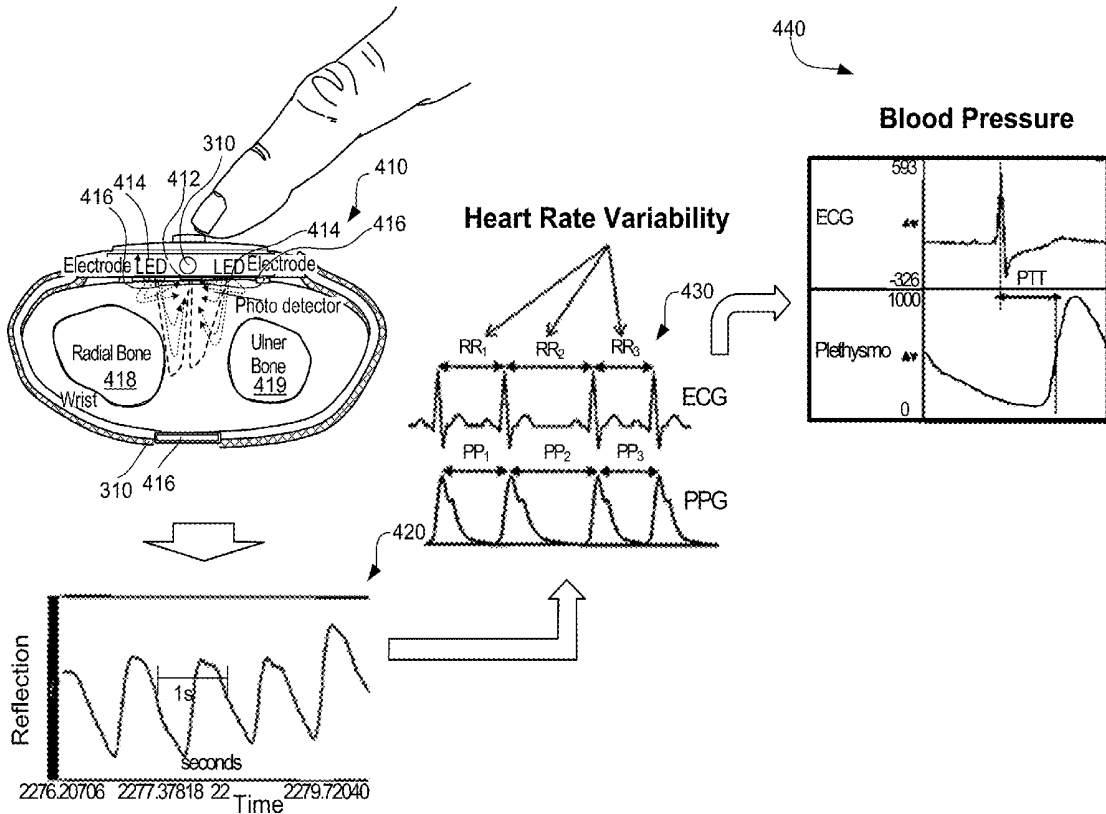

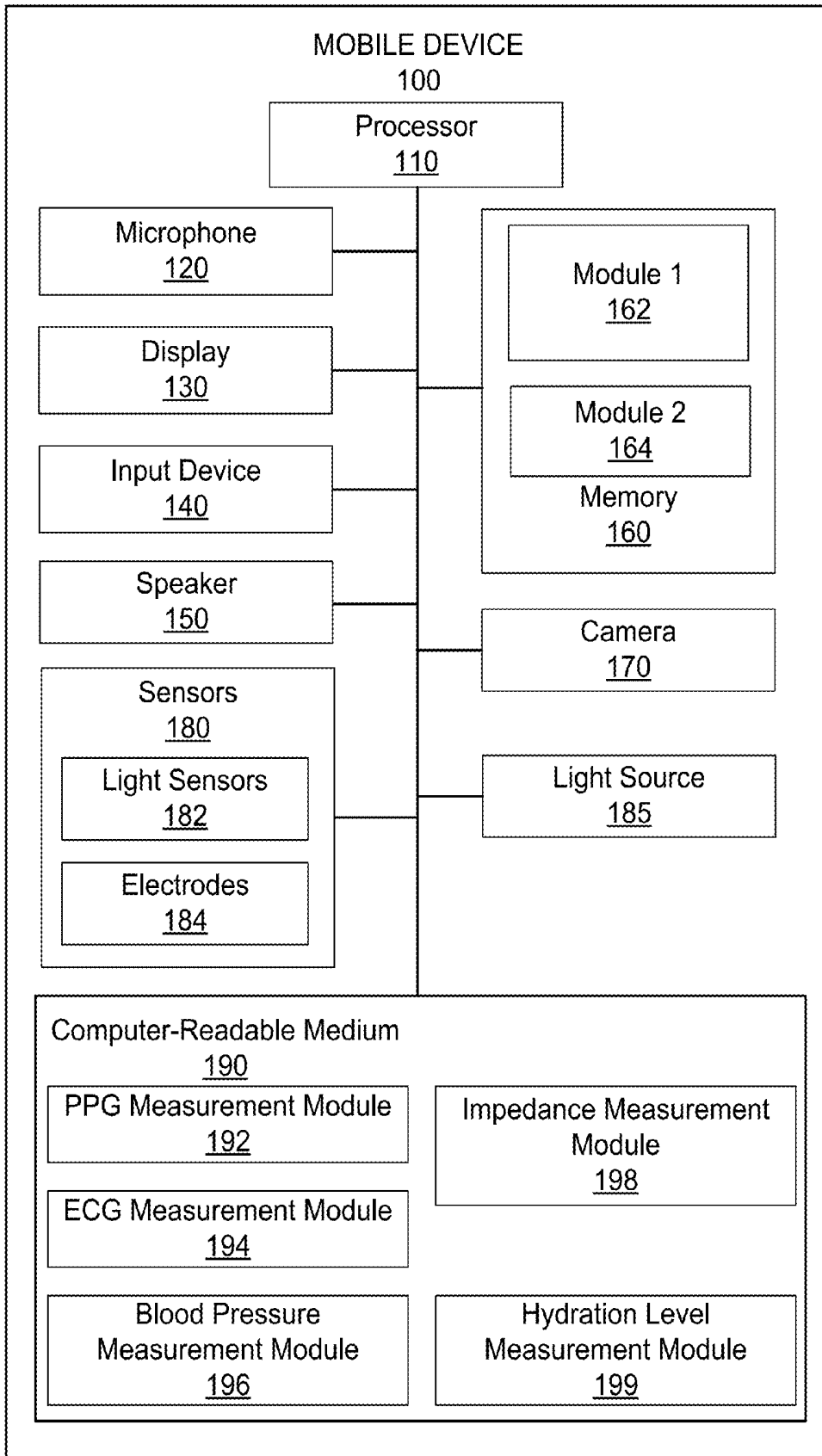

FIG. 1

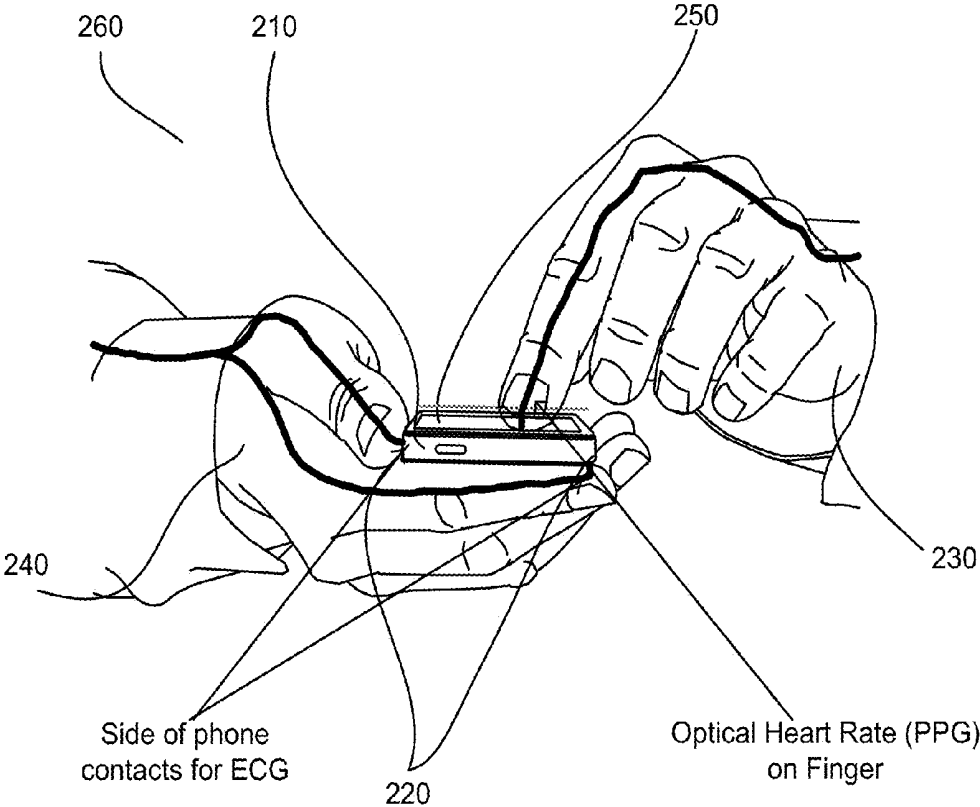

FIG. 2

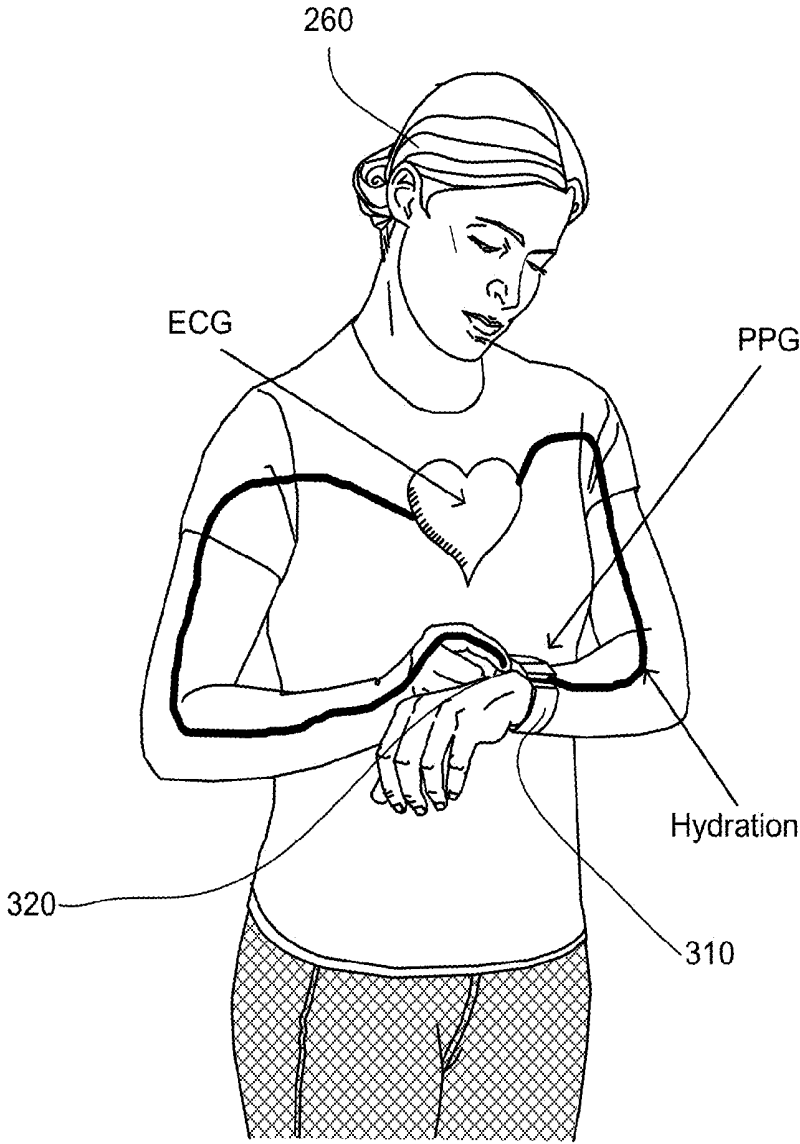

FIG. 3

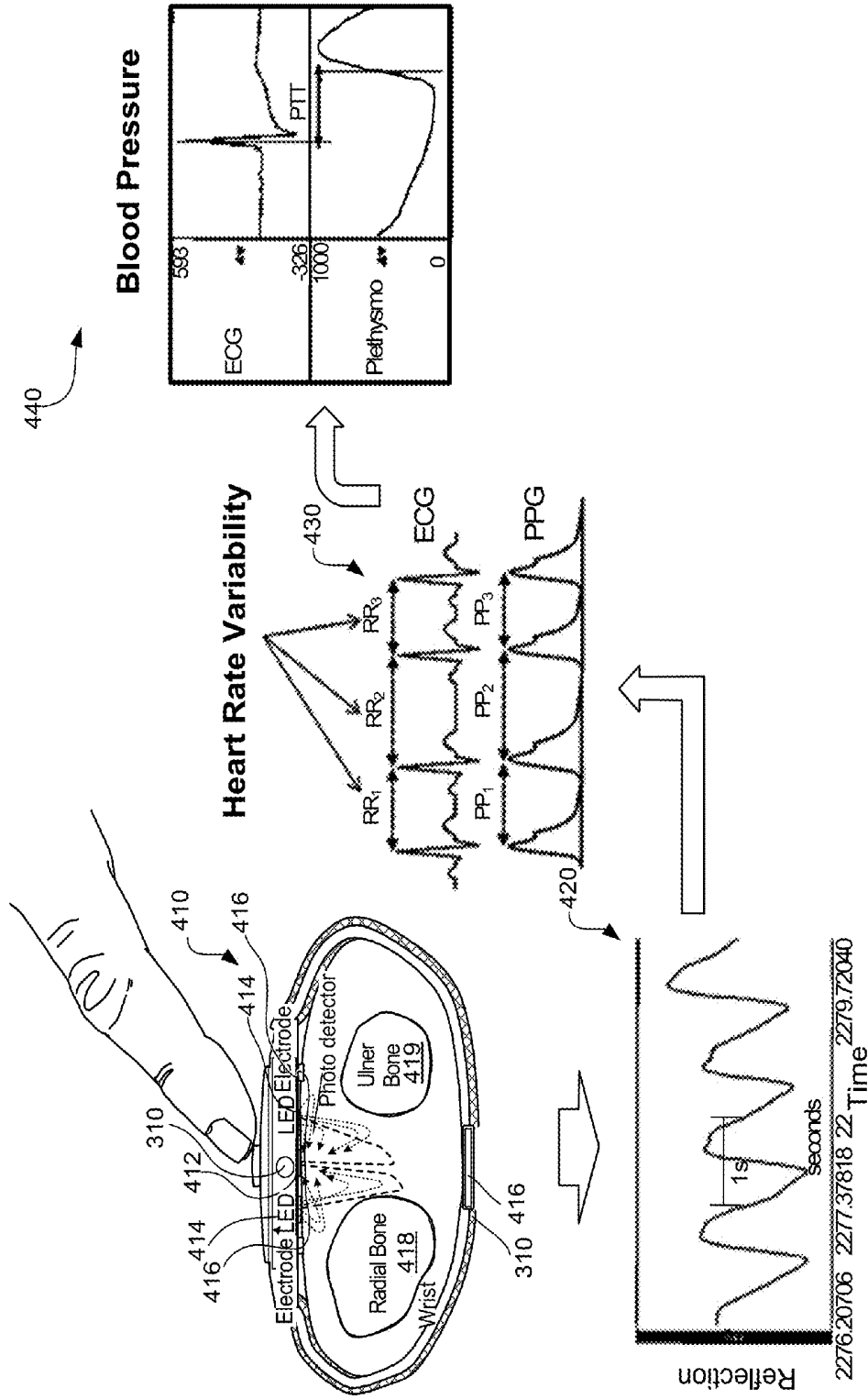

FIG. 4A

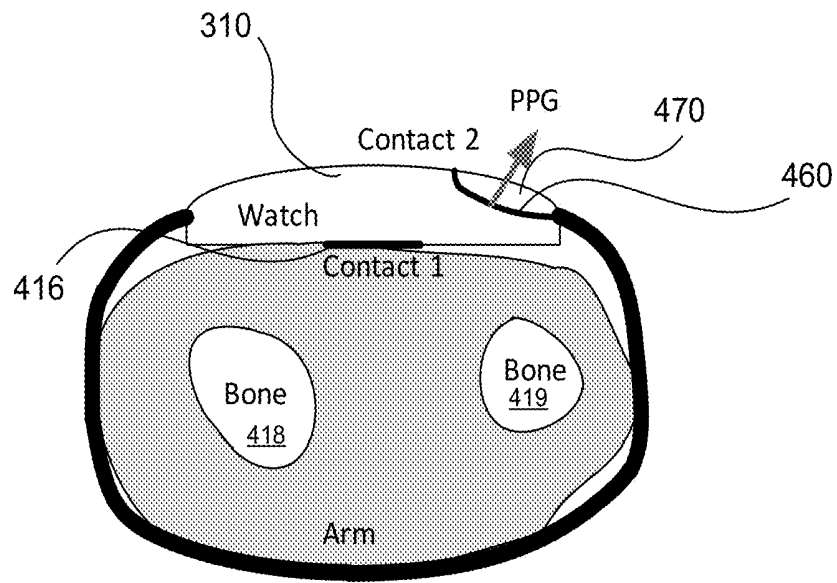

FIG. 4B

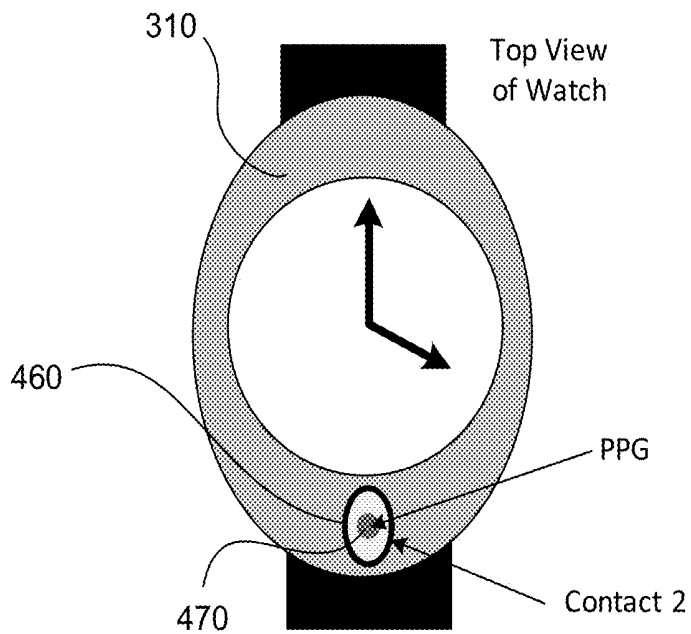

FIG. 4C

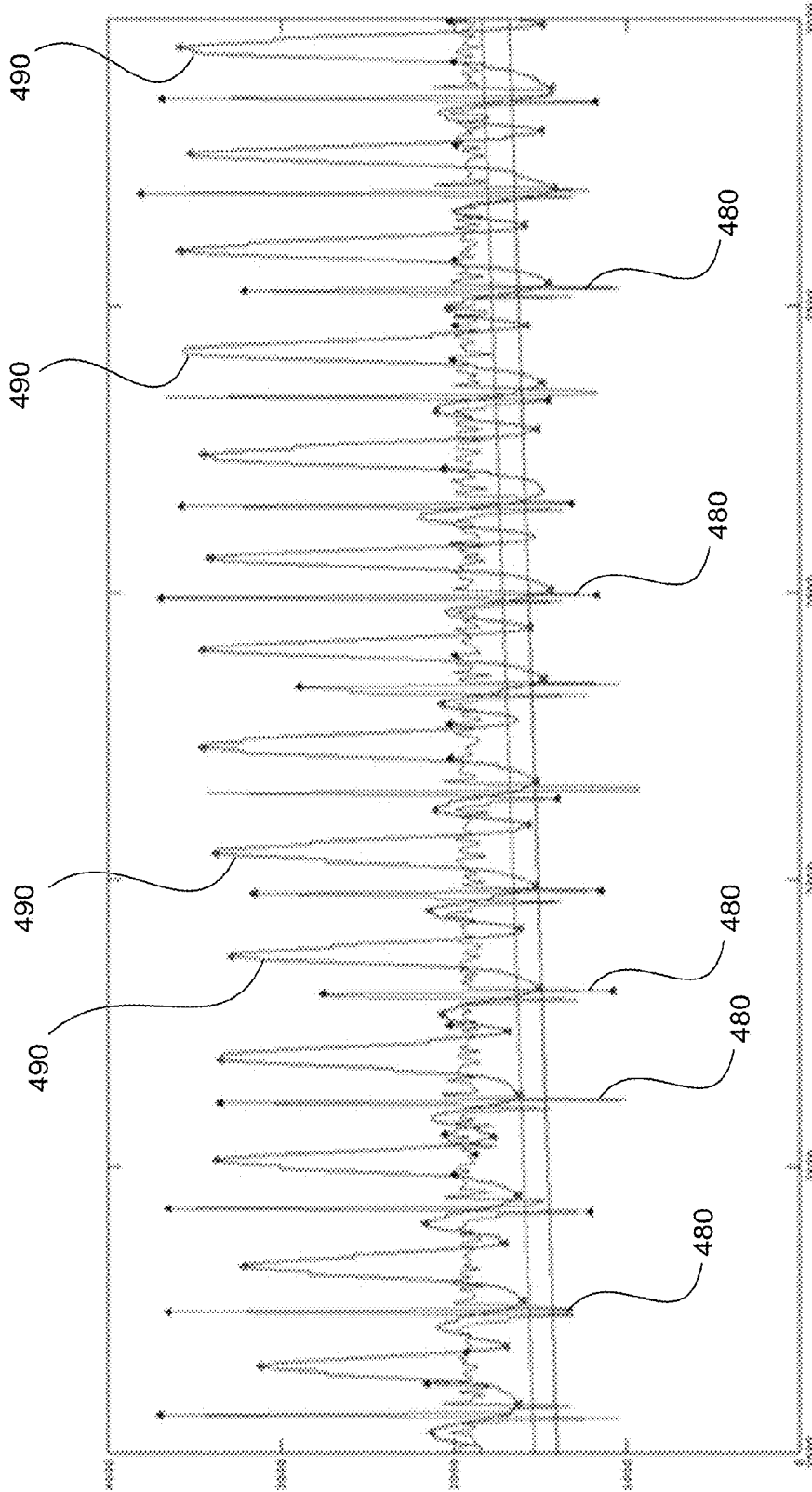

FIG. 4D

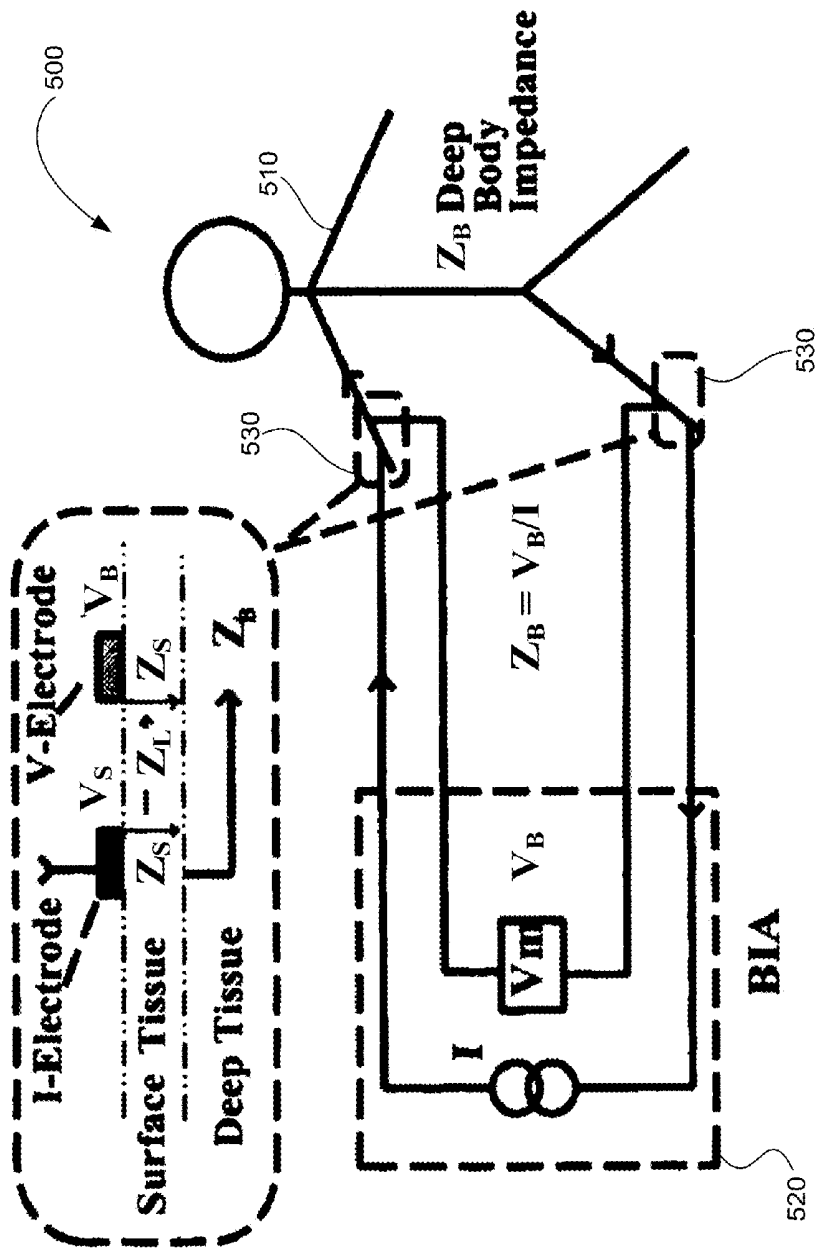

FIG. 5

Fricke's circuit

Two parallel electrical conductors:

$R_{(ECW)}$: H_2O-Na

$R_{(ICW)}$: H_2O-K

isolated by a cell membrane (X_c)

600

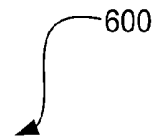
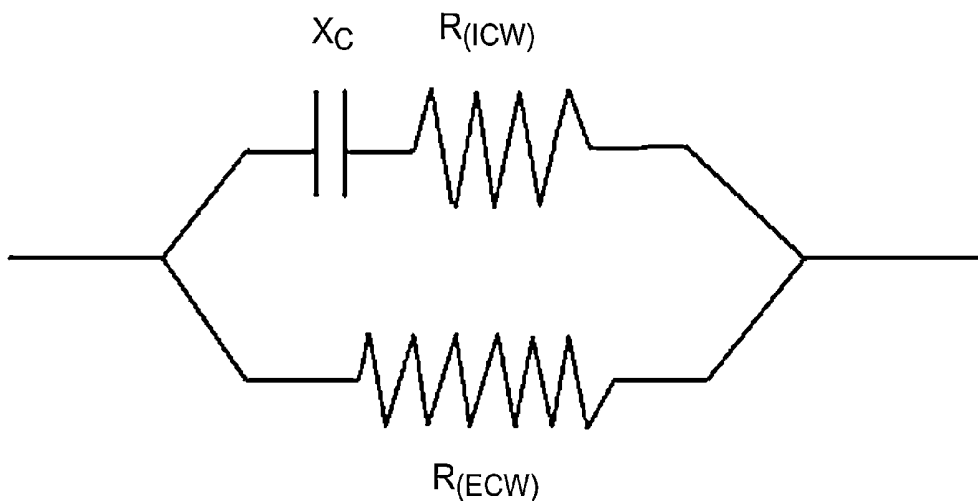



FIG. 6

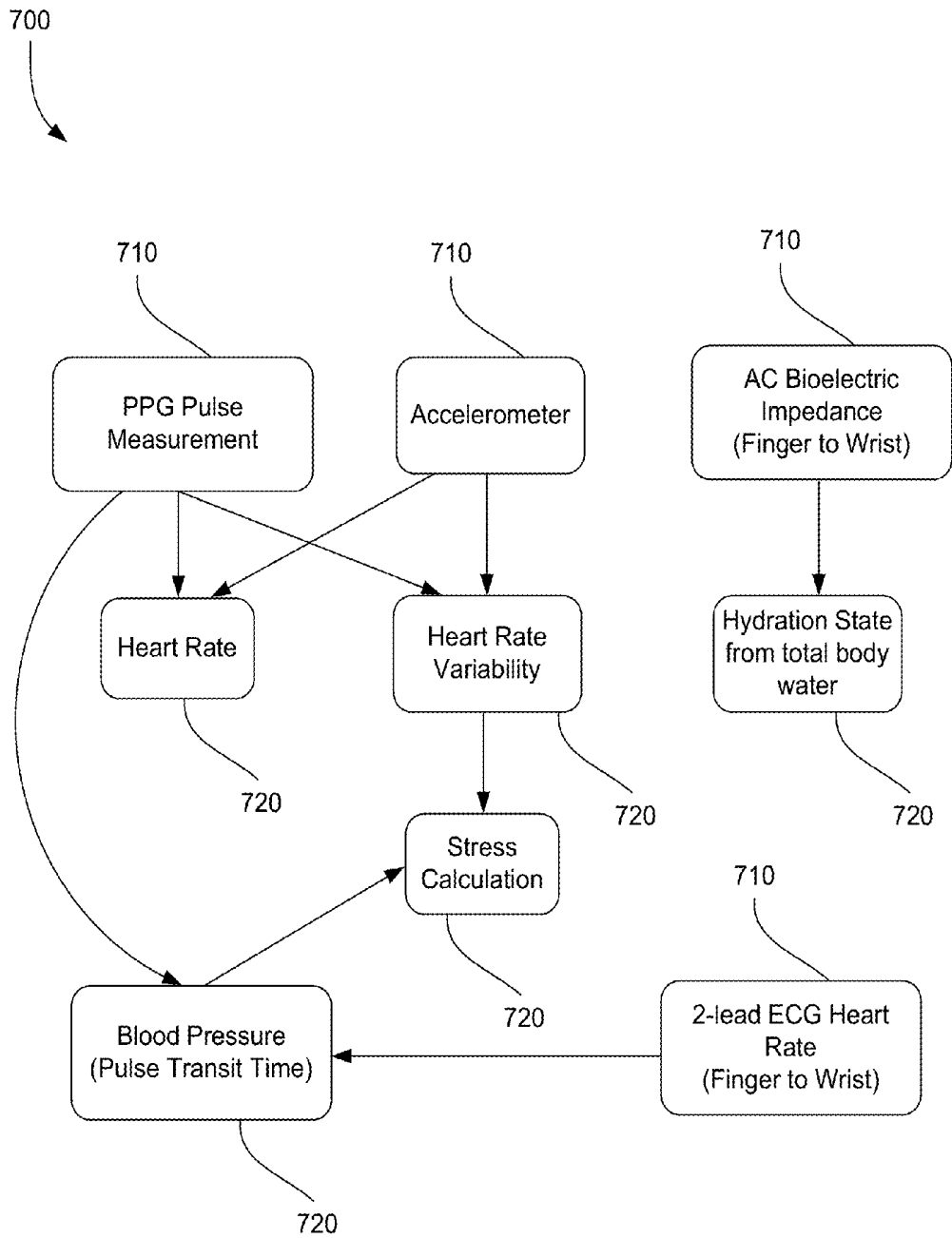

FIG. 7

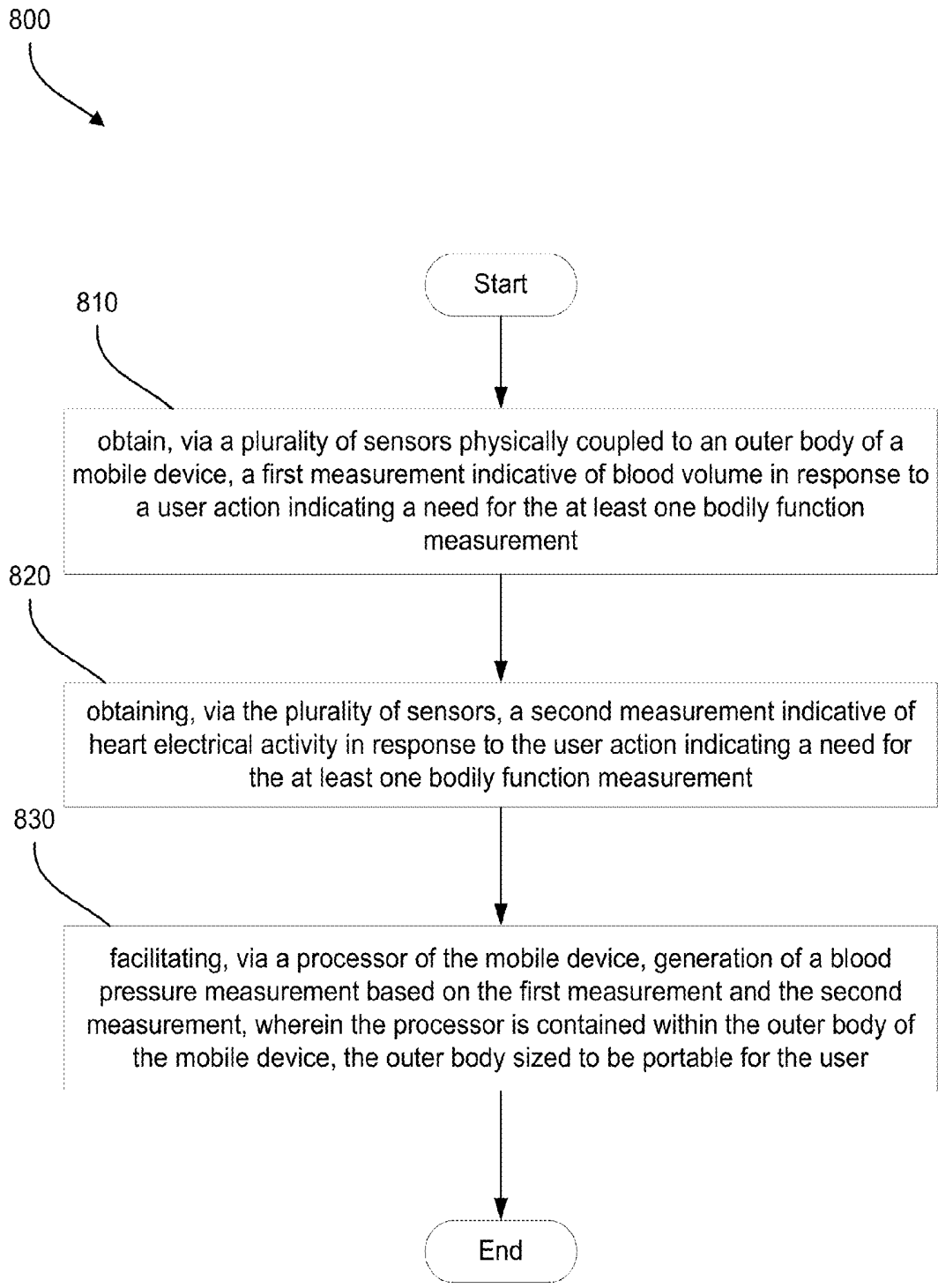

FIG. 8

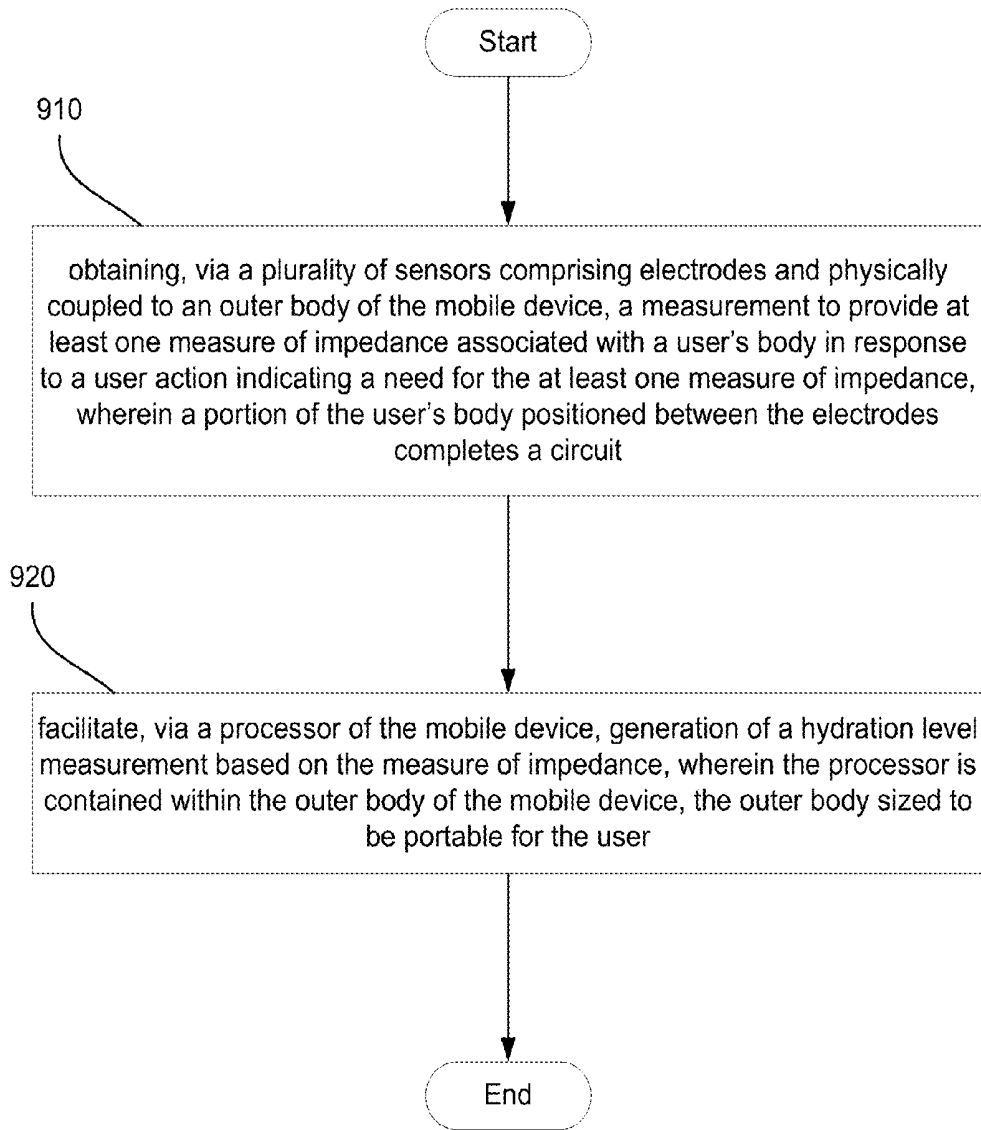

FIG. 9

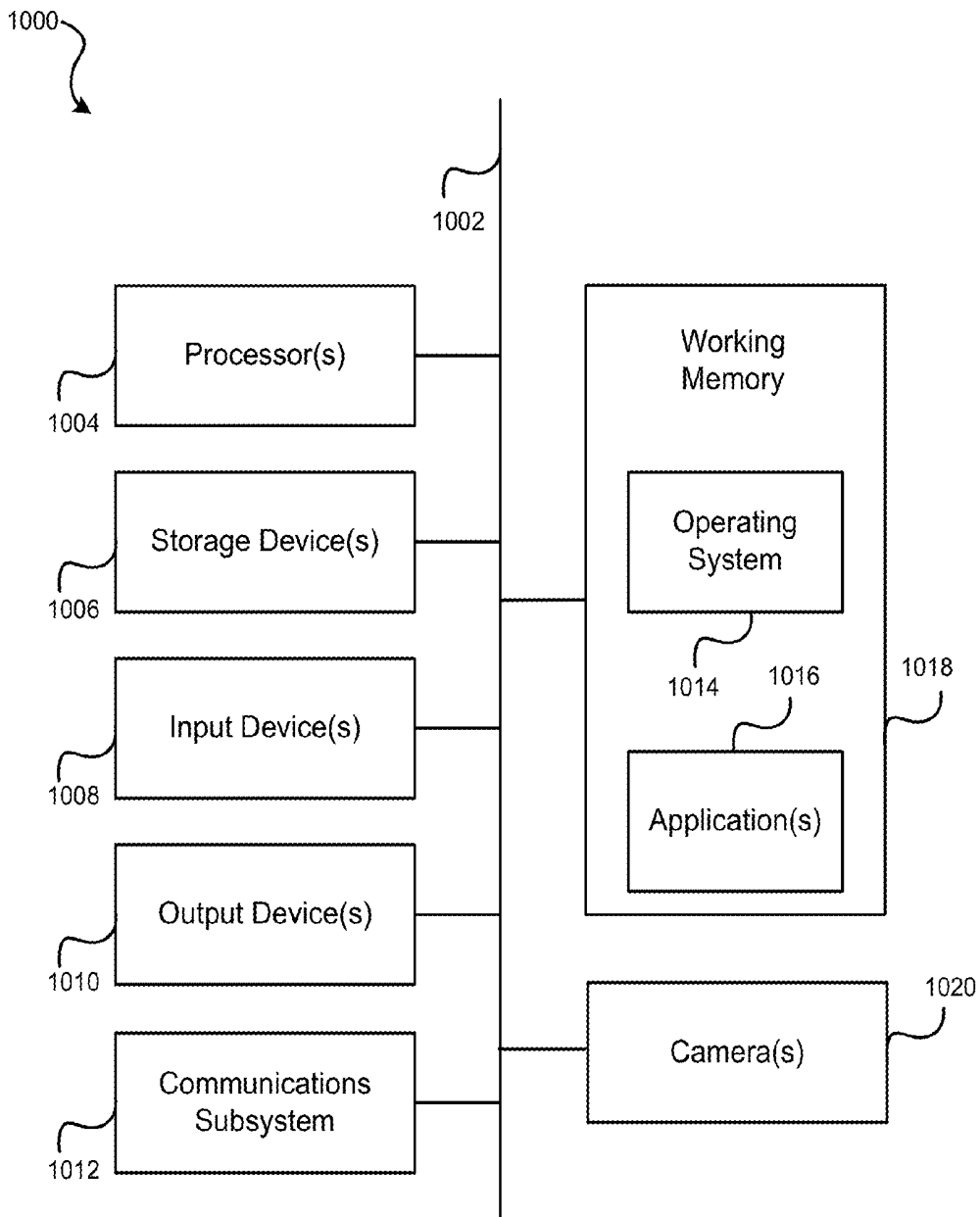

FIG. 10

**SYSTEM AND METHOD FOR OBTAINING
BODILY FUNCTION MEASUREMENTS
USING A MOBILE DEVICE**

CROSS-REFERENCE TO RELATED
APPLICATIONS

[0001] This application is a continuation-in-part of U.S. Non-Provisional application Ser. No. 14/278,062, filed May 15, 2014, entitled "SYSTEM AND METHOD FOR OBTAINING BODILY FUNCTION MEASUREMENTS USING A MOBILE DEVICE", which claims the benefit of U.S. Provisional Application No. 61/895,995, filed Oct. 25, 2013, entitled "SYSTEM AND METHOD FOR OBTAINING BODILY FUNCTION MEASUREMENTS USING A MOBILE DEVICE", which are incorporated herein by reference.

BACKGROUND

[0002] Aspects of the disclosure relate to mobile devices, and more particularly, a system and method for obtaining at least one bodily function measurement of a user operating a mobile device.

[0003] It is often desirable for a user to be aware his/her bodily function measurements, which may provide physiological measures of stress, measures of hydration, and other measures of general health. Physiological measures of stress may be used to communicate to a user instructions to alter his/her behavior, e.g., taking a break, taking deep breaths, etc. Measures of hydration may be used by athletes or generally active individuals to ensure that they stay hydrated to maintain physical performance. Additionally, this information may be useful for individuals who work in hot or dry environments and must maintain proper hydration. Further, this information may be useful for elderly individuals whose sense of hydration is decreased and are more prone to becoming dehydrated. Thus, important bodily function measurements may include measurements of a user's blood pressure and/or hydration state.

[0004] A user's blood pressure may be measured using a pulse-measuring device. Typical pulse-measuring devices use either photoplethysmography (PPG) or electrocardiography (ECG) to measure a user's pulse. A user's systolic blood pressure or diastolic blood pressure may be determined using a combination of the PPG and ECG using a technique known as pulse transit time (PTT). The systolic blood pressure, along with other inputs such as pulse rate variability (PRV) and galvanic skin response (GSR) may be useful in determining the user's physiological measures of stress. However, existing mobile device solutions for obtaining PPG measurements and ECG measurements can only obtain measurements for one or the other. That is, existing mobile device solutions can only obtain a PPG measurement or an ECG measurement, but not both.

[0005] A user's hydration state may be determined by measuring a total body water amount using a bioelectric impedance analysis (BIA). BIA measurements are typically accurate and may fall within 200 ml of the actual value when performed properly. Typically, existing solutions to measure BIA require professional equipment in a clinical setting. Additionally, the few devices that exist to measure BIA outside of a clinical setting are not very mobile, e.g., they may not fit within a user's pocket or be integrated into another device that the user typically always has with them.

[0006] Accordingly, a need exists for a mobile solution to obtain both PPG and ECG measurements used for determining a user's blood pressure and to obtain a body water content measurement used for determining a user's hydration state.

BRIEF SUMMARY

[0007] Certain embodiments are described that for obtaining at least one bodily function measurement of a user operating a mobile device.

[0008] In some embodiments, a mobile device for obtaining at least one bodily function measurement comprises an outer body sized to be portable for a user, a processor contained within the outer body, and a plurality of sensors physically coupled to the outer body for obtaining data accessible by the processor. One or more sensors of the sensors is configured to obtain a first measurement indicative of blood volume in response to a user action, wherein at least one of the sensors configured to obtain the first measurement is contained within a contact button coupled to the outer body. One or more of the sensors is configured to obtain a second measurement indicative of heart electrical activity in response to the user action. The processor is configured to facilitate generation of a blood pressure measurement based on the first measurement and the second measurement.

[0009] In some embodiments, the mobile device is configured to perform a primary function and a secondary function, and wherein the processor is configured to facilitate generation of the blood pressure measurement as the secondary function of the mobile device.

[0010] In some embodiments, the first measurement indicative of blood volume comprises a photoplethysmography (PPG) measurement.

[0011] In some embodiments, the second measurement indicative of heart electrical activity comprises an electrocardiography (ECG) measurement.

[0012] In some embodiments, the one or more of the sensors is configured to obtain the first measurement comprises at least one light sensor, and wherein the mobile device further comprises at least one light source and the at least one light sensor measures reflected light from the light source reflected off of blood vessels within a user of the mobile device to obtain the first measurement.

[0013] In some embodiments, the at least one light sensor includes an infrared (IR) light emitting diode (LED).

[0014] In some embodiments, the one or more of the sensors is configured to obtain the second measurement indicative of heart electrical activity comprises at least a first electrode and a second electrode, and wherein a portion of a user of the mobile device's body completes a circuit between the first electrode and the second electrode.

[0015] In some embodiments, the mobile device is a watch.

[0016] In some embodiments, the mobile device is a smartphone device.

[0017] In some embodiments, method for obtaining at least one bodily function measurement via a mobile device comprises obtaining, via a plurality of sensors physically coupled to an outer body of the mobile device, a first measurement indicative of blood volume in response to a user action, wherein at least one of the sensors is contained within a contact button coupled to the outer body. The method further comprises obtaining, via the plurality of sensors, a second measurement indicative of heart electrical activity in response to the user action. The method also comprises facilitating, via a processor of the mobile device, generation of a

blood pressure measurement based on the first measurement and the second measurement, wherein the processor is contained within the outer body of the mobile device, the outer body sized to be portable for the user.

[0018] In some embodiments, an apparatus for obtaining at least one bodily function measurement comprises means for obtaining, via a plurality of sensors physically coupled to an outer body of a mobile device, a first measurement indicative of blood volume in response to a user action, wherein at least one of the sensors is contained within a contact button coupled to the outer body. The method further comprises means for obtaining, via the plurality of sensors, a second measurement indicative of heart electrical activity in response to the user action. The method also comprises means for facilitating, via a processor of the mobile device, generation of a blood pressure measurement based on the first measurement and the second measurement, wherein the processor is contained within the outer body of the mobile device, the outer body sized to be portable for the user.

[0019] In some embodiments, one or more non-transitory computer-readable media storing computer-executable instructions for obtaining at least one bodily function measurement that, when executed, cause one or more computing devices included in a mobile device to obtain, via a plurality of sensors physically coupled to an outer body of the mobile device, a first measurement indicative of blood volume in response to a user action, wherein at least one of the sensors is contained within a contact button coupled to the outer body. The computer-executable instructions, when executed, further cause the one or more computing devices included in a device to obtain, via the plurality of sensors, a second measurement indicative of heart electrical activity in response to the user action. The computer-executable instructions, when executed, further cause the one or more computing devices included in a device to facilitate, via a processor of the mobile device, generation of a blood pressure measurement based on the first measurement and the second measurement, wherein the processor is contained within the outer body of the mobile device, the outer body sized to be portable for the user.

[0020] In some embodiments, a mobile device for obtaining at least one bodily function measurement comprises an outer body sized to be portable for a user, a processor contained within the outer body, and a plurality of sensors physically coupled to the outer body for obtaining data accessible by the processor. The plurality of sensors comprises electrodes and a portion of a user's body positioned between the electrodes completes a circuit and a measurement to provide at least one measure of impedance associated with the user's body in response to a user action. The processor is configured to facilitate generation of a hydration level measurement based on the measure of impedance.

[0021] In some embodiments, the mobile device is configured to perform a primary function and a secondary function, and wherein the processor is configured to facilitate generation of the hydration level measurement as the secondary function of the mobile device.

[0022] In some embodiments, at least one of the sensors is built into a multifunction surface, wherein the multifunction surface is configured to simultaneously obtain the impedance measurement and a user input.

[0023] In some embodiments, the multifunction surface comprises silver metal.

[0024] In some embodiments, the multifunction surface comprises Indium Tin Oxide (ITO).

[0025] In some embodiments, the mobile device is a watch.

[0026] In some embodiments, the mobile device is a smartphone device.

[0027] In some embodiments, a method for obtaining at least one bodily function measurement via a mobile device comprises obtaining, via a plurality of sensors comprising electrodes and physically coupled to an outer body of the mobile device, a measurement to provide at least one measure of impedance associated with a user's body in response to a user action, wherein a portion of the user's body positioned between the electrodes completes a circuit. The method also comprises facilitating, via a processor of the mobile device, generation of a hydration level measurement based on the measure of impedance, wherein the processor is contained within the outer body of the mobile device, the outer body sized to be portable for the user.

[0028] In some embodiments, an apparatus for obtaining at least one bodily function measurement via a mobile device comprises means for obtaining, via a plurality of sensors comprising electrodes and physically coupled to an outer body of the mobile device, a measurement to provide at least one measure of impedance associated with a user's body in response to a user action, wherein a portion of the user's body positioned between the electrodes completes a circuit. The apparatus further comprises means for facilitating, via a processor of the mobile device, generation of a hydration level measurement based on the measure of impedance, wherein the processor is contained within the outer body of the mobile device, the outer body sized to be portable for the user.

[0029] In some embodiments, one or more non-transitory computer-readable media storing computer-executable instructions for obtaining at least one bodily function measurement that, when executed, cause one or more computing devices included in a mobile device to obtain, via a plurality of sensors comprising electrodes and physically coupled to an outer body of the mobile device, a measurement to provide at least one measure of impedance associated with a user's body in response to a user action, wherein a portion of the user's body positioned between the electrodes completes a circuit. The computer-executable instructions, when executed, further cause the one or more computing devices included in a device to facilitate, via a processor of the mobile device, generation of a hydration level measurement based on the measure of impedance, wherein the processor is contained within the outer body of the mobile device, the outer body sized to be portable for the user.

BRIEF DESCRIPTION OF THE DRAWINGS

[0030] Aspects of the disclosure are illustrated by way of example. In the accompanying figures, like reference numbers indicate similar elements, and:

[0031] FIG. 1 illustrates a mobile device configured to obtain PPG and ECG measurements of a user, according to some embodiments;

[0032] FIG. 2 illustrates a smartphone device configured to obtain PPG and ECG measurements of a user, according to some embodiments;

[0033] FIG. 3 illustrates a wristwatch device configured to obtain PPG, ECG, and impedance measurements of a user, according to some embodiments;

[0034] FIG. 4A illustrates a cross sectional view of the wristwatch device of FIG. 3 and graphs showing measurements obtained by the wristwatch device, according to some embodiments;

[0035] FIG. 4B illustrates a cross sectional view of the wristwatch device of FIG. 3. where the sensor for obtaining the PPG measurement is contained within a contact button of the wristwatch device, according to some embodiments;

[0036] FIG. 4C illustrates a top view of the wristwatch device of FIG. 3 where the sensor for obtaining the PPG measurement is contained within a contact button of the wristwatch device, according to some embodiments;

[0037] FIG. 4D illustrates a graph comparing heart activity measurements between contact button contained PPG sensor and a wrist based PPG sensor, according to some embodiments;

[0038] FIG. 5 a schematic diagram illustrating a method of obtaining impedance measurements of a user, according to some embodiments;

[0039] FIG. 6 is a schematic diagram of two resistors and a capacitor representing conduction through tissue, according to some embodiments;

[0040] FIG. 7 is a flow diagram illustrating a plurality of derived metrics from a plurality of sensor metrics, according to some embodiments;

[0041] FIG. 8 is a flow diagram of an exemplary method of obtaining at least one bodily function measurement;

[0042] FIG. 9 is another flow diagram of an exemplary method of obtaining at least one bodily function measurement; and

[0043] FIG. 10 illustrates an example of a computing system in which one or more embodiments may be implemented.

DETAILED DESCRIPTION

[0044] Several illustrative embodiments will now be described with respect to the accompanying drawings, which form a part hereof. While particular embodiments, in which one or more aspects of the disclosure may be implemented, are described below, other embodiments may be used and various modifications may be made without departing from the scope of the disclosure or the spirit of the appended claims.

[0045] FIG. 1 illustrates a simplified block diagram of a mobile device 100 that may incorporate one or more embodiments. Mobile device 100 includes a processor 110, microphone 120, display 130, input device 140, speaker 150, memory 160, camera 170, sensors 180, light source 185, and computer-readable medium 190.

[0046] Processor 110 may be any general-purpose processor operable to carry out instructions on the mobile device 100. The processor 110 is coupled to other units of the mobile device 100 including microphone 120, display 130, input device 140, speaker 150, memory 160, camera 170, sensors 180, light source 185, and computer-readable medium 190.

[0047] Microphone 120 may be any an acoustic-to-electric transducer or sensor that converts sound into an electrical signal. The microphone 120 may provide functionality for a user of the mobile device 100 to record audio or issue voice commands for the mobile device 100.

[0048] Display 130 may be any device that displays information to a user. Examples may include an LCD screen, CRT monitor, or seven-segment display.

[0049] Input device 140 may be any device that accepts input from a user. Examples may include a keyboard, keypad, or mouse. In some embodiments, the microphone 120 may also function as an input device 140.

[0050] Speaker 150 may be any device that outputs sound to a user. Examples may include a built-in speaker or any

other device that produces sound in response to an electrical audio signal and/or ultrasonic signal(s).

[0051] Memory 160 may be any magnetic, electronic, or optical memory. Memory 160 includes two memory modules, module 1 162 and module 2 164. It can be appreciated that memory 160 may include any number of memory modules. An example of memory 160 may be dynamic random access memory (DRAM).

[0052] Camera 170 is configured to capture one or more images via a lens located on the body of mobile device 100. The captured images may be still images or video images. The camera 170 may include a CMOS image sensor to capture the images. Various applications running on processor 110 may have access to camera 170 to capture images. It can be appreciated that camera 170 can continuously capture images without the images actually being stored within the mobile device 100. Captured images may also be referred to as image frames.

[0053] Sensors 180 may be a plurality of sensors configured to obtain data accessible by the processor. The sensors 180 may also be physically coupled to the outer body of the mobile device 100. The plurality of sensors 180 may include one or more light sensors 182 and/or one or more electrodes 184. The light sensors 182 may be configured to facilitate measurement of reflected light from the light source 185 (described below) reflected off of blood vessels within a user of the mobile device 100 to obtain the a PPG measurement indicative of the user's blood volume. A portion of a user of the mobile device's 100 body may complete a circuit between a first electrode and a second electrode, e.g., when the user touches both electrodes 184. The electrodes 184 may be configured to facilitate measurement of heart electrical activity of the user to obtain an ECG measurement. The electrodes 184 may also be configured to facilitate measurement of impedance of the user of the mobile device 100 to obtain a level measurement.

[0054] Light source 185 may be any source of light configured to emit light through a user's body. In some embodiments, the light source 185 may be a LED light source. The emitted light may be of a wavelength that can pass through parts of a user's body. For example, the light source 185 may emit LED light through a user's wrist. In some embodiments, the mobile device 100 may include multiple light sources 185. The light emitted from light source 185 may reflect off of blood vessels within the user's body and the reflected light may be measured by one or more light sensors 182 to obtain a PPG measurement, as described above. It can be appreciated that emitted light may be of different wavelengths depending on different wavelengths. For example, different wavelengths of light may be appropriate to improve the signal, reduce noise, deal with dark skin colors, measure the blood's oxygen content, or penetrate to different depths of the user's body.

[0055] Computer-readable medium 190 may be any magnetic, electronic, optical, or other computer-readable storage medium. Computer-readable storage medium 190 includes PPG measurement module 192, ECG measurement module 194, blood pressure measurement module 196, impedance measurement module 198, and hydration level measurement module 199.

[0056] PPG measurement module 192 is configured to, when executed by processor 110, obtain a photoplethysmography (PPG) measurement. The PPG measurement may be a measurement of blood volume of a user operating the mobile

device **100**. The PPG measurement may be obtained by the PPG measurement module **192** in response to a user action. The PPG measurement module **192** may interface with the light source **185** and light sensors **182** in order to obtain the PPG measurement. Upon indication by the user of a need for a PPG measurement, the PPG measurement module **192** may direct the light source **185**, or multiple light sources, to emit light through the user's body. As described above, the emitted light may reflect off or transmitted through blood vessels within the user's body and may be detected by one or more light sensors **182** within the mobile device **100**. The PPG measurement module **192** may measure, by interfacing with the one or more light sensors, the amount of reflected or transmitted light detected by the one or more light sensors **182**. The PPG measurement module **192** may then determine a PPG measurement that is indicative of the user's blood volume based on the measurement of the reflected light.

[0057] ECG measurement module **194** is configured to, when executed by processor **110**, obtain an electrocardiography (ECG) measurement. The ECG measurement may be a measurement of heart electrical activity of a user operating the mobile device **100**. The ECG measurement may be obtained by the ECG measurement module **194** in response to a user action. The ECG measurement module **194** may interface with the electrodes **184** in order to obtain the ECG measurement. Upon indication by the user of a need for an ECG measurement, the ECG measurement module **194** may interface with the electrodes **184** to measure (assuming the user's body completes a circuit between the electrodes **184**) electrical impulse(s) generated by the polarization and depolarization of cardiac tissue within the user's body. In some embodiments, the electrical impulse(s) may be generated by the beating of the user's heart. In some embodiments, the ECG measurement module **194** may interface with the electrodes **184** to measure the electrical impulse(s) automatically upon the user's body completing a circuit between the electrodes **184**. The ECG measurement module **194** may then determine an ECG measurement based on the measured electrical impulse(s). It can be appreciated that ECG measurement can be obtained using two or more electrode leads.

[0058] Blood pressure measurement module **196** is configured to, when executed by processor **110**, generate a blood pressure measurement of the user based on the PPG measurement and the ECG measurement. According to Poon, C. C. Y.; Zhang, Y. T. "Cuff-less and Noninvasive Measurements of Arterial Blood Pressure by Pulse Transit Time", *Engineering in Medicine and Biology 27th Annual Conference*, 2005. *IEEE*, On page(s): 1-4, the calculation of the blood pressure measurement based on the PPG measurement and the ECG measurement is well known in the art.

[0059] Impedance measurement module **198** is configured to, when executed by processor **110**, obtain an impedance measurement. The impedance measurement may be indicative of a hydration level of a user operating the mobile device **100**. The impedance measurement may be obtained by the impedance measurement module **198** in response to a user action. In impedance measurement module **198** may interface with the electrodes **184** in order to obtain the impedance measurement. Upon indication by the user of a need for an impedance measurement, the impedance measurement module **198** may interface with the electrodes **184** to measure (assuming the user's body completes a circuit between the electrodes **184**) electrical impedance through the user's body. In some embodiments, the impedance measurement module

198 may interface with the electrodes **184** to measure the electrical impedance automatically upon the user's body completing a circuit between the electrodes **184**.

[0060] Hydration level measurement module **199** is configured to, when executed by processor **110**, obtain a hydration level measurement based on the impedance measurement obtained by the impedance measurement module **198**. The hydration level measurement module **199** may determine the hydration level from the measured impedance using techniques well known in the art.

[0061] It can be appreciated that the outer body of the mobile device **100** may be sized to be portable for a user. It can be appreciated that the term "portable" may refer to something that is able to be easily carried or moved, and may be a light and/or small. In the context of embodiments of the present invention, the term portable may refer to something easily transportable by the user or wearable by the user. For example, the mobile device **100** may be a smartphone device or a watch wearable by the user. Other examples of portable devices include a head-mounted display, calculator, portable media player, digital camera, pager, personal navigation device, etc. Examples of devices that may not be considered portable include a desktop computer, traditional telephone, television, appliances, etc. It can be appreciated that the bodily function measurements can be obtained via the smartphone, watch, or any other of the mentioned devices.

[0062] FIG. 2 illustrates a smartphone device **210** configured to obtain PPG and ECG measurements of a user, according to some embodiments. It can be appreciated that the smartphone device **210** is only one example of a mobile device **100**. The smartphone device **210** may include a plurality of contacts **220**. In some embodiments, a single contact **220** may be positioned at each end of the smartphone device **210**. In other embodiments, a device front surface **250** of the smartphone device **210** may include a contact layer including, e.g., silver metal or Indium Tin Oxide (ITO). The smartphone device **210** may obtain both PPG and ECG measurements of the user **260**. In some embodiments, the device front surface **250** may be a touchscreen.

[0063] For example, the user **260** may hold the smartphone device **210** with his/her first hand **240** touching one or more of the contacts **220** and with his/her second hand **230** touching the device front surface **250**. Upon the user **260** performing this action, the contacts **220** and the contact layer of the device front surface **250** may complete a circuit through the user's **260** body. The smartphone device **210** may then measure an electrical potential through the completed circuit to determine the ECG measurement. It can be appreciated that the ECG measurement may also be obtained without the user's first hand **240** or second hand **230** contacting the device front surface **250**. That is, the user's first hand **240** may make contact with a first side contact **220** and the user's second hand **230** may make contact with a second side contact **220** to complete the circuit. Alternatively, the user **260** may make contact with both side contacts **220** using only his/her first hand **240** or second hand **230** (see below for a measurement of PPG or Galvanic Skin Response (GSR)). Alternatively, and not illustrated in FIG. 1, sensors positioned and/or touched at other locations, for example legs, feet, ankles, knees, elbows, arms, neck, head, etc. could also be used to generate PPG, GSR and possibly ECG, depending on the location and how the contact was made.

[0064] The device front surface **250** of the smartphone device **210** may also obtain a PPG measurement of the user

260 by using an optical based technology. For example, when the user 260 touches the device front surface 250, a light source 185 may shine a light into the user's 260 skin, one or more sensors may measure the blood flow through the capillaries and thus determine a heart rate (PPG) of the user. This process is described in further detail below. In some embodiments, the light source may be a dedicated light source that is part of the smartphone device 210.

[0065] Accordingly, by obtaining both the PPG and ECG measurements of the user 260, a PTT technique may be used to determine the user's blood pressure. The smartphone device 210 may then provide important information to the user 260, based on the determined blood pressure (described further below).

[0066] Additionally, the smartphone device 210 may obtain an impedance measurement of the user using BIA techniques. In some embodiments, the impedance measurement may be obtained via the contact layer of the device front surface 250. The process of obtaining the impedance measurement is described in further detail below.

[0067] It can be appreciated that the device front surface 250 may serve multiple functions. That is, the device front surface 250 may be used to obtain ECG, PPG, and/or impedance measurements as described above, and may also be used as a user input device. The user 260 may use the device front surface 250 to provide input to applications being executed on the smartphone device 210. When the user 260 wishes to obtain a bodily function measurement using the device front surface 250, the user 260 may place the smartphone device 210 into a measurement mode. Alternatively, the smartphone device 210 may automatically detect the user's intention to obtain a bodily function measurement, e.g., from the user 260 placing his/her finger in a particular location on the device front surface 250 or touching the device front surface 250 for a predetermined period of time. Alternatively, the smartphone device 210 may regularly scan and store vital signs of the user 260 in the user's normal course of operating the device 210, without the user wanting or needed a particular vital sign report at that time.

[0068] FIG. 3 illustrates a wristwatch device 310 configured to obtain PPG, ECG, and impedance measurements of a user, according to some embodiments. The wristwatch device 310 illustrated in FIG. 3 operates similarly to the smartphone device 210 in FIG. 2. That is, the wristwatch device 310 may obtain PPG, ECG, and impedance measurements of the user 260 via a plurality of contacts. In some embodiments, one or more contacts may be placed at the bottom of the wristwatch device 310, where the contact makes a continuous contact with the user's 260 wrist while the user 260 wears the wristwatch device 310.

[0069] The wristwatch device 310 may also include a multifunction button 320, which may be used to obtain a bodily function measurement and also as a user input device. For example, the multifunction button 320 may be used by the user 260 to set a date and/or time for the wristwatch device 310. The multifunction button may have an integrated electrode on the surface. The user 260 may also use the multifunction button 320 to obtain an ECG measurement by touching the button 320 to complete a circuit (via the other contacts) through the user's body. In some embodiments, the multifunction button 320 may be integrated into a touchscreen of the wristwatch device 310.

[0070] The PPG and hydration measurements may be obtained in a similar fashion as described with respect to the

smartphone device of FIG. 2, e.g., via the contacts on the wristwatch device 310. The PPG measurement may also be obtained using optical techniques, as described below.

[0071] The wristwatch device 310 may be designed to be portable such that the user may easily wear the device or carry it on his/her person. In some embodiments, the wristwatch device 310 may perform everyday functions other than obtaining PPG, ECG, and impedance measurements of the user. For example, the wristwatch device 310 may provide the current time, a stopwatch function, a calendar function, communication functions, etc. The PPG, ECG, and impedance measurements functions may be available in addition to the other described functions on the wristwatch device 310.

[0072] FIG. 4A illustrates a cross sectional view 410 of the wristwatch device 310 of FIG. 3 and graphs 420, 430, and 440 showing measurements obtained by the wristwatch device, according to some embodiments. The cross sectional view 410 of the wristwatch device 310 shows a photodetector 412, a plurality of light emitting diodes (LED) 414, and a plurality of electrodes contacts 416. Additionally, the cross sectional view 410 also illustrates parts of a user's wrist, e.g., radial bone 418 and ulnar bone 419. In some embodiments, the plurality of LEDs 414 can be infrared (IR) LEDs. The IR LEDs may provide advantages to the user, such as not distracting the user from normal operation of the wristwatch device 310 because the IR LEDs may not emit any visible light.

[0073] The wristwatch device 310 may obtain PPG measurements of the user by using optical techniques. To obtain a PPG measurement, the LEDs 414 (typically positioned at the bottom of the wristwatch device 310 and on top of the user's wrist) may emit a light into the user's skin. The reflected light may be received at the photodetector 412. The user's blood volume may be determined based off of the reflected light as compared against time. From this data, the user's PPG measurement may be determined. In some embodiments, the determination of the user's blood volume may be determined from a change in the user's blood volume. More specifically, a change in the diameter of the blood vessels that are being probed by the LEDs 414.

[0074] Additionally, the user's ECG measurement may be obtained using the plurality of contacts 416 as described above with respect to FIG. 3. It can be appreciated that in the wristwatch device 310 embodiment, the plurality of contacts 416 may continuously be in contact with the user's skin while the user is wearing the wristwatch device 310 around his/her wrist. The user may then touch, with his/her hand that is not wearing the wristwatch device 310, another contact 416 that is located at another location on the wristwatch device 310 to complete the circuit through the user's body.

[0075] Similarly, the user's hydration measurements may also be obtained by using the plurality of contacts 416 and determining impedance through the user's body.

[0076] Graph 420 illustrates the intensity of the obtained light reflections at the photodetector 412 against time. In this example, the duration between each pulse is approximately one second. From this graph, the user's PPG can be determined.

[0077] Graph 430 shows a user's heart rate variability by comparing the user's ECG and the user's PPG. As shown in graph 440, the PTT can be determined by taking the difference between a peak of an ECG pulse and the corresponding inflection point (at the same time interval) of the PPG pulse.

The PTT may then be used to determine the user's blood pressure, which is well known in the art.

[0078] FIG. 4B illustrates a cross sectional view of the wristwatch device 310 of FIG. 3, where the sensor for obtaining the PPG measurement is contained within a contact button of the wristwatch device, according to some embodiments. In contrast to the wristwatch device illustrated in FIG. 4A, the wristwatch device 310 illustrated in FIG. 4B contains a PPG sensor 470 within a contact button 460 on the wristwatch device 310. The user may place his/her finger on the contact button 460 such that the PPG sensor 470 can obtain the PPG signal from the finger to determine the PPG measurement. In some embodiments, the PPG sensor 470 may be an optical sensor.

[0079] Certain advantages may be realized by placing the PPG sensor 470 within the contact button 460, including but not limited to, allowing for a faster and more accurate reading of the PPG signal from the user's finger as opposed to from the user's wrist. This can result in faster determination of the user's PTT. It can be appreciated that the PPG sensor 470 within the contact button 460 can provide better results than measuring the PPG from the arm/wrist due to the vascularization of the arm associated with obtaining the PPG measurement from the arm. That is, the arteries near the surface of the arm where the measurement is attempting to be obtained from can blur out the signal due to the high number of routes that blood cloud flow. However, in the finger, typically an artery runs along the inside between the user's fingers to the tip of the finger before expanding out into many capillaries. As such, a clear signal can be obtained from the finger.

[0080] In some embodiments, the contact button 460 may be a multi-function button operable to serve other functions of the wristwatch device 310. For example, the multi-function button can be used to interact with the wristwatch device 310 for setting the time, starting/stopping a stopwatch, or any other function typically available in a wristwatch device 310.

[0081] In the implementation of FIG. 4B, the wristwatch device 310 may also obtain an ECG measurement as described with respect to FIG. 4A, in accordance with some embodiments. That is, the ECG measurement can be obtained by the electrical contact 416 in contact with the user's arm/wrist and contact button 460 in contact with the user's finger, whereby the circuit is completed. Advantageously, when the user touches his/her finger to the contact button 460, both the ECG measurement and the PPG measurement can be obtained.

[0082] FIG. 4C illustrates a top view of the wristwatch device of FIG. 3 where the sensor for obtaining the PPG measurement is contained within a contact button of the wristwatch device, according to some embodiments. FIG. 4C illustrates the top view of the wristwatch device 310 described in FIG. 4B. As illustrated in the figure, the PPG sensor 470 is contained within the contact button 460. The electrical contact 416 used to obtain ECG measurement data can be located at the bottom of the wristwatch device 310.

[0083] In some embodiments, the contact button 460 may have an opening such that light from the PPG sensor 470 can travel through the opening to obtain an optical PPG measurement. In some embodiments, the contact button 460 may be made of a material that optimizes metal electrodes, such as stainless steel.

[0084] FIG. 4D illustrates a graph showing heart activity measurements obtained from PPG measurements obtained at the finger, according to some embodiments. The graph shows

an electrocardiogram signal 480 and a PPG signal 490 obtained at the finger of a 24-year old male. It can be appreciated that the PPG signal 490 does not contain much noise and the signal is smooth and/or rounded. Due to the better resolution of the PPG signal 490 provided by obtaining the measurement from the finger rather than the wrist, other information such as the heart activity can also benefit from the increased accuracy. Additional information that can be determined due to the better resolution of the PPG signal 490 can include, but is not limited to, systolic blood pressure and a measure of vascular stiffness.

[0085] FIG. 5 is a schematic diagram 500 of a method for obtaining impedance measurements of a user, according to some embodiments. The mobile device may be either the smartphone device described in FIG. 2, the wristwatch device described in FIG. 3, or any other mobile device. As described above, the impedance measurement of the user may be used to determine the user's hydration level using BIA techniques. The user's body 510 essentially functions as a capacitance and resistance network in this illustration. When the user's body 510 makes contact with the contact points 530, an impedance converter 520 may determine the impedance value through the user's body 510. In this scenario, the user's body 510 may act as a capacitor. The impedance value may be a function of surface tissue impedance and deep tissue impedance. The impedance value may then be used to estimate a total body water content of the user's body 510. This figure shows measuring the impedance through one leg, the torso, and one arm. The method works the same way measuring through both arms and the chest. In some embodiments, the mobile device may include phase-sensitive electronics to distinguish between electrical resistance and reactance.

[0086] Upon determining the user's hydration level, the mobile device may provide a notification to the user. The types of notifications are described in further detail with respect to FIG. 7.

[0087] FIG. 6 is a schematic diagram 600 of two resistors and a capacitor representing conduction through tissue, according to some embodiments. In FIG. 6, x_c represents the capacitance of the user's cell walls, $R_{(CW)}$ represents the resistance of the body water inside of the user's cells, and $R_{(ECW)}$ represents the resistance of the body water outside of the user's cells. The circuit shown in FIG. 6 may be used as part of the schematic diagram in FIG. 5 to determine the hydration level of the user by determining an electrical impedance through the user's body.

[0088] FIG. 7 is a flow diagram 700 illustrating a plurality of derived metrics 720 from a plurality of sensor metrics 710, according to some embodiments. The plurality of sensor metrics 710 may include, but is not limited to, PPG pulse measurement, accelerometer measurements, AC biometric impedance measurements, and 2-lead ECG heart rate measurements. These sensor metrics 710 may be obtained by taking measurements via the mobile device. Based on data from the sensor metrics 710, a plurality of derived metrics 720 may be derived. These derived metrics may include, but is not limited to, heart rate, heart rate variability, stress calculation, blood pressure, and hydration state.

[0089] For example, when a PPG pulse measurement is obtained, using the techniques described herein, the user's heart rate and/or heart rate variability may be determined. The PPG pulse measurement may be combined with an ECG heart rate measurement to determine the user's blood pressure using PTT techniques. Based on the determined blood pres-

sure, a user's stress level may be determined. If it is determined that the user is at a high stress level, the mobile device may notify the user to take a deep breath, go for a walk, drink a glass of water, etc. As shown, the stress level may also be determined from the user's GSR data.

[0090] In another example, when an AC bioelectric impedance measurement is obtained, using the techniques described herein, the user's hydration state may be determined from data regarding the total body water of the user. If the user's hydration state is determined to be low, the mobile device may notify the user to drink a glass of water. On the other hand, if the user's hydration state is determined to be adequate, the mobile device may notify the user that to keep up the good work.

[0091] In another example, energy calculations may be determined based upon accelerometer and gyroscope data obtained by the mobile device. For example, if the user is moving around actively, the accelerometer data may indicate a high level of movement and the mobile device may determine that the user's energy level is high. The mobile device may notify the user to continue being active. In some embodiments, the mobile device may keep track of the user's energy level throughout the day and notify the user upon predetermined intervals to become active in order to reach a threshold amount of activity for the day.

[0092] In some embodiments, accelerometer measurements may be used to determine the user's heart rate and/or heart rate variability. The same calculations described above may be determined/calculated using these measurements.

[0093] It is understood that the specific order or hierarchy of steps in the processes disclosed is an illustration of exemplary approaches. Based upon design preferences, it is understood that the specific order or hierarchy of steps in the processes may be rearranged. Further, some steps may be combined or omitted. The accompanying method claims present elements of the various steps in a sample order, and are not meant to be limited to the specific order or hierarchy presented.

[0094] The previous description is provided to enable any person skilled in the art to practice the various aspects described herein. Various modifications to these aspects will be readily apparent to those skilled in the art, and the generic principles defined herein may be applied to other aspects. Moreover, nothing disclosed herein is intended to be dedicated to the public.

[0095] FIG. 8 is a flow diagram 800 of an exemplary method of obtaining at least one bodily function measurement. In block 810, a first measurement indicative of blood volume is obtained in response to a user action. The first measurement may be obtained via a plurality of sensors physically coupled to an outer body of a mobile device. In some embodiments, the first measurement may be a photoplethysmography (PPG) measurement.

[0096] In some embodiments, the plurality of sensors may include at least one light sensor. The mobile device may also include at least one light source. Obtaining the first measurement may include measuring, via the at least one light sensor, reflected light from the light source reflected off of blood vessels within a user of the mobile device. For example, in FIG. 3, the wearable watch obtains a PPG measurement of the user via the light sensors and light source within the wearable watch. The PPG measurement may be obtained by the PPG measurement module described in FIG. 1.

[0097] In block 820, a second measurement indicative of heart electrical activity is obtained in response to the user action. The second measurement may be obtained via the plurality of sensors. In some embodiments, the second measurement may be an electrocardiography (ECG) measurement.

[0098] In some embodiments, the plurality of sensors may include at least a first electrode and a second electrode. Obtaining the second measurement may include detecting completion of a circuit between the first electrode and the second electrode via a portion of the user's body. For example, in FIG. 3, the wearable watch obtains an ECG measurement of the user via the electrodes located on the outer body of the wearable watch. The ECG measurement may be obtained by the ECG measurement module described in FIG. 1.

[0099] In block 830, generation of a blood pressure measurement based on the first measurement and the second measurement is facilitated via a processor of the mobile device. The processor may be contained within the outer body of the mobile device and the outer body may be sized to be portable for the user. In some embodiments, the mobile device may be configured to perform a primary function and a secondary function. Facilitating the generation of the blood pressure measurement may be performed as the secondary function of the mobile device. For example, in FIG. 3, the wearable watch may facilitate measurement of the user's blood pressure based on the obtained PPG and ECG measurements. The blood pressure may be determined by the blood pressure measurement module described in FIG. 1.

[0100] In some embodiments, the mobile device is a watch. For example, in FIG. 3, the mobile device is a wearable watch. In other embodiments, the mobile device is a smartphone device. For example, in FIG. 2, the mobile device is a smartphone device.

[0101] In some embodiments, at least one of the sensors is built into a multifunction surface, wherein the multifunction surface is configured to simultaneously obtain the first measurement or the second measurement and a user input. For example, in FIG. 2, the smartphone device (also capable of obtaining PPG and ECG measurements similar to the wearable watch) includes a multifunction touchscreen surface that facilitates user input to the smartphone device. In one example, the multifunction surface can include

[0102] In some embodiments, block 810 and block 820 may be performed by a first device and block 830 may be performed by a second device. That is, the measures of blood volume and heart electrical activity may be performed by a device separate than the generation of the blood pressure measurement. For example, the measure of blood volume and heart electrical activity may be performed via a communication device worn by the user, whereas the generation of the blood pressure measurement may be performed by a server computer that receives the measures of blood volume and heart electrical activity from the communication device. In some embodiments, the server computer could reside within a cloud system.

[0103] FIG. 9 is another flow diagram 900 of an exemplary method of obtaining at least one bodily function measurement. In block 910, a measurement to provide at least one measure of impedance associated with a user's body is obtained in response to a user action. In some embodiments, the measurement may be obtained via a plurality of sensors comprising electrodes that are physically coupled to an outer

body of the mobile device. In some embodiments, a portion of the user's body positioned between the electrodes completes a circuit.

[0104] For example, in FIG. 3, the wearable watch obtains an impedance measurement of the user via the electrodes located on the outer body of the wearable watch. The impedance measurement may be obtained by the impedance measurement module described in FIG. 1.

[0105] In block 920, generation of a hydration level measurement based on the measure of impedance is facilitated via a processor of the mobile device. In some embodiments, the processor is contained within the outer body of the mobile device. In some embodiments, the outer body is sized to be portable for the user.

[0106] In some embodiments, the mobile device is configured to perform a primary function and a secondary function. In some embodiments, the processor is configured to facilitate generation of the hydration level measurement as the secondary function of the mobile device. For example, in FIG. 3, the wearable watch may facilitate measurement of the user's hydration level based on the obtained impedance measurement. The hydration level may be determined by the hydration level measurement module described in FIG. 1.

[0107] In some embodiments, at least one of the sensors is built into a multifunction surface. In some embodiments, the multifunction surface is configured to simultaneously obtain the impedance measurement and a user input. In some embodiments, the multifunction surface comprises Indium Tin Oxide (ITO). In some embodiments, the multifunction surface comprises silver metal. In some embodiments, the multifunction surface comprises a network of wires or a transparent conductor. For example, in FIG. 2, the smartphone device (also capable of obtaining impedance measurements similar to the wearable watch) includes a multifunction touchscreen surface that facilitates user input to the smartphone device.

[0108] In some embodiments, the mobile device is a watch. For example, in FIG. 3, the mobile device is a wearable watch. In other embodiments, the mobile device is a smartphone device. For example, in FIG. 2, the mobile device is a smartphone device.

[0109] In some embodiments, block 910 may be performed by a first device and block 920 may be performed by a second device. That is, the measure of impedance may be performed by a device separate from the generation of the hydration level measurement. For example, the measure of impedance may be performed via a communication device worn by the user, whereas the generation of the hydration level may be performed by a server computer that receives the measure of impedance from the communication device. In some embodiments, the server computer could reside within a cloud system.

[0110] FIG. 10 illustrates an example of a computing system in which one or more embodiments may be implemented. A computer system as illustrated in FIG. 10 may be incorporated as part of the above described computerized device. For example, computer system 1000 can represent some of the components of a television, a computing device, a server, a desktop, a workstation, a control or interaction system in an automobile, a tablet, a netbook or any other suitable computing system. A computing device may be any computing device with an image capture device or input sensory unit and a user output device. An image capture device or input sensory unit may be a camera device. A user output device may

be a display unit. Examples of a computing device include but are not limited to video game consoles, tablets, smart phones and any other hand-held devices. FIG. 10 provides a schematic illustration of one embodiment of a computer system 1000 that can perform the methods provided by various other embodiments, as described herein, and/or can function as the host computer system, a remote kiosk/terminal, a point-of-sale device, a telephonic or navigation or multimedia interface in an automobile, a computing device, a set-top box, a table computer and/or a computer system. FIG. 10 is meant only to provide a generalized illustration of various components, any or all of which may be utilized as appropriate. FIG. 10, therefore, broadly illustrates how individual system elements may be implemented in a relatively separated or relatively more integrated manner. In some embodiments, elements of computer system 100 may be used to implement functionality of the mobile device 100 in FIG. 1.

[0111] The computer system 1000 is shown comprising hardware elements that can be electrically coupled via a bus 1002 (or may otherwise be in communication, as appropriate). The hardware elements may include one or more processors 1004, including without limitation one or more general-purpose processors and/or one or more special-purpose processors (such as digital signal processing chips, graphics acceleration processors, and/or the like); one or more input devices 1008, which can include without limitation one or more cameras, sensors, a mouse, a keyboard, a microphone configured to detect ultrasound or other sounds, and/or the like; and one or more output devices 1010, which can include without limitation a display unit such as the device used in embodiments of the invention, a printer and/or the like.

[0112] In some implementations of the embodiments of the invention, various input devices 1008 and output devices 1010 may be embedded into interfaces such as display devices, tables, floors, walls, and window screens. Furthermore, input devices 1008 and output devices 1010 coupled to the processors may form multi-dimensional tracking systems.

[0113] The computer system 1000 may further include (and/or be in communication with) one or more non-transitory storage devices 1006, which can comprise, without limitation, local and/or network accessible storage, and/or can include, without limitation, a disk drive, a drive array, an optical storage device, a solid-state storage device such as a random access memory ("RAM") and/or a read-only memory ("ROM"), which can be programmable, flash-updateable and/or the like. Such storage devices may be configured to implement any appropriate data storage, including without limitation, various file systems, database structures, and/or the like.

[0114] The computer system 1000 might also include a communications subsystem 1012, which can include without limitation a modem, a network card (wireless or wired), an infrared communication device, a wireless communication device and/or chipset (such as a Bluetooth™ device, an 802.11 device, a Wi-Fi device, a WiMax device, cellular communication facilities, etc.), and/or the like. The communications subsystem 1012 may permit data to be exchanged with a network, other computer systems, and/or any other devices described herein. In many embodiments, the computer system 1000 will further comprise a non-transitory working memory 1018, which can include a RAM or ROM device, as described above.

[0115] The computer system 1000 also can comprise software elements, shown as being currently located within the working memory 1018, including an operating system 1014, device drivers, executable libraries, and/or other code, such as one or more application programs 1016, which may comprise computer programs provided by various embodiments, and/or may be designed to implement methods, and/or configure systems, provided by other embodiments, as described herein. Merely by way of example, one or more procedures described with respect to the method(s) discussed above might be implemented as code and/or instructions executable by a computer (and/or a processor within a computer); in an aspect, then, such code and/or instructions can be used to configure and/or adapt a general purpose computer (or other device) to perform one or more operations in accordance with the described methods.

[0116] A set of these instructions and/or code might be stored on a computer-readable storage medium, such as the storage device(s) 1006 described above. In some cases, the storage medium might be incorporated within a computer system, such as computer system 1000. In other embodiments, the storage medium might be separate from a computer system (e.g., a removable medium, such as a compact disc), and/or provided in an installation package, such that the storage medium can be used to program, configure and/or adapt a general purpose computer with the instructions/code stored thereon. These instructions might take the form of executable code, which is executable by the computer system 1000 and/or might take the form of source and/or installable code, which, upon compilation and/or installation on the computer system 1000 (e.g., using any of a variety of generally available compilers, installation programs, compression/decompression utilities, etc.) then takes the form of executable code.

[0117] Substantial variations may be made in accordance with specific requirements. For example, customized hardware might also be used, and/or particular elements might be implemented in hardware, software (including portable software, such as applets, etc.), or both. Further, connection to other computing devices such as network input/output devices may be employed. In some embodiments, one or more elements of the computer system 1000 may be omitted or may be implemented separate from the illustrated system. For example, the processor 1004 and/or other elements may be implemented separate from the input device 1008. In one embodiment, the processor is configured to receive images from one or more cameras that are separately implemented. In some embodiments, elements in addition to those illustrated in FIG. 10 may be included in the computer system 1000.

[0118] Some embodiments may employ a computer system (such as the computer system 1000) to perform methods in accordance with the disclosure. For example, some or all of the procedures of the described methods may be performed by the computer system 1000 in response to processor 1004 executing one or more sequences of one or more instructions (which might be incorporated into the operating system 1014 and/or other code, such as an application program 1016) contained in the working memory 1018. Such instructions may be read into the working memory 1018 from another computer-readable medium, such as one or more of the storage device(s) 1006. Merely by way of example, execution of the sequences of instructions contained in the working memory 1018 might cause the processor(s) 1004 to perform one or more procedures of the methods described herein.

[0119] The terms “machine-readable medium” and “computer-readable medium,” as used herein, refer to any medium that participates in providing data that causes a machine to operate in a specific fashion. In some embodiments implemented using the computer system 1000, various computer-readable media might be involved in providing instructions/code to processor(s) 1004 for execution and/or might be used to store and/or carry such instructions/code (e.g., as signals). In many implementations, a computer-readable medium is a physical and/or tangible storage medium. Such a medium may take many forms, including but not limited to, non-volatile media, volatile media, and transmission media. Non-volatile media include, for example, optical and/or magnetic disks, such as the storage device(s) 1006. Volatile media include, without limitation, dynamic memory, such as the working memory 1018. Transmission media include, without limitation, coaxial cables, copper wire and fiber optics, including the wires that comprise the bus 1002, as well as the various components of the communications subsystem 1012 (and/or the media by which the communications subsystem 1012 provides communication with other devices). Hence, transmission media can also take the form of waves (including without limitation radio, acoustic and/or light waves, such as those generated during radio-wave and infrared data communications).

[0120] Common forms of physical and/or tangible computer-readable media include, for example, a floppy disk, a flexible disk, hard disk, magnetic tape, or any other magnetic medium, a CD-ROM, any other optical medium, punchcards, papertape, any other physical medium with patterns of holes, a RAM, a PROM, EPROM, a FLASH-EPROM, any other memory chip or cartridge, a carrier wave as described hereinafter, or any other medium from which a computer can read instructions and/or code.

[0121] Various forms of computer-readable media may be involved in carrying one or more sequences of one or more instructions to the processor(s) 1004 for execution. Merely by way of example, the instructions may initially be carried on a magnetic disk and/or optical disc of a remote computer. A remote computer might load the instructions into its dynamic memory and send the instructions as signals over a transmission medium to be received and/or executed by the computer system 1000. These signals, which might be in the form of electromagnetic signals, acoustic signals, optical signals and/or the like, are all examples of carrier waves on which instructions can be encoded, in accordance with various embodiments of the invention.

[0122] The communications subsystem 1012 (and/or components thereof) generally will receive the signals, and the bus 1002 then might carry the signals (and/or the data, instructions, etc. carried by the signals) to the working memory 1018, from which the processor(s) 1004 retrieves and executes the instructions. The instructions received by the working memory 1018 may optionally be stored on a non-transitory storage device 1006 either before or after execution by the processor(s) 1004.

[0123] The methods, systems, and devices discussed above are examples. Various configurations may omit, substitute, or add various procedures or components as appropriate. For instance, in alternative configurations, the methods may be performed in an order different from that described, and/or various stages may be added, omitted, and/or combined. Also, features described with respect to certain configurations may be combined in various other configurations. Different

aspects and elements of the configurations may be combined in a similar manner. Also, technology evolves and, thus, many of the elements are examples and do not limit the scope of the disclosure or claims.

[0124] Specific details are given in the description to provide a thorough understanding of example configurations (including implementations). However, configurations may be practiced without these specific details. For example, well-known circuits, processes, algorithms, structures, and techniques have been shown without unnecessary detail in order to avoid obscuring the configurations. This description provides example configurations only, and does not limit the scope, applicability, or configurations of the claims. Rather, the preceding description of the configurations will provide those skilled in the art with an enabling description for implementing described techniques. Various changes may be made in the function and arrangement of elements without departing from the spirit or scope of the disclosure.

[0125] Also, configurations may be described as a process which is depicted as a flow diagram or block diagram. Although each may describe the operations as a sequential process, many of the operations can be performed in parallel or concurrently. In addition, the order of the operations may be rearranged. A process may have additional steps not included in the figure. Furthermore, examples of the methods may be implemented by hardware, software, firmware, middleware, microcode, hardware description languages, or any combination thereof. When implemented in software, firmware, middleware, or microcode, the program code or code segments to perform the necessary tasks may be stored in a non-transitory computer-readable medium such as a storage medium. Processors may perform the described tasks.

[0126] Having described several example configurations, various modifications, alternative constructions, and equivalents may be used without departing from the spirit of the disclosure. For example, the above elements may be components of a larger system, wherein other rules may take precedence over or otherwise modify the application of the invention. Also, a number of steps may be undertaken before, during, or after the above elements are considered.

What is claimed is:

1. A mobile device for obtaining at least one bodily function measurement, comprising:

- an outer body sized to be portable for a user;
- a processor contained within the outer body;
- a plurality of sensors physically coupled to the outer body for obtaining data accessible by the processor;
- wherein one or more of the sensors is configured to obtain a first measurement indicative of blood volume in response to a user action, wherein at least one of the sensors configured to obtain the first measurement is contained within a contact button coupled to the outer body;
- wherein one or more of the sensors is configured to obtain a second measurement indicative of heart electrical activity in response to the user action; and
- wherein the processor is configured to facilitate generation of a blood pressure measurement based on the first measurement and the second measurement.

2. The mobile device of claim 1 wherein the mobile device is configured to perform a primary function and a secondary function, and wherein the processor is configured to facilitate generation of the blood pressure measurement as the secondary function of the mobile device.

3. The mobile device of claim 1 wherein the first measurement indicative of blood volume comprises a photoplethysmography (PPG) measurement.

4. The mobile device of claim 1 wherein the second measurement indicative of heart electrical activity comprises an electrocardiography (ECG) measurement.

5. The mobile device of claim 1 wherein the one or more of the sensors configured to obtain the first measurement indicative of blood volume comprises at least one light sensor, and wherein the mobile device further comprises at least one light source and the at least one light sensor measures reflected light from the light source reflected off of blood vessels within a user of the mobile device to obtain the first measurement.

6. The mobile device of claim 5, wherein the at least one light source comprises an infrared (IR) light emitting diode (LED).

7. The mobile device of claim 1 wherein the one or more of the sensors configured to obtain the second measurement indicative of heart electrical activity comprises at least a first electrode and a second electrode, and wherein a portion of a user of the mobile device's body completes a circuit between the first electrode and the second electrode.

8. The mobile device of claim 1 wherein the mobile device is at least one of a smartphone device or a watch.

9. The mobile device of claim 1 wherein at least one of the sensors is built into a multifunction surface, wherein the multifunction surface is configured to simultaneously obtain the first measurement or the second measurement and a user input.

10. A method for obtaining at least one bodily function measurement via a mobile device, comprising:

obtaining, via a plurality of sensors physically coupled to an outer body of the mobile device, a first measurement indicative of blood volume in response to a user action, wherein at least one of the sensors is contained within a contact button coupled to the outer body;

obtaining, via the plurality of sensors, a second measurement indicative of heart electrical activity in response to the user action; and

facilitating, via a processor of the mobile device, generation of a blood pressure measurement based on the first measurement and the second measurement, wherein the processor is contained within the outer body of the mobile device, the outer body sized to be portable for the user.

11. The method of claim 10 wherein the mobile device is configured to perform a primary function and a secondary function, and wherein the facilitating step is performed as the secondary function of the mobile device.

12. The method of claim 10 wherein the first measurement indicative of blood volume comprises a photoplethysmography (PPG) measurement.

13. The method of claim 10 wherein the second measurement indicative of heart electrical activity comprises an electrocardiography (ECG) measurement.

14. The method of claim 10 wherein the plurality of sensors comprises at least one light sensor and the mobile device comprises at least one light source, and wherein obtaining the first measurement indicative of blood volume comprises measuring, via the at least one light sensor, reflected light from the light source reflected off of blood vessels within a user of the mobile device to obtain the first measurement.

15. The method of claim 14, wherein the at least one light source comprises an infrared (IR) light emitting diode (LED).

16. The method of claim 10 wherein the plurality of sensors comprises at least a first electrode and a second electrode, and wherein obtaining the second measurement indicative of heart electrical activity comprises detecting completion of a circuit between the first electrode and the second electrode via a portion of the user's body.

17. The method of claim 10 wherein the mobile device is at least one of a smartphone device or a watch.

18. The method of claim 10 wherein at least one of the sensors is built into a multifunction surface, wherein the multifunction surface is configured to simultaneously obtain the first measurement or the second measurement and a user input.

19. An apparatus for obtaining at least one bodily function measurement, comprising:

means for obtaining, via a plurality of sensors physically coupled to an outer body of a mobile device, a first measurement indicative of blood volume in response to a user action, wherein at least one of the sensors is contained within a contact button coupled to the outer body;

means for obtaining, via the plurality of sensors, a second measurement indicative of heart electrical activity in response to the user action; and

means for facilitating, via a processor of the mobile device, generation of a blood pressure measurement based on the first measurement and the second measurement, wherein the processor is contained within the outer body of the mobile device, the outer body sized to be portable for the user.

20. The apparatus of claim 19 wherein the mobile device is configured to perform a primary function and a secondary function, and wherein the facilitating step is performed as the secondary function of the mobile device.

21. The apparatus of claim 19 wherein the first measurement indicative of blood volume comprises a photoplethysmography (PPG) measurement, and wherein the second measurement indicative of heart electrical activity comprises an electrocardiography (ECG) measurement.

22. The apparatus of claim 19 wherein the plurality of sensors comprises at least one light sensor and the mobile device comprises at least one light source, and wherein the means for obtaining the first measurement indicative of blood volume comprises means for measuring, via the at least one light sensor, reflected light from the light source reflected off of blood vessels within a user of the mobile device to obtain the first measurement, and wherein the at least one light source is an infrared (IR) light emitting diode (LED).

23. The apparatus of claim 19 wherein the plurality of sensors comprises at least a first electrode and a second electrode, and wherein the means for obtaining the second measurement indicative of heart electrical activity comprises means for detecting completion of a circuit between the first electrode and the second electrode via a portion of the user's body.

24. The apparatus of claim 19 wherein at least one of the sensors is built into a multifunction surface, wherein the

multifunction surface is configured to simultaneously obtain the first measurement or the second measurement and a user input.

25. One or more non-transitory computer-readable media storing computer-executable instructions for constructing a representation of a planar object that, when executed, cause one or more computing devices included in a mobile device to:

obtain, via a plurality of sensors physically coupled to an outer body of the mobile device, a first measurement indicative of blood volume in response to a user action, wherein at least one of the sensors is contained within a contact button coupled to the outer body;

obtain, via the plurality of sensors, a second measurement indicative of heart electrical activity in response to the user action; and

facilitate, via a processor of the mobile device, generation of a blood pressure measurement based on the first measurement and the second measurement, wherein the processor is contained within the outer body of the mobile device, the outer body sized to be portable for the user.

26. The non-transitory computer-readable media of claim 25 wherein the mobile device is configured to perform a primary function and a secondary function, and wherein the facilitating step is performed as the secondary function of the mobile device.

27. The non-transitory computer-readable media of claim 25 wherein the first measurement indicative of blood volume comprises a photoplethysmography (PPG) measurement, and wherein the second measurement indicative of heart electrical activity comprises an electrocardiography (ECG) measurement.

28. The non-transitory computer-readable media of claim 25 wherein the plurality of sensors comprises at least one light sensor and the mobile device comprises at least one light source, and wherein obtaining the first measurement indicative of blood volume comprises measuring, via the at least one light sensor, reflected light from the light source reflected off of blood vessels within a user of the mobile device to obtain the first measurement, and wherein the at least one light source is an infrared (IR) light emitting diode (LED).

29. The non-transitory computer-readable media of claim 25 wherein the plurality of sensors comprises at least a first electrode and a second electrode, and wherein the obtaining the second measurement indicative of heart electrical activity comprises detecting completion of a circuit between the first electrode and the second electrode via a portion of the user's body.

30. The non-transitory computer-readable media of claim 25 wherein at least one of the sensors is built into a multifunction surface, wherein the multifunction surface is configured to simultaneously obtain the first measurement or the second measurement and a user input.

* * * * *

专利名称(译)	用于使用移动设备获得身体功能测量的系统和方法		
公开(公告)号	US20150119654A1	公开(公告)日	2015-04-30
申请号	US14/523588	申请日	2014-10-24
[标]申请(专利权)人(译)	高通股份有限公司		
申请(专利权)人(译)	高通公司		
当前申请(专利权)人(译)	高通公司		
[标]发明人	MARTIN RUSSEL ALLYN SHEYNBLAT LEONID HOFFMAN DOUGLAS WAYNE		
发明人	MARTIN, RUSSEL ALLYN SHEYNBLAT, LEONID HOFFMAN, DOUGLAS WAYNE		
IPC分类号	A61B5/021 A61B5/0402 A61B5/02 A61B5/00		
CPC分类号	A61B5/021 A61B5/0059 A61B5/0402 A61B5/7278 A61B5/681 A61B5/6898 A61B5/742 A61B5/02028 A61B5/0261 A61B5/0404 A61B5/0537 A61B5/6824		
优先权	61/895995 2013-10-25 US		
其他公开文献	US10052035		
外部链接	Espacenet USPTO		

摘要(译)

提出了用于获得至少一个身体功能测量的方法，系统，计算机可读介质和设备。移动设备包括尺寸适于用户便携的外部主体，包含在外部主体内的处理器，以及物理地耦合到外部主体的多个传感器。传感器配置成获得指示血容量的第一测量值和指示响应于用户动作的心脏电活动的第二测量值。基于第一测量和第二测量确定血压测量。传感器还包括电极，其中位于电极之间的用户身体的一部分完成电路和测量，以提供与用户身体相关的至少一种阻抗测量。基于阻抗的测量确定水合水平测量。

