



US 20200121851A1

(19) **United States**

(12) **Patent Application Publication**
Rinehart et al.

(10) **Pub. No.: US 2020/0121851 A1**
(43) **Pub. Date: Apr. 23, 2020**

(54) **SYSTEM AND METHOD FOR
CLOSED-LOOP PATIENT-ADAPTIVE
HEMODYNAMIC MANAGEMENT**

Publication Classification

(71) Applicant: **The Regents of the University of
California, Oakland, CA (US)**

(51) **Int. Cl.**
A61M 5/172 (2006.01)
A61M 5/168 (2006.01)
A61M 5/142 (2006.01)
A61B 5/029 (2006.01)
A61B 5/00 (2006.01)
G16H 20/17 (2006.01)

(72) Inventors: **Joseph B. Rinehart**, Newport Beach,
CA (US); **Maxime Cannesson**, Irvine,
CA (US)

(52) **U.S. Cl.**
CPC *A61M 5/1723* (2013.01); *A61M 5/16877*
(2013.01); *A61M 5/142* (2013.01); *A61B*
5/029 (2013.01); *A61B 5/4833* (2013.01);
G16H 20/17 (2018.01); *A61B 5/14542*
(2013.01); *A61M 2230/04* (2013.01); *A61M*
2230/00 (2013.01); *A61M 2205/52* (2013.01);
A61M 2205/502 (2013.01); *A61B 5/7203*
(2013.01); *A61M 2202/0208* (2013.01)

(73) Assignee: **The Regents of the University of
California, Oakland, CA (US)**

(21) Appl. No.: **16/723,737**

(22) Filed: **Dec. 20, 2019**

Related U.S. Application Data

(60) Continuation of application No. 14/680,706, filed on
Apr. 7, 2015, now Pat. No. 10,512,722, which is a
division of application No. 13/349,058, filed on Jan.
12, 2012, now Pat. No. 9,022,974.

(60) Provisional application No. 61/432,081, filed on Jan.
12, 2011.

(57) **ABSTRACT**

A system and method for patient-adaptive hemodynamic management is described. One embodiment includes a system for hemodynamic management including transfusion, volume resuscitation with intravenous fluids, and medications, utilizing monitored hemodynamic parameters including the described dynamic predictors of fluid responsiveness, and including an intelligent algorithm capable of adaptation of the function of the device to specific patients.

10

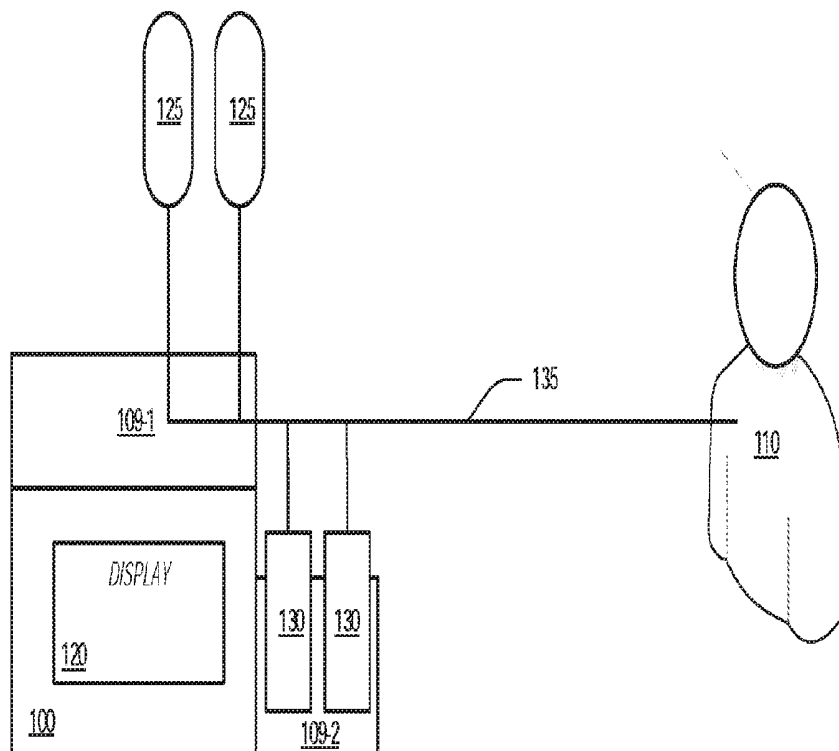

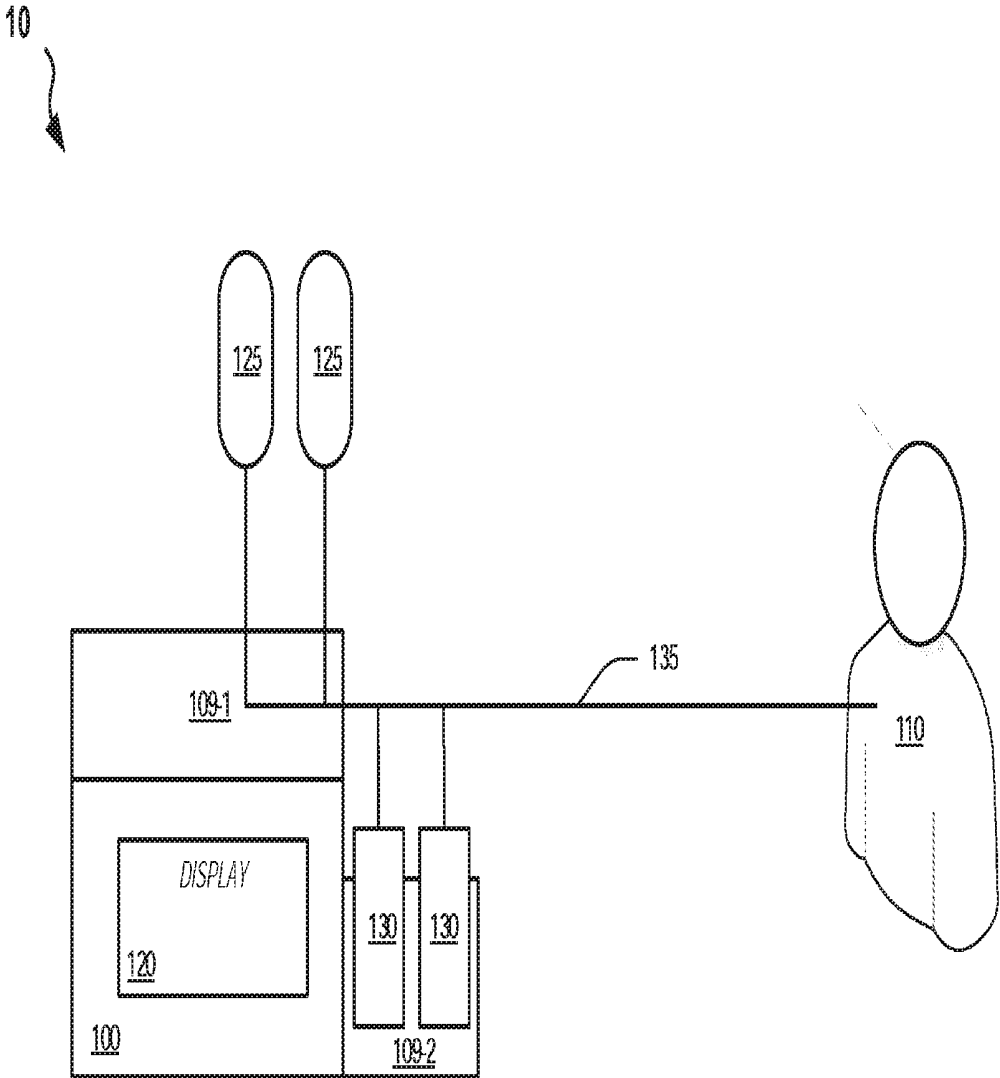

FIG. 1A

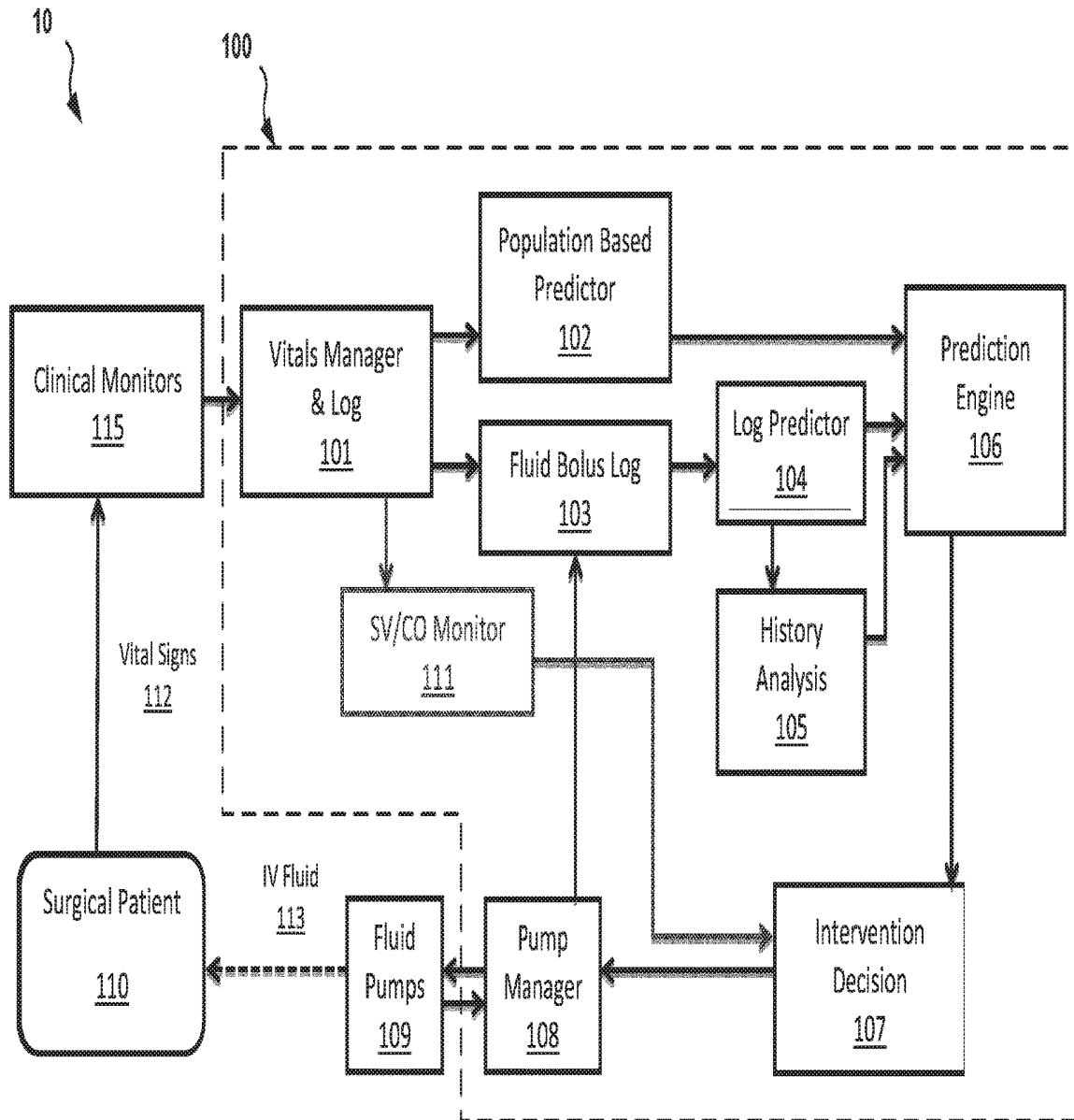

FIG. 1B

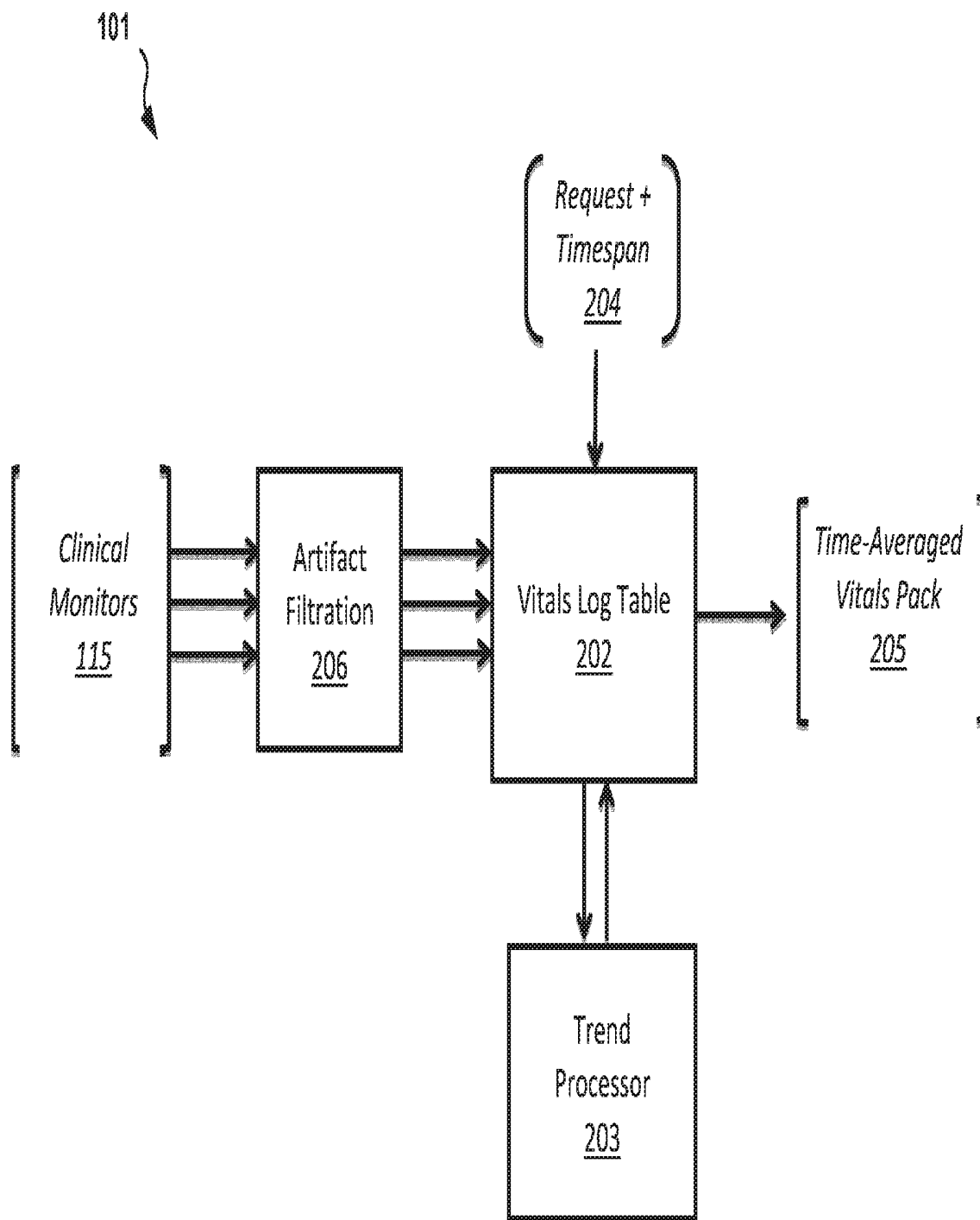

FIG. 2

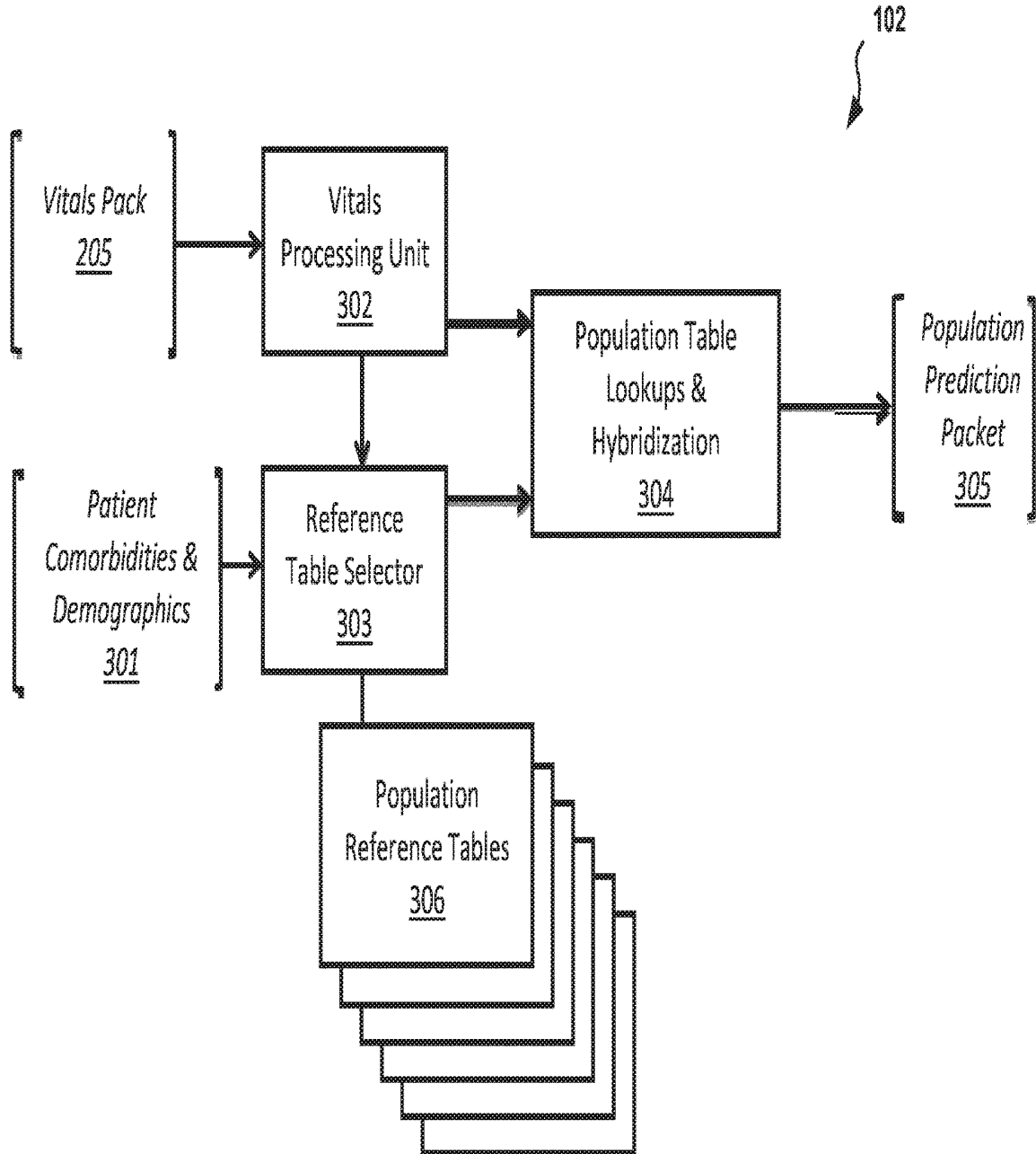

FIG. 3

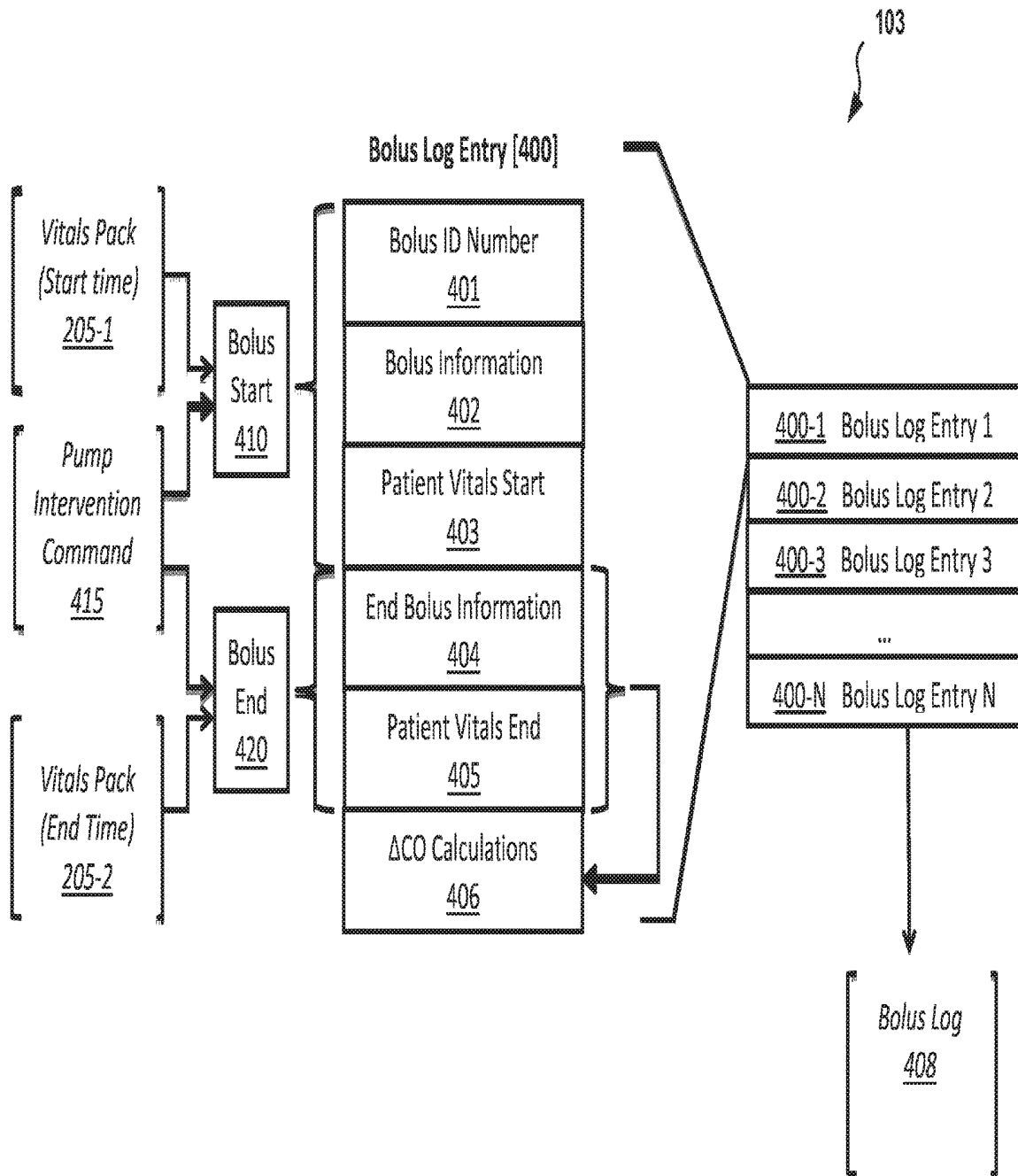

FIG. 4

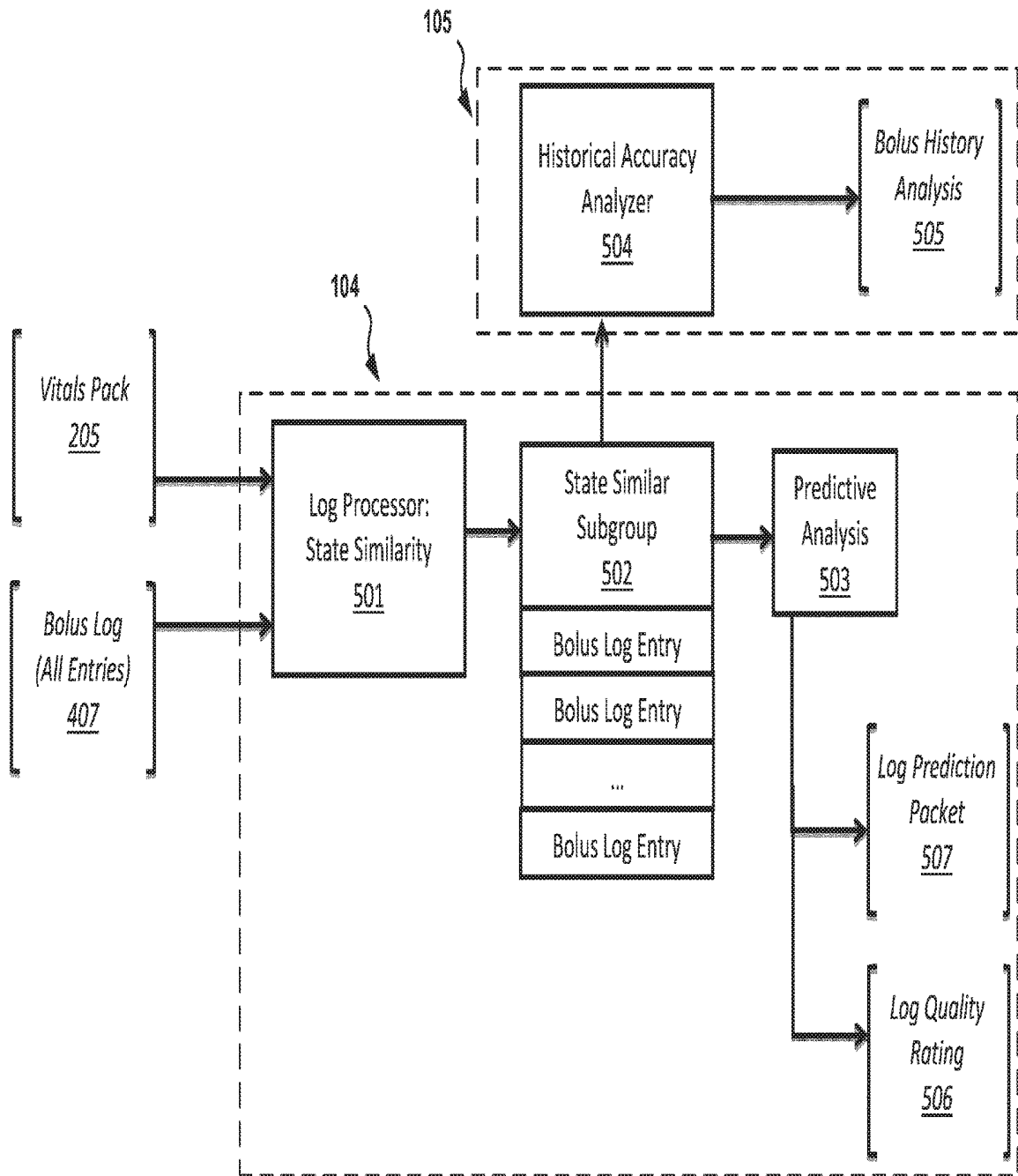

FIG. 5

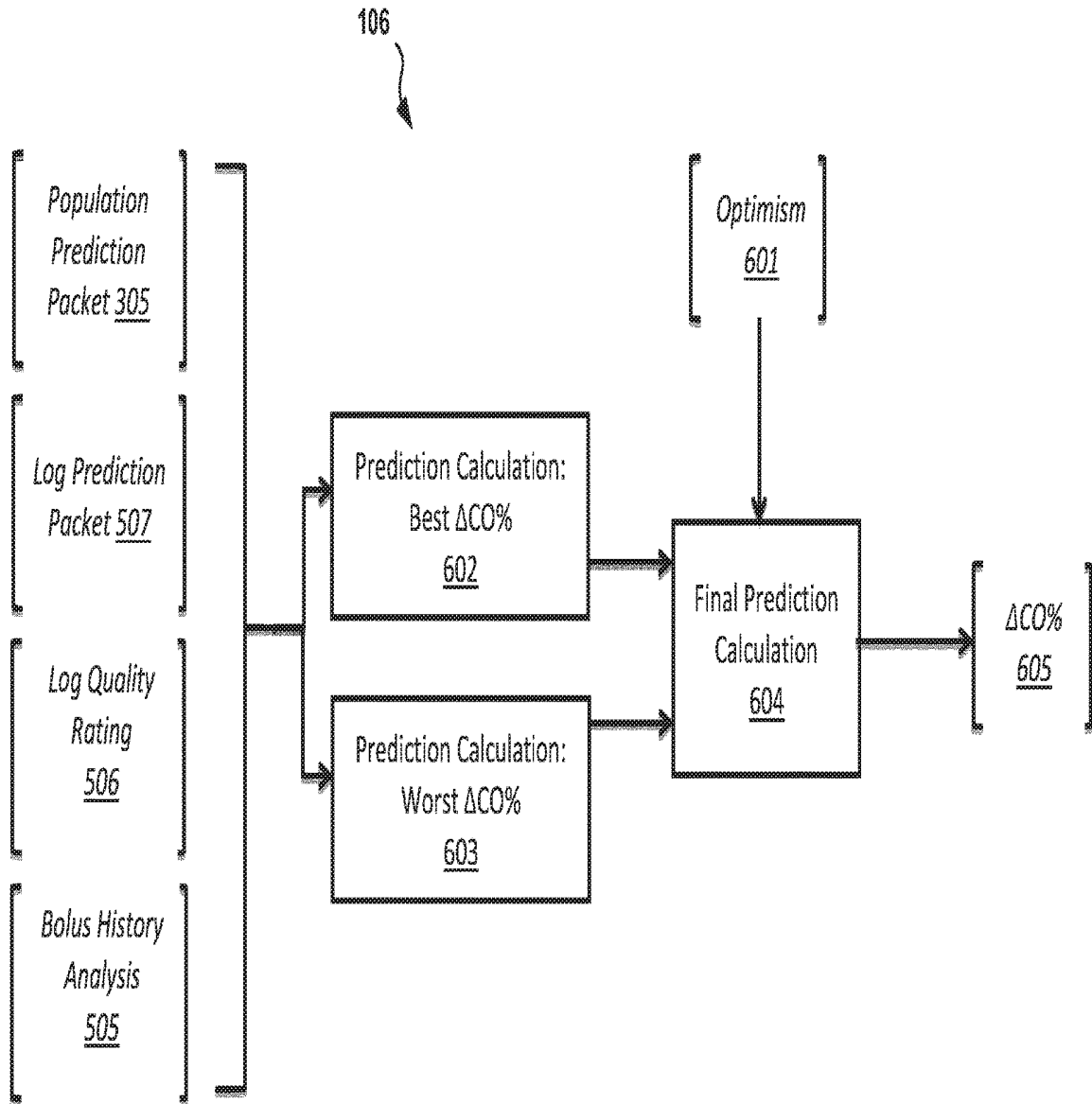

FIG. 6

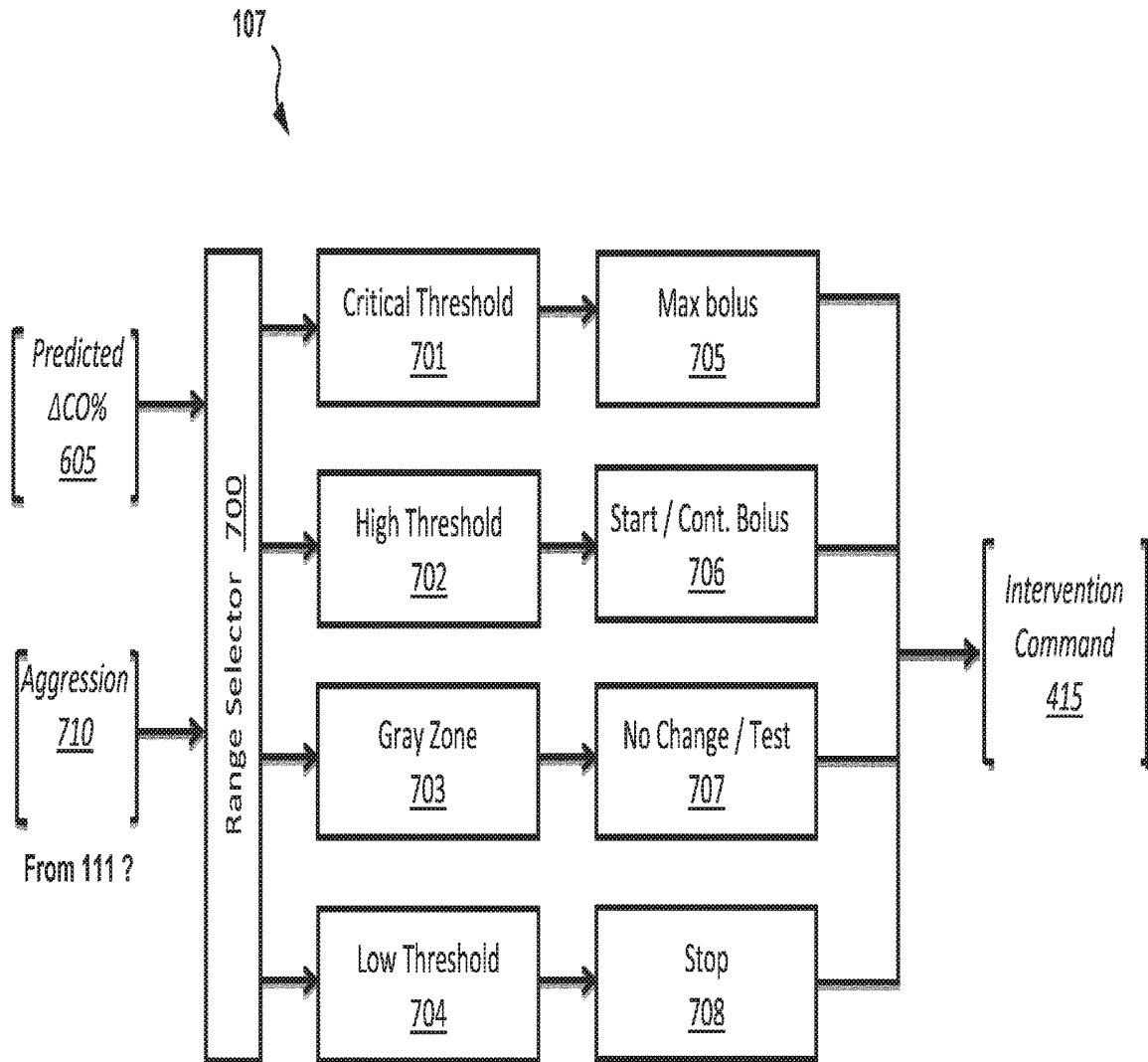

FIG. 7

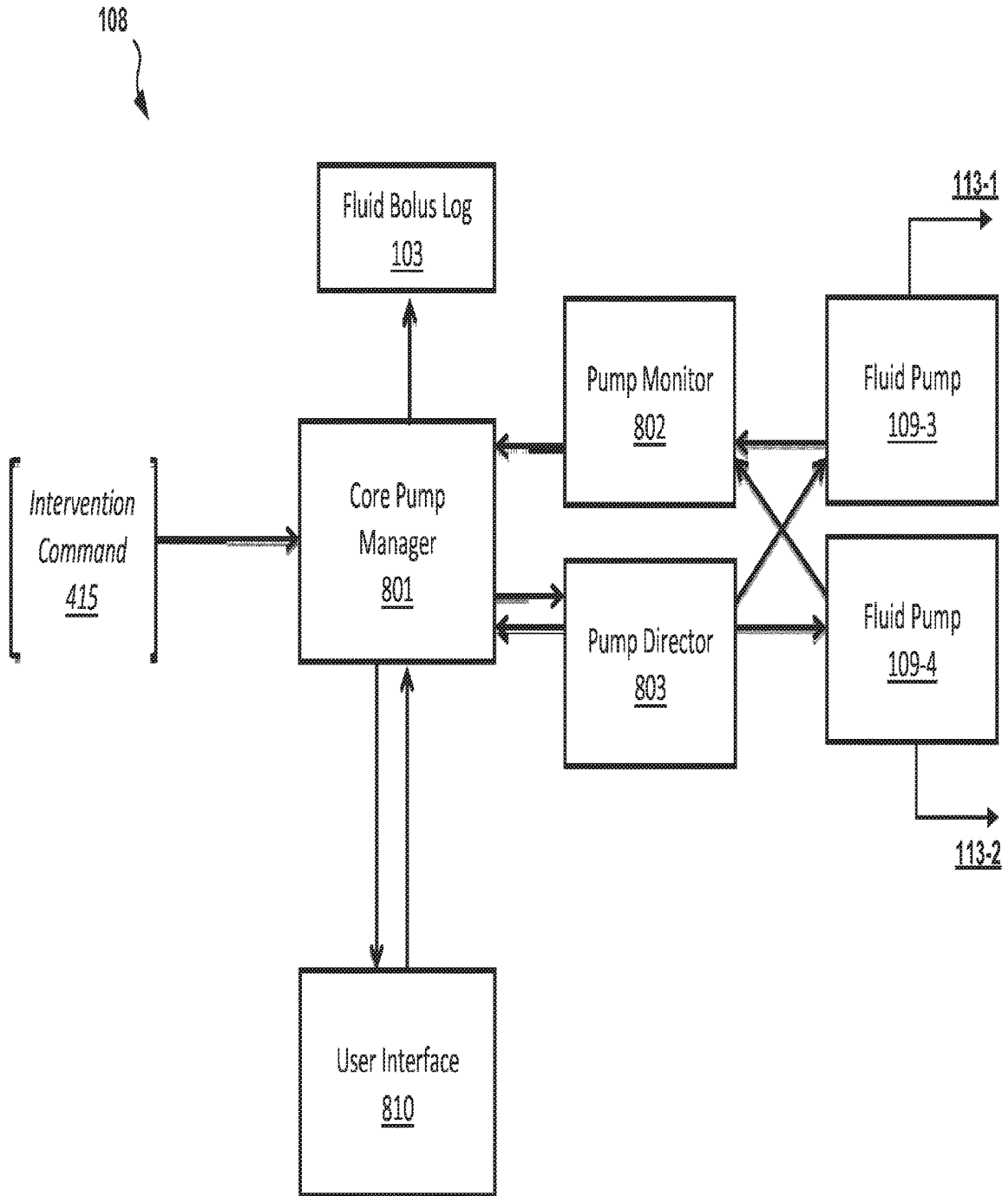

FIG. 8

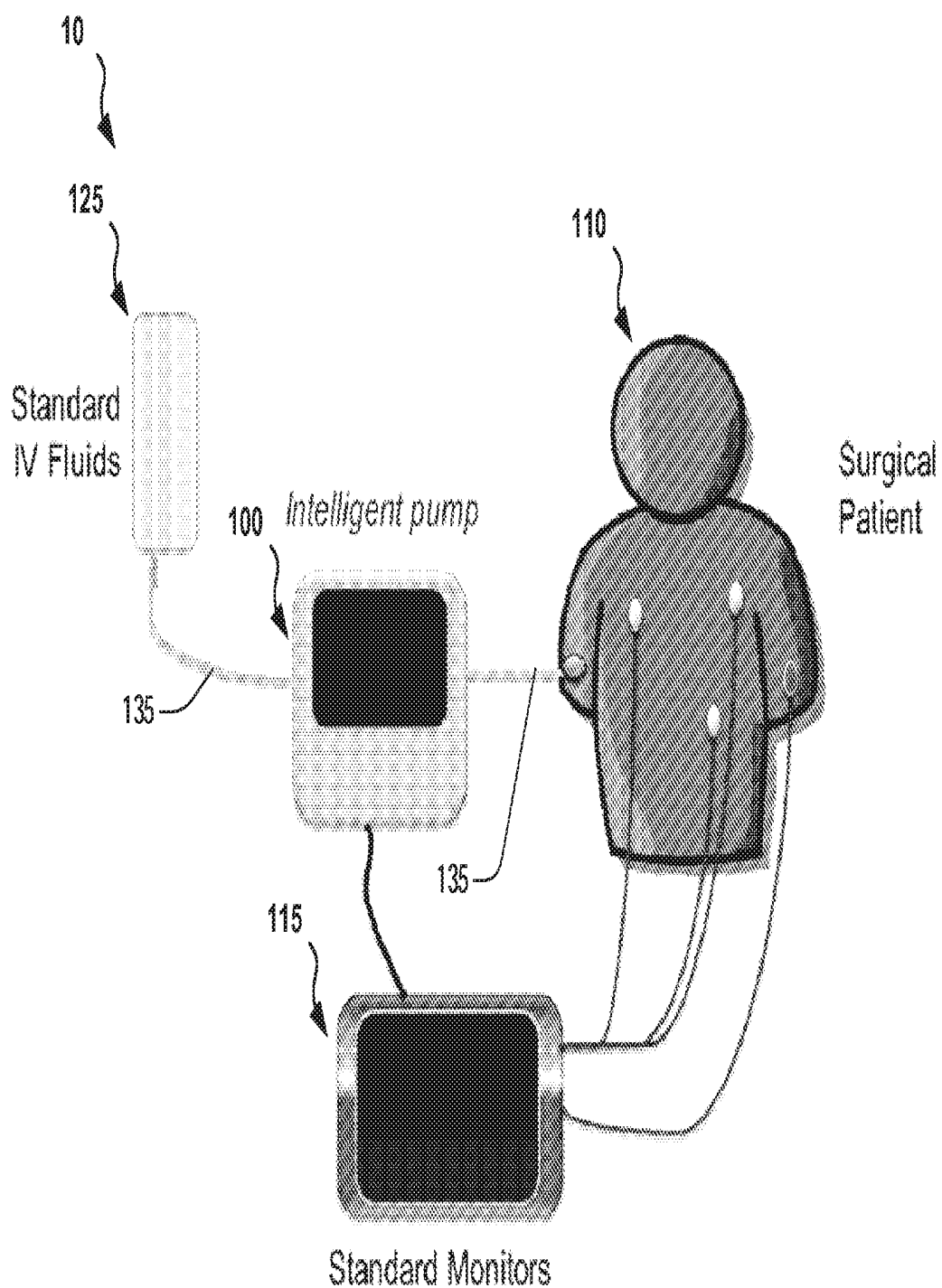
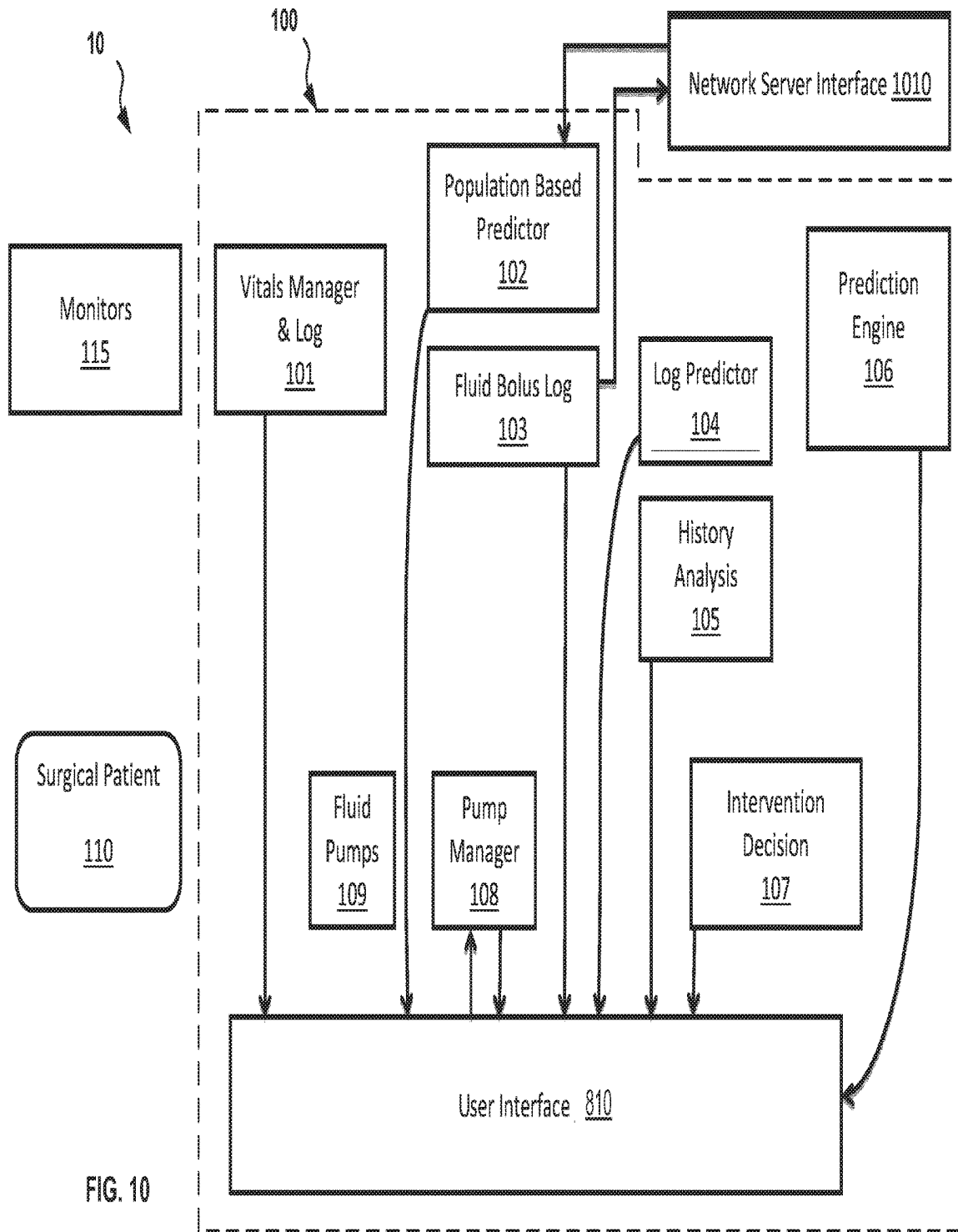

FIG. 9



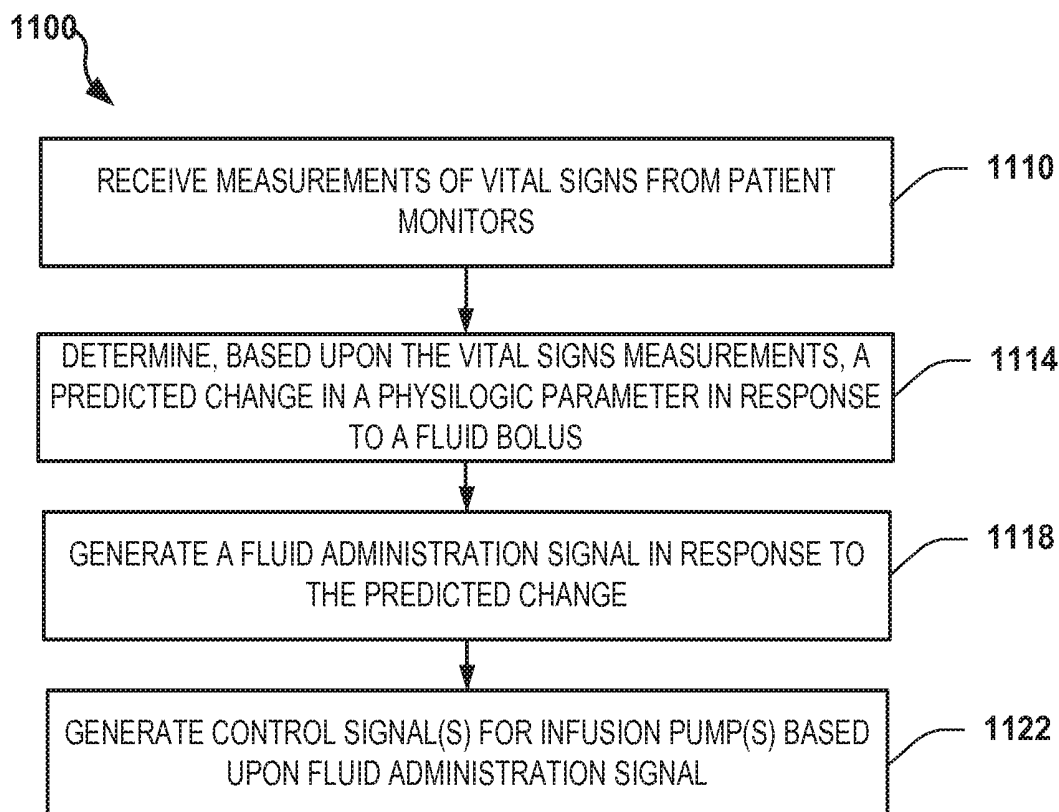

FIG. 11

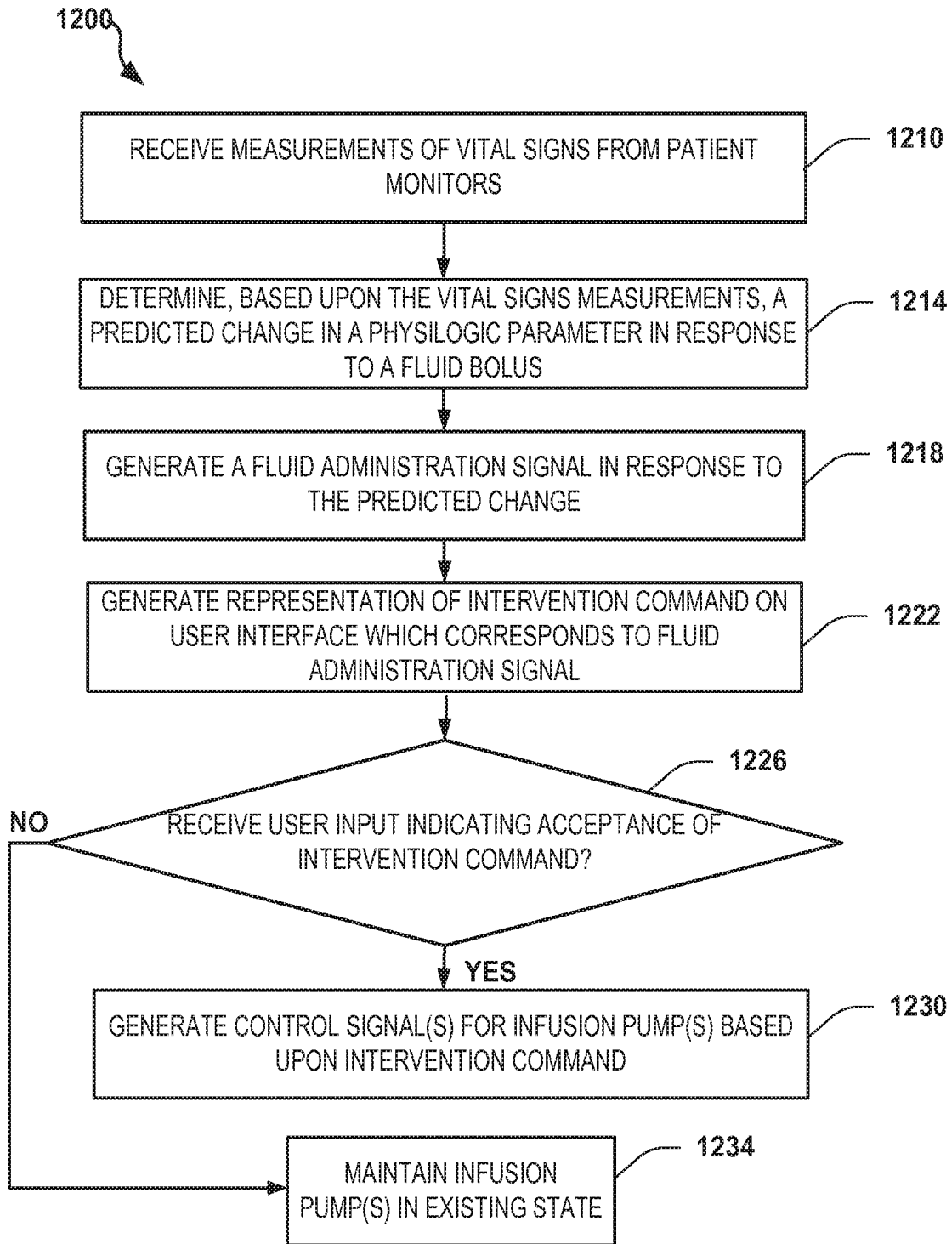

FIG. 12

1300

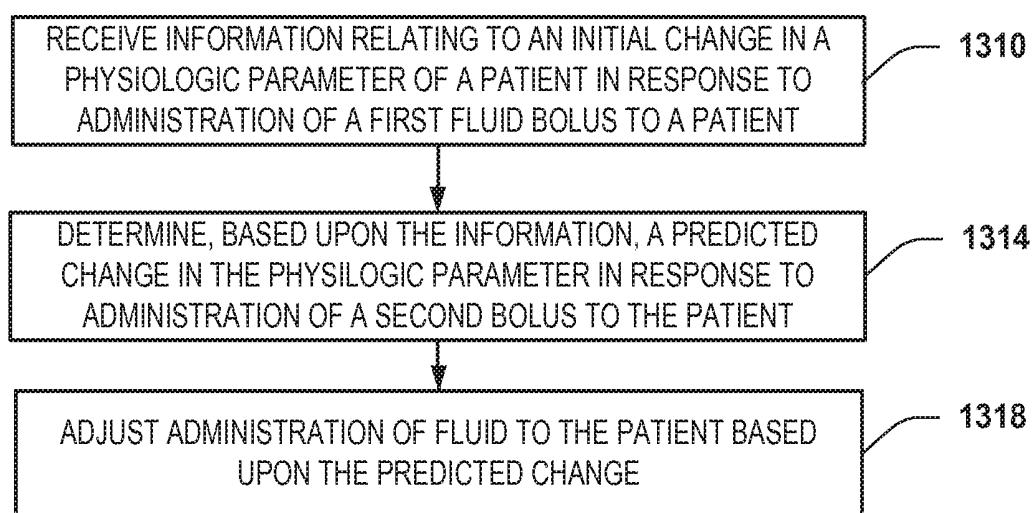

FIG. 13

1400

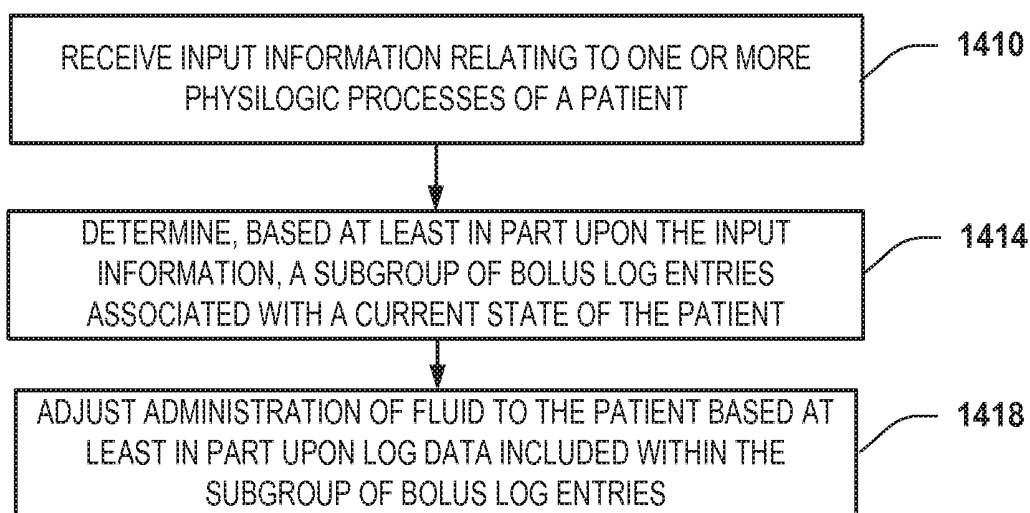

FIG. 14

1500

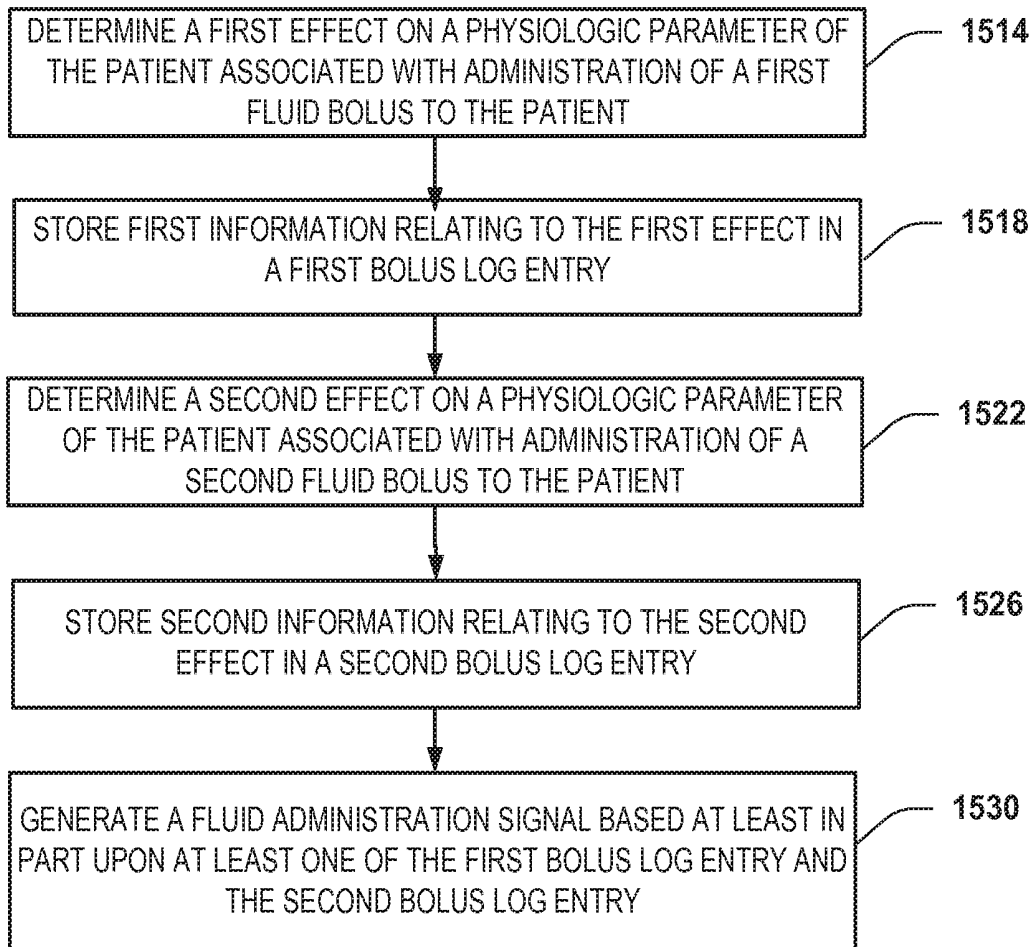

FIG. 15

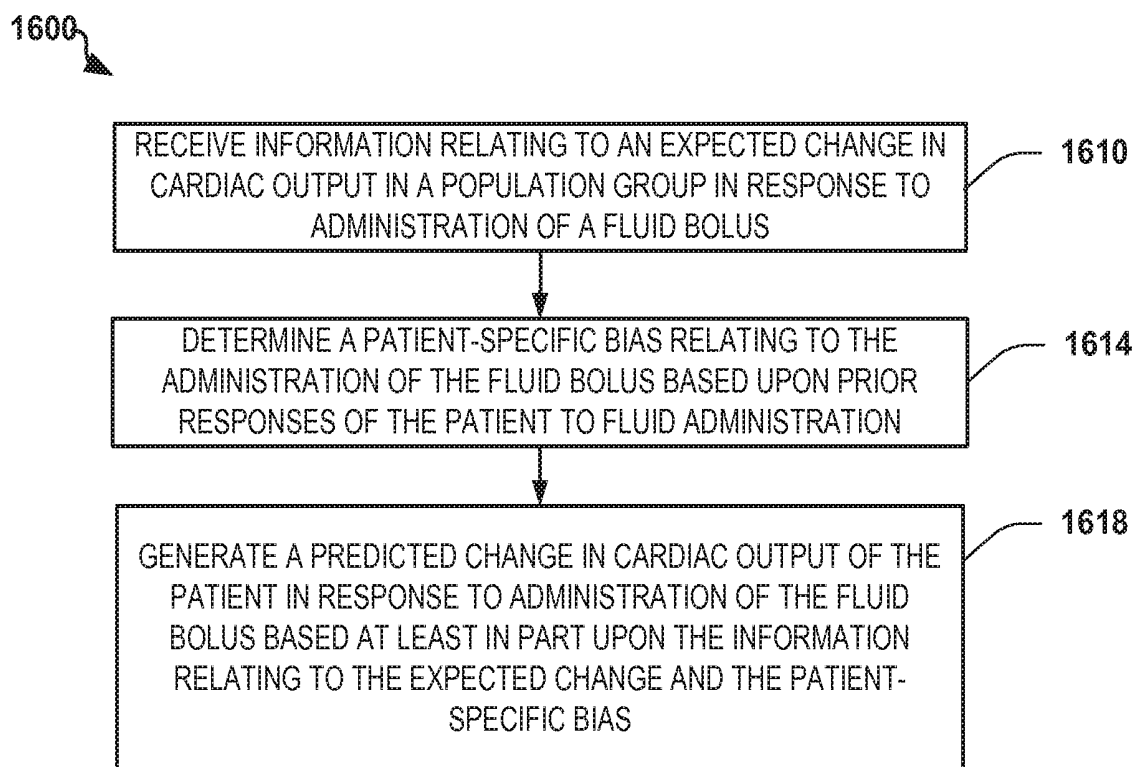

FIG. 16

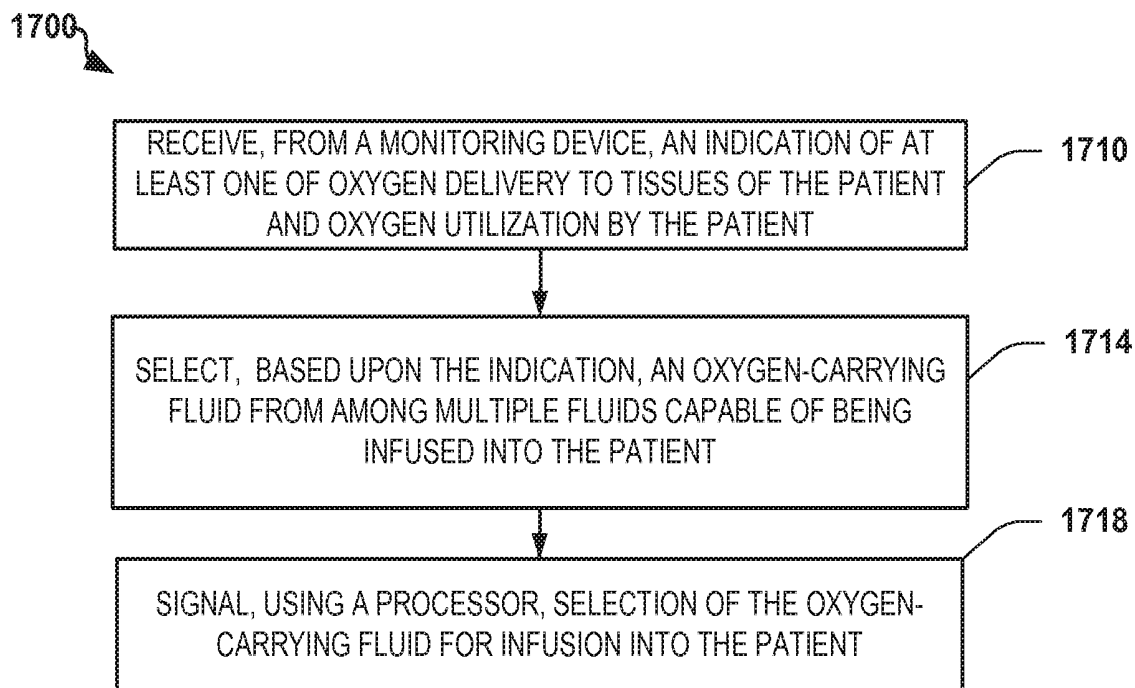

FIG. 17

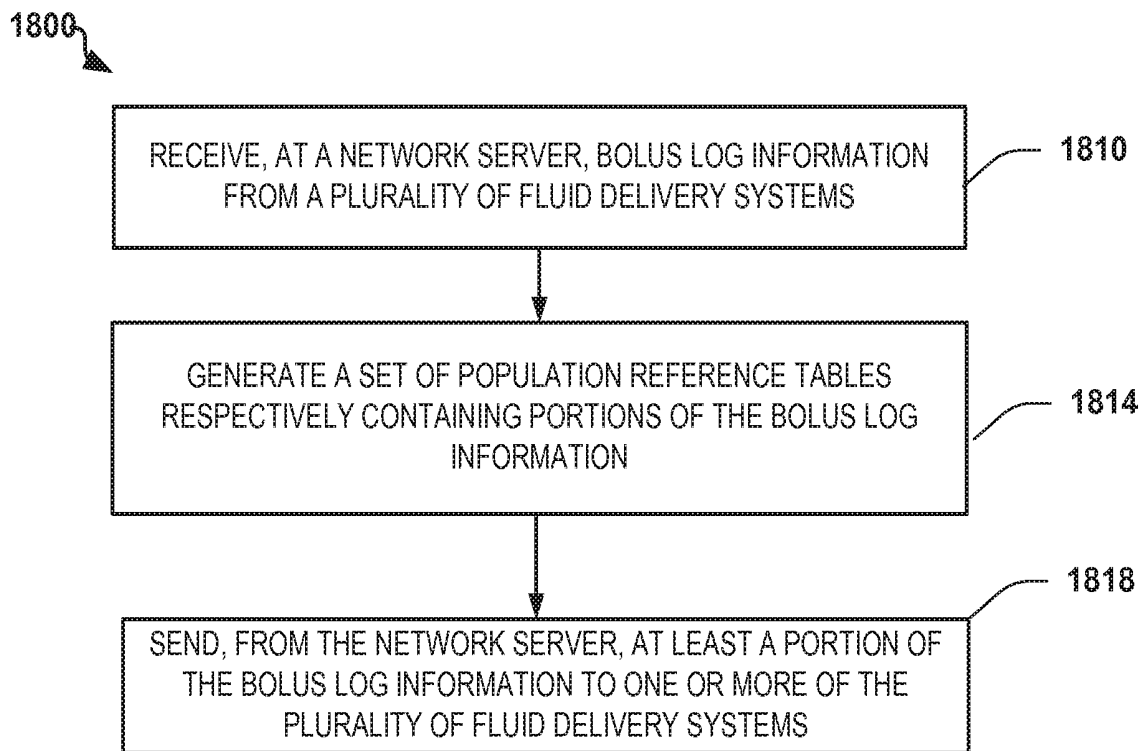

FIG. 18

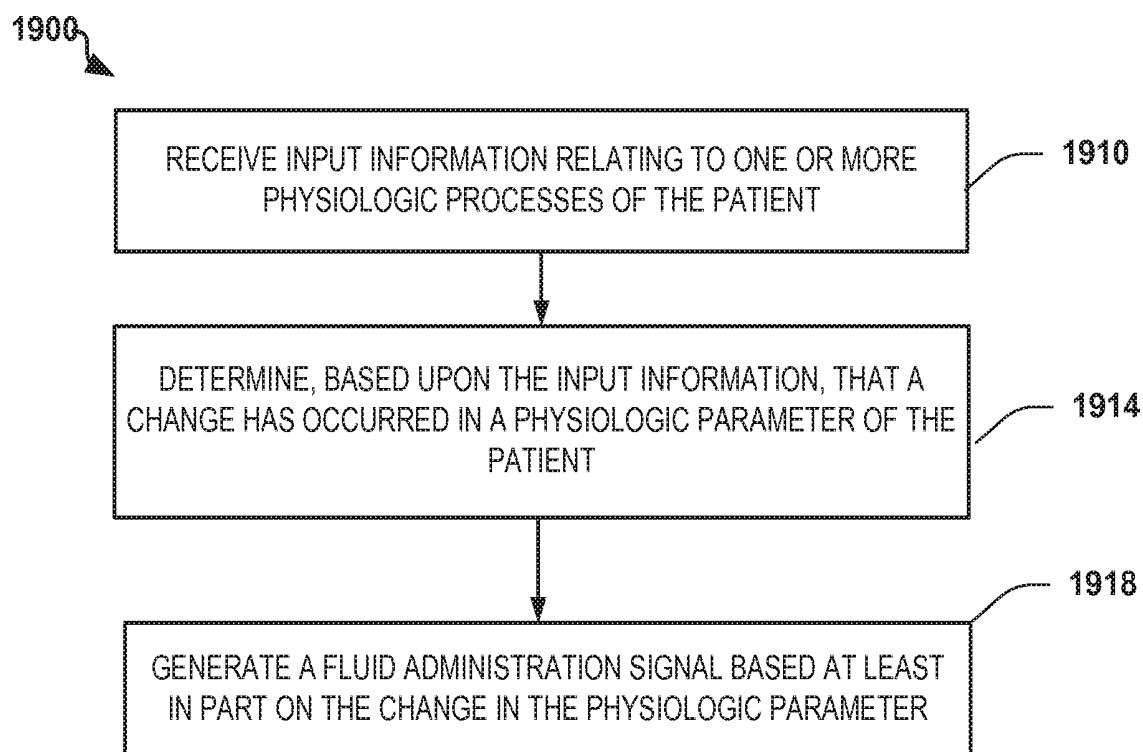

FIG. 19

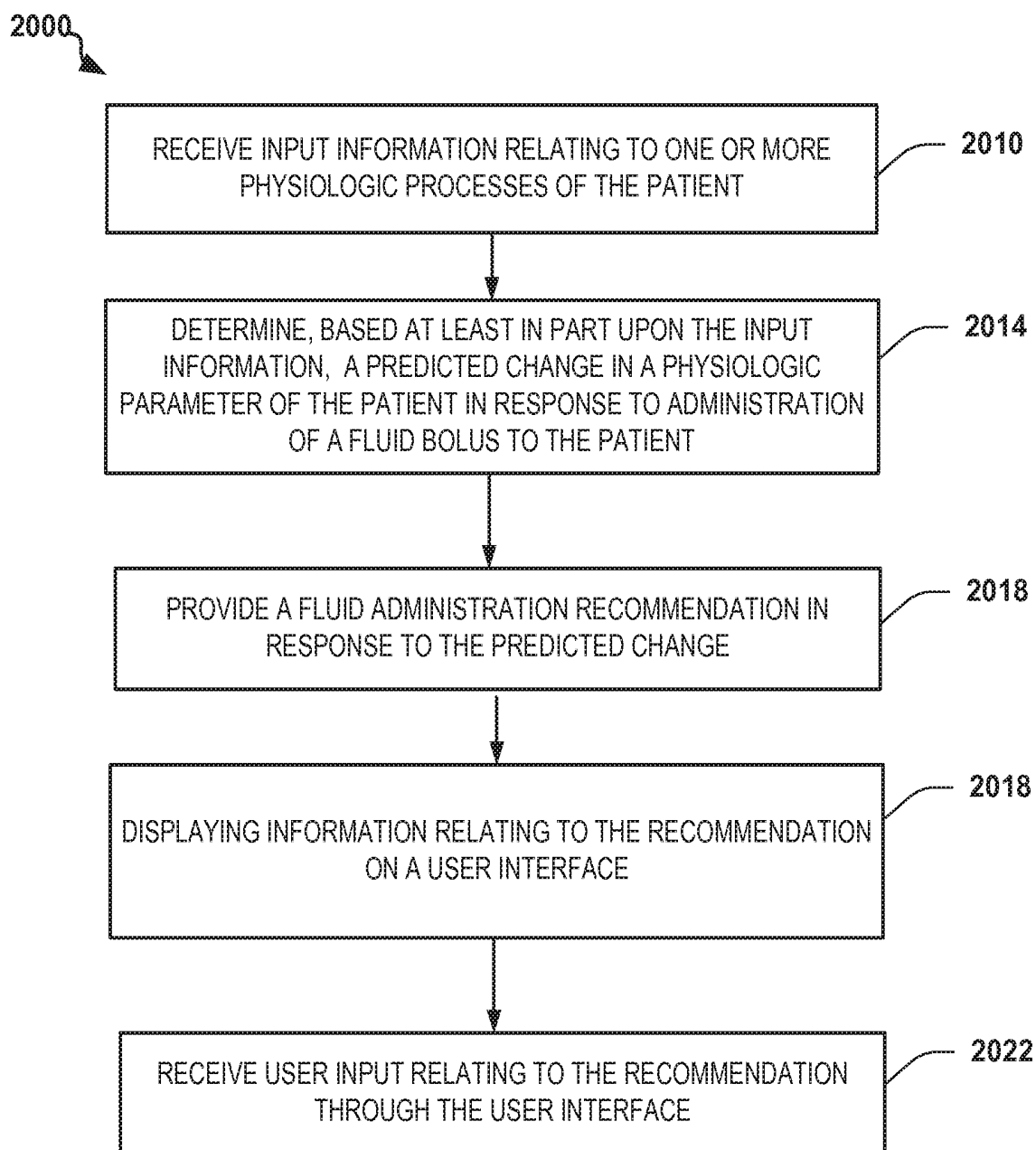

FIG. 20

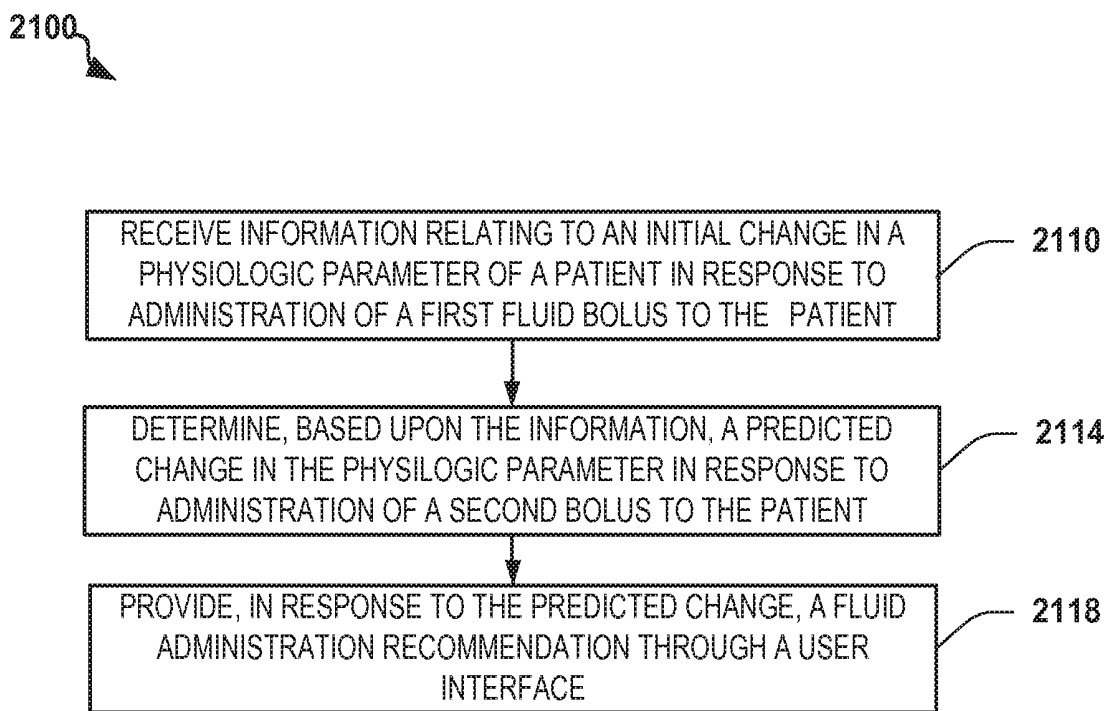

FIG. 21

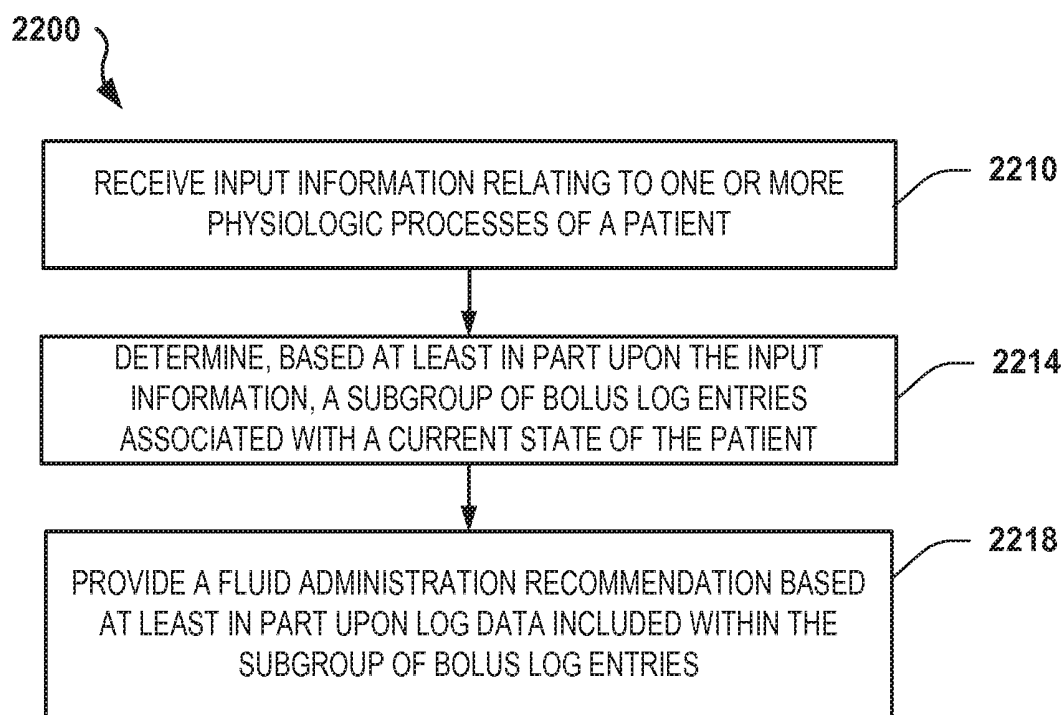

FIG. 22

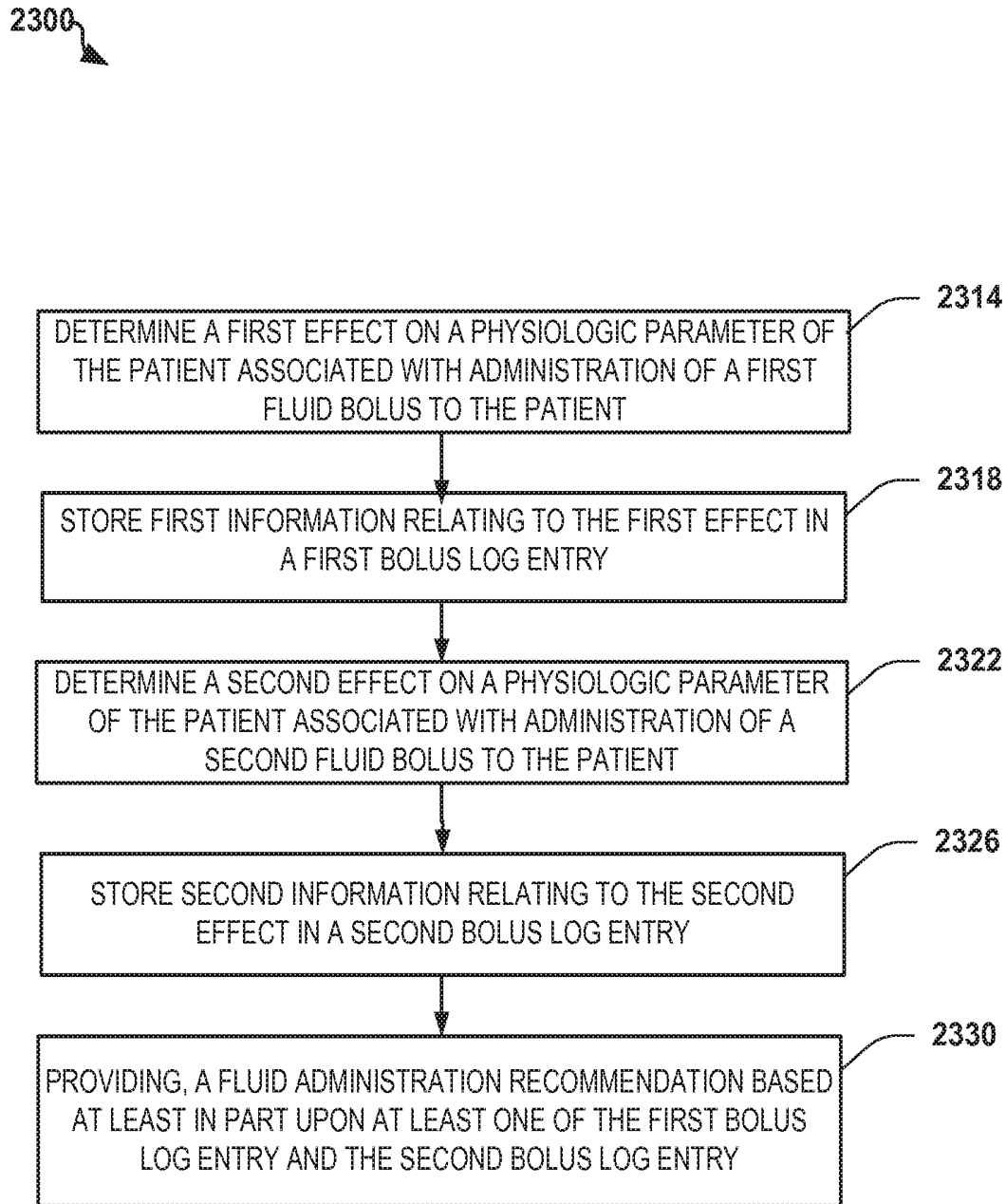

FIG. 23

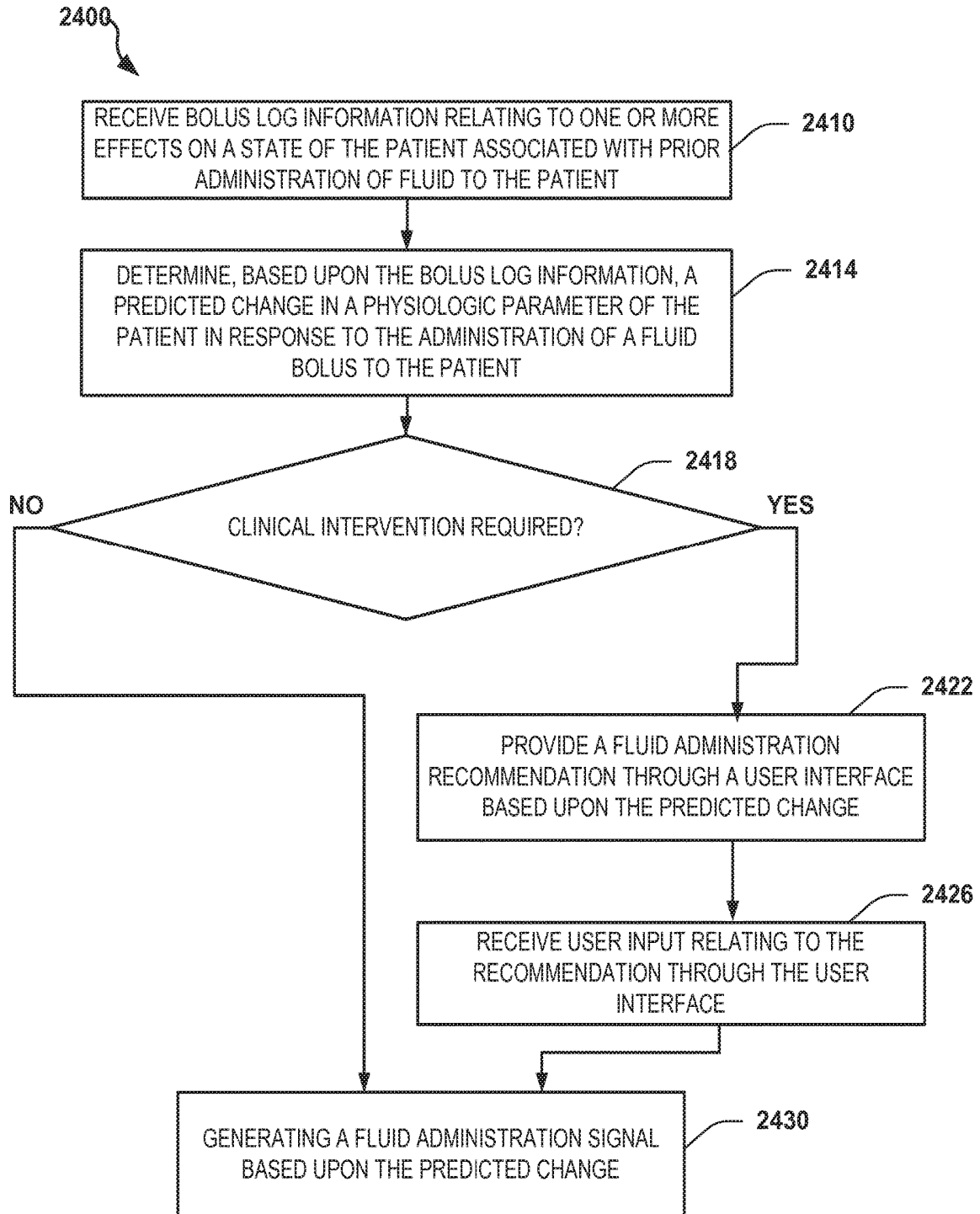

FIG. 24

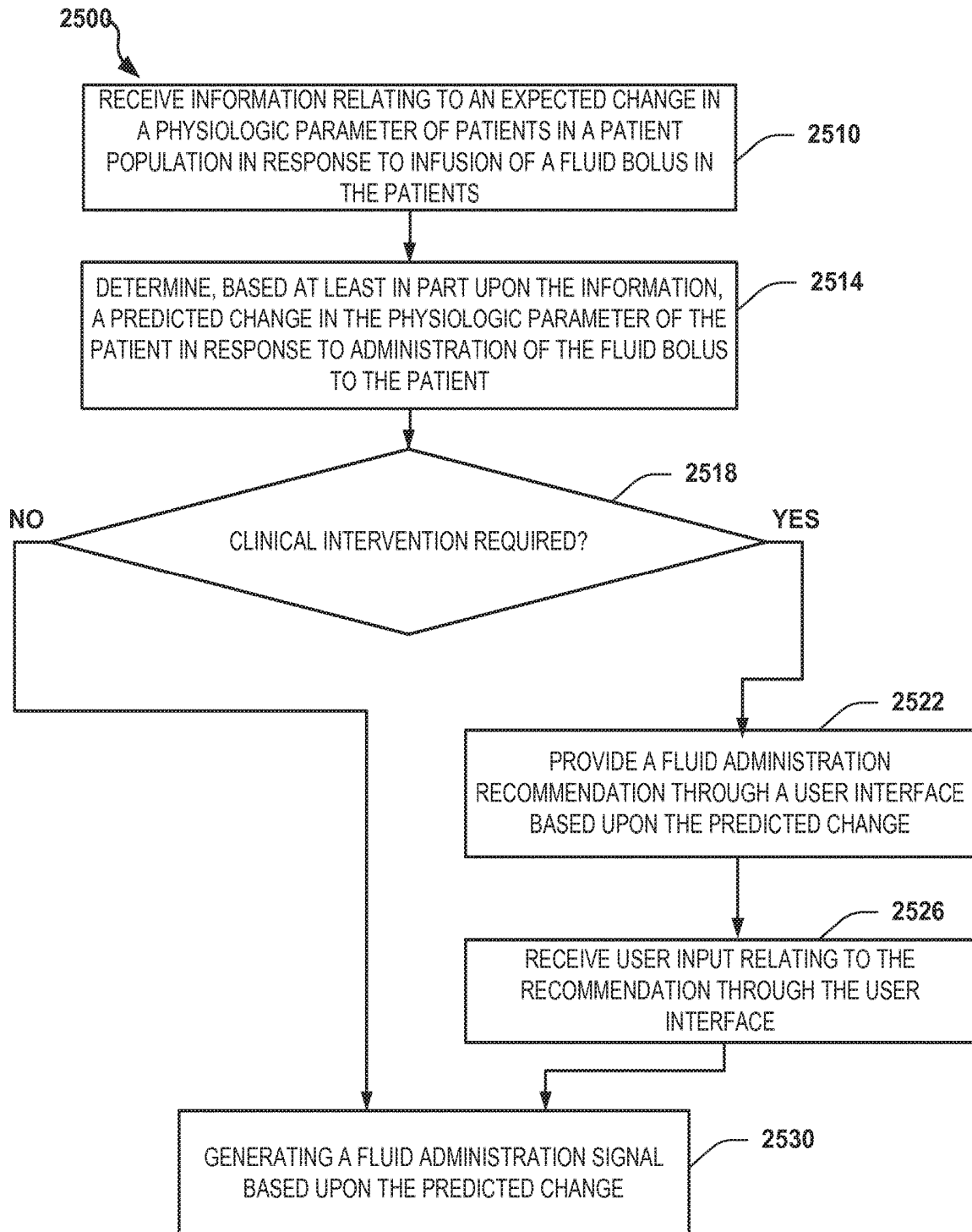

FIG. 25

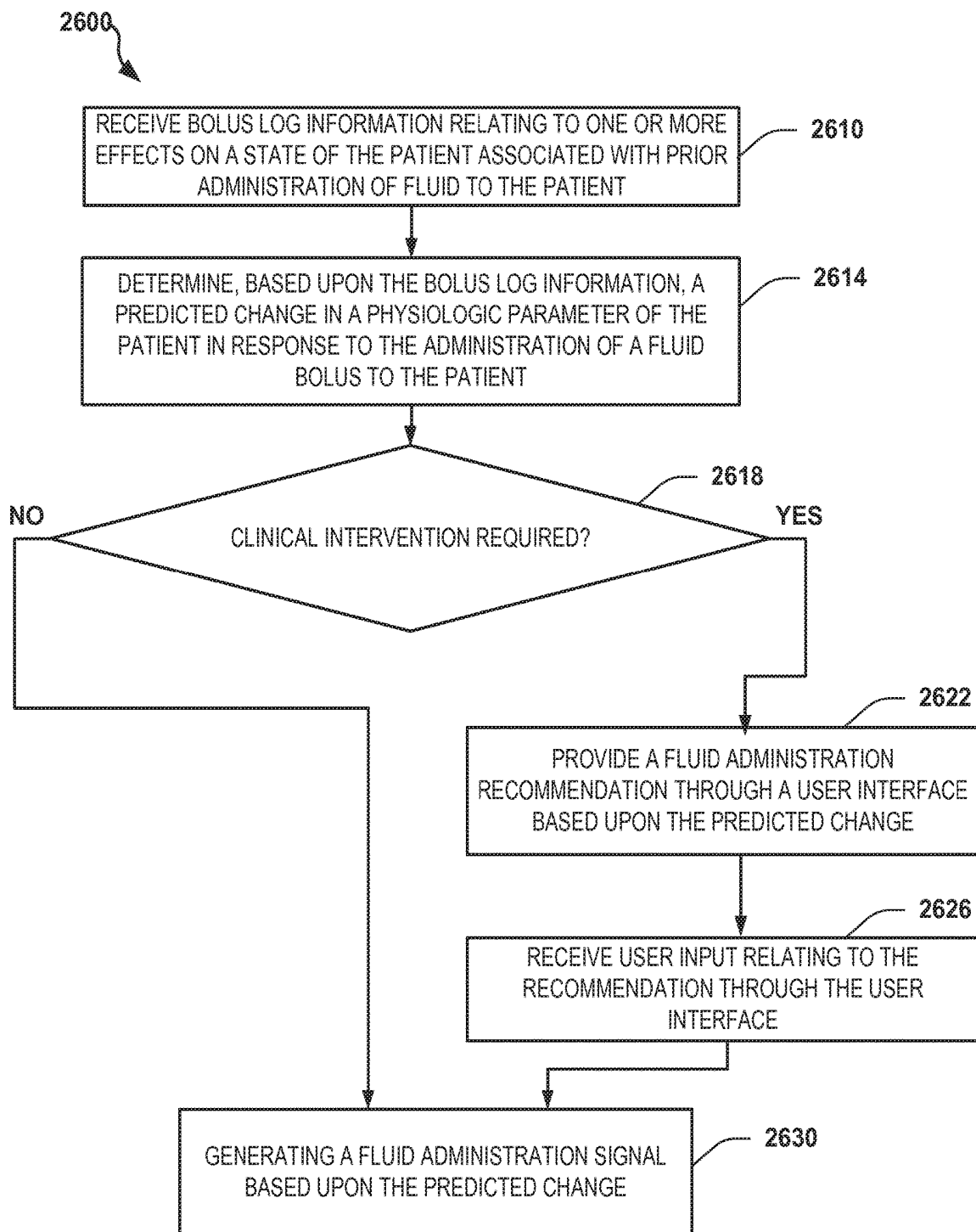

FIG. 26

Table 1: Fluid Management: Practitioners vs. Closed-Loop

Group	(1) Anesthesiologist Managed	(2) Anesthesiologist Managed Pressors, Closed-loop Fluids	(3) Closed-loop Managed	(4) No Management
First Bolus (minutes)	21.5 ±5.6*	15.6 ±1.1	16.0 ±1.3	-
Total Fluid Given (ml)	1968 ±644*	2875 ±275	2675 ±244	-
Mean Arterial Pressure (mmHg)	76 ±4.2	79 ±2.0	79 ±1.1	61 ±6.9
Mean Cardiac Output During Case (L/min)	5.2 ±0.6*	5.8 ±0.2**	5.9 ±0.2**	3.8 ±0.4
Final Cardiac Output (L/min)	4.8 ±1.5*	5.6 ±0.5**	5.7 ±0.4**	1.7 ±0.9
Cardiac Output During Case, Coefficient of Variation (%)	36.7 ±23*	16.6 ±9**	16.3 ±8**	89 ±29

Data are reported as mean +/- standard deviation. * p<0.05 vs. groups 2, 3, and 4. ** p<0.05 vs. groups 1 & 4.

FIG. 27

SYSTEM AND METHOD FOR CLOSED-LOOP PATIENT-ADAPTIVE HEMODYNAMIC MANAGEMENT

CROSS-REFERENCE TO RELATED APPLICATIONS

[0001] The present application is a divisional application of U.S. patent application Ser. No. 13/349,058, filed on Jan. 12, 2012, which claims the benefit of U.S. Provisional Application Ser. No. 61/432,081, filed on Jan. 12, 2011. The contents of each of these applications are hereby incorporated by reference herein in their entirety for all purposes.

FIELD

[0002] The disclosure relates to an apparatus and method for hemodynamic management capable of facilitating fluid administration, transfusion of blood products, and administration of blood pressure supporting medications.

BACKGROUND

[0003] In the past, fluid resuscitation has been approached directly by clinicians using vital signs, or clinical guidelines regarding urine output, for example. Previous automated systems have been tried using either urine output or other physiologic parameters like blood pressure or heart rate, all of which have been unable to accurately predict fluid responsiveness. In some cases trial-and-error was the best option available.

[0004] Although present devices are functional, they are not sufficiently accurate or otherwise satisfactory.

SUMMARY

[0005] In one aspect the disclosure describes a method that incorporates the dynamic predictors of fluid responsiveness (“fluid predictors” i.e. pulse-pressure variation or PPV, stroke volume variation or SVV, parameters derived from the plethysmograph waveform, etc) which have been shown to reliably predict a response to fluid bolus in specific conditions. This allows directed fluid management with the goal of optimizing cardiac output.

[0006] In another aspect, a method is provided that incorporates the dynamic predictors of fluid (“fluid predictors”) responsiveness in conjunction with a patient-adaptive monitoring system that adjusts output based on previous responses represents a substantial improvement over previously proposed automated systems.

[0007] Using a combination of the change in the fluid predictive parameters and the change in cardiac output in response to a bolus allows a very specific measurement of the bias present in a particular patient at a particular time and allows for patient-adaptive responses to be effected. Additionally, using a variety of available vital signs and cardiac output information allows for appropriate administration of blood-pressure supporting pharmacologic agents.

[0008] In another aspect, a method and system is provided comprising a set of processes and a device based on those used to administer IV fluids, blood and medications to patients autonomously.

[0009] In another aspect, an intelligent pump apparatus for delivering fluid to a patient is provided. The intelligent pump apparatus includes an infusion pump device and a controller in electrical communication with the infusion pump device. The controller determines a predicted change in a physi-

ologic parameter of the patient in response to administration of a fluid bolus to the patient and provides a pump control signal to the infusion pump device in response to the predicted change.

[0010] In a further aspect, a device is provided that includes one or more processors and a memory operatively coupled to the one or more processors. The memory of the device stores signals which, when executed by the one or more processors, cause the one or more processors to receive input information relating to one or more physiologic processes of a patient. Further, the signals cause the processor to determine a predicted change in a physiologic parameter of the patient in response to administration of a fluid bolus to the patient where the predicted change is based at least in part on the input information. Yet further, the signals cause the processor to generate a fluid administration signal in response to the predicted change.

[0011] In yet another aspect, an infusion system is provided that includes a pump apparatus and a controller. The pump apparatus controls delivery of fluid to a patient. The controller receives input information relating to one or more physiologic processes of a patient, and determines a predicted change in a physiologic parameter of the patient in response to administration of a fluid bolus to the patient. The predicted change is based at least in part on the input information, and provides a fluid administration signal to the pump apparatus in response to the predicted change.

[0012] In a further aspect, a device is provided that includes one or more processors and a memory operatively coupled to the one or more processors. In the device of this aspect, the memory stores signals which, when executed by the one or more processors, cause the one or more processors to receive information relating to an initial change in a physiologic parameter of a patient in response to administration of a first fluid bolus to a patient. The signals further cause the one or more processors to determine, based at least in part upon the information, a predicted change in the physiologic parameter in response to an administration of a second bolus, and to adjust administration of fluid to the patient based upon the predicted change.

[0013] In yet another aspect, an infusion system includes a pump apparatus configured to control delivery of fluid to a patient and a controller. The controller receives information relating to an initial change in a physiologic parameter of a patient in response to administration of a first fluid bolus to a patient. The controller then determines, based at least in part upon the information, a predicted change in the physiologic parameter in response to an administration of a second bolus, and the controller adjusts a fluid administration signal provided to the pump apparatus based upon the predicted change.

[0014] In still another aspect, an intelligent pump apparatus for delivering fluid to a patient is provided. The intelligent pump apparatus includes an infusion pump device and a monitoring interface. The monitoring interface receives, from a monitoring device, an indication of at least one of oxygen delivery to tissues of the patient and oxygen utilization by the patient. The intelligent pump apparatus also includes a controller in electrical communication with the infusion pump device. The controller is configured to select, based upon the indication, an oxygen-carrying fluid from among multiple fluids capable of being infused into the patient and to instruct the infusion pump device to infuse the oxygen-carrying fluid into the patient.

[0015] In a further aspect, a system is provided that includes: 1) a means of calculating the expected increase in cardiac output in the general population in response to a fluid bolus given a specific set of physiologic parameters. This calculation is based on previously published and unpublished data; 2) a means of calculating the expected increase in cardiac output in a specific patient given a specific set of physiologic parameters and data collected from previous fluid administrations; 3) a means of calculating bias, artifact, and error in the response to fluid, in part based on the difference between the change in actual cardiac output and the change in the dynamic predictor and the predictable relationship between the two; 4) calculations for determining whether or not blood pressure supporting medications are indicated, and if so how much; and 5) calculations for determining whether or not blood product administration is indicated, and if so how much.

[0016] In yet a further aspect, a clinical device is provided that is capable of administering fluids, blood products, and medications based on the algorithms above, monitoring the patient response, and displaying the monitored information in a specific and novel way to the practitioner. One purpose of this device is to automate and standardize administration of intravenous fluids, blood products, and blood-pressure supporting medications to assist clinicians with the eventual goal of improving outcomes.

[0017] In an additional aspect, an apparatus for hemodynamic and cardiac output management in a patient is provided, comprising a computer readable storage medium storing instructions to perform a method of managing hemodynamic and cardiac output in a patient, the method comprising the steps of determining, given a set of available physiologic data obtained from patient monitoring devices, which parameters to use and in what combinations to predict fluid responsiveness; and determining the expected increase in cardiac output in the general population in response to a fluid bolus of specific size given the chosen set of physiologic parameters; and determining patient-specific bias in the response to said fluid based on the patient's prior responses to fluid administration.

[0018] The apparatus may further comprise detecting and filtering artifact in the monitored data; and detecting and filtering error in the patient bias using the strong relationship between the predictive parameters and their response to fluid administration, especially to detect ongoing bleeding or fluid shifts which might influence bias.

[0019] The apparatus may also comprise dynamically adapting to specific patients using the known biases in conjunction with associated physiologic parameters, their means and standard deviations in relationship to one another, and observed responses to previous interventions by the apparatus; determining whether blood-pressure supporting medications are indicated and if so administer them, again monitoring responses and adapting to the patient, and determining whether blood product administration is indicated and if so administer them.

[0020] The apparatus may be further configured such that adaptation and learning is further enhanced by data shared between devices over time to improve population expectations and the processes of the apparatus.

[0021] The apparatus may be further configured such that the adapting process is concerned not only with adjustments to the fluid administration volume and threshold and to the medication administration dose and threshold, but also with

automatic adjustments to the weight of each measured parameter in decision-making by the apparatus.

[0022] The apparatus may further comprise pumps capable of injecting fluid or medication into said patient.

[0023] The apparatus may be further configured to operate, in real time and without operator interaction, to automatically adjust the anticipated response to a new bolus based on the bias information in a state-dependent fashion.

[0024] In yet another aspect, a method for hemodynamic and cardiac output management in a patient is provided comprising: obtaining physiologic data from a patient, injecting fluid, medications, or blood products into a patient as indicated, measuring the results of said interventions in said patient, adapting future interventions based on data collected from previous interventions said fluid to said patient.

[0025] Those skilled in the art can readily recognize that numerous variations and substitutions may be made in the invention, its use and its configuration to achieve substantially the same results as achieved by the embodiments described herein. Accordingly, there is no intention to limit the invention to the disclosed exemplary forms. Many variations, modifications and alternative constructions fall within the scope and spirit of the disclosed invention as expressed in the claims.

[0026] As previously stated, the above-described embodiments and implementations are for illustration purposes only. Numerous other embodiments, implementations, and details of the invention are easily recognized by those of skill in the art from the following descriptions and claims.

BRIEF DESCRIPTION OF THE DRAWINGS

[0027] Various objects and advantages and a more complete understanding of the present invention are apparent and more readily appreciated by reference to the following Detailed Description and to the appended claims when taken in conjunction with the accompanying Drawings wherein:

[0028] FIG. 1A illustrates details of an exemplary patient-adaptive hemodynamic management system in accordance with the disclosure;

[0029] FIG. 1B illustrates details of an embodiment of a control device that can be used, for example, in the system of FIG. 1A;

[0030] FIG. 2 illustrates details of an embodiment of a vitals manager and log component that can be used, for example, in the control device of FIG. 1B;

[0031] FIG. 3 illustrates details of an embodiment of a population based predictor component that can be used, for example, in the control device of FIG. 1B;

[0032] FIG. 4 illustrates details of an embodiment of a fluid bolus log component that can be used, for example, in the control device of FIG. 1B;

[0033] FIG. 5 illustrates details of an embodiment of a log predictor component and an embodiment of a history analysis component that can be used, for example, in the control device of FIG. 1B;

[0034] FIG. 6 illustrates details of an embodiment of a prediction engine that can be used, for example, in the control device of FIG. 1B;

[0035] FIG. 7 illustrates details of an embodiment of an intervention decision component that can be used, for example, in the control device of FIG. 1B;

[0036] FIG. 8 illustrates details of an embodiment of a pump manager component that can be used, for example, in the control device of FIG. 1B;

[0037] FIG. 9 illustrates details of another exemplary patient-adaptive hemodynamic management system in accordance with the disclosure;

[0038] FIG. 10 illustrates information flow between various components of the patient-adaptive hemodynamic management system of FIG. 1A;

[0039] FIG. 11 is a flowchart depicting an exemplary method of providing patient-adaptive hemodynamic management in accordance with the disclosure;

[0040] FIG. 12 is a flowchart depicting an exemplary method of providing patient-adaptive hemodynamic management including a user intervention in accordance with the disclosure;

[0041] FIG. 13 is a flowchart depicting another exemplary method of providing patient-adaptive hemodynamic management in accordance with the disclosure;

[0042] FIG. 14 is a flowchart depicting another exemplary method of providing patient-adaptive hemodynamic management in accordance with the disclosure;

[0043] FIG. 15 is a flowchart depicting another exemplary method of providing patient-adaptive hemodynamic management in accordance with the disclosure;

[0044] FIG. 16 is a flowchart depicting another exemplary method of providing patient-adaptive hemodynamic management in accordance with the disclosure;

[0045] FIG. 17 is a flowchart depicting another exemplary method of providing patient-adaptive hemodynamic management in accordance with the disclosure;

[0046] FIG. 18 is a flowchart depicting another exemplary method of providing patient-adaptive hemodynamic management in accordance with the disclosure;

[0047] FIG. 19 is a flowchart depicting another exemplary method of providing patient-adaptive hemodynamic management in accordance with the disclosure;

[0048] FIG. 20 is a flowchart depicting another exemplary method of providing patient-adaptive hemodynamic management in accordance with the disclosure;

[0049] FIG. 21 is a flowchart depicting another exemplary method of providing patient-adaptive hemodynamic management in accordance with the disclosure;

[0050] FIG. 22 is a flowchart depicting another exemplary method of providing patient-adaptive hemodynamic management in accordance with the disclosure;

[0051] FIG. 23 is a flowchart depicting yet another exemplary method of providing patient-adaptive hemodynamic management in accordance with the disclosure;

[0052] FIG. 24 is a flowchart depicting another exemplary method of providing patient-adaptive hemodynamic management including a clinical intervention in accordance with the disclosure;

[0053] FIG. 25 is a flowchart depicting another exemplary method of providing patient-adaptive hemodynamic management including a clinical intervention in accordance with the disclosure;

[0054] FIG. 26 is a flowchart depicting yet another exemplary method of providing patient-adaptive hemodynamic management including a clinical intervention in accordance with the disclosure;

[0055] FIG. 27 is a summary of results from initial studies using the methodology of the control device in simulations.

[0056] In the appended figures, similar components and/or features may have the same reference label. Further, various components of the same type may be distinguished by following the reference label by a dash and a second label that distinguishes among the similar components. If only the first reference label is used in the specification, the description is applicable to any one of the similar components having the same first reference label irrespective of the second reference label.

DETAILED DESCRIPTION

[0057] The contents of each of the following applications are incorporated by reference herein in their entirety for all purposes: U.S. application Ser. No. 13/349,168, U.S. application Ser. No. 13/349,114, and U.S. application Ser. No. 13/349,012, all filed on Jan. 12, 2012.

[0058] An intelligent, closed-loop, patient-adaptive hemodynamic management system and method are provided to monitor hemodynamic parameters, including those predictive of fluid responsiveness, the system being capable of fluid administration, transfusion of blood products, and administration of blood pressure supporting medications based on those parameters in conjunction with patient-adaptive algorithms as well as pooled patient data, and displaying the monitored parameters in a way easily interpreted by practitioners.

[0059] The system and method provided are based on hemodynamic monitoring including dynamic parameters of fluid responsiveness ('fluid predictors') derived from arterial pressure waveform, plethysmograph wave form, thoracic ultrasound, bioimpedance, bioactance or EKG waveform, for example.

[0060] This control device and process are designed to utilize, among other physiologic data, the dynamic predictors of fluid responsiveness ('fluid predictors'). As there are several described parameters that meet these criteria such as, for example, pulse-pressure variation (PPV), stroke volume variation (SVV), plethysmograph variability, and EKG waveform characteristics, the description will simply refer to the group as the "Fluid Predictors" or FP. This term should be taken to mean any of the described predictors of fluid responsiveness.

[0061] Additionally, all of the physical values and constants in the disclosure are subject to change based on results of ongoing studies as the device and algorithm are refined; values contained herein should be taken to be exemplary at the time of this writing.

[0062] Other terms and abbreviations used herein include:

[0063] CO—Cardiac output

[0064] Patient or Subject—the "patient" or "subject" is the organism being monitored by and managed by the system. In one embodiment, the patient is a human being. In another embodiment, the patient may be any mammal, reptile, amphibian, or bird of sufficient size to make intravascular resuscitation an appropriate strategy for management of cardiac output and oxygen delivery.

[0065] Vital Signs or Vitals—Any statistical measure of a physiologic process taking place in a patient—including waveforms derived from physiologic processes. Vitals can include, for example:

[0066] Heart Rate (HR)—the number of ventricular contractions per minute

- [0067] Stroke Volume (SV)—the volume of blood ejected by the left ventricle during contraction in milliliters.
- [0068] Systolic Blood Pressure (SBP)—the highest blood pressure felt in the systemic arterial vascular tree during a cardiac cycle.
- [0069] Diastolic Blood Pressure (DBP)—the lowest blood pressure felt in the systemic arterial vascular tree during a cardiac cycle.
- [0070] Mean Arterial Pressure (MAP)—the average blood pressure in the systemic arterial system over one or more cardiac cycles, typically calculated as $((SBP+DBP+DBP)/3)$.
- [0071] Systemic Vascular Resistance (SVR)—An index of arteriolar constriction throughout the body measured in $\text{dyn}\cdot\text{s}/\text{cm}^5$
- [0072] Cardiac Output—the total volume of blood ejected by the left ventricle over one minute
- [0073] Dynamic Predictor (DP)—one or more measures of preload dependence derived from the arterial pressure waveform, plethysmograph waveform, EKG waveform, thoracic ultrasound, bioimpedance, bioreactance, and including specific maneuvers such as passive leg raising and tele-expiratory pause. As there are several described parameters that meet this criteria (pulse-pressure variation, stroke volume variation, plethysmograph variability, EKG waveform variation in lead II, and more) the phrase Dynamic Predictor will be understood to represent any one or more of the measures in this group. The term fluid predictor may be used interchangeably with the term Dynamic Predictor in the present disclosure.
- [0074] Intravenous fluid (IV Fluid)—any fluid intended for administration intravenously to a monitored subject for the purpose of intravascular volume expansion or increasing oxygen delivery. IV Fluid would therefore include, but not be limited to: crystalloid solutions like Lactated Ringer's Solution, Normal Saline, Dextrose Solutions, Plasmalyte, and in general balanced salt solutions and sugar solutions; colloidal solutions like albumins, starches, and similar; and blood products and blood analogs like whole blood, platelets, fresh frozen plasma, cryoprecipitate, packed red blood cells, salvaged cellular solutions, or any substitutes meant to mimic or replace these products.
- [0075] Fluid bolus—an administration of a specific volume of IV Fluid over a discrete timespan.
- [0076] Supervisor (system supervisor, user)—a human user who monitors system operation, and who may, in one embodiment, accept or reject system recommendations before the system acts on those recommendations, and who may, in another embodiment, at any time, override system operation in favor of a user directed action.
- [0077] "Efficacy" of a Fluid Bolus—the degree to which the intravascular administration of said fluid increases the cardiac output; or the degree to which the intravascular administration of said fluid improves the delivery of oxygen to the tissues, for example.
- [0078] Prediction—the calculated percent increase in cardiac output that a fluid bolus would be expected to cause in the patient.
- [0079] Vasoactive Medications—medications controlled by the system that could include those intended to manipulate blood pressure and cardiac output such as, for example, ephedrine, phenylephrine, norepinephrine, epinephrine (adrenaline), dopamine, dobutamine, milrinone, dopexamine, nitroglycerine, nitroprusside, and other vasopressors, inotropes, and vasodilators.
- [0080] With reference to FIG. 1A, a patient-adaptive hemodynamic management system 10 includes a control device 100 coupled via electronic interfaces (not shown) to a first fluid pump 109-1 and a second fluid pump 109-2. The control device 100 includes a display 120. The display 120 includes a display screen, electronics and interfaces coupled to the first and second fluid pumps 109-1 and 109-2. The first fluid pump 109-1 is coupled to fluid sources such as, for example, IV bags 125 containing any of various IV fluids. The second fluid pump 109-2 is coupled to medications such as, for example, medication vials 130 containing fluid medications. The IV bags 125 and medication vials 130 are fluidically coupled to IV tubing 135 which is coupled to a patient 110 such that the IV fluids and medication can be administered to the patient and dynamically controlled by the control device 100.
- [0081] The control device 100 includes one or more processing units (not shown), and one or more computer readable storage medium (not shown). The processing units may be implemented within one or more application specific integrated circuits (ASICs), digital signal processors (DSPs), digital signal processing devices (DSPDs), programmable logic devices (PLDs), field programmable gate arrays (FPGAs), processors, controllers, micro-controllers, microprocessors, other electronic units designed to perform the functions described above, and/or a combination thereof. The computer readable storage medium may include one or more memories for storing data, including read only memory (ROM), random access memory (RAM), magnetic RAM, core memory, magnetic disk storage mediums, optical storage mediums, flash memory devices and/or other machine readable mediums for storing information. The computer readable storage medium may be embodied in one or more portable or fixed storage devices, optical storage devices, wireless channels, and/or various other storage mediums capable of storing that contain or carry instruction (s) and/or data.
- [0082] The control device 100 is coupled to the fluid pumps 109 via interface ports. The interface ports can include one or more of a standard USB port and a standard serial port. The USB connector can also be used to import patient data in real-time from another source such as a patient monitor (not shown). Optionally, an external component may be connected to the control device 100 which will allow for direct monitoring of patient vital signs by the control device 100. Finally, the USB/Serial ports will allow data to be transferred to and from the control device 100 for sharing data with other networked equipment (not shown), and for receiving firmware upgrades. Additional ports may be added (for interface with electronic records systems, for example).
- [0083] In some embodiments, the display 120 provides a touch-screen interface for monitoring vital signs of the patient and for entering patient data and user preferences into the control device 100.
- [0084] The first fluid pump 109-1 can be integrated in the same housing as the control device 100 or can be an external

pump. In either case, the first fluid pump **109-1** can regulate and drive the flow of fluid from the IV bags **125** to the patient, as well as select which fluid to use from which IV bag **125**. The IV fluids can include one or more of crystalloids, colloids, or blood products as well as other fluids. The second fluid pumps **109-2** can be integrated with or external to the control device **100** and can be syringe pump systems for use with multiple medication vials **130**. One or more pumps may be included but are not required for standard use. The fluid pumps **109** can also contain an air detector to hold the infusion in the event air is detected in the tubing. The control device **100** can be coupled to commercially available pumps to control those.

[0085] The IV tubing **135** is typically disposable and is coupled with the control device after flushing and prior to use, as for any standard IV fluid pump. The IV tubing **135** is depicted as a single tube at the patient **110** and multiple tubes at the IV bags **25** and the medication vials **130**. However, multiple IV tubes **135** can be connected to the patient **110**. The disposable IV tubing **135** is sterile IV tubing where a new disposable tube set is used for each patient to maintain sterility. One end of IV tubing **135** can have standard IV bag taps for use with standard IV solutions, colloids, and blood products. The opposite end of the IV tubing **135** can be a male luer lock for connection to standard IV tubing sets and claves. The disposable IV tubing can also have side ports distal to the main fluid pump which the medication syringes from the medication vials **130** can be attached to.

[0086] FIG. 1B illustrates the system **10** including details of an embodiment of the control device **100**. Each of the components of the control device **100** shown in FIG. 1B are described in detail in the figures and sections that follow.

[0087] Referring to FIG. 1B, the surgical patient **110** is monitored by one or more clinical monitors **115**, which are coupled with the control device **100**. The clinical monitors **115** can be integrated with or separate from the control device **100**. The vitals measured by the clinical monitors **115** are communicated in some fashion to a vitals manager and log component **101**, which, in some embodiments, filters the incoming data for noise and validity and then maintains an ongoing record of the validated data in a vitals log.

[0088] Data from the vitals manager component **101** is passed on request to the population based predictor component **102**. The population based predictor component **102** is responsible for making predictions about the likely efficacy of a certain fluid bolus by comparing the received vitals of the patient **110** to mean responses obtained from a previous population of patients with similar vitals in response to the certain fluid bolus.

[0089] Data from the vitals manager component **101** is also passed, on request in some embodiments, to a fluid bolus log component **103**. The data is typically passed or requested when a fluid bolus is initiated or terminated, so that the vitals and calculations based on them may be included in the fluid bolus log with the appropriate bolus. The fluid bolus log component **103** also receives inputs from a pump manager component **108** (e.g., when fluid boluses are initiated or terminated) including the relevant details of the bolus being administered.

[0090] Information from the fluid bolus log component **103** is output to a log predictor component **104**. The log predictor component **104** is configured to analyze the known history of the current patient **110**, and, taking into account

the vitals and sub-analyses based on the vitals, predict the current efficacy of a fluid bolus.

[0091] The log predictor component **104** is also configured, after determining the appropriate segments of the Log that are applicable to the patient **110** in the current state and finishing its predictive analysis, to pass the same segments it used for analysis on to a history analysis component **105**. The history analysis component **105** then further characterizes these segments to examine the mean historical error of both the population based predictor component **102** and the log predictor component **104** by determining, for example, the standard deviation of these errors in order to make corrections to current predictions.

[0092] A prediction engine **106** takes the outputs from the population based predictor component **102**, the log predictor component **104**, and the history analysis component **105**, and uses these outputs to formulate a combined prediction in cardiac output for the current state of the patient **110**. This combined prediction is passed on to an intervention decision component **107** which takes the predicted change in cardiac output and determines the appropriate course of action for the control device **100**. This action may be modified by user specifications in this component.

[0093] Finally, the action dictated by the intervention decision component **107** is communicated to the pump manager component **108**, which is responsible for communication of the action with a supervisor for verification (if necessary) and the actual hardware level control and monitoring of the fluid pump(s) **109**.

[0094] The fluid pump(s) **109**, in one embodiment, are externally controlled fluid pumps which contain their own command interface, alarm system, and configuration. The control of the fluid pumps **109** can be achieved over serial, network, wireless, Bluetooth, or other electronic protocols. The specific design of the fluid pumps **109** is not essential beyond the characteristic that they are able to variably control the rate of administration of IV Fluid and/or medication **113** into the patient **110**. There may be one, two, or more than two physical fluid pumps **109**, depending on the embodiment.

[0095] In another embodiment, the fluid pump(s) **109** are an integrated component of the control device **100**. In this embodiment, the fluid pumps **109** may or may not include alarm and control configurations. If the fluid pumps **109** do not include alarms and controls, the alarms and controls for the pumps can be included in the control device **100**. A user interface (not shown) of the control device **100** can be used to affect some aspects of the fluid pumps **109**. There may be one, two, or more physical pumps **109** in this embodiment.

[0096] In yet another embodiment, the fluid pump(s) **109** are the embodiment of a control device **100** with the entirety of the system built into the hardware and electronic control scheme of the fluid pump **109**. This pump may include one, two, or more individual fluid set channels for control.

[0097] As expected, the fluid pump(s) **109**, deliver IV fluid and/or medications **113** to the patient **110** at the rate and times dictated by the method of the claim, in some cases as approved by the supervisor.

[0098] An SV/CO monitor **111** is another component that keeps track of the stroke volume and cardiac output over time. The SV/CO monitor **111** can independently provide information about the current stroke volume and cardiac output compared to the average and maximum SV/CO and this information can be used by the intervention decision

component 107 either alone or in conjunction with the other components to determine whether or not to provide fluid to the patient.

[0099] FIG. 2 illustrates details of an embodiment of a vitals manager component 101 that can be used, for example, in the management system 10 of FIGS. 1A and 1B. The vitals manager component 101 is responsible for the acceptance and processing of new vital signs received from clinical monitors 201. In one embodiment, clinical monitors 115 are included within the control device 100 and are connected to the patient 110 and simply pass the collected data along to the vitals manager component 101 internally. In another embodiment, external or third-party clinical monitors 115 are connected to the patient and the data from the clinical monitors 115 is sent to the control device 100 through data interfaces using communications protocols, including but not limited to direct serial connections/RS232, TCP/IP or other network protocols including wireless and Bluetooth, USB, and direct analog signals. This data, in a one embodiment, could be expected to arrive about every second, but may be as often as every $\frac{1}{1000}$ th of a second or less in the case of digitized waveforms or even continuously in analog signals, and may be as infrequent as once a minute in low-performance embodiments.

[0100] Regardless of the original source of the information, the vital signs data 112 is received by the vitals manager component 101 and first pass through an artifact and noise filter component 206, referred to from herein as the artifact filtration component 206. The artifact filtration component 206 compares the new vital signs data 112 both to itself (for internal consistency) and to previously received data (for consistency with regards to trends and time), and to general rules about limits on specific parameters. If the new vital signs data 112 is found to satisfy the requirements of the noise filters (e.g., within threshold limits and/or within threshold changes over a threshold time) it is deemed valid and passed on to the Vitals Log table 202. If not, it is rejected as being a temporary artifact and the vital signs data 112 discarded.

[0101] To accomplish this artifact detection, in one embodiment, a mean value and standard deviation can be calculated for any parameter in relationship to any other hemodynamic parameter over time. This calculation is performed for any relevant decision-making variables (for example, the DP and CO). If the target parameter is outside the standard deviation for the associated parameters of comparison, it is more likely that this new measurement is an artifact and will be flagged by the system and temporarily ignored.

[0102] Over the next few measurements, if the target variable returns to a range expected for the associated variables, the previously detected artifact value(s) is/are left flagged and are ignored in any analysis or processing of the vital signs data 112. However, if the target variable remains outside the expected range for longer than a discrete timespan, or the incoming vital signs data 112 change such that they are now in ranges correlating with the vital sign of interest, the flags are removed and the measurement is assumed to be real.

[0103] Additionally, certain parameters measured from the same equipment/monitors will be expected to reflect artifacts simultaneously. For example, a heart rate, blood pressure, and stroke volume variation from an arterial line

waveform would be expected to either all show artifact or none if the signal were to become noisy.

[0104] Similarly, a parameter monitored from different clinical monitors 115 but reporting the same vital sign (for example, a heart rate calculated from the EKG waveform, arterial line waveform, and plethysmograph waveform) would be expected to change in all three measurements. If there is a significant difference between measurements from different clinical monitors 115, the artifact filtration component 206 can determine that there is artifact in one or more of the signals and that one or more of the measurements is likely incorrect.

[0105] Referring again to FIG. 2, a Vitals Log table 202, in one embodiment, maintains a complete record of all vital signs data 112 accepted from the clinical monitors 115 regarding the patient 110, whether temporally contiguous or not. Further, should a different control device 100 be used on the same patient 110, the data from a previous control device 100 could be transferred to the new vitals log table 202 of the new control device 100, either over a network, through a portable media device like a USB drive or electronic smart card, or via some other form of electronic media. At any time, the vitals log table 202 will service vitals request inputs 204 for patient data at given times that are received, for example, from other components of the management system 10. Said vitals request inputs 204 can include both a time point and a time span (e.g., a start time and an end time, or a start time and duration). The time span indicates the period over which the vitals log table 202 should compile and average (or perform other statistical analysis on) the requested data. The time point indicates when this average time frame data should be pulled from the log; this is not necessarily the current time but may be any time, past or future, over the entire monitoring period of the patient 110. The response to this request is, in one embodiment, a time averaged vitals pack output 205, which contains the requested average vitals and trend information (see below), and is accepted as input at other components of the system.

[0106] One adjunct component to the vitals log table 202 is the vitals trend processor 203. When new vital signs data 112 is added to the vitals log table 202, the vitals trend processor 203 will take the new data along with any or all portions of the entirety of the preceding data and analyze, identify and store specific trends. These trends will be stored in the vitals log table 202 along with the new data on acceptance such that the trends at this time point are also available immediately for any incoming vitals request input 204. Such trend analysis, in one embodiment, includes factors like the percent change in heart rate, mean arterial pressure, dynamic predictor, cardiac output, stroke volume, and systemic vascular resistance over the last two minutes, five minutes, and ten minutes.

[0107] FIG. 3 illustrates details of an embodiment of a population based predictor component 102 that can be used, for example, in the control device 100 of FIG. 1B. The population based predictor component 102 receives a vitals pack output (time averaged, for example) 205 supplied by the vitals manager component 101. The vitals pack output 205 is first received by a vitals processing component 302 and distilled into specific core measures for lookup in population reference tables 306. In one embodiment of the system, these measures can include heart rate, stroke volume, systemic vascular resistance, and indications dynamic predictor(s) being utilized, but many other measures are

interchangeable. For example, as cardiac output is nothing more than stroke volume multiplied by heart rate, cardiac output could be used in place of either heart rate or stroke volume with equal efficacy, and many other such replacements are feasible. The limit or requirement of four parameters necessary; other embodiments may include fewer or more. Conceptually, the purpose of this distillation of vitals pack output **205** is to succinctly characterize the patient's overall hemodynamic state during the time frame in question in as complete but concise a manner as possible for comparison with the population data (which has been previously similarly characterized and stored in the population reference tables **306**).

[0108] Once the distillation and characterization of the vitals pack output **205** is completed by the vitals processing component **302**, a reference table selector component **303** identifies one of a plurality of the population reference table **306** based on a comparison of (1) patient demographics and comorbidities input **301** received from the vitals manager component **101**, and (2) any dynamic predictor(s) available, with similar data stored in association with the population reference tables **306**. The population reference tables **306** are multi-dimensional references that link specific patient characterizations (e.g., patient demographics and comorbidities and dynamic predictors) in specific sub-populations of patients, to an expected increase in cardiac output. The patient demographics and comorbidities input **301** will be used by the population based predictor component **102** to determine which population reference table **306** is the most appropriate reference to use based on the evolving information about how patient diseases and demographic factors influence the dynamic predictors and cardiac output. In an example embodiment, an **80**-year old smoker with heart failure would lead to the selection of a population reference table **306** that included only elderly smokers with heart failure, while a similar non-smoking patient would lead to a different population reference table **306** for non-smokers. The population reference tables **306** are expected to evolve as significant sub-groups are identified. Furthermore, all of the population reference tables **306** can be identified by not only the patient population represented, but by a particular dynamic predictor or predictors as well. Thus, there will be different population reference tables **306** for the example **80** year old smoker if pulse-pressure variability is available rather than plethysmograph variability, for example. Finally, more general population reference tables **306** can also be available such that a patient who does not fit the criteria of a narrow subpopulation can be referenced against the broader population.

[0109] Following the characterization of the patient state with the vitals processing component **302** and the selection of the population reference table **306** with the reference table selector component **303**, a population lookup and hybridization component **304** will cross-reference the patient characterization with the chosen population reference table **306** and identify the expected increase in cardiac output for the given patient in the current state. This expected increase in cardiac output is, in the standard embodiment, the amount the cardiac output would be expected to increase in response to distinct volume of intravenous fluid over a distinct time span. For example, in one embodiment, this could be 500 ml of fluid over 10 minutes, but any volume and timeframe are possible. This predicted increase, along with a measure of the quality of the prediction (based upon the specificity of

the population reference table **306** and the quality and frequency of the vitals pack output data **205** received from the vitals manager component **101**) is exported in a population prediction output **305** to subsequent components of the control device **100**.

[0110] FIG. 4 illustrates details of an embodiment of a fluid bolus log component **103** that can be used, for example, in the control device **100** of FIG. 1B. The purpose of the fluid bolus log component **103** is to track and store bolus log entries **400** that include information associated with each distinct volume of intravenous fluid delivered by the control device **100** into a patient **110**. Each bolus log can include one or more of a start time, an end time, a patient condition both before and after the bolus, and the impact of the fluid bolus on hemodynamics. Each bolus log entry **400** is initiated with the acceptance of an intervention command **415** at a bolus start interface **410**. In addition each bolus log entry **400** includes a first vitals pack output **205-1** at start time received by the bolus start interface **410** from the vitals manager component **101**. The first vitals pack output **205-1** includes information indicative of the vitals of the patient

[0111] **110** at or prior to the start time of the fluid bolus. The intervention command **415** also includes an end time that determines the timespan over which the fluid is to be delivered. The end time information of the intervention command **415** is received by a bolus end interface **420**. At the end of the bolus timespan, or shortly before or after the timespan, the bolus end interface **420** receives a second vitals pack output **205-2**. The second vitals pack output **205-2** includes information indicative of the vitals of the patient **110** at or near the end of the fluid bolus.

[0112] Upon initiation of a fluid bolus, the fluid bolus log component **103** creates a new bolus log entry **400** and assigns a bolus ID number **401** to the bolus log entry **400**. In addition, the intervention command includes a reason for initiation of the bolus. The fluid bolus log component **103** stores the reason for initiation of the bolus **402** in the new bolus log entry **400**. The first vitals pack output **205-1** is also recorded as a patient vitals at start time **403** in the bolus log entry **400** such that the bolus log entry **400** contains a complete record of the patient vitals at the start of each fluid administration without need to access other data structures within the system. In another embodiment, first vitals pack output **205-1** is excluded from this bolus log entry **400** and merely the start time recorded, with reference made to the vitals log table **202** or another similar data store based on the start time should vital signs data be needed. The new bolus log entry **400**, as identified by the distinct bolus ID **401**, is left open while the fluid bolus is administered.

[0113] Following the conclusion of the fluid bolus, a waiting period can be allowed to pass before analyses of the results of the bolus are attempted. In one embodiment, this period is about two minutes, but this waiting period could be as little as instantaneous to as long as ten minutes without changing the significance of the post-analysis. Following the determined time span of the bolus, an end command of the intervention command **415** is received at the end bolus interface **420** and the fluid bolus is terminated. The fluid bolus log component **103** stores the end bolus time information **404** in the bolus log entry **400**. In addition, after the determined waiting period, the second vitals pack output **205-2** is received and recorded by the fluid bolus log component **103** at a patient vitals end entry **405**. In many cases, the end command of the intervention command **415**

will correspond to the time upon which the target volume of the fluid bolus is achieved, but in other cases this may be a user-specified termination, an early termination due to contraindication by the patient state, or a modification of the previous bolus, among other causes. Following the recording of the end of the bolus information **404** and the post-bolus vitals in the patient vitals end entry **405**, an additional set of cardiac output

[0114] calculations **406** is added to the bolus log entry **400** regarding the efficacy of the bolus for future reference.

[0115] The determination of efficacy of a given bolus of intravenous fluid into the patient is now described in detail for one embodiment of the control device **100**. First, a simple calculation is made to determine the absolute change in cardiac output from the beginning of the bolus to the end of the bolus:

$$\Delta CO = (CO_{end} - CO_{start}) / CO_{start} \quad (1)$$

[0116] This absolute change ΔCO may not always reflect the true efficacy of a fluid bolus, however. For example, if the patient **110** was losing blood at a rapid pace, the cardiac output would steadily fall as a result. A fluid bolus given during this decline may be insufficient to actually overcome the blood loss and cause an increase in cardiac output, however it would be expected to slow the rate of decline or perhaps hold the cardiac output steady. This would still be an effective fluid bolus, though the absolute change in cardiac output would be flat or even negative and considered ineffective by this measure. Thus, a vector-based analysis can also be performed. The mean rate of change of the cardiac output of the patient over discrete timespans immediately prior to the bolus is noted and compared to the mean rate of change of cardiac output during the period of the fluid bolus. If the rate of change of cardiac output becomes less negative as a result of fluid, then this is also considered an effective bolus.

[0117] An additional method of detection of possible patient conditions confounding calculations of efficacy of a fluid bolus is the known relationship between DP, CO increase with fluid, and the change in DP with fluid.

[0118] The relationship between an increase in DP and an increase in CO in response to a 500 ml bolus in published and unpublished data has a linear regression coefficient (R^2) of approximately 0.39 resulting in the equation $y = 1.54x - 1.11$, where y corresponds to increase in CO and x corresponds to increase in DP [see Cannesson M, Le Manach Y, Hofer C K, Goarin J P, Lehot J J, Vallet B, et al.; "Assessing the Diagnostic Accuracy of Pulse Pressure Variations for the Prediction of Fluid Responsiveness: a 'Gray Zone' Approach." *Anesthesiology*, 2011. 115(2): p. 231-411. The linear regression coefficient represents the statistical strength of the relationship between DP and CO change. This linear regression coefficient was calculated from the clinical data set. As such, it's not reflected in the equation relating y and x , but represents the "tightness" of the equation's fit to the clinical data.

[0119] The relationship between DP and DP decrease (absolute) in response to a 500 ml bolus has a linear regression coefficient (R^2) of approximately 0.63 for the equation $y = -0.72x + 4.3$, where y corresponds to expected decrease in PPV and x corresponds to decrease in PPV.

[0120] Since the PPV/APPV relationship is particularly strong, it can be expected that for any fluid bolus the FP value can be expected to decrease predictably. If the CO

does not increase as expected in response to a bolus and the FP does not decrease within a standard deviation of the expected, there is a much higher likelihood that volume loss is to blame. If the CO does increase but the FP does decrease as expected, this is more likely to be attributable to true patient bias or deviation from expected population-based responses.

[0121] Once these calculations are completed, the cardiac output calculations **406** are stored in the bolus log entry **400** and the bolus log entry **400** is then complete. The completed bolus log entry **400** is stored as bolus log entry **400-1** in a bolus log buffer **408**. The bolus log buffer **408** includes an entire list of bolus log entries **400-1**, **400-2**, **400-3** through **400-N** which is made accessible to subsequent data processing modules (specifically the log predictor component **104** and the history analysis component **105**), as well as packaged for export for sharing of the summary data.

[0122] FIG. 5 illustrates details of an embodiment of a log predictor component **104** and an embodiment of a history analysis component **105** that can be used, for example, in the control device **100** of FIG. 1B. The action of these components is to: 1) in the case of the log predictor component **104**, to take bolus log entries **400** from the fluid bolus log component **103** and vitals pack output data **205** from the vitals manager component **101** and determine a likely resulting change in cardiac output due to a new fluid bolus given the current patient state; and 2) in the case of the history analysis component **105**, to determine the accuracy of both the population based predictor component **102** and the log predictor component **104** in predicting the correct increase in cardiac output in previous boluses in terms of both mean error and standard deviation of the mean error.

[0123] A bolus log processor component **501** receives the current vitals pack output **205** and performs a comparison of the current patient state to the patient state at the beginning of any previous boluses. This is accomplished through a process referred to herein as "state similarity" that is essentially a mathematical combination of distinct hemodynamic measures using Bayesian weights. In one embodiment, the state similarity is the square root of the sum of the squares of the differences in each measured parameter divided by the Bayesian weight of the parameter. The specific weights and hemodynamic measures used in this particular embodiment of the device are heart rate, systemic vascular resistance, stroke volume, and dynamic predictor, using weights of 0.33, 4, 0.2, and 0.1, respectively. These weights are merely one example set and may change, depending on patient population, new clinical observations, or the dynamic predictor in question. The calculation of the state similarity for these four parameters of this embodiment is made between the current state C and the previous state P as follows:

$$HRSS = HRC - HRP / 0.33 \quad (2)$$

where HRC is the current heart rate, HRP is the previous heart rate and HRSS is the heart rate state similarity;

$$SVRSS = SVRC - SVRP / 4 \quad (3)$$

where SVRC is the current systemic vascular resistance, SVRP is the previous systemic vascular resistance and SVRSS is the systemic vascular resistance similarity state;

$$SVSS = SVC - SVP / 0.2 \quad (4)$$

where SVC is the current stroke volume, SVP is the previous stroke volume and SVSS is the stroke volume similarity state; and

$$DPSS = DPC - DPP / 0.1 \quad (5)$$

where DPC is the current dynamic predictor, DPP is the previous dynamic predictor and DPSS is the dynamic predictor similarity state. The resulting total state similarity measure of quality “SSTotal” is calculated as follows:

$$SSTotal=100-HRSS-SVSS-SVRSS-DPSS \quad (6)$$

[0124] The state similarity parameters HRSS, SVRSS, SVSS, DPSS and SSTotal and the corresponding bolus log entry are stored in a state similarity subgroup buffer **502**. Entries in the state similarity bolus log subgroup buffer **502** that exhibit a quality measure SSTotal greater than a “similar” threshold level, and are of a sufficient volume and given over a timespan appropriate to draw meaningful conclusions from, are passed on to a predictive analysis component **503**. Entries in the state similarity bolus log subgroup buffer **502** that exhibit a quality measure SSTotal greater than a “highly similar” state similarity threshold level are given added weight. In a typical embodiment, the “similar” and “highly similar” state similarity threshold levels are 50 and 75 respectively. Entries in the state similarity bolus log subgroup buffer **502** that exhibit quality measures SSTotal that do not meet these thresholds are discarded. In this way the prediction made by the log predictor component **104** is specific to the current global hemodynamic state of the patient **110**, such that if the patient **110** changes dramatically over the course of care, previous intervention results are not assumed to be comparable in the new state.

[0125] The log processor component **501** can start the state similarity analysis of the bolus log entries **400** with the most recent entries and work backward in time. As previous bolus log entries **400** meet the predetermined state similarity thresholds, a running tally of the total state similarity of entries found is kept. When this tally reaches another threshold level, the log processor component **501** stops further state similarity analysis and retains only the entries already captured. In this way, the algorithm manifests both a memory of its past efficacy as well as a ‘forgetfulness’, such that if some aspect of the patient changes in a way that truly alters the patient response to fluid the system will not be permanently biased by the early results but rather will be progressively more influence by the recent results of interventions.

[0126] As an example of this behavior, take a patient in steady state during surgery. The patient cardiac output is 4.5 and the system attempts a fluid bolus. The cardiac output improves to 5.6, a 21% increase. This is considered effective by the system and is recorded as such in one of the bolus log entries **400**. Subsequently the patient has some ischemic heart injury and the cardiac output falls back to 4.5, not because of hypovolemia but because of a loss of inotropy. The system will likely attempt another bolus in this state as the previous one was successful, but in this instance there will be no improvement in cardiac output because the intravascular volume is already maximized. Were it not for the forgetful component of the state similarity analysis of the bolus log entries **400**, the system might continually operate using the initial success indefinitely and thus continue to deliver fluid inappropriately. The emphasis of recent activity and results over more distant activity and results ensures that ineffective interventions are rapidly phased out.

[0127] Once the entries in the state similarity bolus log subgroup buffer **502** that are applicable to the current patient state are selected by the log processor component **501**, a

predictive analysis is performed on the subgroup buffer **502** by a predictive analysis component **503**. The predictive analysis calculates a running average of the change in cardiac output recorded for the entries stored in the subgroup buffer **502**. In one embodiment, the entries in the subgroup buffer **502** are weighted in the running average calculation by their quality measure SSTotal as determined by the log processor component **501**, such that the higher the SSTotal of a previous bolus to the current patient state the more weight the prediction will carry in the combined running average. The output from predictive analysis component **503** is a log prediction packet **507** and a quality rating packet **506** that includes information about the total number of entries in the subgroup and the corresponding state similarity quality measures SSTotal.

[0128] Referring again to FIG. 5, the subgroup buffer **502** selected by the log processor component **501** is also passed into the historical accuracy analyzer **504** of the history analysis component **105**. The historical accuracy analyzer **504** reviews each of the selected bolus log entries **400** contained in the subgroup buffer **502** and compares the cardiac output increase predicted by the population based predictor component **102** and by the log predictor component **104** to the actual increase seen in the patient and calculates the average error and standard deviation of the error for each respective predictor. This information is exported and stored in a bolus history analysis buffer **505**.

[0129] FIG. 6 illustrates details of an embodiment of the prediction engine **106** that can be used, for example, in the control device **100** of FIG. 1B. The prediction engine **106** receives inputs from all of the other predictive components. Specifically, the prediction engine **106** receives the population prediction output **305** from the population predictor component **102**, the log prediction packet **507** and the quality rating packet **506** from the log predictor component **104**, and the bolus history analysis buffer **505** from the history analysis component **505**. The prediction engine **106** uses these inputs to generate a final combined predicted cardiac output change for the current state of the patient **110**.

[0130] The process begins with the prediction engine **106** receiving a population prediction output **305**, a log prediction packet **507**, a log quality rating **506**, and a bolus history analysis **505**. The predictions included in the log prediction packet **507** and the population prediction output **305** are adjusted by the mean error value contained in the bolus history analysis buffer **505** for the respective components. Then the standard deviation of error is both added and subtracted from each component to yield two predictions for each component representing the top and bottom of the range of increase of cardiac output expected. The top and bottom predictions from a first one of the predictive components is averaged with the top and bottom predictions from the second one of the predictive components using the inverse of the standard deviations of each to weight the averages. This results in the narrower standard deviation of the two being given more weight in the resulting value. This results in two final predictions, one for the top and one for the bottom. In the embodiment shown, a best case prediction component **602** calculates the top or greatest predicted change in cardiac output and a worst case prediction component **603** calculates the bottom or least predicted change in cardiac output.

[0131] A final prediction component **604** combines the best case prediction and the worst case prediction to deter-

mine the final predicted change in cardiac output **605**. In the embodiment shown, an “optimism” input **601** is provided to the final prediction component **604**. In this embodiment, the optimism input **601** is a user-defined value between zero and 100 that is used to determine the final predicted change in cardiac output **605** made by the final prediction component **604** within the best case and worst case values determined by the best and worst case prediction components **602** and **603**, respectively. A value of 100 of the optimism input **601** results in the best case predicted change, while a value of zero results in the worst case predicted change in cardiac output. Values between zero and 100 will result in values between the best and worst case values (e.g., linearly interpolated values). The final predicted change in cardiac output **605** is then output. In another embodiment, the optimism input **601** is a fixed value of 100, 75, 50, 25, 0, or some value in-between determined in advance or hard-coded into the algorithm. In yet another embodiment the optimism input **601** is a range of values between the lower end of zero and the upper end of 100.

[0132] FIG. 7 illustrates details of an embodiment of an intervention decision component **107** that can be used, for example, in the control device **100** of FIG. 1B. The intervention decision component **107** receives the final predicted change in cardiac output **605** determined by the prediction engine **106**, and in conjunction with an aggression rating **710** determines an action to be taken by the control device **100**. In one embodiment the aggression rating is a user-specified value within the range -10 to $+10$, inclusive. In another embodiment, the aggression rating **710** can be fixed, or may have a different range. Regardless of the way the aggression rating **710** is determined, the aggression rating **710** is used to generate the intervention command **415** that is provided to the pump manager component **108**.

[0133] The final predicted change in cardiac output **605** (given in percentage increase in cardiac output in this embodiment) received by the intervention decision component **107** is received by an intervention range selector **700** and compared to decision ranges to determine the appropriate course of action. In one embodiment, there are four such ranges, though more or less may be present in other embodiments. The lowest such range in this embodiment is the low threshold zone **704**, in which the administration of fluid is likely to be at best not helpful and at worst detrimental. A second range is the gray zone **703**, in which the outcome of fluid administration is either indeterminate or mixed. A third range is the high threshold zone **702** in which fluid is likely to increase cardiac output significantly. A fourth range is the critical threshold zone **701** in which fluid is almost certain to have a substantial positive impact. In this embodiment, the percentage increase in cardiac output for these zones are 0-7% for the low threshold zone **704**, 8-14% for the gray zone **703**, 15-25% for the high threshold zone **702**, and 25% and greater for the critical threshold zone **701**.

[0134] As indicated in FIG. 7, each of these zones corresponds to an action or set of actions **705**, **706**, **707** or **708** to be taken by the control device **100**. The specific response to a given zone will depend on the embodiment of the system and the number of zones. In the embodiment illustrated in FIG. 7, the response taken in each of the zones is as follows: in the low threshold zone **704** the response is to stop any ongoing infusion and continue monitoring **708**; in the gray zone **703**, the response is to continue whatever action is currently taking place **707**, and in some cases to deliver a test

bolus (see below); in the high threshold zone **702**, the response is to initiate a fluid infusion, or to continue an infusion if already running **706**; and in the critical zone **701**, the response is to accelerate any ongoing infusion to the maximum system rate or start such an infusion if not already active **705**. The final action is sent as an intervention command **415** to the pump manager **108**.

[0135] The volumes and rates of the infusions being started upon intervention are specific to the embodiment of the control device **100** and depend on the characteristics of the pumps **109**. In an embodiment for use in a human patient **110**, a high threshold zone **702** infusion response **706** is 250 ml of fluid, given over a time span of 5-10 minutes depending on the pump capacity, and a critical zone **701** infusion **705** is 500 ml of fluid given over 5-10 minutes depending on the pump capacity. In other embodiments these volumes may be modified as well as the time spans of delivery.

[0136] Again referring to FIG. 7 and the preferred embodiment of the device, in some cases a “test bolus” will be delivered by the pump in the Gray Zone to determine whether or not fluid is likely to be beneficial. This test bolus can be 100 ml of fluid delivered over a time span of between one and ten minutes. Specifically, when a patient is determined to be in the gray zone, and there are no high quality bolus log entries **400** as determined by the state similarity processor **501** within a specified timeframe, a test bolus is initiated. In one embodiment this timeframe is two, three, four, six, ten, or twelve hours.

[0137] With further reference to FIG. 7, the aggression rating **710** is used to modify the zone boundaries during operation of the control device **100**. A positive aggression rating **710** will lower the percentage change in cardiac output of the boundaries, thereby making the control device **100** more likely to deliver fluid for any given prediction by the system. A negative aggression rating will raise the percentage change in cardiac output of the boundaries, and thereby make the control device **100** less likely to deliver fluid for any given prediction by the system. The boundaries may, in one embodiment, be raised by a fixed value for each point of the aggression rating **710** and in another embodiment may be multiplied or divided by a value for each point of the aggression rating **710**. The aggression rating **710** is, in one embodiment, determined by a supervisor during operation of the control device **100**.

[0138] In another embodiment, the intervention decision component **107** may also include a direct input from the vitals manager component **101** through which the intervention decision component **107** receives instantaneous or short-time-averaged vital signs. In this embodiment the intervention decision component **107**, in addition to making recommendations and decisions about IV fluid administration also makes recommendations and decisions about medication administrations.

[0139] In such an embodiment, vasoactive medications may be recommended to the supervisor if deemed appropriate, or, in one embodiment, delivered to the patient **110** directly by the system after supervisory approval or autonomously.

[0140] FIG. 8 illustrates details of an embodiment of a pump manager component **108** that can be used, for example, in the control device **100** of FIG. 1B. As discussed above, the function of the pump manager component **108** is to coordinate fluid pump activity, to monitor the fluid pumps **109** to ensure proper response to commands issued to

the fluid pumps 109, and to interact with a user interface 810 when appropriate. In one embodiment, the pump manager component 108 is the only component of the control device 100 that receives direct instructions in the form of actionable commands from the user interface 810.

[0141] The monitoring and control functions of the pump manager component 108 are provided by interaction between a core pump manager component 801, a pump director component 803, the fluid pumps 109-3 and 109-4, and a pump monitor 802. Any desired pump action communicated from the user interface 810 or received in an intervention command 415 from the intervention decision component 107 is received by the core pump manager component 801 and relayed to the pump director component 803. The received pump actions contain

[0142] explicit information and formatting enabling the core pump manager component 801 to communicate those actions to the specific fluid pumps used in each particular embodiment. The pump director component 803 will confirm that the commands are received and accepted by the fluid pumps 109-3 and/or 109-4, but the pump director component 803 does not track the action of the pumps 109-3 and 109-4 beyond this step. If the commands are rejected, not acknowledged, or any other communication error arises between the pump director component 803 and the fluid pumps 109-3 and 109-4, this is communicated back to the core pump manager component 801 along with the nature of the error.

[0143] One feature of operation of the pump manager component 108 is that any command sent to the fluid pumps 109-1 or 109-2 for delivery of an IV fluid bolus 113-1 or 113-2 contains both a rate and a volume for delivery. Furthermore, the fluid pumps 109 themselves can be designed such that only a command containing both elements is accepted by the pumps. This feature can ensure safety to the patient 110 should communication between the system and the fluid pumps fail for any reason, and further, should the fluid pumps 109, upon loss of communication with the rest of the system, fail to halt active infusions and enter a standby mode until communication is reestablished, they will automatically stop infusing fluid at the completion of the dictated bolus volume. Thus, the fluid pumps 109 are not left indefinitely in an infusing mode due to loss of system communication which could result in over-administration of fluid and pose a safety risk to the Patient.

[0144] The pump monitor component 802 is responsible for the ongoing supervision of the fluid pumps 109 following the initial issuance of a command by the pump director component 803. The pump monitor component 802, at system specified time intervals, queries the fluid pumps 109 and requests an update on their status. The time interval, in one embodiment, may be 100 seconds, 10 seconds, 1 second, $\frac{1}{10}$ th seconds, $\frac{1}{100}$ th seconds, or $\frac{1}{1000}$ th seconds. The status update, in one embodiment, can contain the current pump state (on, off, waiting, infusing, alarm, error) along with detailed information about the amount of volume given in the current infusion (if active), the rate of the current infusion (if active), the total volume given to this patient, the back pressure in the infusion tubing, the available volume to infuse (if present), the nature of the fluid available to infuse (if present), and detailed alarm information (if active). This information is organized and transmitted to the core pump manager component 801.

[0145] The core pump manager component 801, as previously described, is responsible for coordination of all pump activity involving the intervention commands 415 received from the intervention decision component 107 or from other parts of the system such as the user interface 810. Commands are passed into the pump director component 803 for transmission to the fluid pumps 109. If the intervention commands 415 are accepted no further action is needed. If a command fails due to any of the communication errors discussed above, or for any other reason, this failure is relayed back to the core pump manager component 801 by the pump director component 803 for further action. If the nature of the failure may be temporary, for example, a failure of acknowledgement of the command by one of the fluid pumps 109, the core pump manager component 801 may attempt to repeat the command one or more times before taking other action. In other failures that are not likely to be resolvable by the system (for example, air detected in the pump tubing or similar failure alarms, or a pump hardware failure), then an alarm condition may be set by the core pump manager component 801 indicating the nature of the alarm and relayed to the user interface 810 for communication with and input from the human supervisor.

[0146] In the event of an alarm condition specific to a single fluid pump 109, in an embodiment that possesses two or more fluid pumps 109, the core pump manager component 801 may continue operating and attempt to compensate for the fluid pump 109-3 that has failed with the other available fluid pump 109-4 or vice-versa until the condition can be rectified by the supervisor or the condition resulting in the alarm is otherwise resolved. In the event of an alarm condition affecting the entire system, the monitoring of vital signs or the quality of information received into the vitals manager component 101, or in an embodiment with only one fluid pump 109, the core pump manager component 801 will attempt to halt active infusions if possible and will standby until the alarm condition is resolved satisfactorily by the supervisor. Any desired actions dictated by the system in this state will be ignored.

[0147] In addition to passing commands on to the pump director component 803, the core pump manager component 801 also verifies the data received from the pump monitor component 802 to make sure the actual state of the fluid pumps 109 is consistent with the state dictated by the last command provided by the pump director component 803. If the fluid pumps 109 are in a state different from the expected state but communication between the fluid pumps 109 and core pump manager component 801 is intact, the core pump manager component 801 will attempt to issue corrective commands to the pump director component 803 to place the fluid pumps 109 into the correct state. If this fails to correct the discrepancy then a global alarm condition can be set and communicated to the user interface 810 and further pump commands ignored until the alarm condition is resolved.

[0148] In some instances, the state of one or more of the fluid pumps 109 will be affected by the last command issued by the pump director component 803 in an expected manner. For example, if the pump director component 803 issues a command to infuse 500 ml of fluid over 10 minutes, after this infusion completes the fluid pumps 109 will return to standby mode. This is the expected progression of the last issued instruction and as such will be anticipated by the core

pump manager component **801** and treated as consistent with the last issued command. Thus, no alarm condition would result.

[0149] Referring again to FIG. 8, the core pump manager component **801** is also configured, in a decision-support or physician verification mode, for communication of desired actions to the user interface **810** for verification by the supervisor. In this mode, any intervention command **415** received is not acted on by the core pump manager component **801** autonomously. Instead, the intervention command **415** is conveyed to the user interface **810** and displayed to the user along with the option to accept or reject the command. If the command is rejected the core pump manager component **801** takes no further action and will ignore additional identical commands until such a time as the command changes or a pre-determined time span passes. Depending on the embodiment, this time span can be between one and sixty minutes, for example. If the command is approved then the core pump manager component **801** passes the command along to the pump director component **803** for conveyance to the fluid pumps **109**.

[0150] The core pump manager component **801** may also receive specific override commands from the supervisor. These are described in detail later. Should the core pump manager component **801** receive such an override command that command is also communicated to the fluid bolus log component **103** in the form of an intervention command **415**, for proper registration of the intervention command as a bolus log entry **400** in the bolus log buffer **408**.

[0151] Referring again to FIG. 8, in one embodiment, the pump director component **803** may be absent from the operation of the system. In this embodiment, the system has no direct control over the fluid pumps **109** whatsoever. Instead, the operation of the fluid pump(s) **109** is handled by the supervisor directly through the fluid pump(s) own control interface(s). The activity of the fluid pump(s) **109** is relayed back to the core pump manager component **801** through the pump monitor component **802**, and this information is passed along to the fluid bolus log component **103** in order to track the administration of IV Fluid **113** into the patient **110**. Meanwhile, the decisions of the control device **100** are relayed to the supervisor through the user interface **810** as recommendations of care. These recommendations may be displayed to the supervisor in graphical or numeric fashion, the main point being to convey the degree of fluid responsiveness (or predicted efficacy of additional fluid) in the patient **110** by the system.

[0152] FIG. 9 illustrates details of another exemplary patient-adaptive hemodynamic management system **10** in accordance with the disclosure. In this embodiment, an IV bag **125** of fluid is hung above the control device **100** and, using purposed tubing **135** already primed and inserted into the control device **100** tubing **135**, channel and then connect to standard IV access points on the patient **110** or other tubing, delivered by the control device **100** as described throughout the disclosure. Vital signs are delivered to the control device **100** through a physical connection with standard operating room clinical monitors **115** in the illustrated embodiment of FIG. 9. In another embodiment the clinical monitors **115** are replaced with monitors integrated into the control device **100** and connected to the patient **110**, or integrated into the control device **100** and in communication with wireless leads and contacts placed on the patient **110**. In another embodiment the vital signs are communi-

cated to the control device **100** from other monitors over a wireless network such as Bluetooth or other wireless communication protocols. In yet another embodiment, the vital signs are monitored from a distance by devices not in physical contact with the patient and subsequently communicated to the control device **100**.

[0153] Again referring to FIG. 9, in the illustrated embodiment there one IV bag **125** fluid shown and one line of tubing **135** is shown connecting the IV bag **125** to the control device **100**. In another embodiment, two, three, or four different IV bags **125** each with its own tubing run through a dedicated channel in the device, and each IV bag **125** containing different fluids may be used. In such an embodiment, the user of the control device **100** may specify which bag should be used first, second, third, or so on by the system. In another embodiment of the control device **100**, the control device **100** is made aware of what the individual fluid bags contain and will determine which fluid is appropriate based on internal rule sets.

[0154] In another embodiment of the management system **10**, one of the clinical monitors **115** provides a continuous or intermittent measure of patient **110** hemoglobin concentrations. In another embodiment of the management system **10**, one of the monitors **115** provides a measure of mixed central venous oxygen saturation or regional central venous oxygen. In yet another embodiment of the management system **10** one of the monitors provides a continuous or intermittent measure of regional or global tissue oxygen delivery or utilization.

[0155] In another embodiment of the management system **10**, the control device **100** is coupled to either oxygen delivery, tissue oxygenation or utilization, blood hemoglobin concentration, mixed central venous oxygen saturation, or regional venous oxygen saturation, and one of the fluids available to the control device **100** is an oxygen carrying product such as, for example, whole blood, packed red blood cells, salvaged patient blood from the surgical field, artificial blood products or an oxygen-carrying blood substitute. In another embodiment, based on the described setup, the management system **10** may elect to give such an oxygen carrying product instead of other available fluids in the event oxygen delivery to tissues is determined to be inadequate. This may occur independently of decisions made regarding the benefit of fluids alone as determined by the components described above.

[0156] FIG. 10 illustrates information flow between various components of the patient-adaptive hemodynamic management system **10** of FIG. 1A. FIG. 10 shows the same components as FIG. 1, but in this illustration the connections between the components are not shown. Instead the connections between the system components and the user interface **810** and a network server interface **1010** are demonstrated.

[0157] As illustrated in FIG. 10, each component of the management system **10** has outputs to the user interface **810**. These outputs may provide data that can be displayed or not displayed to the supervisor depending on the particular embodiment and implementation of the control device **100**. In the embodiment shown, the only active input from the user interface **810** to components of the control device **100** is an input the pump manager component **108**, specifically the core pump manager component **801**. This input carries, in one embodiment, the approval or rejection of recommended intervention commands **415** as determined by the supervisor. Additionally, in another embodiment, this input

carries supervisor directed override commands to either halt the fluid pump(s) 109 or to initiate a new infusion. These override commands will either persist indefinitely until cleared by the supervisor or will timeout after a predetermined timespan at which point the affected fluid pump 109 will revert to the previous mode of operation.

[0158] In one embodiment, an additional supervisor override command is a “line flush” command. When the fluid pumps 109 are already actively infusing fluid, this line flush command has no effect. When the fluid pumps 109 are in a standby state, the line flush command will cause the fluid pumps 109 to briefly activate and infuse, for example, 2, 5, 8, 10, or 15 ml of fluid depending on the total volume of fluid present in the IV fluid set in the current configuration. After this volume of fluid is infused, the fluid pumps 109 return to a standby state. The purpose of the line flush command is to drive the column of fluid present in the line into the patient 110 such that any medication administered into the line downstream of the fluid pumps 109 will also be flushed into the patient 110.

[0159] An additional supervisor override command present in another embodiment of the control device 100 is a “test bolus” command. When the fluid pumps 109 are in a standby mode, the test bolus command causes a new fluid bolus to be initiated. The volume and time of this bolus are, in one embodiment, 50 ml, 100 ml, 150 ml, 200 ml, or 250 ml of fluid given over 1,2,3,4,5,10, or 15 minutes. If a new infusion command is received (and accepted by the supervisor, if necessary), during this test bolus, the test bolus is stopped and the new bolus is started. Otherwise the test bolus will run to completion and then halt.

[0160] Referring again to FIG. 10, two components of the system interact with the network server interface 1010, the fluid bolus log component 103 and the population based predictor component 102. These interactions may not occur continuously during routine operation of the system, nor are they required as a component of the system.

[0161] In one embodiment, specific information is exchanged between the control device 100 and the network at the beginning and end of operation, or at preset time intervals. Specifically, the bolus log 408 and the patient demographics and comorbidities 301 are packaged and communicated to other networked components via the network server interface 1010. This data includes the details of the bolus log 408, significant patient disease states, and non-identifying demographic data such as patient age, height, weight, and gender. This data may not contain, in one embodiment, any information making specific identification of the source patient possible through the dataset.

[0162] The information communicated via the network server interface 1010 is received by other networked control devices 100 and processed and reorganized into population reference tables 306 which may be specific to a pertinent patient subset or to the population in general. Subsequently, at device startup time or at preset time intervals, the networked control devices 100 can update their own internal population reference tables 306 through the network server interface 1010. In this way, the population reference tables 306 will evolve over time as increasingly detailed population data becomes available for any given patient population.

[0163] The network server interface 1010 may connect to other networked servers and/or control devices 100 over any of a number of forms of electronic communication, includ-

ing but not limited to Ethernet, Wireless TCP/IP, Bluetooth, Cellular technologies, or removable media formats.

[0164] Attention is now directed to FIG. 11 which is a flowchart depicting an exemplary process 1100 of providing patient-adaptive hemodynamic management in accordance with the disclosure. The process 1100 can be performed by the patient-adaptive hemodynamic management system 10 illustrated in FIGS. 1A and 1B including the control device 100 illustrated in FIGS. 2-8. The process 1100 is exemplary only and not limiting. The process 1100 can be altered, e.g., by having stages added, removed, rearranged, combined and/or performed concurrently.

[0165] The process 1100 will be described in reference to the control device 100 of FIGS. 1A, 1B and FIGS. 2-8. The process 1100 begins at stage 1110 where the vitals manager component 101 receives measurements of vital signs from clinical monitors 115. The received vital signs can include physiologic processes such as cardiac output, stroke volume, heart rate, blood pressure and arterial pressure for example.

[0166] Upon receiving the vital signs, the process 1100 continues at stage 1114 where the control device 100 determines, based at least in part upon the vital signs measurements, a predicted change in a physiologic parameter in response to a fluid bolus. The predicted change can be predicted in part by the population based predictor component 102 based on population statistics, and/or in part by the log predictor component 104 and/or, in part by the history analysis component 105 as discussed above. In addition, the population based prediction portion, the bolus log prediction portion and the history analysis predictions can be combined by the prediction engine 106 as discussed above. The physiologic parameter can include one or more of cardiac output or stroke volume of the patient 110.

[0167] Upon predicting the change in the physiologic parameter, the process 1100 continues at stage 1118 where the intervention decision component 107 generates a fluid administration signal in response to the predicted change. The administration signal can be a signal to stop a fluid bolus currently being administered, to continue a current action and continue to test the vital signs, to start a new fluid bolus or continue a fluid bolus if one is being administered and to provide a maximum fluid bolus.

[0168] The administration signal is communicated by the intervention decision component 107 to the pump manager component 108. At stage 1122, the pump manager component 108 generates control signal(s) for infusion pump(s) such as the fluid pumps 108 based upon fluid administration signal to cause the fluid pumps 109 to take the appropriate action.

[0169] Attention is now directed to FIG. 12 which is a flowchart depicting a exemplary method 1200 of providing patient-adaptive hemodynamic management including a user intervention in accordance with the disclosure. The process 1200 can be performed by the patient-adaptive hemodynamic management system 10 illustrated in FIGS. 1A and 1B including the control device 100 illustrated in FIGS. 2-8. The process 1200 is exemplary only and not limiting. The process 1200 can be altered, e.g., by having stages added, removed, rearranged, combined and/or performed concurrently.

[0170] At stage 1210, the vital signs manager 101 receives measurements of vital signs from clinical monitors 115 in a similar fashion as at stage 1110 discussed above. At stage 1214, the control device 100 determines, based upon the

vital signs measurements, a predicted change in a physiologic parameter in response to a fluid bolus. Stage 1214 can be performed in a similar fashion to stage 1114 discussed above. At stage 1218, the intervention decision component 107 generates a fluid administration signal in response to the predicted change in a similar fashion as discussed above in reference to stage 1118.

[0171] At stage 1222, instead of generating a control signal with the pump manager component 107, as was done at stage 1122 in the process 1100, the intervention decision component 107 causes the user interface 810 to generate a representation of an intervention command on the user interface which corresponds to the fluid administration signal. At stage 1226, the user interface 810 receives a user input indicating acceptance or rejection of the intervention command. If the user input is a rejection, the process 1200 continues at stage 1234 where the current infusion or lack of infusion is continued in its existing state. If the user input received at stage 1226 is an acceptance, the process 1200 continues at stage 1230 where the user interface 810 or the intervention decision component 107 generates a control signal or signals based upon the intervention command received at stage 1226 and communicates the control signal (s) to the pump manager component 108.

[0172] Attention is now directed to FIG. 13 which is a flowchart depicting another exemplary process 1300 of providing patient-adaptive hemodynamic management in accordance with the disclosure. The process 1300 can be performed by the patient-adaptive hemodynamic management system 10 illustrated in FIGS. 1A and 1B including the control device 100 illustrated in FIGS. 2-8. The process 1300 is exemplary only and not limiting. The process 1300 can be altered, e.g., by having stages added, removed, rearranged, combined and/or performed concurrently.

[0173] The process 1300 starts at stage 1310 where the vitals manager component 101 receives information relating to an initial change in a physiologic parameter of a patient in response to administration of a first fluid bolus to the patient. At stage 1314, a predicted change in the physiologic parameter in response to administration of a second bolus to the patient is made by one or more of the population based predictor component 102, the log predictor component 104, the history analysis component 105 and the prediction engine 106 using any of the methods discussed above.

[0174] Upon determining the predicted change at stage 1314, the process 1300 continues to stage 1318 where the intervention decision component 107 and the pump manager component 108 adjust administration of the second fluid bolus to the patient based upon the predicted change.

[0175] Attention is now directed to FIG. 14 which is a flowchart depicting another exemplary process 1400 for providing patient-adaptive hemodynamic management in accordance with the disclosure. The process 1400 can be performed by the patient-adaptive hemodynamic management system 10 illustrated in FIGS. 1A and 1B including the control device 100 illustrated in FIGS. 2-8. The process 1400 is exemplary only and not limiting. The process 1400 can be altered, e.g., by having stages added, removed, rearranged, combined and/or performed concurrently.

[0176] At stage 1410, the vitals manager component 101 receives input information relating to one or more physiologic processes of a patient from one or more of the clinical monitors 115. At stage 1414, the fluid bolus log component 103 provides bolus log entries associated with a current state

of the patient to the log predictor component 104 and the log predictor component 104 determines, based at least in part upon the input information, a subgroup of the bolus log entries. The subgroup of entries can be biased based on a state similarity analysis as discussed above in reference to FIG. 5.

[0177] At stage 1418, the intervention decision component 107 adjusts administration of fluid to the patient based at least in part upon log data included within the subgroup of bolus log entries.

[0178] Attention is now directed to FIG. 15 which is a flowchart depicting another exemplary process 1500 for providing patient-adaptive hemodynamic management in accordance with the disclosure. The process 1500 can be performed by the patient-adaptive hemodynamic management system 10 illustrated in FIGS. 1A and 1B including the control device 100 illustrated in FIGS. 2-8. The process 1500 is exemplary only and not limiting. The process 1500 can be altered, e.g., by having stages added, removed, rearranged, combined and/or performed concurrently.

[0179] The process 1500 starts at stage 1514 where the vitals manager component 101 determines a first effect on a physiologic parameter of the patient associated with administration of a first fluid bolus to the patient. The vitals manager component 101 or the fluid bolus log component 103 can determine the first effect by analyzing vitals signals received from the clinical monitors 115 and comparing the received signals to previously received and stored signals. The physiologic parameter can include one or more of cardiac output, stroke volume, etc.

[0180] At stage 1518, the fluid bolus log component 103 stores first information relating to the first effect in a first bolus log entry. The first bolus log entry can be the bolus log entry 400 discussed above in reference to FIG. 4. The first bolus log entry can be stored in memory such as RAM, ROM, flash or other type of computer readable storage medium.

[0181] At stage 1522, the vitals manager component 101 or the fluid bolus log component 103 determines a second effect on the physiologic parameter of the patient associated with administration of a second fluid bolus to the patient. The first effect can be determined by analyzing vitals signals received from the clinical monitors 115.

[0182] At stage 1526, the vitals manager component 101 or the fluid bolus log component 103 stores second information relating to the second effect in a second bolus log entry. The second bolus log entry can be a second bolus log entry 400 store in a computer readable storage medium.

[0183] At stage 1530, the intervention decision component 107 generates a fluid administration signal based at least in part upon at least one of the first bolus log entry and the second bolus log entry. The intervention decision component 107 can receive information indicating one or more of the type of fluid bolus to administer, an amount of fluid bolus to administer and or an rate and time over which to administer the fluid bolus from the log predictor component 104 or the prediction engine 106.

[0184] Attention is now directed to FIG. 16 which is a flowchart depicting another exemplary process 1600 for providing patient-adaptive hemodynamic management in accordance with the disclosure. The process 1600 can be performed by the patient-adaptive hemodynamic management system 10 illustrated in FIGS. 1A and 1B including the control device 100 illustrated in FIGS. 2-8. The process

1600 is exemplary only and not limiting. The process **1600** can be altered, e.g., by having stages added, removed, rearranged, combined and/or performed concurrently.

[0185] The process **1600** starts at stage **1610** where the population based predictor component **102** receives information relating to an expected change in cardiac output in a population group in response to administration of a fluid bolus. The population based information can be stored in a computer readable medium such as one of the population reference tables **306** discussed above.

[0186] At stage **1614**, the log predictor component **104** determines a patient-specific bias relating to the administration of the fluid bolus based upon prior responses of the patient to fluid administration. The bias can be accomplished by using a state similarity analysis of a subgroup of bolus log entries **502** as discussed above in reference to FIG. 5.

[0187] At stage **1618**, the log predictor component **104** and/or the prediction engine **106** generates a predicted change in cardiac output of the patient in response to administration of the fluid bolus based at least in part upon the information relating to the expected change and the patient-specific bias.

[0188] Attention is now directed to FIG. 17 which is a flowchart depicting another exemplary process **1700** for providing patient-adaptive hemodynamic management in accordance with the disclosure. The process **1700** can be performed by the patient-adaptive hemodynamic management system **10** illustrated in FIGS. 1A and 1B including the control device **100** illustrated in FIGS. 2-8. The process **1700** is exemplary only and not limiting. The process **1700** can be altered, e.g., by having stages added, removed, rearranged, combined and/or performed concurrently.

[0189] At stage **1710**, the vitals manager component **101** receives an indication of at least one of oxygen delivery to tissues of the patient and oxygen utilization by the patient. The indication can be received from a monitoring device such as one of the clinical monitors **115** or from an input to the user interface **810**, for example. The vitals manager component **101** stores the indication in one of the bolus log entries in the vitals log table **202**. The vitals log entry is then communicated to the intervention decision component **107**. Alternatively, the intervention decision component **107** can receive the indication directly.

[0190] At stage **1714**, based upon the indication, the intervention decision component **107** selects an oxygen-carrying fluid from among multiple fluids capable of being infused into the patient. At stage **1718**, the intervention decision component **107** signals, using a processor, selection of the oxygen-carrying fluid for infusion into the patient.

[0191] Attention is now directed to FIG. 18 which is a flowchart depicting another exemplary process **1800** of providing patient-adaptive hemodynamic management in accordance with the disclosure. The process **1800** can be performed by the patient-adaptive hemodynamic management system **10** illustrated in FIGS. 1A and 1B including the control device **100** illustrated in FIGS. 2-8. The process **1800** is exemplary only and not limiting. The process **1800** can be altered, e.g., by having stages added, removed, rearranged, combined and/or performed concurrently.

[0192] At stage **1810**, a network server receives bolus log information from a plurality of fluid delivery systems communicatively coupled to the network server. The fluid delivery systems can include, for example, the patient-adaptive hemodynamic management system **10** discussed above.

After receiving the bolus log information, the process **1800** proceeds to stage **1814** where the network server generates a set of population reference tables respectively containing portions of the bolus log information such as, for example the population reference tables **306** discussed above in reference to FIG. 3.

[0193] At stage **1818**, the network server sends at least a portion of the bolus log information to one or more of the plurality of fluid delivery systems such as the patient-adaptive hemodynamic management system **10**. The patient-adaptive hemodynamic management system **10** can then utilize the population reference tables **306** to predict changes in physiologic parameters of a patient based on an ever increasing population of patients.

[0194] Attention is now directed to FIG. 19 which is a flowchart depicting another exemplary process **1900** of providing patient-adaptive hemodynamic management in accordance with the disclosure. The process **1900** can be performed by the patient-adaptive hemodynamic management system **10** illustrated in FIGS. 1A and 1B including the control device **100** illustrated in FIGS. 2-8. The process **1900** is exemplary only and not limiting. The process **1900** can be altered, e.g., by having stages added, removed, rearranged, combined and/or performed concurrently.

[0195] At stage **1910**, the vitals manager component **101** receive input information relating to one or more physiologic processes of the patient. The input information can be received from one of the clinical monitors **115** and/or from the user interface **810**, for example. The vitals manager component **101** stores information indicative of the input information in a bolus log entry of the bolus log table **202**.

[0196] At stage **1914**, the intervention decision component **107** determines, based upon the input information obtained by receiving the bolus log entry containing the stored information, that a change has occurred in a physiologic parameter of the patient. In response, depending on the physiologic parameter being in one of a plurality of range of values such as one of the ranges **701**, **702**, **703** or **704** discussed above in reference to FIG. 7, the intervention decision component **107** generates a fluid administration signal based at least in part on the change in the physiologic parameter. As discussed above, the administration signal can stop a current bolus, start a new bolus, increase or decrease an infusion rate or maximize an infusion rate, depending on which of the plurality of threshold ranges the physiologic parameter is in.

[0197] Attention is now directed to FIG. 20 which is a flowchart depicting another exemplary process **2000** for providing patient-adaptive hemodynamic management in accordance with the disclosure. The process **2000** can be performed by the patient-adaptive hemodynamic management system **10** illustrated in FIGS. 1A and 1B including the control device **100** illustrated in FIGS. 2-8. The process **2000** is exemplary only and not limiting. The process **2000** can be altered, e.g., by having stages added, removed, rearranged, combined and/or performed concurrently.

[0198] At stage **2010**, the vitals manager component **101** receives input information relating to one or more physiologic processes of the patient **110**. The input information can be received from one of the clinical monitors **115** or from the user interface **810**, for example. Upon receiving the input information, the vitals manager component **101** stores information indicative of the input information in a bolus log entry of the bolus log table **202**.

[0199] At stage 2014, one or more of the population based predictor component 102, the log predictor component 104, the history analysis component 105 and the prediction engine 106 determines, based at least in part upon the input information using the methods discussed above, a predicted change in a physiologic parameter of the patient 110 in response to administration of a fluid bolus to the patient.

[0200] At stage 2018, one or more of the components of the control device 100, e.g., the intervention decision component 107 or the prediction engine 106, provides a fluid administration recommendation in response to the predicted change to the user interface 810. At stage 2022, a display of the user interface 810 displays information relating to the recommendation on the user interface 810. At stage 2022, the intervention decision component 107 or the user interface 810 receives user input relating to the recommendation through the user interface 810. The intervention decision component 107 or the user interface 810 can then generate an administration signal to the pump manager component 108 related to the recommendation.

[0201] Attention is now directed to FIG. 21 which is a flowchart depicting another exemplary process 2100 for providing patient-adaptive hemodynamic management in accordance with the disclosure. The process 2100 can be performed by the patient-adaptive hemodynamic management system 10 illustrated in FIGS. 1A and 1B including the control device 100 illustrated in FIGS. 2-8. The process 2100 is exemplary only and not limiting. The process 2100 can be altered, e.g., by having stages added, removed, rearranged, combined and/or performed concurrently.

[0202] At stage 2110, the vitals manager component 101 receives information relating to an initial change in a physiologic parameter of a patient 110 in response to administration of a first fluid bolus to the patient 110. The received information can be received from one of the clinical monitors 115 or from the user interface 810, for example. Upon receiving the input information, the vitals manager component 101 stores information indicative of the input information in a bolus log entry of the bolus log table 202.

[0203] At stage 2114, one or more of the population based predictor component 102, the log predictor component 104, the history analysis component 105 or the prediction engine 106 determines, based upon the information, a predicted change in the physiologic parameter in response to administration of a second bolus to the patient.

[0204] At stage 2118, the prediction engine 106 or the intervention decision engine 107 can provide a fluid administration recommendation through the user interface 810 in response to the predicted change.

[0205] Attention is now directed to FIG. 22 which is a flowchart depicting another exemplary process 2200 for providing patient-adaptive hemodynamic management in accordance with the disclosure. The process 2200 can be performed by the patient-adaptive hemodynamic management system 10 illustrated in FIGS. 1A and 1B including the control device 100 illustrated in FIGS. 2-8. The process 2200 is exemplary only and not limiting. The process 2200 can be altered, e.g., by having stages added, removed, rearranged, combined and/or performed concurrently.

[0206] At stage 2210, the vitals manager component 101 receives input information relating to one or more physiologic processes of a patient. The input information can be received from one of the clinical monitors 115 or from the user interface 810, for example. Upon receiving the input

information, the vitals manager component 101 stores information indicative of the input information in a bolus log entry of the bolus log table 202.

[0207] At stage 2210, one or more of the log predictor component 104, the history analysis component 105 or the prediction engine 106 determines, based at least in part upon the input information, a subgroup of bolus log entries associated with a current state of the patient.

[0208] At stage 2214, the prediction engine 106 or the intervention decision engine 107 can provide a fluid administration recommendation based at least in part upon log data included within the subgroup of bolus log entries. The fluid administration recommendation can be provided to the user interface 810 to prompt a user for acceptance or rejection of the recommendation. Alternatively, the fluid administration recommendation can be converted to a signal to cause the fluid pump manager component 108 to administer the recommendation automatically.

[0209] Attention is now directed to FIG. 23 which is a flowchart depicting yet another exemplary process 2300 for providing patient-adaptive hemodynamic management in accordance with the disclosure. The process 2300 can be performed by the patient-adaptive hemodynamic management system 10 illustrated in FIGS. 1A and 1B including the control device 100 illustrated in FIGS. 2-8. The process 2300 is exemplary only and not limiting. The process 2300 can be altered, e.g., by having stages added, removed, rearranged, combined and/or performed concurrently.

[0210] At stage 2314, the vitals manager component 101 or the fluid bolus log component 103 determines a first effect on a physiologic parameter of the patient associated with administration of a first fluid bolus to the patient.

[0211] At stage 2318, the fluid bolus log component 103 stores first information relating to the first effect in a first bolus log entry 400. At stage 2322, the vitals manager component 101 or the fluid bolus log component 103 determines a second effect on a physiologic parameter of the patient associated with administration of a second fluid bolus to the patient.

[0212] At stage 2326, the fluid bolus log component 103 stores second information relating to the second effect in a second bolus log entry 400.

[0213] At stage 2330, one or more of the population based predictor component 102, the log predictor component 104, the history analysis component 105, the intervention decision engine 107 or the prediction engine 106 provides, a fluid administration recommendation based at least in part upon at least one of the first bolus log entry and the second bolus log entry using the methods discussed above. The recommendation can be provided to the user interface 810 to prompt a user for acceptance or rejection of the recommendation. Alternatively, the fluid administration recommendation can be converted to a signal to cause the fluid pump manager component 108 to administer the recommendation automatically.

[0214] Attention is now directed to FIG. 24 which is a flowchart depicting another exemplary process 2400 for providing patient-adaptive hemodynamic management including a clinical intervention in accordance with the disclosure. The process 2400 can be performed by the patient-adaptive hemodynamic management system 10 illustrated in FIGS. 1A and 1B including the control device 100 illustrated in FIGS. 2-8. The process 2400 is exemplary only and not limiting. The process 2400 can be altered, e.g.,

by having stages added, removed, rearranged, combined and/or performed concurrently.

[0215] At stage 2410, the log predictor component 104 receives bolus log information, e.g., from the fluid bolus log component 103, relating to one or more effects on a state of the patient associated with prior administration of fluid to the patient. At stage 2414, the log predictor component 104 determines, based upon the bolus log information, a predicted change in a physiologic parameter of the patient in response to the administration of a fluid bolus to the patient.

[0216] At decision block 2418, the intervention decision component 107 determines if clinical intervention is required. The decision can be made based on the physiologic parameter lies in one of a plurality of range of values such as the one of the ranges 701, 702, 703 or 704 discussed above in reference to FIG. 7. If it is determined that clinical intervention is not required, the process 2400 continues to stage 2430 where the intervention decision component 107 and the pump manager component 108 communicate with each other to generate a fluid administration signal based upon the predicted change.

[0217] If, at stage 2418, it is determined that clinical intervention is required, the process 2400 continues at stage 2422 where the intervention decision component 107 provides a fluid administration recommendation through the user interface 810 based upon the predicted change. The fluid administration signal can recommend to a user what fluid administration is recommended.

[0218] At stage 2426, the intervention decision component 107 or the user interface 810 receives user input relating to the recommendation through the user interface 810. After receiving the user input, the process continues at stage 2430 where the intervention decision component 107 or the user interface 810 generates a fluid administration signal to the pump manager component 108 to affect the fluid administration to the patient based upon the predicted change and further based upon the user input.

[0219] Attention is now directed to FIG. 25 which is a flowchart depicting another exemplary process 2500 of providing patient-adaptive hemodynamic management including a clinical intervention in accordance with the disclosure. The process 2500 can be performed by the patient-adaptive hemodynamic management system 10 illustrated in FIGS. 1A and 1B including the control device 100 illustrated in FIGS. 2-8. The process 2500 is exemplary only and not limiting. The process 2500 can be altered, e.g., by having stages added, removed, rearranged, combined and/or performed concurrently.

[0220] At stage 2510, the population based predictor component 102 receives information relating to an expected change in a physiologic parameter of patients in a patient population in response to infusion of a fluid bolus in the patients. At stage 2414, the population based predictor component 102 determines, based at least in part upon the information using the methods discussed above, a predicted change in the physiologic parameter of the patient in response to administration of the fluid bolus to the patient.

[0221] At decision block 2518, the intervention decision component 107 determines if clinical intervention is required. The decision can be made based on the physiologic parameter lies in one of a plurality of range of values such as the one of the ranges 701, 702, 703 or 704 discussed above in reference to FIG. 7. If it is determined that clinical intervention is not required, the process 2500 continues to

stage 2530 where the intervention decision component 107 and the pump manager component 108 communicate with each other to generate a fluid administration signal based upon the predicted change.

[0222] If, at stage 2518, it is determined that clinical intervention is required, the process 2500 continues at stage 2522 where the intervention decision component 107 provides a fluid administration recommendation through the user interface 810 based upon the predicted change. The fluid administration signal can recommend to a user what fluid administration is recommended.

[0223] At stage 2526, the intervention decision component 107 or the user interface 810 receives user input relating to the recommendation through the user interface 810. After receiving the user input, the process continues at stage 2530 where the intervention decision component 107 or the user interface 810 generates a fluid administration signal to the pump manager component 108 to affect the fluid administration to the patient based upon the predicted change and further based upon the user input.

[0224] Attention is now directed to FIG. 26 which is a flowchart depicting yet another exemplary process 2600 of providing patient-adaptive hemodynamic management including a clinical intervention in accordance with the disclosure. The process 2600 can be performed by the patient-adaptive hemodynamic management system 10 illustrated in FIGS. 1A and 1B including the control device 100 illustrated in FIGS. 2-8. The process 2600 is exemplary only and not limiting. The process 2600 can be altered, e.g., by having stages added, removed, rearranged, combined and/or performed concurrently.

[0225] At stage 2610, the fluid bolus log component 103 receives bolus log information relating to one or more effects on a state of the patient associated with prior administration of fluid to the patient. At stage 2614, the log predictor component 104 determines, based upon the bolus log information and using the methods discussed above, a predicted change in a physiologic parameter of the patient in response to the administration of a fluid bolus to the patient.

[0226] At decision block 2618, the intervention decision component 107 determines if clinical intervention is required. The decision can be made based on the physiologic parameter lies in one of a plurality of range of values such as the one of the ranges 701, 702, 703 or 704 discussed above in reference to FIG. 7. If it is determined that clinical intervention is not required, the process 2600 continues to stage 2630 where the intervention decision component 107 and the pump manager component 108 communicate with each other to generate a fluid administration signal based upon the predicted change.

[0227] If, at stage 2618, it is determined that clinical intervention is required, the process 2600 continues at stage 2622 where the intervention decision component 107 provides a fluid administration recommendation through the user interface 810 based upon the predicted change. The fluid administration signal can recommend to a user what fluid administration is recommended.

[0228] At stage 2626, the intervention decision component 107 or the user interface 810 receives user input relating to the recommendation through the user interface 810. After receiving the user input, the process continues at stage 2630 where the intervention decision component 107 or the user interface 810 generates a fluid administration signal to the pump manager component 108 to affect the fluid adminis-

tration to the patient based upon the predicted change and further based upon the user input.

[0229] A display of a possible user interface could comprise a standard “Starling Curve” of ventricular function, a graphical indicator of where the patient is perceived to be presently along that curve, and a band showing the ideal range of the curve for the patient. In addition, minimum and maximum curves can be displayed showing the observed ranges of cardiac function in a given patient (not shown).

[0230] FIG. 27 is a summary of a table of results from initial studies using the methodology of the control device 100 in simulations. The performance of the control device 100 was compared to the performance of anesthesiologists across a number of dimensions. The table in FIG. 27 is presented as evidence of the effectiveness of the methodology of the control device 100 in the studies. Closed-loop management of fluid resuscitation has historically been difficult. The table in FIG. 27 is representative of simulation data for a closed-loop fluid-management algorithm using pulse pressure variation (PPV) as the input variable.

[0231] Using a simulator which includes physiologic PPV output, twenty practicing anesthesiology residents and faculty were asked to manage fluids and pressors for a one-hour simulated hemorrhage case of 2L blood loss over 20 minutes (group 1). One week later, they repeated the simulation, but this time fluids were secretly managed by the closed-loop system while practitioner fluid administrations were ignored and only the pressors were entered (group 2). The simulation was also run twenty times with only the closed-loop (group 3) and twenty times with no management (group 4). As illustrated by the data included in FIG. 27, conditions across all groups were similar at baseline for simulated patient weight, height, heart rate (HR), mean arterial pressure (MAP), and cardiac output (CO). Once the hemorrhage began, the closed loop groups (2&3) intervened significantly earlier than the practitioners (group 1) and gave more fluid. The mean and final CO was higher in both closed-loop groups than in the practitioners group, and the coefficient of variance was lower. There was no difference in MAP between intervention groups, but all were significantly higher than the unmanaged group. In conclusion, the data demonstrate that closed-loop management of fluid resuscitation is feasible using a dynamic parameter based algorithm and that this approach can be used to optimize cardiac output.

[0232] In one or more exemplary embodiments, the functions, methods and processes described may be implemented in hardware, software, firmware, or any combination thereof. If implemented in software, the functions may be stored on or encoded as one or more instructions or code on a computer-readable medium. Computer-readable media includes computer storage media. Storage media may be any available media that can be accessed by a computer. By way of example, and not limitation, such computer-readable media can comprise RAM, ROM, EEPROM, CD-ROM or other optical disk storage, magnetic disk storage or other magnetic storage devices, or any other medium that can be used to carry or store desired program code in the form of instructions or data structures and that can be accessed by a computer. Disk and disc, as used herein, includes compact disc (CD), laser disc, optical disc, digital versatile disc (DVD), floppy disk and blu-ray disc where disks usually reproduce data magnetically, while discs reproduce data

optically with lasers. Combinations of the above should also be included within the scope of computer-readable media.

[0233] As used herein, computer program products comprising computer-readable media including all forms of computer-readable medium except, to the extent that such media is deemed to be non-statutory, transitory propagating signals.

[0234] It is understood that the specific order or hierarchy of steps or stages in the processes and methods disclosed are examples of exemplary approaches. Based upon design preferences, it is understood that the specific order or hierarchy of steps in the processes may be rearranged while remaining within the scope of the present disclosure. The accompanying method claims present elements of the various steps in a sample order, and are not meant to be limited to the specific order or hierarchy presented.

[0235] Those of skill in the art would understand that information and signals may be represented using any of a variety of different technologies and techniques. For example, data, instructions, commands, information, signals, bits, symbols, and chips that may be referenced throughout the above description may be represented by voltages, currents, electromagnetic waves, magnetic fields or particles, optical fields or particles, or any combination thereof.

[0236] Those of skill would further appreciate that the various illustrative logical blocks, modules, circuits, and algorithm steps described in connection with the embodiments disclosed herein may be implemented as electronic hardware, computer software, or combinations of both. To clearly illustrate this interchangeability of hardware and software, various illustrative components, blocks, modules, circuits, and steps have been described above generally in terms of their functionality. Whether such functionality is implemented as hardware or software depends upon the particular application and design constraints imposed on the overall system. Skilled artisans may implement the described functionality in varying ways for each particular application, but such implementation decisions should not be interpreted as causing a departure from the scope of the present disclosure.

[0237] The various illustrative logical blocks, modules, and circuits described in connection with the embodiments disclosed herein may be implemented or performed with a general purpose processor, a digital signal processor (DSP), an application specific integrated circuit (ASIC), a field programmable gate array (FPGA) or other programmable logic device, discrete gate or transistor logic, discrete hardware components, or any combination thereof designed to perform the functions described herein. A general purpose processor may be a microprocessor, but in the alternative, the processor may be any conventional processor, controller, microcontroller, or state machine. A processor may also be implemented as a combination of computing devices, e.g., a combination of a DSP and a microprocessor, a plurality of microprocessors, one or more microprocessors in conjunction with a DSP core, or any other such configuration.

[0238] The steps or stages of a method, process or algorithm described in connection with the embodiments disclosed herein may be embodied directly in hardware, in a software module executed by a processor, or in a combination of the two. A software module may reside in RAM memory, flash memory, ROM memory, EPROM memory, EEPROM memory, registers, hard disk, a removable disk, a

CD-ROM, or any other form of storage medium known in the art. An exemplary storage medium is coupled to the processor such the processor can read information from, and write information to, the storage medium. In the alternative, the storage medium may be integral to the processor. The processor and the storage medium may reside in an ASIC. The ASIC may reside in a user terminal. In the alternative, the processor and the storage medium may reside as discrete components in a user terminal.

[0239] The previous description of the disclosed embodiments is provided to enable any person skilled in the art to make or use the present disclosure. Various modifications to these embodiments will be readily apparent to those skilled in the art, and the generic principles defined herein may be applied to other embodiments without departing from the spirit or scope of the disclosure. Thus, the present disclosure is not intended to be limited to the embodiments shown herein but is to be accorded the widest scope consistent with the principles and novel features disclosed herein.

[0240] The disclosure is not intended to be limited to the aspects shown herein, but is to be accorded the full scope consistent with the specification and drawings, wherein reference to an element in the singular is not intended to mean “one and only one” unless specifically so stated, but rather “one or more.” Unless specifically stated otherwise, the term “some” refers to one or more. A phrase referring to “at least one of” a list of items refers to any combination of those items, including single members. As an example, “at least one of: a, b, or c” is intended to cover: a; b; c; a and b; a and c; b and c; and a, b and c.

[0241] The previous description of the disclosed aspects is provided to enable any person skilled in the art to make or use the present disclosure. Various modifications to these aspects will be readily apparent to those skilled in the art, and the generic principles defined herein may be applied to other aspects without departing from the spirit or scope of the disclosure. Thus, the disclosure is not intended to be limited to the aspects shown herein but is to be accorded the widest scope consistent with the principles and novel features disclosed herein. It is intended that the following claims and their equivalents define the scope of the disclosure.

1-21. (canceled)

22. An intravenous fluid management device comprising: a fluid supply comprising intravenous fluid that is substantially free of vasoactive medication;

a fluid control device fluidly coupled to the fluid supply and configured to control a rate of flow of the intravenous fluid from the fluid supply into a patient; and control circuitry communicatively coupled to the fluid control device and configured to:

receive an input signal indicating a physiologic parameter value associated with the patient;

determine, based at least in part on the physiological parameter value, a predicted change in cardiac output of the patient in response to intravenous infusion of a bolus of the intravenous fluid into the patient; and

provide a pump control signal to the fluid control device based at least in part on the predicted change to cause the fluid control device to provide a fluid bolus from the intravenous fluid into the patient.

23. The intravenous fluid management device of claim **22**, further comprising data storage configured to store bolus log

information indicating efficacy of one or more previously-administered fluid boluses, wherein the predicted change is based at least in part on the bolus log information.

24. The intravenous fluid management device of claim **23**, wherein the control circuitry is further configured to determine that the input signal represents valid physiological parameter data, and to store the physiological parameter data in a vitals log maintained in the data storage of the control circuitry.

25. The intravenous fluid management device of claim **24** wherein said determining that the input signal represents valid physiological parameter data involves determining that the physiological parameter value is within a standard deviation of a mean value for related physiological parameter data.

26. The intravenous fluid management device of claim **22**, wherein the control circuitry is further configured to:

generate a characterization of a hemodynamic state of the patient based at least in part on two or more of the group of parameters consisting of heart rate, stroke volume, systemic vascular resistance, and dynamic predictors; and

compare the characterization of the hemodynamic state of the patient with population data to identify a population reference table for the patient;

wherein the predicted change in cardiac output of the patient is based at least in part on the population reference table.

27. The intravenous fluid management device of claim **26**, wherein said comparing the characterization of the hemodynamic state of the patient with the population data involves comparing comorbidities of the patient with similar data stored in association with the population data.

28. The intravenous fluid management device of claim **22**, wherein the control circuitry is further configured to determine a quality of the predicted change.

29. The intravenous fluid management device of claim **28**, wherein the quality of the predicted change is based on a specificity of a population reference table associated with the patient.

30. An intravenous fluid management device comprising: a fluid flow control device configured to control a rate of flow of intravenous fluid from a fluid source; a physical housing; and

control circuitry disposed within the physical housing and communicatively coupled to the fluid flow control device via an electrical communication interface, the control circuitry being configured to:

receive, from a monitor device, an input signal indicating a physiologic parameter value associated with a physiologic parameter of a patient;

determine state similarities between the physiologic parameter value and physiologic parameter values associated with a plurality of respective intravenous fluid boluses previously administered to the patient; and

determine, based at least in part on the state similarities, a predicted change in cardiac output of the patient in response to intravascular volume expansion caused by administration of an intravenous fluid bolus to the patient.

31. The intravenous fluid management device of claim **30**, wherein the state similarities are respectively based on a plurality of different types of physiological parameter values.

32. The intravenous fluid management device of claim **31**, wherein the state similarities are based on a weighed combination of the plurality of different types of physiological parameter values.

33. The intravenous fluid management device of claim **30**, wherein the control circuitry is further configured to determine an actual change in cardiac output of the patient in response to administration of the intravenous fluid bolus, and to compare the predicted change in cardiac output to the actual change in cardiac output to determine a historical accuracy of the predicted change.

34. The intravenous fluid management device of claim **30**, wherein the predicted change in cardiac output comprises a worst-case predicted cardiac output value and a best-case predicted cardiac output value.

35. The intravenous fluid management device of claim **34**, wherein the worst-case predicted cardiac output value and the best-case predicted cardiac output value are determined by subtracting and adding, respectively, a standard deviation of error value from a determined cardiac output value.

36. The intravenous fluid management device of claim **30**, wherein the control circuitry is further configured to determine that the predicted change in cardiac output falls within a predetermined range.

37. The intravenous fluid management device of claim **36**, wherein the control circuitry is further configured to, in response to the determination that the predicted change falls within the predetermined range, cause present intravenous fluid administration to the patient to be ceased.

38. The intravenous fluid management device of claim **36**, wherein the control circuitry is further configured to, in response to the determination that the predicted change falls within the predetermined range, cause a test bolus of the intravenous fluid to be administered to the patient from the fluid source. (new)

39. The intravenous fluid management device of claim **30**, wherein the control circuitry is further configured to generate a fluid administration recommendation in response to the predicted change in cardiac output.

40. An intravenous fluid management device comprising: a fluid flow control device configured to control a rate of flow of intravenous fluid from a fluid source;

a physical housing; and

control circuitry disposed within the physical housing and communicatively coupled to the fluid flow control device via an electrical communication interface, the controller configured to:

receive, from a monitor device, an input signal indicating a current physiologic parameter value associated with a physiologic parameter of a patient;

determine a group of fluid bolus responses associated with a population of patients based at least in part on the current physiologic parameter value;

determine, based at least in part on the group of fluid bolus responses, a predicted change in cardiac output of the patient in response to intravascular volume expansion caused by administration of a new intravenous fluid bolus to the patient; and

provide a pump control signal to the fluid flow control device over the electrical communication interface based at least in part on the predicted change to cause the fluid flow control device to provide the intravenous fluid bolus to the patient in order to effect intravascular volume expansion.

41. The intravenous fluid management device of claim **40**, wherein the control circuitry is further configured to determine a patient-specific bolus response associated with the patient based at least in part on the current physiologic parameter value and a physiologic parameter value associated with an intravenous fluid bolus previously administered to the patient, and wherein said determining the predicted change in cardiac output is based at least in part on the patient-specific bolus response.

42. The intravenous fluid management device of claim **40**, wherein the fluid flow control device is disposed within the physical housing.

43. The intravenous fluid management device of claim **40**, wherein the control circuitry is further configured to calculate a running average of change in cardiac output for the group of fluid bolus responses.

* * * * *

专利名称(译)	闭环患者自适应血流动力学管理系统和方法		
公开(公告)号	US20200121851A1	公开(公告)日	2020-04-23
申请号	US16/723737	申请日	2019-12-20
[标]申请(专利权)人(译)	加利福尼亚大学董事会		
申请(专利权)人(译)	加利福尼亚大学董事会		
当前申请(专利权)人(译)	加利福尼亚大学董事会		
[标]发明人	RINEHART JOSEPH B CANNESSON MAXIME		
发明人	RINEHART, JOSEPH B. CANNESSON, MAXIME		
IPC分类号	A61M5/172 A61M5/168 A61M5/142 A61B5/029 A61B5/00 G16H20/17		
CPC分类号	A61M2202/0208 A61B5/021 A61M2230/04 A61B5/0245 A61M5/16877 A61M5/1723 A61M5/142 A61B5/4833 A61M2230/00 G16H20/17 A61B5/029 A61B5/0295 A61B5/7203 A61B5/14542 A61M2205/52 A61M2205/502		
优先权	61/432081 2011-01-12 US		
外部链接	Espacenet USPTO		

摘要(译)

描述了一种用于患者自适应血液动力学管理的系统和方法。一个实施例包括一种用于血液动力学管理的系统，该系统包括输血，使用静脉内液体进行大量复苏和药物，利用监测的血液动力学参数，包括所描述的流体反应性的动态预测因子，并且包括能够使装置的功能适应特定患者的智能算法。。

