



(19) **United States**

(12) **Patent Application Publication**  
**SILAWAN et al.**

(10) **Pub. No.: US 2017/0105662 A1**  
(43) **Pub. Date: Apr. 20, 2017**

(54) **EMOTION ESTIMATING METHOD,  
EMOTION ESTIMATING APPARATUS, AND  
RECORDING MEDIUM STORING  
PROGRAM**

*A61B 5/00* (2006.01)  
*A61B 5/08* (2006.01)  
*A61B 5/145* (2006.01)  
*A61B 5/11* (2006.01)  
*A61B 5/053* (2006.01)  
*A61B 5/16* (2006.01)  
*A61B 5/021* (2006.01)

(71) Applicant: **Panasonic Intellectual Property  
Corporation of Ame, Torrance, CA  
(US)**

(52) **U.S. Cl.**  
CPC ..... *A61B 5/1171* (2016.02); *A61B 5/165*  
(2013.01); *A61B 5/02055* (2013.01); *A61B*  
*5/0476* (2013.01); *A61B 5/026* (2013.01);  
*A61B 5/021* (2013.01); *A61B 5/02108*  
(2013.01); *A61B 5/0816* (2013.01); *A61B*  
*5/14542* (2013.01); *A61B 5/11* (2013.01);  
*A61B 5/053* (2013.01); *A61B 5/4803*  
(2013.01); *G10L 25/63* (2013.01)

(72) Inventors: **NAWATT SILAWAN, Osaka (JP);  
KOICHI KUSUKAME, Nara (JP);  
SHINJI UCHIDA, Osaka (JP);  
SHINICHI SHIKII, Nara (JP); AKI  
YONEDA, Hyogo (JP); TATSUO  
ITOH, Osaka (JP)**

(21) Appl. No.: **15/288,866**

(22) Filed: **Oct. 7, 2016**

(57) **ABSTRACT**

**Related U.S. Application Data**

(60) Provisional application No. 62/241,374, filed on Oct. 14, 2015.

**Foreign Application Priority Data**

Feb. 18, 2016 (JP) ..... 2016-029363

**Publication Classification**

(51) **Int. Cl.**  
*A61B 5/1171* (2006.01)  
*A61B 5/0205* (2006.01)  
*A61B 5/0476* (2006.01)  
*A61B 5/026* (2006.01)

An emotion estimating method includes: acquiring first data and second data from the subject, the first data corresponding to physiology data, and the second data corresponding to one of physiology data different from the first data and non-physiology data; calculating a first value and a second value based on the acquired first data and second data, the first value indicating a degree of arousal of the subject and the second value indicating a degree of valence of the subject; estimating the emotion of the subject, by using the calculated first value and second value and based on a predetermined association of people's emotions with a degree of arousal and a degree of valence of the people, the predetermined association being pre-stored in a memory; and outputting information indicating the estimated emotion.

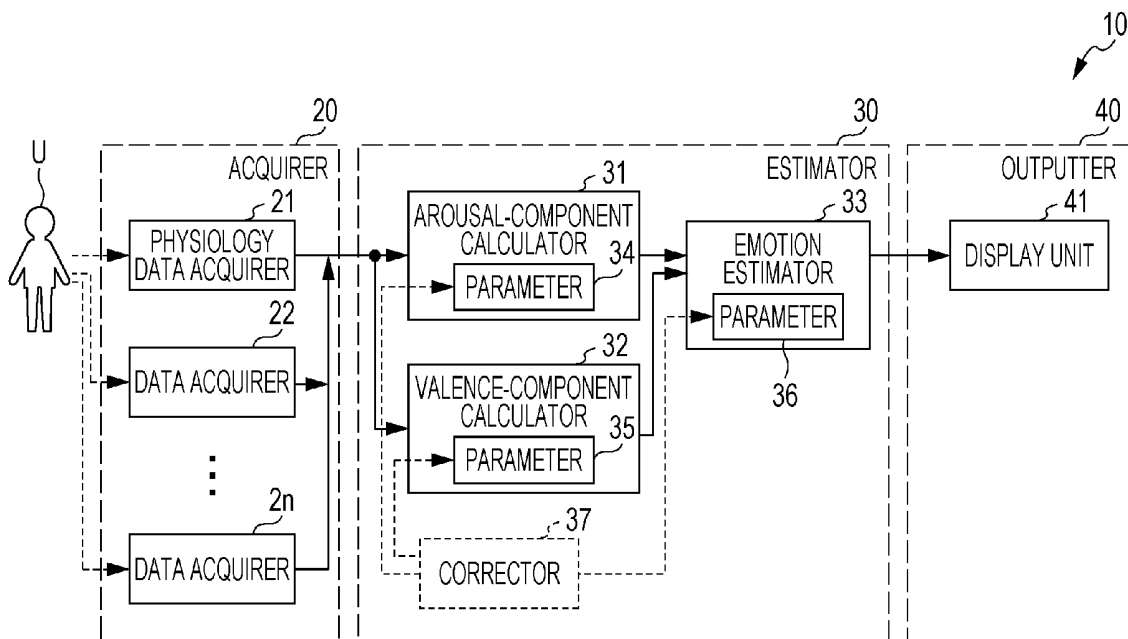

FIG. 1

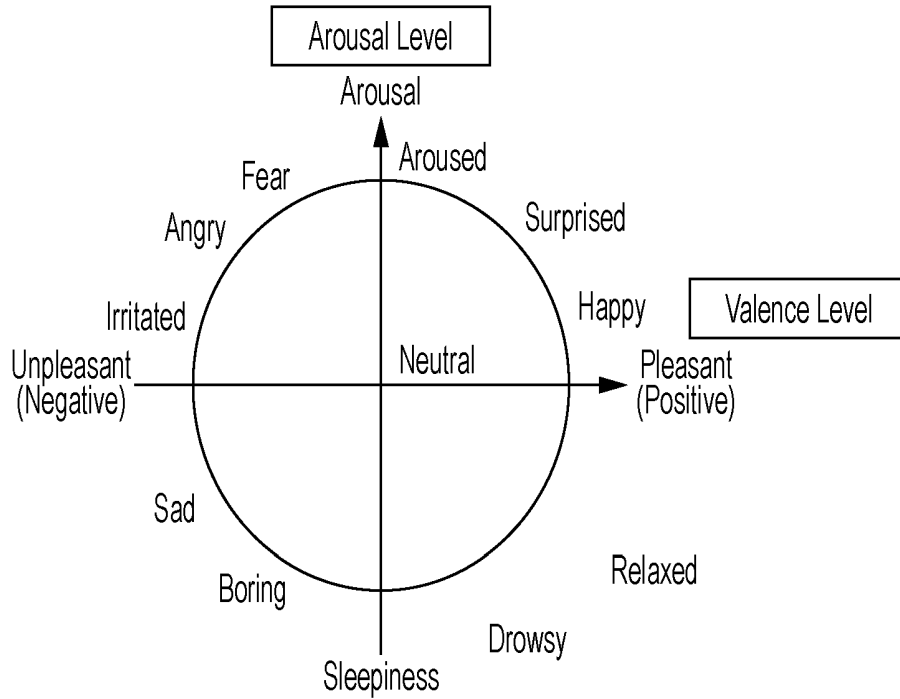

FIG. 2

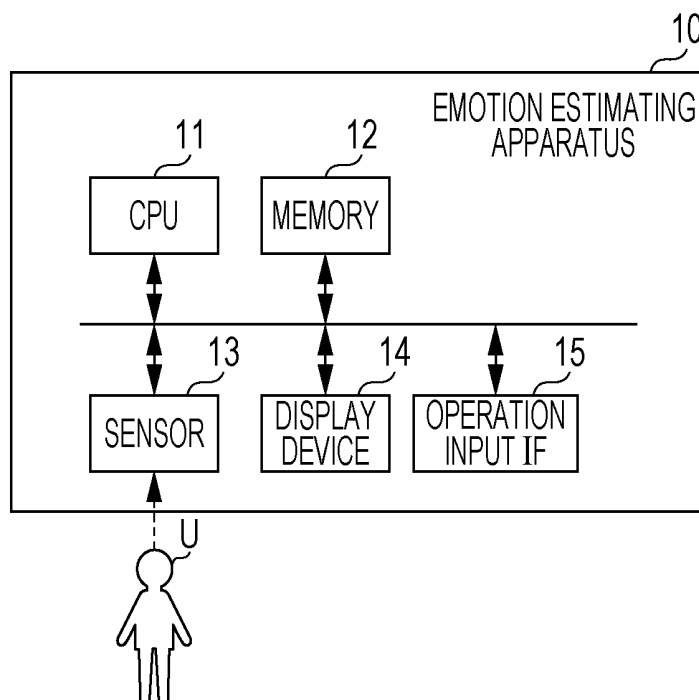

FIG. 3

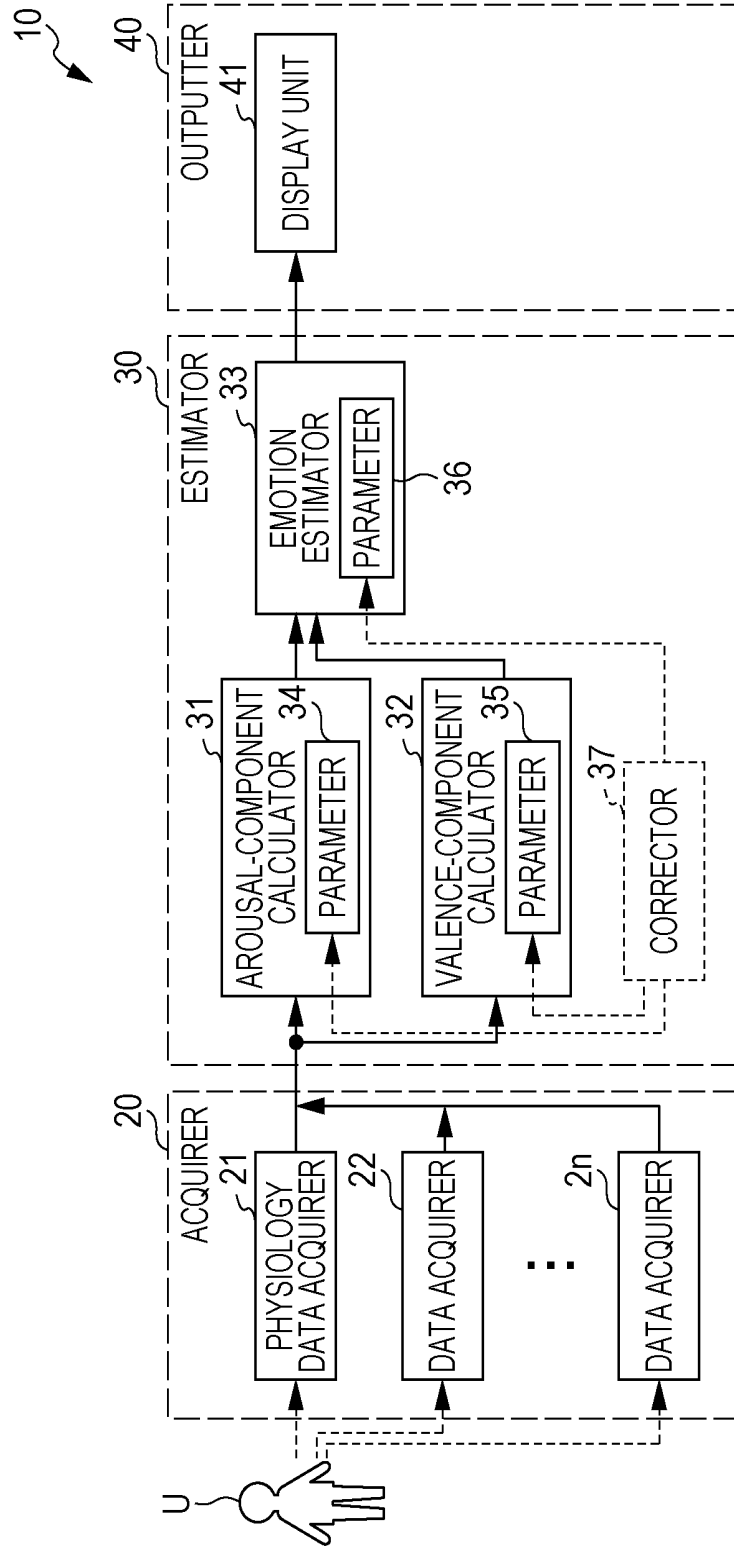

FIG. 4

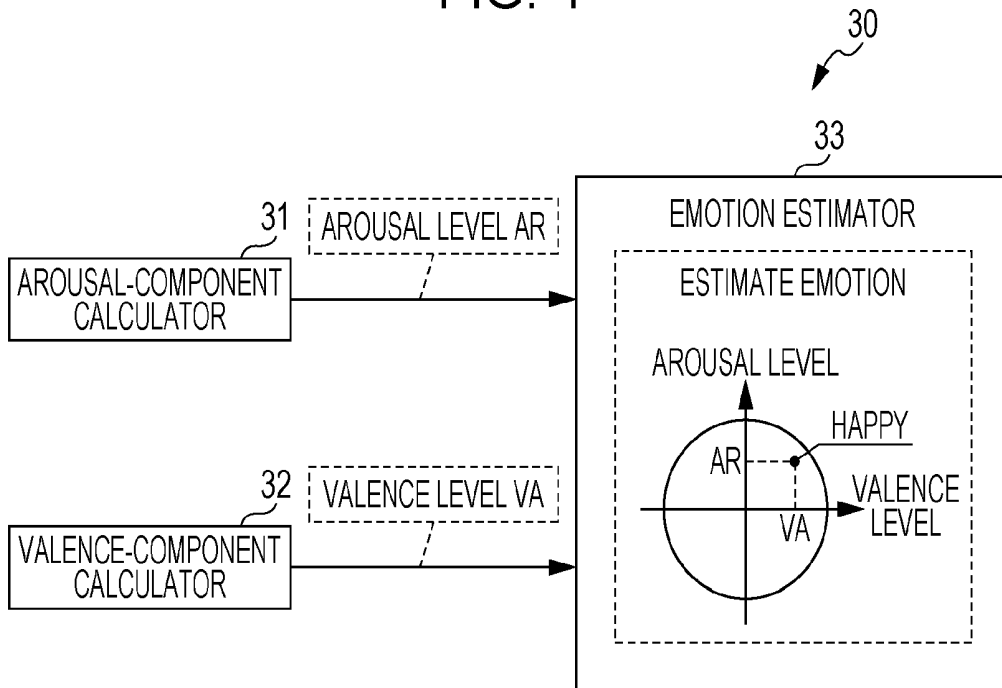
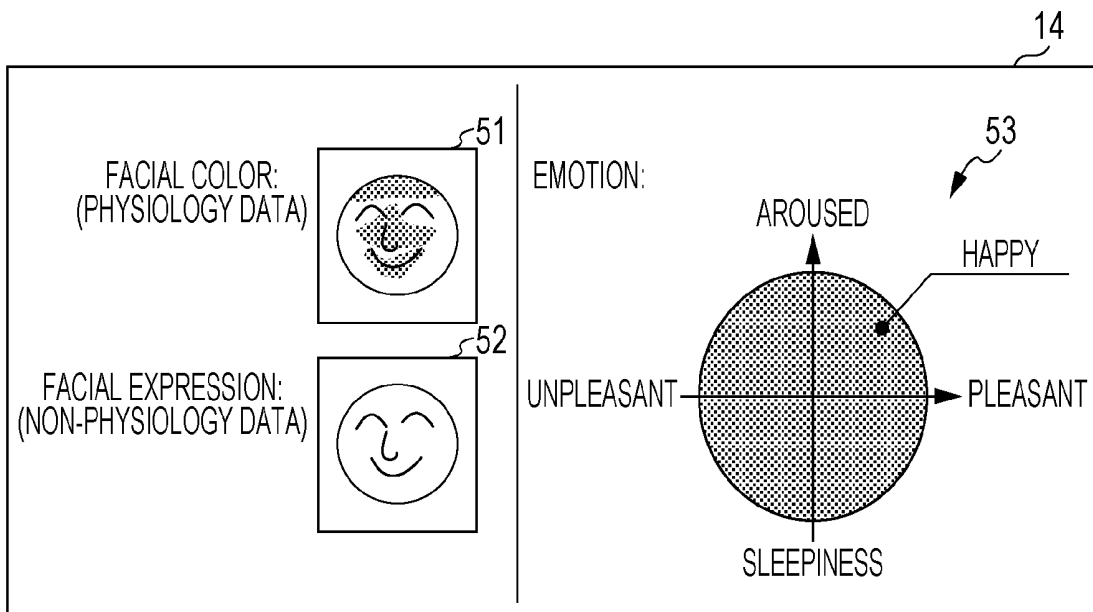
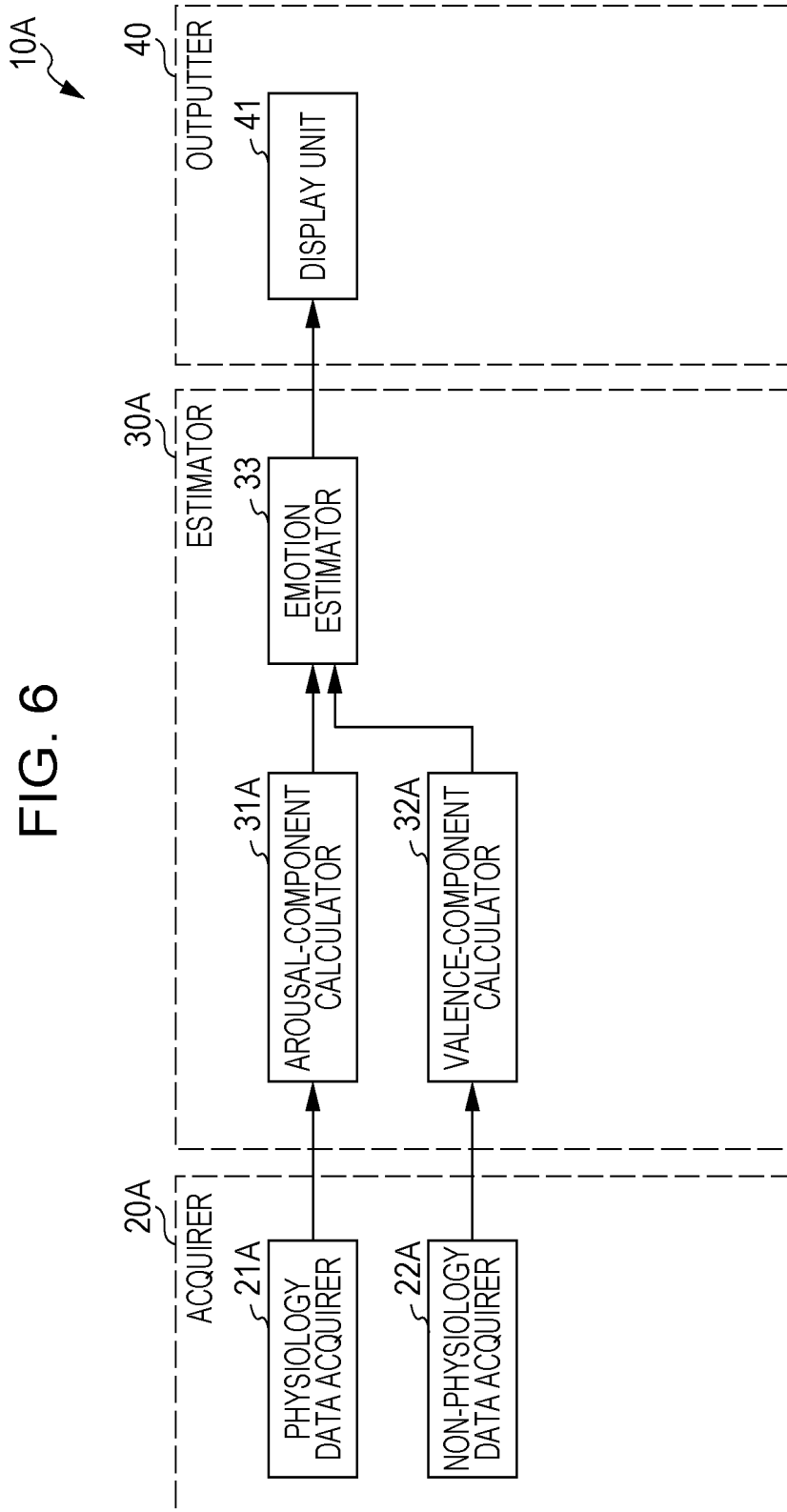

FIG. 5





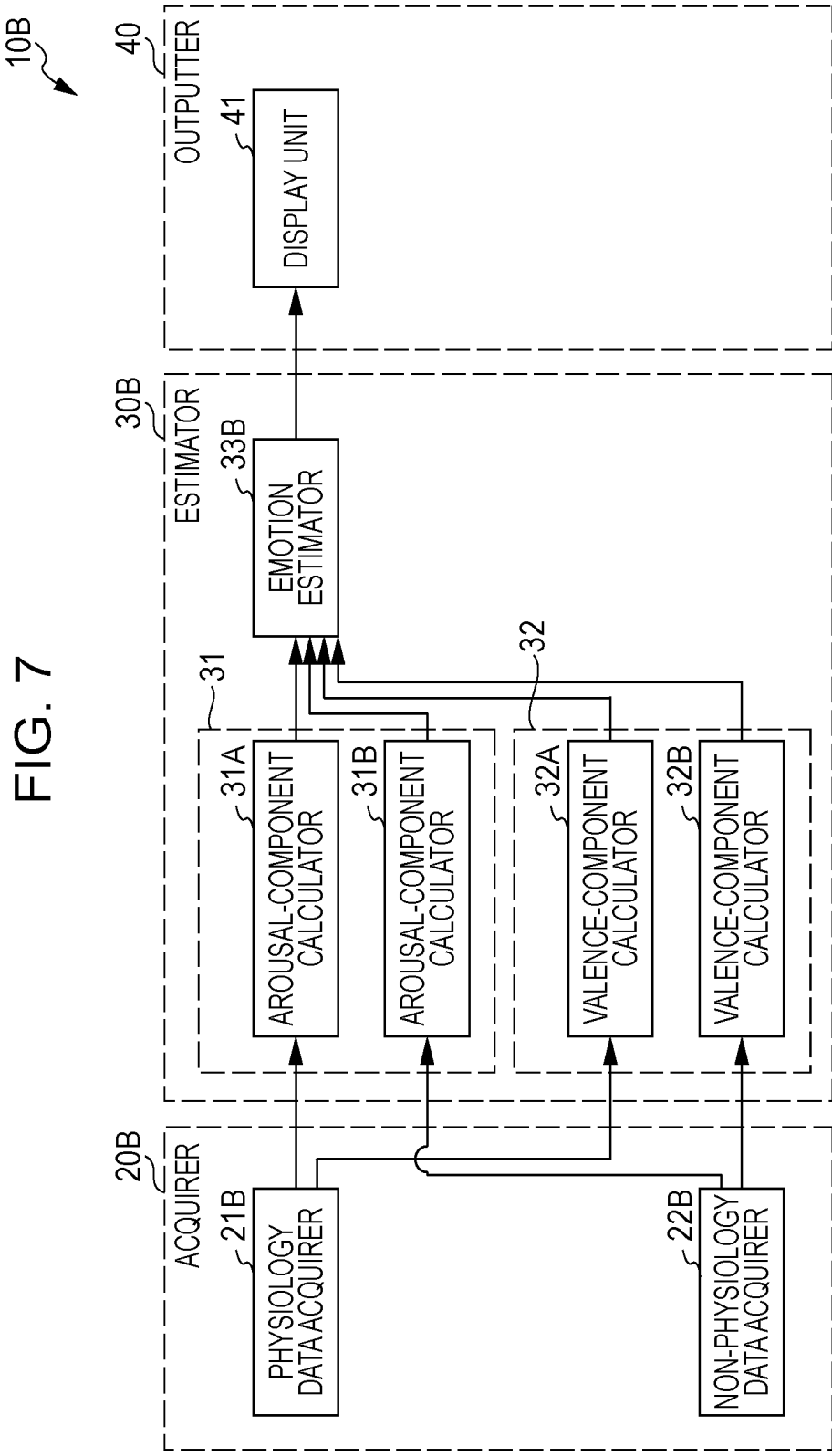
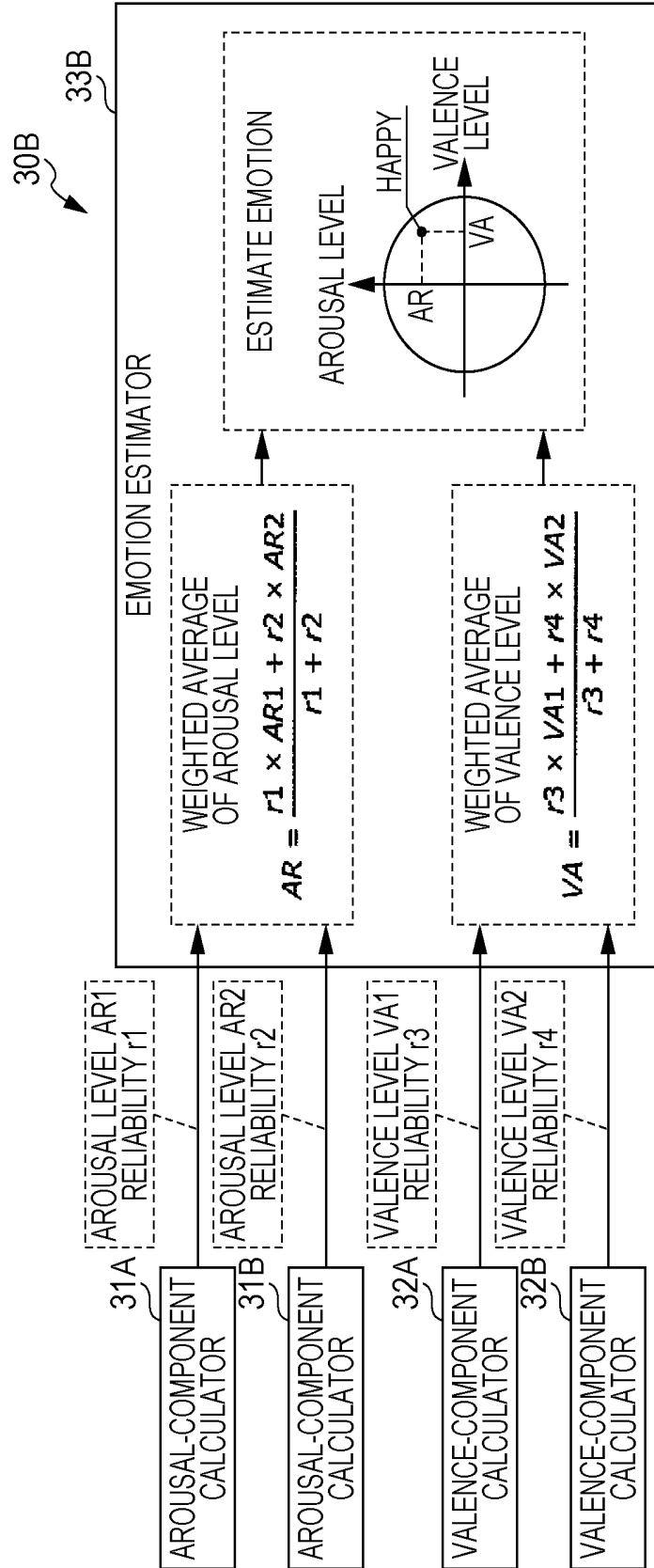

FIG. 7

FIG. 8



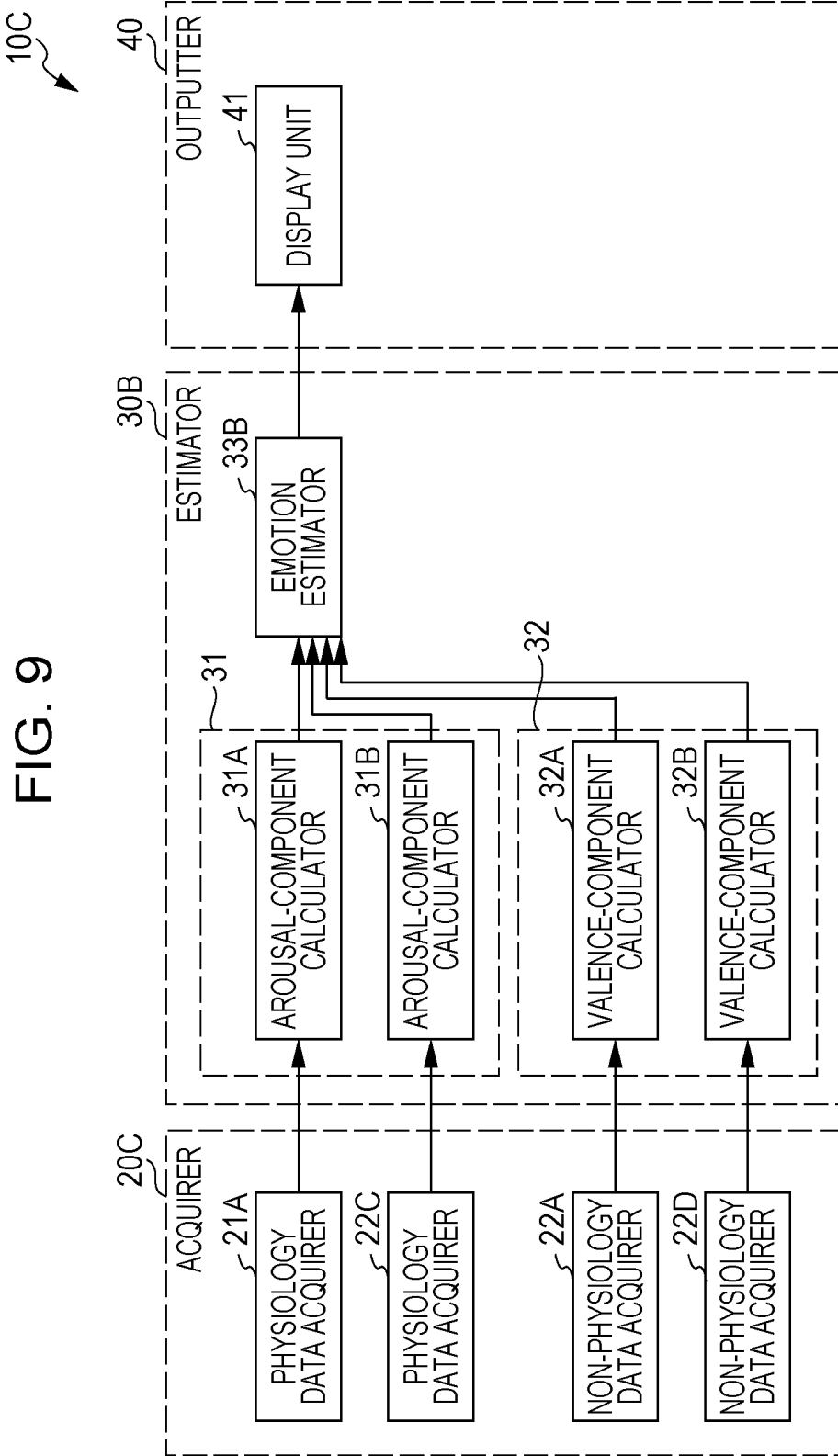

FIG. 9

FIG. 10

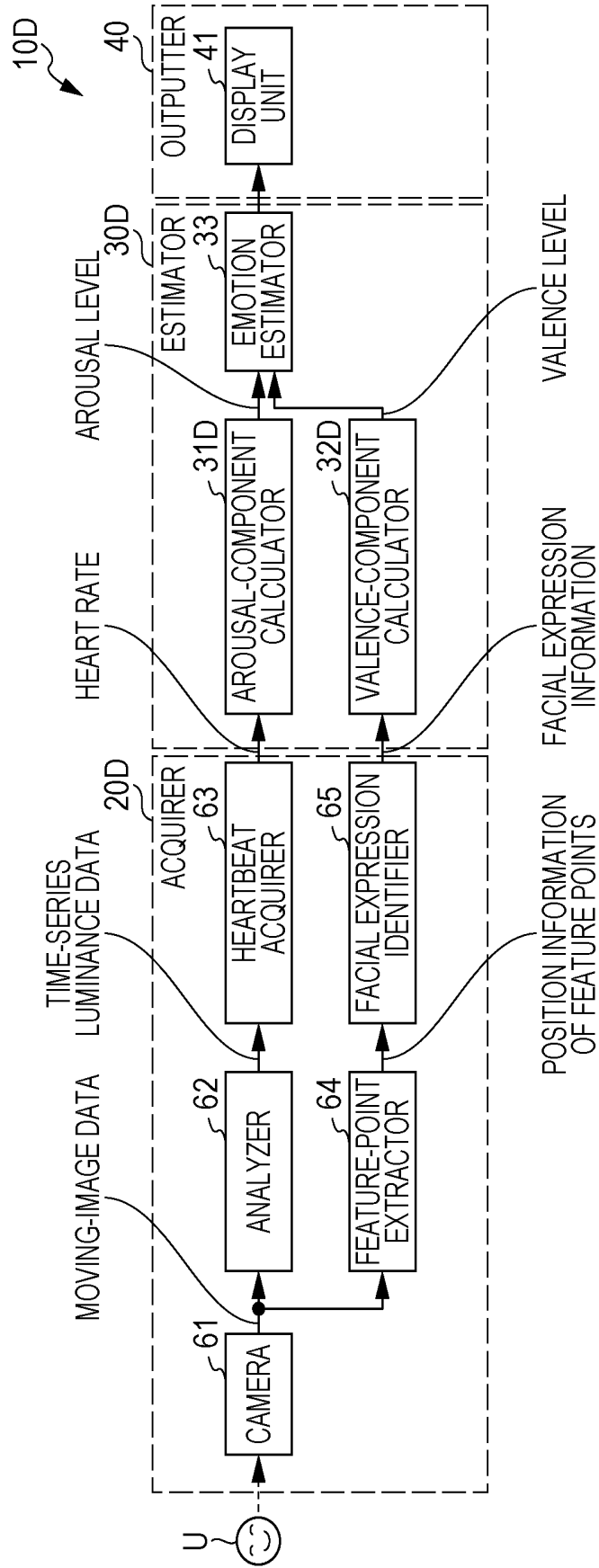

FIG. 11

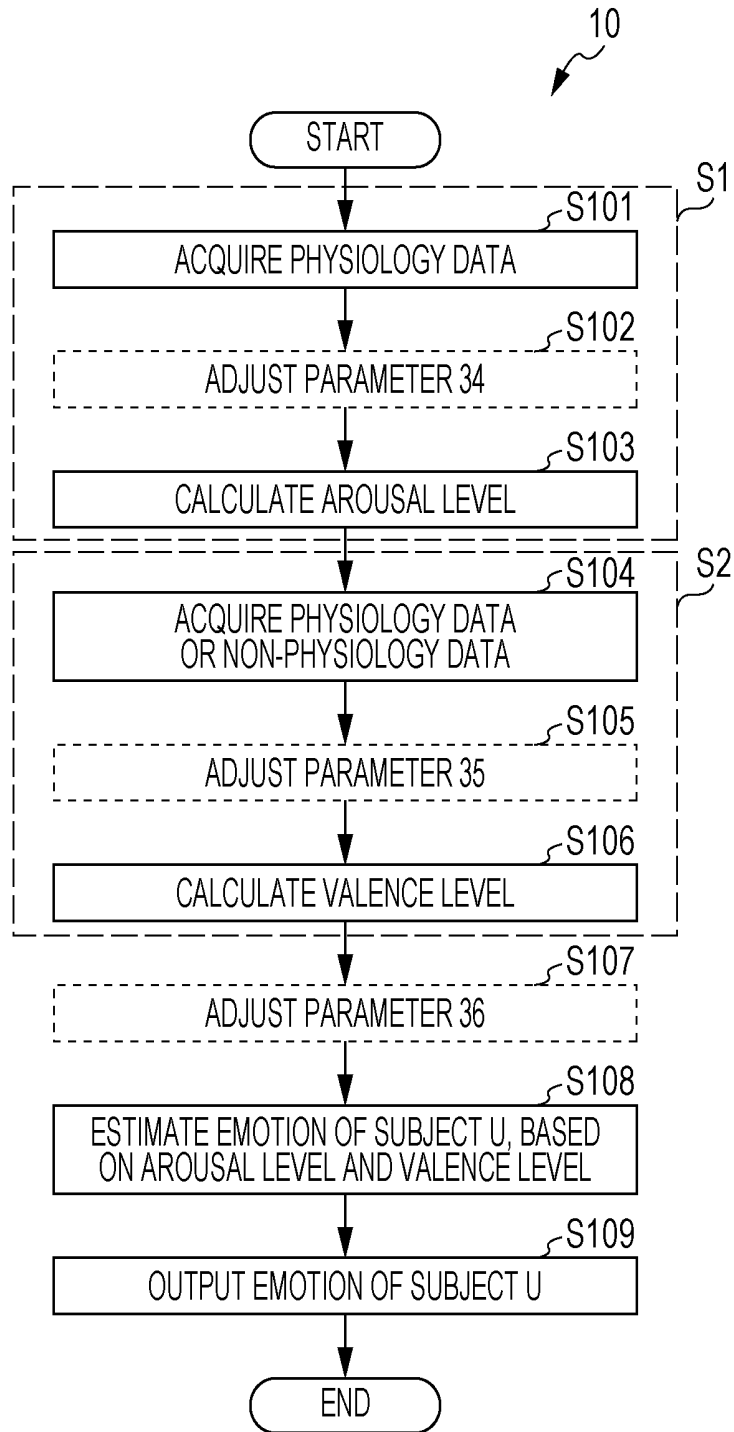

FIG. 12

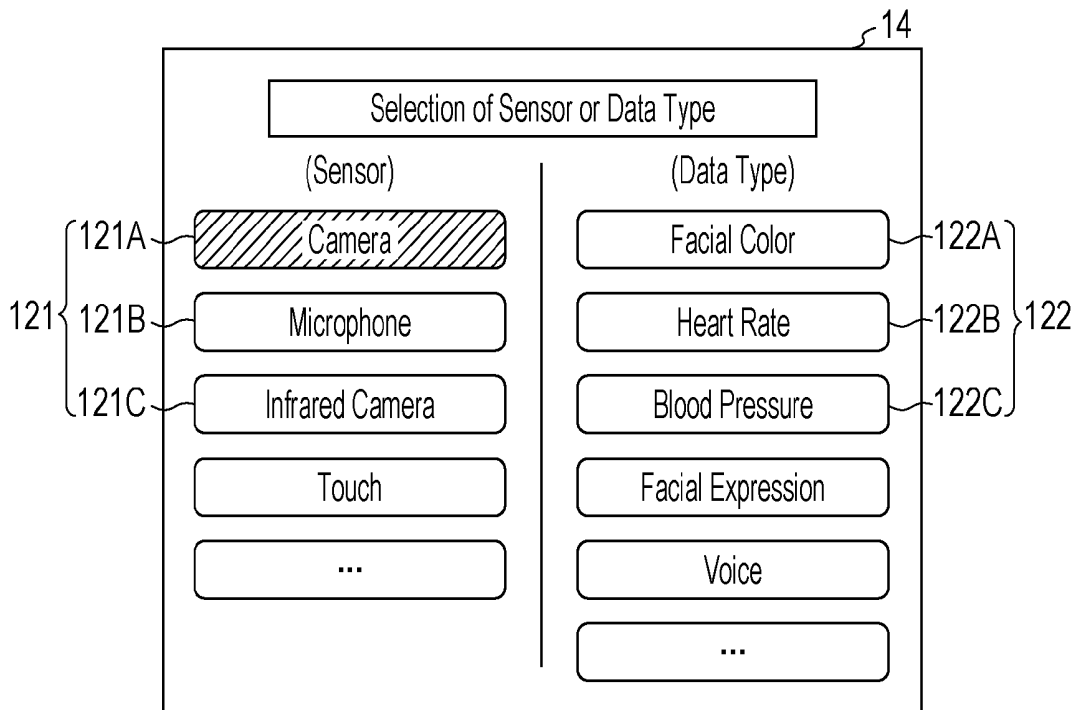

FIG. 13

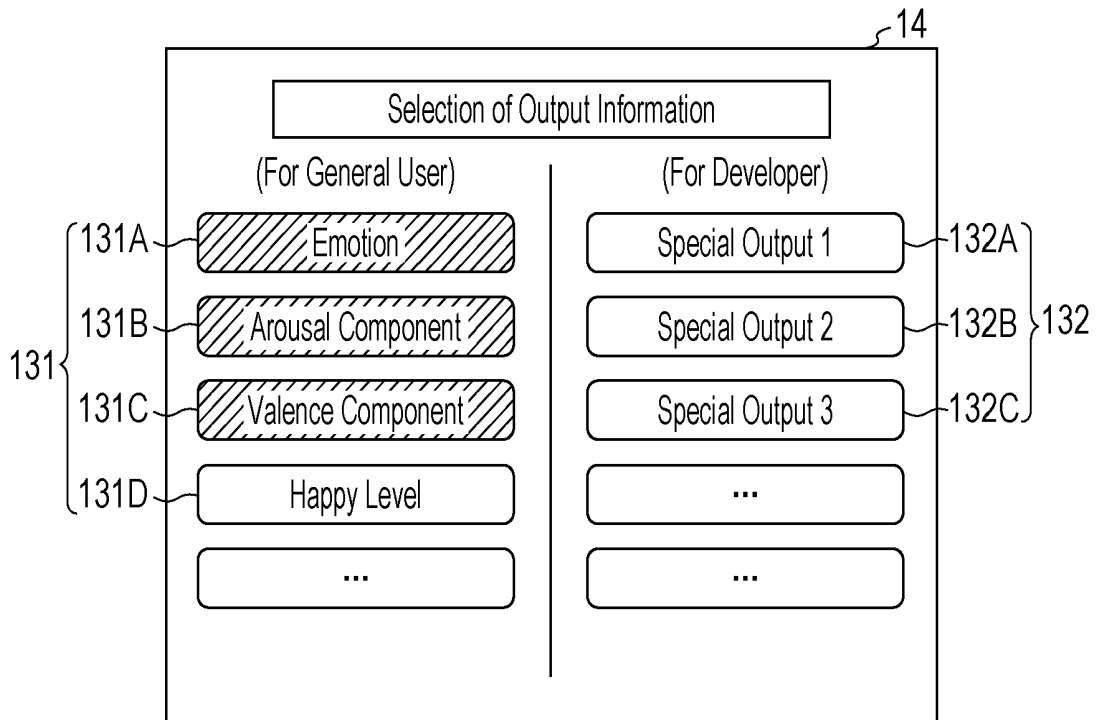

FIG. 14

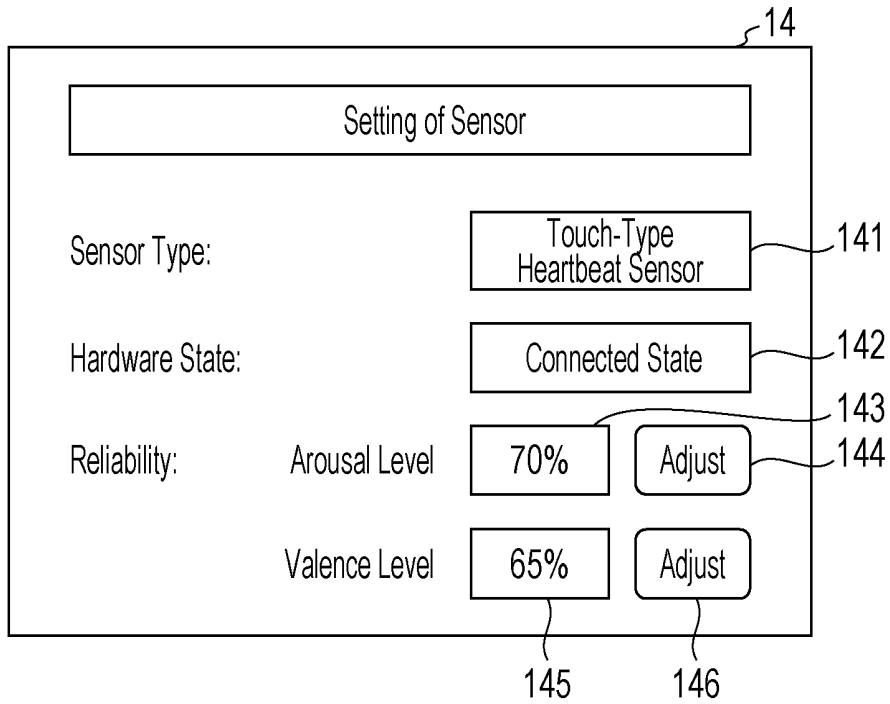

FIG. 15

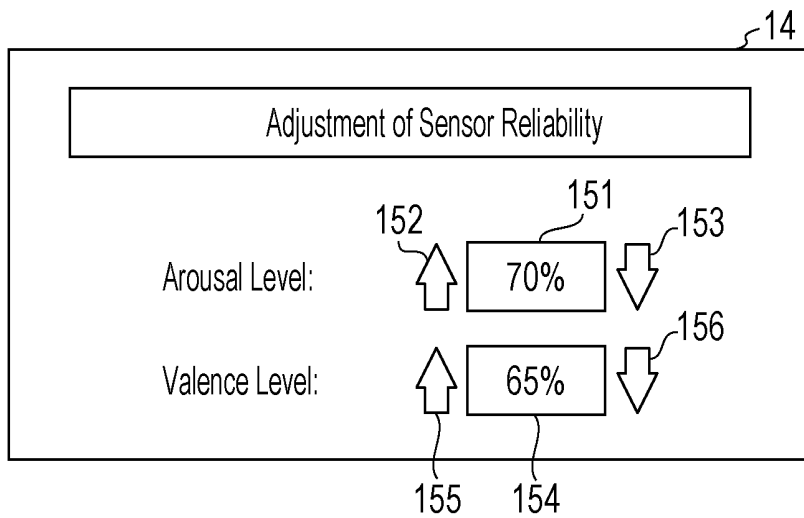

FIG. 16

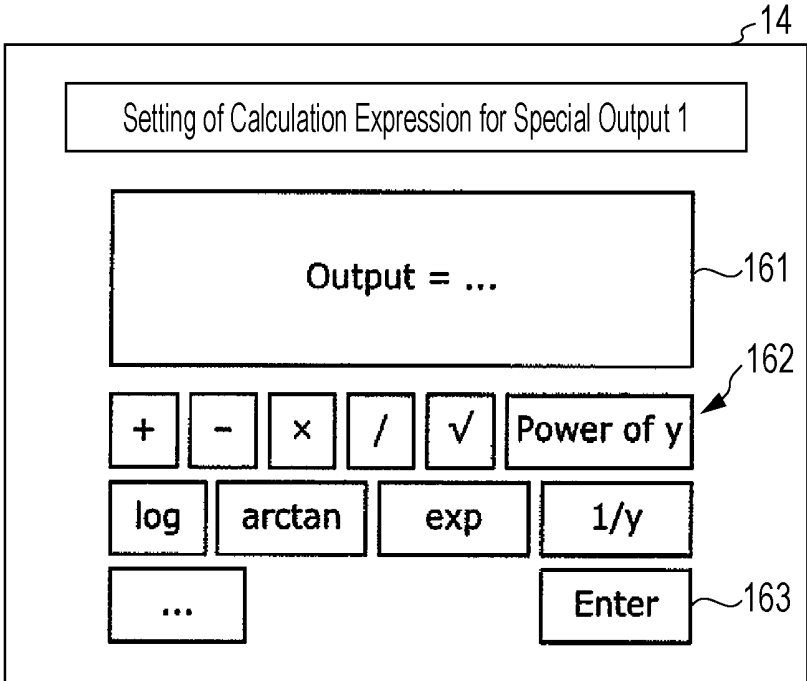

FIG. 17

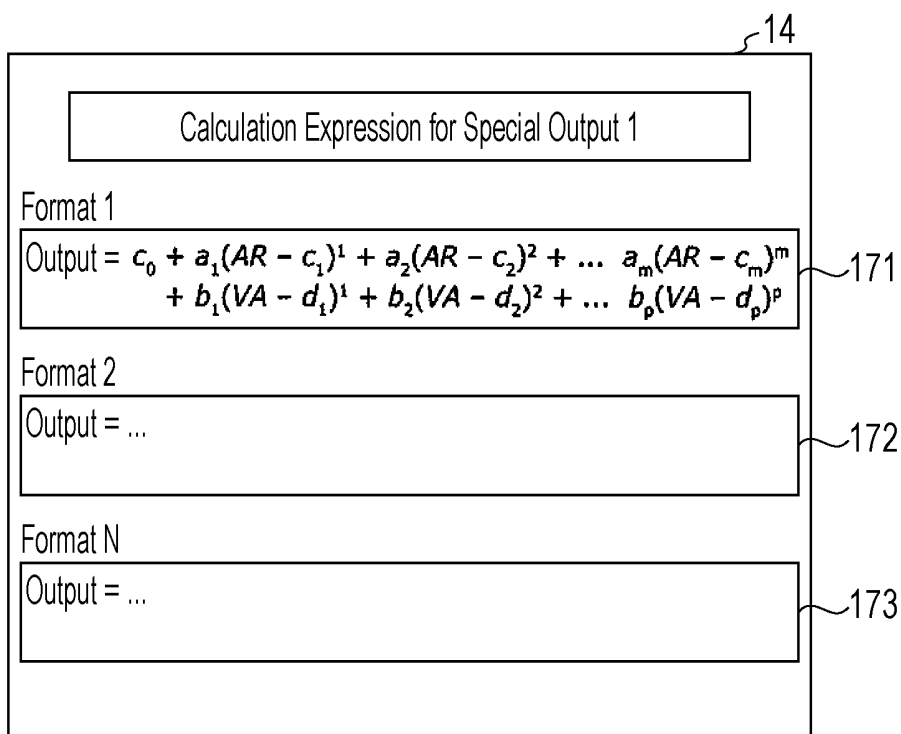

FIG. 18

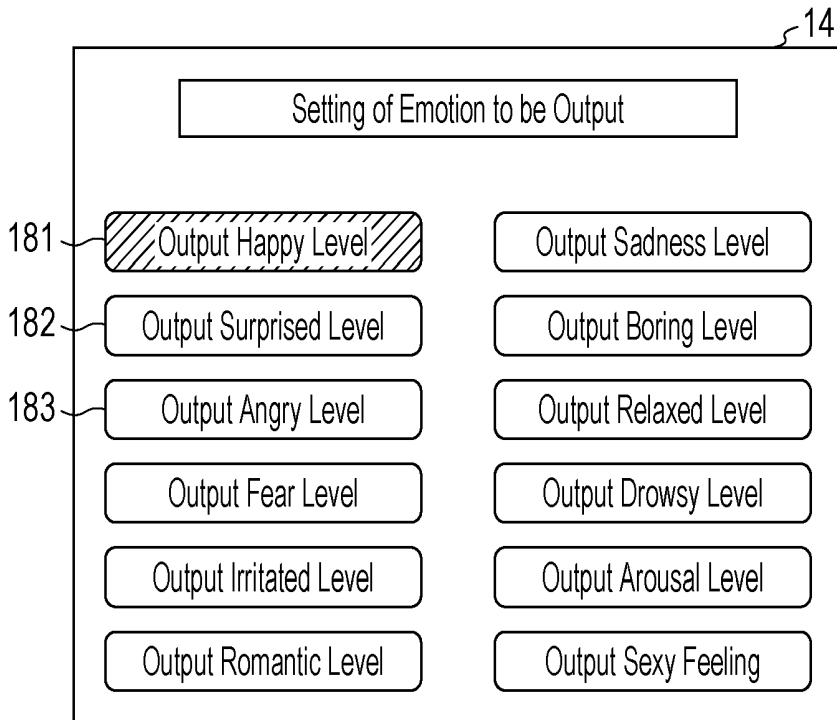

FIG. 19

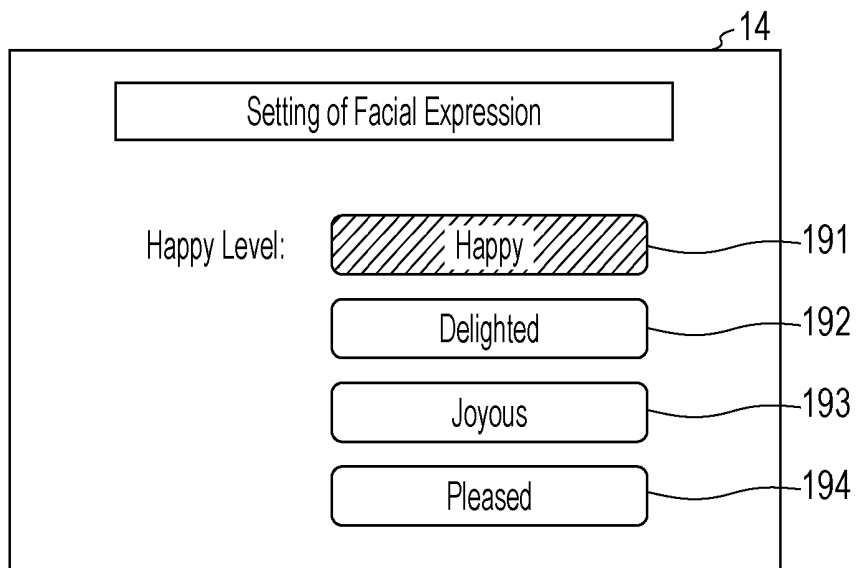

FIG. 20

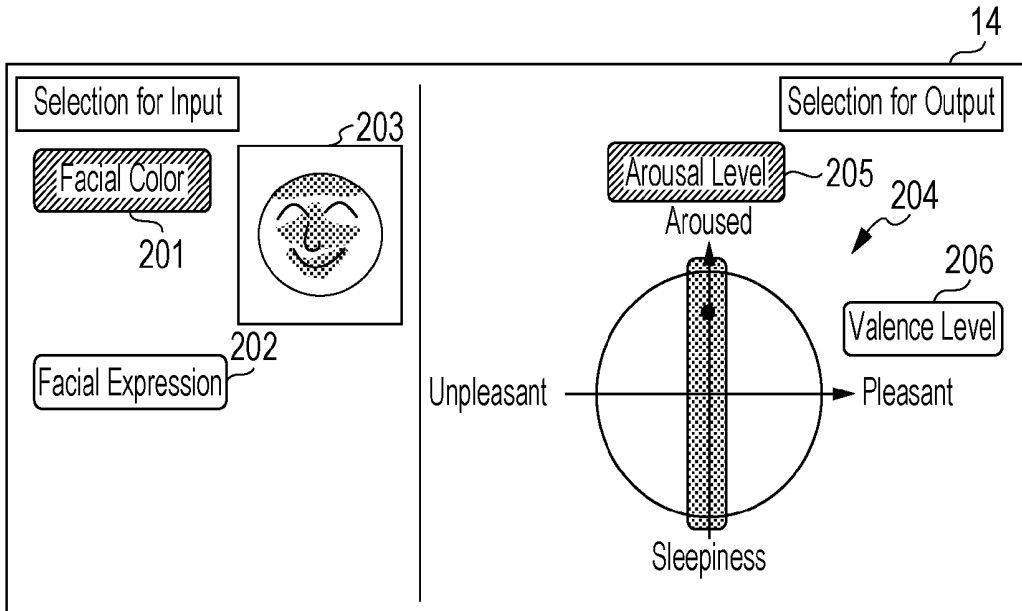

FIG. 21

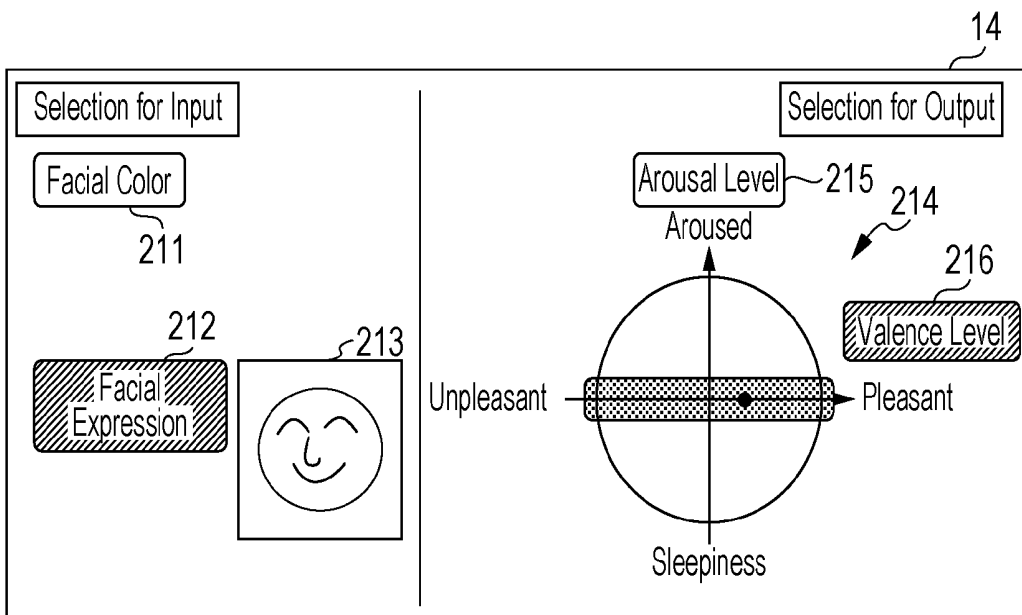

FIG. 22

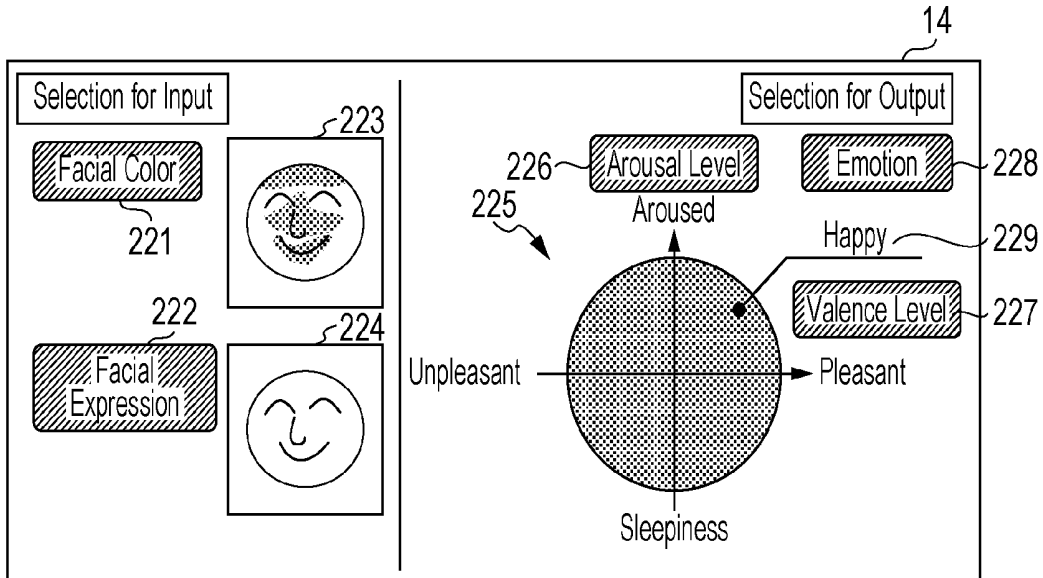

FIG. 23

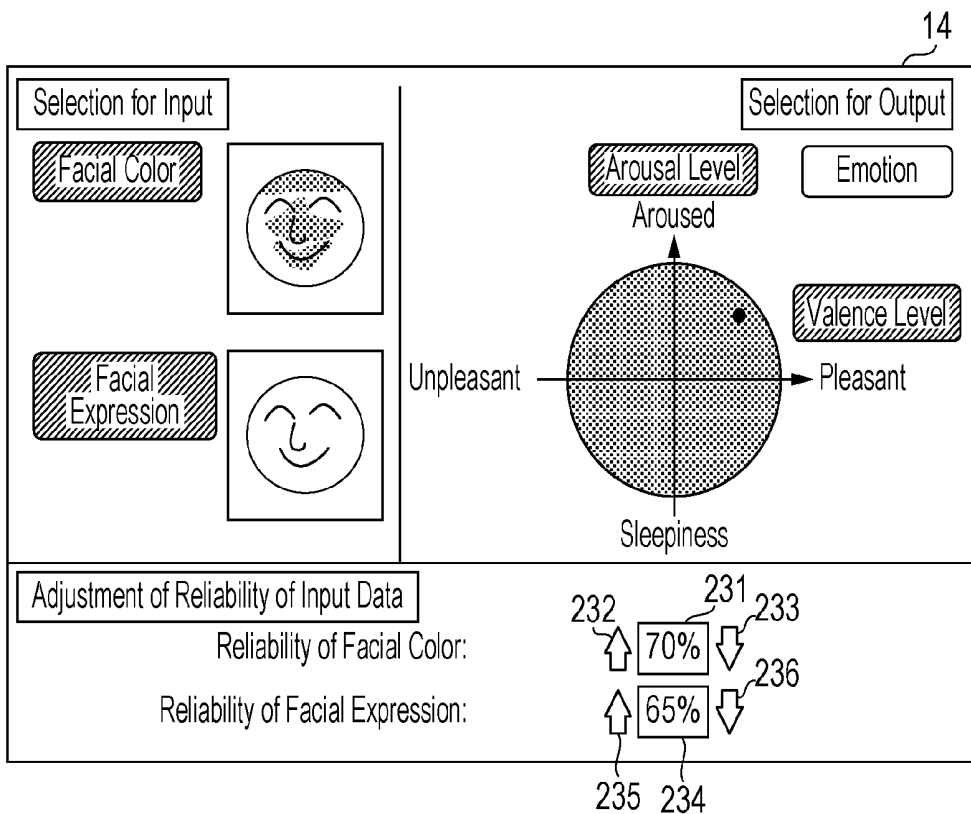

FIG. 24

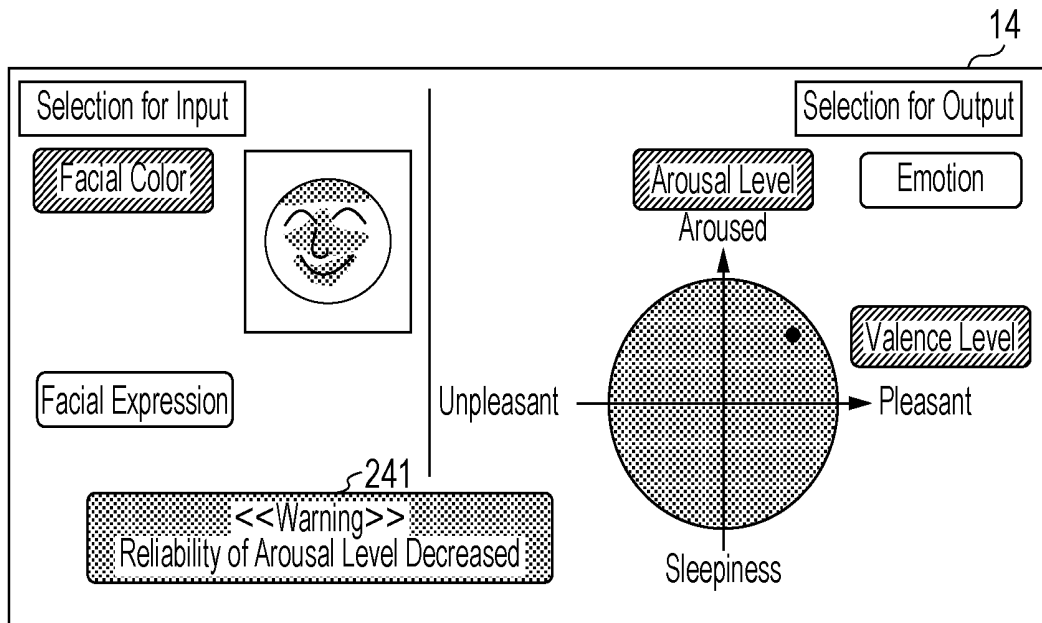

FIG. 25

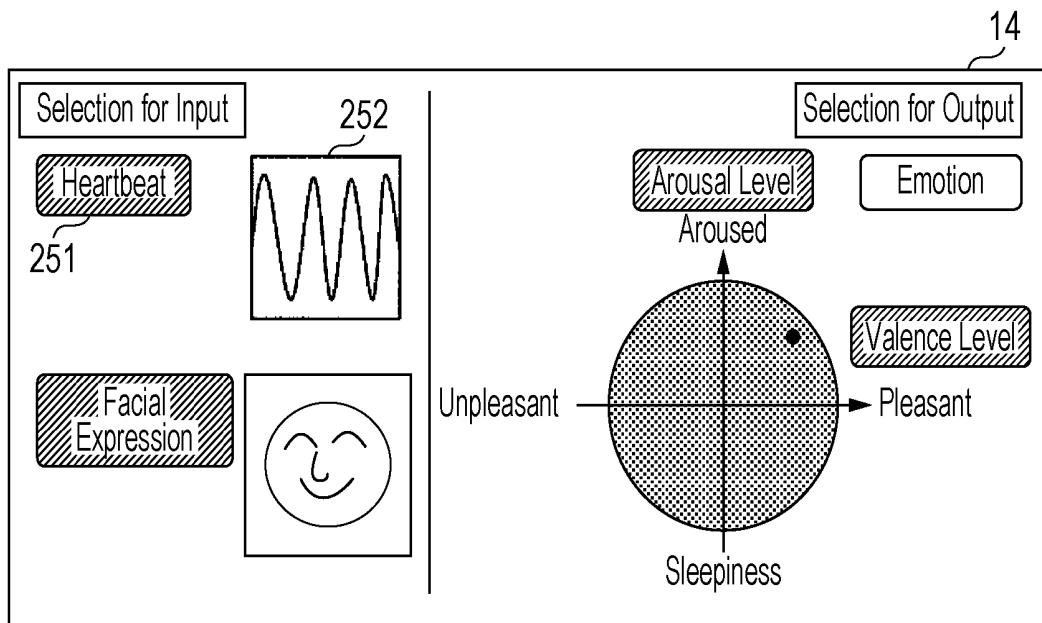

FIG. 26A

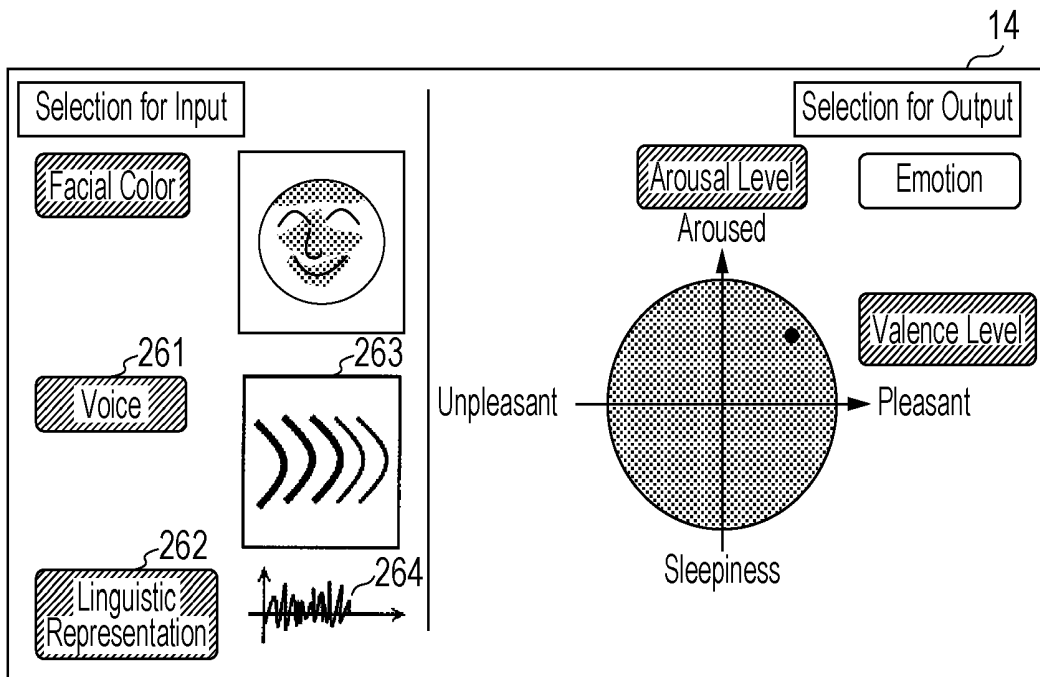

FIG. 26B

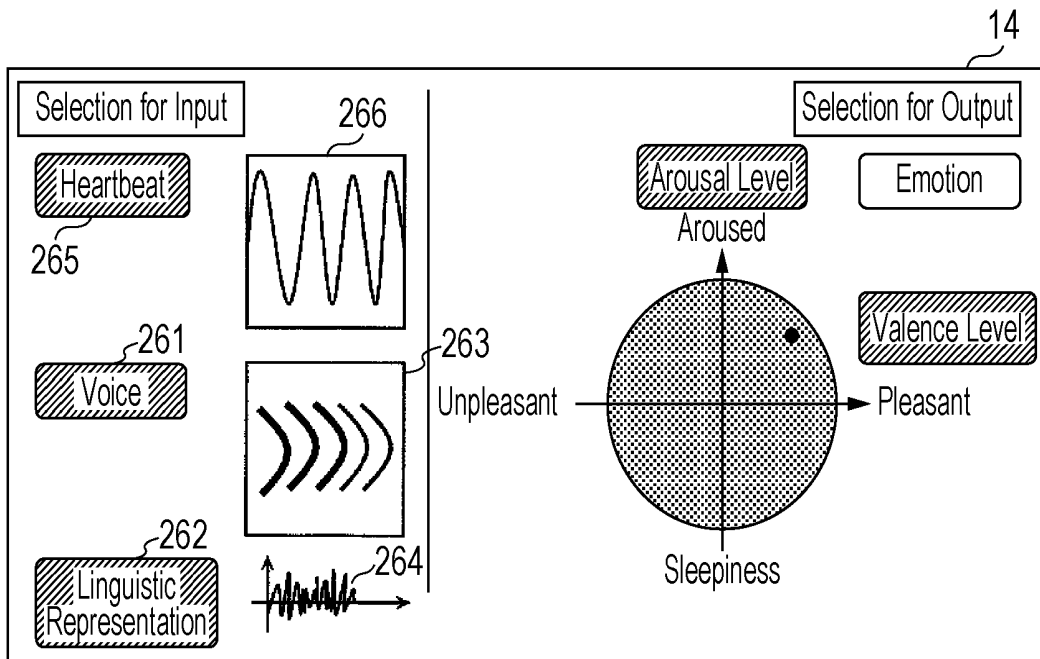

FIG. 27

14

Registration of Subject Information

Nationality:   Blood Pressure: Minimum:  Maximum:

Gender:   Skin Color:

Age:  Chronic Disease:

Average Heart Rate:

FIG. 28

14

Registration of Face of Subject

281

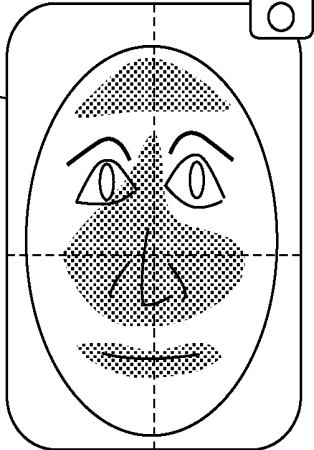

Average Heart Rate:  282

Average Respiration Rate:  283

For face registration, please make a normal facial expression.

284

FIG. 29

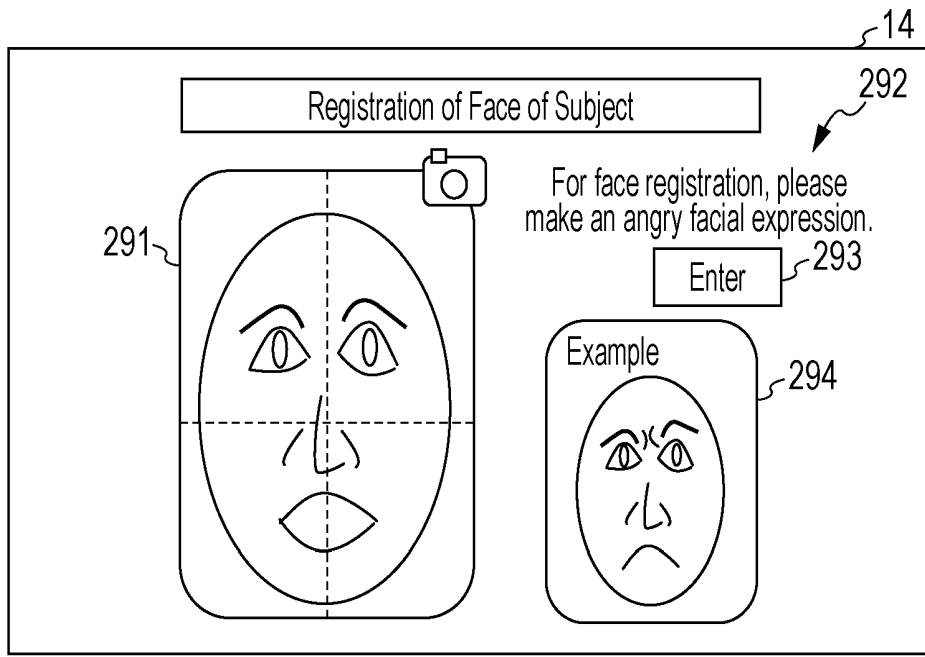

FIG. 30

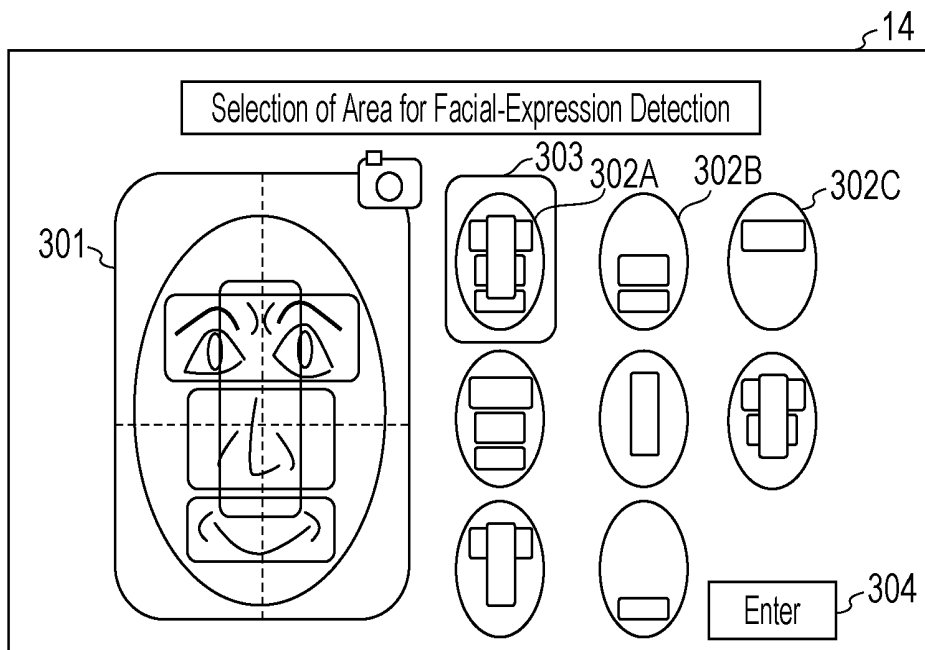

FIG. 31

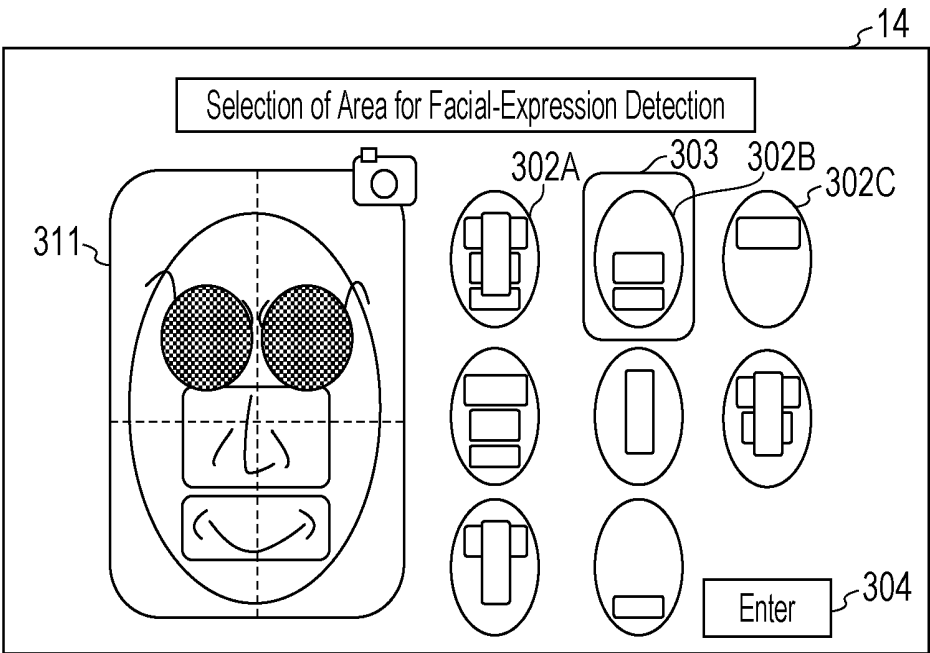

FIG. 32

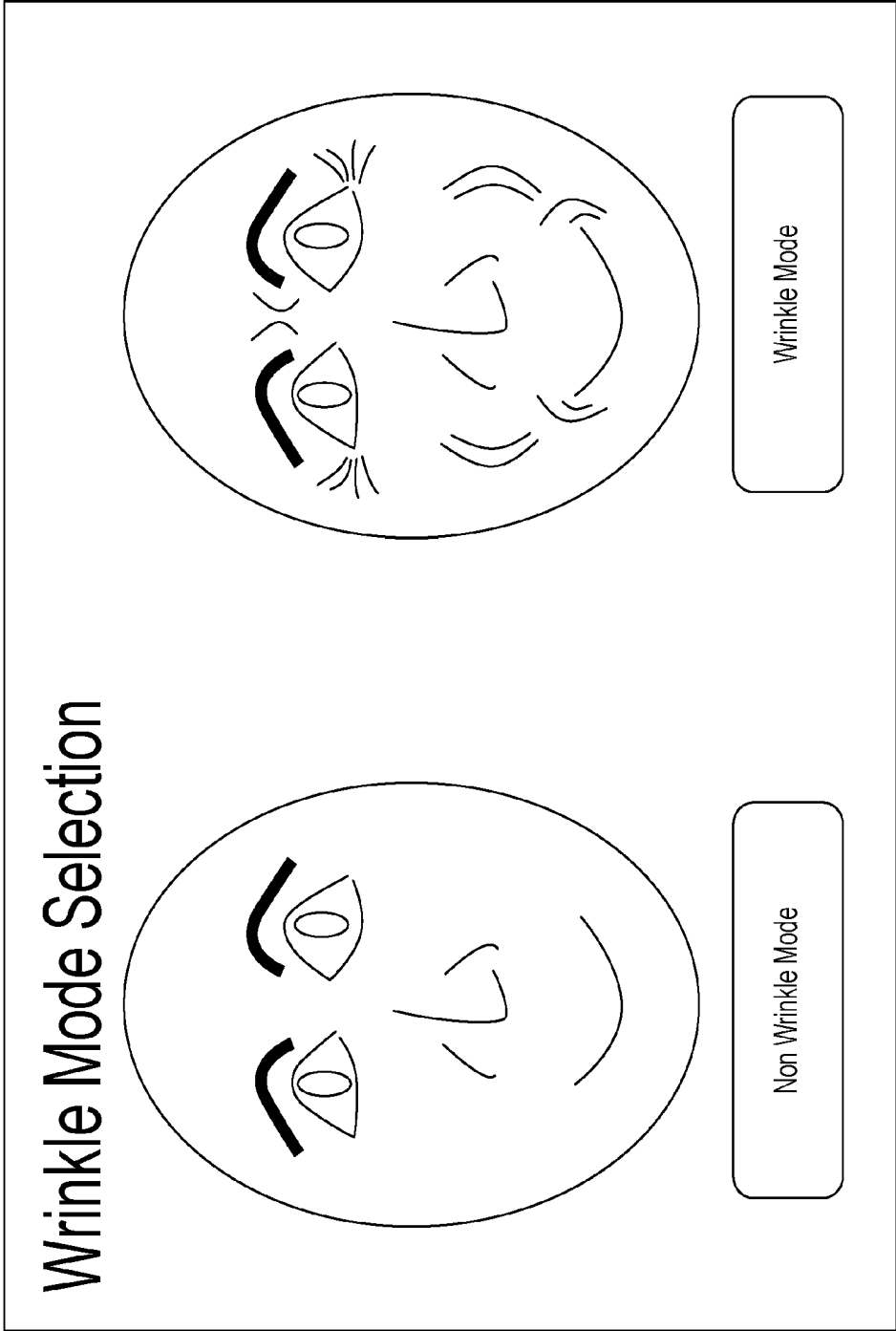
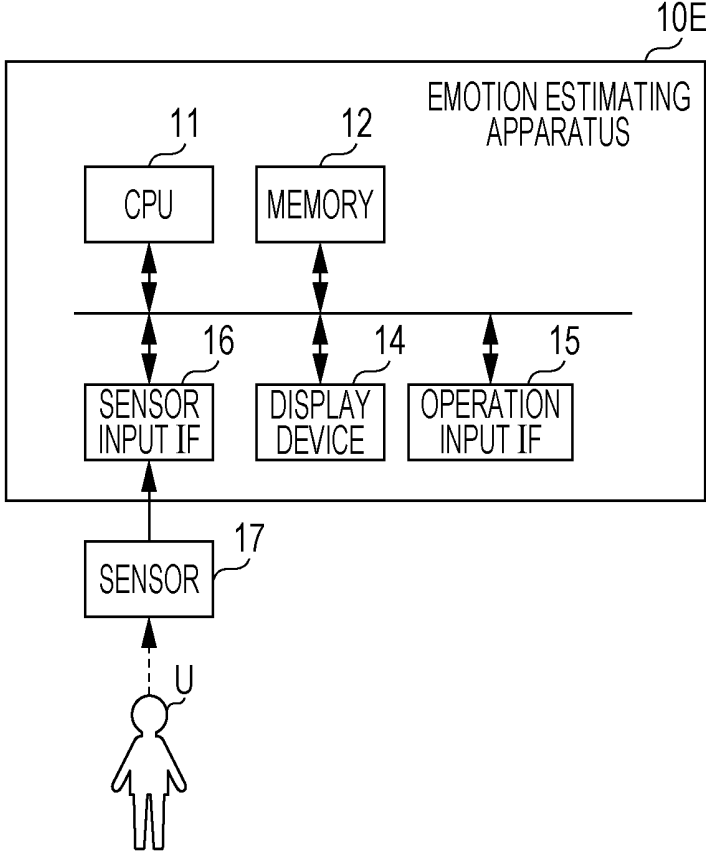

FIG. 33



**EMOTION ESTIMATING METHOD,  
EMOTION ESTIMATING APPARATUS, AND  
RECORDING MEDIUM STORING  
PROGRAM**

**BACKGROUND**

[0001] 1. Technical Field

[0002] The present disclosure relates to an emotion estimating method, an emotion estimating apparatus, and a recording medium storing a program.

[0003] 2. Description of the Related Art

[0004] Japanese Patent No. 5768667 discloses an analyzing apparatus that evaluates, based on a person's facial expression or the like acquired by a sensor, information indicating a possibility that the facial expression or the like is a natural expression of the emotion of the person.

**SUMMARY**

[0005] In one general aspect, the techniques disclosed here feature an emotion estimating method for an emotion estimating apparatus for estimating an emotion of a subject. The emotion estimating method includes: acquiring first data and second data from the subject, the first data corresponding to physiology data, and the second data corresponding to one of physiology data different from the first data and non-physiology data; calculating a first value and a second value based on the acquired first data and second data, the first value indicating a degree of arousal of the subject and the second value indicating a degree of valence of the subject; estimating the emotion of the subject, by using the calculated first value and second value and based on a predetermined association of people's emotions with a degree of arousal and a degree of valence of the people, the predetermined association being pre-stored in a memory; and outputting information indicating the estimated emotion.

[0006] In the emotion estimating method in the present disclosure, it is possible to estimate various emotions felt by a person.

[0007] It should be noted that general or specific embodiments may be implemented as a system, a method, an integrated circuit, a computer program, a computer-readable storage medium such as a compact disc read-only memory (CD-ROM), or any selective combination thereof.

[0008] Additional benefits and advantages of the disclosed embodiments will become apparent from the specification and drawings. The benefits and/or advantages may be individually obtained by the various embodiments and features of the specification and drawings, which need not all be provided in order to obtain one or more of such benefits and/or advantages.

**BRIEF DESCRIPTION OF THE DRAWINGS**

[0009] FIG. 1 is a diagram illustrating one example of a two-dimensional model of human emotions;

[0010] FIG. 2 is a block diagram illustrating the hardware configuration of an emotion estimating apparatus according to an embodiment;

[0011] FIG. 3 is a block diagram illustrating the functional configuration of the emotion estimating apparatus according to the embodiment;

[0012] FIG. 4 is a schematic diagram illustrating an emotion estimating method executed by the emotion estimating apparatus according to the embodiment;

[0013] FIG. 5 is a schematic diagram illustrating an emotion output method executed by the emotion estimating apparatus according to the embodiment;

[0014] FIG. 6 is a block diagram illustrating a first specific example of the functional configuration of the emotion estimating apparatus according to the embodiment;

[0015] FIG. 7 is a block diagram illustrating a second specific example of the functional configuration of the emotion estimating apparatus according to the embodiment;

[0016] FIG. 8 is a block diagram illustrating emotion estimation processing in the second specific example of the functional configuration of the emotion estimating apparatus according to the embodiment;

[0017] FIG. 9 is a block diagram illustrating a third specific example of the functional configuration of the emotion estimating apparatus according to the embodiment;

[0018] FIG. 10 is a block diagram illustrating a fourth specific example of the functional configuration of the emotion estimating apparatus according to the embodiment;

[0019] FIG. 11 is a flow diagram illustrating an estimation method by which the emotion estimating apparatus according to the embodiment estimates an emotion;

[0020] FIG. 12 is a schematic view of an image for receiving, from a user, a selection of a sensor that an acquirer according to the embodiment uses for data acquisition and a selection of data to be acquired;

[0021] FIG. 13 is a schematic view of an image for receiving, from the user, a selection of information to be output from an outputter according to the embodiment;

[0022] FIG. 14 is a schematic view of an image for receiving, from the user, settings of the sensor according to the embodiment;

[0023] FIG. 15 is a schematic view of an image for receiving, from the user, an adjustment of the reliability of the sensor according to the embodiment;

[0024] FIG. 16 is a schematic view of an image for setting a calculation expression regarding output information according to the embodiment;

[0025] FIG. 17 is a schematic view of an image for checking a calculation expression regarding output information according to the embodiment;

[0026] FIG. 18 is a schematic view of an image for selecting an output of information indicating an emotion according to the embodiment;

[0027] FIG. 19 is a schematic view of an image for setting a representation of information indicating an emotion according to the embodiment;

[0028] FIG. 20 is a schematic view of a first example of an image including information indicating an emotion estimated by an estimator according to the embodiment;

[0029] FIG. 21 is a schematic view of a second example of the image including the information indicating the emotion estimated by the estimator according to the embodiment;

[0030] FIG. 22 is a schematic view of a third example of the image including the information indicating the emotion estimated by the estimator according to the embodiment;

[0031] FIG. 23 is a schematic view of a fourth example of the image including the information indicating the emotion estimated by the estimator according to the embodiment;

[0032] FIG. 24 is a schematic view of a fifth example of the image including the information indicating the emotion estimated by the estimator according to the embodiment;

[0033] FIG. 25 is a schematic view of a sixth example of the image including the information indicating the emotion estimated by the estimator according to the embodiment;

[0034] FIG. 26A is a schematic view of a seventh example of the image including the information indicating the emotion estimated by the estimator according to the embodiment;

[0035] FIG. 26B is a schematic view of an eighth example of the image including the information indicating the emotion estimated by the estimator according to the embodiment;

[0036] FIG. 27 is a schematic view of an image for registering subject information according to the embodiment;

[0037] FIG. 28 is a schematic view of a first example of an image for registering the face of the subject according to the embodiment;

[0038] FIG. 29 is a schematic view of a second example of an image for registering the face of the subject according to the embodiment;

[0039] FIG. 30 is a schematic view of a first example of an image for selecting an area for detecting a facial expression from the face of the subject according to the embodiment;

[0040] FIG. 31 is a schematic view of a second example of an image for selecting an area for detecting a facial expression from the face of the subject according to the embodiment;

[0041] FIG. 32 illustrates an example of a screen for prompting the user to select whether or not information regarding wrinkles of the face is to be used when the emotion estimating apparatus makes a facial-expression or emotion determination; and

[0042] FIG. 33 is a block diagram illustrating the hardware configuration of an emotion estimating apparatus according to a modification of the embodiment.

#### DETAILED DESCRIPTION

(Knowledge Underlying Present Disclosure)

[0043] The technology disclosed in Japanese Patent No. 5768667 has a problem in that various emotions, such as happiness and surprise, felt by people cannot be evaluated.

[0044] Accordingly, the present disclosure provides an emotion estimating apparatus and so on that estimate various emotions felt by people.

[0045] An emotion estimating method according to one aspect of the present disclosure is directed to an emotion estimating method for an emotion estimating apparatus for estimating an emotion of a subject. The emotion estimating method includes: acquiring first data and second data from the subject, the first data corresponding to physiology data, and the second data corresponding to one of physiology data different from the first data and non-physiology data; calculating a first value and a second value based on the acquired first data and second data, the first value indicating a degree of arousal of the subject and the second value indicating a degree of valence of the subject; estimating the emotion of the subject, by using the calculated first value and second value and based on a predetermined association of people's emotions with a degree of arousal and a degree of valence of the people, the predetermined association being pre-stored in a memory; and outputting information indicating the estimated emotion.

[0046] According to the above-described aspect, the emotion estimating apparatus in an embodiment can estimate an emotion of a subject on the basis of the predetermined association and through use of two or more pieces of data including physiology data acquired from the subject and physiology data different from that physiology data or non-physiology data acquired from the subject. Through use of the two or more pieces of data, the emotion estimating apparatus disclosed herein calculates two indicators, that is, a first value (an arousal level) and a second value (a valence level) of a subject, thereby making it possible to appropriately estimate various emotions felt by the subject.

[0047] For example, the second data may be non-physiology data.

[0048] According to the above-described aspect, through use of the physiology data and non-physiology data acquired from the subject and based on the predetermined association, the emotion estimating apparatus can estimate an emotion of the subject. The physiology data has a relatively high correlation with the arousal level, and the non-physiology data has a relatively high correlation with the valence level. Hence, when the physiology data and the non-physiology data are used, the arousal level and the valence level can be more accurately calculated, and thus, the emotion of the subject can be estimated with higher accuracy.

[0049] For example, in the calculating, the first value may be calculated based on the first data, and the second value may be calculated based on the second data.

[0050] According to the above-described aspect, the emotion estimating apparatus calculates an arousal level having a relatively high correlation with the physiology data through use of the physiology data acquired from the subject, and calculates a valence level having a relatively high correlation with the non-physiology data through use of the non-physiology data. Hence, the arousal level and the valence level can be more accurately calculated, and thus, the emotion of the subject can be estimated with higher accuracy.

[0051] For example, the emotion estimating apparatus may comprise a camera that captures an image of the subject's face to generate moving-image data; and in the acquiring, a heart rate of the subject may be acquired as the first data, based on the moving-image data generated by the camera, and a facial expression of the subject may be acquired as the second data, the facial expression being identified based on a position of a feature point on the subject's face in the moving-image data generated by the camera.

[0052] According to the above-described aspect, the emotion estimating apparatus obtains both the heart rate, which is physiology data, of the subject and a facial expression, which is non-physiology data, by using a camera and estimates the emotion of the subject. Thus, when both the physiology data and the non-physiology data are obtained using one device, which is a camera, to estimate the emotion, the amount of burden on the subject is reduced, and convenience improves.

[0053] For example, in the outputting, a point in a plane with two coordinate axes indicating the first value and the second value may be output on a display screen of a display device as information indicating the emotion of the subject, the display device being included in the emotion estimating apparatus.

**[0054]** According to the above-described aspect, the emotion estimating apparatus outputs the arousal level and the valence level of the subject by representing the arousal level and the valence level as a point in a plane. This allows the user or the subject to intuitively know which of various possible subject emotions the emotion of the subject corresponds and also the intensity of the emotion of the subject.

**[0055]** For example, in the outputting, at least one of the first value and the second value may be output on a display screen of a display device as information indicating the emotion of the subject, the display device being included in the emotion estimating apparatus.

**[0056]** According to the above-described aspect, the emotion estimating apparatus outputs at least one of the arousal level and the valence level of the subject. As a result of the outputting, the user or the subject can know not only the emotion of the subject but also the arousal level and/or the valence level felt by the subject.

**[0057]** For example, in the outputting, a value indicating an intensity of a predetermined emotion of the subject may be output on a display screen of a display device as information indicating the emotion of the subject, the display device being included in the emotion estimating apparatus.

**[0058]** According to the above-described aspect, the emotion estimating apparatus outputs the intensity of a particular emotion (e.g., happiness) of the subject (in other words, the degree of an emotion). For example, the emotion estimating apparatus outputs not only an emotion "happiness" but also the degree of happiness. This allows the user or the subject to know not only the emotion of the subject but also the intensity or degree of the emotion.

**[0059]** For example, in the calculating, a first reliability that is an indicator indicating correctness of an emotion of the subject, the emotion being estimated based on the first value, may be calculated, and a second reliability that is an indicator indicating correctness of an emotion of the subject, the emotion being estimated based on the second value, may be calculated; and in the outputting, information indicating at least one of the first reliability and the second reliability may be output together with the information indicating the estimated emotion.

**[0060]** According to the above-described aspect, the emotion estimating apparatus outputs, as reliabilities, the level of correctness at which the estimated emotion represents the emotion of the subject. This allows the user or the subject to know not only the emotion of the subject but also the level of correctness at which the emotion represents the emotion of the subject.

**[0061]** For example, the first data acquired in the acquiring may include one or more pieces of first data, and the second data acquired in the acquiring may include one or more pieces of second data; and in the calculating, a first value and a first reliability may be calculated for each of the acquired one or more pieces of first data, the first value may be a value resulting from weighted average using the first reliability for the first value as a weight, a second value and a second reliability may be calculated for each of the acquired one or more pieces of second data, and the second value may be a value resulting from weighted average using the second reliability for the second value as a weight.

**[0062]** According to the above-described aspect, when the arousal level or the valence level can be obtained from a plurality of pieces of physiology data and non-physiology data, the emotion estimating apparatus can estimate an

emotion of the subject by appropriately evaluating the plurality of pieces of physiology data and non-physiology data on the basis of the reliabilities.

**[0063]** For example, in the outputting, when at least one of the first reliability and the second reliability is smaller than a predetermined threshold, a warning may be output.

**[0064]** According to the above-described aspect, the emotion estimating apparatus outputs a warning when the estimated emotion does not so correctly represent the emotion of the subject. This allows the user or the subject to clearly know that the estimated emotion does not so correctly represent the emotion of the subject.

**[0065]** For example, in the calculating, the first data may be compared with a predetermined first reference value to calculate the first value, and the second data may be compared with a predetermined second reference value to calculate the second value; and the emotion estimating method may further include: obtaining information relevant to a physical characteristic of the subject; and adjusting the predetermined first reference value or the predetermined second reference value, based on the obtained information relevant to the physical characteristic of the subject.

**[0066]** According to the above-described aspect, by varying the reference values for the arousal level and the valence level on the basis of information (e.g., the gender or age) relevant to a physical characteristic of the subject, the emotion estimating apparatus can adjust the arousal level and the valence level in accordance with the physical characteristic of the subject and can more appropriately estimate the emotion.

**[0067]** For example, the emotion estimating method may further include receiving, from a user, a selection of an area included in a plurality of predetermined areas of a human face and used for acquiring a facial expression that is the second data. In the acquiring, a feature point included in the area of the subject's face may be acquired as the second data; and in the calculating, the second value may be calculated based on the feature point included in the area of the subject's face.

**[0068]** According to the above-described aspect, upon receiving a setting for the face area for acquiring a facial expression of the subject, the emotion estimating apparatus acquires a facial expression of the subject by using the received setting. For example, when the subject wears sunglasses, the portion of the eyes of the subject is hidden by the sunglasses, and thus information regarding a facial expression cannot be obtained from the eye portion. In such a case, the emotion estimating apparatus is adapted to obtain a facial expression of the subject from a portion other than the eye portion of the subject to thereby make it possible to more appropriately detect the facial expression.

**[0069]** For example, the physiology data may include at least one of face color, a heart rate, a heart rate variation, the low frequency/high frequency (LF/HF) of a heart rate variation, an R wave to R wave (R-R) interval, a pulse wave, a pulse variation, a brain wave, a respiration rate, a respiratory volume, a blood flow, a blood flow variation, a blood pressure, a blood pressure variation, an oxygen saturation level, movement of a part of a human body, movement of a muscle of a human body, movement of a muscle of a face, a body temperature, a skin temperature, a skin conductance, a skin resistance, an amount of sweat, and a perspiration rate.

**[0070]** According to the above-described aspect, by using the physiology data, such as facial color, the emotion estimating apparatus can more specifically estimate an emotion felt by the subject.

**[0071]** For example, the non-physiology data may include at least one of a facial expression, an emotion, a touch input signal, voice, a linguistic representation, a sentence, and body motion.

**[0072]** According to the above-described aspect, by using the non-physiology data, such as a facial expression, the emotion estimating apparatus can more specifically estimate an emotion felt by the subject.

**[0073]** For example, the predetermined first reference value or the predetermined second reference value may be calculated based on at least one of a gender, nationality, age, and skin color of the subject.

**[0074]** According to the above-described aspect, by using the information, such as gender, the emotion estimating apparatus can more specifically estimate an emotion felt by the subject.

**[0075]** Also, a processor may perform at least one of the acquiring, the calculating, the estimating, and the outputting.

**[0076]** An emotion estimating apparatus according to one aspect of the present disclosure is directed to an emotion estimating apparatus including: an acquirer that acquires first data and second data from a subject, the first data corresponding to physiology data, and the second data corresponding to one of physiology data and non-physiology data and being different from the first data; an estimator (i) that calculates a first value and a second value based on the acquired first data and second data, the first value indicating a degree of arousal of the subject and the second value indicating a degree of valence of the subject, and (ii) estimates the emotion of the subject, by using the calculated first value and second value and based on a predetermined association of people's emotions with a degree of arousal and a degree of valence of the people, the predetermined association being pre-stored in a memory; and an outputter that outputs information indicating the estimated emotion.

**[0077]** At least one of the acquirer, the estimator, and the outputter may include a processor.

**[0078]** The above-described aspect offers advantages that are analogous to those of the above-described emotion estimating apparatus.

**[0079]** Also, a recording medium according to one aspect of the present disclosure is directed to a non-transitory recording medium storing a computer program. The program causes a computer to execute: acquiring first data and second data from a subject, the first data corresponding to physiology data, and the second data corresponding to one of physiology data and non-physiology data and being different from the first data; calculating a first value and a second value based on the acquired first data and second data, the first value indicating a degree of arousal of the subject and the second value indicating a degree of valence of the subject; estimating the emotion of the subject, by using the calculated first value and second value and based on a predetermined association of people's emotions with a degree of arousal and a degree of valence of the people, the predetermined association being pre-stored in a memory; and outputting information indicating the estimated emotion.

**[0080]** The above-described aspect offers advantages that are analogous to those of the above-described emotion estimating apparatus.

**[0081]** It should be noted that general or specific embodiments may be implemented as a system, a method, an integrated circuit, a computer program, a computer-readable storage medium such as a CD-ROM, or any selective combination thereof.

**[0082]** Embodiments will be described below in detail with reference to the accompanying drawings.

**[0083]** The embodiments described below each represent a general or specific example. Numerical values, shapes, materials, constituent elements, the arrangement and connection of constituent elements, steps, the order of steps, and so on described in the embodiments below are examples, and are not intended to limit the present disclosure. Of the constituent elements in the embodiments described below, the constituent elements not set forth in the independent claims that represent the broadest concept will be described as optional constituent elements.

#### Embodiments

**[0084]** In the present embodiment, a description will be given of an emotion estimating apparatus for estimating various emotions felt by a person and an emotion estimating method for the emotion estimating apparatus. In the following description, a person whose emotion is to be estimated by an emotion estimating apparatus is referred to as a "subject", and a person who operates the emotion estimating apparatus is referred to as a "user". The subject and the user may be the same person.

**[0085]** FIG. 1 is a diagram illustrating one example of a two-dimensional model of human emotions. More specifically, the two-dimensional emotion model illustrated in FIG. 1 is called Russell's circumplex model.

**[0086]** People feel various emotions, including happiness and surprise. In FIG. 1, various emotions felt by people are arranged in a plane with two axes indicating an arousal level representing a degree of arousal and a valence level representing a degree of valence. It has been known that, as illustrated in FIG. 1, various emotions felt by people can be arranged in a circular ring in the plane.

**[0087]** The present inventors have obtained a result indicating that an estimation result and an actual emotion do not match well when emotion estimation based on Russell's circumplex model is performed using only a facial expression of a subject. As a result of a great deal of consideration in this respect, the present inventors have found that non-physiology data, particularly a facial expression, has a high correlation with the valence level in Russell's circumplex model and has a small correlation with the arousal level. The inventors also have found that the arousal level in Russell's circumplex model has a high correlation with physiology data, such as a heart rate.

**[0088]** On the basis of the above-described findings, the inventors made this disclosure by paying attention to the idea that emotion estimation using Russell's circumplex model can be performed with higher accuracy through appropriate use of non-physiology data and physiology data.

**[0089]** The emotion estimating apparatus according to the present embodiment estimates various emotions felt by a subject, by using physiology data or non-physiology data and based on the above-described correlation. The configu-

ration and the operation of the emotion estimating apparatus will be described below in order.

**[0090]** FIG. 2 is a block diagram illustrating the hardware configuration of an emotion estimating apparatus 10 according to the present embodiment.

**[0091]** As illustrated in FIG. 2, the emotion estimating apparatus 10 includes a central processing unit (CPU) 11, a memory 12, a sensor 13, a display device 14, and an operation input interface (IF) 15.

**[0092]** The CPU 11 is a processor for executing a control program stored in the memory 12. The CPU 11 executes the control program to thereby realize each functional block (described below) in the emotion estimating apparatus 10.

**[0093]** The memory 12 is a storage device and includes a volatile storage area used as work area when the CPU 11 executes the control program and a nonvolatile storage area in which the control program and so on are held.

**[0094]** The sensor 13 is a sensor for acquiring physiology data or non-physiology data of a human subject U from the subject U. The sensor 13 includes a plurality of sensor elements. Each of the sensor elements acquires the physiology data or non-physiology data by detecting the physiology data or non-physiology data from the subject U. At least one of the sensor elements is a sensor element (a physiology sensor) for acquiring physiology data. Each sensor element other than the at least one sensor element may be a physiology sensor or may be a sensor element (a non-physiology sensor) for acquiring non-physiology data.

**[0095]** The physiology data is data related to a biological function and includes at least one of, for example, face color, a heart rate, a heart rate variation, the low frequency/high frequency (LF/HF) of a heart rate variation, an R wave to R wave (R-R) interval, a pulse wave, a pulse variation, a brain wave, a respiration rate, a respiratory volume, a blood flow, a blood flow variation, a blood pressure, a blood pressure variation, an oxygen saturation level (SO<sub>2</sub>), movement of a part of a human body, movement of a muscle of a human body, movement of a muscle of a face, a body temperature, a skin temperature, a skin conductance, a skin resistance, a skin roughness, a skin shininess, an amount of sweat, and a perspiration rate. Examples of the movement of the parts of the human body include the frequency of blinking, and the speed of blinking. The physiology data is also referred to as “non-face-expression data”, in contrast to “facial expression data”.

**[0096]** The physiology sensor includes at least one of, for example, a camera (a visible light camera or a camera having a particular electromagnetic wave filter), an electrocardiogram sensor (EKG or ECG), a photoplethysmographic sensor, an electroencephalogram device (EEG), a spirometer, a respiratory activity measuring instrument, a time-of-flight (TOF) sensor, a millimeter-wave sensor, a millimeter-wave radar, a pulse oximeter, a thermographer, a thermal imager, an infrared imager, a detector for face muscle movement, a skin temperature conductance sensor, a skin resistance sensor, an amount-of-sweat sensor, a near-infrared spectrometer, and a computed tomography (CT) apparatus.

**[0097]** The non-physiology data is data that is related to a biological body and that is not physiology data. The non-physiology data includes at least one, of, for example, a facial expression, an emotion, a touch input signal, voice, a linguistic representation, a sentence, and body motion (a gesture). An emotion acquired as non-physiology data is not

an emotion estimated by the emotion estimating apparatus 10 and is an emotion acquired from another method, and, for example, is input by the subject U as his or her emotion. Of the non-physiology data, for example, data used for estimating a facial expression, such as information (the position and/or the shape of the mouth, an eye, or an eyebrow) that can be read from an image of the face, is referred to as “facial expression data”.

**[0098]** The non-physiology sensor includes, for example, at least one of a camera, an emotion detecting device, a touch input unit (a touch screen), a microphone, a TOF sensor, a millimeter-wave sensor, a millimeter-wave radar, a keyboard for inputting a word or sentence, and a gait sensor.

**[0099]** The display device 14 is one example of a device for outputting various types of information and has a display screen for displaying various types of information as images. The display device 14 is, for example, a display portion of a touch panel display.

**[0100]** The operation input IF 15 receives a user's operation on the emotion estimating apparatus 10. The operation input IF 15 is, for example, a touch panel portion of a touch panel display.

**[0101]** FIG. 3 is a block diagram illustrating the functional configuration of the emotion estimating apparatus 10 according to the present embodiment. FIG. 4 is a schematic diagram illustrating an emotion estimating method executed by the emotion estimating apparatus 10 according to the embodiment. FIG. 5 is a schematic diagram illustrating an emotion output method executed by the emotion estimating apparatus 10 according to the embodiment. The functions of the emotion estimating apparatus 10 will now be described with reference to FIGS. 3 to 5.

**[0102]** As illustrated in FIG. 3, the emotion estimating apparatus 10 includes, an acquirer 20, an estimator 30, and an outputter 40 as functional blocks.

**[0103]** The acquirer 20 is a processor for acquiring physiology data and so on from the subject U. Specifically, the acquirer 20 acquires physiology data (corresponding to first data) and also acquires physiology data different from that physiology data or non-physiology data (corresponding to second data). The acquirer 20 includes a physiology data acquirer 21 and a data acquirer 22. The acquirer 20 may include one or more data acquirers 22 (e.g., data acquirer 2*n*).

**[0104]** The first data, the second data, and so on that the acquirer 20 acquires from the subject U are output to the estimator 30.

**[0105]** The physiology data acquirer 21 is a processor for acquiring the physiology data of the subject U from the subject U. The physiology data acquirer 21 acquires the physiology data of the subject U by using the physiology sensor included in the sensor 13. The physiology data acquirer 21 may also acquire the physiology data of the subject U, the data being held by another apparatus.

**[0106]** The data acquirer 22 is a processor for acquiring the physiology data or non-physiology data of the subject U from the subject U. The data acquirer 22 acquires the physiology data or non-physiology data of the subject U by using the physiology sensor or the non-physiology sensor included in the sensor 13. The data acquirer 22 may also acquire the physiology data or non-physiology data of the subject U, the data being held by another apparatus.

**[0107]** The physiology data acquirer **21** and the data acquirer **22** substantially simultaneously acquire the physiology data and the non-physiology data from the same subject U.

**[0108]** When there are a plurality of data acquirers **22**, each of the data acquirers **22** independently acquires the physiology data or non-physiology data. Hence, at least one of a plurality of pieces of data acquired by the acquirer **20** is physiology data, and the other piece(s) of data is (are) physiology data or non-physiology data. For example, there is a case in which the acquirer **20** acquires one piece of physiology data and one piece of non-physiology data or a case in which the acquirer **20** acquires two pieces of physiology data (and does not acquire any non-physiology data).

**[0109]** The estimator **30** is a processor for estimating the emotion of the subject U which is estimated based on the data acquired by the acquirer **20**. The estimator **30** includes an arousal-component calculator **31**, a valence-component calculator **32**, and an emotion estimator **33**. The estimator **30** may also include a corrector **37**.

**[0110]** The arousal-component calculator **31** is a processor for calculating an arousal level AR (see FIG. 4) indicating the degree of arousal of the subject U on the basis of the data acquired by the acquirer **20**. More specifically, the arousal-component calculator **31** obtains each of the physiology data and the non-physiology data acquired by the physiology data acquirer **21** and the data acquirer **22** and calculates the arousal level AR on the basis of the obtained pieces of data. The arousal-component calculator **31** holds a parameter **34** that serves as a reference value for the physiology data and the non-physiology data, and calculates the arousal level AR by comparing the data acquired by the acquirer **20** with the reference value. The “physiology data and the non-physiology data acquired by the physiology data acquirer **21** and the data acquirer **22**” as used herein may refer to data that does not include non-physiology data, as described above. The arousal level corresponds to a first value.

**[0111]** The arousal-component calculator **31** may also calculate the arousal level AR by excluding, of the physiology data and the non-physiology data, data determined to have a relatively small correlation with the arousal level.

**[0112]** For example, when the arousal-component calculator **31** calculates the arousal level AR on the basis of facial color which is physiology data, the arousal-component calculator **31** compares, for example, a luminance value of red of the facial color of the subject U, the facial color being acquired by the physiology data acquirer **21**, with the reference value for the luminance value of red of the facial color, the reference value being held as the parameter **34**. When the luminance value of red of the facial color of the subject U is equal to the reference value, the arousal level AR is calculated as being zero, and a higher arousal level AR is calculated for a larger luminance value of red of the facial color of the subject U (in other words, a smaller arousal level AR is calculated for a smaller luminance value).

**[0113]** The valence-component calculator **32** is a processor for calculating a valence level VA (see FIG. 4) indicating the degree of valence of the subject U on the basis of the data acquired by the acquirer **20**. More specifically, the valence-component calculator **32** obtains each of the physiology data and the non-physiology data acquired by the physiology data acquirer **21** and the data acquirer **22** and calculates the valence level VA on the basis of the obtained pieces of data. The valence-component calculator **32** holds a parameter **35**

that serves as a reference value for the physiology data and the non-physiology data, and the acquirer **20** calculates the valence level VA by comparing the acquired data with the reference value. The valence level corresponds to a second value.

**[0114]** The valence-component calculator **32** may calculate the valence level VA by excluding, of the physiology data and the non-physiology data, data determined to have a relatively small correlation with the valence level.

**[0115]** For example, when the valence-component calculator **32** calculates the valence level VA on the basis of a facial expression which is non-physiology data, the valence-component calculator **32** identifies, for example, a facial expression from feature points of facial parts from the subject U, the feature points being acquired by the data acquirer **22**, and calculates the valence level VA for the identified facial expression on the basis of a predetermined association.

**[0116]** The emotion estimator **33** is a processor for estimating an emotion of the subject U on the basis of the arousal level AR calculated by the arousal-component calculator **31** and the valence level VA calculated by the valence-component calculator **32**. For example, the emotion estimator **33** pre-holds, in a memory, a predetermined association (e.g., Russell’s circumplex model illustrated in FIG. 1) between the arousal level and the valence level of people. This memory may be the memory **12** illustrated in FIG. 2 or may be a memory different from the memory **12** included in the emotion estimating apparatus **10**. The different memory may be, for example, a storage device (which may also be referred to as an “external storage device”) provided in a unit different from the emotion estimating apparatus **10**. As long as the emotion estimating apparatus **10** has a configuration that can read information regarding the aforementioned predetermined association from the memory and can write information to the memory, the memory in which the predetermined association is stored may or may not be included in the emotion estimating apparatus **10**.

**[0117]** The emotion estimator **33** estimates an emotion of the subject U by obtaining the arousal level AR calculated by the arousal-component calculator **31** and the valence level VA calculated by the valence-component calculator **32** and selecting an emotion that is associated with the obtained arousal level AR and valence level VA by the predetermined association.

**[0118]** When Russell’s circumplex model is used as the predetermined association, the emotion estimator **33** plots points corresponding to the obtained arousal level AR and valence level VA against a plane with a horizontal axis indicating a valence level and a vertical axis indicating an arousal level and estimates, as the emotion of the subject U, an emotion allocated to the points in Russell’s circumplex model (see FIG. 4).

**[0119]** The emotion estimator **33** holds a parameter **36** that serves as a reference for estimating an emotion on the basis of the arousal level AR and the valence level VA. The parameter **36** is, for example, a reference value representing a rate indicating which of the arousal level AR and the valence level VA is to be given a weight. On the basis of the arousal level AR and the valence level VA, the emotion estimator **33** estimates an emotion of the subject U with reference to the parameter **36**.

**[0120]** The corrector **37** is a processor for correcting the parameter **34** held by the arousal-component calculator **31**,

the parameter 35 held by the valence-component calculator 32, and the parameter 36 held by the emotion estimator 33. The corrector 37 corrects the parameters 34, 35, and 36 by adjusting them on the basis of information regarding a physical characteristic of the subject U, more specifically, information such as the gender, nationality, age, skin color, or the like. For example, for calculating the arousal level AR on the basis of the heart rate, which is physiology data, the corrector 37 sets a reference value for the heart rate to a relatively small value when the subject U is a male. With this setting, the arousal-component calculator 31 calculates the arousal level of a male subject as being a larger value than the arousal level of a female subject, even when the heart rate is the same. This is because the heart rate of the male during a normal state is generally lower than the heart rate of the female during a normal state, and thus the male has a larger difference in the heart rate relative to a normal state when the heart rate is the same.

[0121] The estimator 30 outputs information indicating the estimated emotion to the outputter 40.

[0122] The outputter 40 is a processor for outputting information indicating the emotion estimated by the estimator 30. The outputter 40 includes a display unit 41. The display unit 41 is a processor for displaying the information indicating the emotion estimated by the estimator 30 on a display screen of the display device 14 as an image.

[0123] For example, the outputter 40 displays, on the display device 14, an image in which the data acquired by the acquirer 20 and the information indicating the emotion estimated by the estimator 30 are arranged, as illustrated in FIG. 5. The image illustrated in FIG. 5 includes an image 51 indicating the facial color of the subject U, the facial color being acquired by the physiology data acquirer 21 as physiology data, an image 52 indicating a facial expression of the subject U, the facial expression being acquired by the data acquirer 22 as non-physiology data, and an image 53 indicating the emotion of the subject U, the emotion being estimated by the estimator 30. The image 53 is one example of an image indicating the emotion of the subject U by using a point in a plane with two coordinate axes indicating a valence level and an arousal level. The image 53 may indicate at least one of the valence level and the arousal level. The image 53 may indicate a value representing the intensity of a predetermined emotion (e.g., happiness) of the subject U. The image 53 may also indicate at least one of the reliability of the arousal level of the subject U and the reliability of the valence level thereof.

[0124] A method for the output performed by the outputter 40 is not limited to the method illustrated in FIG. 5 and can take a variety of variations including, for example, outputting only the arousal level and outputting the intensity of a particular emotion. Some variations will be described below in detail.

[0125] The following description will be given of a specific configuration of the emotion estimating apparatus 10.

[0126] FIG. 6 is a block diagram illustrating an emotion estimating apparatus 10A, which is a first specific example of the functional configuration of the emotion estimating apparatus 10 according to the embodiment. Constituent elements that are the same as or similar to those in the emotion estimating apparatus 10 are denoted by the same reference numerals, and detailed descriptions thereof are not given. The same also applies to the description below.

[0127] As illustrated in FIG. 6, the emotion estimating apparatus 10A includes an acquirer 20A and an estimator 30A, which correspond to the acquirer 20 and the estimator 30, respectively, in the emotion estimating apparatus 10. Other constituent elements are substantially the same as those in the emotion estimating apparatus 10.

[0128] The acquirer 20A includes a physiology data acquirer 21A and a non-physiology data acquirer 22A.

[0129] The physiology data acquirer 21A is one specific example of the physiology data acquirer 21 in the emotion estimating apparatus 10 and is a processor for acquiring the physiology data of the subject U. The physiology data acquirer 21A supplies the acquired physiology data to an arousal-component calculator 31A.

[0130] The non-physiology data acquirer 22A is one specific example of the data acquirer 22 in the emotion estimating apparatus 10 and is a processor for acquiring the non-physiology data of the subject U. The non-physiology data acquirer 22A supplies the acquired non-physiology data to a valence-component calculator 32A.

[0131] The estimator 30A includes the arousal-component calculator 31A and the valence-component calculator 32A.

[0132] The arousal-component calculator 31A is one specific example of the arousal-component calculator 31 in the emotion estimating apparatus 10 and is a processor for calculating an arousal level on the basis of the physiology data acquired by the physiology data acquirer 21A. For calculating an arousal level, the arousal-component calculator 31A uses the physiology data acquired by the physiology data acquirer 21A and does not use the non-physiology data acquired by the non-physiology data acquirer 22A.

[0133] The valence-component calculator 32A is one specific example of the valence-component calculator 32 in the emotion estimating apparatus 10 and is a processor for calculating a valence level on the basis of the non-physiology data acquired by the non-physiology data acquirer 22A. For calculating a valence level, the valence-component calculator 32A uses the non-physiology data acquired by the non-physiology data acquirer 22A and does not use the physiology data acquired by the physiology data acquirer 21A.

[0134] The emotion estimating apparatus 10A can avoid an arousal level calculation using the non-physiology data having a relatively small correlation with the arousal level and a valence level calculation using the physiology data having a relatively small correlation with the valence level. As a result, there is an advantage in that an emotion of the subject U can be estimated based on data that are highly correlated with the arousal level and the valence level. In addition, since the configuration is simplified, there are also advantages in that the development cost of the apparatus is reduced and the maintenance and operating cost is reduced.

[0135] FIG. 7 is a block diagram illustrating an emotion estimating apparatus 10B, which is a second specific example of the functional configuration of the emotion estimating apparatus 10 according to the embodiment. FIG. 8 is a block diagram illustrating emotion estimation processing performed by the emotion estimating apparatus 10B, which is the second specific example of the functional configuration of the emotion estimating apparatus 10 according to the embodiment.

[0136] As illustrated in FIG. 7, the emotion estimating apparatus 10B includes an acquirer 20B and an estimator 30B, which correspond to the acquirer 20 and the estimator

30, respectively, in the emotion estimating apparatus 10. Other constituent elements are substantially the same as those in the emotion estimating apparatus 10.

[0137] The acquirer 20B includes a physiology data acquirer 21B and a non-physiology data acquirer 22B.

[0138] The physiology data acquirer 21B is one specific example of the physiology data acquirer 21 in the emotion estimating apparatus 10 and is a processor for acquiring the physiology data of the subject U. The physiology data acquirer 21B supplies the acquired physiology data to both an arousal-component calculator 31A and a valence-component calculator 32A. As described above, the physiology data acquirer 21B differs from the physiology data acquirer 21 in the destination to which the acquired physiology data is supplied.

[0139] The non-physiology data acquirer 22B is one specific example of the data acquirer 22 in the emotion estimating apparatus 10 and is a processor for acquiring the non-physiology data of the subject U. The non-physiology data acquirer 22B supplies the acquired non-physiology data to both an arousal-component calculator 31B and a valence-component calculator 32B. As described above, the non-physiology data acquirer 22B differs from the data acquirer 22 in the element to which the acquired non-physiology data is supplied.

[0140] The estimator 30B includes the arousal-component calculators 31A and 31B and the valence-component calculators 32A and 32B. The arousal-component calculators 31A and 31B correspond to the arousal-component calculator 31 in the emotion estimating apparatus 10, and the valence-component calculators 32A and 32B correspond to the valence-component calculator 32 in the emotion estimating apparatus 10.

[0141] The arousal-component calculator 31A is a processor for calculating an arousal level (an arousal level AR1 in FIG. 8) on the basis of the physiology data acquired by the physiology data acquirer 21B. The arousal-component calculator 31A also calculates a reliability (a reliability r1 in FIG. 8) that is an indicator of correctness of emotion estimation based on the arousal level that is calculated.

[0142] Various methods are available as a method for calculating the reliability. For example, a low reliability may be calculated, as the amount of noise included in the physiology data acquired by the physiology data acquirer 21B increases. The reliabilities may be set according to the type of sensor 13 the physiology data acquirer 21B uses to acquire the physiology data from the subject U or may be freely set by the user.

[0143] The arousal-component calculator 31B is a processor for calculating an arousal level (an arousal level AR2 in FIG. 8) on the basis of the non-physiology data acquired by the non-physiology data acquirer 22B. The arousal-component calculator 31B also calculates a reliability (a reliability r2 in FIG. 8) of the arousal level that is calculated.

[0144] The valence-component calculator 32A is a processor for calculating a valence level (a valence level VA1 in FIG. 8) on the basis of the physiology data acquired by the physiology data acquirer 21B. The valence-component calculator 32A also calculates a reliability (a reliability r3 in FIG. 8) of the valence level that is calculated.

[0145] The valence-component calculator 32B is a processor for calculating a valence level (a valence level VA2 in FIG. 8) on the basis of the non-physiology data acquired by the non-physiology data acquirer 22B. The valence-

component calculator 32B also calculates a reliability (a reliability r4 in FIG. 8) of the valence level that is calculated.

[0146] An emotion estimator 33B obtains the arousal levels from the respective arousal-component calculators 31B and 32B, obtains the valence levels from the respective valence-component calculators 32A and 32B, and estimates an emotion of the subject U.

[0147] Upon obtaining a plurality of arousal levels, the emotion estimator 33B calculates one arousal level on the basis of the plurality of arousal levels. There are various methods for calculating one arousal level on the basis of a plurality of arousal levels. Examples of the methods include a method for determining an average of the plurality of arousal levels, a method for determining a weighted average of the plurality of arousal levels by using the reliability of each arousal level as a weight, and a method for determining a median of the plurality of arousal levels.

[0148] FIG. 8 illustrates a method for determining a weighted average. Using the reliabilities r1 and r2 of the arousal levels AR1 and AR2, the emotion estimator 33B calculates one arousal level AR in accordance with:

$$AR=(r1 \times AR1+r2 \times AR2)/(r1+r2) \quad (1)$$

[0149] Also, using the reliabilities r3 and r4 of the valence levels VA1 and VA2, the emotion estimator 33B calculates one valence level VA in accordance with:

$$VA=(r3 \times VA1+r4 \times VA2)/(r3+r4) \quad (2)$$

[0150] The emotion estimator 33B estimates an emotion of the subject U by selecting an emotion that is associated with the calculated arousal level AR and valence level VA by a predetermined association (e.g., Russell's circumplex model).

[0151] FIG. 9 is a block diagram illustrating an emotion estimating apparatus 10C, which is a third specific example of the functional configuration of the emotion estimating apparatus 10 according to the embodiment.

[0152] As illustrated in FIG. 9, the emotion estimating apparatus 10C includes an acquirer 20C and an estimator 30B, which correspond to the acquirer 20 and the estimator 30, respectively, in the emotion estimating apparatus 10. Other constituent elements are substantially the same as those in the emotion estimating apparatus 10.

[0153] The acquirer 20C includes physiology data acquirers 21A and 22C and non-physiology data acquirers 22A and 22D.

[0154] The physiology data acquirer 21A is one specific example of the physiology data acquirer 21 in the emotion estimating apparatus 10 and is a processor for acquiring the physiology data of the subject U. The physiology data acquirer 21A supplies the acquired physiology data to an arousal-component calculator 31A.

[0155] The physiology data acquirer 22C is one specific example of the data acquirer 22 in the emotion estimating apparatus 10 and is a processor for acquiring the physiology data of the subject U. The physiology data acquirer 22C supplies the acquired physiology data to an arousal-component calculator 31B.

[0156] The non-physiology data acquirers 22A and 22D are specific examples of the data acquirer 22 in the emotion estimating apparatus 10 and are processors for acquiring the non-physiology data of the subject U. The non-physiology data acquirer 22A and 22D supplies the acquired non-physiology data to valence-component calculators 32A and 32B, respectively.

[0157] The estimator 30B estimates an emotion of the subject U on the basis of a plurality of arousal levels and a plurality of valence levels, as in the case of the emotion estimating apparatus 10B.

[0158] FIG. 10 is a block diagram illustrating an emotion estimating apparatus 10D, which is a fourth specific example of the functional configuration of the emotion estimating apparatus 10 according to the embodiment.

[0159] As illustrated in FIG. 10, the emotion estimating apparatus 10D includes an acquirer 20D and an estimator 30D, which correspond to more details of the acquirer 20A and the estimator 30A in the emotion estimating apparatus 10A.

[0160] The acquirer 20D includes a camera 61, an analyzer 62, a heartbeat acquirer 63, a feature-point extractor 64, and a facial expression identifier 65.

[0161] The camera 61 is an image capture device that captures a moving image of the face of the subject U to generate moving-image data. The camera 61 supplies the generated moving-image data to the analyzer 62 and the feature-point extractor 64.

[0162] The analyzer 62 is a processor for analyzing small changes in the color of the face of the subject U on the basis of the moving-image data generated by the camera 61. The analyzer 62 obtains the moving-image data generated by the camera 61 and extracts a face area of the subject U in the moving image. The analyzer 62 then generates time-series data indicating the colors of pixels included in the extracted face area. Since the facial color exhibits small changes based on a pulse wave (heartbeat), the time-series data has components that vary according to the pulse wave.

[0163] The heartbeat acquirer 63 is a processor for acquiring the heart rate of the subject U from the time-series data generated by the analyzer 62. The heartbeat acquirer 63 acquires the time-series data generated by the analyzer 62 and extracts the components that vary according to the pulse wave from the acquired time-series data by using a frequency filter or the like, to thereby acquire the heart rate.

[0164] The feature-point extractor 64 is a processor for extracting feature points of the face of the subject U on the basis of the moving-image data generated by the camera 61. The feature-point extractor 64 extracts a part, such as an eyebrow, an eye, the nose, or the mouth, of the subject U from the moving-image data and further extracts the positions of feature points (e.g., upper, lower, left, and right end points) of each part.

[0165] The facial expression identifier 65 is a processor for identifying a facial expression of the subject U on the basis of the part positions extracted by the feature-point extractor 64. For example, when the left and right end points of the mouth is located above a reference position, the facial expression identifier 65 identifies the facial expression of the subject U as being a smile.

[0166] The estimator 30D includes an arousal-component calculator 31D, a valence-component calculator 32D, and an emotion estimator 33.

[0167] The arousal-component calculator 31D compares the heart rate of the subject U, the heart rate being acquired by the heartbeat acquirer 63, with a reference value to calculate an arousal level of the subject U. For example, the arousal-component calculator 31D calculates the arousal level as being zero when the heart rate of the subject U, the heart rate being acquired by the heartbeat acquirer 63, is equal to the reference value, and the arousal-component

calculator 31D calculates a higher arousal level, as the heart rate of the subject U acquired by the heartbeat acquirer 63 increases (in other words, the arousal-component calculator 31D calculates a lower arousal level, as the heart rate decreases).

[0168] The valence-component calculator 32D calculates a valence level on the basis of a facial expression of the subject U which is identified by the facial expression identifier 65. For example, when the facial expression of the subject U which is identified by the facial expression identifier 65 is a smile, the valence-component calculator 32D calculates a relatively large value for the valence level.

[0169] As described above, the emotion estimator 33 estimates an emotion of the subject U on the basis of the arousal level calculated by the arousal-component calculator 31D and the valence level calculated by the valence-component calculator 32D.

[0170] Processing performed by the emotion estimating apparatus 10 configured as described above will be described below.

[0171] FIG. 11 is a flow diagram illustrating an estimation method by which the emotion estimating apparatus 10 according to the embodiment estimates an emotion.

[0172] First, the emotion estimating apparatus 10 acquires physiology data from the subject U in step S1 (steps S101 to S103) and acquires physiology data or non-physiology data from the subject U in step S2 (steps S104 to S106). Either of steps S1 and S2 may be performed earlier or steps S1 and S2 may be performed in parallel at the same time.

[0173] In step S101, the physiology data acquirer 21 acquires the physiology data of the subject U by using the physiology sensor.

[0174] In step S102, the corrector 37 adjusts the parameter 34 in the arousal-component calculator 31. Step S102 is not an essential processing step and does not necessarily have to be executed.

[0175] In step S103, the arousal-component calculator 31 calculates an arousal level on the basis of the physiology data acquired in step S101.

[0176] In step S104, by using the physiology sensor or non-physiology sensor, the data acquirer 22 acquires the physiology data or non-physiology data of the subject U.

[0177] In step S105, the corrector 37 adjusts the parameter 35 in the valence-component calculator 32. Step S105 is not an essential processing step and does not necessarily have to be executed.

[0178] In step S106, the valence-component calculator 32 calculates a valence level on the basis of the physiology data or non-physiology data acquired in step S104.

[0179] In step S107, the corrector 37 adjusts the parameter 36 in the emotion estimator 33. Step S107 is not an essential processing step and does not necessarily have to be executed.

[0180] In step S108, the emotion estimator 33 estimates an emotion of the subject U on the basis of the arousal level calculated in step S103 and the valence level calculated in step S106.

[0181] In step S109, the display unit 41 displays information indicating the emotion of the subject U, the emotion being estimated in step S108.

[0182] Through the above-described series of processes, the emotion estimating apparatus 10 estimates various emotions felt by the subject U, on the basis of the physiology data and non-physiology data acquired from the subject U.

[0183] The following description will be given of images and so on that the emotion estimating apparatus 10 displays on the display device 14.

[0184] FIG. 12 is a schematic view of an image for receiving, from the user, a selection of the sensor 13 that the acquirer 20 according to the embodiment uses for data acquisition and a selection of the data to be acquired.

[0185] The image illustrated in FIG. 12 is displayed on the display device 14 in order to receive, from the user, a selection of the sensor 13 that the acquirer 20 uses for data acquisition and a selection of the data to be acquired. The image includes a plurality of buttons 121 representing the sensors 13 and a plurality of buttons 122 representing data types.

[0186] More specifically, the buttons 121 representing the sensors 13 include buttons 121A, 121B, and 121C representing a camera, a microphone, and an infrared camera, which serve as the sensors 13. When the user operates (e.g., touches) any of the buttons representing the sensors 13 that the acquirer 20 uses for data acquisition, the operation input IF 15 receives the operation, and control is performed so that the acquirer 20 acquires data by using the sensor 13 corresponding to the operated button.

[0187] The buttons 122 representing the data types include, more specifically, buttons 122A, 122B, and 122C representing facial color, a heart rate, and a blood pressure, which are data types. When the user operates any of the buttons which represents the type of data to be acquired by the acquirer 20, the operation input IF 15 receives the operation, and control is performed so that the acquirer 20 acquires data of the type corresponding to the operated button.

[0188] The number of sensors 13 to be selected or the number of data types to be selected may be two or more, and the number of sensors 13 to be selected may have an upper limit or lower limit. When the sensors 13 and data types include items that are associated with each other, they may be selected in coordination with each other. For example, when the camera is selected as the sensor 13, the facial color and the heart rate, which are data types that can be acquired by the camera, may be automatically selected.

[0189] FIG. 13 is a schematic view of an image for receiving, from the user, a selection of information to be output from the outputter 40 according to the embodiment. The image illustrated in FIG. 13 is displayed on the display device 14 in order to receive, from the user, a selection of information to be output from the outputter 40. This image includes a plurality of buttons 131 and a plurality of buttons 132 representing information to be output.

[0190] The buttons 131 are, for example, buttons for a general user, and, more specifically, includes buttons 131A, 131B, 131C, and, 131D respectively representing an emotion, an arousal level, a valence level, and a happy level. When the user operates any of the buttons which represents the information to be output from the outputter 40, the operation input IF 15 receives the operation, and control is performed so that the outputter 40 outputs the information corresponding to the operated button. For example, when the user operates the button 131A, the outputter 40 outputs the estimated emotion of the subject U. Also, when the user operates the button 131B, the outputter 40 outputs the arousal level of the subject U.

[0191] The buttons 132 are, for example, buttons for a developer and include, more specifically, buttons 132A,

132B, and 132C respectively representing three special outputs 1, 2, and 3. The special outputs are output methods provided for adjusting, on a trial basis, a method for calculating an arousal level and a valence level. When the user operates any of the buttons which represents the information to be output from the outputter 40, the operation input IF 15 receives the operation, and control is performed so that the outputter 40 outputs the information corresponding to the operated button.

[0192] A plurality of pieces of information may be selected to be output, and the number of sensors 13 to be selected may have an upper limit or a lower limit.

[0193] FIG. 14 is a schematic view of an image for receiving, from the user, settings of the sensor 13 according to the embodiment. The image illustrated in FIG. 14 is displayed on the display device 14 in order to receive, from the user, settings regarding the type of sensor 13 and so on. This image includes a button 141 indicating the type of sensor 13, a display area 142 indicating the state of the hardware of the sensor 13, a display area 143 indicating the reliability of an arousal level, a button 144 for adjusting the reliability of the arousal level, a display area 145 indicating the reliability of a valence level, and a button 146 for adjusting the reliability of the valence level.

[0194] For changing the type of sensor 13, the user operates the button 141 and then performs an operation for entering a post-change type of sensor 13. The operation is received by the operation input IF 15, and control is performed so that the type of sensor 13 is changed, and a character string displayed on the button 141 is changed to the changed type of sensor 13.

[0195] The display area 142 is a display area in which information indicating whether or not the sensor 13 is appropriately connected to the emotion estimating apparatus 10 is displayed. When the sensor 13 is appropriately connected, "connected state" is displayed, and when the sensor 13 is not appropriately connected, "disconnected state" is displayed.

[0196] The display areas 143 and 145 display the reliabilities of the arousal level and the valence level, respectively. When the user adjusts one of the reliabilities, he or she operates the corresponding button 144 or 146 and then performs an operation for changing the reliability.

[0197] FIG. 15 is a schematic view of an image for receiving, from the user, an adjustment of the reliability of the sensor 13 according to the embodiment. The image illustrated in FIG. 15 is displayed on the display device 14 in order to receive, from the user, settings regarding adjustment of the reliability (specifically, an increase or reduction in the reliability) of the sensor 13. The image is displayed, for example, when the operation input IF 15 receives the user's operation on the button 144 or 146 illustrated in FIG. 14.

[0198] The image includes display areas 151 and 154 in which the reliability of the arousal level and the reliability of the valence level are displayed. The image further includes buttons 152 and 155 for increasing the respective reliabilities of the arousal level and the valence level and buttons 153 and 156 for reducing the respective reliabilities of the arousal level and the valence level.

[0199] For increasing or reducing the arousal level reliability of the sensor 13, the user operates the corresponding button 152 or 153. When the operation input IF 15 receives the operation, the arousal level reliability of the sensor 13 is

increased or reduced in accordance with the operation, and a numerical value representing the arousal level displayed on the display area 151 is increased or reduced. As described above, the emotion estimating apparatus 10 can perform adjustment while presenting a numerical value representing the reliability of the valence level to the user. Since a description similar to the above description also applies to the valence level, the description thereof is not given hereinafter.

[0200] FIG. 16 is a schematic view of an image for setting a calculation expression regarding output information according to the embodiment. The image illustrated in FIG. 16 is displayed on the display device 14 in order to receive, from the user, settings of a calculation expression for a special output, which is one piece of output information. This image is displayed, for example, when the operation input IF 15 receives the user's operation on the button 132A in FIG. 13 or the like.

[0201] The image includes a display area 161 for a calculation expression, buttons 162 for entering operators, and a button 163 for determining the calculation expression. When the user's operation on any of the buttons 162 is performed, the operation input IF 15 receives the operation, and the calculation expression displayed on the display area 161 is updated. When the user's operation on the button 163 is performed, the operation input IF 15 receives the operation, and the calculation expression displayed on the display area 161 is determined to be a calculation expression for special output 1.

[0202] For modifying the contents of the special output, the user can modify the calculation expression by viewing the calculation expression displayed on the display area 161 and operating the buttons 162.

[0203] FIG. 17 is a schematic view of an image for checking a calculation expression regarding output information according to the embodiment. The image illustrated in FIG. 17 is displayed on the display device 14 in order for the user to view a calculation expression for a special output, which is one piece of output information. This image is displayed, for example, when the operation input IF 15 receives the user's operation on the button 163 in FIG. 16.

[0204] The image includes display areas 171, 172, and 173 respectively showing calculation expressions for three special outputs. For example, calculation expressions that the user set on the basis of the image illustrated in FIG. 16 are displayed in the display areas 171, 172, and 173. By viewing the calculation expressions for the three special outputs as a single image, the user can efficiently recognize the relationship among the calculation expressions and can find a point to be modified in the calculation expressions.

[0205] FIG. 18 is a schematic view of an image for selecting an output of information indicating an emotion according to the embodiment. The image illustrated in FIG. 18 is displayed on the display device 14 in order for the emotion estimating apparatus 10 to set information to be output as an estimated emotion.

[0206] This image includes buttons 181, 182, and 183 representing candidates of information that the emotion estimating apparatus 10 outputs as an estimated emotion. The buttons 181, 182, and 183 are given corresponding character strings indicating emotions. When the user performs an operation on any of the buttons, the operation input IF 15 receives the operation, and control is performed so as to perform switching as to whether or not the emotion

corresponding to the operated button is to be output as an estimated emotion. For example, when a determination that the happy level is to be output, the surprised level is to be output, and the angry level is not to be output is made upon button-operation performed by the user, the estimator 30 is permitted to output information indicating "happy" and "surprised" as the emotions of the subject U and is not permitted to output information indicating "angry".

[0207] The user can also limit the emotions to be output to some of the emotions. This offers an advantage in that the user can obtain, for example, only an estimation result needed by the subject U or can prevent an estimation result he or she doesn't want other people to see from being output when the user is the subject U and there is a possibility that other people see the estimation result.

[0208] FIG. 19 is a schematic view of an image for setting a representation of information indicating an emotion according to the embodiment. The image illustrated in FIG. 19 is displayed on the display device 14 in order for the emotion estimating apparatus 10 to set a representation of information to be output as an estimated emotion.

[0209] This image includes buttons 191, 192, 193, and 194 representing candidates of a representation of information that the emotion estimating apparatus 10 outputs as an estimated emotion. Each of the buttons 191, 192, 193, and 194 is given a character string of a representation indicating an emotion of happiness or an emotion similar thereto. When the user performs an operation on any of the buttons, the operation input IF 15 receives the operation, and control is performed so that the outputter 40 outputs information using the representation corresponding to the operated button. For example, when the user performs a button operation to select the button 191 "happy", a representation "happy" is output during output of the emotion of happiness.

[0210] FIG. 20 is a schematic view of a first example of an image including information indicating an emotion estimated by the estimator 30 according to the embodiment.

[0211] The image illustrated in FIG. 20 is displayed on the display device 14 in order to set information to be output as an emotion estimated by the estimator 30.

[0212] This image includes, at its left side, an image regarding an input and includes, at its right side, information regarding an output.

[0213] The left side in the image illustrated in FIG. 20 includes a button 201 for selecting whether or not "facial color", which is physiology data, is to be acquired from the subject U, a button 202 for selecting whether or not "facial expression", which is non-physiology data, is to be acquired from the subject U, and an image 203 showing data acquired from the subject U. When the user operates any of the above-described buttons which represents the data to be acquired by the acquirer 20, the operation input IF 15 receives the operation, and control is performed so that the acquirer 20 acquires the data corresponding to the operated button. FIG. 20 illustrates a state in which control is performed so that the acquirer 20 acquires "facial color", and the color of the button 201 is shown in dark color. Also, the image 203 shows the facial color actually acquired from the subject U.

[0214] The right side in the image illustrated in FIG. 20 includes an image 204 representing the emotion of the subject U, the emotion being estimated by the estimator 30, a button 205 for selecting whether or not the arousal level is to be output, and a button 206 for selecting whether or not

the valence level is to be output. FIG. 20 illustrates a state in which the estimator 30 estimates an emotion by using the arousal level and without using the valence level, and the button 205 is shown in dark color. In the image 204, the emotion estimated by the estimator 30 is shown using only the arousal level.

[0215] Thus, the user or the subject U can intuitively recognize an estimation result of the emotion of the subject U by viewing a single image in which the data acquired from the subject U and the emotion estimated based on the data are arranged.

[0216] FIG. 21 is a schematic view of a second example of an image including information indicating an emotion estimated by the estimator 30 according to the embodiment. The overall configuration of the image illustrated in FIG. 21 is substantially the same as that of the image illustrated in FIG. 20, and differs from that of the image illustrated in FIG. 20 in information acquired from the subject U and information to be output.

[0217] The left side in the image illustrated in FIG. 21 includes a button 211 for selecting whether or not “facial color” is to be acquired from the subject U, a button 212 for selecting whether or not “facial expression” is to be acquired from the subject U, and an image 213 showing the acquired data, as in the image illustrated in FIG. 20. FIG. 21 illustrates a state in which the acquirer 20 is controlled so as to acquire “facial expression”, and the color of the button 212 is shown in dark color. Also, the image 213 shows the facial color actually acquired from the subject U.

[0218] The right side in the image illustrated in FIG. 21 includes an image 214 representing the emotion of the subject U, a button 215 for selecting whether or not the arousal level is to be output, and a button 216 for selecting whether or not the valence level is to be output. FIG. 21 illustrates a state in which the estimator 30 estimates an emotion by using the valence level and without using the arousal level, and the button 216 is shown in dark color. In the image 214, the emotion estimated by the estimator 30 is shown using only the valence level.

[0219] FIG. 22 is a schematic view of a third example of an image including information indicating an emotion estimated by the estimator 30 according to the embodiment. The overall configuration of the image illustrated in FIG. 22 is substantially the same as that of the image illustrated in FIG. 20, and differs from that of the image illustrated in FIG. 20 in information acquired from the subject U and information to be output.

[0220] The left side in the image illustrated in FIG. 22 includes a button 221 for selecting whether or not “facial color” is to be acquired from the subject U and a button 222 for selecting whether or not “facial expression” is to be acquired from the subject U, as in the image illustrated in FIG. 20, and includes images 223 and 224 showing acquired data. FIG. 22 illustrates a state in which the acquirer 20 is controlled so as to acquire “facial color” and “facial expression”, and the colors of the button 221 and 222 are shown in dark color. Also, the images 223 and 224 show the facial color and facial expression, respectively, actually acquired from the subject U.

[0221] The right side in the image illustrated in FIG. 22 includes an image 225 representing the emotion of the subject U, a button 226 for selecting whether or not the arousal level is to be output, a button 227 for selecting whether or not the valence level is to be output, a button 228

for selecting whether or not the estimated emotion is to be output, and a character string 229 representing the estimated emotion. FIG. 22 illustrates a state in which the estimator 30 estimates an emotion by using the arousal level and the valence level, and the buttons 226 and 227 are shown in dark color. In the image 225, the emotion estimated by the estimator 30 is shown using the arousal level and the valence level.

[0222] In addition, FIG. 22 shows a state in which the estimated emotion is output, and the button 228 is shown in dark color. In this case, the character string 229 representing the estimated emotion is shown. The button 228 may be displayed only when outputting both the arousal level and the valence level is selected with the buttons 226 and 227. This is because, when one of the arousal level and the valence level is to be output, showing an emotion estimated from both the arousal level and the valence level is not appropriate.

[0223] FIG. 23 is a schematic view of a fourth example of the image including the information representing the emotion estimated by the estimator 30 according to the embodiment. The upper portion in the image illustrated in FIG. 23 is substantially the same as the image illustrated in FIG. 22. The lower portion in the image illustrated in FIG. 23 includes an image for setting the reliabilities of physiology data and non-physiology data (input data) acquired by the acquirer 20.

[0224] The image for setting the reliabilities of the input data includes a display area 231 in which the reliability of “facial color”, which is physiology data, acquired by the acquirer 20 is displayed, and a display area 234 in which the reliability of “facial expression”, which is non-physiology data, acquired by the acquirer 20 is displayed, and buttons 232, 233, 235, and 236 for adjusting the reliabilities. Since a method for adjusting the reliabilities are the same as or similar to that in FIG. 15, a description thereof is not given hereinafter.

[0225] FIG. 24 is a schematic view of a fifth example of the image including the information representing the emotion estimated by the estimator 30 according to the embodiment. The overall configuration of the image illustrated in FIG. 24 is substantially the same as the image illustrated in FIG. 20, and differs from that of the image illustrated in FIG. 20 in information acquired from the subject U and information to be output.

[0226] The left side in the image illustrated in FIG. 24 is substantially the same as that in FIG. 20. That is, FIG. 24 shows a state in which the acquirer 20 is controlled so as to acquire “facial color”.

[0227] The right side in the image illustrated in FIG. 24 shows a state in which the estimator 30 estimates an emotion by using the arousal level and the valence level and also displays information representing an estimated emotion.

[0228] The image illustrated in FIG. 24 also includes an image 241 for issuing a warning indicating that the reliability of the valence level estimated from the “facial color”, which is physiology data, is low.

[0229] As described above, the outputter 40 displays an emotion estimated from the arousal level and the valence level, and also, when at least one of the reliability of the arousal level and the reliability of the valence level is lower than a predetermined value, the outputter 40 displays an image to that effect. Upon viewing the image, the user or the

subject U can determine that the emotion that is output together with the warning is not so correct.

[0230] FIG. 25 is a schematic view of a sixth example of the image including the information representing the emotion estimated by the estimator 30 according to the embodiment. The overall configuration of the image illustrated in FIG. 25 is substantially the same as the image illustrated in FIG. 22, and differs from that of the image illustrated in FIG. 22 in information indicating physiology data acquired from the subject U.

[0231] The left side in the image illustrated in FIG. 25 includes a button 251 for setting whether or not “heartbeat”, which is physiology data, is to be acquired from the subject U and an image 252 showing time-series data of the waveform of acquired heartbeats.

[0232] Thus, the user or the subject U can recognize the emotion of the subject U which is estimated based on the heartbeats and the facial expression.

[0233] FIG. 26A is a schematic view of a seventh example of the image including the information representing the emotion estimated by the estimator 30 according to the embodiment. The overall configuration of the image illustrated in FIG. 26A is substantially the same as the image illustrated in FIG. 22, and differs from that of the image illustrated in FIG. 22 in information indicating non-physiology data acquired from the subject U.

[0234] The left side in the image illustrated in FIG. 26A includes buttons 261 and 262 for setting whether or not voice and a linguistic representation, which are non-physiology data, are to be obtained from the subject U, an image 263 showing the intensity of obtained voice, and an image 264 showing the intensity of obtained linguistic expression.

[0235] FIG. 26B is a schematic view of an eighth example of the image including the information representing the emotion estimated by the estimator 30 according to the embodiment. The overall configuration of the image illustrated in FIG. 26B is substantially the same as the image illustrated in FIG. 26A, and differs from that of the image illustrated in FIG. 26A in information indicating physiology data acquired from the subject U.

[0236] The left side in the image illustrated in FIG. 26B includes a button 265 for setting whether or not “heartbeat”, which is physiology data, is to be acquired from the subject and an image 266 showing the waveform of acquired heartbeats.

[0237] Thus, the user or the subject U can recognize the emotion of the subject U which is estimated based on the facial color, voice, and a linguistic representation.

[0238] FIG. 27 is a schematic view of an image for registering subject information according to the embodiment.

[0239] The image illustrated in FIG. 27 is displayed on the display device 14 in order to register, with the emotion estimating apparatus 10, information regarding the subject U whose emotion is to be estimated by the emotion estimating apparatus 10 (this information is also referred to as “subject information”).

[0240] This image includes an image for receiving, from the user, operations for registering information regarding the subject U. Examples of the information include the nationality, the gender, the age, an average heart rate during a normal state, a blood pressure during a normal state, the skin color, and a chronic disease of the subject U. When the user performs an operation on any of areas in which the afore-

mentioned pieces of information are displayed, the operation input IF 15 receives the operation, and control is performed so as to change data corresponding to the operated button. A known method, such as a method in which a user selects displayed options, such as settable characters or symbols, can be used for changing the data.

[0241] FIG. 28 is a schematic view of a first example of an image for registering the face of the subject U according to the embodiment.

[0242] The image illustrated in FIG. 28 is displayed on the display device 14 in order to register the face of the subject U whose emotion is to be estimated by the emotion estimating apparatus 10.

[0243] This image includes an image 281 showing the face of the subject U to be registered with the emotion estimating apparatus 10, a display area 282 indicating an average heart rate during a normal state, a display area 283 indicating an average respiration rate during a normal state, and a button 284 for the registration. The image 281 may be an image resulting from reading of data stored in a storage medium or may be an image resulting from photography with a camera when the emotion estimating apparatus 10 has the camera. The average heart rate and the average respiration rate may be input by the user or may be acquired by the sensor 13 from the user.

[0244] When the user performs an operation corresponding to the button 284, the operation input IF 15 receives the operation, and the image 281 when the operation was performed is registered as the face of the subject U. Based on the face of the subject U which is registered as described above, a facial expression, which is non-physiology data, is analyzed.

[0245] FIG. 29 is a block diagram of a second example of the image for registering the face of the subject U according to the embodiment.

[0246] The image illustrated in FIG. 29 is displayed on the display device 14 in order to register the face with various facial expressions of the subject U whose emotion is to be estimated by the emotion estimating apparatus 10.

[0247] This image includes an image 291 showing the face of the subject U to be registered with the emotion estimating apparatus 10, a button 293 for registration, and an image 294 for prompting the subject U to make a facial expression. When the emotion estimating apparatus 10 has a camera, a message 292 for prompting the subject U to make various facial expressions.

[0248] The image 291 may be an image resulting from reading of data stored in a storage medium or an image resulting photography with a camera when the emotion estimating apparatus 10 has the camera.

[0249] The message 292 is a message for prompting the subject U to make a facial expression (e.g., an angry facial expression) of the subject U to be registered. The subject U views the message 292 and makes a facial expression in accordance with the contents of the message 292.

[0250] When the user performs an operation on the button 293, the operation input IF 15 receives the operation, and the image 291 when the operation was performed is registered as the face of the subject U with the facial expression to be registered. Based on the face of the subject U which is registered as described above, a facial expression, which is non-physiology data, is analyzed. Although the number of the facial expressions to be registered may be two or more, for example, it is not necessary to register facial expressions

corresponding to all emotions included in Russell's circumplex model (FIG. 1). This is because, for example, a method using movement of feature points or the like has already been known for an association between a human emotion and a facial expression, and a face with a predetermined emotion can be formed by moving the positions of feature points included in the registered face of the subject U on the basis of a predetermined relationship.

[0251] The image 294 is an image for prompting the subject U to make his or her facial expression. For example, when it is desired to make the subject U make an angry facial expression, the image 294 shows, as an example of the facial expression, an angry facial expression of the subject U which is generated by computer graphics on the basis of an image of the face of the subject U. The image 294 may be an image for making the subject U to feel an emotion so as to spontaneously make a facial expression. For example, when it is desired to register a smile of the subject U, the image 294 may be an image showing a smile of a person different from the subject U or may be an image of animal or the like. The image may also include words or a character representation (e.g., words "It's very beautiful, isn't it?").

[0252] FIG. 30 is a schematic view of a first example of an image for selecting an area for detecting a facial expression from the face of the subject U according to the embodiment. The image illustrated in FIG. 30 is displayed on the display device 14 in order to set a face area of the subject U from which a facial expression, which is non-physiology data, is to be acquired by the acquirer 20.

[0253] This image includes an image 301 in which a pattern of an area from which a facial expression is to be obtained is shown superimposed on the face of the subject U, images 302A, images 302B, and images 302C showing candidates of the pattern of the area, a cursor 303, and a button 304 for registration.

[0254] The image 301 is an image in which the pattern of the area included in the images 302A and specified by the cursor 303 is superimposed on the face of the subject U. The candidates of the pattern of the area are obtained as various patterns of combinations of characteristic portions obtained by segmenting the face. For example, the face is divided into a portion including the eyes on the face, a portion including the nose and the cheek, a portion including the nose and a region between the eyebrows, and a portion including the mouth, and these portions are combined into various combinations to thereby form the patterns of the areas, as illustrated in the images 302A and so on.

[0255] The cursor 303 specifies one of the images 302A and can be moved by a user operation.

[0256] When a user performs an operation on the button 304, the operation input IF 15 receives the operation, and the image 301 when the operation was performed is registered as the pattern of the area from which the facial expression is to be obtained.

[0257] FIG. 31 is a schematic diagram of a second example of the image for selecting an area for detecting a facial expression from the face of the subject U according to the embodiment. The overall configuration and rolls of the image illustrated in FIG. 31 are substantially the same as those of the image illustrated in FIG. 30.

[0258] A portion including the eyes on the face of the subject U included in the image 311 illustrated in FIG. 31 is covered with sunglasses, and it is thought to be difficult to analyze a facial expression on the basis of the eye portion.

In such a case, the pattern of the area corresponding to the image 302B, which is the pattern of an area not including the eye portion, may be registered as the pattern of the area from which a facial expression is to be obtained.

[0259] When information regarding wrinkles of the face is included, it is possible to enhance the accuracy of a facial-expression or emotion determination made by the emotion estimating apparatus 10. In addition, when the emotion estimating apparatus 10 has a function for identifying an individual, it is also possible to enhance the accuracy of identifying an individual.

[0260] FIG. 32 illustrates an example of a screen for prompting the user to select whether or not information regarding wrinkles of the face is to be used when the emotion estimating apparatus 10 makes a facial-expression or emotion determination. In the example in FIG. 32, a message indicating that use of the information regarding wrinkles of the face can enhance the accuracy of the facial-expression and emotion determination may be presented to the user.

#### Modifications of Embodiments

[0261] In a modification, a description will be given of another configuration of the emotion estimating apparatus for estimating various emotions felt by a person. Constituent elements that are the same as or similar to those in the embodiment are denoted by the same reference numerals, and detailed descriptions are not given hereinafter.

[0262] FIG. 33 is a block diagram illustrating the hardware configuration of an emotion estimating apparatus 10E according to this modification.

[0263] As illustrated in FIG. 33, the emotion estimating apparatus 10E includes a CPU 11, a memory 12, a display device 14, an operation input IF 15, a sensor input IF 16, and a sensor 17. The emotion estimating apparatus 10E differs from the emotion estimating apparatus 10 in that the emotion estimating apparatus 10E has the sensor input IF 16 instead of the sensor 13.

[0264] The sensor input IF 16 is connected to the sensor 17 for acquiring, from the human subject U, physiology data or non-physiology data of the subject U. The sensor 17 may be the same as or similar to the sensor 13 in the emotion estimating apparatus 10.

[0265] In the emotion estimating apparatus 10E, the acquirer 20 acquires information from the sensor 17 via the sensor input IF 16 and performs processing that is analogous to that in the emotion estimating apparatus 10 in the embodiment.

[0266] With this configuration, the emotion estimating apparatus 10E can obtain information from the sensor 17 external to the emotion estimating apparatus 10E without provision of a sensor in the emotion estimating apparatus 10E and can estimate the emotion of a subject.

[0267] As described above, the emotion estimating apparatus in the embodiment can estimate an emotion of a subject on the basis of a predetermined association and through use of two or more pieces of data including physiology data acquired from the subject and physiology data different from that physiology data or non-physiology data acquired from the subject. Through use of the two or more pieces of data, the emotion estimating apparatus disclosed herein calculates two indicators, that is, a first value (an arousal level) and a

second value (a valence level) of a subject, thereby making it possible to appropriately estimate various emotions felt by the subject.

[0268] Also, through use of the physiology data and non-physiology data acquired from the subject and based on basis of the predetermined association, the emotion estimating apparatus can estimate an emotion of the subject. The physiology data has a relatively high correlation with the arousal level, and the non-physiology data has a relatively high correlation with the valence level. Hence, when the physiology data and the non-physiology data are used, the arousal level and the valence level can be more accurately calculated, and thus, the emotion of the subject can be estimated with higher accuracy.

[0269] Also, the emotion estimating apparatus calculates an arousal level having a relatively high correlation with the physiology data through use of the physiology data acquired from the subject, and calculates a valence level having a relatively high correlation with the non-physiology data through use of the non-physiology data. Hence, the arousal level and the valence level can be more accurately calculated, and thus, the emotion of the subject can be estimated with higher accuracy.

[0270] Also, the emotion estimating apparatus acquires both the heart rate, which is physiology data, of the subject and a facial expression, which is non-physiology data, by using a camera and estimates the emotion of the subject. Thus, when both the physiology data and the non-physiology data are acquired using one device, which is a camera, to estimate the emotion, the amount of burden on the subject is reduced, and convenience improves.

[0271] The emotion estimating apparatus also outputs the arousal level and the valence level of the subject by representing the arousal level and the valence level as a point in a plane. This allows the user or the subject to intuitively know which of various possible subject emotions the emotion of the subject corresponds and also the intensity of the emotion of the subject.

[0272] The emotion estimating apparatus outputs at least one of the arousal level and the valence level of the subject. As a result of the outputting, the user or the subject can know not only the emotion of the subject but also the arousal level and/or the valence level felt by the subject.

[0273] Also, the emotion estimating apparatus outputs the intensity of a particular emotion (e.g., happiness) of the subject (in other words, the degree of an emotion). For example, the emotion estimating apparatus outputs not only an emotion "happiness" but also the degree of happiness. This allows the user or the subject to know not only the emotion of the subject but also the intensity or degree of the emotion.

[0274] Also, the emotion estimating apparatus outputs, as reliabilities, the level of correctness at which the estimated emotion represents the emotion of the subject. This allows the user or the subject to know not only the emotion of the subject but also the level of correctness at which the emotion represents the emotion of the subject.

[0275] Also, when the arousal level or the valence level can be obtained from a plurality of pieces of physiology data and non-physiology data, the emotion estimating apparatus can estimate an emotion of the subject by appropriately evaluating the plurality of pieces of physiology data and non-physiology data on the basis of the reliabilities.

[0276] In addition, the emotion estimating apparatus outputs a warning when the estimated emotion does not so correctly represent the emotion of the subject. This allows the user or the subject to clearly know that the estimated emotion does not so correctly represent the emotion of the subject.

[0277] Additionally, by varying the reference values for the arousal level and the valence level on the basis of information (e.g., the gender or age) relevant to a physical characteristic of the subject, the emotion estimating apparatus can adjust the arousal level and the valence level in accordance with the physical characteristic of the subject and can more appropriately estimate the emotion.

[0278] Also, upon receiving a setting for the face area for acquiring a facial expression of the subject, the emotion estimating apparatus acquires a facial expression of the subject by using the received setting. For example, when the subject wears sunglasses, the portion of the eyes of the subject is hidden by the sunglasses, and thus information regarding a facial expression cannot be obtained from the eye portion. In such a case, the emotion estimating apparatus is adapted to obtain a facial expression of the subject from a portion other than the eye portion of the subject to thereby make it possible to more appropriately detect the facial expression.

[0279] Also, by using the physiology data, such as facial color, the emotion estimating apparatus can more specifically estimate an emotion felt by the subject.

[0280] In addition, by using the non-physiology data, such as a facial expression, the emotion estimating apparatus can more specifically estimate an emotion felt by the subject.

[0281] Additionally, by using the information, such as gender, the emotion estimating apparatus can more specifically estimate an emotion felt by the subject.

[0282] In each embodiment described above, the individual constituent elements may be implemented by dedicated hardware or may be realized by executing a software program suitable for each constituent element. A program executor, such as a CPU or a processor, may read and execute a software program recorded in a storage medium, such as a hard disk or a semiconductor memory, to thereby realize the constituent elements. Herein, software for realizing the emotion estimating apparatus in each embodiment described above is, for example, a program as described below.

[0283] That is, this program causes a computer to execute an emotion estimating method for an emotion estimating apparatus for estimating an emotion of a subject. The emotion estimating method includes: acquiring first data and second data from a subject, the first data corresponding to physiology data, and the second data corresponding to one of physiology data and non-physiology data and being different from the first data; calculating a first value and a second value based on the acquired first data and second data, the first value indicating a degree of arousal of the subject and the second value indicating a degree of valence of the subject; estimating the emotion of the subject, by using the calculated first value and second value and based on a predetermined association of people's emotions with a degree of arousal and a degree of valence of the people, the predetermined association being pre-stored in a memory; and outputting information indicating the estimated emotion.

**[0284]** Although the emotion estimating apparatus and so on according to one or more aspects have been described above based on the embodiment, the present disclosure is not limited to the embodiment. Modes obtained by applying various modifications conceived by those skilled in the art to the embodiment or modes constituted by combining the constituent elements in different embodiments may also be encompassed by the scope of one or more aspects, as long as such modes do not depart from the spirit and scope of the present disclosure.

**[0285]** The present disclosure can be applied to an emotion estimating method, an emotion estimating apparatus, and so on that estimate various emotions felt by people.

What is claimed is:

1. An emotion estimating method for an emotion estimating apparatus for estimating an emotion of a subject, the emotion estimating method comprising:

acquiring first data and second data from the subject, the first data corresponding to physiology data, and the second data corresponding to one of physiology data different from the first data and non-physiology data; calculating a first value and a second value based on the acquired first data and second data, the first value indicating a degree of arousal of the subject and the second value indicating a degree of valence of the subject;

estimating the emotion of the subject, by using the calculated first value and second value and based on a predetermined association of people's emotions with a degree of arousal and a degree of valence of the people, the predetermined association being pre-stored in a memory; and

outputting information indicating the estimated emotion.

2. The emotion estimating method according to claim 1, wherein the second data is non-physiology data.

3. The emotion estimating method according to claim 1, wherein in the calculating, the first value is calculated based on the first data, and the second value is calculated based on the second data.

4. The emotion estimating method according to claim 2, wherein the emotion estimating apparatus comprises a camera that captures an image of the subject's face to generate moving-image data; and

wherein in the acquiring,

a heart rate of the subject is acquired as the first data, based on the moving-image data generated by the camera, and

a facial expression of the subject is acquired as the second data, the facial expression being identified based on a position of a feature point on the subject's face in the moving-image data generated by the camera.

5. The emotion estimating method according to claim 1, wherein in the outputting, a point in a plane with two coordinate axes indicating the first value and the second value is output on a display screen of a display device as information indicating the emotion of the subject, the display device being included in the emotion estimating apparatus.

6. The emotion estimating method according to claim 1, wherein in the outputting, at least one of the first value and the second value is output on a display screen of a display device as information indicating the emotion of

the subject, the display device being included in the emotion estimating apparatus.

7. The emotion estimating method according to claim 1, wherein in the outputting, a value indicating an intensity of a predetermined emotion of the subject is output on a display screen of a display device as information indicating the emotion of the subject, the display device being included in the emotion estimating apparatus.

8. The emotion estimating method according to claim 1, wherein in the calculating,

a first reliability that is an indicator indicating correctness of an emotion of the subject, the emotion being estimated based on the first value, is calculated, and a second reliability that is an indicator indicating correctness of an emotion of the subject, the emotion being estimated based on the second value, is calculated; and

wherein in the outputting,

information indicating at least one of the first reliability and the second reliability is output together with the information indicating the estimated emotion.

9. The emotion estimating method according to claim 8, wherein the first data acquired in the acquiring comprises one or more pieces of first data, and the second data acquired in the acquiring comprises one or more pieces of second data; and

wherein in the calculating,

a first value and a first reliability are calculated for each of the acquired one or more pieces of first data, the first value is a value resulting from weighted average using the first reliability for the first value as a weight,

a second value and a second reliability are calculated for each of the acquired one or more pieces of second data, and

the second value is a value resulting from weighted average using the second reliability for the second value as a weight.

10. The emotion estimating method according to claim 8, wherein in the outputting,

when at least one of the first reliability and the second reliability is smaller than a predetermined threshold, a warning is output.

11. The emotion estimating method according to claim 1, wherein in the calculating,

the first data is compared with a predetermined first reference value to calculate the first value, and the second data is compared with a predetermined second reference value to calculate the second value; and

wherein the emotion estimating method further comprises:

obtaining information relevant to a physical characteristic of the subject; and

adjusting the predetermined first reference value or the predetermined second reference value, based on the obtained information relevant to the physical characteristic of the subject.

12. The emotion estimating method according to claim 4, further comprising:

receiving, from a user, a selection of an area included in a plurality of predetermined areas of a human face and used for acquiring a facial expression that is the second data,

wherein in the acquiring,

a feature point included in the area of the subject's face is acquired as the second data; and

wherein in the calculating,

the second value is calculated based on the feature point included in the area of the subject's face.

**13.** The emotion estimating method according to claim 1, wherein the physiology data includes at least one of face color, a heart rate, a heart rate variation, a low frequency/high frequency (LF/HF) of a heart rate variation, an R wave to R wave (R-R) interval, a pulse wave, a pulse variation, a brain wave, a respiration rate, a respiratory volume, a blood flow, a blood flow variation, a blood pressure, a blood pressure variation, an oxygen saturation level, movement of a part of a human body, movement of a muscle of a human body, movement of a muscle of a face, a body temperature, a skin temperature, a skin conductance, a skin resistance, an amount of sweat, and a perspiration rate.

**14.** The emotion estimating method according to claim 1, wherein the non-physiology data includes at least one of a facial expression, an emotion, a touch input signal, voice, a linguistic representation, a sentence, and body motion.

**15.** The emotion estimating method according to claim 11, wherein the predetermined first reference value or the predetermined second reference value is calculated based on at least one of a gender, nationality, age, and skin color of the subject.

**16.** The emotion estimating method according to claim 1, wherein a processor performs at least one of the acquiring, the calculating, the estimating, and the outputting.

**17.** An emotion estimating apparatus comprising:  
an acquirer that acquires first data and second data from a subject, the first data corresponding to physiology data, and the second data corresponding to one of physiology data and non-physiology data and being different from the first data;

an estimator (i) that calculates a first value and a second value based on the acquired first data and second data, the first value indicating a degree of arousal of the subject and the second value indicating a degree of valence of the subject, and (ii) estimates the emotion of the subject, by using the calculated first value and second value and based on a predetermined association of people's emotions with a degree of arousal and a degree of valence of the people, the predetermined association being pre-stored in a memory; and

an outputter that outputs information indicating the estimated emotion.

**18.** The emotion estimating apparatus according to claim 17,

wherein at least one of the acquirer, the estimator, and the outputter comprises a processor.

**19.** A non-transitory recording medium storing a computer program, the program causing a computer to execute:

acquiring first data and second data from a subject, the first data corresponding to physiology data, and the second data corresponding to one of physiology data and non-physiology data and being different from the first data;

calculating a first value and a second value based on the acquired first data and second data, the first value indicating a degree of arousal of the subject and the second value indicating a degree of valence of the subject;

estimating the emotion of the subject, by using the calculated first value and second value and based on a predetermined association of people's emotions with a degree of arousal and a degree of valence of the people, the predetermined association being pre-stored in a memory; and

outputting information indicating the estimated emotion.

\* \* \* \* \*

专利名称(译)	情绪估计方法，情绪估计设备和记录介质存储程序		
公开(公告)号	<a href="#">US20170105662A1</a>	公开(公告)日	2017-04-20
申请号	US15/288866	申请日	2016-10-07
申请(专利权)人(译)	PANASONIC知识产权公司的AME		
当前申请(专利权)人(译)	PANASONIC知识产权公司的AME		
[标]发明人	SILAWAN NAWATT KUSUKAME KOICHI UCHIDA SHINJI SHIKII SHINICHI YONEDA AKI ITO H TATSUO		
发明人	SILAWAN, NAWATT KUSUKAME, KOICHI UCHIDA, SHINJI SHIKII, SHINICHI YONEDA, AKI ITO H, TATSUO		
IPC分类号	A61B5/1171 A61B5/0205 A61B5/0476 A61B5/026 A61B5/00 A61B5/08 A61B5/145 A61B5/11 A61B5/053 A61B5/16 A61B5/021		
CPC分类号	A61B5/1171 A61B5/165 A61B5/02055 A61B5/0476 A61B5/026 A61B5/021 G06K9/00302 A61B5/0816 A61B5/14542 A61B5/11 A61B5/053 A61B5/4803 G10L25/63 A61B5/02108 A61B5/0531 A61B5/1107 A61B5/1126 A61B5/7225 A61B5/7235 A61B5/7271 A61B5/74 A61B5/0077 A61B5/1128 A61B5/7264 G06F2203/011 G06K9/6289 G06K2009/00939 G06K2209/27 G16H50/20 H04N21/44218		
优先权	2016029363 2016-02-18 JP 62/241374 2015-10-14 US		
外部链接	<a href="#">Espacenet</a> <a href="#">USPTO</a>		

摘要(译)

一种情绪估计方法，包括：从所述对象获取第一数据和第二数据，所述第一数据对应于生理数据，所述第二数据对应于与所述第一数据和非生理数据不同的生理数据之一；基于所获取的第一数据和第二数据计算第一值和第二值，第一值表示受试者的觉醒程度，第二值表示受试者的效价程度；通过使用所计算的第一值和第二值并基于人的情绪与人的觉醒程度和效价程度的预定关联来估计对象的情绪，将预定关联预先存储在存储器中；并输出指示估计情绪的信息。

