



US010032109B2

(12) **United States Patent**
Hyde et al.

(10) **Patent No.:** **US 10,032,109 B2**
(45) **Date of Patent:** **Jul. 24, 2018**

(54) **SYSTEMS AND METHODS FOR INDIVIDUAL IDENTIFICATION AND AUTHORIZATION UTILIZING CONFORMABLE ELECTRONICS**
(71) Applicant: **ELWHA LLC**, Bellevue, WA (US)
(72) Inventors: **Roderick A. Hyde**, Redmond, WA (US); **Jordin T. Kare**, San Jose, CA (US); **Gary L. McKnight**, Bothell, WA (US); **Robert C. Petroski**, Seattle, WA (US); **Elizabeth A. Sweeney**, Seattle, WA (US)

(73) Assignee: **Elwha LLC**, Bellevue, WA (US)
(*) Notice: Subject to any disclaimer, the term of this patent is extended or adjusted under 35 U.S.C. 154(b) by 0 days.

(21) Appl. No.: **15/232,888**

(22) Filed: **Aug. 10, 2016**

(65) **Prior Publication Data**
US 2018/0046892 A1 Feb. 15, 2018

(51) **Int. Cl.**
G06F 21/32 (2013.01)
G09B 5/02 (2006.01)
(Continued)

(52) **U.S. Cl.**
CPC **G06K 19/0776** (2013.01); **A61B 5/00** (2013.01); **A61B 5/1171** (2016.02);
(Continued)

(58) **Field of Classification Search**
CPC **G07C 9/00158**; **G07C 9/00134**; **G07C 9/00071**; **G07C 9/00563**;
(Continued)

(56) **References Cited**
U.S. PATENT DOCUMENTS
4,783,823 A * 11/1988 Tasaki G06K 9/00 235/380
6,317,834 B1 11/2001 Gennaro et al.
(Continued)

FOREIGN PATENT DOCUMENTS
JP 2006-346221 A 12/2006
WO WO 2015/167926 A1 11/2015

OTHER PUBLICATIONS
Ultraflexible organic photonic skin, Yokota et al., Sci. Adv. (2016); 2 : e1501856.

(Continued)
Primary Examiner — Dionne H Pendleton
(74) *Attorney, Agent, or Firm* — Advent, LLP; Daniel J. Honz

(57) **ABSTRACT**
A device embodiment includes, but is not limited to, a deformable substrate; a sensor assembly including an identity sensor configured to generate identity sense signals associated with a physical characteristic of an individual subject; circuitry including an identity comparison module configured to compare the identity sense signals to reference data indicative of one or more physical characteristics associated with an identity of at least one individual to determine whether the identity sense signals correspond to the identity of the at least one individual, the circuitry including an authorization comparison module configured to compare at least one of the identity sense signals or the identity with one or more authorization parameters; and a reporter configured to generate one or more communication signals associated with a comparison of at least one of the identity sense signals with the authorization parameters or the identity with the one or more authorization parameters.

18 Claims, 13 Drawing Sheets

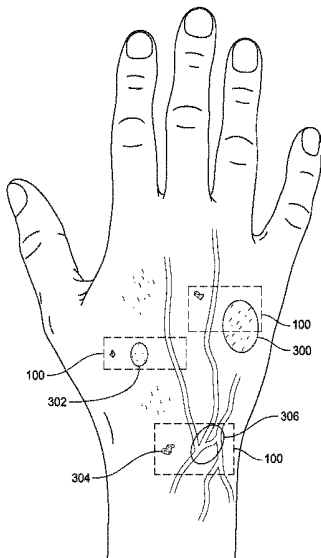

- (51) **Int. Cl.**
A63B 24/00 (2006.01)
G06K 19/077 (2006.01)
G07C 9/00 (2006.01)
A61B 5/00 (2006.01)
A61B 5/1171 (2016.01)
G06F 17/30 (2006.01)
G06K 19/04 (2006.01)
- (52) **U.S. Cl.**
CPC **G06F 17/30985** (2013.01); **G06K 19/041**
(2013.01); **G06K 19/07749** (2013.01); **G07C**
9/00015 (2013.01); **G07C 9/00087** (2013.01);
G07C 2009/00095 (2013.01)
- (58) **Field of Classification Search**
CPC G07C 2009/00095; G07C 9/00023; G07C
9/00087; A61B 5/11; A61B 5/6802; A61B
2560/0223; A61B 2562/00; A61B
2562/0219; A61B 5/0002; A61B 5/0022;
A61B 5/0024; A61B 5/02416; A61B
5/02438; A61B 5/0402; A61B 5/0404;
A61B 5/681; A61B 5/725; A61B 5/742;
A61B 5/00; A61B 5/112; A61B 5/441;
A61B 5/1032; A61B 5/1112; A61B
5/1118; A61B 5/1123; A61B 5/117; A61B
5/1172; A61B 5/6844; A61B 5/7257;
A61B 5/7264; A61B 5/7267; A61B
5/7271; A61B 5/7475; A61B 5/1171;
G06K 9/00342; G06K 9/00335; G06K
19/041; G06K 19/07749; G06K 19/0776;
G06K 9/00496; A41D 1/002; A41D
2600/10; A63B 24/0062; A63B 69/36;
G01C 22/006; G01P 13/00; G01P 1/02;
G01S 19/00; G06F 19/3481; G06F 21/32;
G06F 3/014; G06F 3/017; G06F
17/30985; G06F 17/30988; G06F 19/24;
G06F 17/2288; G06F 17/24; G06Q 50/01;
G09B 19/0038; G09B 5/02; G08B
25/008; H04M 1/66; H04M 1/72527;
G16H 40/20; G16H 50/00; G16H 80/00
See application file for complete search history.

(56) **References Cited**

U.S. PATENT DOCUMENTS

- 2004/0236701 A1 * 11/2004 Beenu G06F 17/30725
705/64
- 2006/0000902 A1 1/2006 Strawn et al.
2010/0130875 A1 5/2010 Banet et al.
2011/0213625 A1 9/2011 Joao
2011/0254682 A1 10/2011 Sigrist Christensen
2012/0165759 A1 6/2012 Rogers et al.
2012/0320581 A1 12/2012 Rogers et al.
2013/0041235 A1 2/2013 Rogers et al.
2013/0294617 A1 11/2013 Alberth, Jr.
2013/0297301 A1 11/2013 Alberth, Jr.
2014/0081665 A1 3/2014 Holmes
2014/0245786 A1 9/2014 Proud et al.
2015/0210042 A1 7/2015 Tapio et al.

- 2015/0292856 A1 10/2015 Ganton et al.
2015/0363563 A1 12/2015 Hallwachs
2016/0051156 A1 2/2016 Kim et al.
2016/0189528 A1 * 6/2016 Lee G08B 25/008
340/541
- 2016/0247161 A1 8/2016 Wang et al.
2017/0014049 A1 1/2017 Durnanyan et al.
2017/0021172 A1 1/2017 Perez et al.
2017/0032168 A1 * 2/2017 Kim H04L 63/0861
2017/0036066 A1 2/2017 Chahine
2017/0039358 A1 * 2/2017 Yuen G06F 3/017
2017/0100035 A1 4/2017 Heikenfeld
2017/0102334 A1 4/2017 Zaretski et al.
2017/0112434 A1 4/2017 Lane
2017/0112453 A1 4/2017 Quinn et al.
2017/0164876 A1 6/2017 Hyde et al.
2017/0169185 A1 6/2017 Weng
2017/0273560 A1 9/2017 Ballam et al.
2017/0293749 A1 * 10/2017 Baek G06F 1/3265
2017/0364732 A1 12/2017 Komogortsev

OTHER PUBLICATIONS

- <http://www.patentlyapple.com/patently-apple/2014/01/motorola-skin-tattoo-patent-contains-bizarre-big-brother-twist.html> (2014).
https://www.technologyreview.com/s/602000/how-to-operate-your-smart-watch-with-the-same-hand-that-wears-it/?utm_campaign=newsletters&utm_source=newsletter-weekly-mobile&utm_medium=email&utm_content=20160801&goal=0_997ed6f472-a395fccd6e-153689181&mc_cid=a395fccd6e&mc_eid=33ecfcf2ad (2016).
Recent advances in gecko adhesion and friction mechanisms and development of gecko-inspired dry adhesive surfaces, Zhou et al., *Friction* 1(2): 114-129 (2013).
Magnetically Actuated Patterns for Bioinspired Reversible Adhesion (Dry and Wet), Drotlef et al., *Adv. Mater.* (2013).
Reverse Adhesion of a Gecko-Inspired Synthetic Adhesive Switched by an Ion-Exchange Polymer-Metal Composite Actuator, Guo et al., *ACS Appl. Mater. Interfaces*, 7, 5480-5487 (2015).
Switching adhesion and friction by light using photosensitive guest-host interactions, Blass et al., *Chem. Commun.*, 51, 1830 (2015).
Miniaturized Flexible Electronic Systems with Wireless Power and Near-Field Communication Capabilities, Kim et al., *Adv. Fund. Mater.* 25, 4761-4767 (2015).
Epidermal Differential Impedance Sensor for Conformal Skin Hydration Monitoring, Huang et al., *Biointerphases* 7:52 (2012).
Epidermal Electronics, Kim et al., *Science* 333, 838 (2011).
<http://www.mhealthtalk.com/smart-skin/> (2011).
Multifunctional Epidermal Electronics Printed Directly Onto the Skin, Yeo et al., *Adv. Mater.* (2013).
<http://www.mc10inc.com/our-story/#content-17> (Accessed Nov. 16, 2016).
<https://www.technologyreview.com/s/428944/making-stretchable-electronics/> (2012).
Breaking free, WTIN (publisher), *Future Materials* (2012).
<http://forwardthinking.pcmag.com/show-reports/312046-d11-is-phone-authentication-possible-by-taking-a-pill-motorola-says-yes> (2013).
PCT International Search Report; International App. No. PCT/US2017/046106; Nov. 17, 2017; pp. 1-4.
PCT International Search Report; International App. No. PCT/US2017/046114; Nov. 22, 2017; pp. 1-6.

* cited by examiner

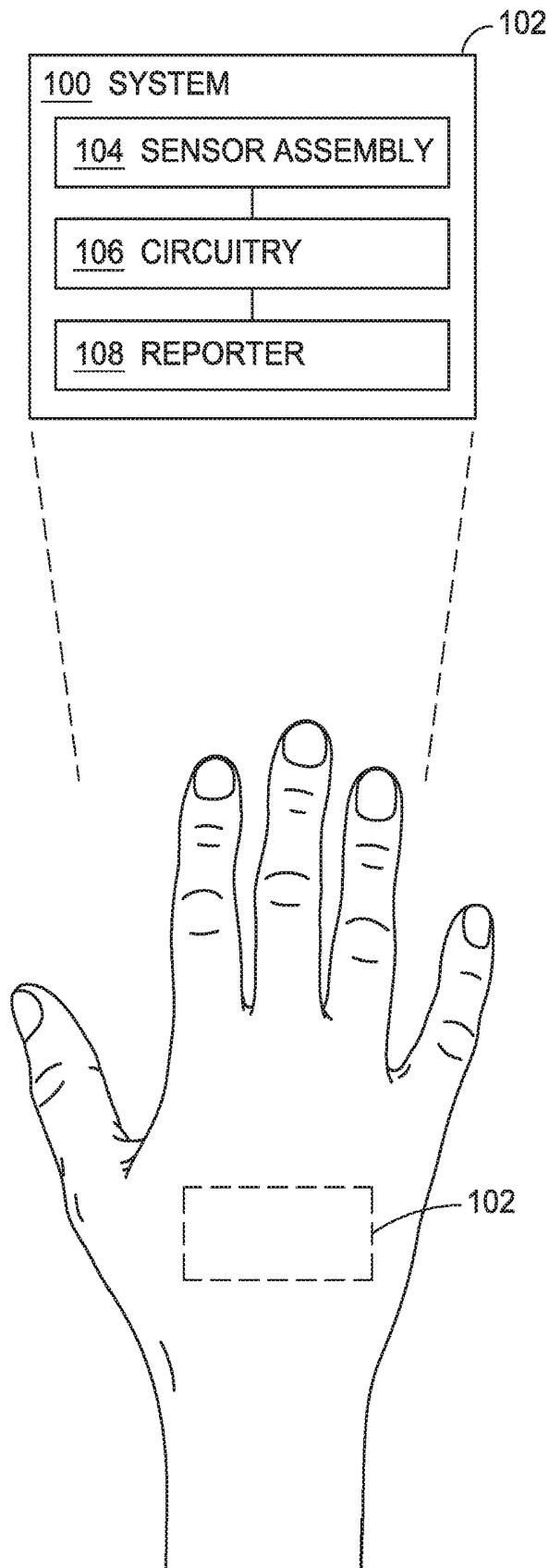

FIG. 1

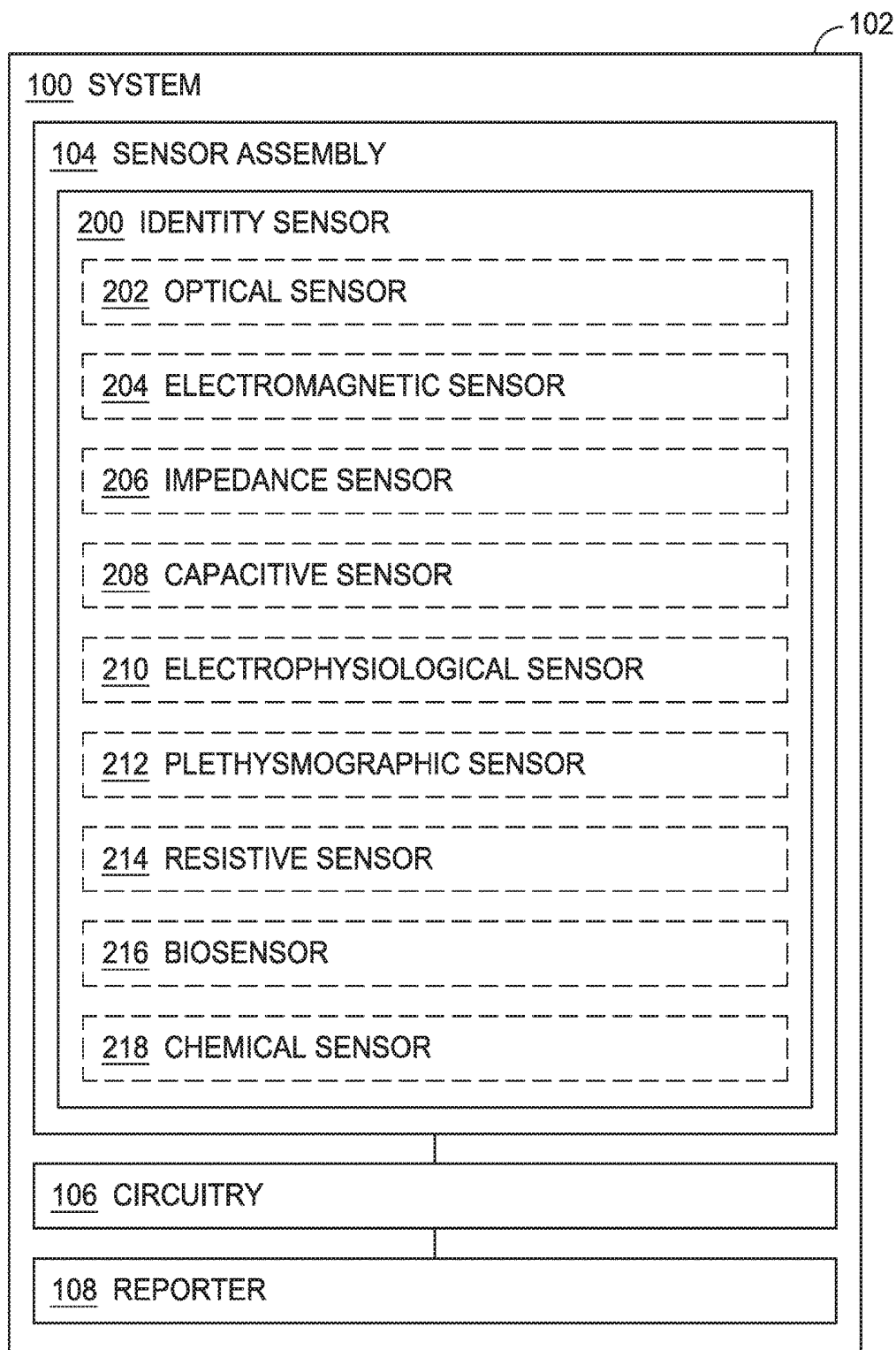

FIG. 2

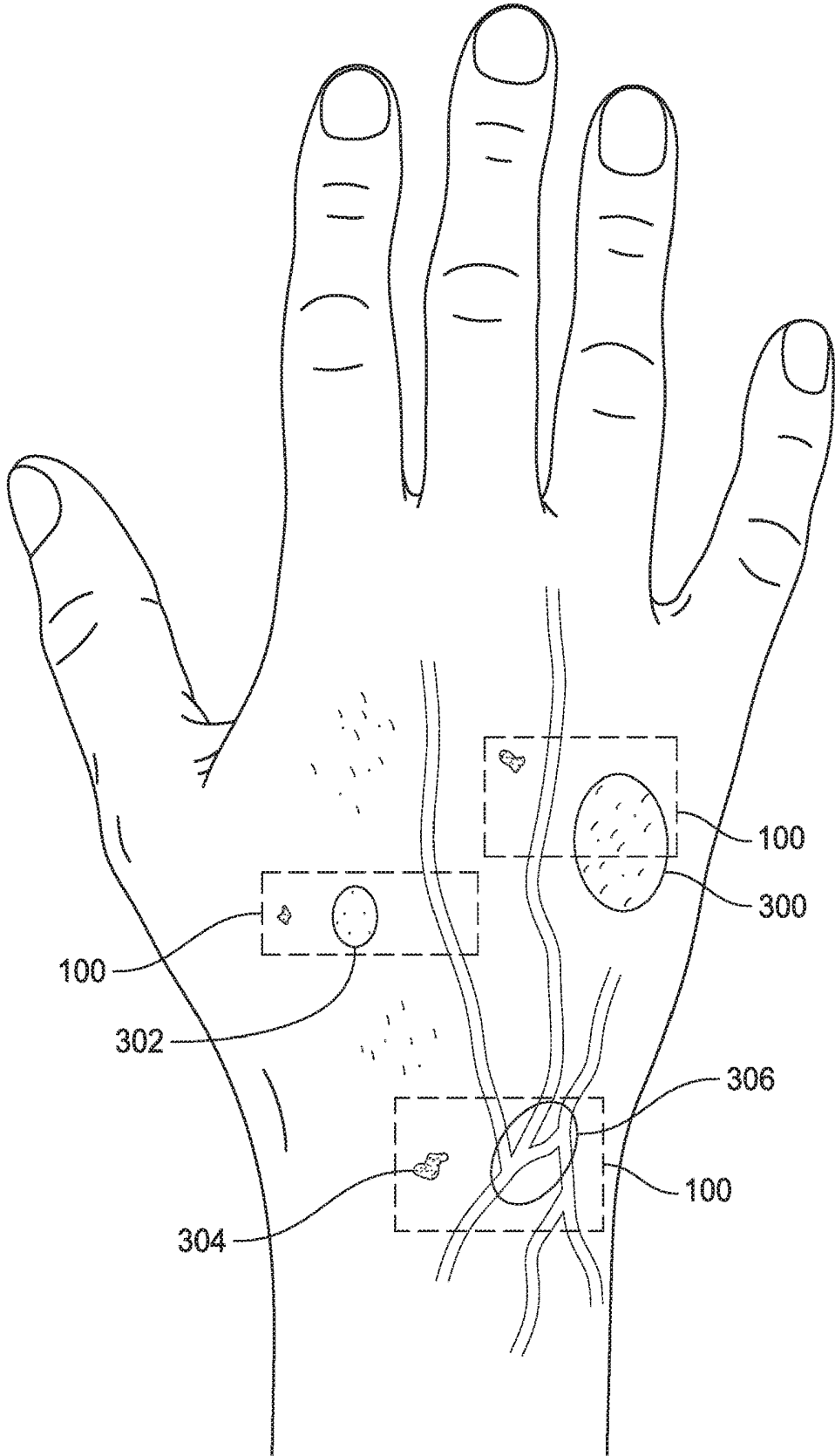

FIG. 3

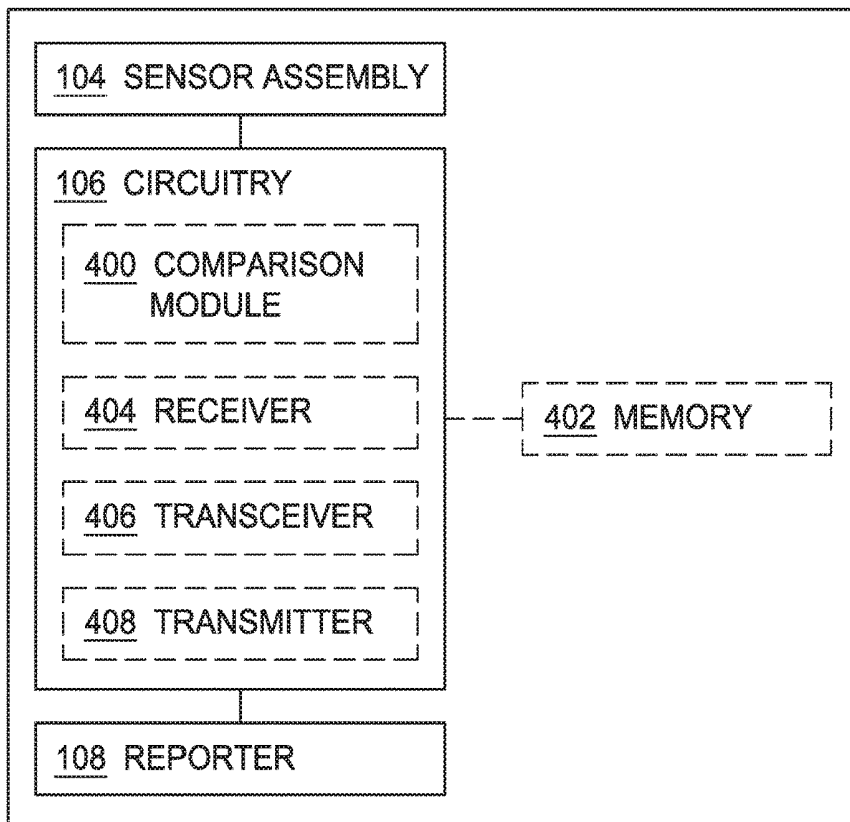

FIG. 4

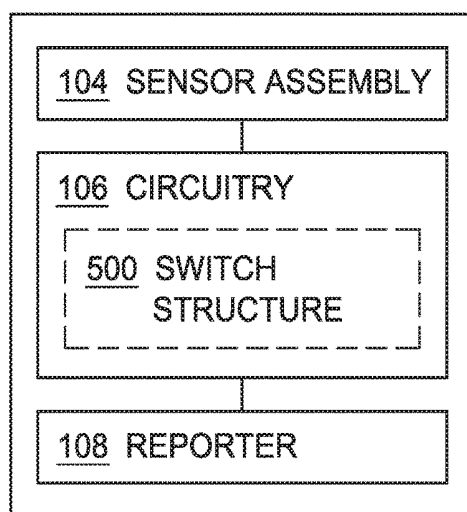

FIG. 5

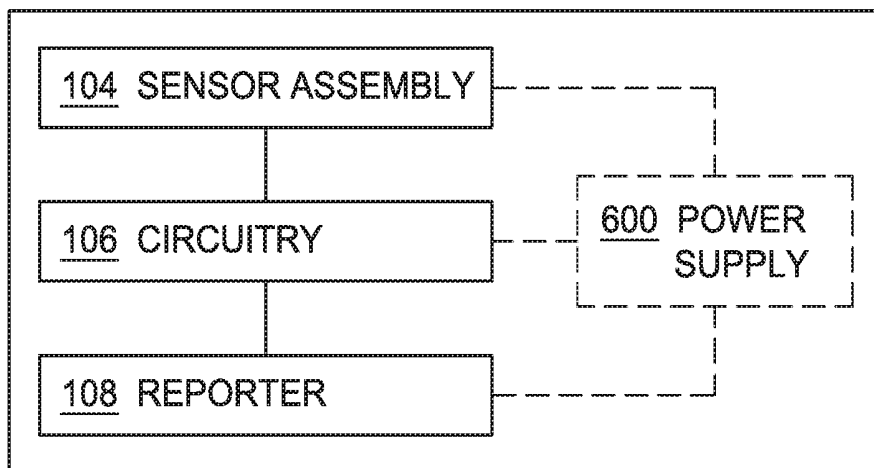

FIG. 6

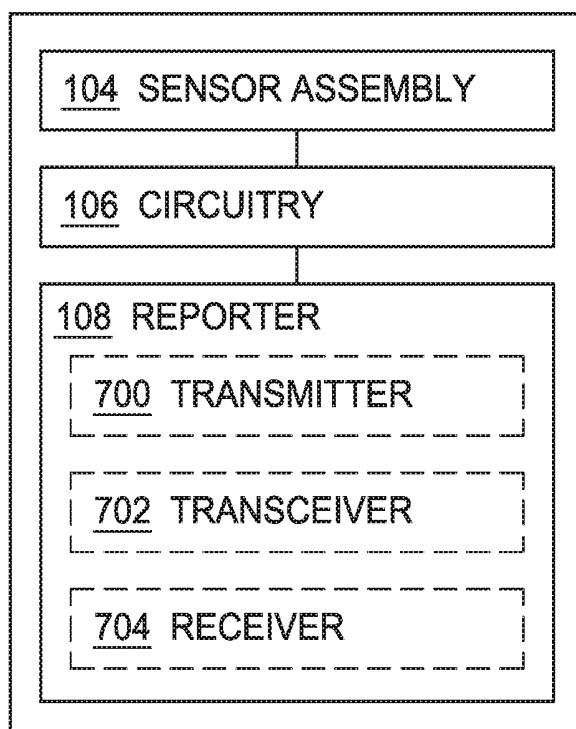

FIG. 7

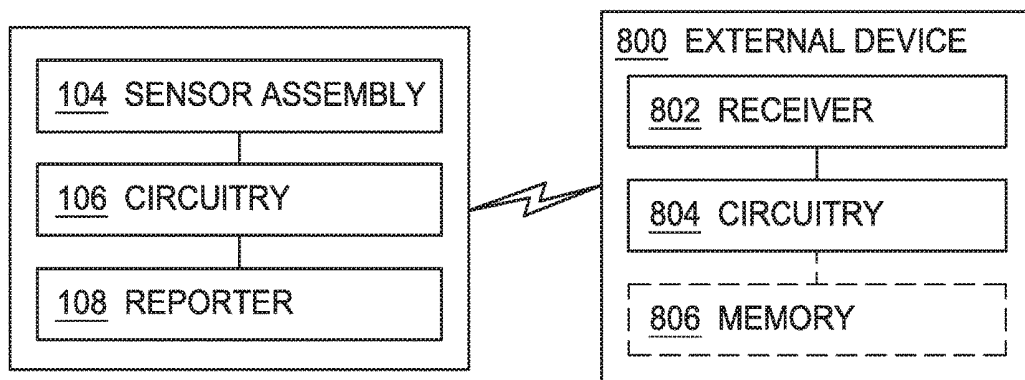

FIG. 8

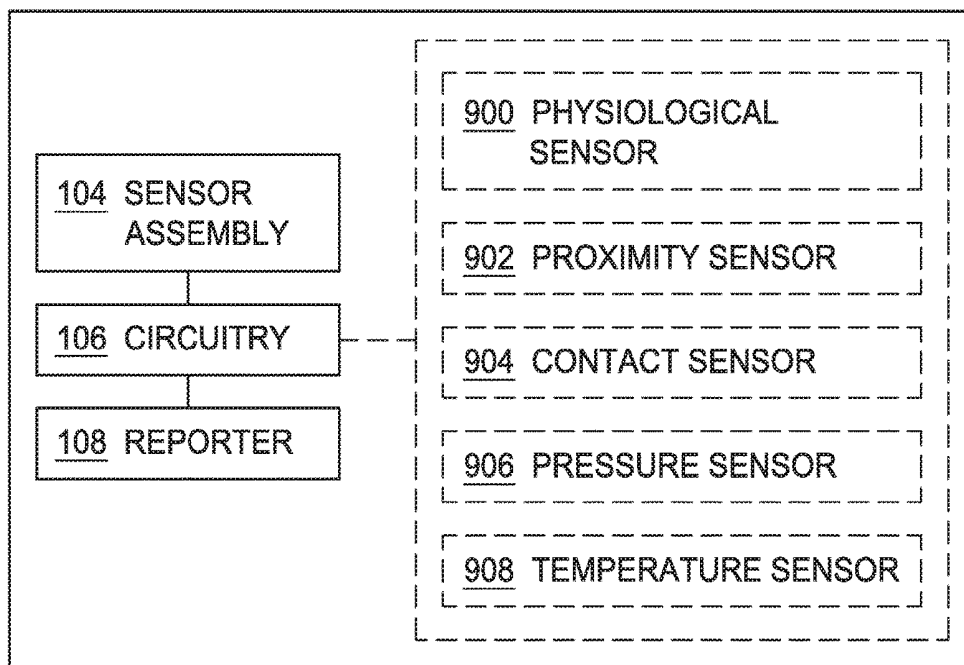

FIG. 9

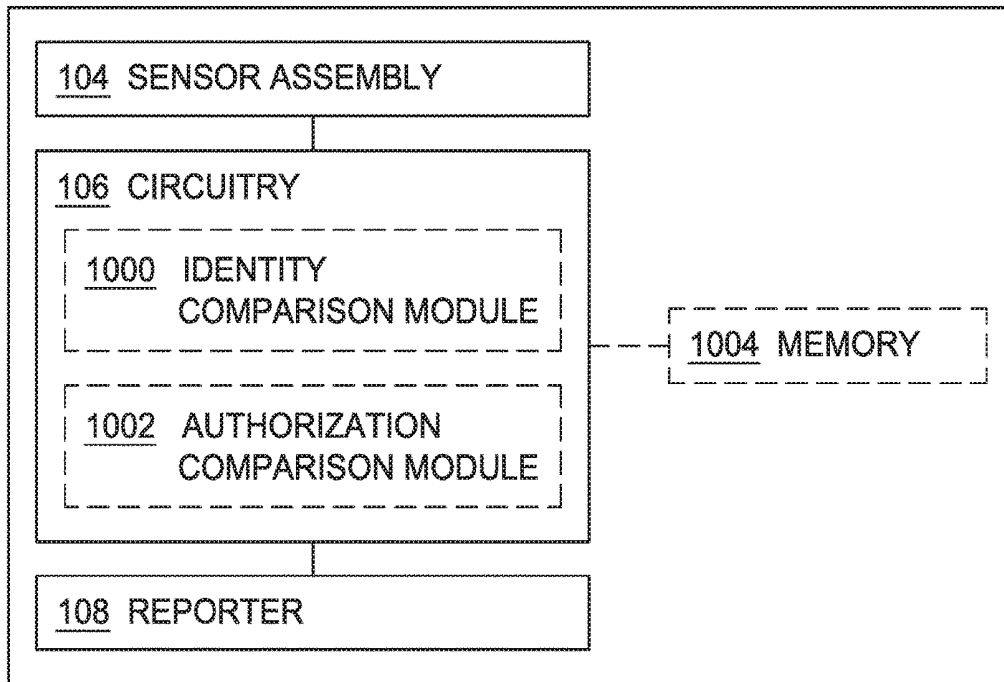

FIG. 10

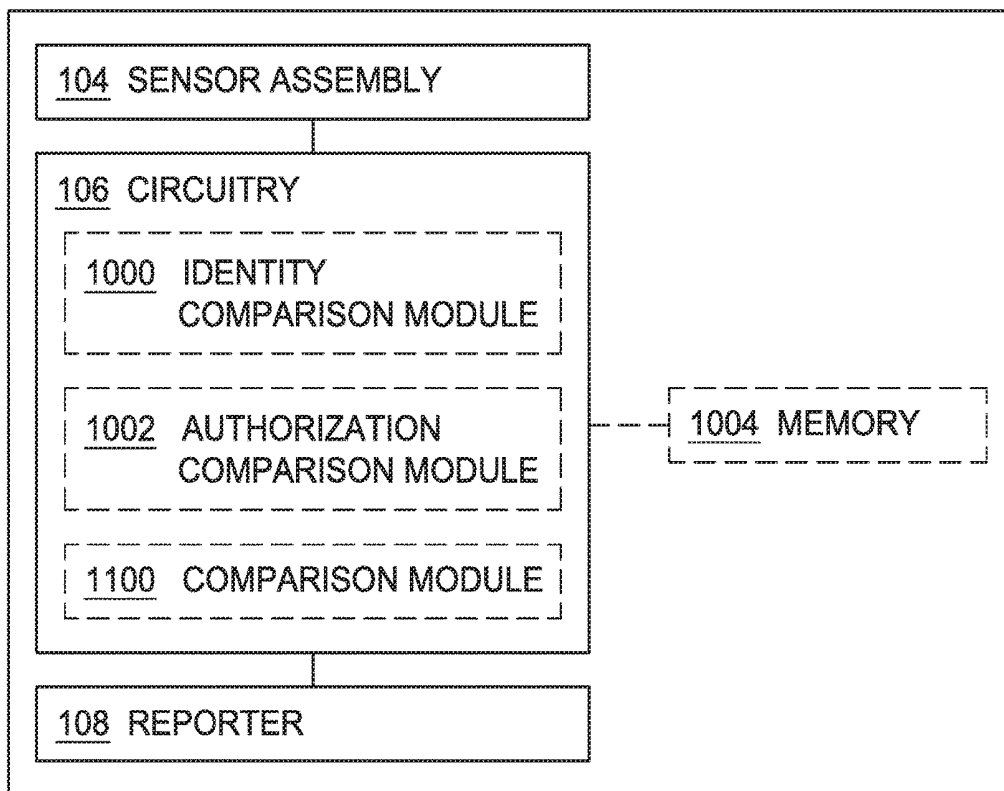

FIG. 11

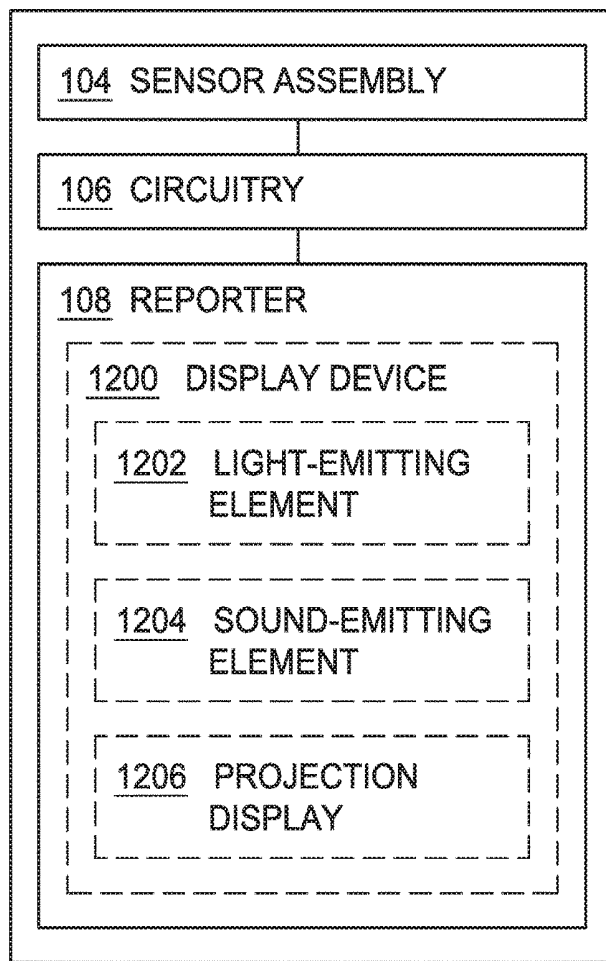

FIG. 12

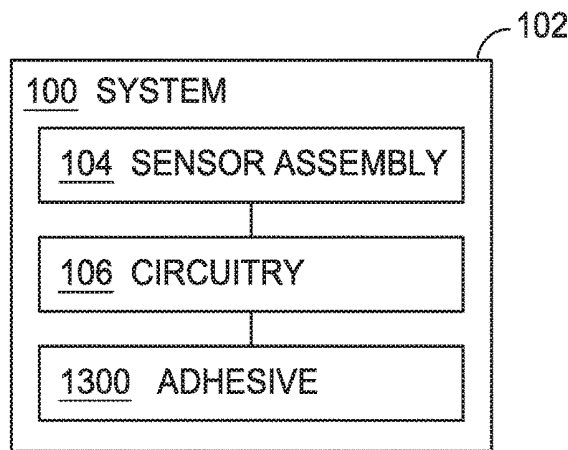

FIG. 13

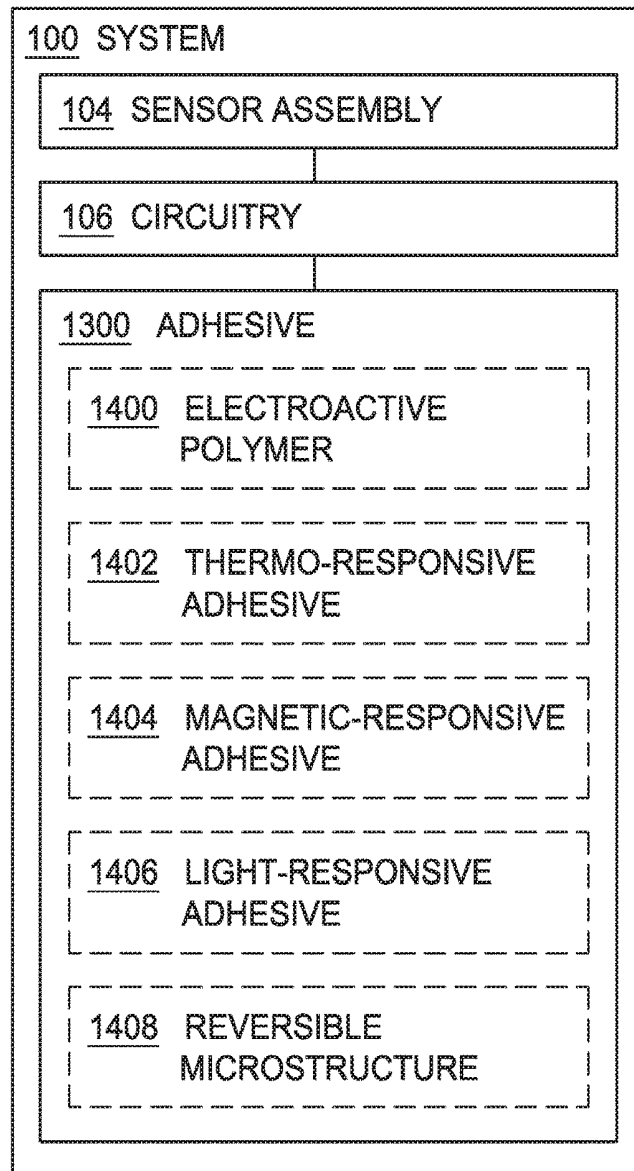

FIG. 14

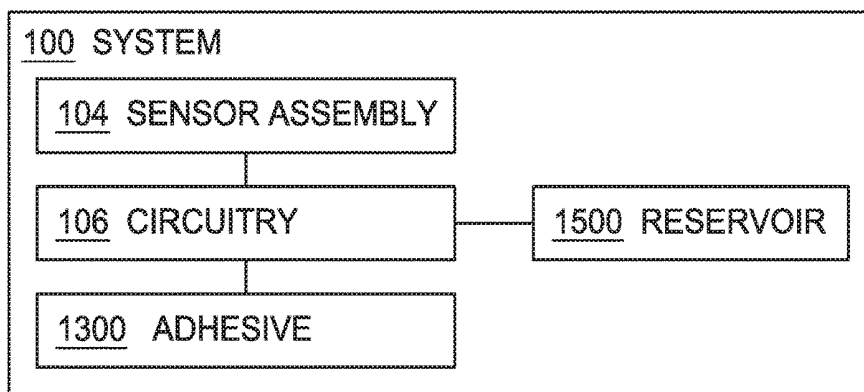

FIG. 15

1600

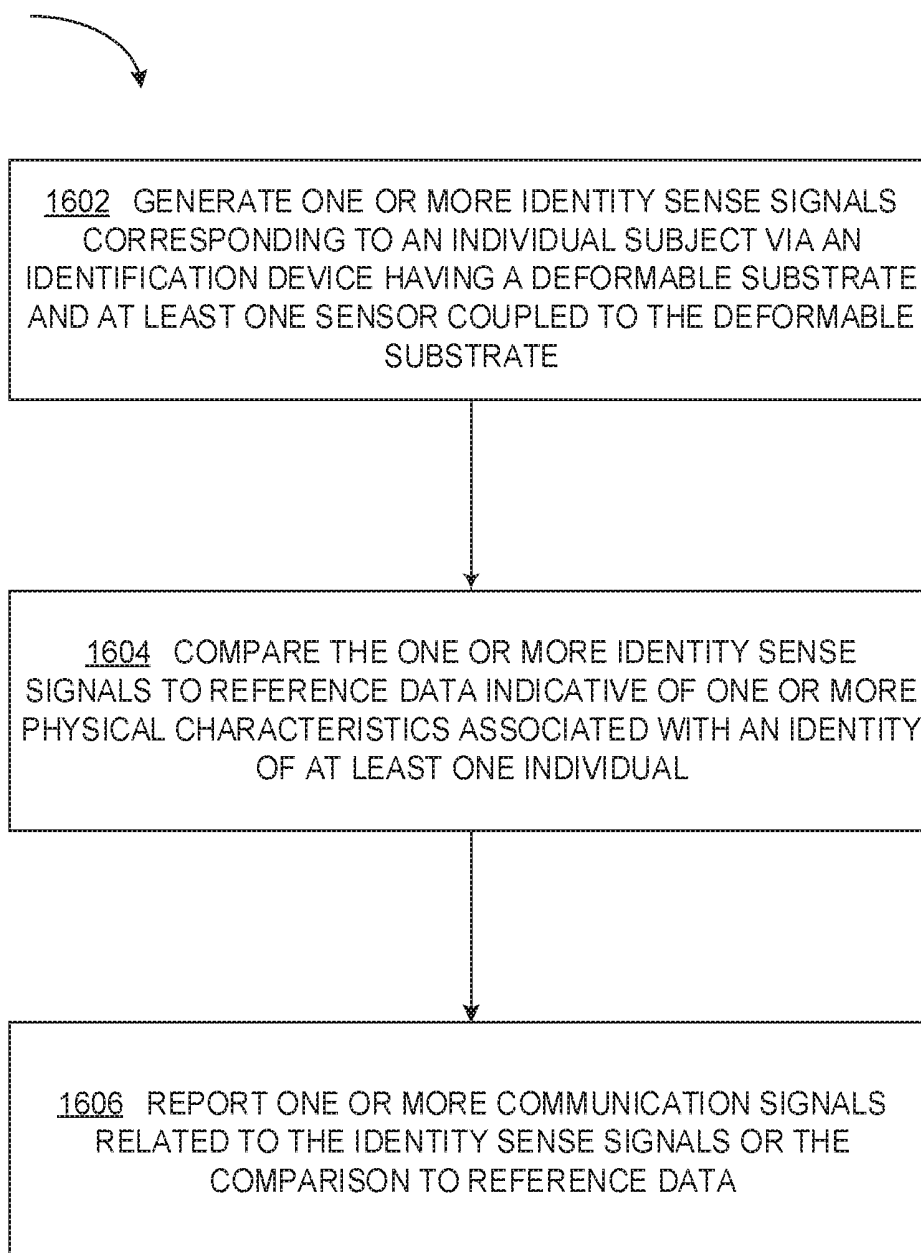
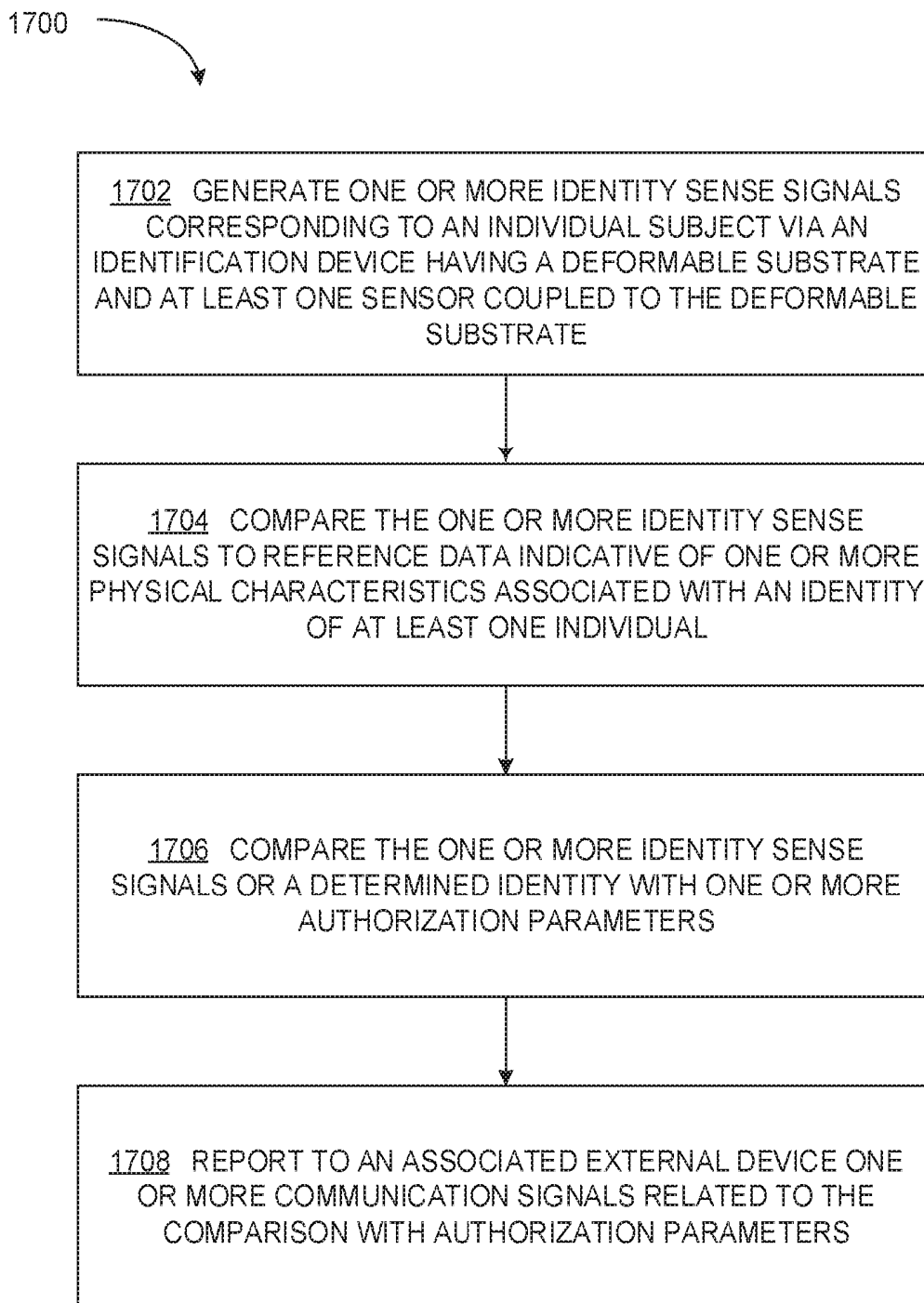

FIG. 16

**FIG. 17**

1800

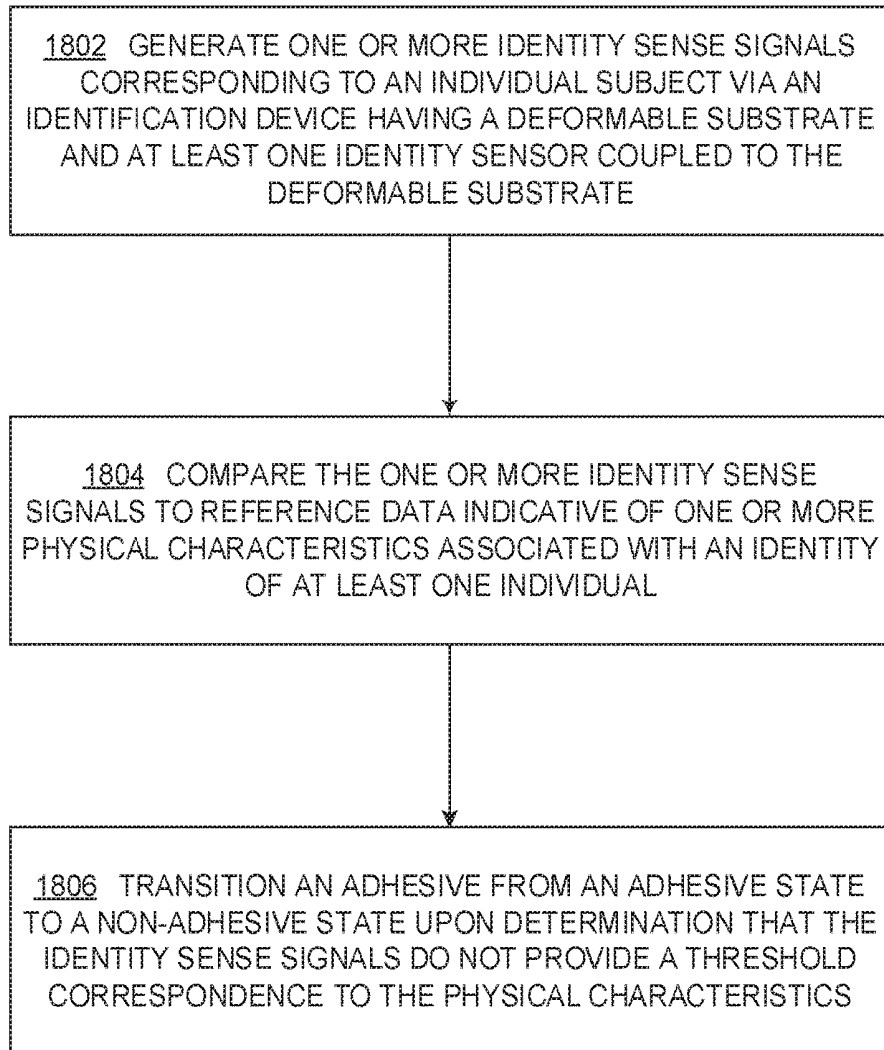

FIG. 18

1900

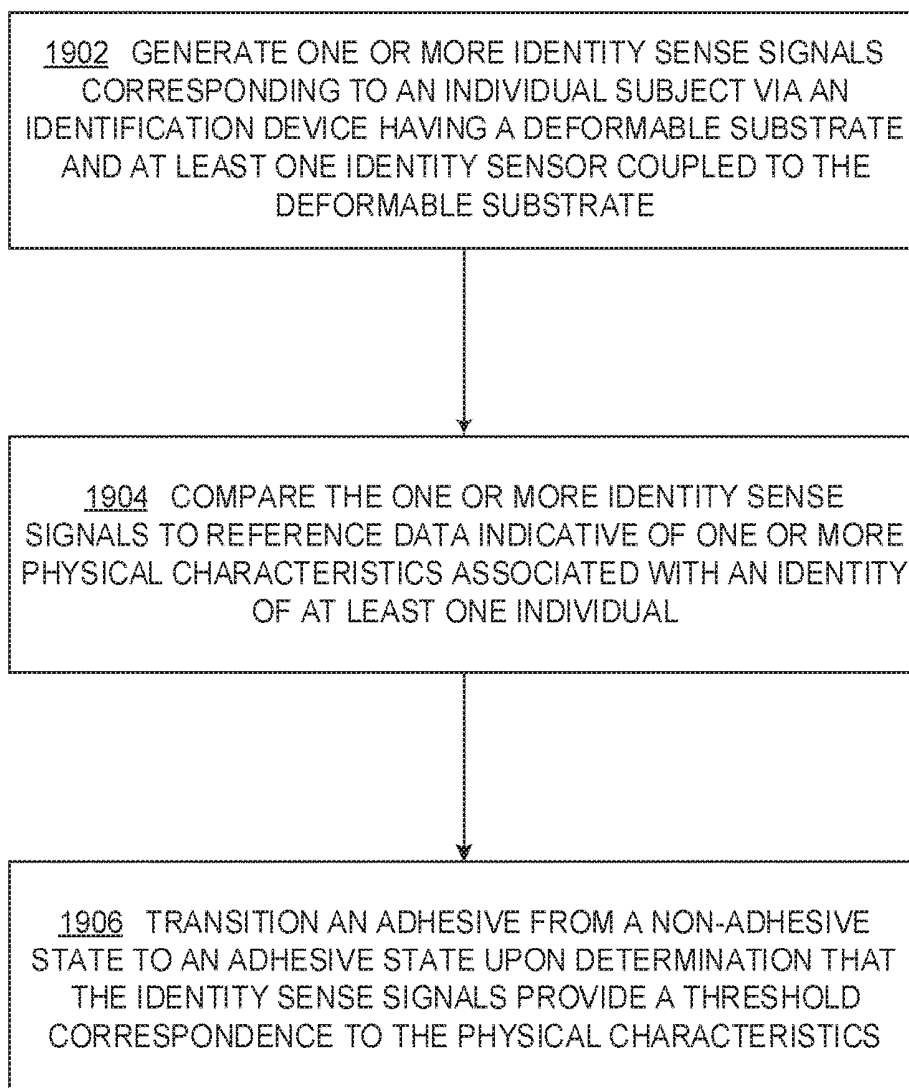

FIG. 19

**SYSTEMS AND METHODS FOR
INDIVIDUAL IDENTIFICATION AND
AUTHORIZATION UTILIZING
CONFORMABLE ELECTRONICS**

If an Application Data Sheet (ADS) has been filed on the filing date of this application, it is incorporated by reference herein. Any applications claimed on the ADS for priority under 35 U.S.C. §§ 119, 120, 121, or 365(c), and any and all parent, grandparent, great-grandparent, etc. applications of such applications, are also incorporated by reference, including any priority claims made in those applications and any material incorporated by reference, to the extent such subject matter is not inconsistent herewith.

CROSS-REFERENCE TO RELATED
APPLICATIONS

The present application claims the benefit of the earliest available effective filing date(s) from the following listed application(s) (the "Priority Applications"), if any, listed below (e.g., claims earliest available priority dates for other than provisional patent applications or claims benefits under 35 USC § 119(e) for provisional patent applications, for any and all parent, grandparent, great-grandparent, etc. applications of the Priority Application(s)).

PRIORITY APPLICATIONS

None.

If the listings of applications provided above are inconsistent with the listings provided via an ADS, it is the intent of the Applicant to claim priority to each application that appears in the Domestic Benefit/National Stage Information section of the ADS and to each application that appears in the Priority Applications section of this application.

All subject matter of the Priority Applications and of any and all applications related to the Priority Applications by priority claims (directly or indirectly), including any priority claims made and subject matter incorporated by reference therein as of the filing date of the instant application, is incorporated herein by reference to the extent such subject matter is not inconsistent herewith.

SUMMARY

In an aspect, a device includes, but is not limited to, a deformable substrate configured to conform to a skin surface of a body portion of an individual subject; a sensor assembly coupled to the deformable substrate, the sensor assembly including one or more identity sensors configured to generate one or more identity sense signals associated with at least one physical characteristic of the individual subject; circuitry operably coupled to the sensor assembly and configured to receive the one or more identity sense signals associated with the at least one physical characteristic of the individual subject, the circuitry including an identity comparison module configured to compare the one or more identity sense signals generated by the sensor assembly to reference data indicative of one or more physical characteristics associated with an identity of at least one individual to determine whether the one or more identity sense signals correspond to the identity of the at least one individual, the circuitry including an authorization comparison module configured to compare at least one of the one or more identity sense signals or the identity of the at least one individual with one or more authorization parameters; and a

reporter operably coupled to the circuitry and configured to generate one or more communication signals responsive to instruction by the circuitry, the one or more communication signals associated with a comparison of at least one of the one or more identity sense signals with the one or more authorization parameters or the identity of the at least one individual with the one or more authorization parameters.

In an aspect, a method includes, but is not limited to, generating one or more identity sense signals corresponding to an individual subject via an identification device having a deformable substrate configured to conform to a skin surface of a body portion of the individual subject and having at least one sensor coupled to the deformable substrate, the one or more identity sense signals associated with at least one physical characteristic of the individual subject; comparing via circuitry the one or more identity sense signals generated by the sensor assembly to reference data indicative of one or more physical characteristics associated with an identity of at least one individual to determine whether the one or more identity sense signals correspond to the identity of the at least one individual; comparing via circuitry at least one of the one or more identity sense signals or the identity of the at least one individual with one or more authorization parameters; and reporting to an associated external device via a reporter one or more communication signals associated with a comparison of at least one of the one or more identity sense signals or the identity of the at least one individual with the one or more authorization parameters.

The foregoing summary is illustrative only and is not intended to be in any way limiting. In addition to the illustrative aspects, embodiments, and features described above, further aspects, embodiments, and features will become apparent by reference to the drawings and the following detailed description.

BRIEF DESCRIPTION OF THE FIGURES

FIG. 1 is a schematic of a system for identification of an individual using conformable electronics.

FIG. 2 is a schematic of an embodiment of a system such as shown in FIG. 1.

FIG. 3 is a schematic of an embodiment of a system such as shown in FIG. 1.

FIG. 4 is a schematic of an embodiment of a system such as shown in FIG. 1.

FIG. 5 is a schematic of an embodiment of a system such as shown in FIG. 1.

FIG. 6 is a schematic of an embodiment of a system such as shown in FIG. 1.

FIG. 7 is a schematic of an embodiment of a system such as shown in FIG. 1.

FIG. 8 is a schematic of an embodiment of a system such as shown in FIG. 1.

FIG. 9 is a schematic of an embodiment of a system such as shown in FIG. 1.

FIG. 10 is a schematic of a system for identification of an individual and authorization of an identified individual using conformable electronics.

FIG. 11 is a schematic of an embodiment of a system such as shown in FIG. 10.

FIG. 12 is a schematic of an embodiment of a system such as shown in FIGS. 1 and 10.

FIG. 13 is a schematic of an embodiment of a system such as shown in FIGS. 1 and 10.

FIG. 14 is a schematic of an embodiment of a system such as shown in FIGS. 1 and 10.

FIG. 15 is a schematic of an embodiment of a system such as shown in FIGS. 1 and 10.

FIG. 16 is a flowchart of a method of identifying an individual using conformable electronics positioned on the individual.

FIG. 17 is a flowchart of a method of identifying and authorizing an individual using conformable electronics positioned on the individual.

FIG. 18 is a flowchart of a method of adjusting an adhesive state of an adhesive responsive to identification of an individual using conformable electronics.

FIG. 19 is a flowchart of a method of adjusting an adhesive state of an adhesive responsive to identification of an individual using conformable electronics.

DETAILED DESCRIPTION

In the following detailed description, reference is made to the accompanying drawings, which form a part hereof. In the drawings, similar symbols typically identify similar components, unless context dictates otherwise. The illustrative embodiments described in the detailed description, drawings, and claims are not meant to be limiting. Other embodiments may be utilized, and other changes may be made, without departing from the spirit or scope of the subject matter presented here.

Systems, devices, and methods are described for identification and authorization of individuals using conformable electronics for aspects of the identification and authorization processes. Such systems can be applied to, maintained against, or otherwise be in contact with, a skin surface of a body portion of an individual to evaluate one or more physical characteristics of the individual, including but not limited to, skin topography features (e.g., pattern of skin surface, follicle pattern, pore pattern, pigmentation, etc.), vascular properties or layouts, electric current pattern (e.g., photovoltaic current pattern), or skin resistivity measurement. The physical characteristics can be compared against reference data that include physical characteristics of known identities to determine whether the measured physical characteristics correspond to the reference physical characteristics, whereby the particular identity can be determined or inferred. In an embodiment, the identification can disable or enable operation or functionality of one or more components of the system. For example, where an individual does not match an identity that corresponds to any reference identity, is identified but is not in a state suitable for operation of a device (e.g., intoxicated, stressed, etc.), or is identified but not authorized to use a particular device or system, the system can disable a power connection to one or more components of the system, thereby preventing their use. Where an individual is identified, the system can enable a power connection to one or more components of the system (e.g., sensors, reporters, etc.), thereby enabling or activating their use. In an embodiment, the identification can lead to subsequent authorization, such as authorization reported to or processed by an external device. Such authorization can permit operation of the external device or associated device or system by the identified and authorized individual, or can permit an external device or associated device or system to be aware of the identity of a particular user.

In an embodiment, the systems described herein can be configured to adhere to a skin surface of a body portion of the individual, which can facilitate ease of use and avoid unintentional misplacement of the identification and/or authorization system. In an embodiment, such systems can be configured to disable the functionality of one or more

components when removed from the skin surface, or otherwise become difficult to remove intact, such as to avoid transfer of the system to another user. In an embodiment, the systems described herein can be removable and reusable.

In an embodiment, the systems described herein can sense a combination of skin properties to confirm that the host body portion is associated with an individual that is present and in good health, which can avoid security issues associated with identification and/or authorization systems that utilize biometric or other identification/authorization protocols that can be circumvented by removal of a body portion or embedded tag used for identification/authorization.

In an embodiment, the systems described herein employ one or more identity sensors configured to monitor or sense at least one physical characteristic of the individual. The identity sensor can include, but is not limited to, an optical sensor, an electromagnetic sensor, an impedance sensor, a capacitive sensor, an electrophysiological sensor, a plethysmographic sensor, a resistive sensor, a biosensor, or a chemical sensor. The identity sensors are coupled to circuitry configured to compare the output of the identity sensors to reference data to determine whether the output of the identity sensors corresponds to an identity of a known individual. The systems can also include one or more of physiological sensors, proximity sensors, contact sensors, pressure sensors, or temperature sensors to facilitate operation of the system, to provide contextual data in combination with the output from the identity sensors, to toggle activation/deactivation of one or more components of the system, or the like.

In an embodiment, the systems described herein employ a reporter configured to generate one or more communication signals responsive to instruction by the circuitry. For example, the reporter can convey information via the one or more communication signals directed to the output of the sensors, a comparison of the output of the sensors with reference data (e.g., reference identity data or reference physical characteristics), identity information of the individual on which the system is positioned, authorization information (e.g., whether or not an identified individual is authorized, such as authorized to operate a particular device, machine, electronic device, etc.), or the like.

In an embodiment, shown in FIG. 1, a system (or device) 100 is configured to evaluate one or more physical characteristics of an individual on which the system 100 is positioned to facilitate identification of the individual. The system 100 includes a deformable substrate 102, a sensor assembly 104, circuitry 106, and a reporter 108. The deformable substrate 102 is configured to conform to a contour of a body portion of an individual subject (e.g., the curvature of a limb). For example, the deformable substrate 102 can comprise a deformable (e.g., conformable, flexible, stretchable, etc.) material configured to interface with, and conform to, the body portion. The body portion is shown in FIG. 1 as a hand, however the system 100 can be positioned on the skin surface of any body portion, including but not limited to, an arm, an elbow, a wrist, a hand, a finger, a leg, a knee, an ankle, a foot, a toe, a facial region, a neck region, a torso region, or the like. The pliable nature of the deformable substrate 102 (e.g., flexibility and stretchability) facilitates interaction/interfacing with the body portion, which includes a generally low-modulus and deformable natural skin surface. In an embodiment, the deformable substrate 102 can include one or more of a stretchable/flexible fabric, paper, or polymer (e.g., a natural or synthetic elastomeric polymer, polyimide, polyvinyl, an organic polymer such as PDMS, xylylene, parylene, an inorganic polymer, a biopolymer, a

composite material, or any combination thereof), a film (e.g., a hydrocolloid film), a membrane (e.g., a nanomembrane, such as a silicon nanomembrane), a gas-permeable elastomeric sheet, or other deformable (e.g., stretchable, flexible, pliable) material. The deformable substrate **102** can be positioned in proximity with the skin surface according to various mechanisms including, but not limited to, affixed to the skin via an adhesive material, held in place by an external pressure, such as pressure provided by a material wrapped around or about a body portion (e.g., a fabric, a garment, a glove, a bandage, etc.), affixed in a textile, fabric, garment, accessory (e.g., a glove, a sock, a finger cot, etc.), or so forth.

In embodiments, the system **100** includes at least one flexible or stretchable electronic component. For example, at least one of the sensor assembly **104** (e.g., identity sensors as described herein), the circuitry **106**, or the reporter **108** can include or be formed of flexible or stretchable electronics coupled to the deformable substrate **102**. For example, interconnects (not illustrated) between these components or within the circuitry can include or be formed of flexible or stretchable electronics (e.g., serpentine conducting tracings allowing for stretchable interconnects) and coupled to the deformable substrate **102**. For example, a power source (e.g., power supply **600** described herein), can include or be formed of flexible or stretchable electronics and be coupled to the deformable substrate **102**. In embodiments, the at least one flexible or stretchable electronic component includes at least one of a wavy, bent, mesh (e.g., open mesh), buckled, or serpentine geometry. In embodiments, the at least one flexible or stretchable electronic component includes at least one nanowire, at least one nanoribbon, or at least one nanomembrane. For example, the system **100** can include one or more multifunctional electronic units comprising a stretchable/flexible system including a sensor assembly (e.g., sensor assembly **104**), reporter (e.g., reporter **108**), and power source (e.g., power supply **600**) in communication via associated circuitry (e.g., circuitry **106**), including interconnects, residing in or on a deformable substrate (e.g., deformable substrate **102**).

In embodiments, the system **100** can include at least one ultrathin electronic component. For example, an ultrathin (e.g., less than 20 micrometers) electronic component can include a thinned wafer (e.g., thinned silicon wafer bonded to a polymer substrate), an ultrathin chip, or the like. For example, ultrathin circuitry can include conductive layers formed on a deformable substrate (e.g., deformable substrate **102**) such as parylene by evaporation deposition with UV lithography and etching. For example, at least one of the sensory assembly **104**, the circuitry **106**, or the reporter **108** can include ultrathin electronics.

In embodiments, the system **100** can include at least one electrically conductive thread, yarn, or textile. For example, the sensory assembly **104**, the circuitry **106**, or the reporter **108** can include at least one electrically conductive thread or yarn. Electrically conductive threads, yarns, or textiles can be configured to provide sufficient current to induce at least one of a wired or wireless coupling, e.g., between electronic components. For example, electronically conductive threads, yarns, or textiles may form circuitry **106** configured to function in communication between one or more sensor assemblies **106**, one or more reporters **108**, or other circuitry **106**. For example, electronically conductive threads, yarns, or textiles may form at least a portion of circuitry **106** configured to function in communication between a plurality of multifunctional electronic units each comprising one or more sensor assemblies **106**, one or more reporters **108**, and

circuitry **106**. Electrically conductive fibers, threads, and yarns can include a metallic material, semi-metallic material, semi-insulative material, semi-conductive material (e.g., silicon and a gallium arsenide), or transparent conductive material (e.g., an indium-tin-oxide (ITO) material). Electrical threads or yarns can be embedded in textiles using weaving, knitting or embroidery, for example, or can be attached using nonwoven production techniques such as adhesion. For example, electrically conductive yarns having curved configuration can be attached to an elastic textile (e.g., by sewing or by adhesion) and can form all or part of a sensor assembly **104** that measures one or more physical characteristics of an individual, e.g., as the curved configuration is altered, such as due to particular skin topography or the like.

The sensor assembly **104** is coupled to the deformable substrate **102** and is positioned to generate one or more sense signals associated with a physical characteristic of the individual subject on whom the system **100** is positioned. For example, as shown in FIG. 2, the sensor assembly **104** includes one or more identity sensors **200** configured to generate one or more identity sense signals associated with at least one physical characteristic of the individual subject. The identity sensor **200** can sense the physical characteristic to provide a basis for identification of the individual subject, or to provide an indication that the individual subject cannot be readily identified based on the observed physical characteristics. The identity sensor **200** can include, but is not limited to, one or more of an optical sensor **202**, an electromagnetic sensor **204**, an impedance sensor **206**, a capacitive sensor **208**, an electrophysiological sensor **210**, a plethysmographic sensor **212**, a resistive sensor **214**, a biosensor **216**, or a chemical sensor **218**. The identity sensor **200** can generate the one or more identity sense signals based on measurement or sensing of one more physical characteristics of the individual subject, where the one or physical characteristics can include but are not limited to, skin topography features (e.g., pattern of skin surface, follicle pattern, pore pattern, pigmentation, etc.), vascular properties or layouts (e.g., arterial patterns, properties, or layouts; vein patterns, properties, or layouts; etc.), electric current pattern (e.g., photovoltaic current pattern), or skin resistivity measurement. For example, as shown in FIG. 3, the system **100** can be positioned on a skin surface of a body portion (shown as a top surface of a hand in FIG. 3), where the system **100** can detect via the identity sensor **200** one or more of a follicle pattern **300**, a pore pattern **302**, a skin pigmentation or distinctive skin mark **304**, or a vascular pattern or layout **306**. The identity sensor **200** can then generate one or more identity sense signals based on the structure of the particular sensor(s) of the sensor assembly **104** (e.g., optical sensor **202**, electromagnetic sensor **204**, impedance sensor **206**, etc.), where such signals will correspond to the measured or sensed physical characteristics to facilitate in analysis of whether the identity of the individual subject can be determined. In an embodiment, the optical sensor **202** includes one or more optoelectronics generate the one or more identity sense signals based on measurement or sensing of one more physical characteristics of the individual subject. For example, the optoelectronics can include, but are not limited to, one or more polymer light-emitting diodes (PLEDs), one or more organic photodetectors (OPDs), or combinations thereof. In an embodiment, the optoelectronics include a plurality of polymer light-emitting diodes (PLEDs) configured to emit light of differing wavelengths (e.g., green, red, blue, etc.), which in combination with one or more organic photodetectors (e.g., having an

active layer of poly(3-hexylthiophene) (P3HT):(6,6)-phenyl-C61-butyrac acid methyl ester (PCBM)) are arranged as an ultraflexible reflective pulse oximeter.

Chemical sensors and biosensors (e.g., chemical sensor **218** and biosensor **216**) can include aspects of physiological sensors, such that each of chemical sensors and biosensors can detect certain physiological conditions or parameters. For example, without limitation, a chemical sensor can detect a chemical signature of an analyte, for example an analyte of a physiological origin (e.g., a cellular compound, a secreted compound such as an antibody or a cytokine, or a metabolite) or an analyte of an exogenous origin (e.g., an ingested, inhaled, or topical substance, such as a drug, or a tagging or labeling compound). Examples of chemical sensors include, but are not limited to, sensors having recognition elements, electronic chip sensors, microbalance sensors, and near infrared spectrometers. A biosensor can detect a biochemical or biological element. Biosensors include, for example but are not limited to, sensors having a biological recognition element able to bind an analyte of interest (e.g., an aptamer-based microcantilever) and sensors utilizing an enzyme with recognition and reaction properties. In an embodiment, chemical sensors or biosensors can include molecular sensor or nanosensor aspects.

The sensor assembly **104** can be structured relative to the deformable substrate **102** such that at least a portion of the sensor assembly **104** is embedded within the deformable substrate **102**, affixed to the deformable substrate **102**, residing on the deformable substrate **102**, printed directly onto the deformable substrate **102**, or a combination thereof. For example, at least a portion of an identity sensor **200** can be embedded within the deformable substrate **102**, can be affixed to the deformable substrate **102**, can reside on the deformable substrate **102**, can be directly printed on the deformable substrate **102**, or a combination thereof. In an embodiment, the deformable substrate **102** can include one or more of a stretchable/flexible fabric, an elastomeric polymer, a hydrocolloid film, a membrane (e.g., a nanomembrane, such as a silicon nanomembrane), a gas-permeable elastomeric sheet, or other conformable material. In an embodiment, at least one of the sensor assembly **104**, the circuitry **106**, or the reporter **108** resides on the deformable substrate **102**, such as residing on at least a portion of one or more of a stretchable/flexible fabric, an elastomeric polymer, a hydrocolloid film, a membrane (e.g., a nanomembrane, such as a silicon nanomembrane), a gas-permeable elastomeric sheet, or other conformable material. For example, at least a portion of at least one of the sensor assembly **104**, the circuitry **106**, or the reporter **108** can be printed directly onto at least a portion of the deformable substrate **102**. In an embodiment, at least one of the sensor assembly **104**, the circuitry **106**, or the reporter **108** is embedded within the deformable substrate **102**, such as embedded within at least a portion of one or more of a stretchable/flexible fabric, an elastomeric polymer, a hydrocolloid film, a membrane (e.g., a nanomembrane, such as a silicon nanomembrane), a gas-permeable elastomeric sheet, or other conformable material.

The circuitry **106** is configured to receive one or more identity sense signals (e.g., from the sensor assembly **104**) associated with one or more physical characteristics of the individual subject on which the system **100** is positioned, and can provide analysis of the one or more identity sense signals. For example, in an embodiment, the circuitry **106** is operably coupled to the sensor assembly **104** such that the circuitry **106** is configured to receive the one or more identity sense signals from the one or more identity sensors

200 of the sensor assembly **104**. In an embodiment, shown in FIG. **4**, the circuitry **106** includes a comparison module **400** configured to compare the one or more identity sense signals generated by the sensor assembly **104** to reference data indicative of one or more physical characteristics associated with an identity of at least one individual to determine whether the one or more identity signals correspond to the identity of the at least one individual. In an embodiment, the reference data is stored in a computer memory device **402** which can include, but is not limited to, random-access memory (RAM), read-only memory (ROM), electrically erasable programmable read-only memory (EEPROM), flash memory, or other memory technology, CD-ROM, digital versatile disks (DVD), or other optical disk storage, magnetic cassettes, magnetic tape, magnetic disk storage, or other magnetic storage devices, or any other medium which can be used to store the desired information maintained by the comparison module **400** and which can be accessed by the circuitry **106** or other associated accessing device.

The circuitry **106** includes components to process the one or more sense signals from the sensor assembly **104** and to provide instruction to the reporter **108** to generate one or more communication signals associated with the one or more identity sense signals, a comparison of the one or more identity sense signals with the one or more physical characteristics from reference data indicative with an identity of a particular individual, determinations made by the circuitry **106**, or other information. For example, the circuitry **106** can include a microprocessor, a central processing unit (CPU), a digital signal processor (DSP), an application-specific integrated circuit (ASIC), a field programmable gate entry (FPGA), or the like, or any combinations thereof, and can include discrete digital or analog circuit elements or electronics, or combinations thereof. In an embodiment, the circuitry **106** includes one or more ASICs having a plurality of predefined logic components. In an embodiment, the circuitry **106** includes one or more FPGAs having a plurality of programmable logic commands. The computer memory device can be integrated with the system **100**, can be associated with an external device and accessible by the system **100** through wireless or wired communication protocols, or a combination thereof. For example, the reference data can be stored by the computer memory **702** coupled to the deformable substrate **102** of the system **100**, can be accessible by the circuitry **106** via wireless means, or can be available to the circuitry **106** through another method, such as through a remote network, a cloud network, and so forth. In an embodiment, the circuitry **106** includes a receiver **404** or transceiver **406** (e.g., antenna, etc.) to receive the reference data information or other information (e.g., correspondence threshold information, programming information) to facilitate operation or control of the system **100** through wireless or wired communication protocols. For example, the receiver **404** can receive one or more communication signals from an external device associated with but not limited to, control programming, authorization parameters, reference data, or a query (e.g., a query to transmit information from the system **100** to the external device, a query to begin sensing of identity sense signals via the sensor assembly **104**, etc.). In embodiments, the circuitry **106** can also include a transmitter **408** or transceiver (e.g., antenna, etc.) to send information amongst components of the system **100** or to components external the system, such as to communicate with an external device (e.g., external device **800** described herein). Such communication can include, for example, indications that the circuitry **106** is accessing one

or more databases or memory devices storing reference or programming data, computational protocols, system updates, or the like.

The reference data includes data indicative of one or more physical characteristics associated with an identity of at least one individual. For example, the reference data can include, but is not limited to, a skin topography feature associated with an identity of an individual, a skin surface pattern associated with an identity of an individual, a follicle pattern associated with an identity of an individual, a pore pattern associated with an identity of an individual, a pigmentation pattern or characteristic associated with an identity of an individual, a vascular layout associated with an identity of an individual, an electric current pattern associated with an identity of an individual, a photovoltaic current pattern associated with an identity of an individual, a skin resistivity measurement associated with an identity of an individual, or the like. For example, the reference data can include one or more physical characteristics associated with a first person/individual, one or more physical characteristics associated with a second person/individual, one or more physical characteristics associated with a third person/individual, and so on. The circuitry 106 is configured to compare the identity sense signals from the sensor assembly 104 to the reference data, such that when the comparison is at or exceeds a threshold correspondence (e.g., within a predetermined confidence interval), the identity of the person/individual stored by the reference data can be attributed to the individual on which the system 100 is positioned. For example, if the reference data includes physical characteristic information for each of Bob, Jan, and Joe, the circuitry 106 can compare the identity sense signals from the sensor assembly 104 to determine whether the identity sense signals would correspond to the physical characteristic information of Bob, Jan, or Joe.

The circuitry 106 can coordinate operations of the system 100 based on analysis of the one or more identity sense signals, which can include but is not limited to, enabling or disabling certain operations or components of the system 100 based on whether the individual subject can be identified via the one or more identity sense signals. For example, in an embodiment, the circuitry 106 is configured to disable at least one component of the system 100 responsive to a correspondence between the one or more identity sense signals and the one or more physical characteristics associated with the identity of the at least one individual being below a threshold correspondence. The correspondence between the one or more identity sense signals and the one or more physical characteristics associated with the identity of the at least one individual can include a comparison by the circuitry 106 between the one or more identity sense signals and the one or more physical characteristics provided in the reference data (e.g., which can be linked or associated with certain identified individuals). As such, the circuitry 106 can disable functionality of a component of the system 100 where the individual subject on which the system 100 is positioned cannot be readily identified based on the comparison made by the circuitry 106. For example, in an embodiment, the circuitry 106 is configured to disable a power connection to the sensor assembly 104 responsive to the correspondence between the one or more identity sense signals and the one or more physical characteristics associated with the identity of the at least one individual being below the threshold correspondence. In an embodiment, the circuitry 106 is configured to disable a power connection to the reporter 108 responsive to the correspondence between the one or more identity sense signals and the one or more

physical characteristics associated with the identity of the at least one individual being below the threshold correspondence. For example, in an embodiment, shown in FIG. 5, the circuitry 106 can include, or can be operably coupled to, a switch structure 500 switchable between an active configuration and an inactivate configuration responsive to control by the circuitry 106. The switch structure 500 can automatically disable, or can continue to disable, a power connection to one or more of the sensor assembly 104 or the reporter 108 (e.g., by providing a break in an electrical circuit providing power to the sensor assembly 104 or the reporter 108) when the individual subject on which the system 100 is positioned cannot be identified by the one or more identity sense signals, causing the circuitry 106 to manipulate the switch structure 500 to the inactive configuration, or causing the circuitry 106 to maintain the inactive configuration. Thus, when the individual subject cannot be identified, the individual subject would be precluded from operating the sensor assembly 104 or the reporter 108.

The circuitry 106 can be configured to permit operation of at least one component of the system 100 responsive to a correspondence between the one or more identity sense signals and the one or more physical characteristics associated with the identity of the at least one individual being at or above a threshold correspondence. The correspondence between the one or more identity sense signals and the one or more physical characteristics associated with the identity of the at least one individual can include a comparison by the circuitry 106 between the one or more identity sense signals and the one or more physical characteristics provided in the reference data (e.g., which can be linked or associated with certain identified individuals). As such, the circuitry 106 can enable functionality of a component of the system 100 where the individual subject on which the system 100 is positioned can be identified (e.g., within the threshold correspondence) based on the comparison made by the circuitry 106. For example, in an embodiment, the circuitry 106 is configured to activate a power connection to the sensor assembly 104 responsive to the correspondence between the one or more identity sense signals and the one or more physical characteristics associated with the identity of the at least one individual being at least at the threshold correspondence. In an embodiment, the circuitry 106 is configured to activate a power connection to the reporter 108 responsive to the correspondence between the one or more identity sense signals and the one or more physical characteristics associated with the identity of the at least one individual being at least at the threshold correspondence. For example, the switch structure 500 can automatically activate, or can continue to support, a power connection to one or more of the sensor assembly 104 or the reporter 108 (e.g., by closing a break in an electrical circuit providing power to the sensor assembly 104 or the reporter 108, by maintaining the operability of the electrical circuit providing power to the sensor assembly 104 or the reporter 108, etc.) when the individual subject on which the system 100 is positioned can be identified by the one or more identity sense signals, causing the circuitry 106 to manipulate the switch structure 500 to the active configuration, causing the circuitry 106 to maintain the switch structure 500 in the active configuration, or the like. Thus, when the individual subject can be identified, the individual subject can operate the sensor assembly 104 or the reporter 108, the system 100 can maintain functionality, etc.

In an embodiment, the circuitry 106 is activated, controlled, or deactivated by gesture. For example, the circuitry 106 can receive one or more sense signals from a gesture

sensor of the system (e.g., an accelerometer, a motion sensor, a proximity sensor, a contact sensor, or other sensor) indicative of a gesture performed by the individual subject, such as a gesture with the body portion on which the system is positioned, a body portion proximate to the body portion on which the system is positioned, or other body portion. For example, the gesture can include a wave, a pinch, a rub, a squeeze, a click, a lift, a flick, a shake, or other gesture configured to activate, control, or deactivate the circuitry **106** via the one or more sense signals from gesture sensor. The system **100** can store a correspondence between a particular gesture and a functionality of the circuitry. For example, a first gesture (e.g., a wave gesture) can correspond to execution of a first program or protocol (e.g., a reporting protocol to cause the circuitry **106** to instruct the reporter **108** to generate the one or more communication signals), a second gesture (e.g., a pinch gesture) can correspond to execution of a second program or protocol (e.g., a sensing protocol to cause the circuitry **106** to activate or deactivate the sensor assembly **104**), and where a third gesture (e.g., a shake gesture) can correspond to execution of a third program or protocol (e.g., a power protocol to cause the system **100** to power up or power down), and so on.

In an embodiment, as shown in FIG. 6, the system **100** includes a power supply **600** configured to provide power to one or more components of the system **100** including, but not limited to, the sensor assembly **104**, the circuitry **106**, and the reporter **108**. For example, the power supply **600** can be a resident device component that is coupled to the deformable substrate **102**. Examples of resident device components include, but are not limited to, batteries (e.g., a thin film battery, a microbattery), solar cells (e.g., silicon-based solar cells) configured to convert light energy into electrical energy for use by the components of the system **100**, fuel cells, and energy harvesting devices (e.g., power devices configured to generate power from motion, such as motion of the body portion, motion of blood flow, and so forth). In embodiments, the power supply **600** includes one or more components positioned remotely from the deformable substrate **102** that transmit power signals via associated wireless power methods including, but not limited to, inductive coupling of power signals. In such embodiments, the system **100** includes one or more components positioned on the deformable substrate **102** configured to one or more of receive, process, and/or distribute the power signals that originate from components positioned remotely from the deformable substrate **102**. For example, the system **100** can include a wireless power coil coupled to the deformable substrate **102** that is configured to receive a remote power signal, such as a remote power signal originating from a remote transmission coil. In an embodiment, the power supply **600** includes stretchable or flexible electronics. For example, the power supply **600** can include a silicon filamentary serpentine-shaped photovoltaic cell. For example, the power supply **600** can include filamentary serpentine-shaped inductive coils.

The reporter **108** of the system **100** is configured to generate one or more communication signals to report information associated with operation of the system **100**. In an embodiment, the reporter **108** is operably coupled to the circuitry **106** and is configured to generate one or more communication signals responsive to instruction by the circuitry **106**. The communication signals can be associated with the one or more identity sense signals generated by the sensor assembly **104** (e.g., via the one or more identity sensors **200**), with a comparison of the one or more identity sense signals with the one or more physical characteristics

associated with the identity of the at least one individual (e.g., as provided by the circuitry **106** to determine whether the one or more identity signals correspond to the identity of the at least one individual), or a combination thereof. For example, the reporter **108** can report that the individual on which the system **100** is placed corresponds to a first individual (e.g., it is Bob), the reporter **108** can report that the information transmitted is a second individual's physical characteristics (e.g., this information corresponds to the skin topography feature of Jan), the reporter **108** can report that the system **100** is unable to determine an identity of the individual (e.g., the physical characteristics measured by the sensor assembly **104** do not correspond to, or do not meet a threshold correspondence to, any of Bob, Jan, or Joe), or the like. In an embodiment, the communication signals are reportable to an external device or system (e.g., external device **800**, described further herein). For example the external device or system can include, but is not limited to, a computing device, system or network (e.g., a personal computing device, an electronic health record, etc.), or an electronic device (e.g., an electronic game, an electronic controller such as on a vehicle or instrument, or other electronic equipment). In an embodiment, the system **100** can transmit the one or more communication signals to a computing device having at least one of circuitry or programming that collects data from one or more wearable sensors that are part of the system **100** or are otherwise associated with the individual on which the system **100** is positioned, so that the computing device can associate data within the communication signals with the individual. The system **100**, via the reporter **108**, can transmit identity information to an electronic controller equipped with authorization capabilities for employment in authorizing use of one or more devices, programs, device functionalities, or the like, by the identified individual. For example, the system **100** can transmit information that the individual is identified as Bob, whereby the electronic controller can facilitate use of one or more devices, programs, device functionalities by Bob, according to his identity.

In an embodiment, shown in FIG. 7, the reporter **108** includes one or more of a transmitter **700**, a transceiver **702**, or a receiver **704**. For example, the reporter **108** can include an antenna structure configured to at least one of transmit the one or more communication signals (e.g., via the transmitter **700**, the transceiver **702**, etc.) or receive one or more communication signals from an external device (e.g., via the transceiver **702**, the receiver **704**, etc.). The one or more communication signals from the external device can include but are not limited to, control programming, authorization parameters, reference data, or a query (e.g., a query to transmit information from the system **100** to the external device). In an embodiment, the sensor assembly **104** includes one or more of a transceiver (e.g., transceiver **702**) or a receiver (e.g., receiver **704**) configured receive one or more communication signals from an external device. For example, the one or more communication signals from the external device can include but are not limited to, control programming, authorization parameters, reference data, or a query (e.g., a query to begin sensing physical characteristics of the individual subject on which the system **100** is positioned).

In an embodiment, the system **100** includes a unique identifier associated with at least one of the deformable substrate **102**, the sensor assembly **104**, the circuitry **106**, or the reporter **108**. The unique identifier can facilitate identifying a source of data, a source of communication signals, or the like, such as when multiple identification devices or

systems **100** are utilized in combination to identify a plurality of individual subjects or when multiple identification devices or systems **100** are utilized by an individual subject, e.g., over a period of time. For example, when the reporter **108** generates the one or more communication signals for transmission (e.g., to an external device), the one or more communication signals can be associated with or can include the unique identifier to identify the source of the one or more communication signals, which in turn can be associated with a particular identity of an individual on which the system **100** is positioned. The external device can therefore associate the identity of the individual with the particular device in future communications, actions, queries, and the like. When multiple identification devices or systems **100** are utilized by the individual subject the use of such identification devices or systems **100** can be tracked via the unique identifier associated with each identification device or system. For example, the unique identifier can designate a source for communications, measurements, identifications, etc. as being directed to a specific identification device or system **100** (e.g., a lot number), where the communications can be tracked sequentially (when multiple identification devices or systems **100** are utilized by the individual subject over a period of time), in parallel (when multiple identification devices or systems **100** are utilized by the individual subject at a given time), or a combination thereof (when multiple identification devices or systems **100** are utilized by the individual subject over a period of time and at a given time).

In an embodiment, shown in FIG. **8**, the system **100** further includes an external device or system (referred to herein as external device **800**) configured to receive communications from the reporter **108** for analysis by the external device **800**. The external device **800** can include a receiver **802** (e.g., receiving antenna, transceiver, etc.) configured to receive the one or more communication signals from the reporter **108**. The external device **800** can also include circuitry **804** configured to compare the one or more communication signals with one or more authorization parameters associated with one or more users authorized to operate the external device **800**. For example, the external device **800** can include, or can access, a computer memory device **806** that maintains data associated with authorization parameters pertinent to operation of the external device **800**. The authorization parameters can include but are not limited to, a list of identified individuals, identities, devices, or systems authorized to operate at least a portion of features of the external device **800**, a list of reference physical characteristics for one or more users authorized to operate the external device **800**, a list of functionalities of the external device **800** that identified individuals are authorized to utilize, or the like. For example, the external device **800** can receive the communication signals from the reporter **108** indicating an identity of the individual subject on whom the deformable substrate **102** is positioned, whereby the external device **800** can compare (e.g., via the circuitry **804**) the identity of the individual with the authorization parameters stored in the memory **806** to determine whether the identified individual is authorized to operate the external device **800**, to determine which functionalities of the external device **800** the identified individual is authorized to operate, or the like. As another example, where the authorization parameters includes a list of identified devices or systems, such devices or systems can automatically operate the portion of features of the external device **800**, such as without interaction with the individual subject or other individual. The external device **800** can include but is not

limited to, a communication device or electronic equipment, such as one or more of a mobile communication device or a computer system including, but not limited to, mobile computing devices (e.g., hand-held portable computers, Personal Digital Assistants (PDAs), laptop computers, netbook computers, tablet computers, or so forth), mobile telephone devices (e.g., cellular telephones and smartphones), devices that include functionalities associated with smartphones and tablet computers (e.g., phablets), portable game devices, portable media players, multimedia devices, satellite navigation devices (e.g., Global Positioning System (GPS) navigation devices), e-book reader devices (eReaders), Smart Television (TV) devices, surface computing devices (e.g., table top computers), Personal Computer (PC) devices, devices that employ touch-based human interfaces, currency-handling devices (e.g., automated teller machines (ATMs), cash registers, coin/bill counters and sorters, credit/debit card readers, etc.), a motorized vehicle or control systems thereof (e.g., car, truck, motorcycle, boat, snowmobile, airplane, helicopter, etc.), exercise facilities or equipment, a home security system, an electronic medication dispenser (e.g., pill dispenser), medical treatment facilities or equipment (e.g., patient suites, surgical suites, surgical equipment, etc.), rental equipment with a user interface (e.g., video rentals, audio rentals, etc.), transportation security terminals (e.g., airport security terminal, train security terminal, ferry security terminal, etc.), personnel-tracking equipment, heavy or specialized machinery, specialized tools, safety equipment, security equipment (e.g., a lock or access point), medical equipment (e.g., drug delivery devices or surgical tools), or personal equipment or clothing having customizable electronic features. The reporter **108** can communicate (e.g., send and receive communication signals) with the external device **800** via one or more connected or wireless communication mechanisms including, but not limited to acoustic communication signals, sound communication signals (e.g., audible, inaudible, or combinations thereof), optical communication signals, radio communication signals, infrared communication signals, ultrasonic communication signals, electric signals (e.g., via a conduction pathway between a component of the system **100** and the external device **800**), and the like. In an embodiment, one or more of the sensor assembly **104** or the circuitry **106** can receive communication signals from the external device **800**. For example, the external device **800** (e.g., a cellular or network-based device) can transmit one or more communication signals to one or more of the sensor assembly **104** or the circuitry **106**, where such communication signals can initiate or terminate particular functionalities of the sensor assembly **104** or circuitry **106** (e.g., turn on/off), provide programming information, provide updated functionalities, provide or update comparison threshold values or reference data, or the like. In an embodiment, the circuitry **106** directs the reporter **108** to generate the one or more communication responsive to a query from the external device **800**. In an embodiment, the reporter **108** generates the one or more communication signals responsive to instruction by the circuitry **106** without any dependence or communication from the external device **800**. For example, the reporter **108** can generate the one or more communication signals regardless of whether the external device **800** is capable of receiving the communication signals. In such instances, the communication signals generated by the reporter **108** can be stored in memory of the system **100**, where the stored communication signals can be utilized later (e.g., to program one or more new systems **100**, external devices **800**, etc.).

In an embodiment, one or more of the sensor assembly 104, the circuitry 106, or the reporter 108 facilitates interaction between the system 100 and one or more other devices or systems resident on the body of the individual on which the system 100 is positioned. For example, the external device 800 can include one or more devices or systems (e.g., one or more sensors, computing devices, or the like) that also reside on the individual on which the system 100 is positioned. In an embodiment, the system 100 includes the one or more other devices or systems resident on the body of the individual, such as additional sensing devices communicatively coupled with one or more of the sensor assembly 104, the circuitry 106, or the reporter 108. For example, when a sensing device resident on the body of the individual is active (e.g., a heart rate monitor), the output of the sensing device can be associated with the identity of the individual by the association between the sensing device resident on the body and the activities of one or more of the sensor assembly 104, the circuitry 106, or the reporter 108 (e.g., the heart rate measured by the heart rate monitor can be associated with the identity of individual on which the devices or systems are positioned).

The system 100 can also include other sensors to provide functionalities independent of identification, supportive of identification, or the like. For example, in an embodiment, shown in FIG. 9, the system 100 includes one or more of a physiological sensor 900, a proximity sensor 902, a contact sensor 904, a pressure sensor 906, or a temperature sensor 908. In an embodiment, one or more of the physiological sensor 900, the proximity sensor 902, the contact sensor 904, the pressure sensor 906, or the temperature sensor 908 can provide sense signals indicative of whether the deformable substrate 102 is attached to, maintained against, or otherwise in contact with a skin surface of the individual. For example, the circuitry 106 can receive the sense signals from one or more of the physiological sensor 900, the proximity sensor 902, the contact sensor 904, the pressure sensor 906, or the temperature sensor 908 and can activate the sensor assembly 104 to begin identification of the individual subject responsive to confirmation of the presence of the deformable substrate 102 on the skin surface.

In an embodiment, shown in FIG. 10, the circuitry 106 includes an identity comparison module 1000 and an authorization comparison module 1002. The identity comparison module 1000 is configured to compare the one or more identity sense signals generated by the sensor assembly 104 to reference data indicative of one or more physical characteristics associated with an identity of at least one individual to determine whether the one or more identity sense signals correspond to the identity of the at least one individual. For example, the identity comparison module 1000 can include structure and functionality similar to, or the same as, the comparison module 400 described herein. The reference data indicative of one or more physical characteristics associated with an identity of at least one individual can be stored in a computer memory device 1004 accessible by the circuitry 106, the identity comparison module 1000, or the authorization comparison module 1002. For example, the computer memory device 1004 can store data associated with a list of identities (e.g., names of individuals) having associated physical characteristics attributable to the particular identity (e.g., a skin topography feature associated with and unique to a first identity, a skin topography feature associated with and unique to a second identity, and the so forth). The authorization comparison module 1002 is configured to compare at least one of the one or more identity sense signals or the identity of the at least one individual

with one or more authorization parameters. The authorization parameters can include but are not limited to, a list of identified individuals or identities authorized to operate at least a portion of features of the system 100, a list of identified authorized individuals or identities under which at least a portion of features of the system 100 (e.g., reporter 108) will function, a list of identified individuals or identities authorized to operate at least a portion of features of an external device (e.g., external device 800), a list of reference physical characteristics for one or more users authorized to operate an external device (e.g., external device 800), a list of functionalities of an external device (e.g., external device 800) that identified individuals are authorized to utilize, or the like.

In an embodiment, the reporter 108 is configured to generate the one or more communication signals responsive to instruction by the circuitry 106, where the one or more communication signals are associated with a comparison of at least one of the one or more identity sense signals with the one or more authorization parameters or the identity of the at least one individual with the one or more authorization parameters. For example, instances where the one or more communication signals are based on a comparison of one or more identity sense signals with the one or more authorization parameters, the authorization comparison module 1002 can directly compare the one or more identity sense signals with authorization parameters stored in the memory 1004. The authorization parameters can include a list of physical characteristics of authorized individuals, such that when the identity sense signals match the physical characteristics of authorized individuals stored in memory, the individual subject can be authorized. For example, authorization can include, but is not limited to, the individual being authorized to utilize the system 100 or to use an external device (e.g., where that individual subject substantially matches one identity of the list of individuals authorized to operate the external device), or the system 100 can function fully (e.g., can transmit information) or a portion of the functionalities of the system 100 to which the authorized individual is permitted to utilized are enabled. When the one or more communication signals are based on a comparison of the identity of the at least one individual with the one or more authorization parameters, the identity comparison module 1000 can first identify the individual based on the one or more identity sense signals, whereby the authorization comparison module 1002 can determine whether the identified authorized individual is (e.g., by comparing the identity to reference data having a list of authorized individuals or identities). In an embodiment, when the one or more authorization parameters corresponds to a single authorized user, the identity comparison module 1000 and the authorization comparison module 1002 can be incorporated as a single module for automatic authentication after identification.

In an embodiment, shown in FIG. 11, the circuitry 106 includes a comparison module 1100 configured to compare the one or more identity sense signals generated by the sensor assembly 104 to reference data indicative of one or more physical characteristics associated with a physical state of the individual to determine whether the individual subject is authorized to operate an external device. For example, the memory 1004 can store reference data associated with physical states including but not limited to, a vital status (e.g., physiological reference data indicative of a living status or a deceased status, physiological data associated with a distress or stress status, or the like) or a functional status (e.g., a physical status, a mental status, or the like). In an embodiment, the comparison module compares sense

signals from other sensors of the system (e.g., one or more of the physiological sensor **900**, the proximity sensor **902**, the contact sensor **904**, the pressure sensor **906**, or the temperature sensor **908**) to determine the vital status or the functional status of the individual. The reference data indicative of one or more physical characteristics associated with a functional status can include but are not limited to, chemical or biological indicators of inebriation or intoxication (e.g., by drugs or alcohol), the presence or absence of a substance (e.g., a toxin, a poison, a prescription medication), a blood oxygenation level, a movement, pattern of movement, or absence of movement (e.g., as indicators of a state of consciousness or of compromised fine motor skills), or so forth. The vital status or the functional status can serve as an indicator as to whether an identified individual is in a state suitable for operation of the external device. For example, while the individual subject may be identified and authorized to use a device, the current status of the individual may preclude total or partial operation of the external device. For example, the sensors of the system **100** may detect that the individual does not have sufficient levels of medication in their bloodstream (e.g., a person with tremors or seizures) to safely operate a motorized vehicle for an extended period of time. In an embodiment, the circuitry **106** is configured to prevent authorization of the individual subject to operate at least a portion of the external device responsive to a correspondence between the one or more identity sense signals and the reference data indicative of the one or more physical characteristics associated with the functional status of the individual being above a functional threshold correspondence. For example, the functional threshold correspondence can be related to a safety threshold of a physical characteristic for operation of the external device (e.g., a blood alcohol content, a medication level, etc.). In an embodiment, the circuitry **106** prevents authorization of the individual subject by not instructing the reporter **108** to generate or transmit the one or more communication signals. In an embodiment, the circuitry **106** can permit partial authorization of operation of the external device, such that only a subset of functionalities of the external device is available to the individual for operation. For example, if an individual is identified and authorized to use a smart phone device, and that individual is determined to be intoxicated or to otherwise have a diminished functional status, the circuitry **106** can permit phone calls or web browsing functionalities, but prevent financial transaction functionalities.

In an embodiment, shown in FIG. 12, the reporter **108** includes a display device **1200** configured to provide a visual indication associated with an output of the reporter **108**. For example, the display device **1200** can include one or more light-emitting elements **1202** (e.g., light-emitting diodes, polymer light-emitting diodes (PLEDs), lasers, or other light source(s)) configured to provide a predetermined pattern of light corresponding to a comparison between at least one of the one or more identity sense signals with the one or more authorization parameters or the identity of the at least one individual with the one or more authorization parameters. The predetermined pattern of light can include patterns associated with light intensity or brightness, color, shapes, or other characteristics discernable between distinct patterns. In an embodiment, the predetermined pattern includes a first pattern associated with a correspondence between at least one of the one or more identity sense signals with the one or more authorization parameters or the identity of the at least one individual with the one or more authorization parameters being below a threshold correspondence

(e.g., the physical characteristics measured by the sensor assembly **104** do not correspond to an authorized individual), and the predetermined pattern includes a second pattern associated with a correspondence between at least one of the one or more identity sense signals with the one or more authorization parameters or the identity of the at least one individual with the one or more authorization parameters being at least at the threshold correspondence (e.g., the physical characteristics measured by the sensor assembly **104** correspond to an authorized individual). For example, the reporter **108** can display via the display device a first pattern (e.g., a first intensity, a first color, a first shape, etc.) if the individual subject is not authorized to operate the external device, and can display a distinct second pattern (a second intensity, a second color, a second shape, etc.) if the individual subject is authorized to operate the external device. The system **100** can also include one or more photodetectors, such as one or more organic photodetectors (OPDs), to detect light from the display device **1200** and/or the sensor assembly **104**, such as light reflected by or refracted from a body portion. For example, the system **100** can include an organic photodetector comprising an active layer of poly(3-hexylthiophene) (P3HT):(6,6)-phenyl-C61-butyric acid methyl ester (PCBM).

In an embodiment, the display device **1200** includes can include one or more sound-emitting elements **1204** (e.g., speaker, tone-source, or other sound source(s)) configured to provide a predetermined pattern of sound corresponding to a comparison between at least one of the one or more identity sense signals with the one or more authorization parameters or the identity of the at least one individual with the one or more authorization parameters. The predetermined pattern of sound can include patterns associated with sound intensity, audible and inaudible phases, or other characteristics discernable between distinct patterns. In an embodiment, the predetermined pattern includes a first pattern associated with a correspondence between at least one of the one or more identity sense signals with the one or more authorization parameters or the identity of the at least one individual with the one or more authorization parameters being below a threshold correspondence (e.g., the physical characteristics measured by the sensor assembly **104** do not correspond to an authorized individual), and the predetermined pattern includes a second pattern associated with a correspondence between at least one of the one or more identity sense signals with the one or more authorization parameters or the identity of the at least one individual with the one or more authorization parameters being at least at the threshold correspondence (e.g., the physical characteristics measured by the sensor assembly **104** correspond to an authorized individual). For example, the reporter **108** can display via the display device a first pattern (e.g., a first intensity, a first audible/inaudible pattern, etc.) if the individual subject is not authorized to operate the external device, and can display a distinct second pattern (a second intensity, a second audible/inaudible pattern, etc.) if the individual subject is authorized to operate the external device.

In an embodiment, the display device **1200** includes a projection display **1206** configured to provide a visual indication associated with an output of the reporter **108**. For example, the projection display **1206** can be configured to provide a projected image (e.g., projected onto a skin surface, onto a clothing item or garment, onto a wall or support surface, onto a screen, etc.) corresponding to a comparison between at least one of the one or more identity sense signals with the one or more authorization parameters

or the identity of the at least one individual with the one or more authorization parameters.

In an embodiment, the circuitry **106** is configured to determine whether the deformable substrate **102** has been removed from the skin surface of the individual subject. For example, the system **100** can include, as a part of the sensor assembly **104**, distinct from the sensor assembly **104**, or a combination thereof, one or more of a strain gauge or a proximity sensor configured to sense whether the deformable substrate **102** has been removed from the skin surface of the individual subject. For example, the system **100** can include a computer memory device storing reference data associated with strain or distance measurements corresponding to removal of the deformable substrate **102** from a skin surface. The circuitry **106** can compare the output from the strain gauge or proximity sensor to such reference data to determine whether the deformable substrate **102** has been removed. In an embodiment, the circuitry **106** is configured to determine whether the deformable substrate **102** has been applied to a skin surface that differs from the skin surface of the individual subject. For example, the system **100** can store in a computer memory device the one or more identity sense signals obtained by the sensor assembly **104** at a first time, whereby the circuitry **106** can compare one or more identity sense signals obtained by the sensor assembly **104** at a second time to the stored identity sense signals obtained by the sensor assembly **104** at the first time to determine whether the signals substantially differ. If the signals are directed to a skin property, a substantial difference between signals obtained at differing times can indicate that the skin surface differs between the first time and the second, which can indicate that the system **100** was transferred between different individuals between the first time and the second time.

The reporter **108** can generate the one or more communication signals responsive to a variety of scenarios involving one or more of identification or authorization. For example, in an embodiment, the one or more communication signals generated by the reporter **108** correspond to a lack of authorization of the individual subject to operate an external device responsive to a correspondence between the one or more identity sense signals and the reference data indicative of one or more physical characteristics associated with the identity of the at least one individual being below a threshold correspondence. For example, when the circuitry **106** (e.g., via the identity comparison module **1000**) is unable to identify the individual subject on which the system **100** is positioned, the reporter **108** can report via the communication signals that the individual subject is not authorized to operate the external device on the basis that such individual subject is not recognizable. In an embodiment, when the circuitry **106** (e.g., via the identity comparison module **1000**) is unable to identify the individual subject on which the system **100** is positioned, the circuitry **106** prevents generation of the communication signals by the reporter **108** (e.g., no instruction from the circuitry **106** to the reporter **108** regarding generation of the one or more communication signals). In an embodiment, the one or more communication signals generated by the reporter **108** correspond to authorization of the individual subject to operate an external device responsive to both of (i) a correspondence between the one or more identity sense signals and the reference data indicative of one or more physical characteristics associated with the identity of the at least one individual being at least at a threshold correspondence and (ii) a correspondence between at least one of the one or more identity sense signals or the identity of the at least one individual with one or more

authorization parameters being at least at a threshold correspondence. For example, when the circuitry **106** is able to identify the individual subject on which the system **100** is positioned (e.g., via the identity comparison module **1000**) and the circuitry **106** is able to authorize the individual subject on which the system **100** is positioned for operation of the external device (e.g., via the authorization comparison module **1002**), the reporter **108** can report via the communication signals that the individual subject is authorized to operate the external device.

In an embodiment, the reporter **108** is configured to provide a static output of communication signals. In an embodiment, the reporter **108** is configured to continuously generate the one or more communication signals. In an embodiment, the reporter **108** is configured to provide a dynamic output of communication signals. In an embodiment, the reporter **108** is configured to generate the one or more communication signals responsive to a query from an external device (e.g., external device **800**). In an embodiment, the reporter **108** is configured to generate the one or more communication signals responsive to a proximity between the reporter **108** and an external device (e.g., external device **800**). For example, the system can include a proximity sensor (e.g., proximity sensor **902**) configured to generate sense signals indicative of proximity between the reporter **108** and an external device (e.g., external device **800**). The circuitry **106** can compare the sense signals from the proximity sensor to reference data (e.g., a threshold proximity) to determine whether the reporter **108** and the external device **800** are close enough to begin transmission of communication signals from the reporter **108** to the external device **800**, and instruct the reporter **108** to generate the one or more communication signals when it is determined that the reporter **108** and the external device **800** are within a threshold proximity.

In an embodiment, shown in FIG. **13**, the system **100** includes the deformable substrate **102**, the sensor assembly **104**, the circuitry **106**, and an adhesive **1300**. The adhesive **1300** is coupled to a surface of the deformable substrate **102** and configured to adhere the deformable substrate **102** to the skin surface of the individual subject. The adhesive **1300** is configured to transition from a first state (e.g., an adhesive state) to a second state (e.g., a non-adhesive state) responsive to one or more energy signals (e.g., electric signals, thermal signals, magnetic signals, light signals, etc.) from the circuitry **106**. In an embodiment, the circuitry **106** is configured to generate the one or more energy signals responsive to a correspondence between the one or more identity sense signals and the one or more physical characteristics associated with the identity of the at least one individual being below a threshold correspondence. For example, if the circuitry **106** cannot determine the identity of the individual subject on whom the system **100** is positioned (e.g., via one or more of the comparison module **400** or the identity comparison module **1000**), the circuitry **106** generates the one or more energy signals to transition the adhesive **1300** from an adhesive state to a non-adhesive state. When in the non-adhesive state, the adhesive **1300** lacks sufficient ability (e.g., adhesive properties, tackiness, adhesion properties, or the like) to keep the deformable substrate **102** secured in place relative to the skin surface of the individual subject (e.g., a low adhesive state). Thus, when the adhesive **1300** is in the non-adhesive state, the system **100** can lose functionality or operability with respect to an individual subject that cannot be readily identified.

In an embodiment, shown in FIG. **14**, the adhesive **1300** can include one or more of an electro-responsive adhesive,

such as an electroactive polymer **1400**, a thermo-responsive adhesive **1402**, a magnetic-responsive adhesive **1404**, a light-responsive adhesive **1406**, or a reversible microstructure **1408**. The electroactive polymer **1400** can be actuated by the one or more energy signals from the circuitry **106** to provide reversible or switchable adhesion characteristics, such as to transition between the adhesive state and the non-adhesive state. For example, the electroactive polymer **1400** can be configured to change a dimension or shape responsive to the one or more energy signals, which can increase or decrease the adhesive effect between the electroactive polymer **1400** and the skin surface to which the system **100** is applied (such as through a change in the amount of surface area in contact with the skin surface, or the like). The electroactive polymer **1400** can include, for example, an electroactive hydrogel, dielectric polymer, electrorestrictive polymer, electroviscoelastic polymer, ferroelectric polymer (e.g., PVDF), liquid crystal elastomer, ionic polymer (e.g., an ionomer such as Nafion), conductive polymer (e.g., polyaniline or polypyrrole films), ionomeric polymer-metallic composite (IPMC), conjugated polymer (e.g., peptide-conjugated PEDOT), single-network or double-network stimuli-responsive gel (e.g., methacrylates such as PMAA and POEGMA), carbon structures (including nanostructures), and the like. In an embodiment, the electroactive polymer **1400** is configured to reversibly transition between the adhesive state and the non-adhesive state responsive to the one or more energy signals from the circuitry **106**. In an embodiment, the electroactive polymer **1400** is configured to reversibly transition between the nonadhesive state and the adhesive state responsive to the one or more energy signals from the circuitry **106**.

The thermo-responsive adhesive **1402** can be actuated by a change in temperature of the adhesive responsive to the one or more energy signals from the circuitry **106** to transition from the adhesive state to the non-adhesive state. For example, the thermo-responsive adhesive **1402** can be configured to at least partially ablate due to an increase in temperature responsive to interaction with the one or more energy signals from the circuitry **106**, which can lead to loss or lessening of adhesion. The thermo-responsive adhesive **1402** can include, for example a thermo-responsive polymer, such as a polyacrylamide (e.g., Poly(N-isopropylacrylamide or poly(N,N-diethylacrylamide)), a shape memory polymer (e.g., epoxy-based), or a L-3,4-dihydroxyphenylalanine (DOPA)-modified polymer. In an embodiment, the thermo-responsive adhesive **1402** is configured to reversibly transition between the adhesive state and the non-adhesive state responsive to the one or more energy signals from the circuitry **106**. In an embodiment, the thermo-responsive adhesive **1402** is configured to reversibly transition between the nonadhesive state and the adhesive state responsive to the one or more energy signals from the circuitry **106**. For example, a thermoresponsive adhesive that becomes adhesive to tissue above a predetermined temperature (e.g., 32 degrees C.) and will lose its adhesive properties below that temperature responsive to the thermal energy signal. For example, a thermal-responsive adhesive includes a DOPA-modified PEG polymer and an oxidizing reagent stored in liposomes, which, when thermally triggered by the energy source, release the oxidizing agent thereby transforming the polymer to an adhesive hydrogel.

The magnetic-responsive adhesive **1404** can be actuated by application of a magnetic field, or change in a magnetic field, applied to the adhesive responsive to the one or more energy signals from the circuitry **106**, such as to transition from the adhesive state to the non-adhesive state. The

magnetic-responsive adhesive **1404** can include, for example an array of micropillars formed with polydimethylsiloxane (PDMS) that has incorporated metallic micro- or nanoparticles such as neodymium (NdFeB) microparticles. In an embodiment, the magnetic-responsive adhesive **1404** is configured to reversibly transition between the adhesive state and the non-adhesive state responsive to the one or more energy signals from the circuitry **106**. In an embodiment, the magnetic-responsive adhesive **1404** is configured to reversibly transition between the nonadhesive state and the adhesive state responsive to the one or more energy signals from the circuitry **106**.

The light-responsive adhesive **1406** can be actuated by application of a light source, or change in exposure to light, applied to the adhesive responsive to the one or more energy signals from the circuitry **106**, such as to transition from the adhesive state to the non-adhesive state. The light-responsive adhesive **1406** can include, for example an azobenzene-modified glycoconjugate, azo-containing liquid crystalline network (LCN) micropillars, or combinations thereof. In an embodiment, the light-responsive adhesive **1406** is configured to reversibly transition between the adhesive state and the non-adhesive state responsive to the one or more energy signals from the circuitry **106**. In an embodiment, the light-responsive adhesive **1406** is configured to reversibly transition between the nonadhesive state and the adhesive state responsive to the one or more energy signals from the circuitry **106**. In embodiments, the light-responsive adhesive **1406** is sensitive to particular wavelengths of light (e.g., ultraviolet light, blue light, etc.). For example, application of the particular wavelengths of light can provide mitigation of the adhesive effect of the light-responsive adhesive **1406**.

The reversible microstructure **1408** can be configured to transition between the adhesive state and the non-adhesive state responsive to the one or more energy signals from the circuitry **106**. For example, the reversible microstructure **1408** can include microtip surfaces, such as elastomeric microtip surfaces, having geometric (e.g., pyramidal) structures protruding from posts arranged in arrays (e.g., square arrays). Such configurations can permit collapse of regions between the posts of the arrays between the protruding geometric structures, such as when subjected to an applied force. The reversible microstructure **1408** can provide differing levels of adhesion based on the underlying attractive forces between, for example, the reversible microstructure **1408** and a skin surface to which the system **100** is applied. For instance, the reversible microstructure **1408** can provide a generally high level of adhesion when the regions between the microtips are collapsed to maximize contact area between the reversible microstructure **1408** and the skin surface, which can facilitate van der Waals interactions. When the posts are permitted to retract to a resting state (e.g., neutral elastomeric positions), the adhesive effect is substantially reduced as compared to the collapsed state. In an embodiment, the reversible microstructure **1408** is configured to reversibly transition between the adhesive state and the non-adhesive state responsive to the one or more energy signals from the circuitry **106**.

In embodiments, the reversible microstructure **1408** can comprise micropillar or microfibrillar structures or an array thereof, which can include biomimetic structural designs that confer adhesive properties (e.g., van der Waals forces, directional adhesion, and frictional adhesion) of natural setae (e.g., gecko setae), designs including anisotropic, asymmetrical materials or structure design (e.g., for anisotropic directional and frictional adhesion), and end shape design. For example, end shapes can include one or more of

a plate shape (e.g., T or L shapes), semi-sphere shape, concave shape, mushroom shape, fibrillar shapes, or lamellae (e.g., in an hierarchical structure). Micropillar or microfibrillar structures can be formed from energy-responsive materials, energy non-responsive materials, or mixtures thereof including, but not limited to, polyimide, PVS, PDMS, poly(methyl methacrylate) (PMMA), polyurethane, polystyrene (PS), silicon rubber, polypropylene, polyethylene, poly(methylvinylsiloxane) (PMVS), IPMC, and other polymers listed in here, as well as carbon structures (including nanostructures). Different portions (e.g., the end shape) of a micropillar or microfibrillar structure can be formed from a material that is different than that forming another portion (e.g., the pillar or fiber) of the structure. At least a portion of a micropillar or microfibrillar structure can be coated, for example with an energy-responsive polymer or with a substance that confers biocompatibility. Micropillar or microfibrillar structures can be configured to transition between the adhesive state and the non-adhesive state responsive to the one or more energy signals from the circuitry 106. In an embodiment, the reversible microstructure 1408 is configured to reversibly transition between the adhesive state and the non-adhesive state responsive to the one or more energy signals from the circuitry 106. For example, adhesive properties of a reversible microstructure that includes micropillar or microfibrillar structures can be altered by altering the orientation of the micropillar or microfibrillar structures (thereby altering the frictional or directional adhesive properties), responsive to the one or more energy signals from the circuitry 106. In an embodiment, the magnetic-responsive adhesive 1404 includes micropillar structures with a T-shaped ending and formed from a magnetic-responsive material (e.g., PDMA with NdFeB microparticles) controllably tilt in the presence of a magnetic field according to the strength and direction of the field, so that adhesion of the micropillar structures can be controllably disrupted responsive to the one or more electromagnetic signals from the circuitry 106.

In an embodiment, the adhesive 1300 includes an actuator responsive to the one or more energy signals from the circuitry 106. For example, an array of micropillars formed from PMVS is attached to an actuator of IPMC, which, responsive to the one or more energy signals from the circuitry 106 (e.g., at 1.0, 1.5, or 2.0 V depending on desired adhesion), bends driving the micropillars to actively adhere to or release the surface.

In an embodiment, shown in FIG. 15, the system 100 includes a reservoir 1500 configured to release an adherence mitigator responsive to the one or more energy signals from the circuitry 106. The adherence mitigator is configured to interact with the adhesive 1300 to transition the adhesive 1300 from the adhesive state to the non-adhesive state. For example, the adherence mitigator can include a substance having a pH (e.g., an acid) that alters the ionic properties of the adhesive (e.g., a single or double network poly(methacrylic acid) hydrogel that bonds at pH 6 but loses adhesion when exposed to acidic pH). For example, the adherence mitigator can include a solvent that degrades a polymer adhesive. The reservoir 1500 can be formed from a portion of the material of the deformable substrate 102, can be formed from a structure positioned on a surface of the deformable substrate 102, or a combination thereof. In an embodiment, the reservoir 1500 includes a plurality of reservoirs, configured to release the reservoir contents temporally, sequentially, in parallel, or in combinations thereof. In an embodiment, the reservoir 1500 includes an energy-responsive hydrogel configured to release the reservoir

contents upon stimulation (e.g., in response to the one or more energy signals, in response to an electric signal, in response to a thermal signal, in response to an electromagnetic signal, etc.) In scenarios where the individual subject cannot be identified, or where the individual subject is identified but not authorized to operate an external device, the circuitry 106 can generate one or more energy signals to activate the reservoir 1500 to cause release of the adherence mitigator, thereby permitting interaction between the adherence mitigator and the adhesive 1300. In an embodiment, the adherence mitigator includes one or more of a fluid material or a powdered material. In an embodiment, the adhesive 1300 is configured to transition from the non-adhesive state to the adhesive state upon removal of the adherence mitigator. For example, the adherent material can be washed or otherwise removed from contact with the adhesive 1300 to permit the adhesive 1300 to attain the adhesive state. In an embodiment, the adherence mitigator is configured to degrade at least a portion of at least one of the adhesive 1300, the deformable substrate 102, the sensor assembly 104, or the circuitry 106. Such degradation can influence the functionality of one or more of the adhesive 1300, the deformable substrate 102, the sensor assembly 104, or the circuitry 106, such as by causing at least a portion of the adhesive 1300, the deformable substrate 102, the sensor assembly 104, or the circuitry 106 to become inoperative. In an embodiment, the one or more energy signals generated by the circuitry 106 are configured to degrade at least a portion of at least one of the adhesive 1300, the deformable substrate 102, the sensor assembly 104, or the circuitry 106. Such degradation can influence the functionality of one or more of the adhesive 1300, the deformable substrate 102, the sensor assembly 104, or the circuitry 106, such as by causing at least a portion of the adhesive 1300, the deformable substrate 102, the sensor assembly 104, or the circuitry 106 to become inoperative. For example, in scenarios where the individual subject cannot be identified, or where the individual subject is identified but not authorized to operate an external device, the circuitry 106 can generate one or more energy signals to cause the inoperability of one or more functions of one or more of the adhesive 1300, the deformable substrate 102, the sensor assembly 104, or the circuitry 106, due to direct interaction with the energy signals or due to interaction with the adherence mitigator released from the reservoir 1500. In an embodiment (not shown) the system 100 includes a reservoir configured to release an adherence promoter responsive to the one or more energy signals from the circuitry 106. For example, the adherence promoter can include a pH enhancer, a wetting agent, a drying agent, or the like.

FIG. 16 illustrates a method 1600 for identifying an individual using conformable electronics positioned on the individual. Method 1600 shows generating one or more identity sense signals in block 1602, where the sense signals correspond to an individual subject and are generated by an identification device having a deformable substrate and at least one sensor coupled to the deformable substrate. For example, the sensor assembly 104 (e.g., one or more identity sensors 200) can generate one or more identity sense signals associated with an individual subject on which the system 100 is positioned. Method 1600 also includes comparing the one or more identity sense signals to reference data indicative of one or more physical characteristics associated with an identity of at least one individual in block 1604. For example, the circuitry 106 can compare (e.g., via comparison module 400, via comparison module 1000, etc.) the identity sense signals to reference data stored in memory

(e.g., memory 402), where the reference data includes physical characteristics linked or associated with an identity of a known individual. Where the identity sense signals meet or exceed a threshold correspondence when compared to the reference data, the identity linked or associated with the physical characteristics stored in memory can be correlated to the individual subject on which the system 100 is positioned (i.e., the individual subject can be presumed to have the known identity based on a successful correspondence). Where the identity sense signals do not meet a threshold correspondence when compared to the reference data, the identity linked or associated with the physical characteristics stored in memory cannot be correlated to the individual subject on which the system 100 is positioned (i.e., the individual subject is not presumed to have the known identity based on the unsuccessful correspondence). Method 1600 also includes reporting one or more communication signals related to the identity sense signals or the comparison of the identity sense signals to the reference data in block 1606. For example, the reporter 108 can generate the one or more communication signals responsive to instruction by the circuitry 106, where such communication signals can relate to the identity sense signals or to the comparison by the circuitry 106 of the identity sense signals with the reference data. For instance, the communication signals can indicate a successful correspondence between the identity sense signals and the reference data (e.g., provide the established identity of the individual subject on which the system 100 is positioned), can indicate an unsuccessful correspondence between the identity sense signals and the reference data (e.g., provide that the identity of the individual subject on which the system 100 is positioned cannot be established with a certain threshold correspondence), or the like.

FIG. 17 illustrates a method 1700 for identifying and authorizing an individual using conformable electronics positioned on the individual. Method 1700 shows generating one or more identity sense signals in block 1702, where the sense signals correspond to an individual subject and are generated by an identification device having a deformable substrate and at least one sensor coupled to the deformable substrate. For example, the sensor assembly 104 (e.g., one or more identity sensors 200) can generate one or more identity sense signals associated with an individual subject on which the system 100 is positioned. Method 1700 also includes comparing the one or more identity sense signals to reference data indicative of one or more physical characteristics associated with an identity of at least one individual in block 1704. For example, the circuitry 106 can compare (e.g., via comparison module 400, via identity comparison module 1000) the identity sense signals to reference data stored in memory (e.g., memory 402), where the reference data includes physical characteristics linked or associated with an identity of a known individual. Where the identity sense signals meet or exceed a threshold correspondence when compared to the reference data, the identity linked or associated with the physical characteristics stored in memory can be correlated to the individual subject on which the system 100 is positioned (i.e., the individual subject can be presumed to have the known identity based on a successful correspondence). Where the identity sense signals do not meet a threshold correspondence when compared to the reference data, the identity linked or associated with the physical characteristics stored in memory cannot be correlated to the individual subject on which the system 100 is positioned (i.e., the individual subject is not presumed to have the known identity based on the unsuccessful correspondence). Method 1700 also includes comparing the one

or more identity sense signals or a determined identity with one or more authorization parameters in block 1706. For example, the circuitry 106 can compare (e.g., via authorization comparison module 1002) the one or more identity sense signals with one or more authorization parameters to determine whether the identity sense signals correspond to an individual that is authorized to operation an associated external device (such as when the reference data includes a list of physical characteristics associated with individuals authorized to operate at least a portion of the functionalities of the external device 800). The circuitry 106 can compare (e.g., via authorization comparison module 1002) an identity of the individual subject (e.g., when the identity sense signals sufficiently correspond to the physical characteristics provided in the reference data in order to identify the individual subject) to a list of individuals authorized to operate the external device to determine whether the identified individual subject can operate at least a portion of the functionalities of the external device. Method 1700 also includes reporting to an associated external device one or more communication signals related to the comparison with authorization parameters in block 1708. For example, the reporter 108 can generate the one or more communication signals responsive to instruction by the circuitry 106 to report to the external device 800, where such communication signals can relate to whether the individual subject is authorized to operate the external device, such as by being unable to identify the individual (e.g., no authorization), by identifying the individual but the identified individual is not on the authorized list (e.g., no authorization), by successfully corresponding the identity sense signals with physical characteristics of authorized individuals (e.g., authorization), by identifying the individual and having the identified individual being on the authorized list (e.g., authorization), or the like.

FIG. 18 illustrates a method 1800 for adjusting an adhesive state of an adhesive responsive to identification of an individual using conformable electronics. Method 1800 shows generating one or more identity sense signals in block 1802, where the sense signals correspond to an individual subject and are generated by an identification device having a deformable substrate and at least one identity sensor coupled to the deformable substrate. For example, the sensor assembly 104 (e.g., one or more identity sensors 200) can generate one or more identity sense signals associated with an individual subject on which the system 100 is positioned. Method 1800 also includes comparing the one or more identity sense signals to reference data indicative of one or more physical characteristics associated with an identity of at least one individual in block 1804. For example, the circuitry 106 can compare (e.g., via comparison module 400, via comparison module 1000, etc.) the identity sense signals to reference data stored in memory (e.g., memory 402), where the reference data includes physical characteristics linked or associated with an identity of a known individual. Where the identity sense signals meet or exceed a threshold correspondence when compared to the reference data, the identity linked or associated with the physical characteristics stored in memory can be correlated to the individual subject on which the system 100 is positioned (i.e., the individual subject can be presumed to have the known identity based on a successful correspondence). Where the identity sense signals do not meet a threshold correspondence when compared to the reference data, the identity linked or associated with the physical characteristics stored in memory cannot be correlated to the individual subject on which the system 100 is positioned (i.e., the individual subject is not presumed to

have the known identity based on the unsuccessful correspondence). Method 1800 also includes transitioning an adhesive from an adhesive state to a non-adhesive state upon determination that the identity sense signals do not provide a threshold correspondence to the physical characteristics in block 1806. For example, the circuitry 106 can generate one or more energy signals to interact with the adhesive 1300 to transition the adhesive 1300 from an adhesive state to a non-adhesive state when the identity of the individual subject on which the system 100 is positioned cannot be determined within a particular threshold correspondence. In such circumstances, the system 100 may no longer be positioned on the individual subject due to an inability of the adhesive 1300 to maintain a suitable connection to a skin surface of the individual subject when in the non-adhesive state.

FIG. 19 illustrates a method 1900 for adjusting an adhesive state of an adhesive responsive to identification of an individual using conformable electronics. Method 1900 shows generating one or more identity sense signals in block 1902, where the sense signals correspond to an individual subject and are generated by an identification device having a deformable substrate and at least one identity sensor coupled to the deformable substrate. For example, the sensor assembly 104 (e.g., one or more identity sensors 200) can generate one or more identity sense signals associated with an individual subject on which the system 100 is positioned. Method 1900 also includes comparing the one or more identity sense signals to reference data indicative of one or more physical characteristics associated with an identity of at least one individual in block 1904. For example, the circuitry 106 can compare (e.g., via comparison module 400, via comparison module 1000, etc.) the identity sense signals to reference data stored in memory (e.g., memory 402), where the reference data includes physical characteristics linked or associated with an identity of a known individual. Where the identity sense signals meet or exceed a threshold correspondence when compared to the reference data, the identity linked or associated with the physical characteristics stored in memory can be correlated to the individual subject on which the system 100 is positioned (i.e., the individual subject can be presumed to have the known identity based on a successful correspondence). Where the identity sense signals do not meet a threshold correspondence when compared to the reference data, the identity linked or associated with the physical characteristics stored in memory cannot be correlated to the individual subject on which the system 100 is positioned (i.e., the individual subject is not presumed to have the known identity based on the unsuccessful correspondence). Method 1900 also includes transitioning an adhesive from a non-adhesive state to an adhesive state upon determination that the identity sense signals provide a threshold correspondence to the physical characteristics in block 1906. For example, the circuitry 106 can generate one or more energy signals to interact with the adhesive 1300 to transition the adhesive 1300 from a non-adhesive state to an adhesive state when the identity of the individual subject on which the system 100 is positioned can be determined within a particular threshold correspondence. For example, the system 100 may be manually positioned or held against the body portion of an individual subject to permit the sensor assembly 104 to generate the identity sense signals, which when the identity can be determined, the adhesive 1300 can transition from the non-adhesive state to an adhesive state (e.g., via interaction with the energy signals from the circuitry 106) to maintain a suitable connection to a skin

surface of the individual subject, such as to fix the system 100 in place on an identified individual.

In an embodiment, the system 100 is configured as an authorized key or pass. For example, an individual subject can utilize a system described herein to gain access to a building (e.g., clinic, hospital, ER, care facility), room, or kiosk, and to interface with systems therein. The individual subject can utilize a system described herein to gain access to a local gym and interface with its system. The individual subject's identity can be recognized, and the individual subject can be directed to particular exercise equipment or classes specific for that individual subject. The individual subject can also receive feedback once interacting or engaging with the exercise equipment or, for example, doing exercises in front of a mirror or mat with sensors. Thus, the individual subject can receive physical therapy, occupational therapy, or customized exercises specifically tailored to him or her by utilizing a system described herein. Further, the system can make product or service recommendations to the individual subject based on the subject's profile. For example, nutrition products or athletic gear or exercise services can be tailored to the individual subject as selected advertising or promotional offers (coupons, etc.). For example, an individual subject can utilize a system as a transportation pass, such as a bus pass, boarding ticket, or venue ticket. After using the pass, the individual subject individual subject's identity can be recognized, and the individual subject can be directed to particular seat. Further, the system can make product or service recommendations to the individual subject based on the subject's profile, for example suggesting a pair of headphones useful for the venue or a particular beverage tailored to the individual subject as selected advertising.

As an example, an individual subject can utilize a system described herein to gain access to one or more piece of equipment such as that described herein. In this regard, the system can identify the individual and activate the transmission by the system so as to act as a key for any of several pieces of equipment configured to receive the predetermined transmission.

As an example, an individual subject can utilize a system described herein to interface with other information or sensor systems for collecting and transmitting data. For example, health sensors worn by an individual subject can interface with the system, which identifies the individual subject and controls data transmission. Identity is authenticated and transmission is allowed, e.g., to a health care record or daily activity record specific to the individual subject. The transmission includes information associating data with the individual subject. The system can further provide recommendations for products or services based on the data (e.g., a recommendation to see a health care provider or have a prescription filled) and can interface with a third party, such as a health care provider's office or pharmacy, to schedule an appointment or place an order, using the identity and authentication.

Certain embodiments are described herein as including logic or a number of components, modules, or mechanisms. Modules may constitute software modules (e.g., code stored or otherwise embodied on a machine-readable medium or in a transmission medium), hardware modules, or any suitable combination thereof. A "hardware module" is a tangible (e.g., non-transitory) unit capable of performing certain operations and may be configured or arranged in a certain physical manner. In various example embodiments, one or more computer systems (e.g., a standalone computer system, a client computer system, or a server computer system) or

one or more hardware modules of a computer system (e.g., a processor or a group of processors) may be configured by software (e.g., an application or application portion) as a hardware module that operates to perform certain operations as described herein.

In some embodiments, a hardware module may be implemented mechanically, electronically, or any suitable combination thereof. For example, a hardware module may include dedicated circuitry or logic that is permanently configured to perform certain operations. For example, a hardware module may be a special-purpose processor, such as a field programmable gate array (FPGA) or an ASIC. A hardware module may also include programmable logic or circuitry that is temporarily configured by software to perform certain operations. For example, a hardware module may include software encompassed within a general-purpose processor or other programmable processor. It will be appreciated that the decision to implement a hardware module mechanically, in dedicated and permanently configured circuitry, or in temporarily configured circuitry (e.g., configured by software) may be driven by cost and time considerations.

Accordingly, the phrase "hardware module" should be understood to encompass a tangible entity, and such a tangible entity may be physically constructed, permanently configured (e.g., hardwired), or temporarily configured (e.g., programmed) to operate in a certain manner or to perform certain operations described herein. Considering embodiments in which hardware modules are temporarily configured (e.g., programmed), each of the hardware modules need not be configured or instantiated at any one instance in time. For example, where a hardware module comprises a general-purpose processor configured by software to become a special-purpose processor, the general-purpose processor may be configured as respectively different special-purpose processors (e.g., comprising different hardware modules) at different times. Software (e.g., a software module) may accordingly configure one or more processors, for example, to constitute a particular hardware module at one instance of time and to constitute a different hardware module at a different instance of time.

Hardware modules can provide information to, and receive information from, other hardware modules. Accordingly, the described hardware modules may be regarded as being communicatively coupled. Where multiple hardware modules exist contemporaneously, communications may be achieved through signal transmission (e.g., over appropriate circuits and buses) between or among two or more of the hardware modules. In embodiments in which multiple hardware modules are configured or instantiated at different times, communications between such hardware modules may be achieved, for example, through the storage and retrieval of information in memory structures to which the multiple hardware modules have access. For example, one hardware module may perform an operation and store the output of that operation in a memory device to which it is communicatively coupled. A further hardware module may then, at a later time, access the memory device to retrieve and process the stored output. Hardware modules may also initiate communications with input or output devices, and can operate on a resource (e.g., a collection of information).

The state of the art has progressed to the point where there is little distinction left between hardware, software, and/or firmware implementations of aspects of systems; the use of hardware, software, and/or firmware is generally (but not always, in that in certain contexts the choice between hardware and software can become significant) a design

choice representing cost vs. efficiency tradeoffs. There are various vehicles by which processes and/or systems and/or other technologies described herein can be effected (e.g., hardware, software, and/or firmware), and that the preferred vehicle will vary with the context in which the processes and/or systems and/or other technologies are deployed. For example, if an implementer determines that speed and accuracy are paramount, the implementer may opt for a mainly hardware and/or firmware vehicle; alternatively, if flexibility is paramount, the implementer may opt for a mainly software implementation; or, yet again alternatively, the implementer may opt for some combination of hardware, software, and/or firmware. Hence, there are several possible vehicles by which the processes and/or devices and/or other technologies described herein can be effected, none of which is inherently superior to the other in that any vehicle to be utilized is a choice dependent upon the context in which the vehicle will be deployed and the specific concerns (e.g., speed, flexibility, or predictability) of the implementer, any of which may vary. Those skilled in the art will recognize that optical aspects of implementations will typically employ optically-oriented hardware, software, and or firmware.

In some implementations described herein, logic and similar implementations can include software or other control structures. Electronic circuitry, for example, may have one or more paths of electrical current constructed and arranged to implement various functions as described herein. In some implementations, one or more media can be configured to bear a device-detectable implementation when such media hold or transmit device detectable instructions operable to perform as described herein. In some variants, for example, implementations can include an update or modification of existing software or firmware, or of gate arrays or programmable hardware, such as by performing a reception of or a transmission of one or more instructions in relation to one or more operations described herein. Alternatively or additionally, in some variants, an implementation can include special-purpose hardware, software, firmware components, and/or general-purpose components executing or otherwise invoking special-purpose components. Specifications or other implementations can be transmitted by one or more instances of tangible transmission media as described herein, optionally by packet transmission or otherwise by passing through distributed media at various times.

Alternatively or additionally, implementations may include executing a special-purpose instruction sequence or otherwise invoking circuitry for enabling, triggering, coordinating, requesting, or otherwise causing one or more occurrences of any functional operations described above. In some variants, operational or other logical descriptions herein may be expressed directly as source code and compiled or otherwise invoked as an executable instruction sequence. In some contexts, for example, C++ or other code sequences can be compiled directly or otherwise implemented in high-level descriptor languages (e.g., a logic-synthesizable language, a hardware description language, a hardware design simulation, and/or other such similar mode(s) of expression). Alternatively or additionally, some or all of the logical expression may be manifested as a Verilog-type hardware description or other circuitry model before physical implementation in hardware, especially for basic operations or timing-critical applications.

The foregoing detailed description has set forth various embodiments of the devices and/or processes via the use of block diagrams, flowcharts, and/or examples. Insofar as

such block diagrams, flowcharts, and/or examples contain one or more functions and/or operations, each function and/or operation within such block diagrams, flowcharts, or examples can be implemented, individually and/or collectively, by a wide range of hardware, software, firmware, or virtually any combination thereof. In one embodiment, several portions of the subject matter described herein can be implemented via Application Specific Integrated Circuits (ASICs), Field Programmable Gate Arrays (FPGAs), digital signal processors (DSPs), or other integrated formats. However, some aspects of the embodiments disclosed herein, in whole or in part, can be equivalently implemented in integrated circuits, as one or more computer programs running on one or more computers (e.g., as one or more programs running on one or more computer systems), as one or more programs running on one or more processors (e.g., as one or more programs running on one or more microprocessors), as firmware, or as virtually any combination thereof, and that designing the circuitry and/or writing the code for the software and or firmware would be well within the skill of one of skill in the art in light of this disclosure. In addition, the mechanisms of the subject matter described herein are capable of being distributed as a program product in a variety of forms, and that an illustrative embodiment of the subject matter described herein applies regardless of the particular type of signal bearing medium used to actually carry out the distribution.

In a general sense, the various embodiments described herein can be implemented, individually and/or collectively, by various types of electro-mechanical systems having a wide range of electrical components such as hardware, software, firmware, and/or virtually any combination thereof and a wide range of components that may impart mechanical force or motion such as rigid bodies, spring or torsional bodies, hydraulics, electro-magnetically actuated devices, and/or virtually any combination thereof. Consequently, as used herein “electro-mechanical system” includes, but is not limited to, electrical circuitry operably coupled with a transducer (e.g., an actuator, a motor, a piezoelectric crystal, a Micro Electro Mechanical System (MEMS), etc.), electrical circuitry having at least one discrete electrical circuit, electrical circuitry having at least one integrated circuit, electrical circuitry having at least one application specific integrated circuit, electrical circuitry forming a general purpose computing device configured by a computer program (e.g., a general purpose computer configured by a computer program which at least partially carries out processes and/or devices described herein, or a microprocessor configured by a computer program which at least partially carries out processes and/or devices described herein), electrical circuitry forming a memory device (e.g., forms of memory (e.g., random access, flash, read only, etc.)), electrical circuitry forming a communications device (e.g., a modem, communications switch, optical-electrical equipment, etc.), and/or any non-electrical analog thereto, such as optical or other analogs. Examples of electro-mechanical systems include but are not limited to a variety of consumer electronics systems, medical devices, as well as other systems such as motorized transport systems, factory automation systems, security systems, and/or communication/computing systems. Electro-mechanical as used herein is not necessarily limited to a system that has both electrical and mechanical actuation except as context may dictate otherwise.

In a general sense, the various aspects described herein can be implemented, individually and/or collectively, by a wide range of hardware, software, firmware, and/or any

combination thereof and can be viewed as being composed of various types of “electrical circuitry.” Consequently, as used herein “electrical circuitry” includes, but is not limited to, electrical circuitry having at least one discrete electrical circuit, electrical circuitry having at least one integrated circuit, electrical circuitry having at least one application specific integrated circuit, electrical circuitry forming a general purpose computing device configured by a computer program (e.g., a general purpose computer configured by a computer program which at least partially carries out processes and/or devices described herein, or a microprocessor configured by a computer program which at least partially carries out processes and/or devices described herein), electrical circuitry forming a memory device (e.g., forms of memory (e.g., random access, flash, read only, etc.)), and/or electrical circuitry forming a communications device (e.g., a modem, communications switch, optical-electrical equipment, etc.). The subject matter described herein can be implemented in an analog or digital fashion or some combination thereof.

With respect to the use of substantially any plural and/or singular terms herein, the plural can be translated to the singular and/or from the singular to the plural as is appropriate to the context and/or application. The various singular/plural permutations are not expressly set forth herein for sake of clarity.

The herein described subject matter sometimes illustrates different components contained within, or connected with, different other components. It is to be understood that such depicted architectures are merely exemplary, and that in fact many other architectures can be implemented which achieve the same functionality. In a conceptual sense, any arrangement of components to achieve the same functionality is effectively “associated” such that the desired functionality is achieved. Hence, any two components herein combined to achieve a particular functionality can be seen as “operably coupled to” each other such that the desired functionality is achieved, irrespective of architectures or intermedial components. Likewise, any two components so associated can also be viewed as being “operably connected,” or “operably coupled,” to each other to achieve the desired functionality, and any two components capable of being so associated can also be viewed as being “operably couplable,” to each other to achieve the desired functionality. Specific examples of operably couplable include but are not limited to physically mateable and/or physically interacting components, and/or wirelessly interactable, and/or wirelessly interacting components, and/or logically interacting, and/or logically interactable components.

In some instances, one or more components can be referred to herein as “configured to,” “configured by,” “configurable to,” “operable/operative to,” “adapted/adaptable,” “able to,” “conformable/conformed to,” etc. Those skilled in the art will recognize that such terms (e.g. “configured to”) can generally encompass active-state components and/or inactive-state components and/or standby-state components, unless context requires otherwise.

In general, terms used herein, and especially in the appended claims (e.g., bodies of the appended claims) are generally intended as “open” terms (e.g., the term “including” should be interpreted as “including but not limited to,” the term “having” should be interpreted as “having at least,” the term “includes” should be interpreted as “includes but is not limited to,” etc.). If a specific number of an introduced claim recitation is intended, such an intent will be explicitly recited in the claim, and in the absence of such recitation no such intent is present. For example, as an aid to understand-

ing, the following appended claims may contain usage of the introductory phrases “at least one” and “one or more” to introduce claim recitations. However, the use of such phrases should not be construed to imply that the introduction of a claim recitation by the indefinite articles “a” or “an” limits any particular claim containing such introduced claim recitation to claims containing only one such recitation, even when the same claim includes the introductory phrases “one or more” or “at least one” and indefinite articles such as “a” or “an” (e.g., “a” and/or “an” should typically be interpreted to mean “at least one” or “one or more”); the same holds true for the use of definite articles used to introduce claim recitations. In addition, even if a specific number of an introduced claim recitation is explicitly recited, those skilled in the art will recognize that such recitation should typically be interpreted to mean at least the recited number (e.g., the bare recitation of “two recitations,” without other modifiers, typically means at least two recitations, or two or more recitations). Furthermore, in those instances where a convention analogous to “at least one of A, B, and C, etc.” is used, in general such a construction is intended in the sense one having skill in the art would understand the convention (e.g., “a system having at least one of A, B, and C” would include but not be limited to systems that have A alone, B alone, C alone, A and B together, A and C together, B and C together, and/or A, B, and C together, etc.). In those instances where a convention analogous to “at least one of A, B, or C, etc.” is used, in general such a construction is intended in the sense one having skill in the art would understand the convention (e.g., “a system having at least one of A, B, or C” would include but not be limited to systems that have A alone, B alone, C alone, A and B together, A and C together, B and C together, and/or A, B, and C together, etc.). Typically a disjunctive word and/or phrase presenting two or more alternative terms, whether in the description, claims, or drawings, should be understood to contemplate the possibilities of including one of the terms, either of the terms, or both terms unless context dictates otherwise. For example, the phrase “A or B” will be typically understood to include the possibilities of “A” or “B” or “A and B.”

This disclosure has been made with reference to various example embodiments. However, those skilled in the art will recognize that changes and modifications may be made to the embodiments without departing from the scope of the present disclosure. For example, various operational steps, as well as components for carrying out operational steps, may be implemented in alternate ways depending upon the particular application or in consideration of any number of cost functions associated with the operation of the system; e.g., one or more of the steps may be deleted, modified, or combined with other steps.

Additionally, as will be appreciated by one of ordinary skill in the art, principles of the present disclosure, including components, may be reflected in a computer program product on a computer-readable storage medium having computer-readable program code means embodied in the storage medium. Any tangible, non-transitory computer-readable storage medium may be utilized, including magnetic storage devices (hard disks, floppy disks, and the like), optical storage devices (CD-ROMs, DVDs, Blu-ray discs, and the like), flash memory, and/or the like. These computer program instructions may be loaded onto a general purpose computer, special purpose computer, or other programmable data processing apparatus to produce a machine, such that the instructions that execute on the computer or other programmable data processing apparatus create a means for

implementing the functions specified. These computer program instructions may also be stored in a computer-readable memory that can direct a computer or other programmable data processing apparatus to function in a particular manner, such that the instructions stored in the computer-readable memory produce an article of manufacture, including implementing means that implement the function specified. The computer program instructions may also be loaded onto a computer or other programmable data processing apparatus to cause a series of operational steps to be performed on the computer or other programmable apparatus to produce a computer-implemented process, such that the instructions that execute on the computer or other programmable apparatus provide steps for implementing the functions specified.

The foregoing specification has been described with reference to various embodiments. However, one of ordinary skill in the art will appreciate that various modifications and changes can be made without departing from the scope of the present disclosure. Accordingly, this disclosure is to be regarded in an illustrative rather than a restrictive sense, and all such modifications are intended to be included within the scope thereof. Likewise, benefits, other advantages, and solutions to problems have been described above with regard to various embodiments. However, benefits, advantages, solutions to problems, and any element(s) that may cause any benefit, advantage, or solution to occur or become more pronounced are not to be construed as a critical, a required, or an essential feature or element. As used herein, the terms “comprises,” “comprising,” and any other variation thereof are intended to cover a non-exclusive inclusion, such that a process, a method, an article, or an apparatus that comprises a list of elements does not include only those elements but may include other elements not expressly listed or inherent to such process, method, system, article, or apparatus.

In embodiments, the system is integrated in such a manner that the system operates as a unique system configured specifically for function of one or more of the systems described herein (e.g., system **100**) used to identify and/or authorize individual, such as to operate external devices (e.g., external device **800**), and any associated computing devices of the system operate as specific use computers for purposes of the claimed system, and not general use computers. In embodiments, at least one associated computing device of the system operates as a specific use computer for purposes of the claimed system, and not a general use computer. In embodiments, at least one of the associated computing devices of the system is hardwired with a specific ROM to instruct the at least one computing device. In embodiments, one of skill in the art recognizes that the systems described herein (e.g., system **100**) and associated systems/devices effect an improvement at least in the technological field(s) of identification and/or authorization.

While various aspects and embodiments have been disclosed herein, other aspects and embodiments will be apparent to those skilled in the art. The various aspects and embodiments disclosed herein are for purposes of illustration and are not intended to be limiting, with the true scope and spirit being indicated by the following claims.

The invention claimed is:

1. A device, comprising:

- a deformable substrate configured to conform to a skin surface of a body portion of an individual subject;
- a sensor assembly coupled to the deformable substrate, the sensor assembly including one or more identity sensors configured to generate one or more identity

sense signals associated with at least one physical characteristic of the individual subject;
 at least one of a proximity sensor, a contact sensor, a pressure sensor, or a temperature sensor coupled to the deformable substrate and configured to generate one or more sense signals indicative of whether the deformable substrate is in contact with the skin surface of the individual subject;
 circuitry operably coupled to the sensor assembly and configured to receive the one or more sense signals indicative of whether the deformable substrate is in contact with the skin surface of the individual subject and configured to activate the one or more identity sensors to generate the one or more identity sense signals when the one or more sense signals indicate that the deformable subject is in contact with the skin surface of the individual subject, the circuitry further configured to receive the one or more identity sense signals associated with the at least one physical characteristic of the individual subject, the circuitry including an identity comparison module configured to compare the one or more identity sense signals generated by the sensor assembly to reference data indicative of one or more physical characteristics associated with an identity of at least one individual to determine whether the one or more identity sense signals correspond to the identity of the at least one individual, the circuitry including an authorization comparison module configured to compare at least one of the one or more identity sense signals or the identity of the at least one individual with one or more authorization parameters; and a reporter operably coupled to the circuitry and configured to generate one or more communication signals responsive to instruction by the circuitry, the one or more communication signals associated with a comparison of at least one of the one or more identity sense signals with the one or more authorization parameters or the identity of the at least one individual with the one or more authorization parameters, wherein the reporter includes a display device having one or more light emitting elements configured to provide a predetermined pattern of light corresponding to a comparison between at least one of the one or more identity sense signals with the one or more authorization parameters or the identity of the at least one individual with the one or more authorization parameters, and wherein the predetermined pattern includes a first pattern associated with a correspondence between at least one of the one or more identity sense signals with the one or more authorization parameters or the identity of the at least one individual with the one or more authorization parameters being below a threshold correspondence, and wherein the predetermined pattern includes a second pattern associated with a correspondence between at least one of the one or more identity sense signals with the one or more authorization parameters or the identity of the at least one individual with the one or more authorization parameters being at least at the threshold correspondence.

2. The device of claim 1, wherein the circuitry further includes a comparison module configured to compare the one or more identity sense signals generated by the sensor assembly to reference data indicative of one or more physical characteristics associated with a physical state of the individual to determine whether the individual subject is authorized to operate an external device.

3. The device of claim 1, wherein the one or more identity sensors include at least one of an optical sensor, an electromagnetic sensor, an impedance sensor, or a capacitive sensor.

4. The device of claim 1, wherein the one or more identity sensors include at least one of an electrophysiological sensor, a plethysmographic sensor, a resistive sensor, a biosensor, or a chemical sensor.

5. The device of claim 1, wherein the at least one physical characteristic includes a skin topography feature.

6. The device of claim 5, wherein the skin topography feature includes at least one of a pattern of a skin surface or a follicle pattern.

7. The device of claim 1, wherein the circuitry is configured to determine whether the deformable substrate has been removed from the skin surface of the individual subject.

8. The device of claim 7, wherein the sensor assembly includes at least one of a strain gauge or a proximity sensor configured to sense whether the deformable substrate has been removed from the skin surface of the individual subject.

9. The device of claim 7, wherein the circuitry is configured to determine whether the deformable substrate has been applied to a skin surface that differs from the skin surface of the individual subject.

10. The device of claim 1, wherein the circuitry is configured to disable at least one component of the device responsive to a correspondence between the one or more identity sense signals and the reference data indicative of one or more physical characteristics associated with the identity of the at least one individual being below a threshold correspondence.

11. The device of claim 1, wherein the circuitry is configured to permit operation of at least one component of the identification device responsive to a correspondence between the one or more identity sense signals and the reference data indicative of one or more physical characteristics associated with the identity of the at least one individual being at least at a threshold correspondence.

12. The device of claim 11, wherein the circuitry is configured to activate a power connection to the reporter responsive to the correspondence between the one or more identity sense signals and the reference data indicative of one or more physical characteristics associated with the identity of the at least one individual being at least at the threshold correspondence.

13. The device of claim 1, wherein the one or more communication signals correspond to a lack of authorization of the individual subject to operate an external device responsive to a correspondence between the one or more identity sense signals and the reference data indicative of one or more physical characteristics associated with the identity of the at least one individual being below a threshold correspondence.

14. The device of claim 1, wherein the one or more communication signals correspond to authorization of the individual subject to operate an external device responsive to both of (i) a correspondence between the one or more identity sense signals and the reference data indicative of one or more physical characteristics associated with the identity of the at least one individual being at least at a threshold correspondence and (ii) a correspondence between at least one of the one or more identity sense signals or the identity of the at least one individual with one or more authorization parameters being at least at a threshold correspondence.

15. The device of claim 1, wherein the reporter is configured to generate the one or more communication signals responsive to a proximity between the reporter and an external device.

16. The device of claim 1, wherein the one or more identity sense signals include at least one of an electric current pattern, a photovoltaic current pattern, or a skin resistivity measurement.

17. The device of claim 1, wherein at least one of the reporter, the sensor assembly, or the circuitry includes at least one of a receiver or a transceiver configured to receive one or more communication signals from an external device, wherein the one or more communication signals from an external device are associated with at least one of control programming, reference data, authorization parameters, or a query.

18. The device of claim 1, wherein the at least one physical characteristic includes a vascular layout.

* * * * *

专利名称(译)	利用适形电子设备进行个人识别和授权的系统和方法		
公开(公告)号	US10032109	公开(公告)日	2018-07-24
申请号	US15/232888	申请日	2016-08-10
[标]申请(专利权)人(译)	埃尔瓦有限公司		
申请(专利权)人(译)	ELWHA LLC		
当前申请(专利权)人(译)	ELWHA LLC		
[标]发明人	HYDE RODERICK A KARE JORDIN T MCKNIGHT GARY L PETROSKI ROBERT C SWEENEY ELIZABETH A		
发明人	HYDE, RODERICK A. KARE, JORDIN T. MCKNIGHT, GARY L. PETROSKI, ROBERT C. SWEENEY, ELIZABETH A.		
IPC分类号	G06F21/32 A63B24/00 G09B5/02 G06K19/04 G06K19/077 G06F17/30 G07C9/00 A61B5/00 A61B5/1171		
CPC分类号	G06K19/0776 A61B5/00 A61B5/1171 G06F17/30985 G06K19/07749 G07C9/00015 G07C9/00087 G06K19/041 G07C2009/00095 G07C9/257 G07C9/26 G06F16/90344 G07C9/21		
其他公开文献	US20180046892A1		
外部链接	Espacenet		

摘要(译)

装置实施例包括但不限于可变形基板;传感器组件,包括身份传感器,被配置为生成与个体对象的身体特征相关联的身份感测信号;包括身份比较模块的电路,其被配置为将身份感测信号与指示与至少一个个体的身份相关联的一个或多个身体特征的参考数据进行比较,以确定身份感测信号是否对应于至少一个个体的身份,包括授权比较模块的电路,该授权比较模块被配置为将至少一个身份感测信号或身份与一个或多个授权参数进行比较;报告器,被配置为生成与至少一个身份检测信号与授权参数或与一个或多个授权参数的身份的比较相关联的一个或多个通信信号。

