



US009271672B2

(12) **United States Patent**
Linders et al.

(10) **Patent No.:** **US 9,271,672 B2**
(45) **Date of Patent:** ***Mar. 1, 2016**

(54) **METHOD AND APPARATUS FOR INDICATING THE EMERGENCE OF AN ULCER**

(71) Applicant: **Podimetrics, Inc.**, Cambridge, MA (US)

(72) Inventors: **David Robert Linders**, Somerville, MA (US); **Jonathan David Bloom**, Cambridge, MA (US); **Jeffrey Mark Engler**, Cambridge, MA (US); **Brian Jude Petersen**, Somerville, MA (US); **Adam Geboff**, San Jose, CA (US); **David Charles Kale**, Los Angeles, CA (US)

(73) Assignee: **Podimetrics, Inc.**, Somerville, MA (US)

(*) Notice: Subject to any disclaimer, the term of this patent is extended or adjusted under 35 U.S.C. 154(b) by 105 days.

This patent is subject to a terminal disclaimer.

(21) Appl. No.: **13/799,847**

(22) Filed: **Mar. 13, 2013**

(65) **Prior Publication Data**

US 2013/0261495 A1 Oct. 3, 2013

Related U.S. Application Data

(60) Provisional application No. 61/618,889, filed on Apr. 2, 2012.

(51) **Int. Cl.**
A61B 5/00 (2006.01)
A61B 5/01 (2006.01)

(52) **U.S. Cl.**
CPC **A61B 5/447** (2013.01); **A61B 5/0022** (2013.01); **A61B 5/0075** (2013.01);

(Continued)

(58) **Field of Classification Search**
CPC A61B 5/008; A61B 5/01; A61B 5/015; A61B 5/150954; A61B 2018/00791; A61B 2018/00815; A61B 2015/00821
USPC 600/549, 587, 592, 595
See application file for complete search history.

(56) **References Cited**

U.S. PATENT DOCUMENTS

4,574,359 A 3/1986 Ishizaka et al. 364/557
4,592,000 A 5/1986 Ishizaka et al. 364/557

(Continued)

FOREIGN PATENT DOCUMENTS

CN 1308225 8/2001 G01K 3/00
CN 201312800 9/2009 A61B 5/00

(Continued)

OTHER PUBLICATIONS

Tamura et al., "A bed temperature monitoring system for assessing body movement during sleep," Clin. Phys. Physiol. Meas., 1988, vol. 9, No. 2, 139-145.*

(Continued)

Primary Examiner — Rene Towa

(74) *Attorney, Agent, or Firm* — Sunstein Kann Murphy & Timbers LLP

(57) **ABSTRACT**

A method of monitoring a patient's foot forms a thermogram of the sole of at least one foot of the patient, and determines whether the thermogram presents at least one of a plurality of prescribed patterns. The method also compares the thermogram against a prior thermogram of the same foot, and produces output information indicating the emergence of an ulcer on a given portion on the at least one foot as a function of 1) whether the thermogram is determined to present the at least one pattern, and 2) the comparison with the prior thermogram, which shows non-ulcerated tissue at the given location.

33 Claims, 15 Drawing Sheets

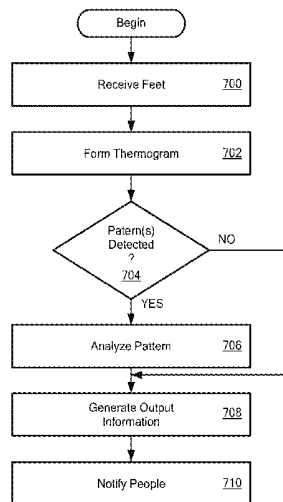

(52) U.S. Cl.

CPC *A61B 5/0077* (2013.01); *A61B 5/015*
(2013.01); *A61B 5/445* (2013.01); *A61B*
5/6807 (2013.01); *A61B 5/706* (2013.01);
A61B 5/7275 (2013.01); *A61B 5/7282*
(2013.01); *A61B 5/7425* (2013.01); *A61B*
5/0008 (2013.01); *A61B 2562/0276* (2013.01);
A61B 2576/02 (2013.01)

(56)

References Cited

U.S. PATENT DOCUMENTS

4,629,336 A	12/1986	Ishizaka	374/169
4,647,918 A	3/1987	Goforth	340/573
4,648,055 A	3/1987	Ishizaka et al.	164/557
4,843,577 A	6/1989	Muramoto	364/557
4,866,621 A	9/1989	Ono	364/413.03
4,878,184 A	10/1989	Okada et al.	364/557
5,011,294 A	4/1991	Yamaguchi	374/107
5,015,102 A	5/1991	Yamaguchi	374/107
5,066,141 A	11/1991	Ikeda et al.	374/169
5,259,389 A	11/1993	Muramoto et al.	128/736
5,473,629 A	12/1995	Muramoto	374/102
5,642,096 A	6/1997	Leyerer et al.	340/573
5,678,566 A	10/1997	Dribbon	128/779
5,929,332 A	7/1999	Brown	73/172
6,090,050 A	7/2000	Constantinides	600/549
6,195,921 B1	3/2001	Truong	36/136
6,398,740 B1	6/2002	Lavery et al.	600/549
6,767,330 B2	7/2004	Lavery et al.	600/549
6,807,869 B2	10/2004	Farrington et al.	73/862.046
6,963,772 B2	11/2005	Bloom et al.	600/547
7,052,472 B1	5/2006	Miller et al.	600/549
7,167,734 B2	1/2007	Khalil et al.	600/310
7,206,718 B2	4/2007	Cavanagh et al.	702/155
7,318,004 B2	1/2008	Butterfield	702/130
7,637,657 B2	12/2009	Yamamoto et al.	374/169
7,716,005 B2	5/2010	Shoureshi et al.	702/131
7,726,206 B2	6/2010	Terrafranca, Jr. et al.	73/862.041
7,758,523 B2	7/2010	Collings et al.	600/592
8,360,987 B2	1/2013	Kantro et al.	600/549
2002/0082486 A1	6/2002	Lavery et al.	600/300
2006/0021261 A1	2/2006	Face	36/132
2006/0030783 A1	2/2006	Tsai et al.	600/547
2007/0038273 A1	2/2007	Bales et al.	607/88
2007/0039211 A1	2/2007	Pichler	36/140
2007/0043408 A1	2/2007	Winnett et al.	607/96
2008/0214962 A1	9/2008	Kantro et al.	600/592
2008/0238660 A1*	10/2008	Dayton et al.	340/539.14
2009/0219972 A1	9/2009	Carlsson et al.	374/137
2009/0306801 A1	12/2009	Sivak et al.	700/98
2010/0004566 A1	1/2010	Son et al.	600/592
2010/0041998 A1	2/2010	Postel	600/475
2010/0198022 A1	8/2010	Vuillerme et al.	600/301
2010/0268111 A1	10/2010	Drinan et al.	600/547
2010/0324455 A1	12/2010	Rangel et al.	600/592
2011/0015498 A1	1/2011	Mestrovic et al.	600/301
2011/0214501 A1	9/2011	Ross et al.	73/172
2011/0275956 A1	11/2011	Son et al.	600/592
2011/0313314 A1	12/2011	Gefen	600/555
2012/0109013 A1	5/2012	Everett et al.	600/587
2012/0190989 A1	7/2012	Kaiser et al.	600/476
2012/0221286 A1	8/2012	Bisch et al.	702/131
2013/0019503 A1	1/2013	Vogt	36/103

FOREIGN PATENT DOCUMENTS

CN	202263087	6/2012	A61F 7/00
DE	202010013176	3/2011	A61B 5/107
EP	0885587	12/1998	A61B 5/00
JP	55071919	5/1980	G01K 1/02
JP	2009539454	11/2009	A61B 5/00
KR	101027367	4/2011	A61B 5/145
RU	2433783	11/2011	A61B 5/01
WO	WO 2007/114768	10/2007	G01K 11/12
WO	WO 2008/058051	5/2008	G01K 13/00
WO	WO 2009/005373	1/2009	A61B 5/01
WO	WO 2010/021932	2/2010	A61B 5/00
WO	WO 2012/051394	4/2012	G01N 21/00
WO	WO 2012/084814	6/2012	A43B 7/14

OTHER PUBLICATIONS

- Caselli, M.D. et al., "The Forefoot-to-Rearfoot Plantar Pressure Ratio is Increased in Severe Diabetic Neuropathy and Can Predict Foot Ulceration," *Diabetes Care*, vol. 25, No. 6, pp. 1066-1071, Jun. 2002.
- Dabiri et al., "Electronic Orthotics Shoe: Preventing Ulceration in Diabetics Patients," 30th Annual International IEEE EMBS Conference, pp. 771-774, Aug. 2008.
- Medgadget.com, "TempTouch for Foot Ulcer Detection," Xilas, Inc., 2 pages, Apr. 19, 2005.
- Morley et al., "In-Shoe Multisensory Data Acquisition System," *IEEE Transactions on Biomedical Engineering*, vol. 48, No. 7, pp. 815-820, Jul. 2001.
- Bharara et al., "Coming events cast their shadows before: detecting inflammation in the acute diabetic foot and the foot in remission," *Diabetes/Metabolism Research and Reviews*, vol. 28, pp. 15-20, 2012.
- Brioschi et al., "Automated Computer Diagnosis of IR Medical Imaging," FLIR Technical Series, Application Note for Research & Science, FLIR Systems, Inc., 6 pages, 2011.
- Chen et al., "Development of a Thermal and Hyperspectral Imaging System for Wound Characterization and Metabolic Correlation," *John Hopkins Apl Technical Digest*, vol. 26, No. 1, pp. 67-74, 2005.
- Kaabouch et al., "Predicting neuropathic ulceration: analysis of static temperature distributions in thermal images," *Journal of Biomedical Optics*, vol. 15, No. 6, pp. 061715-1-061715-6, 2010.
- Liu et al., "Infrared Dermal Thermography on Diabetic Feet Soles to Predict Ulcerations: a Case Study," *Proc. of SPIE*, vol. 8572, pp. 85720N-1-85720N-9, 2013.
- Korean Intellectual Property Office, International Search Report—International Application No. PCT/US2013/030997, dated Jul. 8, 2013, together with the Written Opinion of the International Searching Authority, 13 pages.
- Liu et al., "Statistical analysis of spectral data: a methodology for designing an intelligent monitoring system for the diabetic foot," *Predicting neuropathic ulceration: analysis of static temperature distributions in thermal images*, *Journal of Biomedical Optics*, vol. 18(12), pp. 126004-1-126004-11, Dec. 2013.
- Van Netten et al., "Infrared Thermal Imaging for Automated Detection of Diabetic Foot Complications," *Journal of Diabetes Science and Technology*, vol. 7, Issue 5, pp. 1122-1129, Sep. 2013.
- European Patent Office, Supplementary European Search Report—Application No. EP 13 77 2800, dated Jun. 26, 2015, 7 pages.

* cited by examiner

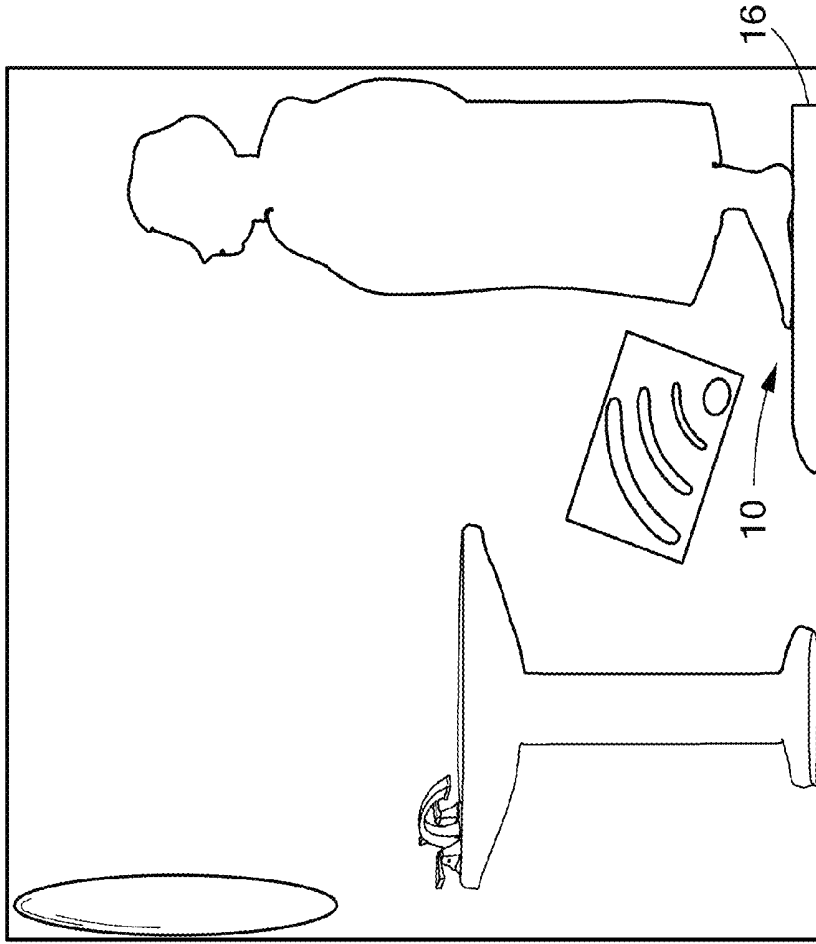

FIG. 2A

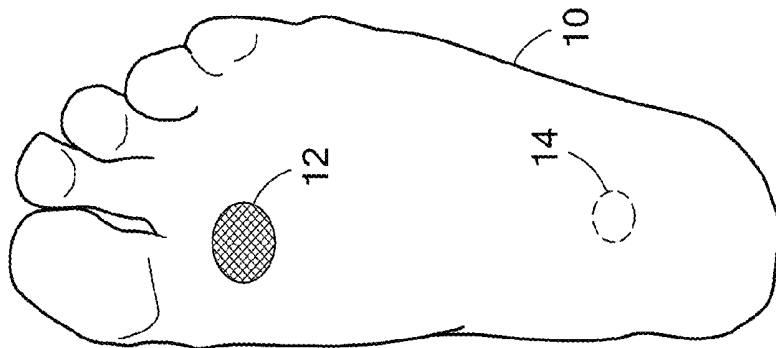

FIG. 1

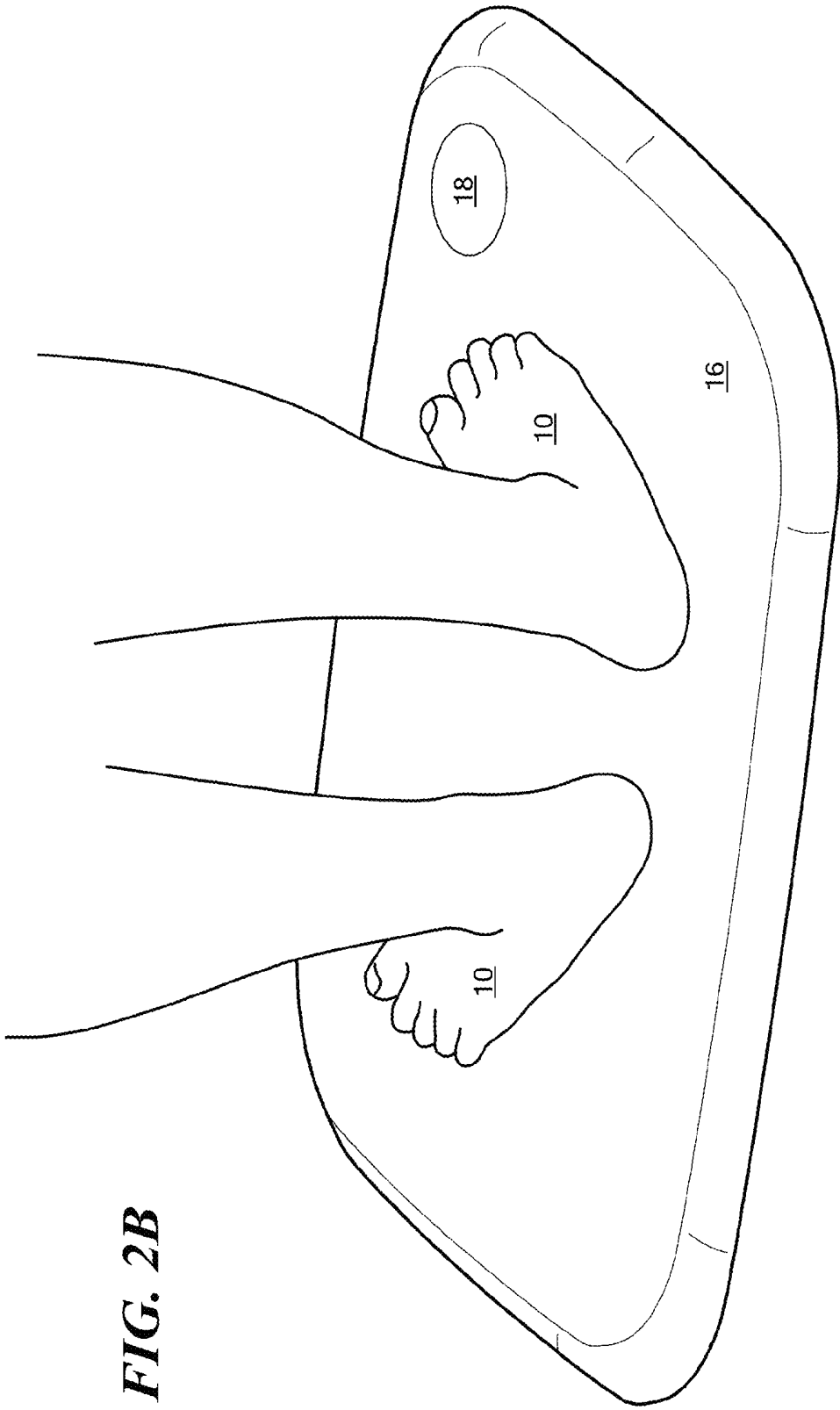

FIG. 2B

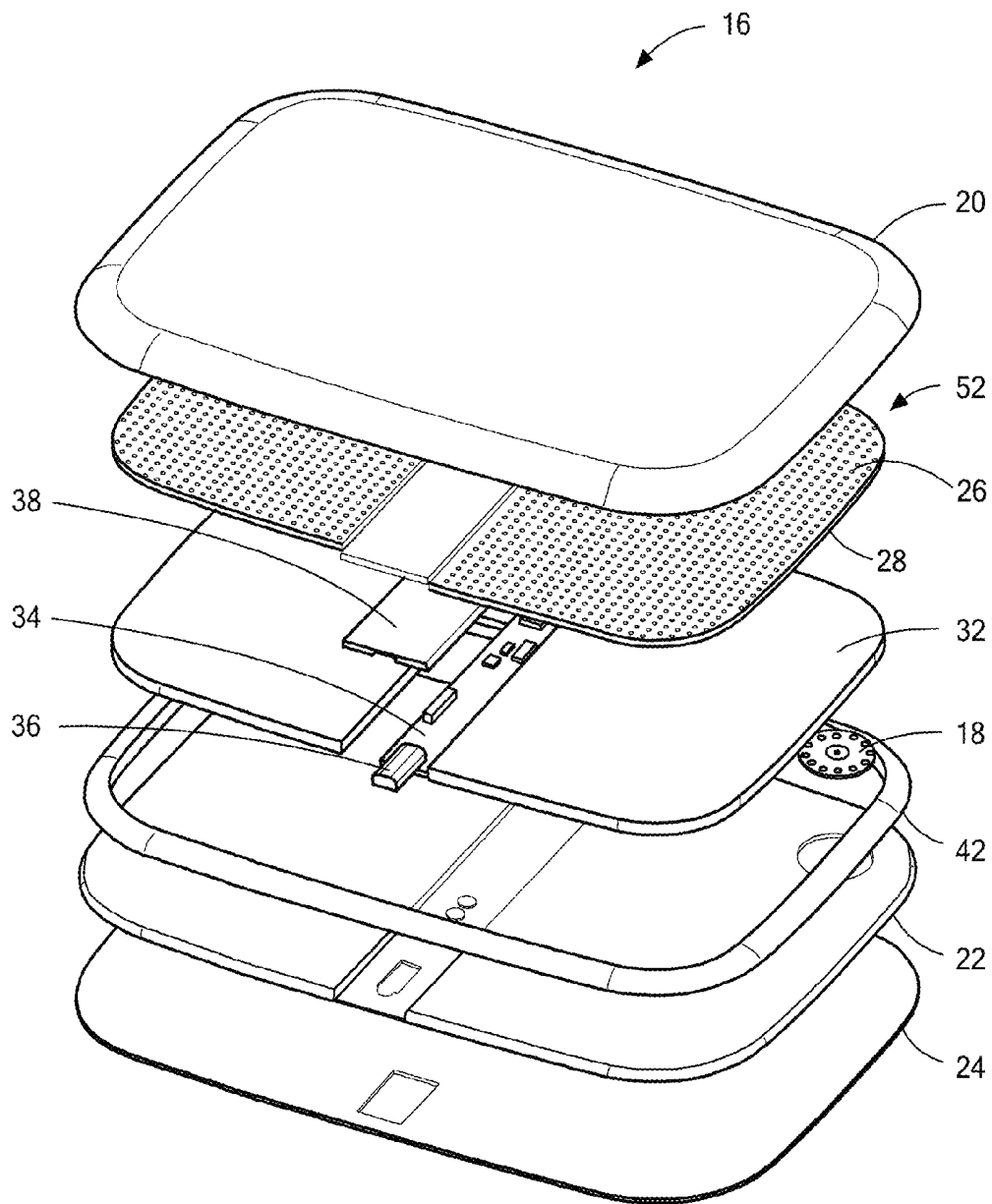

FIG. 3A

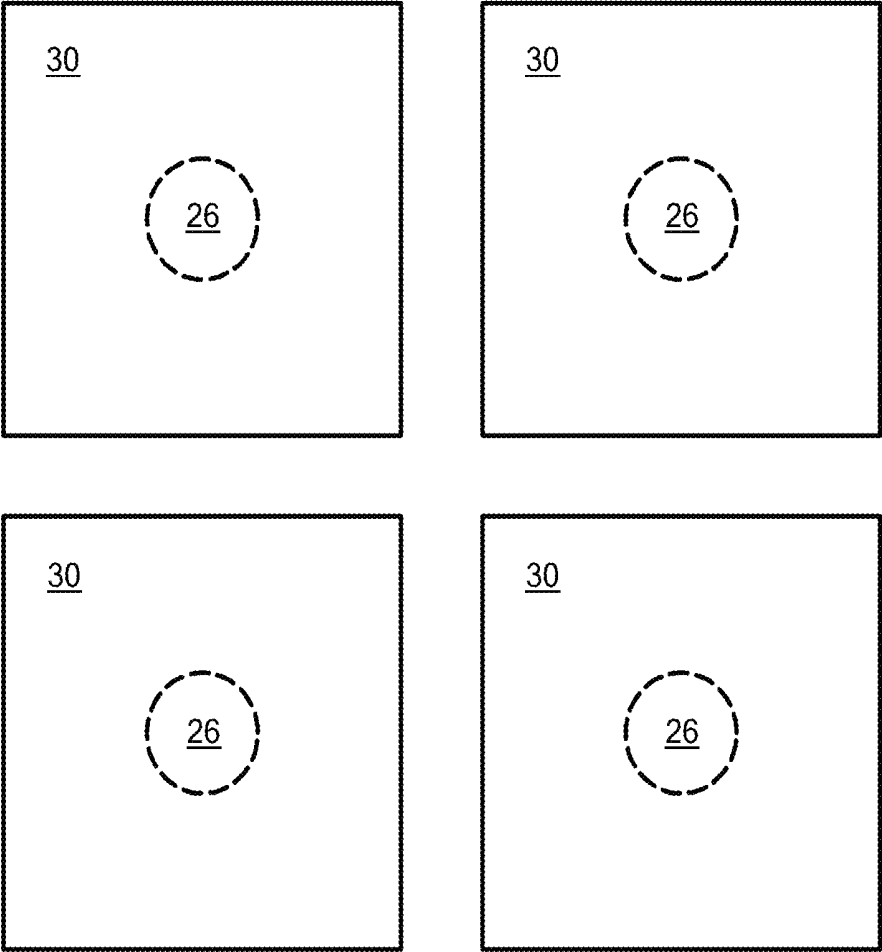

FIG. 3B

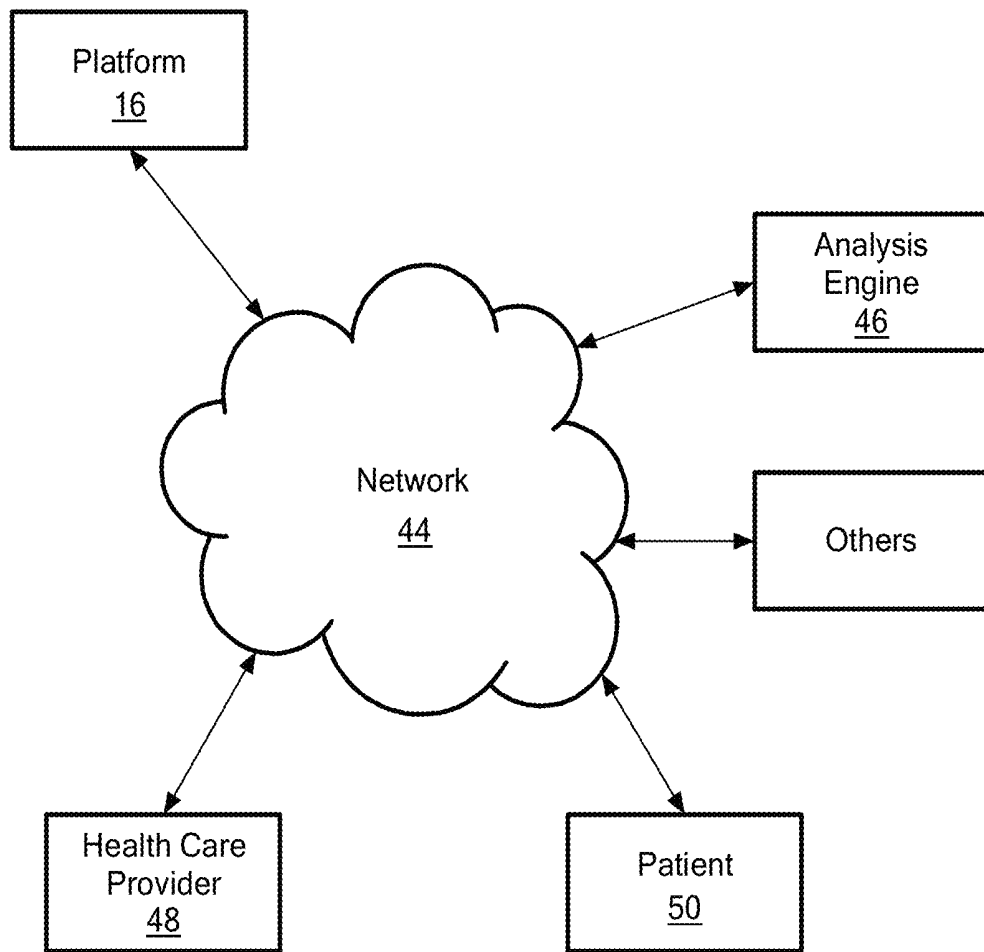

FIG. 4

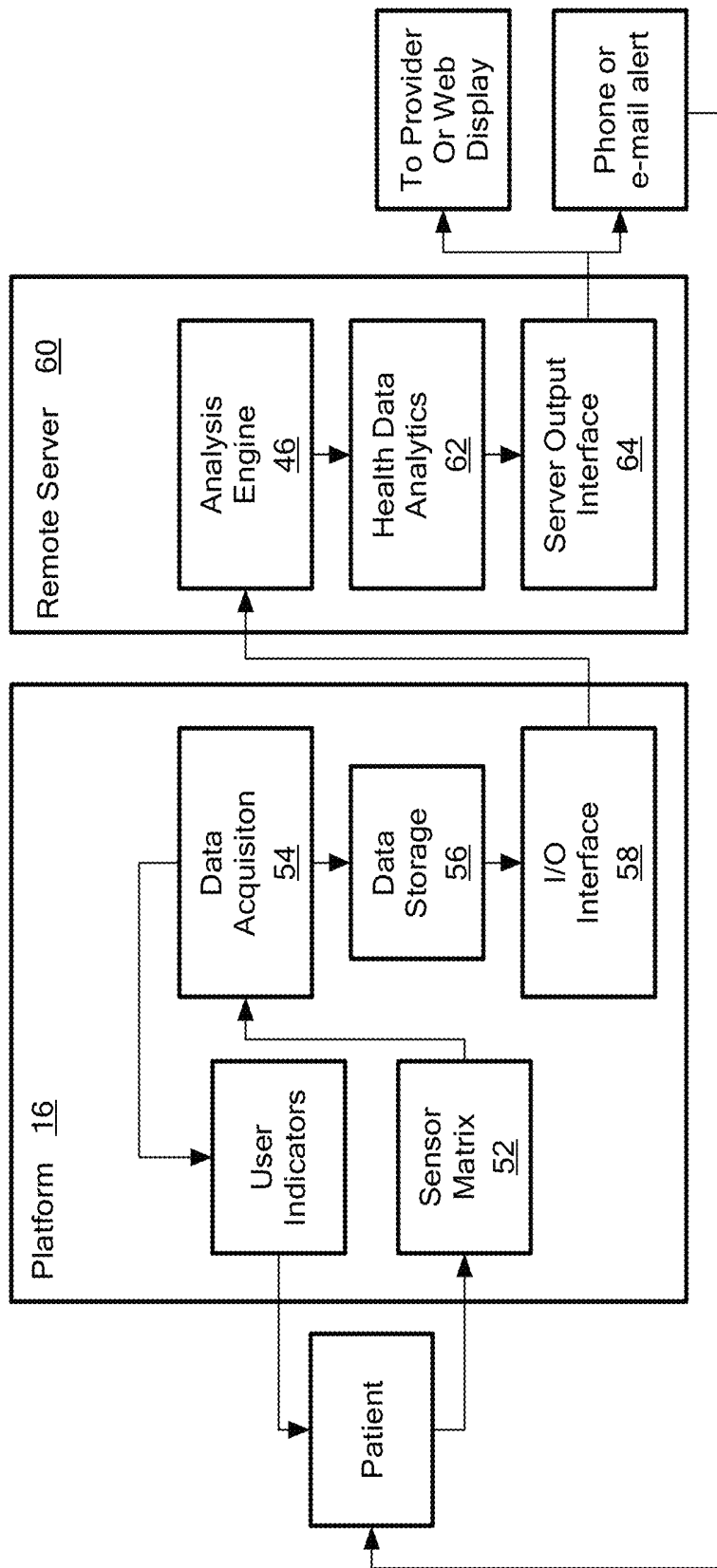

FIG. 5

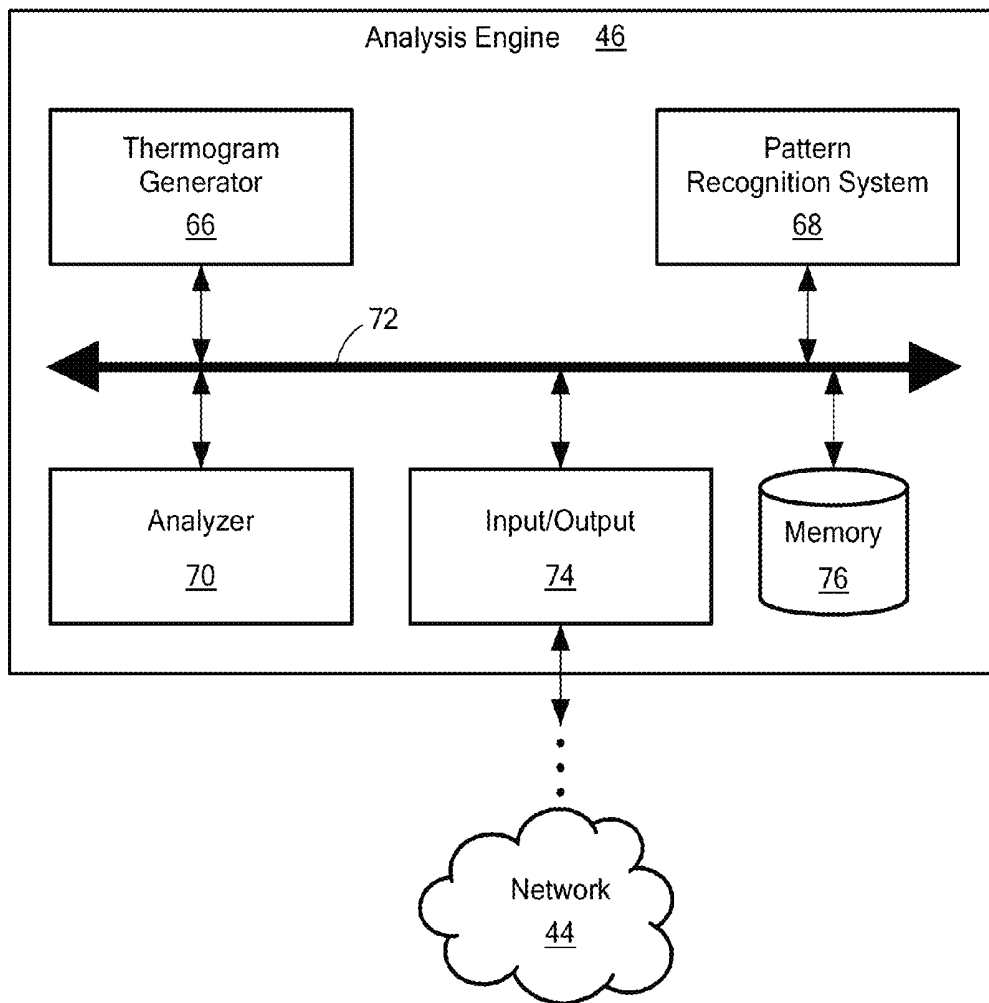

FIG. 6

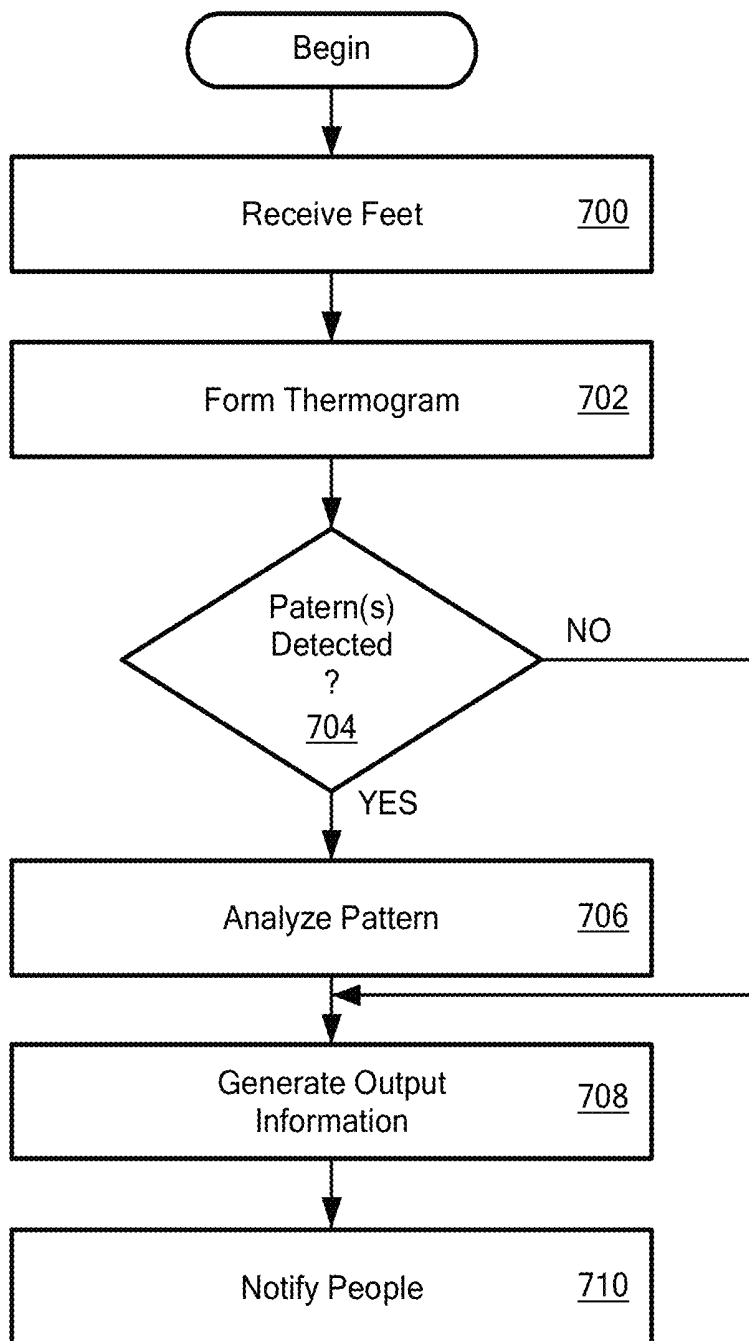

FIG. 7

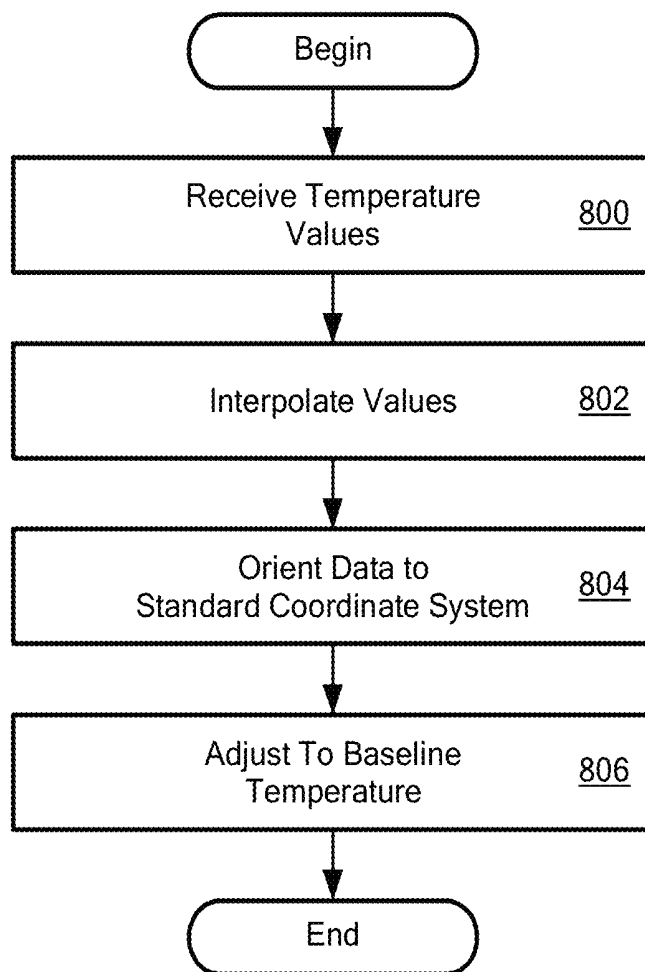

FIG. 8

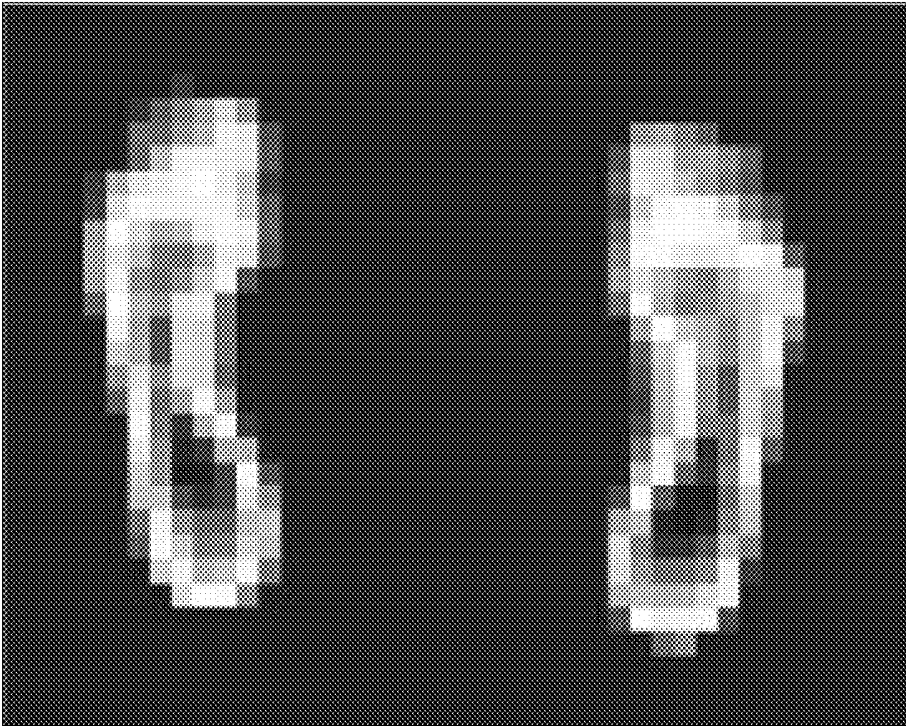

FIG. 9A



FIG. 9B

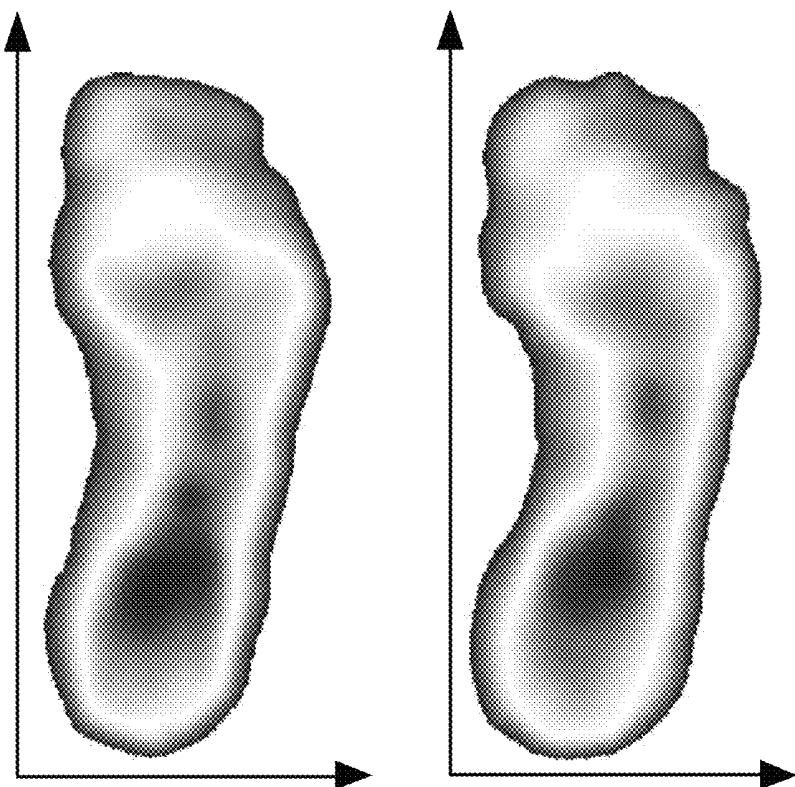

FIG. 9C

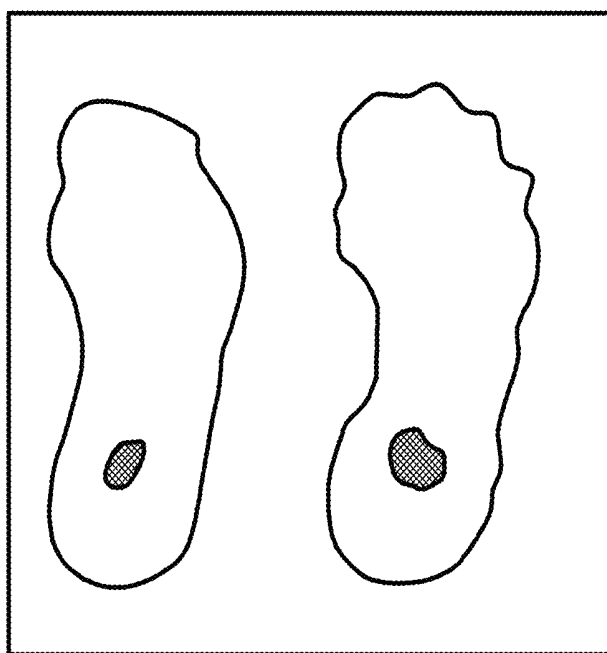

FIG. 9D

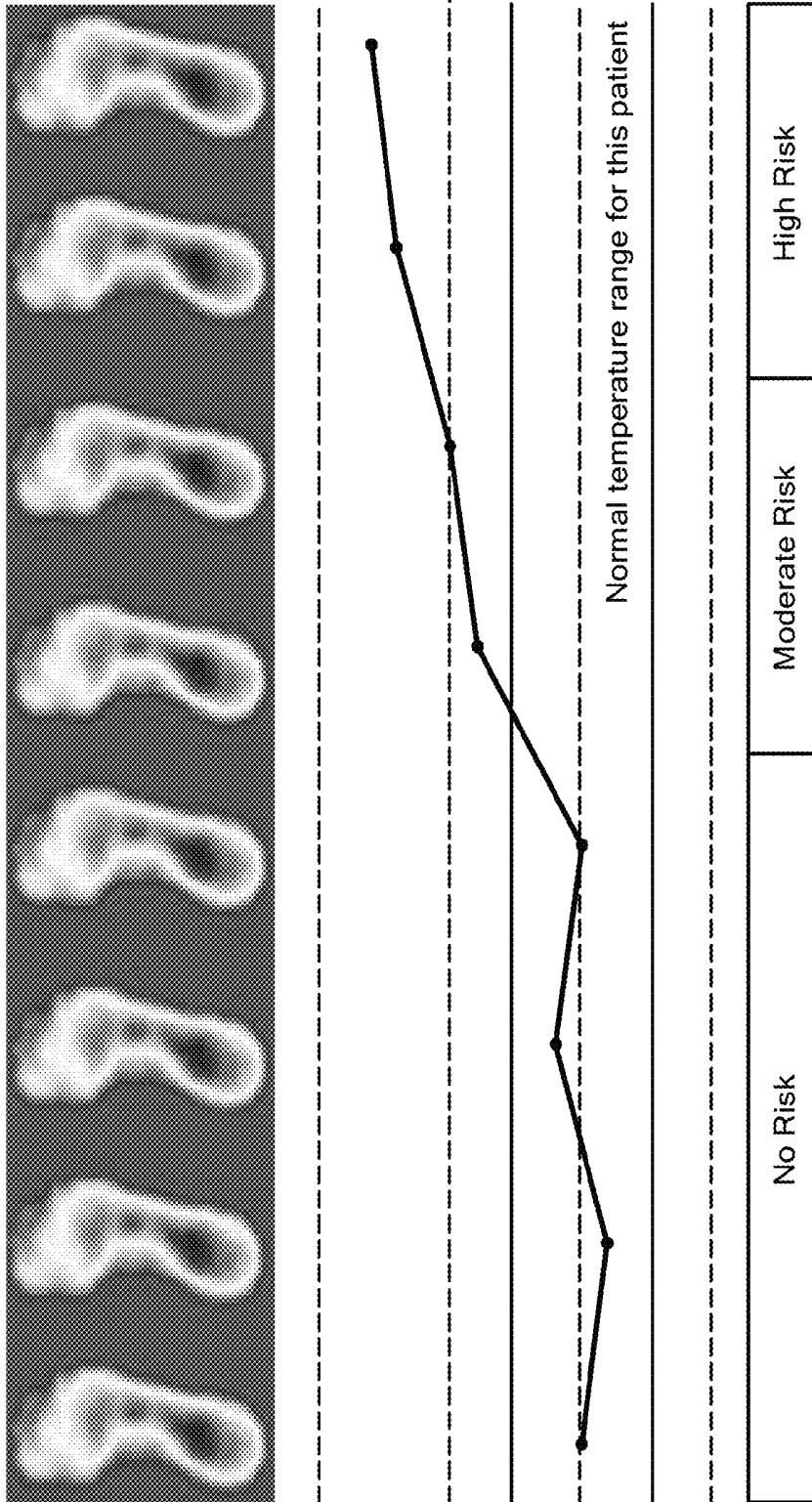

FIG. 10A

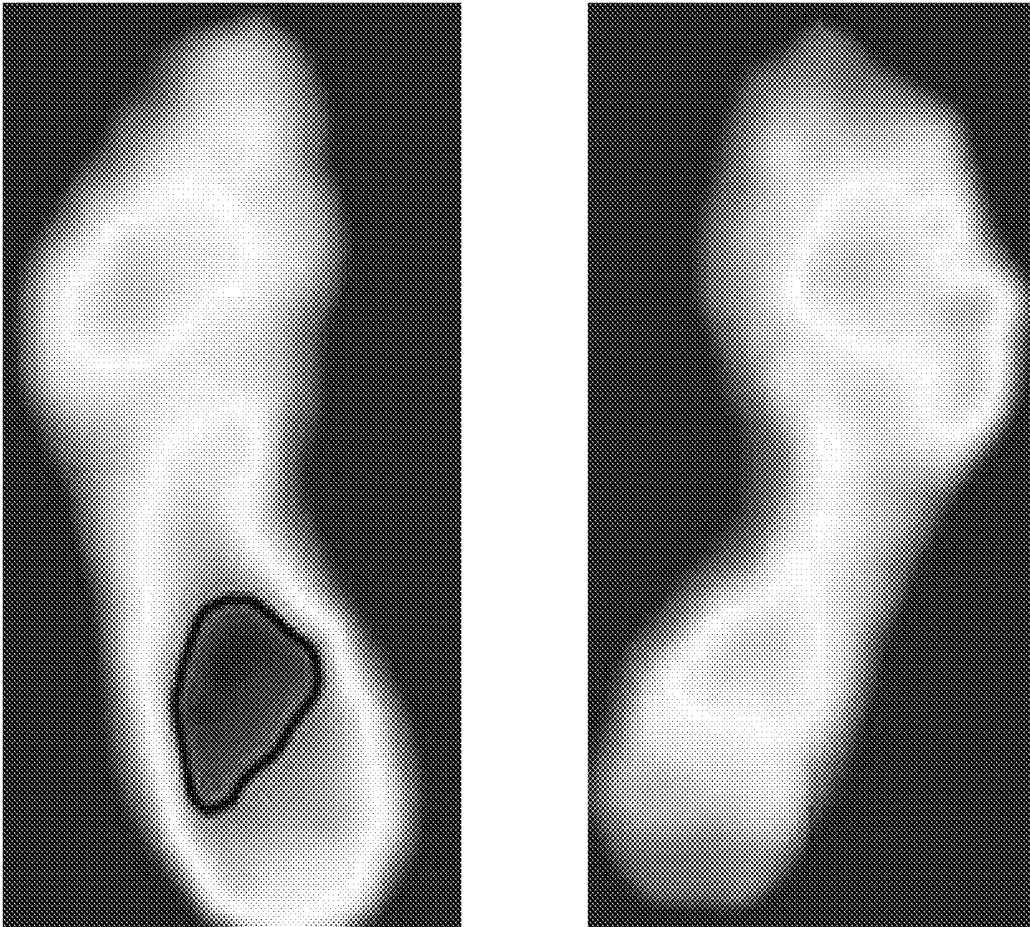

FIG. 10B

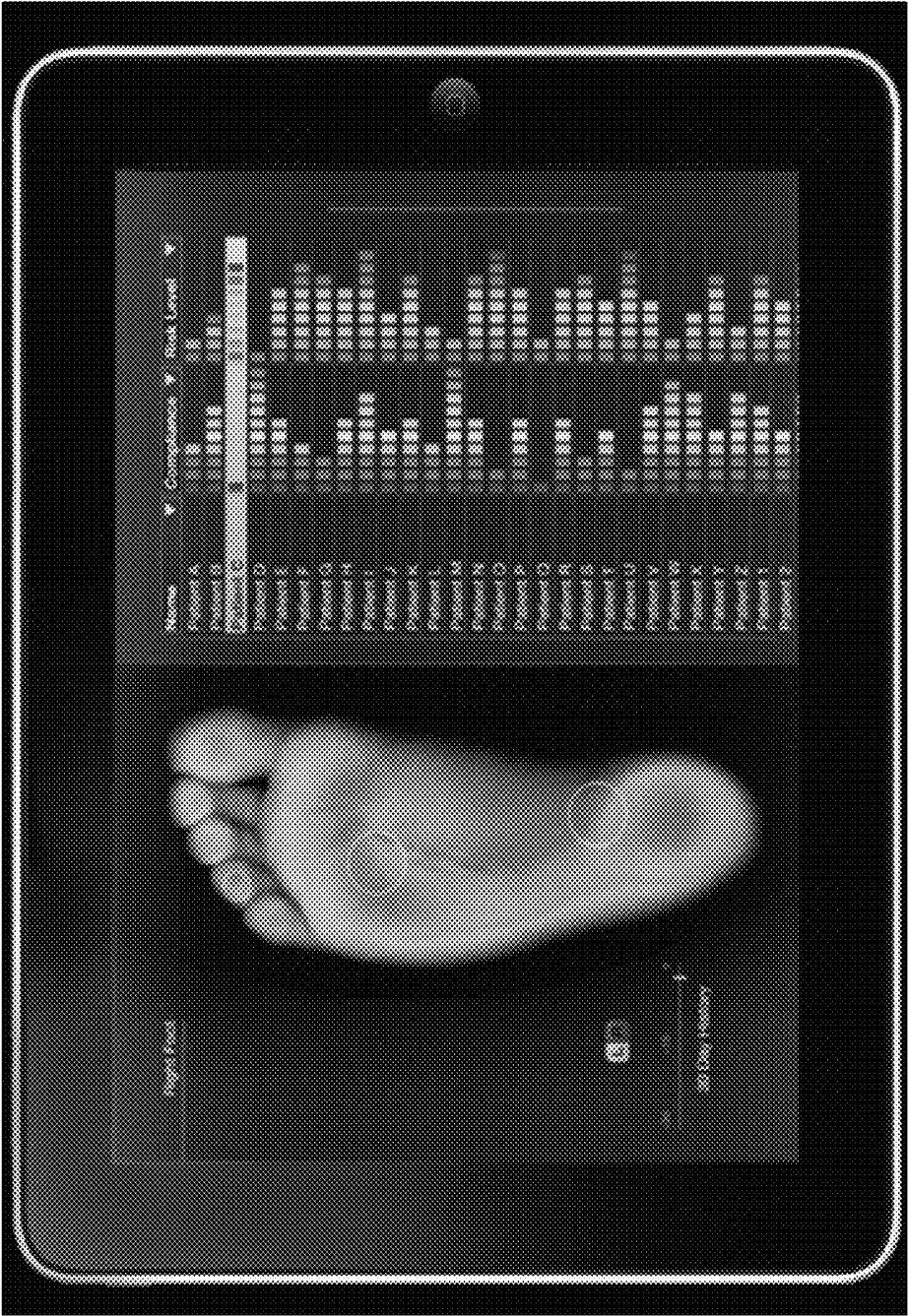

FIG. 11A

Patient	Last Checked	Risk Level
Patient A	1/2/12 12:00	20%
Patient B	1/6/12 2:10	35%
Patient C	1/5/12 3:00	80%
Patient D	1/5/12 6:30	40%
Patient E	1/5/12 5:00	25%
Patient F	1/3/12 11:00	35%
Patient G	1/4/12 7:30	30%
Patient H	1/5/12 5:00	40%

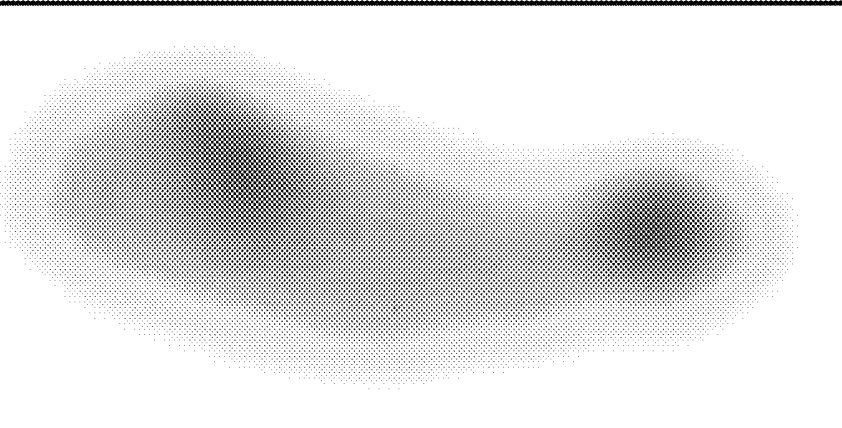

FIG. 11B

METHOD AND APPARATUS FOR INDICATING THE EMERGENCE OF AN ULCER

PRIORITY

This patent application claims priority from provisional U.S. patent application No. 61/618,889, filed Apr. 2, 2012, entitled, "AUTONOMOUS METHOD FOR PREDICTING MEDICAL CONDITIONS IN MAMMALS," and naming Jonathan David Bloom, David Robert Linders, Jeffrey Mark Engler, David Charles Kale, and Adam Geboff as inventors, the disclosure of which is incorporated herein, in its entirety, by reference.

RELATED APPLICATIONS

This patent application is related to the following utility patent applications, each of which is incorporated herein, in its entirety, by reference:

1. U.S. patent application Ser. No. 13/803,866, filed on Mar. 14, 2013, entitled, "METHOD AND APPARATUS FOR INDICATING THE EMERGENCE OF A PRE-ULCER AND ITS PROGRESSION," and naming Jonathan David Bloom, David Robert Linders, Jeffrey Mark Engler, Brian Petersen, David Charles Kale, and Adam Geboff as inventors, and

2. U.S. patent application Ser. No. 13/799,828, filed on even date herewith, entitled, "METHOD AND APPARATUS FOR INDICATING THE RISK OF AN EMERGING ULCER," and naming Jonathan David Bloom, David Robert Linders, Jeffrey Mark Engler, Brian Petersen, David Charles Kale, and Adam Geboff as inventors.

FIELD OF THE INVENTION

The invention generally relates to ulcers on living beings and, more particularly, the invention relates to evaluating portions of living beings for ulcers.

BACKGROUND OF THE INVENTION

Open sores on an external surface of the body often form septic breeding grounds for infection, which can lead to serious health complications. For example, foot ulcers on the bottom of a diabetic's foot can lead to gangrene, leg amputation, or, in extreme cases, death. The healthcare establishment therefore recommends monitoring a diabetic's foot on a regular basis to avoid these and other dangerous consequences. Unfortunately, known techniques for monitoring foot ulcers, among other types of ulcers, often are inconvenient to use, unreliable, or inaccurate, thus reducing compliance by the very patient populations that need it the most.

SUMMARY OF VARIOUS EMBODIMENTS

In accordance with one embodiment of the invention, a method of monitoring a patient's foot forms a thermogram of the sole of at least one foot of the patient, and determines whether the thermogram presents at least one of a plurality of prescribed patterns. The method also compares the thermogram against a prior thermogram of the same foot, and produces output information indicating the emergence of an ulcer on a given portion on the at least one foot as a function of 1) whether the thermogram is determined to present the at

least one pattern, and 2) the comparison with the prior thermogram, which shows non-ulcerated tissue at the given location.

Although it may show non-ulcerated tissue at a given location, the prior thermogram may show a pre-ulcer at that same location.

Moreover, the method may provide an open platform for receiving at least one foot or both feet. Among other things, the open platform may have at least one temperature sensor for generating a plurality of temperature data values after receipt of the at least one foot. The open platform may be in the form of a floor mat. The plurality of temperature sensors (e.g., stationary and/or contact sensors) illustratively are at discrete locations on the foot. Accordingly a thermogram may be formed by interpolating temperature data between at least two of the plurality of temperature sensors to produce approximate and physically continuous temperature readings at locations that are between the sensors. The sensors may be contact sensors and/or be stationary.

Moreover, the platform may have a receiving area for receiving the at least one foot, and/or for positioning both feet. The receiving area has a surface area that is greater than the surface area of the at least one foot. Accordingly, the thermogram can have data for substantially the entirety of the sole. In addition, unlike isotherms, the thermogram typically is expected to have data showing substantially continuous two-dimensional spatial temperature variations across portions of the at least one foot.

To indicate the emergence of an ulcer, the method may use any of a number of different patterns. One shows a deviation in two portions of the same foot, while a second shows a deviation in corresponding portions of the patient's two feet. Another pattern shows a deviation in one portion of the same foot over time. The deviation may be a temperature deviation (e.g., about 4 degrees F.) at or across the specified foot geography.

In addition to having any of a variety of different form factors, the open platform often does not necessarily visually display the thermogram. Instead, its data often is used to determine the emergence of a new ulcer without the need to display the thermogram. Moreover, some embodiments determine the orientation of the at least one foot to produce orientation information, and then use that orientation information to determine whether the thermogram presents at least one of a plurality of prescribed patterns.

Some embodiments forward, across a network, a data message having the temperature data representing the thermogram. In response, some embodiments may receive a risk message, also from the network, having the output information. Among other things, output information may include information for displaying quantitative indicia indicating the emergence of an ulcer.

Some embodiments form the thermogram by receiving a thermogram message (having temperature data of the sole) through a network from an open platform, and forming the thermogram from the temperature data in the thermogram message. For example, the thermogram may be formed by interpolating the received temperature data.

In accordance with other embodiments of the invention, an apparatus for monitoring a patient's foot has a thermogram generator configured to form a thermogram of the sole of at least one foot of the patient, and a pattern recognition system (operatively coupled with the thermogram generator) configured to determine whether the thermogram presents at least one of a plurality of prescribed patterns. The apparatus also has a comparator (operatively coupled with the pattern recognition system) configured to compare the thermogram

against a prior thermogram of the same foot, and an analyzer (operatively coupled with the comparator) configured to produce output information indicating the emergence of an ulcer on a given portion on the at least one foot as a function of 1) whether the thermogram is determined to present the at least one pattern, and 2) the comparison with the prior thermogram, which shows non-ulcerated tissue at the given location.

Illustrative embodiments of the invention are implemented as a computer program product having a computer usable medium with computer readable program code thereon. The computer readable code may be read and utilized by a computer system in accordance with conventional processes.

BRIEF DESCRIPTION OF THE DRAWINGS

Those skilled in the art should more fully appreciate advantages of various embodiments of the invention from the following "Description of Illustrative Embodiments," discussed with reference to the drawings summarized immediately below.

FIG. 1 schematically shows a foot having a prominent foot ulcer and a pre-ulcer.

FIG. 2A schematically shows one use and form factor that may be implemented in accordance with illustrative embodiments of the invention.

FIG. 2B schematically shows an open platform that may be configured in accordance with illustrative embodiments of the invention.

FIG. 3A schematically shows an exploded view of one type of open platform that may be configured in accordance with illustrative embodiments of the invention.

FIG. 3B schematically shows a close up view of the platform with details of the pads and temperature sensors.

FIG. 4 schematically shows a network implementing of illustrative embodiments of the invention.

FIG. 5 schematically shows an overview of various components of illustrative embodiments of the invention.

FIG. 6 schematically shows details of a data processing module in accordance with illustrative embodiments of the invention.

FIG. 7 shows a process of monitoring the health of the patient's foot or feet in accordance with illustrative embodiments of the invention.

FIG. 8 shows a process of forming a thermogram in accordance with illustrative embodiments of the invention.

FIGS. 9A-9D schematically show the progression of the thermogram and how it is processed in accordance with one embodiment of the invention.

FIGS. 10A and 10B schematically show two different types of patterns that may be on the soles of a patient's foot indicating an ulcer or pre-ulcer.

FIGS. 11A and 11B schematically show two different user interfaces that may be displayed in accordance with illustrative embodiments of the invention.

DESCRIPTION OF ILLUSTRATIVE EMBODIMENTS

In illustrative embodiments, a method and apparatus analyze a patient's foot to determine the whether a new ulcer has emerged on its underside (i.e., on its sole). This permits patients, their healthcare providers, and/or their caregivers to intervene earlier, reducing the risk of more serious complications. To that end, an open platform receives the patient's foot and generates temperature data that is processed to form a thermogram. If the thermogram presents at least one of a number of prescribed patterns, then various embodiments

produce output information indicating the emergence of an ulcer on the patient's foot. Details of illustrative embodiments are discussed below.

FIG. 1 schematically shows a bottom view of a patient's foot **10** that, undesirably, has an ulcer **12** and a pre-ulcer **14** (described below and shown in phantom since pre-ulcers **14** do not break through the skin). As one would expect, an ulcer **12** on this part of the foot **10** typically is referred to as a "foot ulcer **12**." Generally speaking, an ulcer is an open sore on a surface of the body generally caused by a breakdown in the skin or mucous membrane. Diabetics often develop foot ulcers **12** on the soles of their feet **10** as part of their disease. In this setting, foot ulcers **12** often begin as a localized inflammation that may progress to skin breakdown and infection.

It should be noted that discussion of diabetes and diabetics is but one example and used here simply for illustrative purposes only. Accordingly, various embodiments apply to other types of diseases (e.g., stroke, deconditioning, sepsis, friction, coma, etc . . .) and other types of ulcers—such embodiments may apply generally where there is a compression or friction on the living being's body over an extended period of time. For example, various embodiments also apply to ulcers formed on different parts of the body, such as on the back (e.g., bedsores), inside of prosthetic sockets, or on the buttocks (e.g., a patient in a wheel chair). Moreover, illustrative embodiments apply to other types of living beings beyond human beings, such as other mammals (e.g., horses or dogs). Accordingly, discussion of diabetic human patients having foot ulcers **12** is for simplicity only and not intended to limit all embodiments of the invention.

Many prior art ulcer detection technologies known to the inventors suffered from one significant problem—patient compliance. If a diseased or susceptible patient does not regularly check his/her feet **10**, then that person may not learn of an ulcer **12** or a pre-ulcer **14** until it has emerged through the skin and/or requires significant medical treatment. Accordingly, illustrative embodiments implement an ulcer monitoring system in any of a variety of forms—preferably in an easy to use form factor that facilitates and encourages regular use.

FIGS. 2A and 2B schematically show one form factor, in which a patient/user steps on an open platform **16** that gathers data about that user's feet **10**. In this particular example, the open platform **16** is in the form of a floor mat placed in a location where he the patient regularly stands, such as in front of a bathroom sink, next to a bed, in front of a shower, on a footrest, or integrated into a mattress. As an open platform **16**, the patient simply may step on the top sensing surface of the platform **16** to initiate the process. Accordingly, this and other form factors favorably do not require that the patient affirmatively decide to interact with the platform **16**. Instead, many expected form factors are configured to be used in areas where the patient frequently stands during the course of their day without a foot covering. Alternatively, the open platform **16** may be moved to directly contact the feet **10** of a patient that cannot stand. For example, if the patient is bedridden, then the platform **16** may be brought into contact with the patient's feet **10** while in bed.

A bathroom mat or rug are but two of a wide variety of different potential form factors. Others may include a platform **16** resembling a scale, a stand, a footrest, a console, a tile built into the floor, or a more portable mechanism that receives at least one of the feet **10**. The implementation shown in FIGS. 2A and 2B has a top surface area that is larger than the surface area of one or both of the feet **10** of the patient.

This enables a caregiver to obtain a complete view of the patient's entire sole, providing a more complete view of the foot 10.

The open platform 16 also has some indicia or display 18 on its top surface they can have any of a number of functions. For example, the indicia can turn a different color or sound an alarm after the readings are complete, show the progression of the process, or display results of the process. Of course, the indicia or display 18 can be at any location other than on the top surface of the open platform 16, such as on the side, or a separate component that communicates with the open platform 16. In fact, in addition to, or instead of, using visual or audible indicia, the platform 16 may have other types of indicia, such as tactile indicia/feedback, or thermal indicia.

Rather than using an open platform 16, alternative embodiments may be implemented as a closed platform 16, such as a shoe or sock that can be regularly worn by a patient, or worn on an as-needed basis. For example, the insole of the patient's shoe or boot may have the functionality for detecting the emergence of a pre-ulcer 14 or ulcer 12, and/or monitoring a pre-ulcer 14 or ulcer 12.

To monitor the health of the patient's foot (discussed in greater detail below), the platform 16 of FIGS. 2A and 2B gathers temperature data about a plurality of different locations on the sole of the foot 10. This temperature data provides the core information ultimately used to determine the health of the foot 10. FIG. 3 schematically shows an exploded view of the open platform 16 configured and arranged in accordance with one embodiment of the invention. Of course, this embodiment is but one of a number of potential implementations and, like other features, is discussed by example only.

As shown, the platform 16 is formed as a stack of functional layers sandwiched between a cover 20 and a rigid base 22. For safety purposes, the base preferably has rubberized or has other non-skid features on its bottom side. FIG. 3 shows one embodiment of this non-skid feature as a non-skid base 24. The platform 16 preferably has relatively thin profile to avoid tripping the patient and making it easy to use.

To measure foot temperature, the platform 16 has an array or matrix of temperature sensors 26 fixed in place directly underneath the cover 20. More specifically, the temperature sensors 26 are positioned on a relatively large printed circuit board 28. The sensors 26 preferably are laid out in a two-dimensional array/matrix of stationary contact sensors on the printed circuit board 28. The pitch or distance between the preferably is relatively small, thus permitting more temperature sensors 26 on the array. Among other things, the temperature sensors 26 may include temperature sensitive resistors (e.g., printed or discrete components mounted onto the circuit board 28), thermocouples, fiberoptic temperature sensors, or a thermochromic film. Accordingly, when used with temperature sensors 26 that require direct contact, illustrative embodiments form the cover 20 with a thin material having a relatively high thermal conductivity. The platform 16 also may use temperature sensors 26 that can still detect temperature through a patient's socks.

Other embodiments may use noncontact temperature sensors 26, such as infrared detectors. Indeed, in that case, the cover 20 may have openings to provide a line of sight from the sensors 26 to the sole of the foot 10. Accordingly, discussion of contact sensors is by example only and not intended to limit various embodiments. As discussed in greater detail below and noted above, regardless of their specific type, the plurality of sensors 26 generate a plurality of corresponding temperature data values for a plurality of portions/spots on the patient's foot 10 to monitor the health of the foot 10.

Some embodiments also may use pressure sensors for various functions, such as to determine the orientation of the feet 10 and/or to automatically begin the measurement process. Among other things, the pressure sensors may include piezoelectric, resistive, capacitive, or fiber-optic pressure sensors. This layer of the platform 16 also may have additional sensor modalities beyond temperature sensors 26 and pressure sensors, such as positioning sensors, GPS sensors, accelerometers, gyroscopes, and others known by those skilled in the art.

To reduce the time required to sense the temperature at specific points, illustrative embodiments position an array of heat conducting pads 30 over the array of temperature sensors 26. To illustrate this, FIG. 3B schematically shows a small portion of the array of temperature sensors 26 showing four temperature sensors 26 and their pads 30. The temperature sensors 26 are drawn in phantom because they preferably are covered by the pads 30. Some embodiments do not cover the sensors 26, however, and simply thermally connect the sensors 26 with the pads 26.

Accordingly, each temperature sensor 26 has an associated heat conducting pad 30 that channels heat from one two dimensional portion of the foot 10 (considered a two dimensional area although the foot may have some depth dimensionality) directly to its exposed surface. The array of conducting pads 30 preferably takes up the substantial majority of the total surface area of the printed circuit board 28. The distance between the pads 30 thermally isolates them from one another, thus eliminating thermal short-circuits.

For example, each pad 30 may have a square shape with each side having a length of between about 0.1 and 1.0 inches. The pitch between pads 30 thus is less than that amount. Accordingly, as a further detailed example, some embodiments may space the temperature sensors 26 about 0.4 inches apart with 0.25 inch (per side) square pads 30 oriented so that each sensor 26 is at the center of the square pads 30. This leaves an open region (i.e., a pitch) of about 0.15 inches between the square pads 30. Among other things, the pads 30 may be formed from a film of thermally conductive metal, such as a copper.

As suggested above, some embodiments do not use an array of temperature sensors 26. Instead, such embodiments may use a single temperature sensor 26 that can obtain a temperature reading of most or all of the sole. For example, a single sheet of a heat reactive material, such as a thermochromic film (noted above), or similar apparatus should suffice. As known by those in the art, a thermochromic film, based on liquid crystal technology, has internal liquid crystals that reorient to produce an apparent change in color in response to a temperature change, typically above the ambient temperature. Alternatively, one or more individual temperature sensors 26, such as thermocouples or temperature sensor resistors, may be movable to take repeated temperature readings across the bottom of the foot 10.

To operate efficiently, the open platform 16 should be configured so that its top surface contacts substantially the entire sole of the patient's foot 10. To that end, the platform 16 has a flexible and movable layer of foam 32 or other material that conforms to the user's foot 10. For example, this layer should conform to the arch of the foot 10. Of course, the sensors 26, printed circuit board 28, and cover 20 also should be similarly flexible and yet robust to conform to the foot 10 in a corresponding manner. Accordingly, the printed circuit board 28 preferably is formed largely from a flexible material that supports the circuit. For example, the printed circuit board 28 may be formed primarily from a flex circuit that supports the temperature sensors 26, or it may be formed from strips of

material that individually flex when receiving feet. Alternative embodiments may not have such flexibility (e.g., formed from conventional printed circuit board material, such as FR-4) and thus, produce less effective data.

The rigid base **22** positioned between the foam **32** and the non-skid base **24** provides rigidity to the overall structure. In addition, the rigid base **22** is contoured to receive a motherboard **34**, a battery pack **36**, a circuit housing **38**, and additional circuit components that provide further functionality. For example, the motherboard **34** may contain integrated circuits and microprocessors that control the functionality of the platform **16**.

In addition, the motherboard **34** also may have a user interface/indicia display **18** as discussed above, and a communication interface **40** (FIG. **5**) to connect to a larger network **44**, such as the Internet. The communication interface **40** may connect wirelessly or through a wired connection with the larger network **44**, implementing any of a variety of different data communication protocols, such as Ethernet. Alternatively, the communication interface **40** can communicate through an embedded Bluetooth or other short range wireless radio that communicates with a cellular telephone network **44** (e.g., a 3G or 4G network).

The platform **16** also may have edging **42** and other surface features that improve its aesthetic appearance and feel to the patient. The layers may be secured together using one or more of an adhesive, snaps, nuts, bolts, or other fastening devices.

Although it gathers temperature and other data about the patient's foot, illustrative embodiments may locate additional logic for monitoring foot health at another location. For example, such additional logic may be on a remote computing device. To that and other ends, FIG. **4** schematically shows one way in which the platform **16** can communicate with a larger data network **44** in accordance with various embodiments the invention. As shown, the platform **16** may connect with the Internet through a local router, through its local area network, or directly without an intervening device. This larger data network **44** (e.g., the Internet) can include any of a number of different endpoints that also are interconnected. For example, the platform **16** may communicate with an analysis engine **46** that analyzes the thermal data from the platform **16** and determines the health of the patient's foot **10**. The platform **16** also may communicate directly with a healthcare provider **48**, such as a doctor, nurse, relative, and/or organization charged with managing the patient's care. In fact, the platform **16** also can communicate with the patient, such as through text message, telephone call, e-mail communication, or other modalities as the system permits.

FIG. **5** schematically shows a block diagram of a foot monitoring system, showing the platform **16** and the network **44** with its interconnected components in more detail. As shown, the patient communicates with the platform **16** by standing on or being received in some manner by the array of sensors **26**, which is represented in this figure as a "sensor matrix **52**." A data acquisition block **54**, implemented by, for example, the motherboard **34** and circuitry shown in FIG. **3**, controls acquisition of the temperature and other data for storage in a data storage device **56**. Among other things, the data storage device **56** can be a volatile or nonvolatile storage medium, such as a hard drive, high-speed random-access-memory ("RAM"), or solid-state memory. The input/output interface port **40**, also controlled by the motherboard **34** and other electronics on the platform **16**, selectively transmits or forwards the acquired data from the storage device to the analysis engine **46** on a remote computing device, such as a server **60**. The data acquisition block **54** also may control the

user indicators/displays **18**, which provide feedback to the user through the above mentioned indicia (e.g., audible, visual, or tactile).

As noted above and discussed in greater detail below with regard to FIGS. **7** and **8**, the analysis engine **46**, on the remote server **60**, analyzes the data received from the platform **16** in conjunction with a health data analytics module **62**. A server output interface **64** forwards the processed output information/data from the analysis engine **46** and health data analytics module **62** toward others across the network **44**, such as to a provider, a web display, or to the user via a phone, e-mail alert, text alert, or other similar way.

This output message may have the output information in its relatively raw form for further processing. Alternatively, this output message may have the output information formatted in a high-level manner for easy review by automated logic or a person viewing the data. Among other things, the output message may indicate the actual emergence of an ulcer **12** or a pre-ulcer **14**, the risk of the emergence of an ulcer **12** or a pre-ulcer **14**, or simply that the foot **10** is healthy and has no risks of ulcer **12** or pre-ulcer **14**. In addition, this output message also may have information that helps an end-user or healthcare provider **48** monitor an ulcer **12** or pre-ulcer **14**.

Using a distributed processing arrangement like that shown in FIG. **5** has a number of benefits. Among other things, it permits the platform **16** to have relatively simple and inexpensive components that are unobtrusive to the patient. Moreover, this permits a "software-as-a-service" business model ("SAAS model"), which, among other things, permits more flexibility in the functionality, typically easier patient monitoring, and more rapid functional updates. In addition, the SAAS model facilitates accumulation of patient data to improve analytic capability.

Some embodiments may distribute and physically position the functional components in a different manner. For example, the platform **16** may have the analysis engine **46** on its local motherboard **34**. In fact, some embodiments provide the functionality entirely on the platform **16** and/or within other components in the local vicinity of the platform **16**. For example, all of those functional elements (e.g., the analysis engine **46** and other functional elements) may be within the housing formed by the cover **20** and the rigid base **22**. Accordingly, discussion of a distributed platform **16** is but one of a number of embodiments that can be adapted for a specific application or use.

Those skilled in the art can perform the functions of the analysis engine **46** using any of a number of different hardware, software, firmware, or other non-known technologies. FIG. **6** shows several functional blocks that, with other functional blocks, may be configured to perform the functions of the analysis engine **46**. This figure simply shows the blocks and is illustrative of one way of implementing various embodiments, while FIGS. **7** and **8** describe their functions in greater detail.

In summary, the analysis engine **46** of FIG. **6** has a thermogram generator **66** configured to form a thermogram of the patient's foot **10** or feet **10** based on a plurality of temperature readings from the bottom of the foot **10**, and a pattern recognition system **68** configured to determine whether the thermogram presents any of a number of different prescribed patterns. Pattern data and other information may be stored in a local memory **76**. As discussed below, if the thermogram presents any of these prescribed patterns, then the foot **10** may be unhealthy in some manner (e.g., having a pre-ulcer **14** or an ulcer **12**).

The analysis engine **46** also has an analyzer **70** configured to produce the above noted output information, which indi-

cates any of a number of different conditions of the foot **10**. For example, the output information may indicate the risk that an ulcer **12** will emerge, the emergence of a pre-ulcer **14** (i.e., the first indication of a pre-ulcer **14**), the progression of a known ulcer **12**, or the emergence of a new ulcer **12** (i.e., the first indication of any given ulcer **12** to the patient and associated support). Communicating through some interconnect mechanism, such as a bus **72** or network connection, these modules cooperate to determine the status of the foot **10**, which may be transmitted or forwarded through an input/output port **74** that communicates with the prior noted parties across the larger data network **44**.

FIG. **7** shows a process that uses the various components described above in FIGS. **1** through **6** to determine the health of the patient's foot **10**. It should be noted that this process is a simplified, high level summary of a much larger process and thus, should not be construed to suggest that only these steps are required. In addition, some of the steps may be performed in a different order than those described below. Although functions and processes of this process are described as being executed by the functional blocks in FIGS. **5** and **6**, some embodiments can be executed by other functional components.

The process begins at step **700**, in which the platform **16** receives the patient's feet **10** on its top surface, which may be considered a foot receiving area. For example, as shown in FIG. **2A**, the patient may step on the open platform **16** in front of the bathroom sink while washing her hands, brushing her teeth, or performing some other routine, frequent daily task. Presumably, the platform **16** is energized before the patient steps onto it. Some embodiments, however, may require that the platform **16** be affirmatively energized by the patient turning on power in some manner (e.g., actuating a power switch). Other embodiments, however, normally may operate in a low power, conservation mode (a "sleep mode") that rapidly turns on in response to a stimulus, such as receipt of the patient's feet **10**.

Accordingly, the platform **16** controls the sensor array to measure the temperature at the prescribed portions of the patient's foot/sole. At the same time, the user indicator display **18** may deliver affirmative feedback to the patient by any of the above discussed ways. After the patient steps on the platform **16**, the temperature sensors **26** may take a relatively long time to ultimately make their readings. For example, this process can take between 30 to 60 seconds. Many people, however, do not have that kind of patience and thus, may step off the platform **16** before it has completed its analysis. This undesirably can lead to inaccurate readings. In addition, these seemingly long delay times can reduce compliance.

The inventors recognized these problems. Accordingly, illustrative embodiments of the invention do not require such long data acquisition periods. Instead, the system can use conventional techniques to extrapolate a smaller amount of real temperature data (e.g., a sparser set of the temperature data) to arrive at an approximation of the final temperature at each point of the foot. For example, this embodiment may use techniques similar to those used in high speed thermometers to extrapolate the final temperature data using only one to three seconds of actual temperature data.

This step therefore produces a matrix of discrete temperature values across the foot **10** or feet **10**. FIG. **9A** graphically shows one example of this discrete temperature data for two feet **10**. As discrete temperature values, this representation does not have temperature information for the regions of the foot **10** between the temperature sensors **26**. Accordingly,

using this discrete temperature data as shown in FIG. **9A**, the process forms a thermogram of the foot **10** or feet **10** under examination (step **702**).

In simple terms, as known by those in the art, a thermogram is a data record made by a thermograph, or a visual display of that data record. A thermograph simply is an instrument that records temperatures (i.e., the platform **16**). As applied to illustrative embodiments, a thermograph measures temperatures and generates a thermogram, which is data, or a visual representation of that data, of the continuous two-dimensional temperature data across some physical region, such as a foot **10**. Accordingly, unlike an isothermal representation of temperature data, a thermogram provides a complete, continuous data set/map of the temperatures across an entire two-dimensional region/geography. More specifically, in various embodiments, a thermogram shows (within accepted tolerances) substantially complete and continuous two-dimensional spatial temperature variations and gradients across portions of the sole of (at least) a single foot **10**, or across the entire sole of the single foot **10**.

Momentarily turning away from FIG. **7**, FIG. **8** shows a process that step **702** uses to form a thermogram. This discussion will return to FIG. **7** and proceed from step **702** after completing the thermogram formation process of FIG. **8**. It should be noted that, in a manner similar to FIG. **7**, the process of FIG. **8** is a simplified, high level summary of a larger process and thus, should not be construed to suggest that only these steps are required. In addition, some of the steps may be performed in a different order than those described below. In a manner similar to the functions and processes of FIG. **7**, the functions and processes described with regard to this process also can be executed by the functional blocks in FIGS. **5** and **6**, or by other functional components.

The process of forming a thermogram begins at step **800**, in which the thermogram generator **66** of the analysis engine **46** receives the plurality of temperature values, which, as noted above, are graphically shown by FIG. **9A**. Of course, the thermogram generator **66** typically receives those temperature values as raw data. The depiction in FIG. **9A** therefore is simply for illustration purposes only.

After receiving the temperature values, the process begins calculating the temperatures between the temperature sensors **26**. To that end, the process uses conventional interpolation techniques to interpolate the temperature values in a manner that produces a thermogram as noted above (step **802**). Accordingly, for a thermogram of a planar thermodynamic system at steady state, the process may be considered to increase the spatial resolution of the data.

Among other ways, some embodiments may use Laplace interpolation between the temperatures observed at each temperature sensor **26**. Laplace interpolation is appropriate for this function given its physical relevance—the heat equation should simplify to the Laplace equation under the assumption of steady state. The interpolant may be constructed by applying a second-order discrete finite difference Laplacian operator to the data, imposing equality conditions on the known temperatures at the sensors **26**, and solving the resulting sparse linear system using an iterative solver, such as GMRES.

FIG. **9B** schematically shows one example of the thermogram at this stage of the process. This figure should be contrasted with FIG. **9A**, which shows a more discrete illustration of the soles of the feet **10**.

At this point, the process is considered to have formed the thermogram. For effective use, however, it nevertheless still may require further processing. Step **804** therefore orients the data/thermogram to a standard coordinate system. To that

end, the process may determine the location of the sole of each foot **10**, and then transform it into a standard coordinate system for comparison against other temperature measurements on the same foot **10**, and on the other foot **10**. This ensures that each portion of the foot **10** may be compared to itself from an earlier thermogram. FIG. 9C schematically shows one example of how this step may reorient the thermogram of FIG. 9B.

The position and orientation of the foot **10** on the platform **16** therefore is important when performing this step. For example, to determine the position and orientation of the foot **10**, the analysis engine **46** and its thermogram generator **66** simply may contrast the regions of elevated temperature on the platform **16** (i.e., due to foot contact) with those at ambient temperature. Other embodiments may use pressure sensors to form a pressure map of the foot **10**.

The process may end at this point, or continue to step **806**, to better contrast warmer portions of the foot **10** against other portions of the foot **10**. FIG. 9D schematically shows a thermogram produced in this manner from the thermogram of FIG. 9C. This figure more clearly shows two hotspots on the foot **10** than FIG. 9C. To that end, the process determines the baseline or normal temperature of the foot **10** for each location within some tolerance range. The amount to which the actual temperature of a portion of the foot **10** deviates from the baseline temperature of that portion of the foot **10** therefore is used to more readily show hotspots.

For example, if the deviation is negative, the thermogram may have some shade of blue, with a visual scale of faint blues being smaller deviations and richer blues being larger deviations. In a similar manner, positive deviations may be represented by some shade of red, with a visual scale of faint red being smaller deviations and richer reds being larger deviations. Accordingly, and this example, bright red portions of the thermogram readily show hotspots that may require immediate attention. Of course, other embodiments may use other colors or techniques for showing hotspots. Accordingly, discussion of color coding or specific colors is not intended to limit all embodiments.

Now that the thermogram generator **66** has generated the thermogram, with brighter hotspots and in an appropriate orientation, this discussion returns to FIG. 7 to determine if the thermogram presents or shows any of a number of prescribed patterns (step **704**) and then analyzes any detected pattern (step **706**) to determine if there are hotspots. In particular, as noted, an elevated temperature at a particular portion of the foot **10** may be indicative or predictive of the emergence and risk of a pre-ulcer **14** or ulcer **12** in the foot **10**. For example, temperature deviations of about 2 degrees C. or about 4 degrees F. in certain contexts can suggest emergence of an ulcer **12** or pre-ulcer **14**. Temperature deviations other than about two degrees C. also may be indicative of a pre-ulcer **14** or ulcer **12** and thus, 2 degrees C. and 4 degrees F. are discussed by example only. Accordingly, various embodiments analyze the thermogram to determine if the geography of the foot **10** presents or contains one or more of a set of prescribed patterns indicative of a pre-ulcer **14** or ulcer **12**. Such embodiments may analyze the visual representation of the thermograph, or just the data otherwise used to generate and display a thermograph image—without displaying the thermograph.

A prescribed pattern may include a temperature differential over some geography or portion of the foot **10** or feet **10**. To that end, various embodiments contemplate different patterns that compare at least a portion of the foot **10** against other foot data. Among other things, those comparisons may include the following:

1. A comparison of the temperature of the same portion/spot of the same foot **10** at different times (i.e., a temporal comparison of the same spot),

2. A comparison of the temperatures of corresponding portions/spots of the patient's two feet **10** at the same time or at different times, and/or

3. A comparison of the temperature of different portions/spots of the same foot **10** at the same time or at different times.

As an example of the first comparison, the pattern may show a certain region of a foot **10** has a temperature that is 4 F higher than the temperature at that same region several days earlier. FIG. 10A schematically shows one example of this, in which a portion of the same foot **10**—the patient's left foot **10**, has a spot with an increased risk of ulceration.

As an example of the second comparison, the pattern may show that the corresponding portions of the patient's feet **10** have a temperature differential that is 4 degrees F. FIG. 10B schematically shows an example of this, where the region of the foot **10** on the left (the right foot **10**) having a black border is hotter than the corresponding region on the foot **10** on the right (the left foot **10**).

As an example of the third comparison, the pattern may show localized hotspots and peaks within an otherwise normal foot **10**. These peaks may be an indication of pre-ulcer **14** or ulcer **12** emergence, or increased risk of the same, which, like the other examples, alerts caregiver and patient to the need for more vigilance.

Of course, various embodiments may make similar comparisons while analyzing the thermogram for additional patterns. For example, similar to the third comparison, the pattern recognition system **68** may have a running average of the temperature of the geography of the entire foot **10** over time. For any particular spot on the foot **10**, this running average may have a range between a high temperature and a low temperature. Accordingly, data indicating that the temperature at that given spot is outside of the normal range may be predictive of a pre-ulcer **14** or an ulcer **12** at that location.

Some embodiments may use machine learning and advanced filtering techniques to ascertain risks and predictions, and to make the comparisons. More specifically, advanced statistical models may be applied to estimate the current status and health of the patient's feet **10**, and to make predictions about future changes in foot health. State estimation models, such as a switching Kalman filters, can process data as they become available and update their estimate of the current status of the user's feet **10** in real-time. The statistical models can combine both expert knowledge based on clinical experience, and published research (e.g., specifying which variables and factors should be included in the models) with real data gathered and analyzed from users. This permits models to be trained and optimized based on a variety of performance measures.

Models can be continually improved as additional data is gathered, and updated to reflect state-of-the-art clinical research. The models also can be designed to take into account a variety of potentially confounding factors, such as physical activity (e.g., running), environmental conditions (e.g., a cold floor), personal baselines, past injuries, predisposition to developing problems, and problems developing in other regions (e.g., a rise in temperature recorded by a sensor **26** may be due to an ulcer **12** developing in a neighboring region measured by a different sensor). In addition to using these models for delivering real-time analysis of users, they also may be used off-line to detect significant patterns in large archives of historical data. For example, a large rise above baseline temperature during a period of inactivity may precede the development of an ulcer **12**.

Alternative embodiments may configure the pattern recognition system **68** and analyzer **70** to perform other processes that identify risk and emergence, as well as assist in tracking the progressions ulcers **12** and pre-ulcers **14**. For example, if there is no ambient temperature data from a thermogram prior to the patient's use of the platform **16**, then some embodiments may apply an Otsu filter (or other filter) first to the high resolution thermogram to identify regions with large temperature deviations from ambient. The characteristics of these regions (length, width, mean temperature, etc . . .) then may be statistically compared to known distributions of foot characteristics to identify and isolate feet **10**. The right foot thermogram may be mirrored and an edge-alignment algorithm can be employed to standardize the data for hotspot identification.

Two conditions can be evaluated independently for hotspot identification. The first condition evaluates to true when a spatially-localized contralateral thermal asymmetry exceeds a pre-determined temperature threshold for a given duration. The second condition evaluates to true when a spatially-localized ipsilateral thermal deviation between temporally successive scans exceeds a pre-determined temperature threshold for a given duration. The appropriate durations and thermal thresholds can be determined from literature review or through application of machine learning techniques to data from observational studies. In the latter case, a support vector machine or another robust classifier can be applied to outcome data from the observational study to determine appropriate temperature thresholds and durations to achieve a desired balance between sensitivity and specificity.

Illustrative embodiments have a set of prescribed patterns against which the pattern recognition system **68** and analyzer **70** compare to determine foot health. Accordingly, discussion of specific techniques above are illustrative of any of a number of different techniques that may be used and thus, are not intended to limit all embodiments of the invention.

The output of this analysis can be processed to produce risk summaries and scores that can be displayed to various users to trigger alerts and suggest the need for intervention. Among other things, state estimation models can simulate potential changes in the user's foot **10** and assess the likelihood of complications in the future. Moreover, these models can be combined with predictive models, such as linear logistic regression models and support vector machines, which can integrate a large volume and variety of current and historical data, including significant patterns discovered during off-line analysis. This may be used to forecast whether the user is likely to develop problems within a given timeframe. The predictions of likelihood can be processed into risk scores, which also can be displayed by both users and other third parties. These scores and displays are discussed in greater detail below.

To those ends, the process continues to step **708**, which generates output information relating to the health of the foot **10**. Specifically, at this stage in the process, the analysis engine **46** has generated the relevant data to make a number of conclusions and assessments, in the form of output information, relating to the health of the foot **10**. Among other things, those assessments may include the risk of an ulcer **12** emerging anywhere on the foot **10**, or at a particular location on the foot **10**. This risk may be identified on a scale from no risk to maximum risk.

FIG. **11A** shows one example of the output information in a visual format with a scale ranking the risk of ulcer emergence. The scale in this example visually displays de-identified patients (i.e., Patient A to Patient **2**) as having a certain risk level of developing the foot ulcer **12**. The "Risk Level"

column shows one way of graphically displaying the output information, in which more rectangles indicate a higher risk of ulcer **12**. Specifically, in this example, a single rectangle may indicate minimal or no risk, while rectangles filling the entire length of that table entry may indicate a maximum risk or fully emerged ulcer **12**. Selection of a certain patient may produce an image of the foot **10** with a sliding bar showing the history of that patient's foot **10**. FIG. **11B** schematically shows a similar output table in which the risk level is characterized by a percentage from zero to hundred percent within some time frame (e.g., days). Patient C is bolded in this example due to their 80 percent risk of the emergence of an ulcer **12**.

The output table thus may provide the caregiver or health-care provider with information, such as the fact that Patient B has a 90 percent probability that he/she will develop a foot ulcer **12** in the next 4-5 days. To assist in making clinical treatment decisions, the clinician also may access the patient's history file to view the raw data.

Other embodiments produce output information indicating the emergence of a pre-ulcer **14** at some spot on the foot **10**. As known by those skilled in the art, a pre-ulcer **14** may be considered to be formed when tissue in the foot **10** is no longer normal, but it has not ruptured the top layer of skin. Accordingly, a pre-ulcer **14** is internal to the foot **10**. More specifically, tissue in a specific region of the foot **10** may not be receiving adequate blood supply and thus, may need more blood. When it does not receive an adequate supply of blood, it may become inflamed and subsequently, become necrotic (i.e., death of the tissue). This creates a weakness or tenderness in that region of the foot **10**. Accordingly, a callous or some event may accelerate a breakdown of the tissue, which ultimately may rupture the pre-ulcer **14** to form an ulcer **12**.

Illustrative embodiments may detect the emergence of a pre-ulcer **14** in any of a number of manners described above. For example, the system may compare temperature readings to those of prior thermograms, such as the running average of the temperature at a given location. This comparison may show an elevated temperature at that spot, thus signaling the emergence of a new pre-ulcer **14**. In more extreme cases, this may indicate the actual emergence of a new ulcer **12**.

The emergence or detection of a pre-ulcer **14** can trigger a number of other preventative treatments that may eliminate or significantly reduce the likelihood of the ultimate emergence of an ulcer **12**. To that end, after learning about a pre-ulcer **14**, some embodiments monitor the progression of the pre-ulcer **14**. Preferably, the pre-ulcer **14** is monitored during treatment in an effort to heal the area, thus avoiding the emergence of an ulcer **12**. For example, the caregiver may compare each day's thermogram to prior thermograms, thus analyzing the most up to date state of the pre-ulcer **14**. In favorable circumstances, during a treatment regimen, this comparison/monitoring shows a continuous improvement of the pre-ulcer **14**, indicating that the pre-ulcer **14** is healing. The output information therefore can have current and/or past data relating to the pre-ulcer **14**, and the risk that it poses for the emergence of an ulcer **12**.

Sometimes, patients may not even realize that they have an ulcer **12** until it has become seriously infected. For example, if the patient undesirably does not use the foot monitoring system for a long time, he/she may already have developed an ulcer **12**. The patient therefore may step on the platform **16** and the platform **16** may produce output information indicating the emergence of an ulcer **12**. To that end, the analyzer **70** may have prior baseline thermogram (i.e., data) relating to this patient's foot **10** (showing no ulcer), and make a comparison against that baseline data to determine the emergence

of an actual ulcer **12**. In cases where the data is questionable about whether it is an ulcer **12** or a pre-ulcer **14**, the caregiver and/or patient nevertheless may be notified of the higher risk region of the foot **10** which, upon even a cursory visual inspection, should immediately reveal the emergence of an ulcer **12**.

The process concludes at step **710**, in which the process (optionally) manually or automatically notifies the relevant people about the health of the foot **10**. These notifications or messages (a type of "risk message") may be in any of a number of forms, such as a telephone call, a text message, e-mail, and data transmission, or other similar mechanism. For example, the system may forward an e-mail to a healthcare provider indicating that the right foot **10** of the patient is generally healthy, while the left foot **10** has a 20 percent risk of developing an ulcer **12**, and a pre-ulcer **14** also has emerged on a specified region. Armed with this information, the healthcare provider may take appropriate action, such as by directing the patient to stay off their feet **10**, use specialized footwear, soak their feet **10**, or immediately check into a hospital.

Accordingly, illustrative embodiments take advantage of the continuous data provided by a thermogram to ascertain various risks to foot health. In addition, such embodiments also monitor the foot **10** using an easy to follow regimen and form factor that encourages patient compliance. Early detection can assist in avoiding foot ulcers **12**, while late detection can alert patients to yet undiscovered ulcers **12**, which can then be effectively treated.

Various embodiments of the invention may be implemented at least in part in any conventional computer programming language. For example, some embodiments may be implemented in a procedural programming language (e.g., "C"), or in an object oriented programming language (e.g., "C++"). Other embodiments of the invention may be implemented as preprogrammed hardware elements (e.g., application specific integrated circuits, FPGAs, and digital signal processors), or other related components.

In an alternative embodiment, the disclosed apparatus and methods (e.g., see the various flow charts described above) may be implemented as a computer program product (or in a computer process) for use with a computer system. Such implementation may include a series of computer instructions fixed either on a tangible medium, such as a computer readable medium (e.g., a diskette, CD-ROM, ROM, or fixed disk) or transmittable to a computer system, via a modem or other interface device, such as a communications adapter connected to a network over a medium.

The medium may be either a tangible medium (e.g., optical or analog communications lines) or a medium implemented with wireless techniques (e.g., WIFI, microwave, infrared or other transmission techniques). The medium also may be a non-transient medium. The series of computer instructions can embody all or part of the functionality previously described herein with respect to the system. The processes described herein are merely exemplary and it is understood that various alternatives, mathematical equivalents, or derivations thereof fall within the scope of the present invention.

Those skilled in the art should appreciate that such computer instructions can be written in a number of programming languages for use with many computer architectures or operating systems. Furthermore, such instructions may be stored in any memory device, such as semiconductor, magnetic, optical or other memory devices, and may be transmitted using any communications technology, such as optical, infrared, microwave, or other transmission technologies.

Among other ways, such a computer program product may be distributed as a removable medium with accompanying printed or electronic documentation (e.g., shrink wrapped software), preloaded with a computer system (e.g., on system ROM or fixed disk), or distributed from a server or electronic bulletin board over the larger network **44** (e.g., the Internet or World Wide Web). Of course, some embodiments of the invention may be implemented as a combination of both software (e.g., a computer program product) and hardware. Still other embodiments of the invention are implemented as entirely hardware, or entirely software.

Although the above discussion discloses various exemplary embodiments of the invention, it should be apparent that those skilled in the art can make various modifications that will achieve some of the advantages of the invention without departing from the true scope of the invention.

What is claimed is:

1. A method of determining an emergence of an ulcer on a given portion on at least one foot of a patient, the method comprising:

providing one or more processors;

providing an open platform for receiving at least one foot, the open platform having a plurality of temperature sensors;

generating, using the plurality of temperature sensors, a plurality of discrete temperature data values after receipt of the at last one foot;

forming, by at least one of the one or more processors, at least one thermogram of a sole of each of the at least one foot of the patient from the discrete temperature data values, each thermogram comprising a spatially continuous data set of two-dimensional temperature values across the sole of one foot;

determining, by at least one of the one or more processors, whether the at least one thermogram presents at least one of a plurality of prescribed patterns;

said determining comprising comparing the at least one thermogram against a prior thermogram of the same foot; and

producing, by at least one of the one or more processors, output information indicating an emergence of an ulcer on a given portion on the at least one foot, said producing being a function of whether the at least one thermogram is determined to present the at least one prescribed pattern, said producing also being a function of the comparison, the prior thermogram showing non-ulcerated tissue at the given portion.

2. The method as defined by claim 1 wherein the prior thermogram shows a pre-ulcer at the given portion.

3. The method as defined by claim 1 wherein said providing an open platform comprises positioning both feet on the open platform.

4. The method as defined by claim 1 wherein the open platform comprises a floor mat.

5. The method as defined by claim 1 wherein the plurality of temperature sensors comprises a plurality of stationary sensors.

6. The method as defined by claim 1 wherein the plurality of temperature sensors comprise at least one contact sensor, the at least one contact sensor being in thermally-conductive contact with a sole of each of the at least one foot of the patient to generate the plurality of discrete temperature data values.

7. The method as defined by claim 1 wherein the plurality of temperature sensors are positioned at discrete locations of the open platform, said forming comprising interpolating temperature data between at least two of the plurality of

temperature sensors to produce approximate temperature readings at locations that are between the sensors.

8. The method as defined by claim 1 wherein the platform has a receiving area for receiving the at least one foot, the receiving area having a surface area that is greater than the surface area of the at least one foot.

9. The method as defined by claim 1 wherein at least one of the plurality of prescribed patterns shows a deviation in two portions of the same foot.

10. The method as defined by claim 1 wherein at least one of the plurality of prescribed patterns shows a deviation in one portion of the same foot over time.

11. The method as defined by claim 1 further comprising receiving a risk message from a network, the risk message having the output information.

12. The method as defined by claim 1 wherein said forming comprises forming a thermogram of substantially the entirety of the sole of each of the at least one foot of the patient.

13. The method as defined by claim 1 further comprising determining an orientation of the at least one foot to produce orientation information, said determining using the orientation information to determine whether the at least one thermogram presents at least one of the plurality of prescribed patterns.

14. The method as defined by claim 1 wherein the output information comprises information for displaying quantitative indicia indicating the emergence of the ulcer.

15. The method as defined by claim 1 further comprising forwarding a data message across a network, the data message having the spatially continuous data set of two-dimensional temperature values representing the at least one thermogram.

16. The method as defined by claim 1 wherein said forming comprises:

receiving a thermogram message through a network from the open platform, the thermogram message having the discrete temperature data values; and

forming the at least one thermogram from the discrete temperature data values in the thermogram message after receipt of the thermogram message.

17. The method as defined by claim 16 wherein said forming the at least one thermogram comprises interpolating the received discrete temperature data values.

18. A computer program product for determining the emergence of an ulcer on a given portion on the at least one foot of a patient, the computer program product comprising a tangible, non-transient computer usable medium having computer readable program code thereon, the computer readable program code comprising:

program code for receiving a plurality of discrete temperature data values from an open platform configured to receive at least one foot, the open platform having a plurality of temperature sensors,

the plurality of temperature sensors being configured to generate the plurality of discrete temperature data values after receipt of the at least one foot;

program code for forming at least one thermogram of a sole of at least one foot of the patient from the discrete temperature data values, each thermogram comprising a spatially continuous data set of two-dimensional temperature values across the sole of one foot;

program code for determining whether the at least one thermogram presents at least one of a plurality of prescribed patterns;

said program code for determining comprising program code for comparing the at least one thermogram against a prior thermogram of the same foot; and

program code for producing output information indicating the emergence of an ulcer on a given portion on the at least one foot as a function of 1) the comparison and 2) whether the at least one thermogram is determined to present the at least one pattern, the prior thermogram showing non-ulcerated tissue at the given portion.

19. The computer program product as defined by claim 18 wherein the prior thermogram shows a pre-ulcer at the given portion.

20. The computer program product as defined by claim 18 wherein the program code for forming comprises computer program code for interpolating temperature data between at least two of a plurality of temperature data points across a two dimensional space to produce approximate temperature readings at locations that are between the at least two of the plurality of temperature data points across the two dimensional space.

21. The computer program product as defined by claim 18 wherein at least one of the plurality of prescribed patterns shows a deviation in one portion of the same foot over time.

22. The computer program product as defined by claim 18 further comprising program code for receiving a risk message from a network, the risk message having the output information.

23. The method as defined by claim 18 wherein the output information comprises information for displaying quantitative indicia indicating the emergence of the ulcer.

24. The computer program product as defined by claim 18 further comprising program code for forwarding a data message across a network, the message having the spatially continuous data set of two-dimensional temperature values representing the at least one thermogram.

25. The computer program product as defined by claim 18 wherein the program code for forming the at least one thermogram comprises:

program code for receiving a thermogram message through a network from the open platform, the thermogram message having the plurality of discrete temperature data values; and

program code for forming the at least one thermogram from the plurality of discrete temperature data values after receipt of the thermogram message.

26. The computer program product as defined by claim 25 wherein the program code for forming the at least one thermogram from the plurality of discrete temperature data values comprises program code for interpolating the received plurality of discrete temperature data values.

27. An apparatus for determining an emergence of an ulcer on a given portion on at least one foot of a patient, the apparatus comprising:

an open platform having a plurality of temperature sensors configured to generate a plurality of discrete temperature data values after receipt of the at least one foot,

a thermogram generator operatively coupled with the open platform and configured to form at least one thermogram of a sole of each of the at least one foot of the patient from the plurality of discrete temperature data values, each thermogram comprising a spatially continuous data set of two-dimensional temperature values across the sole of one foot;

a pattern recognition system operatively coupled with the thermogram generator, the pattern recognition system configured to determine whether the at least one thermogram presents at least one of a plurality of prescribed patterns;

19

a comparator operatively coupled with the pattern recognition system, the comparator configured to compare the at least one thermogram against a prior thermogram of the same foot; and

an analyzer operatively coupled with the comparator, the analyzer being configured to produce output information indicating the emergence of an ulcer on a given portion on the at least one foot as a function of whether the thermogram is determined to present the at least one of the prescribed patterns, the output information also being a function of the comparison, the prior thermogram showing non-ulcerated tissue at the given portion.

28. The apparatus as defined by claim 27 wherein the open platform comprises a floor mat.

29. The apparatus as defined by claim 27 wherein the plurality of temperature sensors are positioned at discrete locations of the open platform, the thermogram generator

20

being configured to form a thermogram by interpolating temperature data between at least two of the plurality of temperature sensors to produce approximate temperature readings at locations that are between the sensors.

5 30. The apparatus as defined by claim 27 wherein the plurality of temperature sensors comprises a plurality of stationary sensors and at least one contact sensor.

10 31. The apparatus as defined by claim 27 wherein the open platform includes a housing at least in part containing the thermogram generator, pattern recognition system, and analyzer.

32. The apparatus as defined by claim 27 wherein at least one of the plurality of prescribed patterns shows a deviation in one portion of the same foot over time.

15 33. The apparatus as defined by claim 27 wherein the prior thermogram shows a pre-ulcer at the given portion.

* * * * *

专利名称(译)	用于指示溃疡出现的方法和设备		
公开(公告)号	US9271672	公开(公告)日	2016-03-01
申请号	US13/799847	申请日	2013-03-13
[标]申请(专利权)人(译)	珀迪迈垂克斯公司		
申请(专利权)人(译)	PODIMETRICS INC.		
当前申请(专利权)人(译)	PODIMETRICS INC.		
[标]发明人	LINDERS DAVID ROBERT BLOOM JONATHAN DAVID ENGLER JEFFREY MARK PETERSEN BRIAN JUDE GEMBOFF ADAM KALE DAVID CHARLES		
发明人	LINDERS, DAVID, ROBERT BLOOM, JONATHAN, DAVID ENGLER, JEFFREY, MARK PETERSEN, BRIAN, JUDE GEMBOFF, ADAM KALE, DAVID, CHARLES		
IPC分类号	A61B5/00 A61B5/01		
CPC分类号	A61B5/447 A61B5/0022 A61B5/0075 A61B5/0077 A61B5/015 A61B5/445 A61B5/6807 A61B5/706 A61B5/7275 A61B5/7282 A61B5/7425 A61B5/0008 A61B2562/0276 A61B2576/02 A61B5/6892 G16H40/63 G16H50/30		
代理机构(译)	桑斯坦KANN墨菲原料林律师事务所		
优先权	61/618889 2012-04-02 US		
其他公开文献	US20130261495A1		
外部链接	Espacenet USPTO		

摘要(译)

监测患者足部的方法形成患者的至少一只脚的鞋底的热分析图，并确定热分析图是否呈现多个规定图案中的至少一个。该方法还将热谱图与同一脚的先前热谱图进行比较，并产生输出信息，该输出信息指示在至少一只脚上的给定部分上出现溃疡，作为1) 是否确定热谱图呈现为at的函数。至少一种模式，和2) 与先前的热谱图的比较，其显示给定位置处的非溃疡组织。

of the sole of at least one foot of the patient, and determines whether the thermogram presents at least one of a plurality of prescribed patterns. The method also compares the thermogram against a prior thermogram of the same foot, and produces output information indicating the emergence of an