



US 20180078775A1

(19) **United States**

(12) **Patent Application Publication**
Linder et al.

(10) **Pub. No.: US 2018/0078775 A1**
(43) **Pub. Date: Mar. 22, 2018**

(54) **LEADLESS STIMULATION DEVICE WITH A HOUSING THAT HOUSES INTERNAL COMPONENTS OF THE LEADLESS STIMULATION DEVICE AND FUNCTIONS AS THE BATTERY CASE AND A TERMINAL OF AN INTERNAL BATTERY**

Publication Classification

(51) **Int. Cl.**
A61N 1/375 (2006.01)
A61N 1/378 (2006.01)
A61B 5/042 (2006.01)
A61B 5/00 (2006.01)
A61N 1/05 (2006.01)
A61N 1/372 (2006.01)

(52) **U.S. Cl.**
 CPC *A61N 1/3756* (2013.01); *A61N 1/378* (2013.01); *A61N 1/37205* (2013.01); *A61B 5/686* (2013.01); *A61N 1/05* (2013.01); *A61B 5/0422* (2013.01)

(71) Applicant: **CARDIAC PACEMAKERS, INC.**, St. Paul, MN (US)

(72) Inventors: **William J. Linder**, Golden Valley, MN (US); **Keith R. Maile**, New Brighton, MN (US)

(73) Assignee: **CARDIAC PACEMAKERS, INC.**, St. Paul, MN (US)

(21) Appl. No.: **15/699,578**

(22) Filed: **Sep. 8, 2017**

Related U.S. Application Data

(60) Provisional application No. 62/397,882, filed on Sep. 21, 2016.

(57) **ABSTRACT**

Implantable medical devices such as leadless stimulation devices that may provide longer battery life while minimizing device size. In some cases, having the outer housing of the implantable medical device serve multiple roles, such as the battery case for an internal battery, may permit reduced device size by eliminating one or more layers or components within the device.

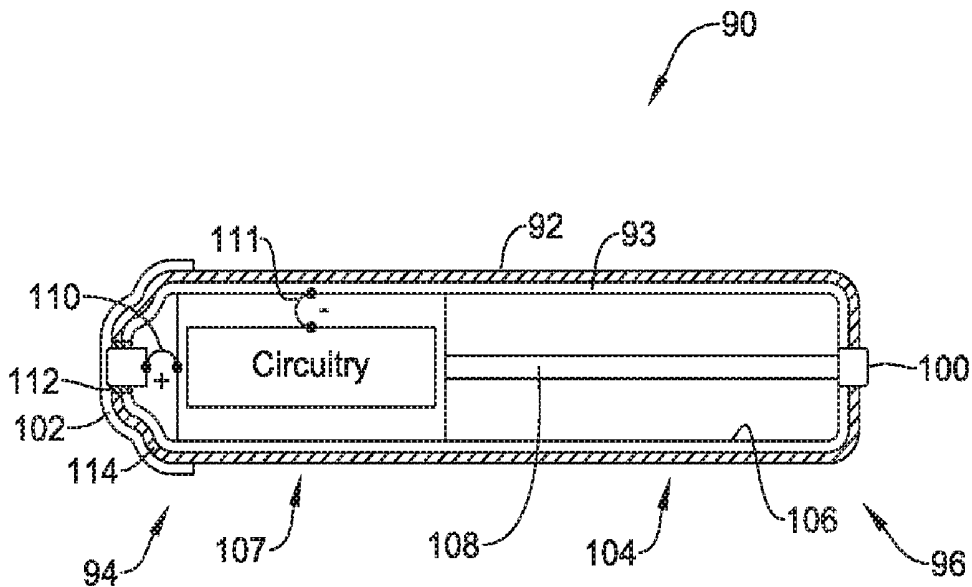

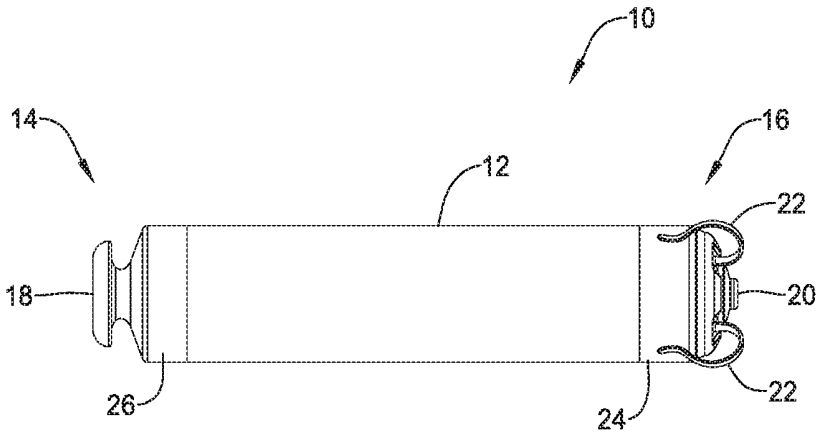

FIG. 1

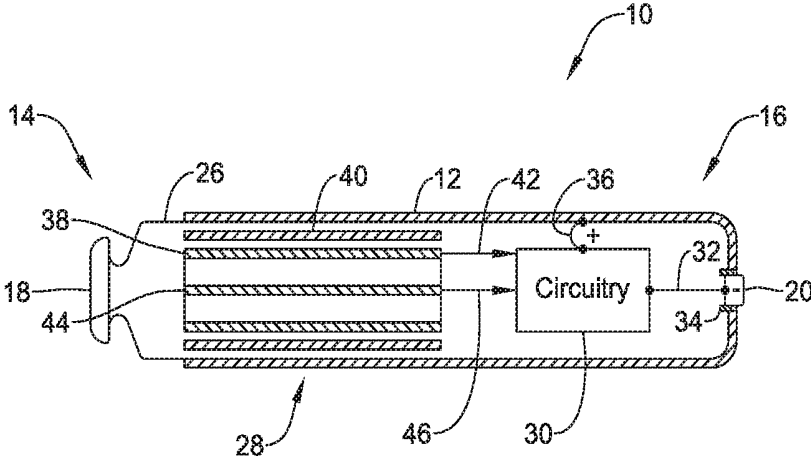

FIG. 2

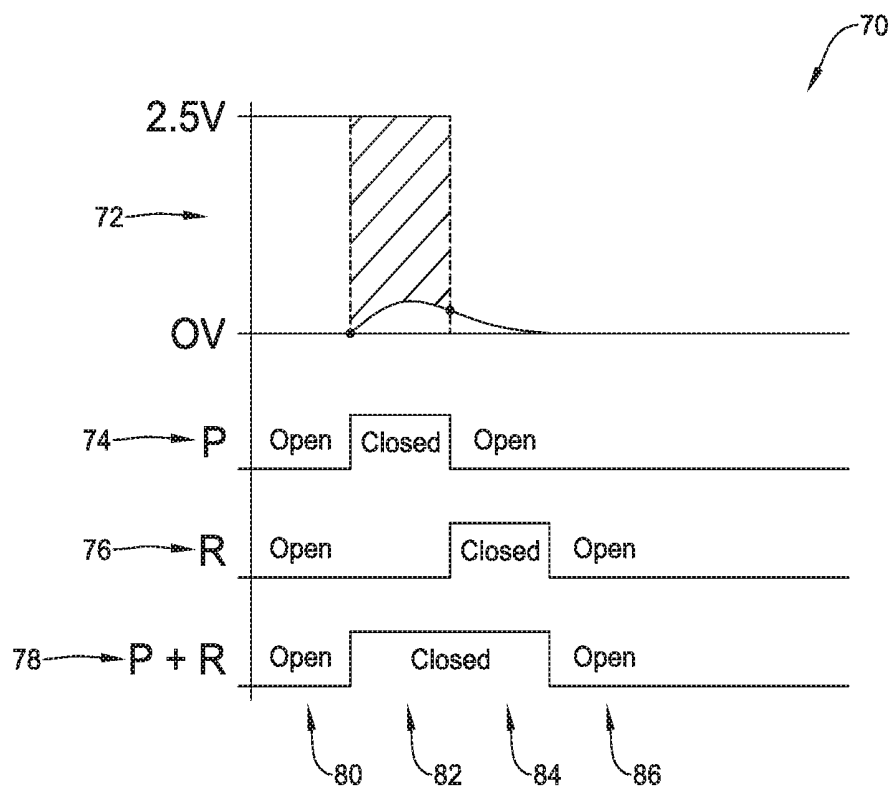

FIG. 4

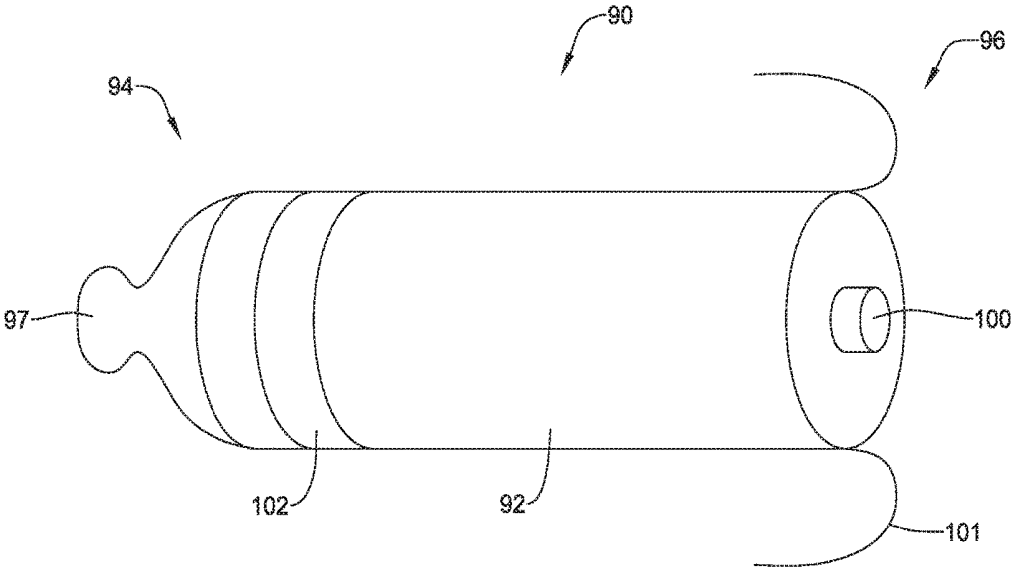

FIG. 5

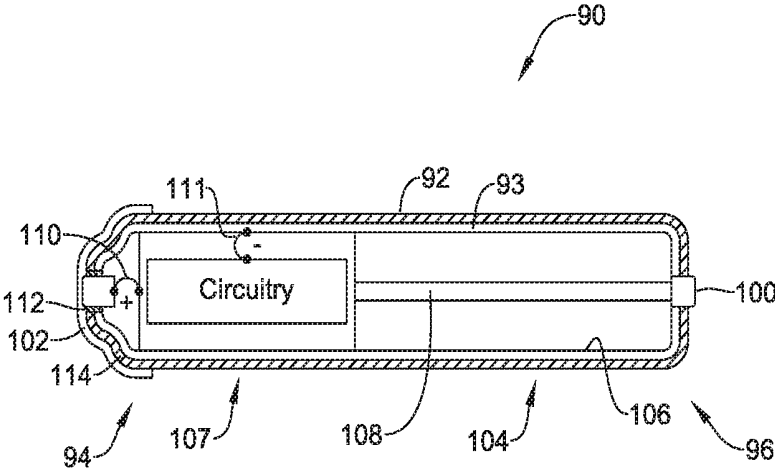

FIG. 6

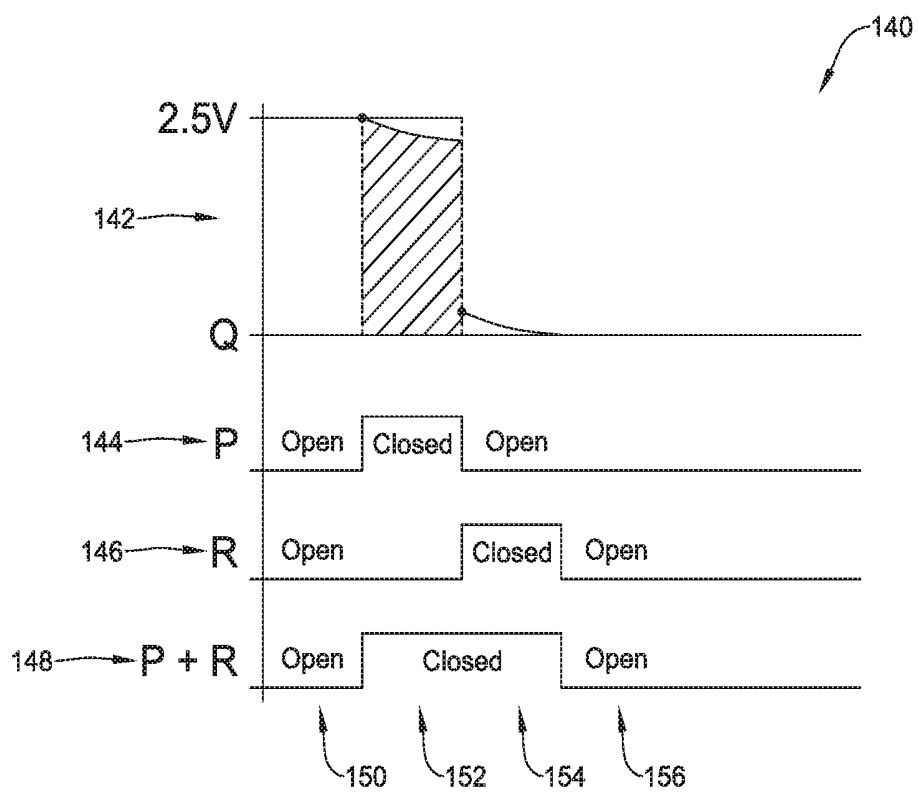

FIG. 8

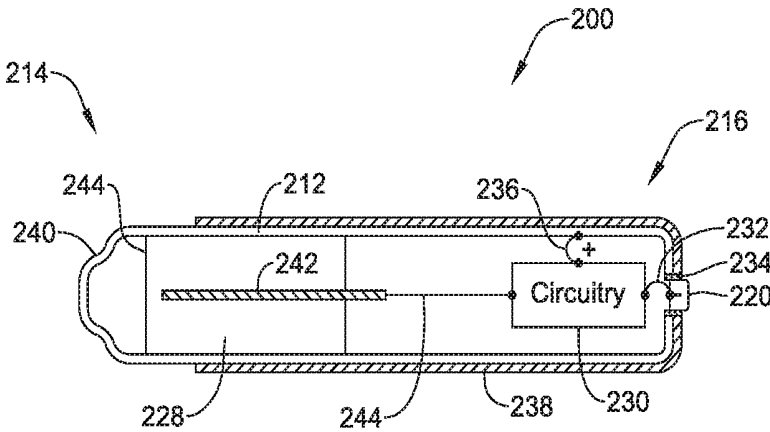

FIG. 9

LEADLESS STIMULATION DEVICE WITH A HOUSING THAT HOUSES INTERNAL COMPONENTS OF THE LEADLESS STIMULATION DEVICE AND FUNCTIONS AS THE BATTERY CASE AND A TERMINAL OF AN INTERNAL BATTERY

CROSS REFERENCE TO RELATED APPLICATIONS

[0001] This application claims the benefit of U.S. Provisional Patent Application Ser. No. 62/397,882 filed on Sep. 21, 2016, the disclosure of which is incorporated herein by reference.

TECHNICAL FIELD

[0002] The disclosure relates generally to leadless devices such as leadless stimulation devices and more particularly to leadless stimulation devices having an internal battery.

BACKGROUND

[0003] A variety of leadless stimulation devices are known, including but not limited to cardiac pacemakers such as leadless cardiac pacemakers, leadless neuro-stimulators, and the like. Leadless cardiac pacemakers are used to sense and pace hearts that are susceptible to a variety of incorrect heart rhythms, including but not limited to bradycardia, which is a slow heart rate, and tachycardia, which is a high heart rate. It will be appreciated that in many cases, there are competing desires for providing long battery life while minimizing device size. Accordingly, there is a desire for making a leadless stimulation device that meets a need for long battery life while minimizing device size.

SUMMARY

[0004] The disclosure is directed to implantable medical devices such as leadless stimulation devices that are configured to provide long battery life while minimizing device size. In some cases, a clever rearrangement of components permits reduced device size by eliminating one or more layers within the device.

[0005] In an example of the disclosure, a leadless stimulation device (LSD) includes a housing having a first end, an opposing second end and a side wall that extends between the first end and the second end. The first end and at least part of the side wall of the housing are conductive, and at least part of the housing that is conductive functions as a cathode electrode for the LSD, wherein the cathode electrode is exposed to the environment outside of the housing. The LSD includes an anode electrode that is spaced from the cathode electrode and is exposed to the environment outside of the housing. A battery may be situated inside the housing, the battery having a negative terminal and a positive terminal, with the negative terminal operatively coupled to the at least part of the housing that is conductive including the cathode electrode. Stimulation circuitry may be situated inside the housing and operatively coupled to the cathode electrode and the anode electrode, the stimulation circuitry may be configured to provide a stimulation pulse by applying a voltage difference between the cathode electrode and the anode electrode, with a more negative voltage applied to the cathode electrode than to the anode electrode.

[0006] Alternatively or additionally to any of the embodiments above, the negative terminal of the battery may be

electrically connected to an inside surface of the at least part of the side wall of the housing that is conductive.

[0007] Alternatively or additionally to any of the embodiments above, the first end and the at least part of the side wall of the housing that is conductive may include a continuous conductive material.

[0008] Alternatively or additionally to any of the embodiments above, the LSD may further include an insulator overlaying at least the first end and the at least part of the side wall of the housing that is conductive, except not overlaying the cathode electrode.

[0009] Alternatively or additionally to any of the embodiments above, the anode electrode is electrically insulated from the first end and the at least part of the side wall of the housing that is conductive.

[0010] Alternatively or additionally to any of the embodiments above, the anode electrode is electrically coupled to an anode terminal of the stimulation circuitry and the cathode electrode and the stimulation circuitry are both electrically coupled to the negative terminal of the battery.

[0011] Alternatively or additionally to any of the embodiments above, the anode electrode is disposed proximate the second end of the housing.

[0012] Alternatively or additionally to any of the embodiments above, the anode electrode may include a conductive element disposed proximate the second end of the housing, wherein the conductive element is electrically coupled to an anode terminal of the stimulation circuitry.

[0013] Alternatively or additionally to any of the embodiments above, the anode electrode has an anode surface area that is exposed to the environment outside of the housing, and the cathode electrode has a cathode surface area that is exposed to the environment outside of the housing, wherein the anode surface area is at least 2 times greater than the cathode surface area.

[0014] Alternatively or additionally to any of the embodiments above, the housing is an elongated housing with a fixation element proximate the first end of the housing, and the cathode electrode is located on the first end of the housing.

[0015] Alternatively or additionally to any of the embodiments above, the stimulation circuitry may include pacing circuitry and the stimulation pulse may include a pacing pulse.

[0016] In another example of the disclosure, a leadless cardiac pacemaker (LCP) includes a housing having a first end, an opposing second end and a side wall that extends between the first end and the second end. The first end and at least part of the side wall of the housing are conductive and are electrically connected together. A fixation element may be disposed proximate the first end of the housing. At least part of the first end of the housing may be exposed to the environment outside of the housing and may function as a cathode electrode for the LCP. The LCP includes an anode electrode that is spaced from the cathode electrode and is exposed to the environment outside of the housing. Stimulation circuitry may be situated inside the housing and may be operatively coupled to the cathode electrode and the anode electrode, the stimulation circuitry may be configured to provide a stimulation pulse by applying a voltage difference between the cathode electrode and the anode electrode, with a more negative voltage applied to the cathode electrode than to the anode electrode.

[0017] Alternatively or additionally to any of the embodiments above, the LCP may further include a battery situated inside the housing, the battery having a negative terminal and a positive terminal, wherein the negative terminal is coupled to the at least part of the side wall of the housing that is conductive, and thus to the cathode electrode.

[0018] Alternatively or additionally to any of the embodiments above, the battery may be a jelly roll battery, and the housing functions as a battery housing.

[0019] Alternatively or additionally to any of the embodiments above, the LCP may further include an insulator overlaying at least the first end and the at least part of the side wall of the housing that is conductive, except not overlaying the cathode electrode.

[0020] In another example of the disclosure, a leadless cardiac pacemaker (LCP) includes a housing having a first end, an opposing second end and a side wall extending between the first end and the second end. A battery may be situated inside the housing, the battery having a negative terminal and a positive terminal, with the negative terminal operatively coupled to the side wall of the housing. A cathode electrode may be operatively coupled to the negative terminal of the battery through the housing and may be exposed to the environment outside of the housing. An anode electrode may be spaced from the cathode electrode and exposed to the environment outside of the housing. Stimulation circuitry may be situated inside the housing and may be configured to provide a stimulation pulse by applying a voltage difference between the cathode electrode and the anode electrode, with a more negative voltage applied to the cathode electrode than to the anode electrode.

[0021] Alternatively or additionally to any of the embodiments above, the LCP may further include an insulator overlaying at least part of the housing, but not over the cathode electrode or the anode electrode.

[0022] Alternatively or additionally to any of the embodiments above, the anode electrode may be electrically coupled to an anode terminal of the stimulation circuitry and the cathode electrode and the stimulation circuitry may both be electrically coupled to the negative terminal of the battery.

[0023] Alternatively or additionally to any of the embodiments above, the cathode electrode is on the first end of the housing, and the anode electrode is proximate the second end of the housing.

[0024] Alternatively or additionally to any of the embodiments above, the anode electrode has an anode surface area that is exposed to the environment outside of the housing, and the cathode electrode has a cathode surface area that is exposed to the environment outside of the housing, wherein the anode surface area is at least 5 times greater than the cathode surface area.

[0025] The above summary of some embodiments is not intended to describe each disclosed embodiment or every implementation of the present disclosure. The Figures, and Detailed Description, which follow, more particularly exemplify some of these embodiments.

BRIEF DESCRIPTION OF THE FIGURES

[0026] The disclosure may be more completely understood in consideration of the following detailed description in connection with the accompanying drawings, in which:

[0027] FIG. 1 is a perspective view of an illustrative leadless cardiac pacemaker (LCP) in accordance with an embodiment of the disclosure;

[0028] FIG. 2 is a schematic view of the LCP of FIG. 1;

[0029] FIG. 3 is a circuit diagram corresponding to the LCP of FIGS. 1 and 2;

[0030] FIG. 4 is a graphical representation of operation of the circuit diagram of FIG. 3;

[0031] FIG. 5 is a side view of an illustrative leadless cardiac pacemaker (LCP) in accordance with an embodiment of the disclosure;

[0032] FIG. 6 is a schematic view of the LCP of FIG. 5;

[0033] FIG. 7 is a circuit diagram corresponding to the LCP of FIGS. 5 and 6;

[0034] FIG. 8 is a graphical representation of operation of the circuit diagram of FIG. 7; and

[0035] FIG. 9 is a schematic view of an illustrative leadless cardiac pacemaker (LCP) in accordance with an embodiment of the disclosure.

[0036] While the disclosure is amenable to various modifications and alternative forms, specifics thereof have been shown by way of example in the drawings and will be described in detail. It should be understood, however, that the intention is not to limit the disclosure to the particular embodiments described. On the contrary, the intention is to cover all modifications, equivalents, and alternatives falling within the spirit and scope of the disclosure.

DESCRIPTION

[0037] For the following defined terms, these definitions shall be applied, unless a different definition is given in the claims or elsewhere in this specification.

[0038] All numeric values are herein assumed to be modified by the term “about,” whether or not explicitly indicated. The term “about” generally refers to a range of numbers that one of skill in the art would consider equivalent to the recited value (i.e., having the same function or result). In many instances, the terms “about” may include numbers that are rounded to the nearest significant figure.

[0039] The recitation of numerical ranges by endpoints includes all numbers within that range (e.g. 1 to 5 includes 1, 1.5, 2, 2.75, 3, 3.80, 4, and 5).

[0040] As used in this specification and the appended claims, the singular forms “a,” “an,” and “the” include plural referents unless the content clearly dictates otherwise. As used in this specification and the appended claims, the term “or” is generally employed in its sense including “and/or” unless the content clearly dictates otherwise.

[0041] It is noted that references in the specification to “an embodiment,” “some embodiments,” “other embodiments,” etc., indicate that the embodiment described may include one or more particular features, structures, and/or characteristics. However, such recitations do not necessarily mean that all embodiments include the particular features, structures, and/or characteristics. Additionally, when particular features, structures, and/or characteristics are described in connection with one embodiment, it should be understood that such features, structures, and/or characteristics may also be used connection with other embodiments whether or not explicitly described unless clearly stated to the contrary.

[0042] The following detailed description should be read with reference to the drawings in which similar structures in different drawings are numbered the same. The drawings,

which are not necessarily to scale, depict illustrative embodiments and are not intended to limit the scope of the disclosure.

[0043] Cardiac pacemakers provide electrical stimulation to heart tissue to cause the heart to contract and thus pump blood through the vascular system. Conventional pacemakers may include an electrical lead that extends from a pulse generator implanted subcutaneously or sub-muscularly to an electrode positioned adjacent the inside or outside wall of the cardiac chamber. As an alternative to conventional pacemakers, self-contained or leadless cardiac pacemakers have been proposed. Leadless cardiac pacemakers are small capsules that may, for example, be fixed to an intracardiac implant site in a cardiac chamber. In some cases, the small capsule may include bipolar pacing/sensing electrodes, a power source (e.g. an internal battery), and associated electrical circuitry for controlling the pacing/sensing electrodes, and thus may provide electrical stimulation to heart tissue and/or sense a physiological condition. The capsule may be delivered to the heart using a delivery device which may be advanced through a femoral vein, into the inferior vena cava, into the right atrium, through the tricuspid valve, and into the right ventricle.

[0044] The disclosure pertains to leadless stimulation devices. While examples of the disclosure are illustrated as leadless cardiac pacemakers, it will be appreciated that the discussion therein applies equally to a variety of different leadless stimulation devices that may benefit from a reduced form factor relative to onboard battery power, including but not limited to neuro-stimulators and other stimulation devices that may be used to inhibit or encourage particular physiologic activity as a result of providing electrical stimulation to nerves and/or other tissue.

[0045] FIG. 1 is a perspective view of an illustrative leadless cardiac pacemaker (LCP) 10. The LCP 10 includes an outer housing 12 that extends from a proximal end 14 to a distal end 16. In some cases, as illustrated, the proximal end 14 may include a retrieval feature 18. In some cases, as shown, the distal end 16 may include a cathode tip electrode 20 and one or more fixation tines 22. In some instances, a majority of the outer housing 12 is electrically conductive, and part of it may serve as an anode electrode 26. In some cases, an insulation portion 24 may electrically isolate the cathode tip electrode 20 from the rest of the conductive outer housing 12. Alternatively, or in addition, the outer housing 12 may include an electrically insulating coating that extends from the cathode tip electrode 20 to a location 15 that is spaced from the cathode tip electrode 20. The exposed portion of the housing 12 may then function as the anode electrode 26. When so provided, the insulating coating may help define the particular size, location and/or geometry of the anode electrode 26.

[0046] FIG. 2 is a schematic view of the LCP 10 of FIG. 1, showing some of the internal components. While the LCP 10 may include additional components such as one or more sensors, the LCP 10 may be seen as including a battery 28 and circuitry 30. At the distal end 16 of the LCP 10, the cathode electrode 20 may be electrically coupled to the circuitry 30 via a cathodic coupling 32 that passes through a feed through 34 that passes through the conductive outer housing 12. The feed through 34 extends through the outer housing 12 and electrically insulates the cathode electrode 20 from the outer housing 12. An anodic coupling 36 electrically couples the outer housing 12, and thus the anode

electrode 26, to the circuitry 30. In some cases, the anode electrode 36 may have a surface area that is greater than a surface area of the cathode electrode 20. In some cases, the anode electrode 36 may have a surface area that is at least 5 times, 10 times, 20 times or more than that of the cathode electrode 20.

[0047] In the example shown, the battery 28 includes a conductive battery case 38 that is situated inside and separate from the outer housing 12. It will be appreciated that the conductive battery case 38 is cathodic, and is electrically coupled to the circuitry 30 via a battery cathode coupling 42. In some cases, as illustrated, the LCP 10 may include an insulating layer 40 that is disposed between the conductive cathodic battery case 38 and the anodic outer housing 12. The insulating layer 40 may prevent the cathodic battery case 38 from shorting to the anodic outer housing 12. The size of the LCP 10 must be sufficiently large to accommodate the conductive battery case 38 that is situated inside the outer housing 12 and the insulating layer 40 situated therebetween.

[0048] The illustrative battery 28 includes an anode post 44 that is electrically coupled to the circuitry 30 via a battery anode coupling 46. In some cases, the battery 28 may be considered a jelly roll type battery in which an anodic layer is electrically coupled with the anode post 44 and is rolled up with a cathodic layer that is electrically coupled with the conductive battery case 38, with an insulating layer disposed between the anodic layer and the cathodic layer. The jelly roll may be inserted into the conductive battery case 38, with the cathodic layer of the jelly roll making electrical contact with the conductive battery case 38. When so provided, the conductive battery case 38 functions as the cathode terminal of the battery.

[0049] FIG. 3 is a schematic circuit diagram 50 showing some features of the circuitry 30, and in particular, illustrating how the LCP 10 may switch between pacing and tissue recharge. As can be seen, the circuit diagram 50 includes a DC-DC converter 29, which converts the battery voltage received from the battery 28 to a pace pulse voltage. The DC-DC converter 29 charges a pace pulse capacitor 52 to the desired pace pulse voltage. When a pace pulse is to be delivered to the heart H, a pace switch 56 is closed, which connects the anode of the pace pulse capacitor 52 to the anode electrode 26 of the LCP 10, which is coupled to the heart H. Also, a pace/recharge switch 60 is closed, which connects the cathode of the pace pulse capacitor 52 to the cathode tip electrode 20 of the LCP 10, which is also coupled to the heart H at a location that is spaced from the anode electrode 26.

[0050] With reference to FIG. 4, control signal 74 shows the closing of pace switch 56, and control signal 78 shows the closing of pace/recharge switch 60 during a pace pulse time 82. This results in a pace pulse being delivered to the heart H, with a more negative voltage delivered to the cathode tip electrode 20 than the anode electrode 26, as shown by trace 72 of FIG. 4. In some cases, the pace pulse has an initial amplitude that decays slightly over time. This is due to subsequent charging of the tissue of the heart H, represented in circuit diagram 50 by capacitor 21.

[0051] A recharge time 84 follows the pace pulse time 82. During the recharge time 84, the pace switch 56 is opened as shown by control signal 74, and a recharge switch 58 is closed as shown by control signal 76. The pace/recharge switch 60 remains closed as shown by control signal 78.

During the recharge time **84**, the charged tissue of the heart H is discharged, as shown by trace **72** of FIG. **4**. This is illustrated in circuit diagram **50** by the shorting of capacitor **21** and the heart H by recharge switch **58** and pace/recharge switch **60**. After the recharge time **84**, the pace switch **56**, recharge switch **58** and pace/recharge switch **60** are open, as indicated by control signals **74**, **76** and **78**, respectively. The switches may remain open until a next pace pulse is desired. The pace pulse capacitor **52** may be recharged by the DC-DC converter **29** when the pace switch **56** is open, such as during times **80**, **84** and **86**.

[0052] FIG. **5** is a side view of an illustrative LCP **90**. The illustrative LCP **90** includes an outer housing **92** that extends from a proximal end **94** to a distal end **96**. The outer housing **92** may be considered as defining a side wall **93** that extends from the proximal end **94** to the distal end **96**. In some cases, at least part of the outer housing **92** may be considered as being electrically conductive. In some cases, all of the outer housing **92** may be considered as being formed of an electrically conductive material. In some cases, part or all of the outer housing **92** may be formed of a material that is a continuous conductive material. In some cases, as illustrated, the proximal end **94** may include a retrieval feature **97**.

[0053] In some cases, as shown, the distal end **96** may include a cathode tip electrode **100**. The distal end **96** may also include one or more fixation tines **101**. In some instances, all or a majority of the outer housing **92** is electrically conductive and may be cathodically connected to a power source (e.g. internal battery) inside the LCP **90**. The LCP **90** may include an anode electrode **102** that is spaced apart from the cathode tip electrode **100** and that is electrically isolated from the outer housing **92**. In some cases, the anode electrode **102** may be formed of an electrically conductive element such as a conductive film or a conductive metal cap that is disposed on an insulative coating that is provided on the outer housing **92**. The cathode tip electrode **100** and the anode electrode **102** are both electrically exposed to an environment outside of the outer housing **92**. In some cases, the anode electrode **102** may have a surface area that is greater than a surface area of the cathode tip electrode **100**. In some cases, the anode electrode **102** may have a surface area that is at least 2 times, 5 times, 10 times, 20 times or more than that of the cathode tip electrode **100**.

[0054] FIG. **6** is a schematic view of the LCP **90**, showing some of the internal components. While the LCP **90** may include additional components such as one or more sensors, the LCP **90** may be seen as including a battery **104** and circuitry **107**. In some cases, the circuitry **107** may be configured to provide a stimulation pulse by providing a voltage difference between the cathode tip electrode **100** and the anode electrode **102**, with a more negative voltage applied to the cathode tip electrode **100** than to the anode electrode **102**.

[0055] In the example shown, the battery **104** is contained by the outer housing **106**. In some cases, the outer housing **106** may function as the battery case for the battery **104** and the outer housing for the LCP **90**. When so provided, the separate battery case **38** and insulating layer **40** of the LCP **10** of FIG. **2** are not necessary. This may allow the size of the LCP **90** to be reduced relative to the size of the LCP **10**,

or the battery **104** or other components may be larger than the battery **28** or other components of the LCP **10** for a given size device.

[0056] In the example shown in FIG. **6**, the outer housing **106** is cathodic and is electrically coupled to the cathode tip electrode **100**. In some cases, the cathode tip electrode **100** may be directly connected to and/or formed by the outer housing **106**. The circuitry **107** may be electrically connected to the cathode tip electrode **100** via a cathodic coupling **111** extending from the circuitry **107** to the outer housing **92**, and the outer housing **92** may form the rest of the connection to the cathode tip electrode **100**.

[0057] It is contemplated that the outer housing **106** may not only function as the outer housing of the LCP **90**, but may also function as the battery case of the battery **104**. The outer housing **106** may also act as the negative battery terminal of the battery **104**, and as the pace/sense cathode. As can be seen, the outer housing **106** may serve multiple roles. An insulating layer **114** may be provided over the outside of the outer housing **106**, leaving the cathode tip electrode **100** exposed. This may confine the pacing/sensing cathode to the exposed part of the outer housing **106**, namely the cathode tip electrode **100**.

[0058] The battery **104** may include an anode post **108** that provides an anodic electrical connection to the circuitry **107** and may be considered as defining the negative battery terminal. The circuitry **107** may be electrically coupled to the anode electrode **102** via an anodic coupling **110** that passes through a feed through **112**. The feed through **112** may electrically isolate the anodic coupling **110** from the conductive outer housing **92**. In some cases, the anode electrode **102** may be exposed to form an electrical connection to the heart H, and may be electrically isolated from the outer housing **92** via the insulating layer **114**.

[0059] In some cases, the battery **104** may be considered a jelly roll type battery in which an anodic layer is electrically coupled with the anode post **108** and is rolled up with a cathodic layer that is electrically coupled with the outer housing **106**, with an insulating layer disposed between the anodic layer and the cathodic layer. The jelly roll may be inserted into the outer housing **106**, wherein the cathodic layer of the jelly roll may make electrical contact with the outer housing **106**. When so provided, the outer housing **106** may become or function as the cathode terminal of the battery **104**.

[0060] FIG. **7** is a schematic circuit diagram **120** showing some features of the circuitry **107**, and in particular, illustrating how the LCP **90** may switch between pacing and tissue recharge. As can be seen, the circuit diagram **120** includes a DC-DC converter **105**, which converts the battery voltage received from battery **104** to a pace pulse voltage. The DC-DC converter **105** charges a pace pulse capacitor **122** to the desired pace pulse voltage. When a pace pulse is to be delivered to the Heart H, the pace switch **126** and the pace/recharge switch **130** are closed, which collectively connects the anode of the pace pulse capacitor **122** to the anode electrode **102** of the LCP **90**. Regardless of the state of the pace switch **126** and the pace/recharge switch **130**, the cathode tip electrode **100** of the LCP **90** is connected to the cathode of the pace pulse capacitor **122** and to the negative battery terminal. The cathode tip electrode **100** is coupled to the heart H at a location that is spaced from the anode electrode **102**.

[0061] With reference to FIG. 8, control signals 144 and 148 show the closing of pace switch 126 and pace/recharge switch 130, respectively, during pace pulse time 152. This results in a pace pulse being delivered to the heart H, with a more negative voltage delivered to the cathode tip electrode 100 than the anode electrode 102, as shown by trace 142 of FIG. 8. In some cases, the pace pulse has an initial amplitude that decays slightly over time. This is due to subsequent charging of the tissue of the heart H, represented in circuit diagram 120 by capacitor 124.

[0062] After the pacing pulse, and during a recharge time 154, the pace switch 126 is opened as shown by control signal 144, the pace/recharge switch 130 remains closed, and the recharge switch 128 is closed. During the recharge time 154, the charged tissue of the heart H is discharged, as shown by trace 142 of FIG. 8. This is illustrated in circuit diagram 120 by the shorting of capacitor 124 and the heart H by recharge switch 128 and pace/recharge switch 130. After the recharge time 154, the pace switch 126, recharge switch 128 and pace/recharge switch 130 are open, as indicated by control signals 144, 146 and 148, respectively. The switches may remain in the open state until a next pace pulse is desired. The pace pulse capacitor 122 may be recharged by the DC-DC converter 105 when the pace switch 126 is open, such as during times 150, 154 and 156.

[0063] FIG. 9 is a schematic view of a LCP 200 including an outer housing 212. The outer housing 212 extends from a proximal end 214 to a distal end 216. While the LCP 200 may include additional components such as one or more sensors, the LCP 200 may be seen as including a battery 228 and circuitry 230. At the distal end 216 of the LCP 200, a cathode electrode 220 may be electrically coupled to the circuitry 230 via a cathodic coupling 232 that passes through a feed through 234. The feed through 234 extends through the outer housing 212 and electrically insulates the cathode electrode 220 from the outer housing 212. An anodic coupling 236 electrically couples the outer housing 212 to the circuitry 230. An insulating layer 238 extends over a portion of the outer housing 212 and defines an anode electrode 240. So far, this construction is similar to that shown and described above with respect to LCP 10 of FIG. 2.

[0064] The construction of the battery 228 of LCP 200 may be considered as being opposite in polarity to that of the battery 28 shown in FIG. 2. The battery 228 of FIG. 9 includes a cathode post 242 that is electrically coupled to the circuitry 230 via a battery cathode coupling 244. An outer surface 244 of the battery 228 may be considered as being anodic, and may be directly coupled to the conductive outer housing 212.

[0065] In some cases, the battery 228 may be considered a jelly roll type battery in which a cathodic layer is electrically coupled with the cathode post 242 and is rolled up with an anodic layer that is electrically coupled with the outer housing 212, with an insulating layer disposed between the anodic layer and the cathodic layer. The jelly roll may be inserted into the outer housing 212, wherein the anodic layer makes electrical contact with the outer housing 212. When so provided, the outer housing 212 may function as the anode terminal of the battery 228.

[0066] It should be understood that this disclosure is, in many respects, only illustrative. Changes may be made in details, particularly in matters of shape, size, and arrangement of steps without exceeding the scope of the disclosure.

This may include, to the extent that it is appropriate, the use of any of the features of one example embodiment being used in other embodiments.

What is claimed is:

1. A leadless stimulation device (LSD), comprising:
 - a housing having a first end, an opposing second end and a side wall extending between the first end and the second end;
 - the first end and at least part of the side wall of the housing are conductive, with at least part of the housing that is conductive functioning as a cathode electrode for the LSD, wherein the cathode electrode is exposed to the environment outside of the housing;
 - an anode electrode, spaced from the cathode electrode, exposed to the environment outside of the housing;
 - a battery situated inside the housing, the battery having a negative terminal and a positive terminal, with the negative terminal operatively coupled to the at least part of the housing that is conductive including the cathode electrode; and
 - stimulation circuitry situated inside the housing and operatively coupled to the cathode electrode and the anode electrode, the stimulation circuitry configured to provide a stimulation pulse by applying a voltage difference between the cathode electrode and the anode electrode, with a more negative voltage applied to the cathode electrode than to the anode electrode.
2. The LSD of claim 1, wherein the negative terminal of the battery is electrically connected to an inside surface of the at least part of the side wall of the housing that is conductive.
3. The LSD of claim 1, wherein the first end and the at least part of the side wall of the housing that is conductive comprise a continuous conductive material.
4. The LSD of claim 1, further comprising an insulator overlaying at least the first end and the at least part of the side wall of the housing that is conductive, except not overlaying the cathode electrode.
5. The LSD of claim 1, wherein the anode electrode is electrically insulated from the first end and the at least part of the side wall of the housing that is conductive.
6. The LSD of claim 5, wherein:
 - the anode electrode is electrically coupled to an anode terminal of the stimulation circuitry; and
 - the cathode electrode and the stimulation circuitry are both electrically coupled to the negative terminal of the battery.
7. The LSD of claim 1, wherein the anode electrode is disposed proximate the second end of the housing.
8. The LSD of claim 1, wherein the anode electrode comprises a conductive element disposed proximate the second end of the housing, wherein the conductive element is electrically coupled to an anode terminal of the stimulation circuitry.
9. The LSD of claim 1, wherein the anode electrode has an anode surface area that is exposed to the environment outside of the housing, and the cathode electrode has a cathode surface area that is exposed to the environment outside of the housing, wherein the anode surface area is at least 2 times greater than the cathode surface area.
10. The LSD of claim 1, wherein the housing is an elongated housing with a fixation element proximate the first end of the housing, and the cathode electrode is located on the first end of the housing.

11. The LSD of claim 1, wherein the stimulation circuitry comprises pacing circuitry and the stimulation pulse comprises a pacing pulse.

12. A leadless cardiac pacemaker (LCP), comprising:
 a housing having a first end, an opposing second end and a side wall extending between the first end and the second end, wherein the first end and at least part of the side wall of the housing are conductive and electrically connected together;
 a fixation element proximate the first end of the housing; at least part of the first end of the housing is exposed to the environment outside of the housing and functions as a cathode electrode for the LCP;
 an anode electrode, spaced from the cathode electrode, and exposed to the environment outside of the housing; and
 stimulation circuitry situated inside the housing and operatively coupled to the cathode electrode and the anode electrode, the stimulation circuitry configured to provide a stimulation pulse by applying a voltage difference between the cathode electrode and the anode electrode, with a more negative voltage applied to the cathode electrode than to the anode electrode.

13. The LCP of claim 12, further comprising a battery situated inside the housing, the battery having a negative terminal and a positive terminal, wherein the negative terminal is coupled to the at least part of the side wall of the housing that is conductive, and thus to the cathode electrode.

14. The LCP of claim 13, wherein the battery is a jelly roll battery, and the housing functions as a battery housing.

15. The LCP of claim 12, further comprising an insulator overlaying at least the first end and the at least part of the side wall of the housing that is conductive, except not overlaying the cathode electrode.

16. A leadless cardiac pacemaker (LCP), comprising:
 a housing having a first end, an opposing second end and a side wall extending between the first end and the second end;

a battery situated inside the housing, the battery having a negative terminal and a positive terminal, with the negative terminal operatively coupled to the side wall of the housing;

a cathode electrode operatively coupled to the negative terminal of the battery through the housing, the cathode electrode exposed to the environment outside of the housing;

an anode electrode, spaced from the cathode electrode, exposed to the environment outside of the housing; and

stimulation circuitry situated inside the housing, the stimulation circuitry configured to provide a stimulation pulse by applying a voltage difference between the cathode electrode and the anode electrode, with a more negative voltage applied to the cathode electrode than to the anode electrode.

17. The LCP of claim 16, further comprising an insulator overlaying at least part of the housing, but not over the cathode electrode or the anode electrode.

18. The LCP of claim 16, wherein:

the anode electrode is electrically coupled to an anode terminal of the stimulation circuitry; and

the cathode electrode and the stimulation circuitry are both electrically coupled to the negative terminal of the battery.

19. The LCP of claim 16, wherein the cathode electrode is on the first end of the housing, and the anode electrode is proximate the second end of the housing.

20. The LCP of claim 16, wherein the anode electrode has an anode surface area that is exposed to the environment outside of the housing, and the cathode electrode has a cathode surface area that is exposed to the environment outside of the housing, wherein the anode surface area is at least 5 times greater than the cathode surface area.

* * * * *

专利名称(译)	无引线刺激装置，具有容纳无引线刺激装置的内部部件的壳体，并且用作电池壳体和内部电池的端子		
公开(公告)号	US20180078775A1	公开(公告)日	2018-03-22
申请号	US15/699578	申请日	2017-09-08
[标]申请(专利权)人(译)	心脏起搏器股份公司		
申请(专利权)人(译)	心脏起搏器，INC.		
当前申请(专利权)人(译)	心脏起搏器，INC.		
[标]发明人	LINDER WILLIAM J MAILE KEITH R		
发明人	LINDER, WILLIAM J. MAILE, KEITH R.		
IPC分类号	A61N1/375 A61N1/378 A61B5/042 A61B5/00 A61N1/05 A61N1/372		
CPC分类号	A61N1/3756 A61N1/378 A61B5/0422 A61B5/686 A61N1/05 A61N1/37205 A61N1/3758 H01M2/022 H01M10/0422 H01M2220/30		
优先权	62/397882 2016-09-21 US		
外部链接	Espacenet USPTO		

摘要(译)

可植入的医疗设备，例如无引线刺激设备，可以提供更长的电池寿命，同时最小化设备尺寸。在一些情况下，使可植入医疗装置的外壳具有多种作用，例如用于内部电池的电池盒，可通过消除装置内的一个或多个层或部件而允许减小装置尺寸。

