



US010028658B2

(12) **United States Patent**  
**Wang et al.**

(10) **Patent No.: US 10,028,658 B2**  
(45) **Date of Patent: Jul. 24, 2018**

(54) **IMAGER FOR MEDICAL DEVICE**

(56) **References Cited**

(71) Applicant: **Welch Allyn, Inc.**, Skaneateles Falls, NY (US)

U.S. PATENT DOCUMENTS

(72) Inventors: **Ynjiun Paul Wang**, Cupertino, CA (US); **Chee Keen Lai**, Singapore (SG); **Jeffrey H. Schmidt**, Manlius, NY (US)

4,121,574 A	10/1978	Lester	
6,909,793 B1 *	6/2005	Mori .....	A61B 5/02055 348/14.07
7,967,190 B2	6/2011	Hussey	
8,243,940 B2	8/2012	Smith	
8,442,607 B2	5/2013	Banet	

(Continued)

(73) Assignee: **WELCH ALLYN, INC.**, Skaneateles Falls, NY (US)

FOREIGN PATENT DOCUMENTS

(\* ) Notice: Subject to any disclaimer, the term of this patent is extended or adjusted under 35 U.S.C. 154(b) by 431 days.

GB 2408103 5/2005

OTHER PUBLICATIONS

(21) Appl. No.: **14/143,448**

Julian C.P. Cheung, Fully Automated Thermometer Calibration System at the Standards and Calibration Laboratory (SCL), The Government of the Hong Kong Special Administrative Region Standards and Calibration Laboratory (SCL), presented at Metrology in a Fast Paced Society Workshop & Symposium, NCSL International Workshop and Symposium, Jul. 17, 2013, 24 pages.

(22) Filed: **Dec. 30, 2013**

(65) **Prior Publication Data**

US 2015/0182114 A1 Jul. 2, 2015

(Continued)

(51) **Int. Cl.**

Primary Examiner — Michael C Stout

<b>A61B 5/00</b>	(2006.01)
<b>G06K 9/00</b>	(2006.01)
<b>H04M 1/02</b>	(2006.01)
<b>A61B 90/96</b>	(2016.01)
<b>A61B 90/90</b>	(2016.01)
<b>A61B 5/01</b>	(2006.01)
<b>G06K 9/32</b>	(2006.01)

(74) *Attorney, Agent, or Firm* — Merchant & Gould, P.C.

(52) **U.S. Cl.**

CPC ..... **A61B 5/0008** (2013.01); **A61B 5/742** (2013.01); **A61B 90/90** (2016.02); **A61B 90/96** (2016.02); **A61B 5/01** (2013.01); **G06K 9/3258** (2013.01); **H04M 2250/52** (2013.01)

(57) **ABSTRACT**

(58) **Field of Classification Search**

CPC ..... G06K 9/325–9/3258  
USPC ..... 600/300  
See application file for complete search history.

A system for transmitting a temperature of a patient to an electronic medical record associated with the patient includes a thermometer with a digital display that is configured to display a temperature value associated with the temperature signal and at least one error-checking value. The system also includes a handheld imaging device including a camera to capture an image of the digital display of the thermometer, a processor to extract the text in the image using optical character recognition, and perform an error-check on the temperature value using the at least one error-checking value in the image, and to transmit the patient's identification number and temperature to an electronic medical record system.

**7 Claims, 7 Drawing Sheets**

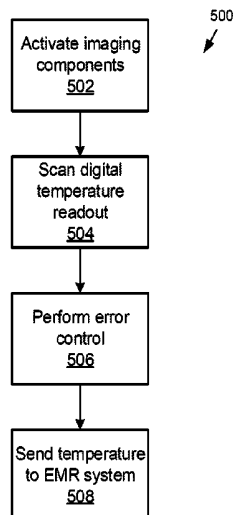

(56)

**References Cited**

U.S. PATENT DOCUMENTS

2003/0034900 A1\* 2/2003 Han ..... G01D 4/004  
340/870.02

2003/0163287 A1\* 8/2003 Vock ..... A43B 3/0005  
702/187

2004/0034779 A1 2/2004 Wood et al.

2005/0035877 A1\* 2/2005 Kim ..... H04Q 9/00  
340/870.02

2007/0080223 A1 4/2007 Japuntich

2007/0174152 A1 7/2007 Bjornberg

2007/0282208 A1 12/2007 Jacobs

2008/0011847 A1 1/2008 Silverbrook et al.

2008/0221396 A1 9/2008 Garces

2008/0262376 A1\* 10/2008 Price ..... A61B 5/0002  
600/547

2009/0192813 A1\* 7/2009 Gejdos ..... G06F 19/323

2009/0326410 A1\* 12/2009 James ..... A61B 10/0012  
600/551

2010/0182631 A1\* 7/2010 King ..... G06F 17/243  
358/1.15

2010/0204596 A1\* 8/2010 Knutsson ..... A61B 5/02055  
600/509

2011/0028799 A1 2/2011 Banet

2011/0082711 A1 4/2011 Poeze

2012/0179006 A1\* 7/2012 Jansen ..... A61B 5/0537  
600/301

2012/0226771 A1 9/2012 Harrington et al.

2012/0298755 A1\* 11/2012 Lu ..... G06K 7/12  
235/468

2012/0323590 A1 12/2012 Udani

2013/0116515 A1 5/2013 Banet

2013/0173968 A1\* 7/2013 McVey ..... G06F 11/0004  
714/49

2013/0191513 A1 7/2013 Kamen

2013/0197320 A1 8/2013 Albert et al.

2013/0207812 A1\* 8/2013 Heydlauf ..... G01N 35/00871  
340/691.6

2013/0234850 A1\* 9/2013 Lee ..... A61B 5/02  
340/539.12

2013/0267809 A1\* 10/2013 Brister ..... A61B 5/14865  
600/347

2013/0281801 A1 10/2013 Proud

2014/0098209 A1\* 4/2014 Neff ..... A61B 5/0033  
348/77

2014/0155755 A1\* 6/2014 Pinter ..... A61B 5/0008  
600/474

2014/0237342 A1\* 8/2014 King ..... G06F 17/30876  
715/224

2014/0320677 A1\* 10/2014 Jarvenpaa ..... H04N 5/23203  
348/207.11

2015/0085155 A1\* 3/2015 Diaz Spindola ..... G06T 19/006  
348/222.1

2015/0145693 A1\* 5/2015 Toriumi ..... A61B 5/746  
340/870.17

OTHER PUBLICATIONS

International Search Report and Written Opinion in PCT/US2014/067344 dated Mar. 25, 2015, 20 pages.

\* cited by examiner

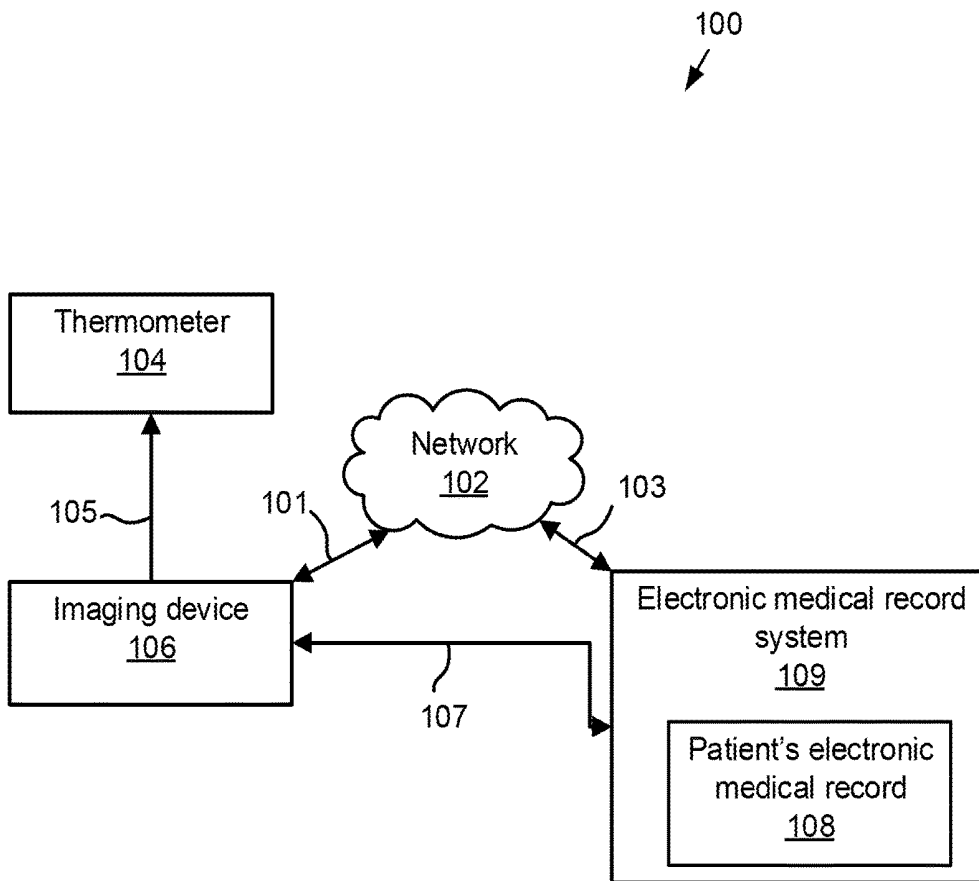

**FIG. 1**

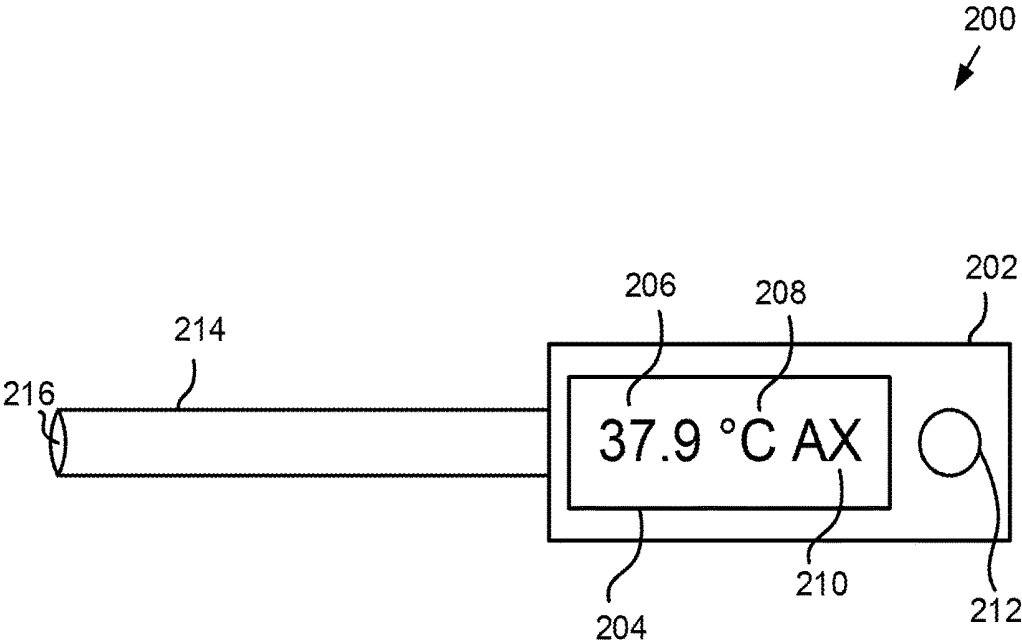

**FIG. 2**

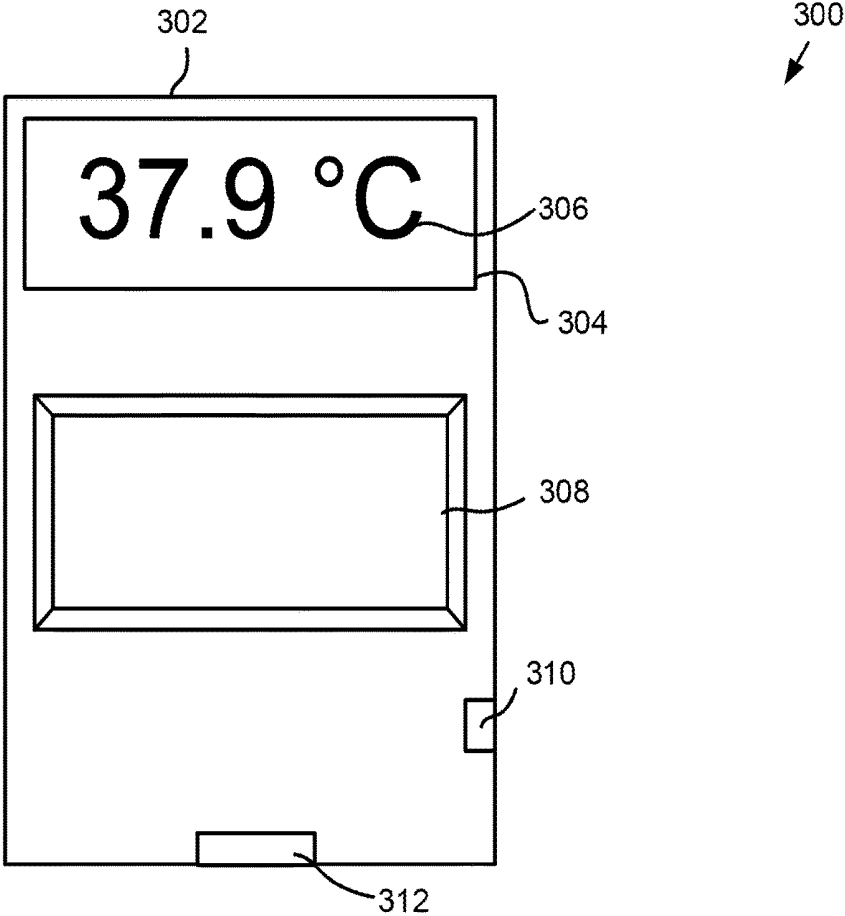

**FIG. 3**

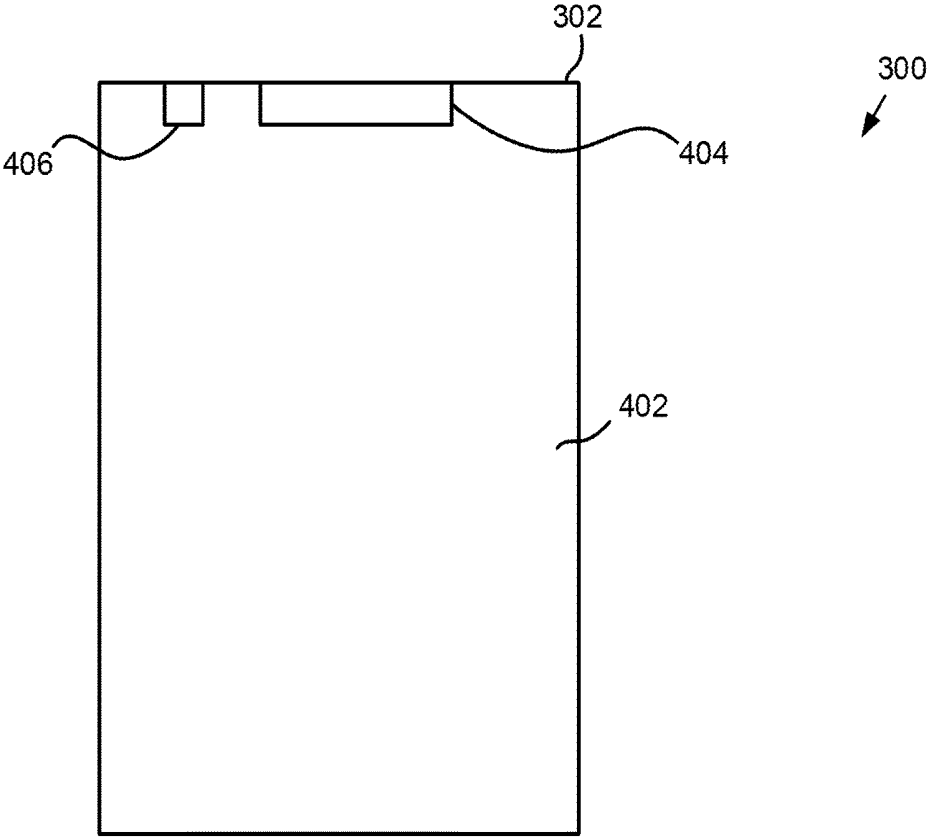

**FIG. 4**

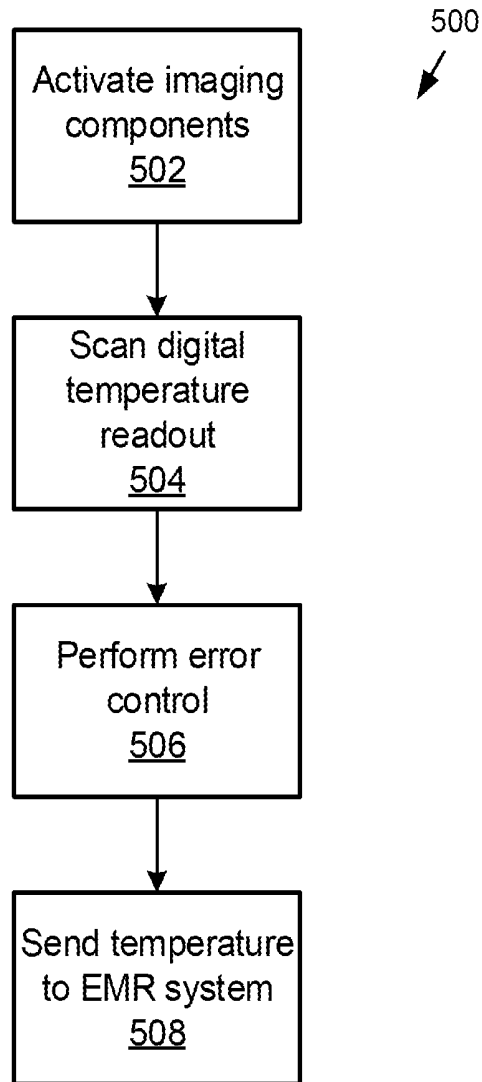

**FIG. 5**

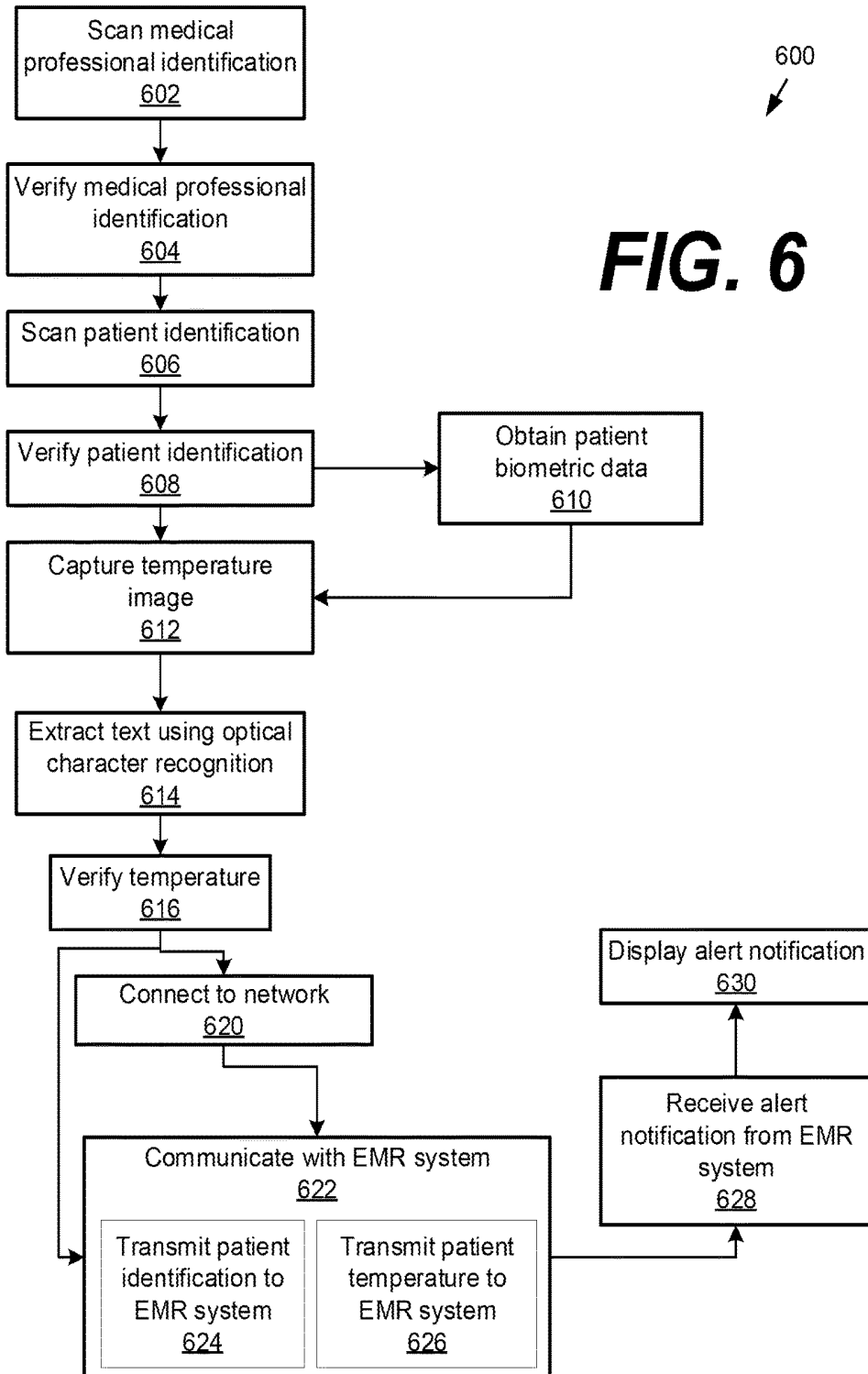

**FIG. 6**

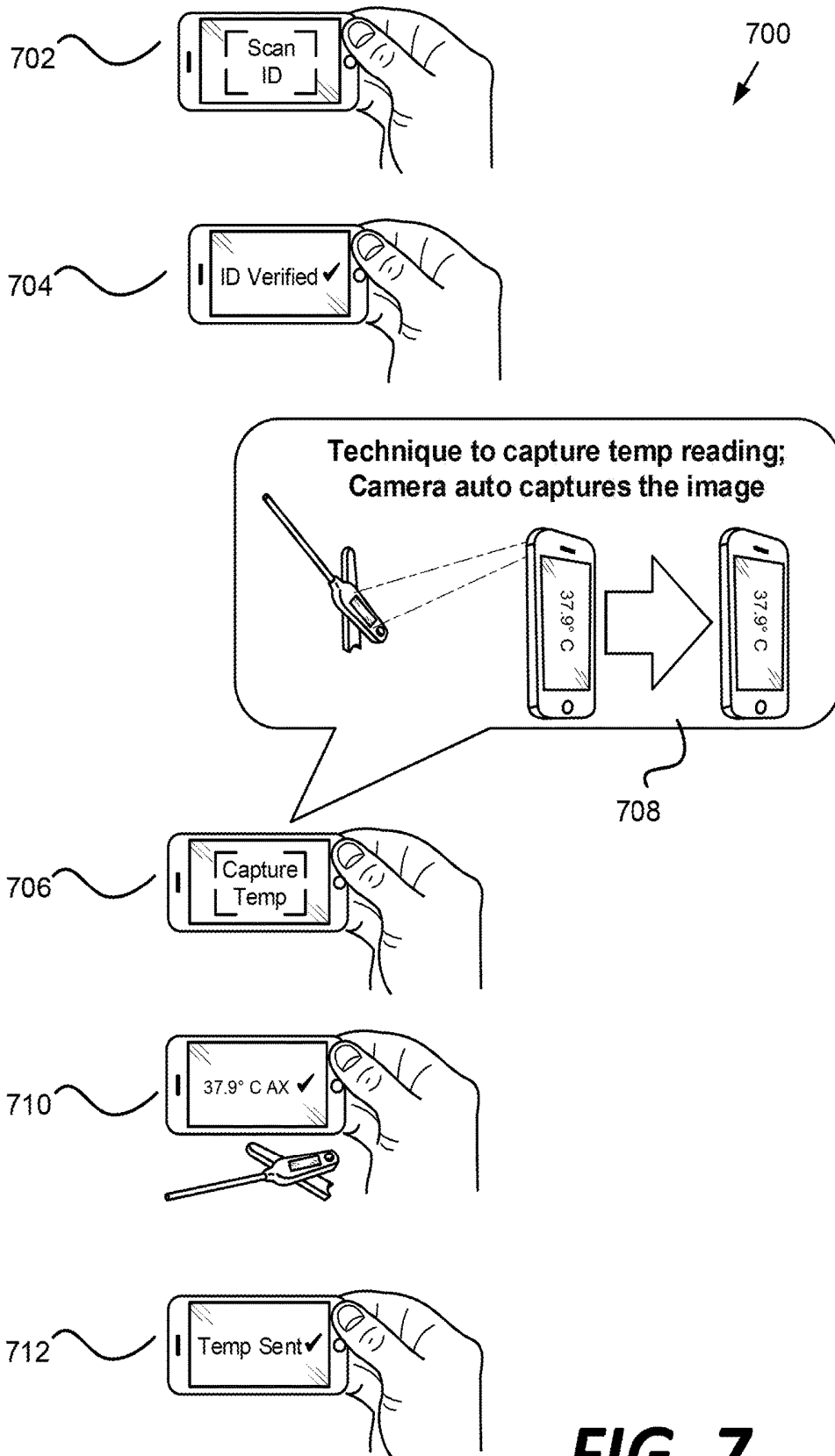

**FIG. 7**

## IMAGER FOR MEDICAL DEVICE

## BACKGROUND

Many medical situations require taking the vital signs of a patient, such as the temperature of the patient. In some instances, the historical temperature trend of the patient must be monitored. Sometimes, the medical personnel taking the temperature are not the same as the medical personnel that diagnose the one or more conditions affecting the patient. Current thermometers do not provide an inexpensive and easy way to capture these temperature readings.

## SUMMARY

In one aspect, a handheld imaging device is provided. The imaging device includes a housing, a camera supported by the housing and configured to capture an image containing text including both a value representing a physiological measurement and a checksum value, a processor operatively coupled to the camera, and configured to extract the text in the image using optical character recognition, and a network connection unit operatively coupled to the processor, where the network connection unit is configured to communicate with an electronic medical record system and to transmit at least some of the extracted text to the electronic medical record system.

Additionally, the handheld imaging device includes a processor configured to perform an error-control using the at least one checksum value in the image. The error-control can also include using an error detection function to verify an integrity of the value representing the physiological measurement, and an error correction function to correct any errors in the value representing the physiological measurement. The imaging device camera can be configured to image a temperature reading provided by a thermometer, a barcode, a quick response code, or a Microsoft® tag. The imaging device, whose housing can be a key fob, can communicate with the electronic medical system wirelessly.

Also provided is a system for transmitting a temperature of a patient to an electronic medical record associated with the patient. The system includes the handheld imaging device and a thermometer. The thermometer includes a housing, a temperature sensor, a digital display configured to display a temperature value associated with the temperature signal and at least one error-checking value. The digital display can be an e-ink display. The error checking value can be a checksum character. Also, the error checking can be performed using cyclic redundancy check-16 (CRC-16) or a Reed-Solomon error correction code.

Additionally, the electronic medical record system inputs the temperature value into the electronic medical record associated with the patient. The camera of the handheld imaging device can be further configured to capture a second image comprising a patient identifier. The patient identifier can be affixed to a patient wrist band or a patient bed.

Also provided is a method of sending a temperature of a patient to an electronic medical record associated with the patient. The method includes measuring the temperature of the patient using the thermometer, capturing an image of the display of the thermometer using a handheld image capture device, extracting text in the image using optical character recognition, checking the temperature in the extracted text using the error-checking value, and transmitting at least some of the extracted text to the electronic medical record system.

The method can also include scanning an identification code of the patient using the handheld image capture device and verifying an identity of the patient. Verifying the identity can include obtaining biometric data of the patient, such as an image of a face, an eye, or a fingerprint of the patient. The method can also include receiving an alert notification, where the alert notification is textual or color-based, and where the handheld image capture device displays the alert notification if the temperature is above a maximum temperature threshold or below a minimum temperature threshold.

## DESCRIPTION OF THE FIGURES

FIG. 1 illustrates one embodiment of an imager and thermometer system including a network, a thermometer, an imaging device, and an electronic medical record.

FIG. 2 illustrates one embodiment of a basic digital thermometer sensor.

FIG. 3 illustrates a front view of one embodiment of a hand-held imaging device.

FIG. 4 illustrates a rear view of one embodiment of the hand-held imaging device.

FIG. 5 is a flow chart of an example method of the steps a medical professional performs while operating the hand-held imaging device.

FIG. 6 is a flow chart of an example method of the operation of the hand-held imaging device.

FIG. 7 is an example graphical user interface illustrating multiple displays during the operation of the hand-held imaging device.

## DETAILED DESCRIPTION

FIG. 1 is a schematic block diagram illustrating an example system 100 for recording and entering a measured temperature into an electronic medical record. In this example, the system 100 includes a network 102, a medical device, such as a thermometer 104, an imaging device 106, and an electronic medical record 108 of a patient maintained by an electronic medical record system 109. In the example system, the imaging device 106 and the electronic medical record system 109 are in communication either directly via communication path 107 or via the network 102 using wired and/or wireless communication schemes.

Although the examples provided herein are described with respect to a thermometer, the systems and methods are equally applicable to any other medical devices that capture and display vital signs of a patient, such as, for example, a pulse oximeter, an electrocardiograph, blood pressure monitor, etc.

The example thermometer 104 functions to capture a temperature signal, preferably of a patient. The example thermometer is shown in more detail in FIG. 2, which is described further below.

The example imaging device 106 functions to capture the temperature signal of the thermometer 104. In one embodiment, the example imaging device 106 communicates the temperature signal directly via communication path 107 to the electronic medical record 108. In some embodiments, the direct connection via communication path 107 between the imaging device and the electronic medical record system 109 occurs via a universal serial bus (USB) connecting cable in batch mode. In some embodiments, the transfer of information occurs when imaging device 106 is placed in a receiving dock (not pictured), where the receiv-

ing dock is in direct communication with the electronic medical record system. Other direct communication configurations are possible.

In one embodiment, the imaging device **106** is connected to the network **102** (connection **101**). The network **102** is, in turn, connected to the electronic medical record system **109** (connection **103**). The connections **101** and **103** may include any type of wireless network, a wired network, or any communication network known in the art. For example, wireless connections can include cellular network connections and connections made using protocols such as 802.11a, b, and/or g. In other examples, a wireless connection can be accomplished directly between the imaging device **106** and the electronic medical record system **109** using one or more wired or wireless protocols, such as Bluetooth, Wi-Fi Direct, radio-frequency identification (RFID), or Zigbee. Other configurations are possible.

In one embodiment, the imaging device **106** is a dedicated device that is configured to perform the operations described herein. In other embodiments, the imaging device **106** is a mobile device such as a smart phone (e.g., cellular telephone) or a computer tablet, where the mobile device performs the methods and operations described herein while running an application configured to control the operation of the mobile device.

The example electronic medical record system **109** includes the hardware and software required for receiving the communication of the temperature signal from the imaging device **106** and storing the signal in the patient's electronic medical record **108**. In some embodiments, the electronic medical record system **109** is configured to transmit an alert to the imaging device **106** after receiving the temperature signal via the direct via communication path **107** or over the network connection **101** and **103**. Electronic medical records (EMR) are alternatively known as electronic health records (EHR) or personal health records (PHR), and these three terms can be used interchangeably for the purposes of this document.

The example electronic medical record system **109** includes a processor and memory. In some embodiments, the memory may be stored on a remote device and accessed over a communications network. In some embodiments, the electronic medical record system **109** functions as a central processing unit or server. As described further herein, the electronic medical record system **109** is programmed to store a plurality of medical records so that the records can be created, accessed, and updated.

The example electronic medical record **108** is a record corresponding to a specific patient. Example methods of communicating a temperature signal from the imaging device **106** to the electronic medical record system **109** are shown in FIGS. **5** and **6**, which are described further below. In some embodiments the electronic medical record **108** contains the vital information of a patient, such as previous measurements of the patient's blood pressure, heart rate, temperature, allergies, medications, previous diagnoses, etc. The electronic medical record **108** can be stored, accessed, and updated using a variety of known techniques.

FIG. **2** illustrates an example of a basic digital thermometer sensor **200**. In this example, the thermometer **200** includes a housing **202**, a digital display **204**, where the display includes a digital temperature reading **206**, the temperature unit **208**, and one or more error-checking values **210**. The housing also includes a button **212** to initiate a temperature measurement. Attached to the housing is an electronic sensor housing **214** that supports an electronic

temperature sensor **216**. In a preferred embodiment, the thermometer sensor **200** is inexpensively produced.

Thermometer housing **202** supports the display **204**, the electronic sensor housing **214**, and the button **212** used to initiate a temperature measurement. Additionally, the thermometer housing **202** encloses the components required to, for example, initiate a temperature signal measurement, convert the temperature signal to a digital display **206**, generate error-checking values **210**, toggle between temperature units **208**, monitor battery life, power the digital display **204**, and turn off the digital display **204**. Additional operations are possible. The components required to perform the operation of the thermometer **200**, not pictured in FIG. **2**, include, for example, a memory coupled to a processor, which is in turn coupled to the display **204**, all of which are powered by a battery that is, for example, rechargeable or a replaceable single use battery.

The thermometer housing **202** is constructed of an inexpensive material, such as, for example, plastic. As depicted in FIG. **2**, the thermometer housing **202** is, in some embodiments, shaped as a rectangular prism. Other configurations of the thermometer housing **202** are possible. For example, the thermometer housing **202** is, in some embodiments, shaped like other polyhedra. In other embodiments, the thermometer housing **202** is a continuous shape with the electronic sensor housing **214**, such that the two housings, **202** and **214**, appear integral to each other.

The digital display **204** includes a digital temperature **206**, the units of the temperature **208**, and one or more error-checking values **210**. The digital display **204** is, in some embodiments, a liquid-crystal display (LCD), an organic light-emitting diode (OLED) display, or an e-ink display. In a preferred embodiment, the digital display **204** is an e-ink display.

The digital temperature **206** is the measurement of the electronic sensor displayed as, in some embodiments, Arabic numerals in sans-serif or serif typeface. The digital temperature **206** is displayed, for example, with accuracy to the ones, tenths, or hundredths place. In a preferred embodiment, the digital temperature **206** is displayed to the tenths place.

The units **208** of the digital temperature **206** are located adjacent to the temperature **206** in the digital display **204**. The units **208** include, for example, the degree symbol ( $^{\circ}$ ) and an abbreviation of the unit. In most embodiments, the units **208** are either degrees Celsius, displayed as “ $^{\circ}$  C.” or degrees Fahrenheit, displayed as “ $^{\circ}$  F.”. Conceivably, the thermometer **200** could be configured to display a lesser-used unit, such as Kelvin.

The one or more error-checking values **210** also appear in the example embodiment's display **204**. In some embodiments, the error-checking values **210** appear adjacent to the temperature units **208** in the digital display **204**. In some embodiments, the error-checking values **210** are one or more characters. In one embodiment, the error-checking values **210** are two characters. The error-checking values **210** can be any type of conventional error-checking values, such as, for example, checksum characters, or characters associated with checksum algorithms such as cyclic redundancy checks (CRC), Fletcher's checksum, or Adler-32. In the embodiments employing error correction algorithms, the checksum characters can be error correction codewords such as Reed Solomon Error Correction codes. In the embodiment where the medical device is an electrocardiograph, the electrocardiogram (ECG) graph can be encoded with a checksum barcode to depict the ECG resolution and image pixel level

error correction, or, the entire ECG graph could be encoded in the barcode or 2-dimensional code displayed on the screen.

Button **212** initiates a temperature measurement by the sensor **216**. In most embodiments, the button **212** is a physical button supported by the thermometer housing **202**. In some embodiments, the button can be a screen button such as a touch screen button. Button **212** is operatively coupled to the temperature sensor **216** so that, in most embodiments, the temperature sensor **216** initiates a temperature measurement protocol when a user depresses the button **212**.

The example button **212** in FIG. **2** is circular in shape, but other shapes, such as triangles, rectangles, and squares, are contemplated. Also, additional locations for the button **212** are possible on the housing **202**, such as, for example, on the distal end from the sensor, on the surface opposite the display **204**, and on the same surface as the display **204** but in a different configuration.

The electronic sensor housing **214** supports the electronic temperature sensor **216**. As discussed above, the electronic sensor housing **214** is, in some embodiments, a separate component that is attached to the thermometer housing **202**, or, in other embodiments, integral with the thermometer housing **202**. In most embodiments, the electronic sensor housing **214** is constructed of plastic or thin metal.

The positional relationship of the electronic temperature sensor **216** and the electronic sensor housing **214** varies by embodiment. In one embodiment, the sensor **216** is located on the distal end of the housing **214**. In another embodiment, multiple sensors **216** are located along the exterior of a longitudinal axis of the housings **214**. Regardless of configuration, the one or more temperature sensors **216** are operatively connected to the thermometer's processor.

The electronic temperature sensor **216** is disposed in the example embodiment on the end of the sensor housing **214**. As mentioned, one or more sensors **216** are employed in alternate embodiments and located at various positions along the housing **214**. The electronic temperature sensor **216** is for example, a thermistor, a silicon bandgap temperature sensor, a thermocouple, or a resistance thermometer. Non-contact thermometers can also be used, such as a non-contact infrared thermometer with a display including a checksum.

FIG. **3** illustrates a front view of an example imaging device **300** for capturing the temperature measured and displayed by the thermometer **200** and transmitting the temperature to the electronic medical record system **109**. A rear view of the example imaging device **300** is provided in FIG. **4**. In this example, the imaging device **300** includes a housing **302**, a display **304** that includes text **306**, a button **308**, a USB port **310**, and a microphone **312**. Alternate embodiments can include additional buttons or may not include the USB port **310** or the microphone **312**. In other embodiments, the imaging device **300** is a mobile phone or tablet PC.

In this example, the imaging device housing **302** supports the display **304**, the button **308**, the USB port **310**, and the microphone **312**. The housing **302** can be constructed of an inexpensive, lightweight material, such as a plastic or a composite material. In most embodiments, the housing is shaped as a rectangular prism with rounded edges. In other embodiments, the housing is more curved, such as, for example, an elliptical prism.

The example housing **302** contains the components necessary for the functions performed by the imaging device **300**. In some embodiments, these components, not pictured

in FIG. **3**, include, for example, a memory, a processor operatively coupled to the memory and the display **304**, and a wireless communication unit including components necessary for wireless communication, such as Bluetooth, Zigbee, Wi-Fi, Wi-Fi Direct, and radio-frequency identification (RFID).

In some embodiments, the housing **302** is a key fob. In most embodiments, the housing is sized to be held in one hand, to be light weight, and to fit in a pocket. In some embodiments, the housing also contains components configured to provide tactile and auidial feedback, such as vibrations and sounds, respectively.

In the example embodiment **300**, the imaging device also has a display **304**. The display **304** is, in some embodiments, a liquid-crystal display (LCD) or an organic light-emitting diode (OLED) display. The size and resolution of the display **304** varies in different embodiments, but in all embodiments, the display is capable of displaying text **306**. For example, in one embodiment, the display **304** is capable of displaying color and at least four lines of readable text.

In the example embodiment **300**, the imaging device also has a button **308**. Button **308** is used, in the example embodiment, to initiate an image scan and to interact with instructions or prompts on the screen **304**. The size and location of the button vary in different embodiments. Some embodiments have a touch screen that displays a button. In some embodiments, the housing **302** or screen **304** have more than one buttons, used for operations such as, for example, connecting the device to a wireless network, such as Bluetooth or Wi-Fi, or to respond and interact with other on-screen prompts and messages.

In the example embodiment **300**, the imaging device also has a USB port **310**. The USB port **310** is located on the side of the housing in example embodiment **300**, but the port **310** can be positioned in other locations on the housing. In a preferred embodiment, the imaging device **300** has a rechargeable battery that can be recharged through the USB port **310**. In some embodiments, the USB port **310** is used to directly connect the imaging device **300** to a dock (not pictured), to the EMR system **109** (not pictured), or any peripheral device (not pictured). USB port **310** may be any size, standard, micro, or mini, or any standard, 1.0, 2.0, or 3.0, for example.

In the example embodiment **300**, the imaging device also has a microphone **312**. Microphone **312** is an optional component in the imaging device **300**. In some embodiments, the imaging device **300** processor is configured to perform voice recognition processing. In those embodiments, the user may state audibly the patient's identification or temperature as an additional error check or in place of scanning the thermometer reading.

FIG. **4** illustrates a rear view of example imaging device **300**. In this example, the imaging device **300** includes a housing **302** with a rear surface **402**, as well as an imaging component **404** and a light source **406**. In some embodiments, the imaging device **300** is powered by a replaceable battery; the access point for replacing the battery is contemplated to be on the rear surface **402**.

As shown in FIG. **4**, the imaging component has an operative plane that is parallel to the rear surface of the housing **302**. In alternate embodiments, the imaging component **404** operational plane is normal to the rear surface of the housing **302**. As discussed above, in some embodiments, the imaging device is a cellular phone or computer tablet. In those embodiments, the imaging device is the camera component in the mobile phone or computer tablet.

In this example, the imaging component **404** includes a camera, including, for example, a lens, a sensor array operatively coupled to the processor and memory in the housing **302**. In some embodiments, the camera is configured to automatically focus. Additionally, in this embodiment, the imaging component **404** is operatively coupled to button **308**, whereupon the imaging process begins when the user depresses button **308**.

In other embodiments, the imaging component **404** includes a visible light-emitting diode, for example, a 650 nm red light-emitting diode or other wavelengths, such as a white light-emitting diode (LED). A lens and a sensor array to receive the reflected LED light, such as, for example, a complementary metal-oxide semiconductor (CMOS), are also provided in these embodiments.

In this example, the imaging component **404** is capable of reading both alphanumeric characters as well as any type of bar code, such as linear bar codes, QR codes, and Microsoft® tags.

In some embodiments, the imaging device **300** includes an illumination source. In some embodiments, the illumination source is at least one light-emitting diode (LED) operatively coupled to the processor, memory, and imaging component **404**.

FIG. **5** illustrates a flow chart of an example method **500** of using the imaging device **106**. The example method **500** includes activating the imaging components **502**, scanning the digital temperature readout **504**, performing error control **506**, and sending the temperature to the electronic medical record (EMR) system **508**.

In this embodiment, the use begins by the user activating the imaging components **502**. In a preferred embodiment, the user is a medical professional, such as a nurse, nurse practitioner, physician's assistant, medical student, resident physician, or physician. In many circumstances, the use will occur in a medical facility, such as a clinic or hospital, but none of the methods or uses disclosed herein are limited to being used within a medical facility. At some point in time prior to or concurrent with example method **500**, a medical professional will have taken the temperature of the patient. The medical professional taking the temperature of the patient using the thermometer **200** is, in some embodiments, the same professional performing example method **500**. In other embodiments, different medical professionals perform the temperature measurement and the example method **500**.

Activating the imaging components **502** includes, in some embodiments, the initial setup of the imaging device **106**. Initial setup includes, in some embodiments, activating the wireless connectivity of the device **106** to the network **102**, activating and syncing the Bluetooth connection with the electronic medical records system **109**, and calibrating the imaging component **404**. In some embodiments, the imaging device **106** is turned on, or awakened from a sleep or hibernate mode, by pressing button **308**. Some embodiments have a dedicated on/off button. Other configurations are possible.

The next step in the example method is for the user to scan the digital temperature readout **504**. In one embodiment, the user initiates the scan by pressing button **308** and aiming the imaging component **404** towards the temperature readout. In some embodiments, the user holds down the button **308** until the device captures the temperature image. In other embodiments, the user simply needs to press the button **308** to initiate the temperature image capture.

In this example, the imaging device screen **304** displays the temperature readout if the device **106** was able to read, process, and/or verify the display on the thermometer **206**,

**208** and **210**. In this example, if the imaging device cannot read, process, or verify the thermometer display, the imaging device screen **304** displays a message to the user to retry or rescan the thermometer display, or that there has been an error. Alternatively, or in addition, the imaging device vibrates when the thermometer display is not properly read, although the opposite configuration is also possible—the device vibrates when the display is properly read.

In some embodiments, before or after the user scans the digital temperature **504**, the user also scans identifying information. As discussed below with reference to FIG. **6**, identifying information includes a medical professional identification, a patient identification number or bar code, for example on a wrist band, or biometric information such as, for example, a fingerprint, a facial geometry, or an eye scan.

After the thermometer display has been scanned, the next step in the example method is for the user to perform error control **506**. As discussed above, the thermometer display **204** includes at least one error-checking character **210**. The error-checking character or characters is derived from the temperature captured by the thermometer and displayed on the thermometer display.

For example, using known error-checking algorithms such as cyclic redundancy check-16 (CRC-16) or a Reed-Solomon error correction code, the temperature reading is used to generate the error-checking character or characters. The error-checking characters can be imaged at the time the temperature is imaged from the thermometer display. Upon performing character recognition on the temperature and error-checking characters, the temperature and error-checking characters are compared using one of the noted algorithms. If an error is detected, it is assumed that capture and/or character recognition has failed, and an indication for reimaging of the information is provided. Alternatively, in some embodiments, the imaging device continuously reimages until the error-checking algorithms respond correctly, which can be stopped automatically or followed by a signal beep, vibration, or display to stop the reimaging.

The next step in the example method is to send the temperature to the electronic medical record system **508**. In some embodiments, this step can occur without the user's initiation. For example, in one embodiment, during the initial setup in step **502**, the device **106** is programmed to automatically transmit the captured temperature if the imaging device **106** is directly connected to the EMR system **109** wirelessly, or if the imaging device **106** is connected to the network **102**. In other embodiments, the user can initiate the transmission of the temperature to the EMR system **109** by following screen prompts on the imaging device **106** and/or by pressing button **308**.

Although the error checking is performed by the imaging devices in this example, other configurations are possible. For example, in a different embodiment, the temperature reading and the error-checking value are both communicated to the electronic medical system. The electronic medical system, in turn, performs the error checking. If an error occurs, the information can be returned to the imaging device in some embodiments.

In a similar manner, the optical character recognition can also be performed by the electronic medical record system in other embodiments. In such a scenario, the image or images are transmitted to the electronic medical records system. The electronic medical records system thereupon performs the optical character recognition and error checking. In yet another example, the image or images can be stored in the electronic medical record.

In an alternate embodiment, the imaging device **106** used to perform the method in FIG. **5** is a cellular telephone or computer tablet. In those embodiments, the mobile phone or tablet (collectively, “mobile device”) run an application that is configured to control the imaging component in the mobile device. Additionally, in some embodiments, the application is also configured to scan and interpret the temperature readout **504**, perform the error control **506** and send the temperature to the EMR system **508**.

FIG. **6** illustrates an example method **600** of the imaging device **106** operations during use by one or more medical professionals. The example method **600** includes scanning one or more medical professionals’ identification **602**, verifying the medical professional identification **604**, scanning a patient identification **606**, verifying the patient identification **608**, alternatively obtaining patient biometric data **610**, capturing the temperature image **612**, extracting the text of the temperature image using optical character recognition **614**, verifying the temperature **616**, connecting to a network **620**, communicating with the electronic medical record system **622**, transmitting patient identification to the EMR system **624**, transmitting the patient’s temperature to the EMR system **626**, receiving an alert notification from the EMR system **628**, and displaying the alert notification **630**.

In the example method **600**, the user optionally initiates a scan of a professional identification **602**, such as, for example, a badge containing a bar code, using the imaging device **106**. The scanning operations of the imaging device **106** are described with reference to FIG. **4**, above. After scanning the professional identification, the imaging device extracts text using optical character recognition, if necessary, and performs an error check **604** using any error-checking characters present in the professional identification.

In some embodiments, step **602** is necessary to activate the imaging device **106** or the application running on the mobile device. In some embodiments, the professional identification is associated with the patient’s temperature reading and sent to the EMR system with the temperature reading. In other embodiments, the imaging device **106** user starts at step **606** or step **612** without first scanning and verifying their own identification. In still other embodiments, the same user uses the same imaging device and the imaging device is configured to store the user’s scanned, or otherwise inputted, identification.

In the example method **600**, the user optionally initiates a scan of a patient identification **606**. The scanning operations of the imaging device **106** are described with reference to FIG. **4**, above. After scanning or capturing an image of the patient identification **606**, the imaging device **106** performs an error-check using any error checking characters present in the patient identification. In some embodiments, the patient identification is a bar code or bed number associated with the patient. In some embodiments, the imaging device scans patient biometric data **610**, either in place of or in addition to the bar code or bed number. In those embodiments, the processor is configured to perform an analysis of the patient’s fingerprints, facial geometry, or eyes.

Next, the imaging device **106** captures the temperature image **612** displayed on the thermometer **200**. Step **612** is initiated by the imaging device user. In some embodiments, the imaging device **106** emits a guiding light, such as a laser, to help the user aim the device onto the temperature reading. In other embodiments, the imaging device display **304** shows the field of view of the imaging component as a way to guide the user in aiming the device. In the example embodiment, the imaging device **106** is configured to con-

tinuously scan until it recognizes at least two numbers corresponding to the patient’s temperature and at least one error-checking character.

In some embodiments, the imaging device **106** also tags the image with the current date, time, and/or location data. The location data is obtainable by global positioning systems or network information containing, for example, the closest router, IP address, or any information identifying the specific room or area of the medical facility.

In some embodiments, the imaging device **106** records the type of temperature recorded, such as, for example, oral, under arm, forehead, ear, temporal artery, or rectal. This information can be recorded through, for example, on-screen prompts or by scanning a barcode corresponding to the type of measurement taken. In some embodiments, the imaging device **106** can have the type of measurement taken set as a default and recorded along with the temperature. In some embodiments, the type of temperature information can be displayed in the thermometer display **204** which can be captured by the imaging device **106**.

Next, in example method **600**, the imaging device **106** extracts the text from the image using an optical character recognition process **614**. In most embodiments, the output of step **614** includes a temperature, a unit of temperature measurement, and at least one error-checking character.

In the example method **600**, the output of step **614** is used to verify the captured temperature **616**. In step **616**, the imaging device **106** processor performs the error checking using one or more of the methods described herein.

When the imaging device **106** has verified the temperature extracted from the image text **616**, the next step in example method **600** is to either connect to the network **620** or communicate with the EMR system **622** directly. In some embodiments, as discussed above, the imaging device **106** is directly connected to the EMR system **109** via a wireless protocol such as Bluetooth, or through a wired connection, such as a dock or USB connection.

In some embodiments, the imaging device **106** connects to a network **620** through which the device **106** communicates with the EMR system **622**. In those embodiments, the EMR system **109** is also connected to the network. Step **622** includes, for example, the exchange of identifying information between the device **106** and system **109**, well known to one skilled in the art, as well as steps **624** and **626**.

In example method **600**, once a communication is established between the imaging device **106** and the EMR system **109**, the imaging device **106** transmits the patient identification obtained in steps **606** and/or **610** to the EMR system **109**. In some embodiments, the imaging device concurrently or sequentially sends the patient temperature obtained in steps **612**, **614** and **616** to the EMR system **109**. In some embodiments, the EMR system **109** receives the data from the imaging device **106** and enters the data in the patient’s electronic medical record **108**.

In example method **600**, the imaging device optionally receives an alert from the EMR system **628**. In this embodiment, the EMR system **109** compares the patient’s temperature to pre-stored parameters and sends an alert if the temperature falls outside those parameters. For example, the parameters are the normal expected temperature for a human, which can vary depending upon the type of measurement taken. The EMR system **109**, in some embodiments, sends an alert to the imaging device **106** that the patient’s temperature is lower or higher than the expected range.

In some embodiments, the EMR system **109** is configured to compare the instantly transmitted temperature with pre-

vious measurements. The EMR system 109, in some embodiments, sends an alert to the imaging device 106 if the temperature is higher than the previous measurement, if the temperature is significantly higher than the previous measurement, such as at least 1-2° F. higher, if the temperature is trending lower, if the temperature is significantly lower than the previous measurement, or if the trend of the previous measurements is increasing or decreasing.

In some embodiments, the EMR system 109 is configured to send custom notifications to the imaging device 106 or is customized to send notifications only at specific temperatures. For example, a physician associated with the patient may be interested in being alerted when the patient's temperature drops below a certain temperature, such as 100° F. In that embodiment, the EMR system 109 is configured to send an alert to the imaging device that a physician should be notified of the patient's current temperature. Other customizations are possible.

In the example method 600, upon receipt of the alert notification, the imaging device 106 displays a message on the screen 630 and/or provides tactile feedback, such as one or more vibrations. For example, in one embodiment the imaging device displays an instruction to the user to retake the patient's temperature or set an alarm to retake the patient's temperature in the future. The image device 106 is configured, in some embodiments, to store and display pre-determined notifications or to display other notifications received from the EMR system 109, such as "Notify Physician".

FIG. 7 illustrates a set 700 of example graphical user interfaces at various points in the example method shown in FIG. 6. The example set 700 includes an identity scan screen 702, a confirmation of identity verification screen 704, a capture temperature screen 706, a call-out showing the capture temperature screens 708, a temperature verification screen 710, and a temperature sent screen 712. In the embodiment shown, the imaging device is a smart phone including a display, a camera, and wireless connectivity functionality, running an application configured to implement example method 600.

In the example 700, identity scan screen 702 appears for scanning the medical professional identification 602 and for scanning the patient identification 606. The screen display includes guide lines to help the user frame the identification in the display, which in turn, enables the camera to capture the identification and use the image for further processing. Other embodiments for guiding the user are possible, such as, for example, using a blackout frame. Also included in the example display are the instructions "Scan ID". In other embodiments, the position of the words is different and/or omitted. Other words directing the user are possible.

Example graphical user interfaces 700 also include identity confirmation screen 704 informing the user that, in some embodiments, the imaging device successfully scanned the identification and converted the image to readable text. In other embodiments, confirmation screen 704 varies in design and/or content. In some embodiments, confirmation screen 704 appears on the device accompanied by tactile or aural feedback, such as a vibration or a beep, respectively. In some embodiments, the confirmation screen 704 is displayed when the imaging device 106 communicates with the EMR system 109 and verifies that the identification scanned, for example, the patient or professional identification, has a corresponding entry in the system 109 database.

Example graphical user interfaces 700 also include capture temperature screen 706. Similar to scan identity screen 702, the imaging device screen in this example contains

demarcations to guide the user in aiming the imaging component towards the temperature reading. Callout 708 depicts graphically two of the operations, in this embodiment, the imaging device performs when the user aims the device on the temperature reading: scanning the thermometer readout and converting the image to text.

Example graphical user interfaces 700 also include temperature verification screen 710. In this example, the imaging device screen provides notification that the device was able to read the thermometer text and that the error-correction processes confirmed that the scanned temperature is correct. In some embodiments, temperature verification screen 710 displays the temperature, the units of measurement, and the error-checking value or values.

Example graphical user interfaces 700 also include temperature sent screen 712. In other embodiments, temperature sent screen 712 varies in design and/or content. In some embodiments, temperature sent screen 712 appears on the device accompanied by tactile or aural feedback, such as a vibration or a beep, respectively. In this example, the confirmation screen 712 appears on the imaging device screen when the imaging device has successfully connected to the EMR system directly or through the network, and successfully transmitted the temperature and any additional data associated with the temperature to the EMR system.

The flow diagrams depicted herein are just examples. There may be many variations to these diagrams or the steps (or operations) described therein without departing from the spirit of the disclosure. For instance, the steps may be performed in a differing order, or steps may be added, deleted or modified.

While embodiments have been described, it will be understood that those skilled in the art, both now and in the future, may make various improvements and enhancements can be made.

What is claimed is:

1. A handheld imaging device, comprising:

a housing;

a camera supported by the housing and configured to capture a visual image containing text displayed by a thermometer, the text displayed by the thermometer including both a value representing a physiological measurement and a checksum value;

a processor operatively coupled to the camera and configured to:

extract the text from the visual image using optical character recognition, and

compare the value representing the physiological measurement and the checksum value to check for errors in the optical character recognition of the image;

a display on the housing configured to display the text; and

a network connection unit operatively coupled to the processor,

wherein the network connection unit is configured to communicate with an electronic medical record system and to transmit at least some of the extracted text to the electronic medical record system, and

wherein the processor is further configured to provide at least one of a message to capture a new visual image or an error message on the display screen, if the imaging device is not able to read, process or verify the value representing the physiological measurement.

2. The handheld imaging device of claim 1, wherein the error-control includes using an error detection function to verify an integrity of the value representing the physiological measurement.

3. The handheld imaging device of claim 1, wherein the error-control includes using an error correction function to correct error of the value representing the physiological measurement.

4. The handheld imaging device of claim 1, wherein the camera is configured to image a temperature reading provided by a thermometer. 5

5. The handheld imaging device of claim 1, further comprising:

a code interpretation module configured to interpret any one of the following in the image: a barcode or a quick response code. 10

6. The handheld imaging device of claim 1, wherein the network connection unit communicates with the electronic medical system wirelessly. 15

7. The handheld imaging device of claim 1, wherein the housing is a key fob.

\* \* \* \* \*

专利名称(译)	医疗设备成像仪		
公开(公告)号	<a href="#">US10028658</a>	公开(公告)日	2018-07-24
申请号	US14/143448	申请日	2013-12-30
[标]申请(专利权)人(译)	伟伦公司		
申请(专利权)人(译)	伟伦, INC.		
当前申请(专利权)人(译)	伟伦, INC.		
[标]发明人	WANG YNJIUN PAUL LAI CHEE KEEN SCHMIDT JEFFREY H		
发明人	WANG, YNJIUN PAUL LAI, CHEE KEEN SCHMIDT, JEFFREY H.		
IPC分类号	A61B5/00 G06K9/00 H04M1/02 A61B90/96 A61B90/90 A61B5/01 G06K9/32		
CPC分类号	A61B5/0008 A61B5/742 A61B90/90 A61B90/96 H04M2250/52 A61B5/01 G06K9/3258		
代理机构(译)	商户 GOULD, P.C.		
其他公开文献	US20150182114A1		
外部链接	<a href="#">Espacenet</a>		

摘要(译)

一种用于将患者的温度传输到与患者相关联的电子病历的系统，包括具有数字显示器的温度计，该数字显示器被配置为显示与温度信号相关联的温度值和至少一个错误校验值。该系统还包括手持成像装置，其包括用于捕获温度计的数字显示器的图像的相机，用于使用光学字符识别来提取图像中的文本的处理器，以及使用at执行对温度值的错误检查。图像中至少一个错误检查值，并将患者的识别号和温度传送到电子病历系统。

