



US 20160287089A1

(19) **United States**

(12) **Patent Application Publication**

Yi et al.

(10) **Pub. No.: US 2016/0287089 A1**

(43) **Pub. Date:**

Oct. 6, 2016

(54) **PRESSURE SENSOR INCLUDING HYBRID ELECTRONIC SHEET AND WEARABLE DEVICE INCLUDING THE PRESSURE SENSOR**

(71) Applicant: **KOREA INSTITUTE OF SCIENCE AND TECHNOLOGY**, Seoul (KR)

(72) Inventors: **Hyun Jung Yi**, Seoul (KR); **Seung Woo Lee**, Seoul (KR); **Ki Young Lee**, Seoul (KR)

(21) Appl. No.: **14/988,459**

(22) Filed: **Jan. 5, 2016**

(30) **Foreign Application Priority Data**

Apr. 2, 2015 (KR) 10-2015-0046751

Publication Classification

(51) **Int. Cl.**
A61B 5/021 (2006.01)
A61B 5/00 (2006.01)
(52) **U.S. Cl.**
CPC *A61B 5/021* (2013.01); *A61B 5/6801* (2013.01)

(57) **ABSTRACT**

Provided are a pressure sensor including hybrid electronic sheet and a wearable device including the pressure sensor. The pressure sensor has excellent controllable electric characteristics and excellent mechanical flexibility and stability, and measures, for example, pressure in a simple and highly reproducible manner in which a resistance of a component in a sensor varies depending on applied pressure.

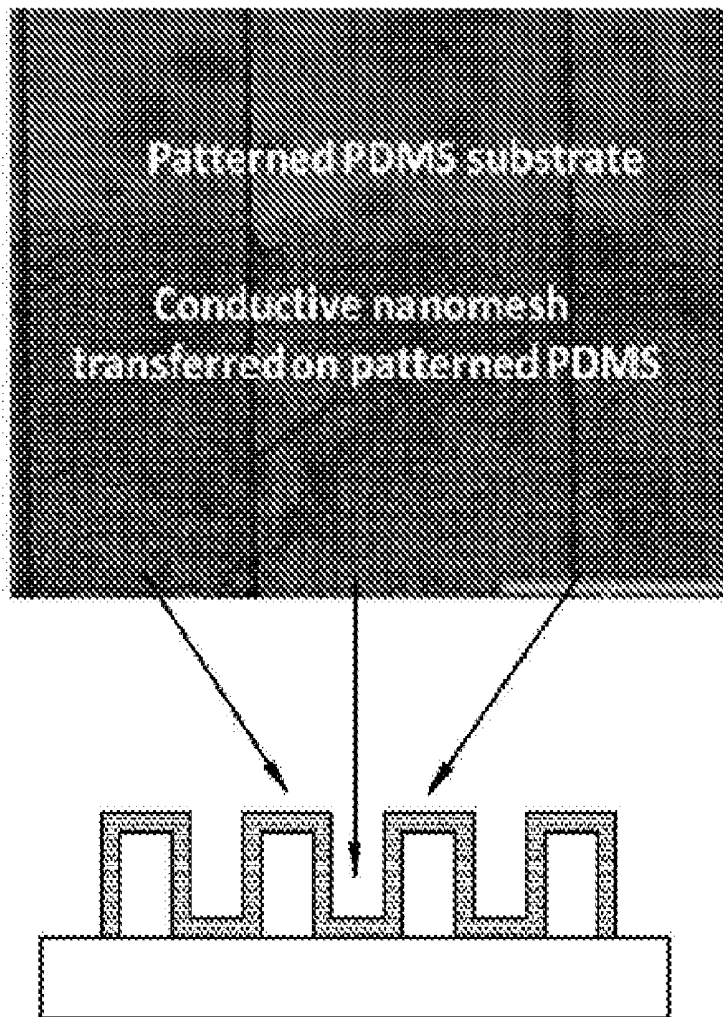

FIG. 1A

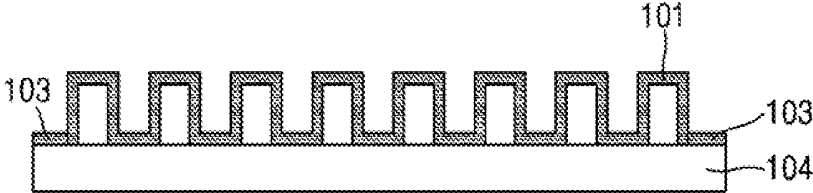

FIG. 1B

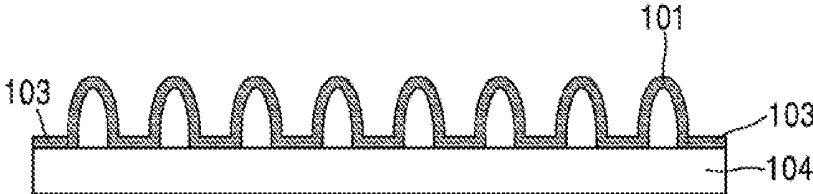

FIG. 1C

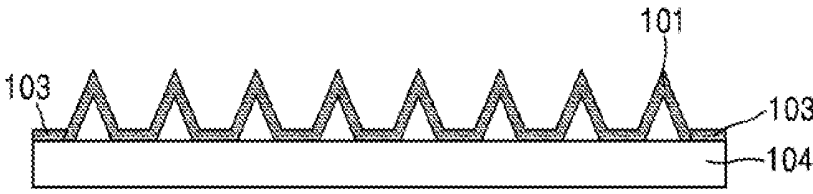

FIG. 2A

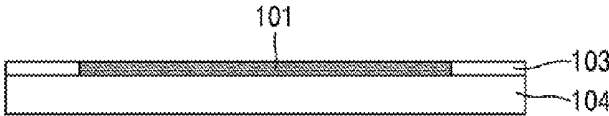

FIG. 2B

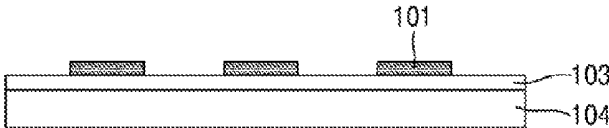

FIG. 2C

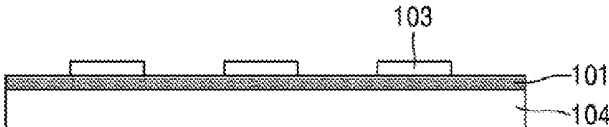

FIG. 3A

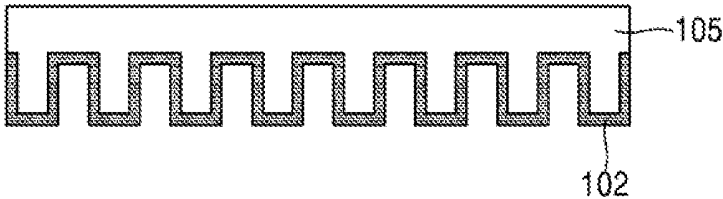

FIG. 3B

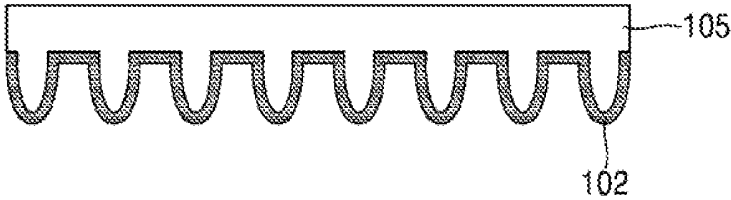

FIG. 3C

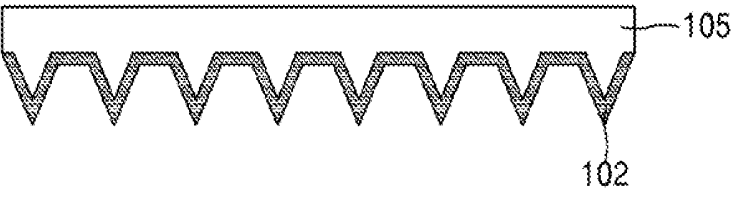

FIG. 4

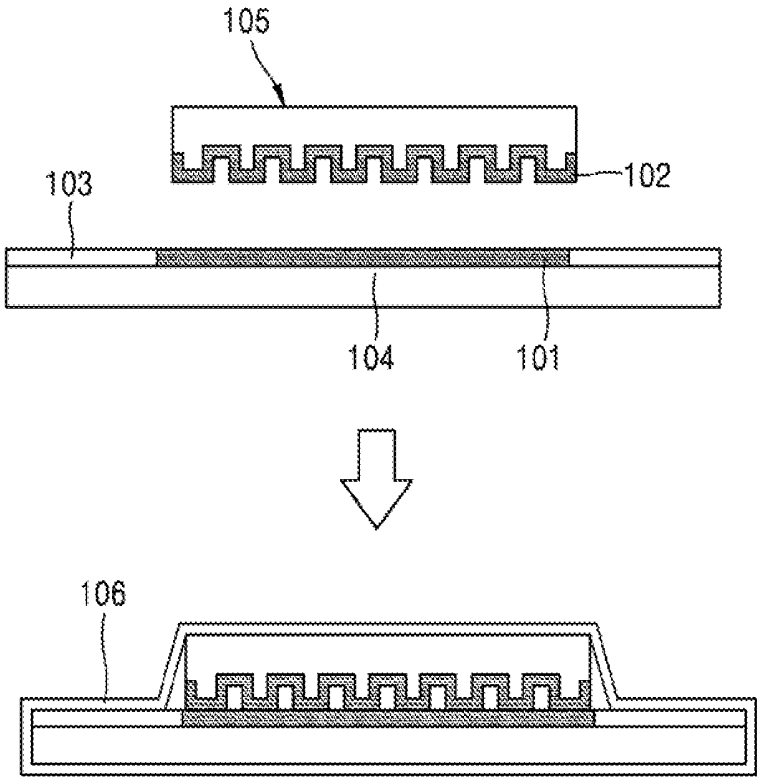

FIG. 5A

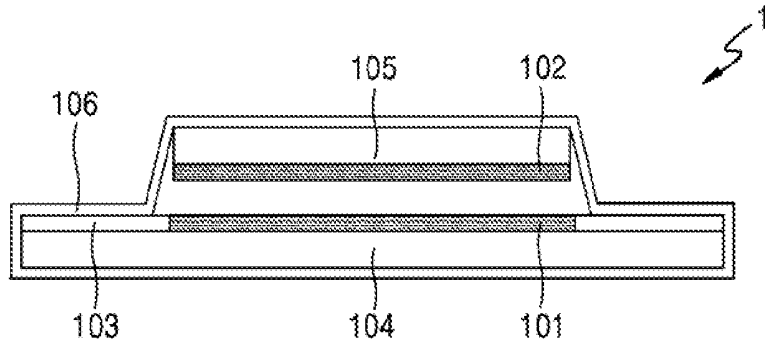

FIG. 5B

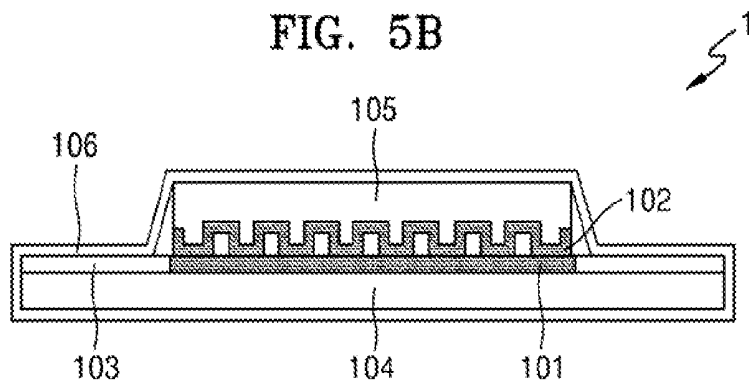

FIG. 5C

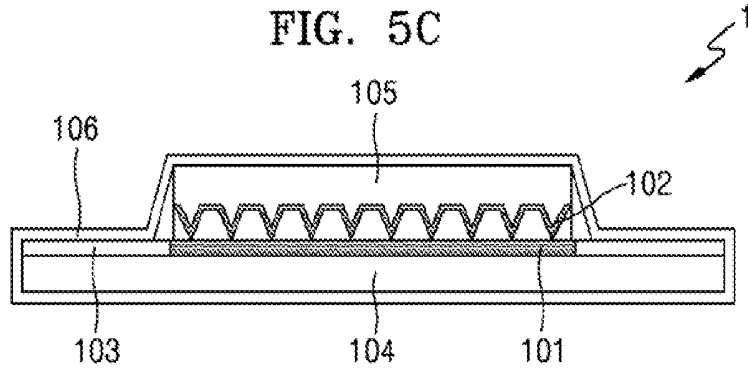

FIG. 5D

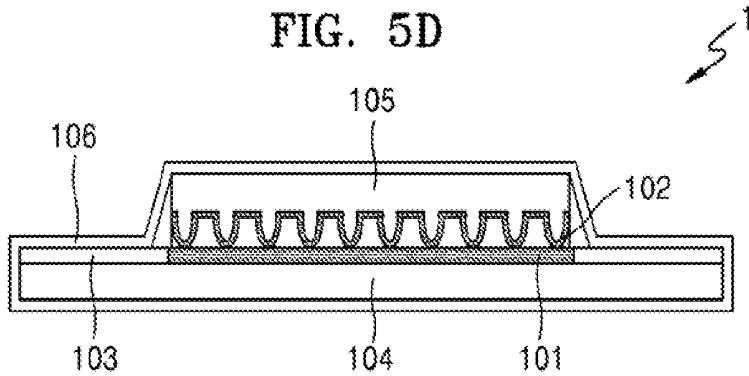

FIG. 6A

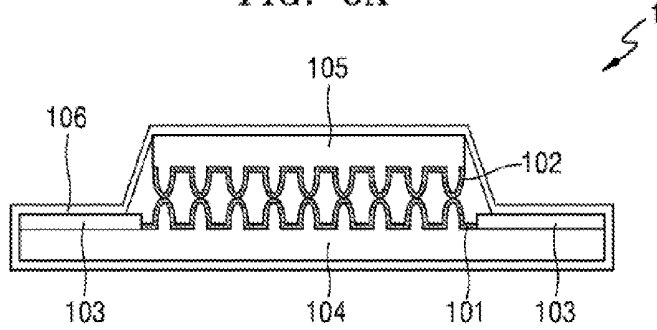

FIG. 6B

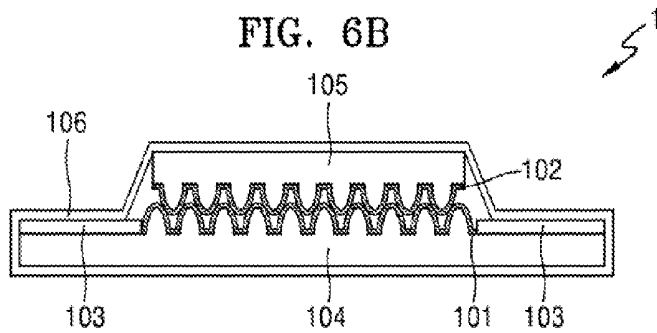

FIG. 6C

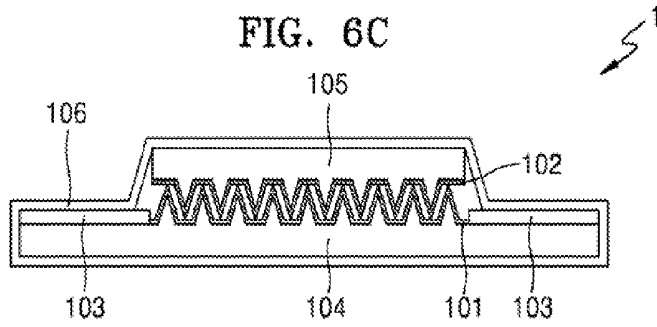

FIG. 6D

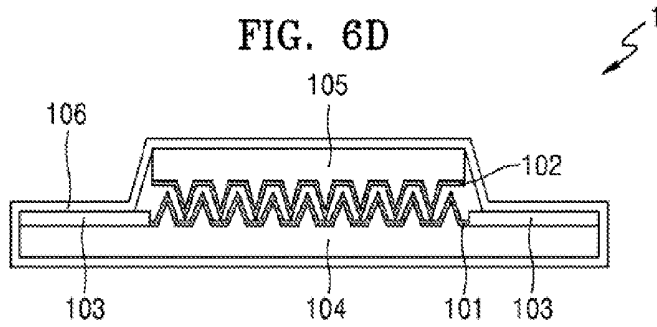

FIG. 7A

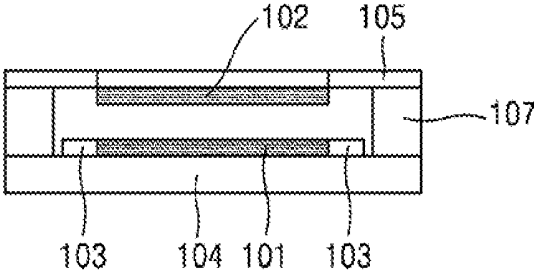

FIG. 7B

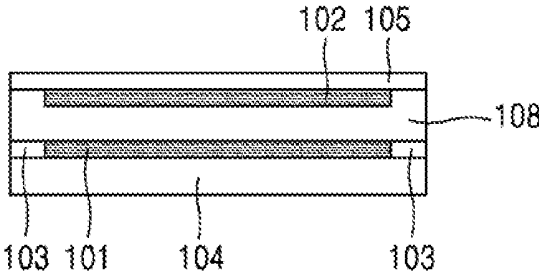

FIG. 8

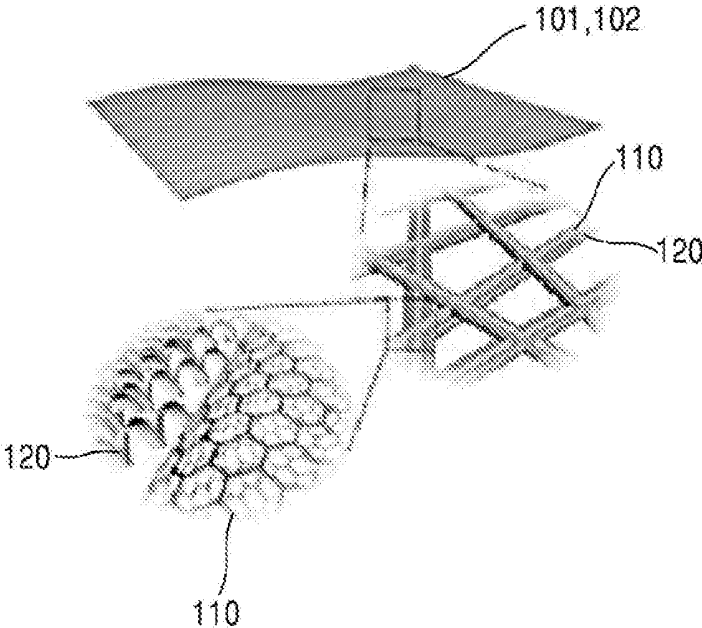

FIG. 9

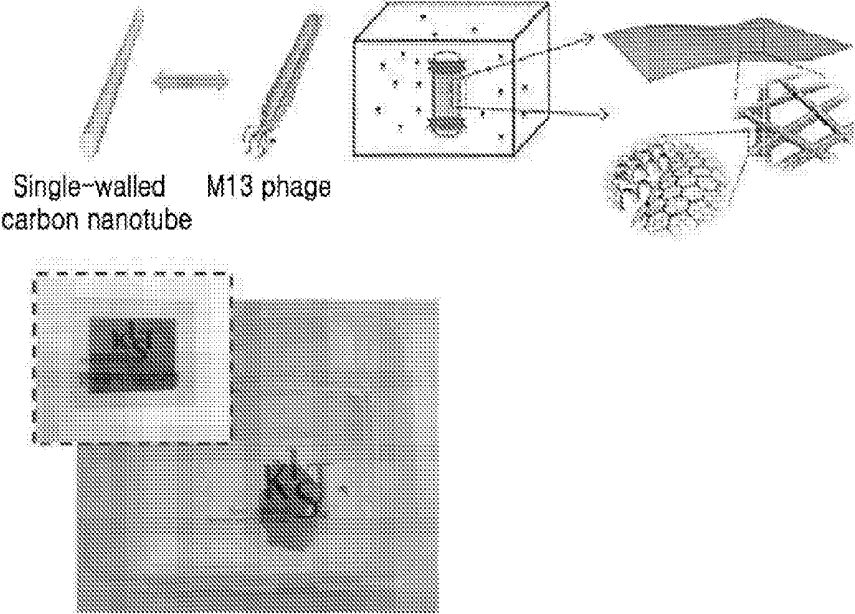

FIG. 10

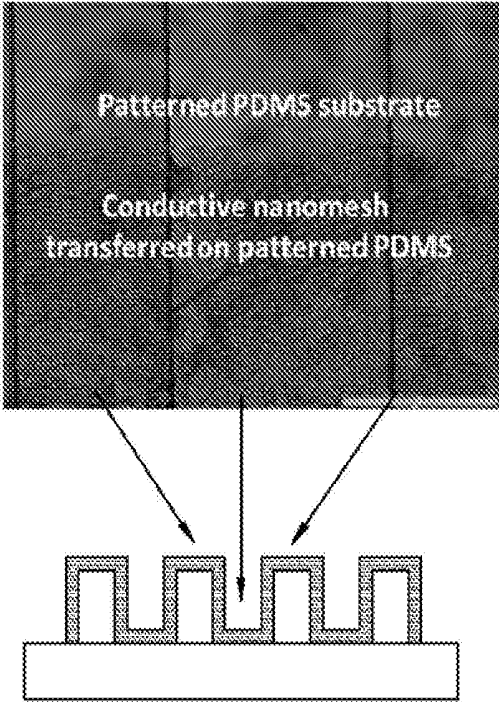

FIG. 11

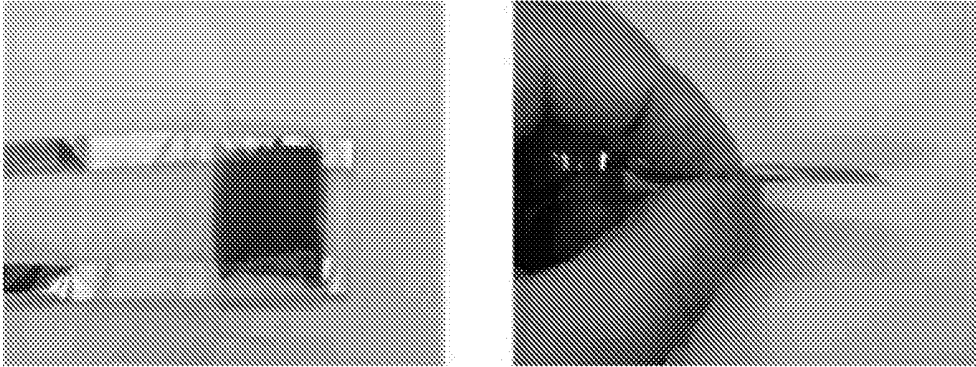

FIG. 12

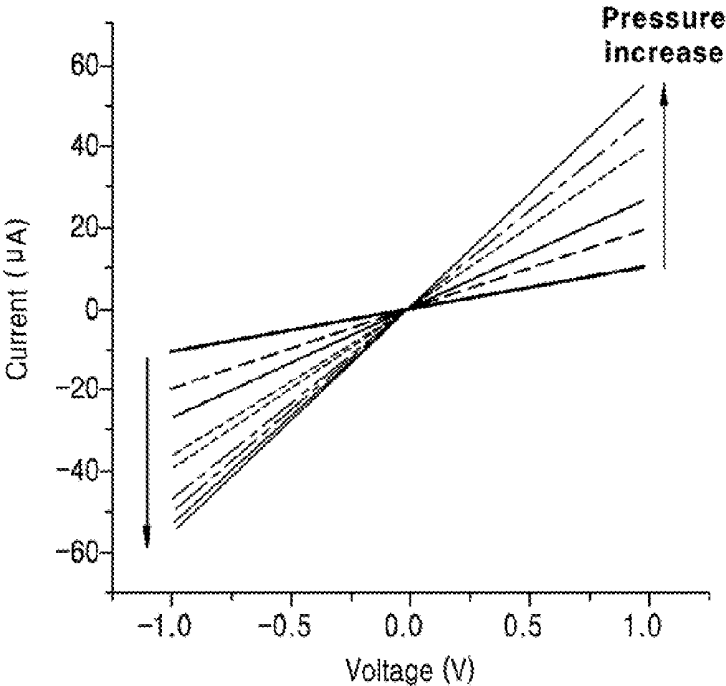

FIG. 13

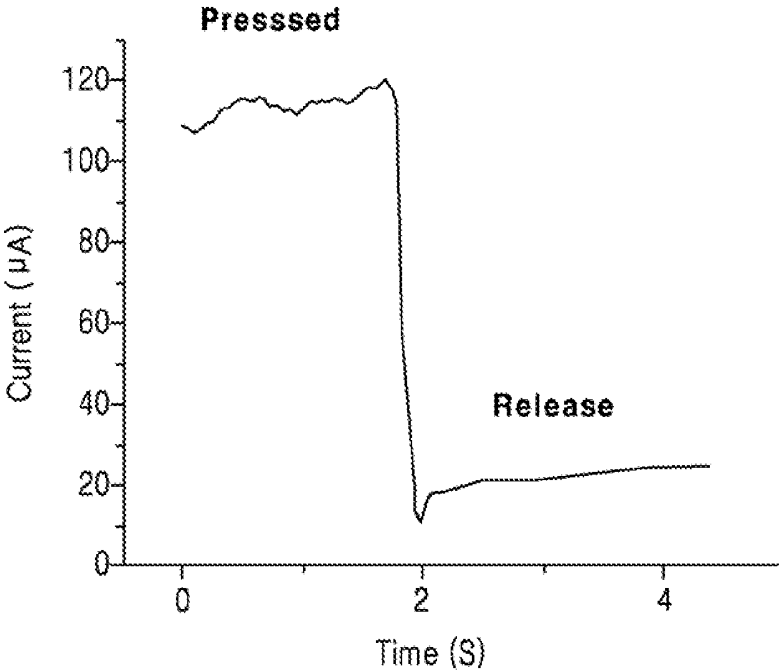

FIG. 14

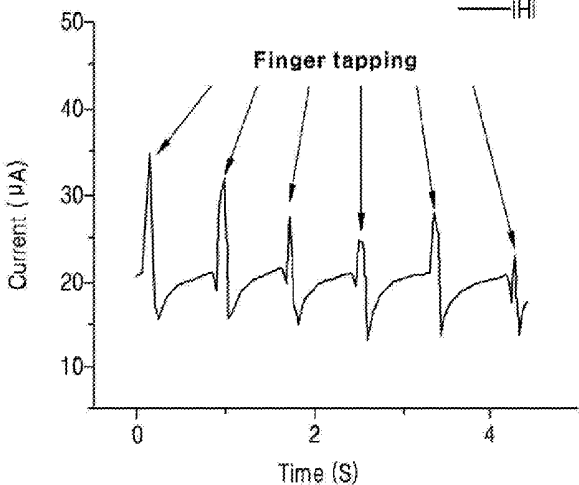
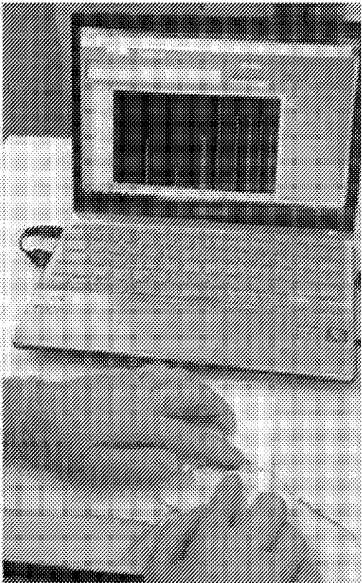

FIG. 15

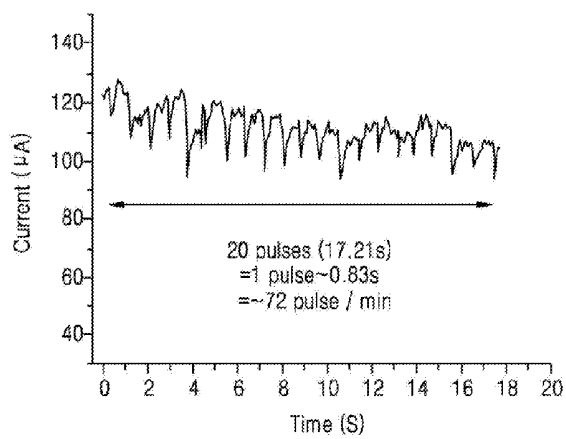
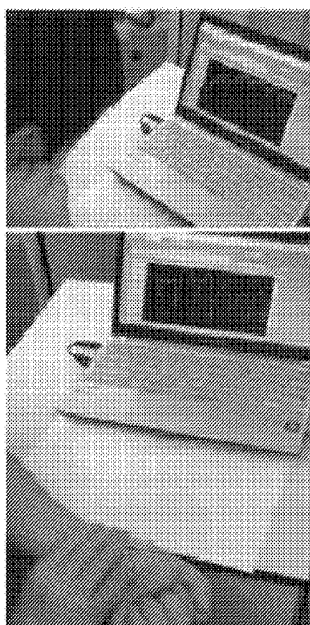

FIG. 16

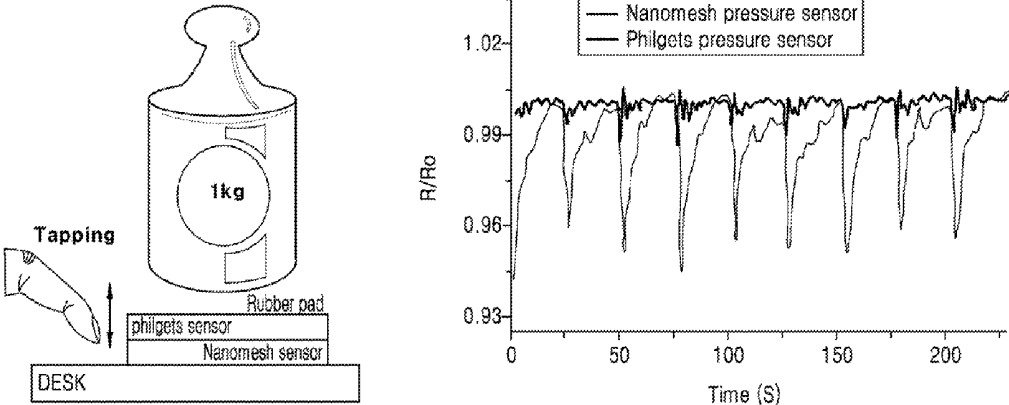

FIG. 17

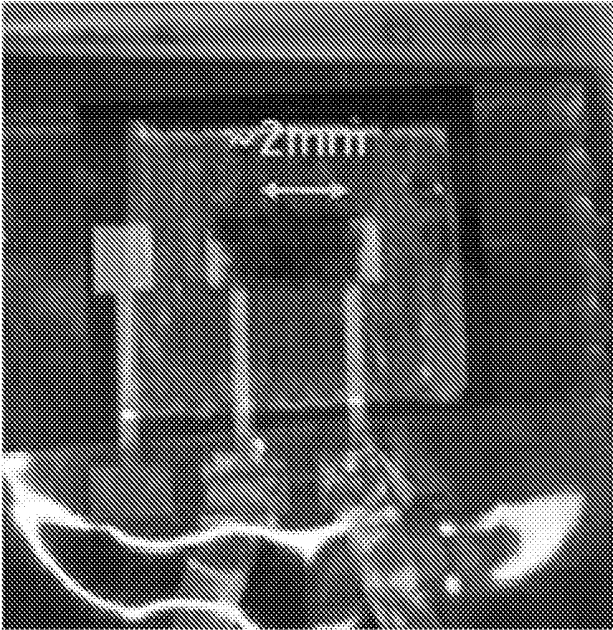

FIG. 18

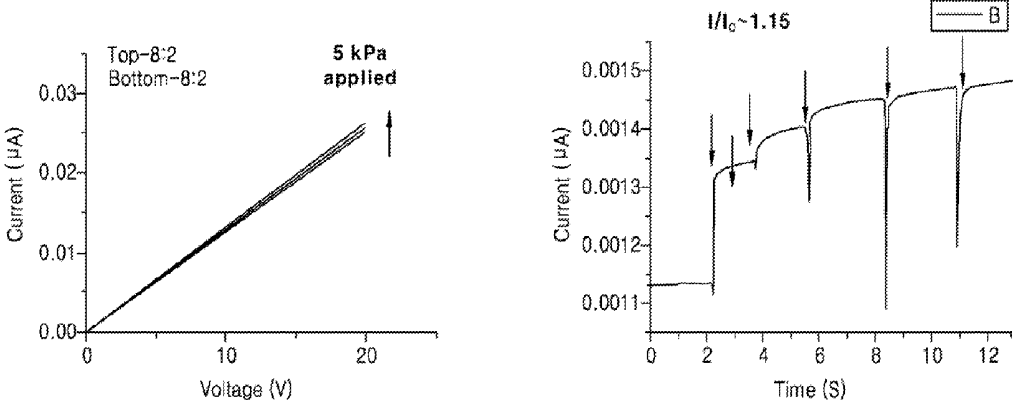

FIG. 19

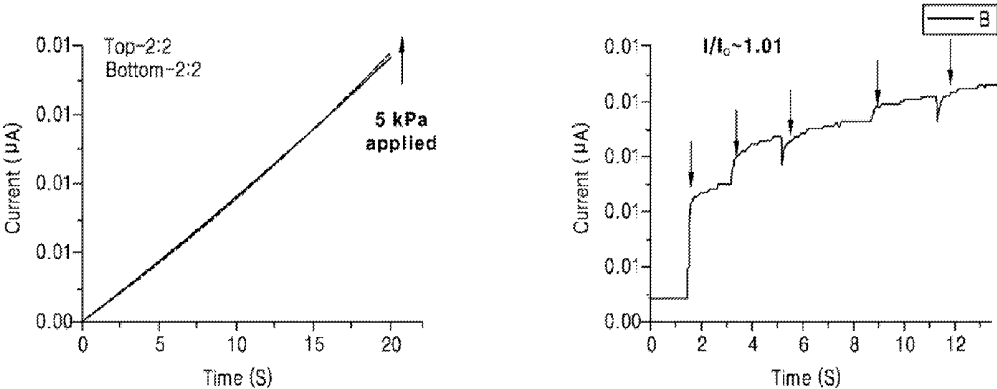

FIG. 20

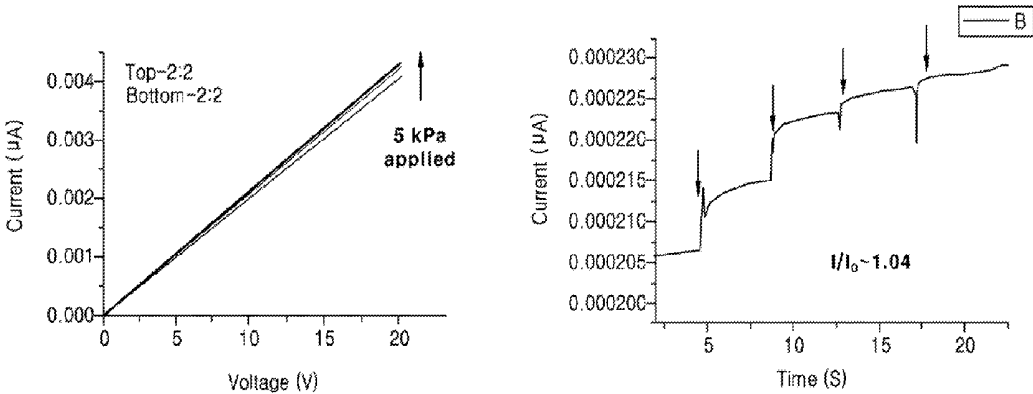

FIG. 21

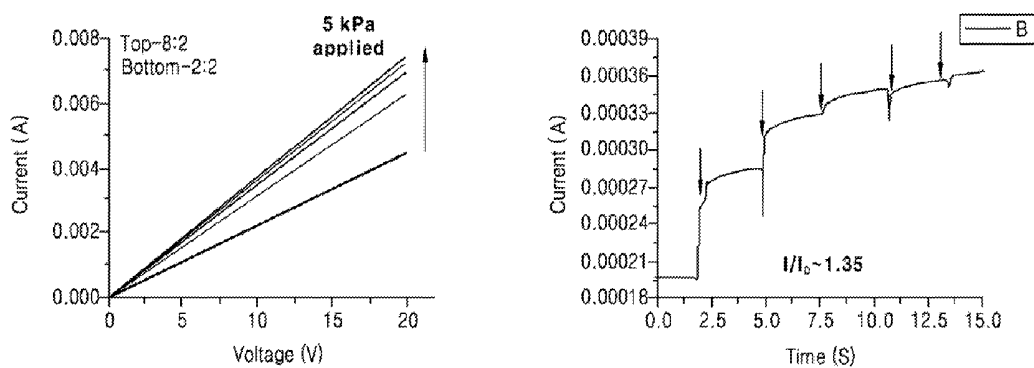
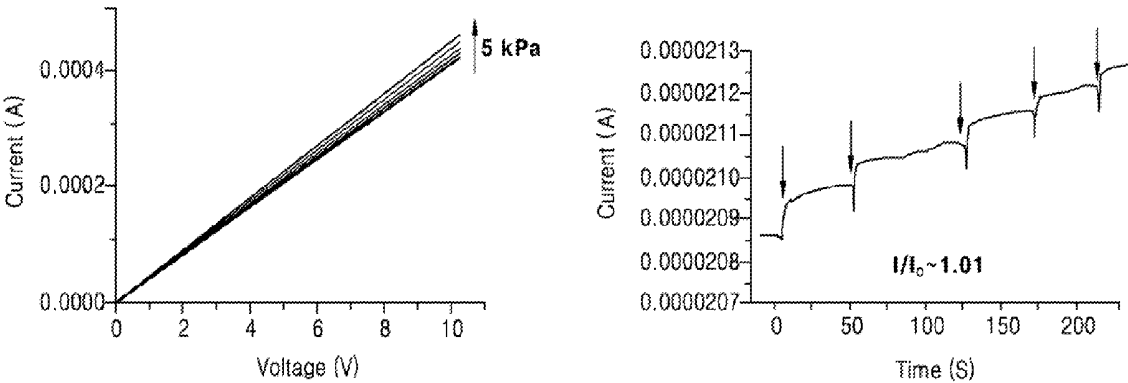

FIG. 22



**PRESSURE SENSOR INCLUDING HYBRID
ELECTRONIC SHEET AND WEARABLE
DEVICE INCLUDING THE PRESSURE
SENSOR**

CROSS-REFERENCE TO RELATED
APPLICATION

[0001] This application claims the benefit of Korean Patent Application No. 10-2015-0046751, filed on Apr. 2, 2015, in the Korean Intellectual Property Office, the disclosure of which is incorporated herein in its entirety by reference.

BACKGROUND

[0002] 1. Field

[0003] One or more exemplary embodiments relate to a pressure sensor including a hybrid electronic sheet and a wearable device including the pressure sensor.

[0004] 2. Description of the Related Art

[0005] Pressure sensors are widely used due to the commercial availability and popularity of mobile terminals or displays to which a touch-input manner is introduced. Touch-based pressure sensors are attracting attention for use in robots that measure and respond to external environments or stimuli, as well as use in electronic devices. Due to increasing recognition for the ubiquitous environment and technical development of humanoid robots, in addition to process robots that receive one-dimensional commands and repeatedly perform correspondingly, robots that respond and handle complicated and various environments or external stimuli by themselves are getting much attention. To voluntarily respond to external stimuli or environmental changes, such robots convert external stimuli or environmental changes into electrical signals through a tactile pressure sensing system mounted on their surfaces and voluntarily, flexibly respond to a command of a user.

[0006] Flexible device-based pressure sensors are available for use in, in addition to emotional electronic devices and humanoid robots, a sensor system that manages physical activities and regular sports activities. Flexible device-based super-sensitive pressure sensors can be used in a wearable sensor system that measures a heart pulse wave via the human skin or collects data about human walking and habits by attaching a pressure sensor to the sole of footwear. To embody such a wearable sensor system, there is a need to develop a sensor that includes a sensor basic unit having excellent bending and restoring properties, and excellent mechanical flexibility and stability.

[0007] Silicon-based solid MEMS-based pressure devices have a high level of accuracy, but due to their fragile property, they lack flexibility and are likely to crack, resulting in high difficulty for their application on various surfaces including a flexible surface. To develop a novel flexible electronic device having high mechanical flexibility, a conductive polymer, such as polypyrrole, PEDOT:PSS, or polyaniline, graphene, or a nano-structure material, such as carbon nanotube (CNT), metal nanoparticle, or metal nanowire are getting attention as an alternative to silicon. In particular, CNT is an alternative to ITO, which is conventionally used, due to its high light transmissibility and conductivity. CNT also has excellent chemical stability and mechanical characteristics. Furthermore, the recent advance in synthesis technology enables mass-production of CNT, decreasing manufacturing costs thereof. However, in the

case of conductive polymer-based pressure sensors, their long-term stability and, when in contact with moisture, their conductivity may change significantly. Accordingly, this material is inappropriate for a pressure sensor. In the case of nano material-based devices, in view of properties of nano materials, it is difficult to obtain reproducibility.

[0008] Accordingly, there is a need to develop a pressure sensor that has excellent controllable electrical properties so that it is usable/applicable in various fields including humanoid-based robots, smart vehicles, aerial applications, simulation, process control, human being-friendly IT, fingerprint-recognition systems, bio-monitoring smart sensors, or the like, and that has excellent mechanical flexibility and stability.

SUMMARY

[0009] One or more exemplary embodiments include a pressure sensor including: a bottom substrate; a top substrate located on the bottom substrate and spaced apart from at least a portion of the bottom substrate; and an electronic sheet formed on at least a portion of the bottom substrate or at least a portion of a surface of the top substrate facing the bottom substrate, or a first electronic sheet formed on at least a portion of the bottom substrate and a second electronic sheet formed on at least a portion of a surface of the top substrate facing the bottom substrate; wherein the electronic sheet includes a graphitic material and a phage binding to the graphitic material, and the binding is made between a peptide displayed on a coat protein or a fragment thereof of the phage and the graphitic material.

[0010] One or more exemplary embodiments include a wearable device for measuring bio-information, the wearable device including the pressure sensor.

BRIEF DESCRIPTION OF THE DRAWINGS

[0011] These and/or other aspects will become apparent and more readily appreciated from the following description of the embodiments, taken in conjunction with the accompanying drawings in which:

[0012] FIG. 1A-1C illustrate examples of a patterned bottom substrate of a pressure sensor according to an exemplary embodiment;

[0013] FIG. 2A-2C illustrate examples of a bottom substrate of a pressure sensor according to an exemplary embodiment;

[0014] FIG. 3A-3C illustrate examples of a patterned top substrate of a pressure sensor according to an exemplary embodiment;

[0015] FIG. 4 illustrates a pressure sensor according to an exemplary embodiment;

[0016] FIG. 5A-5D illustrate examples of a pressure sensor according to another exemplary embodiment;

[0017] FIG. 6A-6D illustrate examples of a pressure sensor according to another exemplary embodiment;

[0018] FIG. 7A-7B illustrate a pressure sensor according to an exemplary embodiment, including an intermediate insulating structure or an intermediate insulating layer;

[0019] FIG. 8 illustrates a hybrid electronic sheet of a pressure sensor according to an exemplary embodiment;

[0020] FIG. 9 illustrates how to manufacture a hybrid electronic sheet of a pressure sensor according to an exemplary embodiment;

[0021] FIG. 10 shows an image of the micro structure of a top substrate of a pressure sensor according to an exemplary embodiment;

[0022] FIG. 11 shows an image of a pressure sensor according to an exemplary embodiment;

[0023] FIG. 12 is a graph of current when different levels of pressure are applied to a pressure sensor according to an exemplary embodiment;

[0024] FIG. 13 is a graph of current when a pressure sensor according to an exemplary embodiment is pressed or released;

[0025] FIG. 14 shows an image of an experiment in which a sudden pressure is applied to a pressure sensor according to an exemplary embodiment by using a finger, and illustrates a graph of change in current of the pressure sensor over time caused by force generated by the finger-tapping;

[0026] FIG. 15 illustrates a graph of current converted from a pulse of blood flow at radial artery measured by using a pressure sensor according to an exemplary embodiment;

[0027] FIG. 16 illustrates a schematic diagram showing how an experiment was performed in which a pressure sensor according to an exemplary embodiment was compared with a commercially available Phidgets FSR sensor having a diameter of 10 mm, and a graph of a responding property of the two sensors with respect to vibration caused by finger-tapping on a desk;

[0028] FIG. 17 shows an image of a small pressure sensor used for an experiment which was performed to identify the relationship between the sensitivity of a pressure sensor according to an exemplary embodiment and a composition of a hybrid electronic sheet of the pressure sensor;

[0029] FIG. 18 illustrates a graph of current with respect to pressure when a hybrid electronic sheet made from a graphitic material and p8 GB#1 at a ratio of 8:2 transferred on a top substrate of a pressure sensor according to an exemplary embodiment and a hybrid electronic sheet made from a graphitic material and p8 GB#1 at a ratio of 8:2 transferred on a bottom substrate of the pressure sensor were pressed at an incremental pressure rate of 1 kPa, starting from 0 kPa;

[0030] FIG. 19 illustrates a graph of current with respect to pressure when a hybrid electronic sheet made from a graphitic material and p8 GB#1 at a ratio of 2:2 transferred on a top substrate of a pressure sensor according to an exemplary embodiment and a hybrid electronic sheet made from a graphitic material and p8 GB#1 at a ratio of 8:2 transferred on a bottom substrate of the pressure sensor were pressed at an incremental pressure rate of 1 kPa, starting from 0 kPa;

[0031] FIG. 20 illustrates a graph of current with respect to pressure when a hybrid electronic sheet made from a graphitic material and p8 GB#1 at a ratio of 2:2 transferred on a top substrate of a pressure sensor according to an exemplary embodiment and a hybrid electronic sheet made from a graphitic material and p8 GB#1 at a ratio of 2:2 transferred on a bottom substrate of the pressure sensor were pressed at an incremental pressure rate of 1 kPa, starting from 0 kPa;

[0032] FIG. 21 illustrates a graph of current with respect to pressure when a hybrid electronic sheet made from a graphitic material and p8 GB#1 at a ratio of 8:2 transferred on a top substrate of a pressure sensor according to an exemplary embodiment and a hybrid electronic sheet made from a graphitic material and p8 GB#1 at a ratio of 2:2

transferred on a bottom substrate of the pressure sensor were pressed at an incremental pressure rate of 1 kPa, starting from 0 kPa; and

[0033] FIG. 22 illustrates a graph of current when a hybrid electronic sheet made from a graphitic material and p8 GB#1 at a ratio of 5:2 transferred on a top substrate of a pressure sensor according to an exemplary embodiment and poly(3,4-ethylenedioxythiophene) polystyrene sulfonate (PEDOT:PSS) transferred on a bottom substrate were pressed at an incremental pressure rate of 1 kPa, starting from 0 kPa.

DETAILED DESCRIPTION

[0034] Reference will now be made in detail to embodiments, examples of which are illustrated in the accompanying drawings, wherein like reference numerals refer to like elements throughout. In this regard, the present embodiments may have different forms and should not be construed as being limited to the descriptions set forth herein. Accordingly, the exemplary embodiments are merely described below, by referring to the figures, to explain aspects of the present description. Expressions such as “at least one of,” when preceding a list of elements, modify the entire list of elements and do not modify the individual elements of the list.

[0035] An aspect provides a pressure sensor including: a bottom substrate; a top substrate located on the bottom substrate and spaced apart from at least a portion of the bottom substrate; and an electronic sheet formed on at least a portion of the bottom substrate or at least a portion of a surface of the top substrate facing the bottom substrate, or a first electronic sheet formed on at least a portion of the bottom substrate and a second electronic sheet formed on at least a portion of a surface of the top substrate facing the bottom substrate; wherein the electronic sheet includes a graphitic material and a phage binding to the graphitic material, and the binding is made between a peptide displayed on a coat protein or a fragment thereof of the phage and the graphitic material.

[0036] The term “pressure sensor” used herein may be interchangeably used with “touch sensor” or “tactile sensor,” and refers to an apparatus, tool, or device that detects given force, contact, pressure, tactus, or touch, and converts them into signals (for example, an electric signal). In some embodiments, the pressure sensor may be a flexible pressure sensor, and may be an integrated or miniaturized pressure sensor having a thickness of less than 1 mm. In some embodiments, the pressure sensor may have excellent controllable electrical properties, mechanical flexibility, and stability, and due to these properties, the pressure sensor may be used in humanoid robots, touch displays, bio-information measuring wearable devices, smart vehicles, aerial applications, simulation, process control, human-friendly IT, fingerprint recognition systems, or bio-monitoring smart sensors.

[0037] The term “sheet” used herein refers to a material having a certain width and a certain thickness, and for example, may include a film, a web, a membrane, or a complex structure thereof.

[0038] The term “graphitic material” used herein refers to a material having a surface with a hexagonal arrangement of carbon atoms, i.e., a graphitic surface, and may include any material having a graphitic surface, regardless of physical, chemical or structural properties. Examples thereof are a

graphene sheet, a highly oriented pyrolytic graphite (HOPG) sheet, a graphene oxide, a reduced graphene oxide, a carbon nanotube such as a single-walled carbon nanotube, a double-walled carbon nanotube, and a multi-walled carbon nanotube, and fullerene. The graphitic material may be metallic, semi-conductive, or a hybrid thereof. For example, the graphitic material may be a combination of a graphene sheet and a single-walled carbon nanotube.

[0039] Referring to FIGS. 1 to 3, a bottom substrate 104 with a first electronic sheet 101 that has been transferred thereonto, or a top substrate 105 with a second electronic sheet 102 that has been transferred thereonto may have a pattern. For example, the bottom substrate 104 or the top substrate 105 may have a patterned surface having a convex portion and a concave portion, and the convex portion may have a triangular, tetragonal, or circular cross-section. Also, the pressure sensor may further include an electrically connected to the electronic sheet 101, 102. In some embodiments, an electrode 103 may be electrically connected to at least one of the first electronic sheet 101 and the second electronic sheet 102, and may be patterned on the bottom substrate 104 or the top substrate 105. For example, the first electronic sheet 101 may be patterned and transferred between patterns of the electrode 103 on the bottom substrate 104. In some embodiments, the electrode 103 is transferred on the bottom substrate 104, and the first electronic sheet 101 is patterned and transferred on the electrode 103. In some embodiments, the first electronic sheet 101 is transferred on the bottom substrate 104, and the electrode 103 is patterned and transferred on the first electronic sheet 101. The second electronic sheet 102 and the electrode 103 may be disposed on the top substrate 105 in the same manner as described above.

[0040] In some embodiments, the pressure sensor may include a conductive material layer formed on the bottom substrate 104, or on at least a portion of a surface of the top substrate 105 facing the bottom substrate 104. For example, when an electronic sheet is formed on at least a portion of a surface of the top substrate 105 facing the bottom substrate 104, a conductive material layer may be formed on the bottom substrate 104, or when an electronic sheet is formed on the bottom substrate 104, a conductive material layer may be formed on at least a portion of a surface of the top substrate 105 facing the bottom substrate 104. The conductive material layer may include a conductive material, and examples thereof will be described below.

[0041] Each of the top substrate 105 and the bottom substrate 104 may be a flexible substrate, for example, a transparent flexible substrate. Each of the top substrate 105 and the bottom substrate 104 may be, for example, a substrate manufactured using polydimethylsiloxane (PDMS), polyethersulfone (PES), poly(3,4-ethylenedioxythiophene), poly(styrenesulfonate), polyimide, polyurethane, polyester, perfluoropolyether (PFPE), polycarbonate, or a combination of the foregoing polymers.

[0042] A material for the electrode 103 may include a conductive material, for example, silver, silver epoxy, palladium, copper, aluminum, gold, titanium, palladium, chromium, nickel, platinum, silver/silver chloride, silver/silver ion, or mercury/mercury oxide. In some embodiments, a conductive polymer may be used to form the electrode 103 due to its flexibility and ease of coating. In some embodiments, a conductive polymer may be used to form the electrode 103 due to its flexibility and ease of coating. An

example of such a conductive polymer is poly(3,4-ethylenedioxythiophene) polystyrene sulfonate (PEDOT:PSS).

[0043] Referring to FIGS. 4 and 5, at least a portion of the first electronic sheet 101 may contact at least a portion of the second electronic sheet 102, or at least a portion of the second electronic sheet 102 may contact at least a portion of the first electronic sheet 101. For the contact, the lower substrate 104 with the first electronic sheet 101 transferred thereon, or the top substrate 105 with the second electronic sheet 102 transferred thereon may be patterned as described above. In some embodiments, the pressure sensor may further include a cover 106 located on a surface of the bottom substrate 104 or the top substrate 105 being opposite to where the first and second electronic sheets 101 and 102 are formed. The cover 106 may protect or house the pressure sensor, and may be integrally formed with the lower substrate 104 or the top substrate 105.

[0044] Referring to FIG. 6, at least a portion of the first electronic sheet 101 formed on a convex portion of the lower substrate 104 may contact at least a portion of the second electronic sheet 102 formed on a convex portion or concave portion of the top substrate 105. In some embodiments, at least a portion of the second electronic sheet 102 formed on a convex portion of the top substrate 105 may contact at least a portion of the first electronic sheet 101 formed on a convex portion or concave portion of the lower substrate 104. For the contact, the bottom substrate 104 or the top substrate 105 may be patterned as described above. The contact may occur, for example, between the longest convex portions of two substrates, between side surfaces of convex portions of two substrates, or between the longest convex portion of a substrate and a concave portion of the other substrate. Due to the contact according to an embodiment, the pressure sensor may have high sensitivity and may quickly respond to even shear force.

[0045] Referring to FIG. 7, the pressure sensor may further include an intermediate insulating structure 107 or an intermediate insulating layer 108 to space the lower substrate 104 from the top substrate 105. For example, the lower substrate 104 and the top substrate 105 may be spaced apart from each other by a certain distance with the intermediate insulating structure 107 or the intermediate insulating layer 108 therebetween. The height of the intermediate insulating structure 107 or intermediate insulating layer 108 may be adjusted to be greater than that of the electrode 103 or the first electronic sheet 101 formed on the bottom substrate 104.

[0046] Pressure applied to the lower substrate 104, the top substrate 105, or the cover 106 may change a contact area, contact distance or a conductive network density between the first electronic sheet 101 and the second electronic sheet 102. Due to the applied pressure, the first electronic sheet 101 and the second electronic sheet 102, which have been spaced apart from each other, may be brought into contact each other, or in the case in which the first electronic sheet 101 and the second electronic sheet 102 have partly contacted each other, the contact area thereof may increase. Due to the applied pressure, a conductive network of the first electronic sheet 101 may contact a conductive network of the second electronic sheet 102 more. For example, when a convex portion of the lower substrate 104 or the top substrate 105 has a tetragonal cross-section, the applied pressure may not lead to an increase in the contact area between the first and second electronic sheets 101 and 102, but their

contact distance may be decrease, and their conductive networks may contact each other to a greater degree, resulting in a wider pressure driving range. For example, when a convex portion of the lower substrate **104** or the top substrate **105** has a pyramid-shape cross-section, the applied pressure may lead to an increase in the contact area and the conductive network contact between the first and second electronic sheets **101** and **102**, resulting in a higher sensitivity. When the contact area, contact distance or the conductive network density changes, the resistance or current of a sensor may change, allowing pressure applied to the sensor to be detectable.

[0047] In some embodiments, the pressure sensor may measure applied pressure by measuring capacitance. For example, in the case of a pressure sensor including a bottom substrate and a top substrate that are spaced apart from each other without electric contact by an intermediate insulating structure or an intermediate insulating layer, when pressure is applied, capacitance of the pressure sensor changes, and by measuring the change in capacitance, the applied pressure is measured.

[0048] In some embodiments, the pressure sensor may include a processor (not shown) that measures a signal (for example, an electric signal) corresponding to applied pressure, or obtains information about, for example, applied pressure. The processor may obtain information about force or pressure (for example, intensity of force, direction of force, or how many times force is applied) by measuring varying resistance or current. The information may be converted into a certain signal (for example, an electrical signal), which is then displayed, or may be provided to a separate device connected to the pressure sensor so as to allow the separate device to perform a target operation. Accordingly, the processor may include an electronic device that converts a measured value into a display value, a display showing results, or one or more control interfaces. In some embodiments, through an external measuring device (not shown) connected via an electrode, the pressure sensor may perform the same operation as described in connection with the processor.

[0049] Referring to FIG. 8, each of the first and second electronic sheets **101** and **102** may have an area of, for example, 0.0001 to 1000 cm², 0.0001 to 100 cm², or 1 to 20 cm², and a thickness of, for example, 20 to 2000 nm, 40 to 1500 nm, 40 to 1000 nm, 60 to 500 nm, or 80 to 200 nm. In some embodiments, an internal structure of each of the first and second electronic sheets **101** and **102** including a graphitic material **110** and a phage **120** may have a percolated network structure. The term “percolated network” used herein refers to a lattice structure consisting of random conductive or non-conductive linkages.

[0050] Another aspect provides a method of preparing an electronic sheet including: preparing a colloid material including a graphitic material; adding a phage, which displays a peptide having a binding ability to the graphitic material on its coat protein or a fragment thereof, to a solution so as to prepare a phage solution; mixing the colloid material and the phage solution so as to prepare a mixture; and dialyzing the mixture using a membrane so as to form an electronic sheet in a solution.

[0051] In preparing the colloid material, the colloid material may be an aqueous solution, in which graphitic materials

are dispersed or dissolved. The colloid material may be prepared by stabilizing the graphitic material in a surfactant-containing solution.

[0052] The surfactant may include a surfactant which is bio-compatible with biomaterials such as a peptide or a phage. Examples thereof are sodium dodecyl sulfate (SDS), sodium deoxycholate (DOC), Nonidet P-40, Triton X-100, and Tween 20®.

[0053] In preparing the phage solution, the method of preparing the phage is the same as described above. In some embodiments, the prepared phage may be added to an appropriate solution, for example, distilled water, phosphate-buffered saline (PBS), or Tris-buffered saline (TBS), and the solution may have a pH of 5 to 8.

[0054] In an exemplary embodiment, when a graphene sheet is used as the graphitic material, a two-dimensional structure of the graphene sheet may provide a large contact area of constituent materials, compared to a material of one-dimensional structure. Therefore, it is possible to realize a large hybrid electronic sheet.

[0055] In an exemplary embodiment, when a combination of a graphene sheet and a single-walled carbon nanotube is used as the graphitic material, the concentration of the graphene sheet needs not to be high, which is necessary for when a graphene sheet is used alone, while retaining the advantage of the two-dimensional structure of the graphene sheet.

[0056] In an exemplary embodiment, when the graphene sheet is combined with the single-walled carbon nanotube, the size and thickness of the resultant sheet increase and the effective area of a nanoelectrode per unit area increases.

[0057] In the dialyzing to form the electronic sheet, a membrane tube containing the mixture may be dialyzed against a dialysis solution, or the mixture may be dialyzed by using a membrane in itself. The membrane may include a semi-permeable film or any structure that allows a mixture, such as a material, to permeate therethrough. For example, the dialyzing to form the electronic sheet may be dialyzing in an ion-added solution. A concentration of ions included in the dialysis solution may be in a range of 0 or more to less than 10 mM. The ion concentration may be controllable by adding a monovalent electrolyte to the dialysis solution, for example, 0.1 mM NaCl to triple distilled water used for dialysis.

[0058] In some embodiments, the dialysis solution may be distilled water, triple distilled water (resistance >18 Mohm cm), PBS, or TBS in terms of stability with the phage.

[0059] In forming the electronic sheet by dialysis, the dialysis may be performed for about 5 to 60 hours, about 10 to 50 hours, or about 15 to 40 hours. After the dialysis, a thin electronic sheet may be formed along the surface of the membrane tube.

[0060] In some embodiments, the method of preparing the electronic sheet may further include, after forming the electronic sheet by dialysis, separating the formed electronic sheet from the membrane in an aqueous solution. The separation may be accomplished, for example, by twisting the membrane tube used for the dialysis to separate the electronic sheet formed along the membrane. A freestanding electronic sheet may be obtained by controlling a membrane clip in an aqueous solution.

[0061] In some embodiments, the method of preparing the electronic sheet may further include transferring the electronic sheet formed in the aqueous solution with a suitable

substrate or mask according to its purpose. The substrate or mask may be made of a metal, a semiconductor, an insulator, a polymer, an elastomer, etc. For example, a flexible electronic device may be prepared by transferring the electronic sheet with a flexible polymer substrate. In some embodiments, this process is to form patterns on the electronic sheet by transferring the separated electronic sheet with a patterned substrate or mask. For example, when a patterned stencil mask is used, a pattern is formed on the electronic sheet when the mask is detached after the electronic sheet is completely dried. By this process, a device may be realized on a flexible electronic sheet without additional physical or chemical etching.

[0062] In preparing the mixture, a mixing ratio of the colloidal graphitic material and the phage solution may be controlled by those skilled in the art, depending on use of the electronic sheet. That is, the mixing ratio may be controlled depending on the desired properties of the electronic sheet, such as electrical conductivity, electrical conductive properties, electrochemical charging current, hydrophilicity, etc. For example, the molar ratio of the colloidal graphitic material and the phage solution may be controlled in terms of structural stability of the electronic sheet, formation of the electronic sheet with a large area, and electrical resistance of the electronic sheet. The molar ratio of the colloidal graphitic material and the phage solution may be in a range of 30:1 to 1:30, in a range of 20:1 to 1:20, in a range of 15:1 to 1:15, in a range of 10:1 to 1:10, or in a range of 8:1 to 1:8, for example, 20:1, 10:1, 4:1, 1:4, or 1:8.

[0063] In some embodiments, a resistance value of the electronic sheet may be dependent on the molar ratio of the colloidal graphitic material and the phage solution. Accordingly, by controlling the molar ratio, the numbers of the graphitic material and the phage included in the electronic sheet are controlled and thus, a resistance value of the electronic sheet is controlled. For example, a ratio of the number of graphitic material to the number of phages included in the electronic sheet in the first electronic sheet or the second electronic sheet may be in a range of 1:10 to 10:1, 1:8 to 8:1, 1:4 to 4:1, or 1:2 to 2:1.

[0064] In some embodiments, by controlling the molar ratio or the number ratio, a resistance value of the first electronic sheet may be equal to or greater than a resistance value of the second electronic sheet. When the resistance value of the first electronic sheet is equal to or greater than the resistance value of the second electronic sheet, a driving range of the pressure sensor may be widened compared to when the resistance value of the first electronic sheet is less than the resistance value of the second electronic sheet. In some embodiments, the resistance value of the first electronic sheet may be less than the resistance value of the second electronic sheet. When the resistance value of the first electronic sheet is less than the resistance value of the second electronic sheet, sensitivity of the pressure sensor may be higher than when the resistance value of the first electronic sheet is equal to or greater than the resistance value of the second electronic sheet. The sensitivity of the pressure sensor indicates a minimum level of pressure detectable by a sensor. An increased or high sensitivity means that the level of pressure detectable is decreased or low. The driving range of the pressure sensor may indicate a range of pressure detectable by a sensor, and an increased or wide driving range of the pressure sensor means that the range of pressure detectable increases or widens. When

sensitivity of the pressure sensor is high, due to high pressure applied to a sensor, the sensor may have a saturated response degree, thereby having a narrow pressure driving range. When the driving range of the pressure sensor is wide, a response degree of the sensor with respect to applied pressure may less change. Accordingly, even at a high level of pressure, the sensor may measure change in pressure without saturation.

[0065] In an exemplary embodiment, the method of preparing the electronic sheet enables the manufacture of a nano structure in which a graphitic material and a phage are homogeneously dispersed, and also the manufacture of a large-area flexible electronic sheet having a thickness of 400 nm or less and an area having tens square centimeter.

[0066] In an exemplary embodiment, the method of preparing the electronic sheet may allow an electronic sheet to be transferred onto various substrates without chemical etching or use of an additional carrier material layer.

[0067] In an exemplary embodiment, the method of preparing the electronic sheet may provide ease of patterning using a substrate or a mask.

[0068] A peptide binding to the graphitic material may be a material capable of binding to the graphitic material in a nondestructive manner. The peptide may be selected from peptide libraries, for example, by a phage display technique. Through the phage display technique, the peptide may be genetically linked to, inserted into, or substituted for the coat protein of the phage, resulting in display of the protein on the exterior of phage, in which the peptide may be encoded by genetic information in the virion. Variants of the protein may be selected and screened by the displayed protein and DNA encoding the same, and this method is called "biopanning". Briefly, biopanning is carried out by incubating the pool of phage-displayed variants with a target (e.g., graphitic material) that has been immobilized, washing away unbound phage, and eluting specifically bound phage by disrupting the binding interactions between the phage and the target. A portion of the eluted phage is set aside for DNA sequencing and peptide identification, and the remainder is amplified *in vivo* to prepare a sub-library for the next round. Then, this procedure is repeated.

[0069] The term "phage" or "bacteriophage" is used interchangeably, and refers to a virus that infects bacteria and replicates within the bacteria. The phage or bacteriophage may be used to display a peptide which selectively or specifically binds to a graphitic material or volatile organic compound. The phage may be genetically engineered to display the peptide capable of binding to the graphitic material on a coat protein of the phage or a fragment thereof. As used herein, the term "genetic engineering" or "genetically engineered" means introduction of one or more genetic modifications into the phage in order to display the peptide capable of binding to the graphitic material on the coat protein of the phage or the fragment thereof, or a phage prepared thereby. The genetic modifications include introduction of a foreign gene encoding the peptide. The phage may be a filamentous phage, for example, M13 phage, F1 phage, Fd phage, If1 phage, Ike phage, Zj/Z phage, Ff phage, Xf phage, Pf1 phage, or Pf3 phage.

[0070] The term "phage display" or "phage with a peptide displayed thereon" used herein refers to a display of a functional foreign peptide or protein on the surface of a phage or phagemid particle. The surface of the phage may refer to a coat protein of the phage or a fragment thereof.

[0071] The functional foreign peptide may be present as being linked to the N-terminus of the coat protein of the phage, or as being inserted into a coat protein. The phage may be a phage in which the C-terminus of a functional foreign peptide is linked to the N-terminus of the coat protein of the phage, or the peptide is inserted between consecutive amino acid sequences of the coat protein of the phage or replaced for a part of the consecutive amino acid sequences of the coat protein. The positions in the amino acid sequence of the coat protein, at which the peptide is inserted or replaced, may be positions of 1 to 5, positions of 1 to 40, positions of 1 to 30, positions of 1 to 20, position of 1 to 10, positions of 2 to 8, positions of 2 to 4, positions of 2 to 3, positions of 3 to 4, or a position of 2, from the N-terminus of the coat protein. In some embodiments, the coat protein may be p3, p6, p8 or p9.

[0072] The peptide having a binding affinity specifically to the graphitic material may be a peptide or a peptide set including one or more selected from the group consisting of amino acid sequences of $X_2SX_1AAX_2X_3P$ (SEQ ID NO. 1), $X_2X_2PX_3X_2AX_3P$ (SEQ ID NO. 2), $SX_1AAX_2X_3P$ (SEQ ID NO. 3), and $X_2PX_3X_2AX_3P$ (SEQ ID NO. 4). In some embodiments, the peptide or peptide set may include one or more selected from the group consisting of amino acid sequences of SEQ ID NOS. 5 to 8. Consecutive amino acid sequences of a coat protein of a phage may be linked to the N-terminus or C-terminus of the amino acid sequence of the peptide or peptide set. Therefore, for example, the peptide or peptide set may have an amino acid sequence having a length of 5 to 60, 7 to 55, 7 to 40, 7 to 30, 7 to 20, or 7 to 10 amino acids.

[0073] The peptide may have a conservative substitution of a known peptide. The peptide may have a conservative substitution of a known peptide. The term "conservative substitution" used herein denotes replacement of a first amino acid residue with a second different amino acid residue without changing biophysical properties of a protein or a peptide. Here, the first and second amino acid residues mean those having side chains having similar biophysical properties. The similar biophysical properties may include an ability to donate or accept hydrophobicity, charge, polarity, or hydrogen bonding. Examples of the conservative substitution are within the groups of basic amino acids (arginine, lysine, and histidine), acidic amino acids (glutamic acid and aspartic acid), polar amino acids (glutamine and asparagine), hydrophobic amino acids (leucine, isoleucine, valine and methionine), hydrophilic amino acids (aspartic acid, glutamic acid, asparagine and glutamine), aromatic amino acids (phenylalanine, tryptophan, tyrosine and histidine), and small amino acids (glycine, alanine, serine and threonine). Amino acid substitutions that do not generally alter specific activity are known in the art. For example, in the peptide, X_1 may be W, Y, F, or H, X_2 may be D, E, N, or Q, and X_3 may be I, L, or V.

[0074] For example, the C-terminus of any one peptide of SEQ ID NO. 1 to SEQ ID NO. 8 may be linked to the body of M13 phage, that is, not to the tip of the phage, but to the N-terminus of p8 (SEQ ID NO. 19) having a length of 50 amino acids, which is present on the body in a longitudinal direction. In some embodiments, for example, any one peptide of SEQ ID NO. 1 to SEQ ID NO. 8 may be replaced for the positions of 2 to 4 (e.g., EGD), the positions of 2 and 3 or 3 and 4, or the position of 2 in the amino acid sequence of the coat protein p8 of M13 phage.

[0075] In an exemplary embodiment, a phage that displays a peptide having a binding affinity to a graphitic material specifically bind to the graphitic material, and thus additional functionalities may be provided by a non-destructive method that does not cause damage to properties of the graphitic material. In a case in which the peptide is displayed on the coat protein of the filamentous phage, a contact area with the graphitic material is large enough to provide a stronger binding affinity.

[0076] In an exemplary embodiment, the phage may be arranged on the graphitic surface with directionality using the filamentous structure of the phage in itself. For example, the phage may be arranged in a row in a specific direction. In this case, the binding affinity of the peptide present on the coat protein of the phage for the graphitic surface is enhanced and the phage is arranged in a row. The phage arranged in a row may provide anisotropic functionality to the graphitic surface, which is distinguishable from isotropic or random functionalities which are available when peptide is used alone. In addition to the arrangement in a row, the phage may be arranged to form a structure having specific directionality, such as a layered (e.g., smectic), nematic, spiral or lattice structure. Accordingly, various functionalities may be provided onto the graphitic surface using the arrangement structures of the phage.

[0077] In some embodiments, the pressure sensor may be a pressure sensor for measuring blood pressure or a heart rate.

[0078] The blood pressure may be arterial pressure, capillary blood pressure, or venous pressure, and in general, the blood pressure may mean arterial pressure. The arterial pressure changes corresponding to cardiac impulse. The blood pressure may be measured in an invasive manner or a non-invasive manner. In an embodiment, the pressure sensor may be connected to a catheter to measure blood pressure. In an example of the invasive manner, a catheter is inserted into a blood vessel to measure blood pressure through a connector containing, for example, a Heparin isotonic sodium chloride solution. In some embodiments, the pressure sensor is connected to a front end of the catheter to measure blood pressure. In the non-invasive manner, in some embodiments, the pressure sensor may be located on a site where a pulse wave is measurable, for example, a soft skin site where the radial artery, the brachial artery, the carotid artery, the carotid vein, the femoral artery, the popliteal artery, the tibial artery, or the dorsal pedis artery runs. In some embodiments, the pressure sensor may measure blood pressure by detecting the pressure (e.g. blood pressure) delivered to a skin site located above the blood vessel when the heart pulses and the blood vessel shrinks or expands.

[0079] In some embodiments, the pressure sensor may measure a heart impulse or a heart rate by detecting a pulse occurring in a blood vessel or vein when the heart pulses and converting the pulse into an electric signal.

[0080] Another aspect provides a wearable device including a pressure sensor, the pressure sensor including: a bottom substrate; a top substrate located on the bottom substrate and spaced apart from at least a portion of the bottom substrate; and an electronic sheet formed on at least a portion of the bottom substrate or at least a portion of a surface of the top substrate facing the bottom substrate, or a first electronic sheet formed on at least a portion of the bottom substrate and a second electronic sheet formed on at

least a portion of a surface of the top substrate facing the bottom substrate; wherein the electronic sheet includes a graphitic material and a phage binding to the graphitic material, and the binding is made between a peptide displayed on a coat protein or a fragment thereof of the phage and the graphitic material.

[0081] The pressure sensor is the same as described above.

[0082] The wearable device is used to measure bio-information, and the bio-information may include blood pressure or a heart rate. In an exemplary embodiment, the bio-information may be force or pressure generated by walking, and one or more pressure sensors may be mounted on the sole of a person's foot or footwear to measure the intensity or distribution degree of force caused by walking. Also, one or more pressure sensors may be mounted on a person's tooth or oral cavity to measure degree of force or distribution due to a tooth bite. Accordingly, in some embodiments, the wearable device may be a patch, a band, a watch, footwear, tooth attached device.

[0083] In some embodiments, the wearable device may further include a controller that logically communicates with the pressure sensor, and receives and processes signal data generated by the pressure sensor so as to output data associated with controlling the pressure sensor.

[0084] The pressure sensor of the wearable device may be controlled by the controller, which responds at certain time intervals or responds to a particular event (for example, a switch operation) and receives and processes bio-information detected by the pressure sensor.

[0085] In some embodiments, the wearable device may further include a memory that stores a processor for operation of a controller, and that temporally stores input/output data (for example, bio-information). The memory may store information (for example, blood pressure or heart rate) about electrical signals transmitted by the pressure sensor.

[0086] In some embodiments, the wearable device may further include a display unit that displays information processed by the controller or information stored by the memory. In some embodiments, the wearable device may further include a wireless communication unit that sends information processed by the controller or information stored by the memory to a person wearing the wearable device or other users (for example, a person located near the person wearing the wearable device, a trainer of athletes, a physician, a hospital, or the family of the person wearing the wearable device) all having a wireless communication system. For example the wireless communication unit may include a broadcasting receiving module, a mobile communication module, a wireless Internet module, or a near-distance communication module. Information detected by the pressure sensor may be sent to the person wearing the wearable device including the pressure sensor or other users through the wireless communication unit.

[0087] The pressure sensor has excellent controllable electric properties, and mechanical flexibility and stability, and accordingly, the pressure sensor is effectively used in the wearable device configured to measure bio-information (for example, blood pressure or heart rate).

[0088] Hereinafter, embodiments of the inventive concept will be described. However, the embodiments are presented herein for illustrative purpose only, and do not limit the scope of the inventive concept.

EXAMPLES

Manufacture of Pressure Sensor and Analysis on Characteristics Thereof

[0089] 1. Manufacture of Pressure Sensor 1

[0090] (1) Preparation of Hybrid Electronic Sheet 1

[0091] (1.1) Preparation of Colloid Solution

[0092] First, an aqueous solution was prepared by adding 2% w/v sodium cholate as a surfactant to distilled water, and a colloid solution was prepared by stabilizing single-walled carbon nanotubes with the sodium cholate by dialysis of carbon nanotubes (manufacturer: Nanointegris, SuperPure SWNTs, solution-type, concentration: 250 mg/ml) for 48 hours.

[0093] In this regard, assuming that an average length and an average diameter of the carbon nanotube (CNT) were 1 μm and 1.4 nm, respectively, the number of single-walled carbon nanotubes included in the colloid solution was calculated according to the following equation.

$$\text{Number of single-walled carbon nanotubes (number/mL)} = \text{concentration } (\mu\text{g/mL}) \times 3 \times 10^{11} \text{ CNT} \quad [\text{Equation 1}]$$

[0094] According to this Equation, the number of the single-walled carbon nanotube included in the colloid solution was $7.5 \times 10^{13}/\text{mL}$.

[0095] (1.2) Preparation of Phage Displaying Peptide Having Binding Ability to Graphitic Material

[0096] As M13 phages having a strong binding affinity to the graphitic surface, an M13 phage (p8 GB#1) displaying a peptide DSWAADIP (SEQ ID NO. 5) having a strong binding affinity to the graphitic surface and an M13 phage (p8 GB#5) displaying a peptide DNPIQAVP (SEQ ID NO. 6) were prepared by the following method.

[0097] First, an M13HK vector was prepared using oligonucleotides of SEQ ID NOS. 10 and 11 for site-directed mutation of the 1381st base pair C of an M13KE vector (NEB, product#N0316S) (SEQ ID NO. 9) to G. The prepared M13HK vector was double-digested using restriction enzymes, BspHI (NEB, product# R0517S) and BamHI (NEB, product#R3136T), and dephosphorylated using anti-arctic phosphatase. The dephosphorylated vector was ligated to a double-digested DNA duplex by incubation at 16 $^{\circ}$ C. overnight. A product is then purified and concentrated. Electrocompetent cells (XL-1 Blue, Stratagene) were transformed with 2 μl of a concentrated ligated vector solution by electroporation at 18 kV/cm. A total of five transformations were performed for the library construction. Then, the transformed cells were incubated for 60 minutes, and fractions of several transformants were plated onto agar plates containing x-gal/isopropyl- β -D-1-thiogalactopyranoside (IPTG)/tetracycline (Tet) to determine the diversity of the library. The remaining cells were amplified in a shaking incubator for 8 hours. Oligonucleotides of SEQ ID NOS. 12 and 13 were used in construction of the phage-display p8 peptide library.

[0098] The base sequences of the phage-display p8 peptide library constructed according to an exemplary embodiment had diversity of 4.8×10^7 pfu (plaque forming unit), and include approximately 1.3×10^5 copies of each sequence.

[0099] Then, a highly ordered pyrolytic graphite (HOPG) substrate (manufacturer: SPI product#439HP-AB) having a diameter of 1 cm was prepared. In this regard, the HOPG substrate was a HOPG substrate having a relatively large grain size of 100 μm or smaller. Previously, a carbon

nanotube film surface damaged during its production process had been generally used as a graphitic surface, and thus it was difficult to identify peptides having high binding affinity. In order to solve this problem, HOPG as a material having a graphitic surface was detached from a substrate by using a tape immediately before use, thereby obtaining a fresh surface, so as to minimize the occurrence of defects caused by, for example, oxidation. Subsequently, the phage display p8 peptide library of 4.8×10^{10} pfu (4.8×10^7 diversities, 1000 copies per each sequence), prepared as described above, was prepared in 100 μ L of tris-buffered saline (TBS) and conjugated with the HOPG surface for 1 hour in a shaking incubator at 100 rpm. 1 hour later, the solution was removed and the surface was washed 10 times in TBS. The washed HOPG surface was reacted with Tris-HCl of pH 2.2 as an acidic buffer for 8 minutes to elute peptides reacting non-selectively, and the remaining phage was eluted with an XL-1 blue *E. coli* culture in mid-log phase for 30 minutes. A portion of the eluted culture was set aside for DNA sequencing and peptide identification, and the remainder was amplified to prepare a sub-library for the next round. The above procedure was repeated using the prepared sub-library. Meanwhile, the left plaque was subjected to DNA sequencing to obtain the p8 peptide sequence, and the sequence was analyzed to obtain a phage (P8 GB#1) with DSWAADIP (SEQ ID NO: 5) displayed thereon and a phage (p8 GB#5) with DNPIQAVP (SEQ ID NO: 6) displayed thereon. Herein, DSWAADIP (SEQ ID NO: 5) and DNPIQAVP (SEQ ID NO: 6) were peptide sequences having a strong binding affinity to a graphitic material.

[0100] Also, regarding the binding between the phage and the graphitic material, it was considered that an aspartic acid (D), which is a first amino acid sequence from the N-termini of SEQ ID NOS. 5 and 6, does not affect the binding, and a phage with peptide sequences of SWAADIP (SEQ ID NO. 7) and NPIQAVP (SEQ ID NO. 8) displayed thereon was obtained to confirm its binding to a graphitic material.

[0101] (1.3) Preparation of Phage-Bound Hybrid Electronic Sheet

[0102] The colloid solution prepared above and a phage solution containing the M13 phage (p8 GB#1) having a strong binding force to the graphitic material were mixed at a molar ratio of 8:2.

[0103] Next, for dialysis, the mixture was added to a semipermeable dialysis membrane (SpectrumLab, MWCO 12,000 to 14,000, product #132 700) tube, and the membrane tube was dialyzed against triple distilled water. About 16 hours after the dialysis began, a thin electronic sheet was formed along the surface of the membrane tube. Next, the membrane tube was transferred to triple distilled water and the electronic sheet was detached by twisting the membrane of the membrane tube and then dried.

[0104] FIG. 9 illustrates how to manufacture a hybrid electronic sheet of a pressure sensor according to an exemplary embodiment.

[0105] As shown in FIG. 9, it is seen that carbon nanotubes were dispersed or dissolved in the colloid material which was stabilized by adding it to the surfactant-containing solution. Single-walled carbon nanotube was bound with M13 phage finally to form a sheet having a percolated network structure of carbon nanotubes and M13 phage.

[0106] (2) Manufacture of Bottom Substrate of Pressure Sensor

[0107] A PDMS polymer substrate was used as a bottom substrate. Sylgard® 184 silicon elastomer and a Sylgard® 184 silicon elastomer curing agent were mixed at a ratio of 10:1, and then, a thickness of the result was adjusted by petri-dish spin coating, and curing was performed thereon in an oven at a temperature of 70° C. for about 6 hours. The cured PDMS film was cut to a desired size by using a knife for surgery. On the separated flexible polymer PDMS film, a Stencil mask was mounted, and then, a metal electrode (Pt) was placed thereon by sputtering. Between patterns of the metal electrode, the hybrid electronic sheet prepared according to Example 1.3 was transferred on by using a stencil mask having a size of 1.5x1.5 cm, and then dried in air for about 1 hour. The resultant dried substrate with the hybrid electronic sheet electrode transferred thereon was used as a bottom substrate for a flexible pressure device.

[0108] (3) Manufacture of Top Substrate of Pressure Sensor

[0109] A mould for a patterned polymer substrate for use as a top substrate was manufactured. First, SU-8 100 (manufactured by Microchem Company) was spin-coated on a silicon wafer at a rotational rate of 3000 rpm, and then, sequentially cured at a temperature of 60° C. for 30 minutes and then, at a temperature of 90° C. for 60 minutes, and then, ultraviolet (UV) light was irradiated thereto through a mask having a target pattern and a mask aligner. A target pattern thickness was adjusted by controlling the thickness of a SU-8 film. A width of a line pattern was designed to be in a range of 200 to 400 μ m. After the irradiation of UV light, the result was cured at a temperature of 60° C. for about 1 minutes, and then, at a temperature of 90° C. for about 20 minutes, and then, the formed pattern was developed by using a developer dedicated for SU-8 only (manufactured by Microchem Company). The silicon wafer with a pattern thereon was used as a mould. In the case of a round mould, the line pattern formed as described above or a box pattern was formed by using photoresist, and then, an outer wall of a polymer was melted by using a polymer reflow method, thereby completing the manufacture of a round silicon mould. In the case of a pyramid-shape mould, a tetragonal concave pattern was formed on a silicon wafer by using a photoresist, and a portion of the silicon wafer corresponding to the tetragonal concave pattern that was not protected by the photoresist was etched by using a silicon etching solution (HF), thereby completing the manufacture of a pyramid-shape concave pattern.

[0110] Like the condition used to prepare the PDMS bottom substrate, Sylgard® 184 silicon elastomer and a Sylgard® 184 silicon elastomer curing agent were mixed at a ratio of 10:1, and the mixture was spin-coated on the silicon wafer mould with a pattern thereon while adjusting a thickness of the formed film, and curing was performed thereon in an oven at a temperature of 70° C. for about 6 hours. The cured PDMS film was carefully separated from the silicon wafer mould by using a knife for surgery, thereby completing manufacture of a patterned top substrate. A hybrid electronic sheet was transferred onto the patterned top substrate by using a stencil mask, and then dried in air for about 1 hour. The hybrid electronic sheet transferred on the patterned top substrate was washed with distilled water after the stencil mask was removed, and then, dried by using nitrogen gas. FIG. 10 shows an image of the micro structure of the top substrate with the hybrid electronic sheet transferred thereon.

[0111] FIG. 10 shows an image of the micro structure of the top substrate constituting a pressure sensor according to an exemplary embodiment.

[0112] As shown in FIG. 10, it is seen that the hybrid electronic sheet was conformally formed even on a substrate having a step.

[0113] (4) Manufacture of Pressure Sensor

[0114] The top substrate and the bottom substrate, each having the dried hybrid electronic sheet coated thereon, were stacked on each other, and then, the result structure was packaged by using a sticky polymer material, thereby completing the manufacture of a flexible pressure device. For the packaging, a PDMS solution that had been prepared at a ratio of 10:1 like the condition used to manufacture the bottom substrate, was used in an appropriate amount for coating outside the stack structure of top/bottom PDMS substrate, and then, cured at a temperature of 80° C. for about 30 minutes. Also, instead of the PDMS solution, an epoxy curing agent/a polyacrylate polymer adhesive were used to contact the two PDMS polymer substrates.

[0115] FIG. 11 shows an image of a pressure sensor according to an exemplary embodiment.

[0116] As shown in FIG. 11, it is seen that the pressure sensor according to an exemplary embodiment is a large-area flexible pressure sensor device having a thickness of 1 mm or less.

[0117] 2. Analysis on Properties of Pressure Sensor

[0118] (1) Analysis on Basic Properties

[0119] Performance of the manufactured pressure sensor was measured by using a 4156A precision semiconductor parameter analyzer manufactured by HP Company. Different pressures were applied to the manufactured pressure sensor and a voltage of -1V to +1V was applied to two electrodes to measure I-V (current vs. voltage) signals according to pressure, and results thereof are shown in FIGS. 12 and 13.

[0120] Also, whether the flexible pressure sensor promptly responds to a sudden change in pressure was confirmed as follows: a voltage of 2 V was applied to two electrodes and about 2 to 4 kPa of pressure was applied to the manufactured pressure sensor by tapping to measure real-time change in current by tapping, and results thereof are shown in FIG. 14.

[0121] FIG. 12 is a graph of current when different levels of pressure are applied to a pressure sensor according to an exemplary embodiment.

[0122] Referring to FIG. 12, it is seen that a higher pressure leads to a higher current flowing through a pressure sensor. This result shows that when the pressure sensor is more pressed, a contact area between a top substrate and a bottom substrate, each having an electronic sheet transferred thereon, is widened and accordingly, the resistance occurring between two electrodes decreases and the current flowing therebetween increases.

[0123] FIG. 13 is a graph of current when a pressure sensor according to an exemplary embodiment is pressed or released.

[0124] Referring to FIG. 13, when the pressure sensor is pressed, resistance is low and accordingly, high current flows, and when the pressure sensor is released, the current of the released pressure sensor is dropped to a range of 200 to 300 ms. Also, in view of the constant current flowing in the pressure sensor, it is seen that according to pressure applied to the pressure sensor, a resistance value of a hybrid electronic sheet changes quickly and stably.

[0125] FIG. 14 shows an image of an experiment in which a sudden pressure is applied to a pressure sensor according to an exemplary embodiment by using a finger, and illustrates a graph of change in current of the pressure sensor over time caused by force generated by the finger-tapping.

[0126] Referring to FIG. 14, when a sudden finger-tapping occurs, the current promptly increases and decreases, and the response speed of the flexible pressure sensor with respect to the finger-tapping is 50 ms or less.

[0127] (2) Analysis on Characteristics of Wearable Device

[0128] This experiment was performed to confirm whether the manufactured pressure device can be as a wearable device. A voltage of 2 V was applied between two electrodes, and flexible pressure devices were attached on the wrist where radial artery runs and the neck where carotid vein runs to measure change in blood pressure, and results thereof are shown in Table 15.

[0129] FIG. 15 illustrates a graph of current converted from a pulse of blood flow at radial artery measured by using a pressure sensor according to an exemplary embodiment.

[0130] Referring to FIG. 15, in the case of radial artery of the wrist, 20 pulses were measured for about 17 seconds, and each of the pulses had a period of about 0.83 s. In general, an ordinary person has about 65 to 75 blood pressure pulses per minute. The graph shows about 72 pulses for one minute which was measured by using a pressure sensor according to an exemplary embodiment. This result shows that the pressure sensor according to an exemplary embodiment can be used in a wearable device measuring blood pressure worn on a curved wrist.

[0131] (3) Analysis on Responding Property

[0132] The manufactured pressure device was compared with a commercially available force sensitive resistor (FSR)-based pressure sensor to analyze a responding property thereof.

[0133] Referring to FIG. 16, a hybrid electronic sheet-based flexible pressure device was stacked on a Philgets FSR sensor having a diameter of 10 mm, and then, a 1 kg (about 100 kPa) weight was placed on these two sensors. Then, a surrounding area thereof was tapped by using a finger and at this time, and the resistance of the sensors was measured. Results thereof are shown in FIG. 16.

[0134] FIG. 16 illustrates a schematic diagram showing how an experiment was performed in which a pressure sensor according to an exemplary embodiment was compared with a commercially available Philgets FSR sensor having a diameter of 10 mm, and a graph of a responding property of the two sensors with respect to vibration caused by finger-tapping on a desk.

[0135] Referring to FIG. 16, the sensors commonly showed a decrease in resistance due to vibration caused by tapping in the same period. The decrease in resistance to micro vibration caused by finger-tapping the pressure sensor according to an exemplary embodiment was about 7 times as high as that of the FSR sensor, and accordingly, it is seen that the pressure sensor according to an exemplary embodiment is more sensitive to vibration than the FSR sensor. That is, it is seen that the pressure sensor manufactured using a hybrid electronic sheet including a highly conductive/functional carbon nanotube was a highly-sensitive flexible pressure sensor that responds to even small change in pressure compared to the metal/polymer-based commercially available FSR sensor.

[0136] 3. Controlling Sensitivity of Pressure Sensor by Controlling Composition

[0137] (1) Manufacture of Pressure Sensors 2 to 4

[0138] A resistance-change pressure sensor operates based on change in resistance thereof according to change in a contact area between a top substrate and a bottom substrate occurring when the pressure sensor is pressed. Accordingly, it is possible that sensitivity of a pressure sensor is controllable by changing electrical characteristics of a top substrate and a bottom substrate. To do this, hybrid electronic sheets having different electric characteristics were prepared and placed on the top substrate or the bottom substrate of the pressure sensor.

[0139] In detail, pressure sensors were manufactured in the same manner as in Example 1, except that when the hybrid electron sheets for the top substrate and the bottom substrate were prepared, the phage solution including the colloid solution and the M13 phage(p8 GB#1) were prepared at molar ratios shown in Table 1. The resistance of a hybrid electronic sheet with respect to an electrode was measured as follows: a hybrid electronic sheet was transferred between two electrodes on a bottom substrate for a pressure sensor by using a stencil mask having a size of 2×2 mm and the resistance of the hybrid electronic sheet was measured by using a Fluke multi-meter. When a molar ratio of SWNT to p8 GB#1 was 8:2, the resistance of the hybrid electronic sheet was about 300Ω, and when a molar ratio of SWNT to p8 GB#1 was 2:2, the resistance of the hybrid electronic sheet was about 4300Ω. In other words, it is seen that electrical characteristics of the manufactured hybrid electronic sheet could be controlled by changing the molar ratio of SWNT to p8 GB#1.

TABLE 1

	Pressure sensor 1	Pressure sensor 2	Pressure sensor 3	Pressure sensor 4
Top substrate	8:2	2:2	2:2	8:2
Bottom substrate	8:2	8:2	2:2	2:2

[0140] To predict that it is possible to integrate and miniaturize pressure sensors 1 to 4, they were manufactured in a size of 2 mm×2 mm.

[0141] FIG. 17 shows an image of a small pressure sensor used for an experiment which was performed to identify the relationship between the sensitivity of a pressure sensor according to an exemplary embodiment and a composition of a hybrid electronic sheet of the pressure sensor.

[0142] As shown in FIG. 17, the small pressure sensor according to an exemplary embodiment was 55 times as small as the pressure sensor manufactured according to Example 1.3. This result shows that a hybrid electronic sheet according to an exemplary embodiment enables manufacture of an integrated and miniaturized pressure sensor.

[0143] (2) Analysis on Sensitivity of Pressure Sensor

[0144] To analyze sensitivity of pressure sensors 1 to 4, change in current according to pressure was measured as follows: a voltage of 0 to 20 V was applied between two electrodes, and a pressure applied was increased at an incremental rate of 1 kPa within a range of 0 to 5 kPa. Results thereof are shown in FIGS. 18 to 21.

[0145] FIG. 18 illustrates a graph of current with respect to pressure when a hybrid electronic sheet made from the

graphitic material and p8 GB#1 at a ratio of 8:2 and transferred on a top substrate of a pressure sensor according to an exemplary embodiment and a hybrid electronic sheet made from the graphitic material and p8 GB#1 at a ratio of 8:2 and transferred on a bottom substrate of the pressure sensor were pressed at an incremental pressure rate of 1 kPa, starting from 0 kPa.

[0146] FIG. 19 illustrates a graph of current with respect to pressure when a hybrid electronic sheet made from the graphitic material and p8 GB#1 at a ratio of 2:2 and transferred on a top substrate of a pressure sensor according to an exemplary embodiment and a hybrid electronic sheet made from the graphitic material and p8 GB#1 at a ratio of 8:2 and transferred on a bottom substrate of the pressure sensor were pressed at an incremental pressure rate of 1 kPa, starting from 0 kPa.

[0147] Referring to FIG. 18, in the case of the pressure sensor including the top substrate made from the graphitic material and p8 GB#1 at a ratio of 8:2 and the bottom substrate made from the graphitic material and p8 GB#1 at a ratio of 8:2, when a voltage of 1 kPa was applied to the pressure sensor, the current was increased by about 15%.

[0148] Referring to FIG. 19, in the case of the flexible pressure sensor that includes the top substrate with the hybrid electronic sheet formed using the graphitic material and p8 GB#1 at a ratio of 2:2 and transferred thereon and the bottom substrate with the hybrid electronic sheet formed using the graphitic material and p8 GB#1 at a ratio of 8:2 and transferred thereon, when a voltage of 1 kPa was applied to the pressure sensor, the current was increased by about 1%.

[0149] These results show that in the case in which the resistance of a top substrate is high, even when a contact area between the top substrate and a bottom substrate increases, due to such a high resistance, the increase in current is relatively low. That is, in the case in which the bottom substrate has high conductivity, the lower resistance the top substrate has, the higher sensitivity the pressure sensor has. Also, when a top substrate has high resistance, a pressure sensor having the top substrate has a high-pressure driving range.

[0150] FIG. 20 illustrates a graph of current with respect to pressure when a hybrid electronic sheet made from the graphitic material and p8 GB#1 at a ratio of 2:2 and transferred on a top substrate of a pressure sensor according to an exemplary embodiment and a hybrid electronic sheet made from the graphitic material and p8 GB#1 at a ratio of 2:2 transferred on a bottom substrate of the pressure sensor were pressed at an incremental rate of 1 kPa, starting from 0 kPa.

[0151] FIG. 21 illustrates a graph of current with respect to pressure when a hybrid electronic sheet made from the graphitic material and p8 GB#1 at a ratio of 8:2 and transferred on a top substrate of a pressure sensor according to an exemplary embodiment and a hybrid electronic sheet made from the graphitic material and p8 GB#1 at a ratio of 2:2 and transferred on a bottom substrate of the pressure sensor were pressed at an incremental rate of 1 kPa, starting from 0 kPa.

[0152] Referring to FIG. 20, in the case of the pressure sensor that includes the top substrate with the hybrid electronic sheet formed using the graphitic material and p8 GB#1 at a ratio of 2:2 and transferred thereon and the bottom substrate with the hybrid electronic sheet formed using the graphitic material and p8 GB#1 at a ratio of 2:2 and

transferred thereon, when a voltage of 1 kPa was applied to the pressure sensor, the current was increased by about 4%. This result shows that when the bottom substrate and the top substrate have high resistance, the sensitivity of the pressure sensor is lower than when the bottom substrate and the top substrate have low resistance.

[0153] Referring to FIG. 21, in the case of the pressure sensor that includes the top substrate with the hybrid electronic sheet formed using the graphitic material and p8 GB#1 at a ratio of 8:2 and transferred thereon and the bottom substrate with the hybrid electronic sheet formed using the graphitic material and p8 GB#1 at a ratio of 2:2 and transferred thereon, when a voltage of 1 kPa was applied to the pressure sensor, the current was increased by about 40%. Also, it is seen that when the resistance of the bottom substrate is high, the lower resistance the top substrate, which is to contact the bottom substrate, has, the higher sensitivity the pressure sensor has at a lower driving voltage.

[0154] From the results shown in FIGS. 18 to 21, it is seen that the sensitivity and driving range of a flexible pressure sensor are controllable by adjusting a composition of a hybrid electronic sheet. The results also show that in a pressure sensor according to an exemplary embodiment, when a top substrate is pressed, the top substrate is brought into contact with a bottom substrate, leading to a lower resistance and a higher current in the pressure sensor. This means that a driving range of the flexible pressure sensor is controllable by changing the strength or pattern structure of the top substrate.

[0155] 4. Manufacture of Pressure Sensor Including Electronic Sheet Formed on Either Top Substrate or Bottom Substrate and Characteristics Analysis of the Pressure Sensor

[0156] (1) Manufacture of Pressure Sensor 5

[0157] To manufacture a pressure sensor including a hybrid electronic sheet transferred only on a top substrate, a pressure sensor was manufactured in the same manner as used to manufacture the pressure sensor 1, except that a conductive polymer was coated on the bottom substrate.

[0158] In detail, to manufacture a bottom substrate coated with a conductive polymer PEDOT:PSS (poly(3,4-ethylenedioxythiophene) polystyrene sulfonate), a PDMS polymer substrate was used as the bottom substrate. Sylgard® 184 silicon elastomer and a Sylgard® 184 silicon elastomer curing agent were mixed at a ratio of 10:1, and then, a thickness of the result was adjusted by petri-dish spin coating, and curing was performed thereon in an oven at a temperature of 70° C. for about 6 hours. The cured PDMS film was cut to a desired size by using a knife for surgery. On the separated flexible polymer PDMS film, a Stencil mask was mounted, and then, a metal electrode (Pt) was placed thereon by sputtering. A PEDOT:PSS solution was dropped portionwise between deposited two electrodes, and then, spin coating was performed thereon at a 3000 rpm to complete the manufacture of the bottom substrate having conductivity. For stability of the bottom substrate, the bottom substrate was heat treated in an oven at a temperature of 80° C. for about 10 minutes.

[0159] A top substrate having a pyramid structure was manufactured by silicon wafer etching. In detail, a silicon substrate was patterned by using an exposure process to have a tetragonal pattern, and buffered oxide etching (BOE) was performed thereon for 10 minutes to remove silicon oxide, and then, 30% KOH etching was performed thereon

to manufacture a pyramid structure. A height of the pyramid structure was about 100 μm . Sylgard® 184 silicon elastomer and Sylgard® 184 silicon elastomer curing agent were mixed at a ratio of 10:1, and then, a petridish spin coating method was used to adjust the thickness of the resultant. Then, in an oven at a temperature of 70° C., curing was performed thereon for about 6 hours. The hardened PDMS film was cut to a target size by using an operating knife. A hybrid electronic sheet made from a graphitic material and p8 GB#1 at a ratio of 5:2 was transferred onto the top substrate having the pyramid structure by using a stencil mask, and then, dried for about one hour in air. The hybrid electronic sheet transferred on the polymer film of the top substrate was washed with distilled water after removing the stencil mask, and then dried by using nitrogen gas. Then, the bottom substrate with PEDOT:PSS coated thereon was folded with the top substrate with the hybrid electronic sheet coated thereon, the resultant structure was packaged by using a polymer material having sticky properties, thereby completing manufacture of a flexible pressure device. For device packaging, in the same manner as used to manufacture the bottom substrate, a PDMS solution was doped on outside a top/bottom substrate PDMS substrate, and then cured at a temperature of 80° C. for about 30 minutes. Also, instead of the PDMS solution, an epoxy curing agent/a polyacrylate polymer adhesive were used to bind two PDMS polymer substrates together.

[0160] (2) Analysis of Sensitivity of Pressure Sensor

[0161] A current change with respect to pressure was measured in such a way that 0-10 V of voltage was applied to two electrodes of the pressure sensor 5, while 0 to 5 kPa of pressure was applied thereto at an incremental rate of 1 kPa. Results thereof are shown in FIG. 22.

[0162] FIG. 22 illustrates a graph of current when 0 to 1 kPa of pressure was incrementally applied to a pressure sensor according to an embodiment including a top substrate with a hybrid electronic sheet made from graphitic material and p8 GB#1 at a ratio of 5:2 and transferred thereon and a bottom substrate having PEDOT:PSS transferred thereon.

[0163] Referring to FIG. 22, in the case of a flexible pressure device in which a hybrid electronic sheet made from a graphitic material and p8 GB#1 at a ratio of 5:2 is transferred on a top substrate and PEDOT:PSS is transferred on a bottom substrate, it is seen that when about 1 kPa of pressure was applied, the current was increased by about 1% current. This result shows that even when a hybrid electronic sheet is transferred on at least one of the top substrate and the bottom substrate, the flexible pressure device still works.

[0164] Pressure sensors according to embodiments have excellent controllable electric properties, and mechanical flexibility and stability, and can be used to measure, for example, pressure in an easy and highly reproducible manner in which resistance of a component in the pressure sensor is changed when pressure is applied thereto.

[0165] It should be understood that exemplary embodiments described herein should be considered in a descriptive sense only and not for purposes of limitation. Descriptions of features or aspects within each exemplary embodiment should typically be considered as available for other similar features or aspects in other exemplary embodiments.

[0166] While one or more exemplary embodiments have been described with reference to the figures, it will be understood by those of ordinary skill in the art that various changes in form and details may be made therein without departing from the spirit and scope of the inventive concept as defined by the following claims.

SEQUENCE LISTING

<160> NUMBER OF SEQ ID NOS: 14

<210> SEQ ID NO 1
<211> LENGTH: 8
<212> TYPE: PRT
<213> ORGANISM: Artificial Sequence
<220> FEATURE:
<223> OTHER INFORMATION: peptide selectively binding to graphitic materials
<220> FEATURE:
<221> NAME/KEY: VARIANT
<222> LOCATION: (1)..(1)
<223> OTHER INFORMATION: X is D, E, N, or Q
<220> FEATURE:
<221> NAME/KEY: VARIANT
<222> LOCATION: (3)..(3)
<223> OTHER INFORMATION: X is W, Y, F or H
<220> FEATURE:
<221> NAME/KEY: VARIANT
<222> LOCATION: (6)..(6)
<223> OTHER INFORMATION: X is D, E, N or Q
<220> FEATURE:
<221> NAME/KEY: VARIANT
<222> LOCATION: (7)..(7)
<223> OTHER INFORMATION: X is I, L, or V

<400> SEQUENCE: 1

Xaa Ser Xaa Ala Ala Xaa Xaa Pro
1 5

<210> SEQ ID NO 2
<211> LENGTH: 8
<212> TYPE: PRT
<213> ORGANISM: Artificial Sequence
<220> FEATURE:
<223> OTHER INFORMATION: peptide selectively binding to graphitic materials
<220> FEATURE:
<221> NAME/KEY: VARIANT
<222> LOCATION: (1)..(1)
<223> OTHER INFORMATION: X is D, E, N, or Q
<220> FEATURE:
<221> NAME/KEY: VARIANT
<222> LOCATION: (2)..(2)
<223> OTHER INFORMATION: X is D, E, N, or Q
<220> FEATURE:
<221> NAME/KEY: VARIANT
<222> LOCATION: (4)..(4)
<223> OTHER INFORMATION: X is I, L, or V
<220> FEATURE:
<221> NAME/KEY: VARIANT
<222> LOCATION: (5)..(5)
<223> OTHER INFORMATION: X is D, E, N, or Q
<220> FEATURE:
<221> NAME/KEY: VARIANT
<222> LOCATION: (7)..(7)
<223> OTHER INFORMATION: X is I, L, or V

<400> SEQUENCE: 2

Xaa Xaa Pro Xaa Xaa Ala Xaa Pro
1 5

<210> SEQ ID NO 3
<211> LENGTH: 7
<212> TYPE: PRT
<213> ORGANISM: Artificial Sequence
<220> FEATURE:
<223> OTHER INFORMATION: peptide selectively binding to graphitic

-continued

materials
<220> FEATURE:
<221> NAME/KEY: VARIANT
<222> LOCATION: (2)..(2)
<223> OTHER INFORMATION: X is W, Y, F, or H
<220> FEATURE:
<221> NAME/KEY: VARIANT
<222> LOCATION: (5)..(5)
<223> OTHER INFORMATION: X is D, E, N, or Q
<220> FEATURE:
<221> NAME/KEY: VARIANT
<222> LOCATION: (6)..(6)
<223> OTHER INFORMATION: X is I, L, or V

<400> SEQUENCE: 3

Ser Xaa Ala Ala Xaa Xaa Pro
1 5

<210> SEQ ID NO 4
<211> LENGTH: 7
<212> TYPE: PRT
<213> ORGANISM: Artificial Sequence
<220> FEATURE:
<223> OTHER INFORMATION: peptide selectively binding to graphitic
materials
<220> FEATURE:
<221> NAME/KEY: VARIANT
<222> LOCATION: (1)..(1)
<223> OTHER INFORMATION: X is D, E, N, or Q
<220> FEATURE:
<221> NAME/KEY: VARIANT
<222> LOCATION: (3)..(3)
<223> OTHER INFORMATION: X is I, L, or V
<220> FEATURE:
<221> NAME/KEY: VARIANT
<222> LOCATION: (4)..(4)
<223> OTHER INFORMATION: X is D, E, N, or Q
<220> FEATURE:
<221> NAME/KEY: VARIANT
<222> LOCATION: (6)..(6)
<223> OTHER INFORMATION: X is I, L, or V

<400> SEQUENCE: 4

Xaa Pro Xaa Xaa Ala Xaa Pro
1 5

<210> SEQ ID NO 5
<211> LENGTH: 8
<212> TYPE: PRT
<213> ORGANISM: Artificial Sequence
<220> FEATURE:
<223> OTHER INFORMATION: peptide selectively binding to graphitic
materials

<400> SEQUENCE: 5

Asp Ser Trp Ala Ala Asp Ile Pro
1 5

<210> SEQ ID NO 6
<211> LENGTH: 8
<212> TYPE: PRT
<213> ORGANISM: Artificial Sequence
<220> FEATURE:
<223> OTHER INFORMATION: peptide selectively binding to graphitic
materials

<400> SEQUENCE: 6

Asp Asn Pro Ile Gln Ala Val Pro
1 5

-continued

<210> SEQ ID NO 7
<211> LENGTH: 7
<212> TYPE: PRT
<213> ORGANISM: Artificial Sequence
<220> FEATURE:
<223> OTHER INFORMATION: peptide selectively binding to graphitic materials

<400> SEQUENCE: 7

Ser Trp Ala Ala Asp Ile Pro
1 5

<210> SEQ ID NO 8
<211> LENGTH: 7
<212> TYPE: PRT
<213> ORGANISM: Artificial Sequence
<220> FEATURE:
<223> OTHER INFORMATION: peptide selectively binding to graphitic materials

<400> SEQUENCE: 8

Asn Pro Ile Gln Ala Val Pro
1 5

<210> SEQ ID NO 9
<211> LENGTH: 7222
<212> TYPE: DNA
<213> ORGANISM: Artificial Sequence
<220> FEATURE:
<223> OTHER INFORMATION: cloning vector M13KE

<400> SEQUENCE: 9

aatgctacta ctattagtag aattgatgcc accttttcag ctcgcccc aaatgaaaat 60
atagctaaac aggttattga ccatttcgca aatgtatcta atgggtcaaac taaatctact 120
cgttcgcaga attgggaatc aactgttata tggaatgaaa cttccagaca cgttacttta 180
gttgcatatt taaaacatgt tgagctacag catttatattc agcaattaag ctctaagcca 240
tccgcaaaaa tgacctctta tcaaaaggag caattaaagg tactctctaa tctgacctg 300
ttggagtttg cttccggctc ggttcgcttt gaagctcgaa ttaaaacgcg atatttgaag 360
tctttcgggc ttctctctaa tctttttgat gcaatccgct ttgcttctga ctataatagt 420
cagggtaaag acctgatttt tgatttatgg tcattctcgt tttctgaact gtttaagca 480
tttgaggggg attcaatgaa tatttatgac gattccgcag tattggacgc tatccagtct 540
aaacatttta ctattacccc ctctggcaaa acttcttttg caaaagcctc tcgctatttt 600
ggtttttattc gtctgtctgt aaacgagggg tatgatagtg ttgctcttac tatgcctcgt 660
aattcctttt ggcgttatgt atctgcatta gttgaatgtg gtattcctaa atctcaactg 720
atgaatcttt ctacctgtaa taatgttgtt ccgtagtttc gttttattaa cgtagatttt 780
tcttcccaac gtctgactgt gtataatgag ccagttctta aaatcgcata aggtaattca 840
caatgattaa agttgaaatt aaaccatctc aagccaatt tactactcgt tctgggtgtt 900
ctcgtcaggg caagccttat tcaactgaatg agcagctttg ttacgttgat ttgggtaatg 960
aatatccggg tcttgcaag attactcttg atgaaggtea gccagcctat ggcctgggtc 1020
tgtacaccgt tcatctgtcc tctttcaaag ttggtcagtt eggttccctt atgattgacc 1080
gtctgcgcct cgttccggct aagtaacatg gacgaggtcg eggatttcga cacaatttat 1140

-continued

cagcggatga tacaaatctc cgttgtaact tgtttcgcgc ttggtataat cgctgggggt	1200
caaagatgag tgttttagtg tattcttttg cctctttcgt tttagggttg tgccttcgta	1260
gtggcattac gtatthtacc cgtttaatgg aaacttcctc atgaaaaagt ctttagtcct	1320
caaagcctct gtagcgttg ctaccctcgt tccgatgctg tctttcgtcg ctgagggtga	1380
cgatcccga aaagcggcct ttaactccct gcaagcctca gcgaccgaat atategggta	1440
tgcgtgggag atggttggtg tcattgtcgg cgcaactatc ggatcaagc tgtttaagaa	1500
attcacctcg aaagcaagct gataaacga tacaattaaa ggctcctttt ggagcctttt	1560
ttttggagat tttcaactgg aaaaaattat tattcgaat tcttttagtg gtacctttct	1620
attctcactc ggccgaaact gttgaaagtt gtttagcaaa atcccataca gaaaattcat	1680
ttactaacgt ctggaaagc gacaaaactt tagatcgta cgtaactat gagggctgct	1740
tgtggaatgc tacagcgtt gtagtttgta ctgggtgacga aactcagtgt tacggtacat	1800
gggttctcat tggccttgct atccctgaaa atgaggggtg tggtctgag ggtggcgggt	1860
ctgagggtgg cggttctgag ggtggcggta ctaaactccc tgagtacggt gatcaccta	1920
ttccgggcta tacttatatc aacctctcgc acggcactta tccgctggt actgagcaaa	1980
accccgctaa tctaatcct tctcttgagg agtctcagcc tcttaactat ttcattgttc	2040
agaataatag gttccgaaat aggcaggggg cattaactgt ttatacgggc actgttactc	2100
aaggcactga ccccgtaaaa acttattacc agtacctccc tgatcatca aaagccatgt	2160
atgacgctta ctggaacggt aaattcagag actgcgcttt ccattctggc tttaatgagg	2220
atattttgt ttgtgaatat caaggccaat cgtctgacct gcctcaacct cctgtcaatg	2280
ctggcggcgg cctcgttggt ggttctgggt gcggctctga ggggtggggt cctgaggggtg	2340
gcggttctga ggggtggcgg cctgagggag gcggttccgg tgggtgctct ggttccgggtg	2400
atthtgatta tgaagatg gcaaacgcta ataagggggc tatgaccgaa aatgccgatg	2460
aaaacgcgct acagctcagc gctaaaggca aacttgattc tgcgctact gattacgggtg	2520
ctgctatcga tggtttcatt ggtgacgttt ccggccttgc taatggtaat ggtgctactg	2580
gtgattttgc tggctcfaat tcccaaatgg ctcaagtcgg tgacgggtgat aattcacctt	2640
taatgaataa tttccgtcaa tatttacctt cctcctcctc atcgggtgaa tgcgccccct	2700
ttgtctttgg cgtcggtaaa ccatatgaat tttctattga ttgtgacaaa ataaacttat	2760
tccgtggtgt ctttgcgttt cttttatag ttgccacctt tatgtatgta tttctacgt	2820
ttgctaocat actgcgtaat aaggagtctt aatcatgcca gttcttttgg gtattccgtt	2880
attattcgtt tctcctgggt tctctctggg aactttgttc ggctatctgc ttacttttct	2940
taaaaagggc ttcggtaaga tagctattgc tatttcattg tttcttgctc ttattattgg	3000
gcttaactca attcttgggt gttatctctc tgatattagc gctcaattac cctctgactt	3060
tgttcagggt gttcagttaa ttctcccgct taatcgctt cctgttttt atgttattct	3120
ctctgtaaag gctgctatth tcatthttga cgttaaacaa aaaatcgttt cttatttgga	3180
ttgggataaa taatatggct gtttattttg taactggcaa attaggctct ggaagacgc	3240
tcgttagcgt tggtaagatt caggataaaa ttgtagctgg gtgcaaaaata gcaactaatc	3300
ttgatttaag gcttcaaac ctcccgaag tggggaggtt cgtaaaaacg cctcgcgttc	3360
ttagaatacc ggataagcct tctatatctg atthgcttgc tattgggcgc ggtaatgatt	3420

-continued

cctacgatga aaataaaaac ggcttgcttg ttctcgatga gtgcggtact tggtttaata	3480
cccgttcttg gaatgataag gaaagacagc cgattattga ttggtttcta catgctcgta	3540
aattaggatg ggatattatt tttcttgctc aggacttato tattgttgat aaacaggcgc	3600
gttctgcatt agctgaacat gttgtttatt gtcgctgctc ggacagaatt actttacctt	3660
ttgtcggtag tttatattct cttattactg gctcgaaaat gcctctgect aaattacatg	3720
ttggcgttgt taaatatggc gattctcaat taagccctac tgttgagcgt tggctttata	3780
ctggaagaa tttgtataac gcatatgata ctaaacaggc ttttcttagt aattatgatt	3840
ccggtgttta ttctatttta acgccttatt tatcacacgg tcggtatttc aaaccattaa	3900
atthagtca gaagatgaaa ttaactaaaa tatatttgaa aaagtttctc cgcgttcttt	3960
gtcttgcatg tggatttgca tcagcattta catatagtta tataacccaa cctaagccgg	4020
aggttaaaaa ggtagtctct cagacctatg attttgataa attcactatt gactcttctc	4080
agcgtcttaa tctaagctat cgctatgttt tcaaggattc taagggaaaa ttaattaata	4140
gcgacgattt acagaagcaa ggttattcac tcacatata tgatttatgt actgtttcca	4200
ttaaaaaagg taattcaaat gaaattgta aatgtaatta attttgtttt cttgatgttt	4260
gtttcatcat ctctctttgc tcaggtaatt gaaatgaata attcgcctct gcgcgatttt	4320
gtaacttggg attcaaagca atcaggcgaa tccgttattg tttctccga tgtaaaagg	4380
actgttactg tatattcatc tgacgttaaa cctgaaaatc tacgcaattt ctttatttct	4440
gttttacgtg caaataattt tgatatggta ggttctaacc ctccattat tcagaagat	4500
aatccaaaca atcaggatta tattgatgaa ttgccatcat ctgataatca ggaatatgat	4560
gataattccg ctctctctgg tggtttcttt gttccgcaaa atgataatgt tactcaaaact	4620
tttaaaatta ataacgttgc ggcaaggat ttaatacgag ttgtogaatt gttgtaaag	4680
tctaataact ctaaaactct aaatgtatta tctattgacg gctctaactt attagttgtt	4740
agtgcctcta aagatatttt agataacott cctcaattcc tttcaactgt tgatttgcca	4800
actgaccaga tattgattga gggtttgata tttgaggttc agcaaggatga tgctttagat	4860
ttttcatttg ctgctggctc tcagcgtggc actgttgacg gcggtgttaa tactgaccgc	4920
ctcacctctg ttttatcttc tgcctgggtt tegtctggta ttttaatgg cgatgtttta	4980
gggetatcag ttccgcgcat aaagactaat agccattcaa aaatattgtc tgtgccacgt	5040
attcttacgc tttcaggta gaagggttct atctctgttg gccagaatgt tctttttatt	5100
actggtcgtg tgactggtga atctgccaat gtaaataatc catttcagac gattgagcgt	5160
caaaatgtag gtatttccat gagegttttt cctgttgcaa tggctggcgg taatattgtt	5220
ctggatatta ccagcaagc cgatagtttg agttcttcta ctcaggcaag tgatgttatt	5280
actaatcaaa gaagtattgc tacaacgggt aatttgctg atggacagac tcttttactc	5340
gggtgacctc ctgattataa aaacacttct caggattctg gcgtaccggt cctgtctaaa	5400
atccctttaa tcggctctct gtttagctcc cgctctgatt ctaacgagga aagcacgtta	5460
taegtgtctg tcaaaagcaac catagtacgc gccctgtagc ggccgattaa gcgcggcggg	5520
tgtggtgggt acgcgcagcg tgaccgctac acttgccagc gccctagcgc cegctccttt	5580
cgctttcttc ccttctcttc tcgccacggt cgccggcttt ccccgtaag ctctaaatcg	5640
ggggctccct ttagggttcc gatttagtgc tttacggcac ctgcaccoca aaaaacttga	5700

-continued

```

tttgggtgat ggttcacgta gtgggccatc gccctgatag acggtttttc gccctttgac 5760
gttgaggtcc acgttcttta atagtggact cttgttccaa actggaacaa cactcaacce 5820
tatctcgggc tattcttttg atttataagg gattttgccc atttcggaac caccatcaaa 5880
caggattttc gectgctggg gcaaaccagc gtggaccgct tgctgcaact ctctcagggc 5940
caggcgggtga agggcaatca gctgttgccc gtctcactgg tgaagaaaa aaccaccctg 6000
gcgccaata cgcaaacgc ctctccccgc gcgttgcccg attcattaat gcagctggca 6060
cgacaggttt ccgactgga aagcgggcag tgagcgcaac gcaattaatg tgagttagct 6120
cactcattag gacccccagg ctttacactt tatgcttccg gctcgtatgt tgtgtggaat 6180
tgtgagcggg taacaatttc acacaggaaa cagctatgac catgattacg ccaagcttgc 6240
atgcctgcag gtctctgaat tcaactggccg tcgttttaca acgctcgtgac tgggaaaacc 6300
ctggcgttac ccaacttaat cgcttgcag cacatcccc tttcgccagc tggcgtaata 6360
gcgaagaggc ccgaccgat cgccctccc aacagttgcg cagcctgaat ggcgaatggc 6420
gctttgcctg gtttccggca ccagaagcgg tgccgaaaag ctggctggag tgcgatcttc 6480
ctgaggccga tactgtcgtc gtcccctcaa actggcagat gcacggttac gatgcgcca 6540
tctacaccaa cgtgacctat cccattacgg tcaatccgcc gtttgttccc acggagaatc 6600
cgacgggttg ttactcgtc acatttaatg ttgatgaaag ctggctacag gaaggccaga 6660
cgcaattat ttttgatggc gttcctattg gttaaaaat gagctgattt aacaaaaatt 6720
taatgcgaat ttaacaaaa tattaacggt tacaatttaa atatttgctt atacaatctt 6780
cctgtttttg gggcttttct gattatcaac cggggtacat atgattgaca tgctagtttt 6840
acgattaccg ttcacgatt ctctgtttg ctccagactc tcaggcaatg acctgatagc 6900
ctttgtagat ctctcaaaaa tagctaccct ctccggcatt aatttatcag ctagaacggt 6960
tgaatatcat attgatggtg atttgactgt ctccggcctt tctcaccctt ttgaatcttt 7020
acctacacat tactcaggca ttgcatttaa aatatatgag ggttcaaaaa atttttatcc 7080
ttcgttgaa ataaaggctt ctccgcaaa agtattacag ggtcataatg tttttggtac 7140
aaccgattta gctttatgct ctgaggcttt attgcttaat tttgctaatt ctttgccctg 7200
cctgtatgat ttattggatg tt 7222

```

```

<210> SEQ ID NO 10
<211> LENGTH: 41
<212> TYPE: DNA
<213> ORGANISM: Artificial Sequence
<220> FEATURE:
<223> OTHER INFORMATION: BamH I_SM_upper which is a primer used for
site-directed mutation

```

```
<400> SEQUENCE: 10
```

```
aaggccgctt ttgctggatc ctcaccctca gcagcgaag a 41
```

```

<210> SEQ ID NO 11
<211> LENGTH: 41
<212> TYPE: DNA
<213> ORGANISM: Artificial Sequence
<220> FEATURE:
<223> OTHER INFORMATION: BamH I_SM_lower which is a primer used for
site-directed mutation

```

```
<400> SEQUENCE: 11
```

-continued

```
tctttcgtg ctgagggtga ggatcccga aaagcgcct t 41
```

```
<210> SEQ ID NO 12
<211> LENGTH: 90
<212> TYPE: DNA
<213> ORGANISM: Artificial Sequence
<220> FEATURE:
<223> OTHER INFORMATION: BamM13HK_P8_primer which is an extension
        primer used for preparation
```

```
<400> SEQUENCE: 12
```

```
ttaatgaaa cttcctcatg aaaaagtctt tagtctcaa agcctctgta gccgttgcta 60
```

```
ccctcgttcc gatgctgtct ttcgctgctg 90
```

```
<210> SEQ ID NO 13
<211> LENGTH: 95
<212> TYPE: DNA
<213> ORGANISM: Artificial Sequence
<220> FEATURE:
<223> OTHER INFORMATION: M13HK_P8 which is a library oligonucleotide
        used for preparation
```

```
<220> FEATURE:
<221> NAME/KEY: misc_feature
<222> LOCATION: (1)..(95)
<223> OTHER INFORMATION: n is a, g, c or t
<220> FEATURE:
<221> NAME/KEY: misc_feature
<222> LOCATION: (1)..(95)
<223> OTHER INFORMATION: m is a or c
```

```
<400> SEQUENCE: 13
```

```
aagccgctt ttgcgggatc cnnmnmnm nmnmnmnm nmncagcagc gaaagacagc 60
```

```
atcggaacga gggtagcaac ggctacagag gcttt 95
```

```
<210> SEQ ID NO 14
<211> LENGTH: 50
<212> TYPE: PRT
<213> ORGANISM: Artificial Sequence
<220> FEATURE:
<223> OTHER INFORMATION: P8 protein of M13 phage
```

```
<400> SEQUENCE: 14
```

```
Ala Glu Gly Asp Asp Pro Ala Lys Ala Ala Phe Asn Ser Leu Gln Ala
1           5           10           15
```

```
Ser Ala Thr Glu Tyr Ile Gly Tyr Ala Trp Ala Met Val Val Val Ile
          20           25           30
```

```
Val Gly Ala Thr Ile Gly Ile Lys Leu Phe Lys Lys Phe Thr Ser Lys
          35           40           45
```

```
Ala Ser
50
```

What is claimed is:

1. A pressure sensor comprising
 - a bottom substrate;
 - a top substrate located on the bottom substrate and spaced apart from at least a portion of the bottom substrate; and
 - an electronic sheet formed on at least a portion of the bottom substrate or at least a portion of a surface of the top substrate facing the bottom substrate, or
 - a first electronic sheet formed on at least a portion of the bottom substrate and a second electronic sheet formed

on at least a portion of a surface of the top substrate facing the bottom substrate;

wherein the electronic sheet comprises a graphitic material and a phage binding to the graphitic material, and the binding is made between a peptide displayed on a coat protein or a fragment thereof of the phage and the graphitic material.

2. The pressure sensor of claim 1, wherein at least a portion of the first electronic sheet contacts at least a portion of the second electronic sheet, or the at least a portion of the

second electronic sheet contacts the at least a portion of the first electronic sheet.

3. The pressure sensor of claim 1, wherein the bottom substrate or the top substrate has an uneven surface pattern having a convex portion and a concave portion.

4. The pressure sensor of claim 3, wherein the convex portion has a triangular, tetragonal, or circular cross-section.

5. The pressure sensor of claim 3, wherein at least a portion of the first or second electronic sheet on the convex portion of the bottom or top substrate contacts at least a portion of the corresponding electronic sheet on the convex or concave portion of the corresponding substrate.

6. The pressure sensor of claim 1, wherein the bottom substrate or the top substrate comprises a flexible substrate.

7. The pressure sensor of claim 1, wherein the bottom substrate is spaced apart from the top substrate with an intermediate insulating layer or an intermediate insulating structure therebetween.

8. The pressure sensor of claim 1, further comprising a cover on a surface of the bottom substrate or the top substrate, being opposite to where the corresponding electronic sheet is formed.

9. The pressure sensor of claim 1, wherein a contact area, a contact distance or a conductive network density of the first electronic sheet and the second electronic sheet is dependent on pressure applied to the bottom substrate and the top substrate, respectively.

10. The pressure sensor of claim 1, wherein a number ratio of the graphitic material to the phage in the first electronic sheet or second electronic sheet is in a range of 1:10 to 10:1.

11. The pressure sensor of claim 1, wherein a resistance value of the first electronic sheet is equal to or greater than a resistance value of the second electronic sheet.

12. The pressure sensor of claim 1, wherein a resistance value of the first electronic sheet is less than a resistance value of the second electronic sheet.

13. The pressure sensor of claim 1, wherein an interior structure of the first and second electronic sheets comprises a percolated network structure.

14. The pressure sensor of claim 1, wherein the graphitic material comprises at least one selected from a graphene sheet, a highly oriented pyrolytic graphite (HOPG) sheet, a graphene oxide, a reduced graphene oxide, a single-walled carbon nanotube, a double-walled carbon nanotube, a multi-walled carbon nanotube, and fullerene.

15. The pressure sensor of claim 1, wherein the graphitic material comprises a combination of a graphene sheet and a single-walled carbon nanotube.

16. The pressure sensor of claim 1, wherein the peptide has a least one sequence selected from amino acid sequences set forth in SEQ ID NO. 1 to SEQ ID NO. 8.

17. The pressure sensor of claim 1, wherein the phage is genetically engineered to have a binding property to the graphitic material.

18. The pressure sensor of claim 1, wherein the phage comprises M13 phage, F1 phage, Fd phage, If1 phage, Ike phage, Zj/Z phage, Ff phage, Xf phage, Pf1 phage, or Pf3 phage.

19. The pressure sensor of claim 1, wherein the pressure sensor is to measure blood pressure or a heart rate.

20. A wearable device comprising the pressure sensor of claim 1

* * * * *

专利名称(译)	压力传感器包括混合电子板和包括压力传感器的可穿戴设备		
公开(公告)号	US20160287089A1	公开(公告)日	2016-10-06
申请号	US14/988459	申请日	2016-01-05
[标]申请(专利权)人(译)	韩国科学技术研究院		
申请(专利权)人(译)	韩国学院科技		
当前申请(专利权)人(译)	韩国学院科技		
[标]发明人	YI HYUN JUNG LEE SEUNG WOO LEE KI YOUNG		
发明人	YI, HYUN JUNG LEE, SEUNG WOO LEE, KI YOUNG		
IPC分类号	A61B5/021 A61B5/00		
CPC分类号	A61B5/6801 A61B5/021 A61B5/0245 A61B5/6802 A61B5/6803 A61B5/6807 A61B5/681 G01L9/12 A61B5/02108 A61B5/0215 A61B5/1036 A61B5/6897 A61B2562/0247 A61B2562/028		
优先权	1020150046751 2015-04-02 KR		
其他公开文献	US10568579		
外部链接	Espacenet USPTO		

摘要(译)

提供的是包括混合动力用电子片和包括该压力传感器的可穿戴设备的压力传感器。压力传感器具有优异的可控电学特性和在其中在传感器的部件的电阻取决于施加的压力简单且高度可重复的方式优异的机械灵活性和稳定性，和措施，例如压力。

