



US008868169B2

(12) **United States Patent**
Narayan et al.

(10) **Patent No.:** **US 8,868,169 B2**
(45) **Date of Patent:** ***Oct. 21, 2014**

(54) **METHOD AND SYSTEM FOR DETECTION OF BIOLOGICAL RHYTHM DISORDERS**

A61B 5/046 (2006.01)
A61B 5/0452 (2006.01)
A61B 5/00 (2006.01)

(71) Applicants: **Sanjiv Narayan**, La Jolla, CA (US);
Ruchir Sehra, Scottsdale, AZ (US)

(52) **U.S. Cl.**
CPC *A61B 5/0456* (2013.01); *A61B 5/726* (2013.01); *A61B 5/0464* (2013.01); *A61B 5/0422* (2013.01); *A61B 5/0472* (2013.01); *A61B 5/046* (2013.01); *A61B 5/0452* (2013.01)
USPC **600/516**; 600/515; 600/512; 600/513

(72) Inventors: **Sanjiv Narayan**, La Jolla, CA (US);
Ruchir Sehra, Scottsdale, AZ (US)

(58) **Field of Classification Search**
CPC A61B 5/0452; A61B 5/04525; A61B 5/04011; A61B 5/0205; A61B 5/0456
USPC 600/512, 513, 515, 516
See application file for complete search history.

(73) Assignees: **The Regents of the University of California**, Oakland, CA (US); **Topera, Inc.**, Menlo Park, CA (US); **The United States of America as represented by the Department of Veterans Affairs**, Washington, DC (US)

(*) Notice: Subject to any disclaimer, the term of this patent is extended or adjusted under 35 U.S.C. 154(b) by 0 days.

This patent is subject to a terminal disclaimer.

(56) **References Cited**

U.S. PATENT DOCUMENTS

5,121,750 A 6/1992 Katims
5,172,699 A 12/1992 Svenson et al.
(Continued)

OTHER PUBLICATIONS

U.S. Appl. No. 13/081,411.*

(Continued)

(21) Appl. No.: **14/137,929**

(22) Filed: **Dec. 20, 2013**

(65) **Prior Publication Data**

US 2014/0114204 A1 Apr. 24, 2014

Related U.S. Application Data

(63) Continuation of application No. 13/081,411, filed on Apr. 6, 2011, now Pat. No. 8,700,140.

(60) Provisional application No. 61/342,016, filed on Apr. 8, 2010.

(51) **Int. Cl.**
A61B 5/0456 (2006.01)
A61B 5/0464 (2006.01)
A61B 5/042 (2006.01)
A61B 5/0472 (2006.01)

(57) **ABSTRACT**

System, assembly and method are provided to facilitate reconstruction of cardiac information representing a complex rhythm disorder associated with a patient's heart to indicate a source of the heart rhythm disorder. The complex rhythm disorder can be treated by application of energy to modify the source of the rhythm disorder.

67 Claims, 26 Drawing Sheets

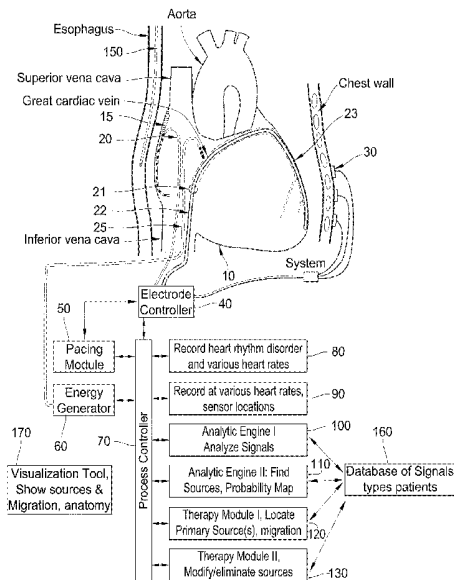

(56)

References Cited

U.S. PATENT DOCUMENTS

5,433,198 A 7/1995 Desai
 5,450,846 A 9/1995 Goldreyer
 5,480,422 A 1/1996 Ben-Haim
 5,487,391 A 1/1996 Panescu
 5,582,173 A 12/1996 Li
 5,657,755 A 8/1997 Desai
 5,662,108 A 9/1997 Budd et al.
 5,718,241 A 2/1998 Ben-Haim et al.
 5,795,303 A 8/1998 Swanson et al.
 5,817,134 A 10/1998 Greenhut et al.
 5,840,025 A 11/1998 Ben-Haim
 5,848,972 A 12/1998 Triedman et al.
 5,868,680 A 2/1999 Steiner et al.
 5,954,665 A 9/1999 Ben-Haim
 6,052,618 A 4/2000 Dahlke et al.
 6,066,094 A 5/2000 Ben-Haim
 6,188,924 B1 2/2001 Swanson et al.
 6,236,883 B1 5/2001 Ciaccio et al.
 6,256,540 B1 7/2001 Panescu et al.
 6,301,496 B1 10/2001 Reisfeld
 6,360,121 B1 3/2002 Shoda
 6,522,905 B2 2/2003 Desai
 6,584,345 B2 6/2003 Govari
 6,847,839 B2 1/2005 Ciaccio et al.
 6,856,830 B2 2/2005 He
 6,892,091 B1 5/2005 Ben-Haim et al.
 6,920,350 B2 7/2005 Xue et al.
 6,941,166 B2 9/2005 MacAdam et al.
 6,959,212 B2 10/2005 Hsu et al.
 6,975,900 B2 12/2005 Rudy et al.
 6,978,168 B2 12/2005 Beatty et al.
 7,016,719 B2 3/2006 Rudy et al.
 7,043,292 B2 5/2006 Tarjan et al.
 7,117,030 B2 10/2006 Berenfeld et al.
 7,123,954 B2 10/2006 Narayan et al.
 7,206,630 B1 4/2007 Tarler
 7,245,962 B2 7/2007 Ciaccio et al.
 7,263,397 B2 8/2007 Hauck et al.
 7,283,865 B2 10/2007 Norén
 7,289,843 B2 10/2007 Beatty et al.
 7,328,063 B2 2/2008 Zhang et al.
 7,505,810 B2 3/2009 Harlev et al.
 7,515,954 B2 4/2009 Harlev et al.
 7,751,882 B1 7/2010 Helland
 7,761,142 B2 7/2010 Ghanem et al.
 7,761,150 B2 7/2010 Ghanem et al.
 7,930,018 B2 4/2011 Harlev et al.
 7,930,020 B2 4/2011 Zhang et al.
 8,165,666 B1 4/2012 Briggs et al.
 8,165,671 B2 4/2012 Freeman et al.
 2002/0010392 A1 1/2002 Desai
 2003/0236466 A1 12/2003 Tarjan et al.
 2004/0073262 A1 4/2004 Lovett
 2005/0148892 A1 7/2005 Desai
 2005/0203502 A1 9/2005 Boveja et al.
 2006/0084970 A1 4/2006 Beatty et al.
 2007/0055167 A1 3/2007 Bullinga
 2007/0208260 A1 9/2007 Afonso

2007/0299351 A1 12/2007 Harlev et al.
 2008/0114258 A1 5/2008 Zhang et al.
 2009/0069704 A1 3/2009 MacAdam et al.
 2009/0099468 A1 4/2009 Thiagalingam et al.
 2009/0112106 A1 4/2009 Zhang
 2009/0112199 A1 4/2009 Zhang et al.
 2009/0177071 A1 7/2009 Harlev et al.
 2009/0177072 A1 7/2009 Harlev et al.
 2009/0299424 A1 12/2009 Narayan
 2010/0094274 A1 4/2010 Narayan
 2010/0204592 A1 8/2010 Hatib et al.
 2010/0305456 A1 12/2010 Brainard, II
 2011/0087121 A1 4/2011 Zhang et al.
 2011/0112425 A1 5/2011 Muhlsteff et al.
 2011/0130801 A1 6/2011 Maskara et al.
 2011/0251505 A1 10/2011 Narayan
 2011/0282227 A1 11/2011 Zhang
 2012/0232417 A1 9/2012 Zhang et al.

OTHER PUBLICATIONS

Houben, R.P.M. et al "Automatic mapping of human atrial fibrillation by template matching", Heart Rhythm, vol. 3 No. 10, Oct. 1, 2006, pp. 1221-1228.*
 Houben, R.P.M., et al, "Automatic mapping of human atrial fibrillation by template matching", Heart Rhythm, vol. 3, No. 10, Oct. 1, 2006, pp. 1221-1228.
 Nademane, Koonlawee, et al., "A new approach for catheter ablation of atrial fibrillation: mapping of the electrophysiologic substrate", J. Amer.Coll.Cardiol., vol. 43, No. 11, Jun. 2, 2004, pp. 2044-2053.
 Narayan, S.M., et al., "Dynamics factors preceding the initiation of atrial fibrillation in humans", Heart Rhythm, vol. 5, No. 6, Jun. 1, 2008, pp. S22-S25.
 Ciaccio, Edward J. et al., "Development of Gradient Descent Adaptive Algorithms to Remove Common Mode Artifact for Improvement of Cardiovascular Signal Quality", Annals of Biomedical Engineering, vol. 35, No. 7, Jul. 2007, pp. 1146-1155.
 Sornborger, Andrew, et al., "Extraction of Periodic Multivariate Signals: Mapping of Voltage-Dependent Dye Fluorescence in the Mouse Heart", IEEE Transactions on Medical Imaging, vol. 22, No. 12, Dec. 2003, pp. 1537-1549.
 Sun, Yan, et al., "Characteristic wave detection in ECG signal using morphological transform", BMC Cardiovascular Disorders, vol. 5, No. 28, 2005.
 Tai, Dean C.S., et al., "Correction of motion artifact in transmembrane voltage-sensitive fluorescent dye emission in hearts", Am. J. Physiol. Heart Circ. Physiol., vol. 287, 2004, pp. H985-H993.
 Lin, Y-J, et al., "Electrophysiological Characteristics and Catheter Ablation in Patients With Paroxysmal Right Atrial Fibrillation", Circulation, Sep. 20, 2005; 112(12): 1692-1700, EPub Sep. 12, 2005.
 Houben, R.P.M., et al., "Processing of Intracardiac Electrograms in Atrial Fibrillation", IEEE Engineering in Medicine and Biology Magazine, 2006, Nov./Dec., pp. 40-51.
 Saksena, S., et al., "Regional Endocardial Mapping of Spontaneous and Induced Atrial Fibrillation in Patients With Heart Disease and Refractory Atrial Fibrillation", Am J Cardiol, 1999; 84:880-889.

* cited by examiner

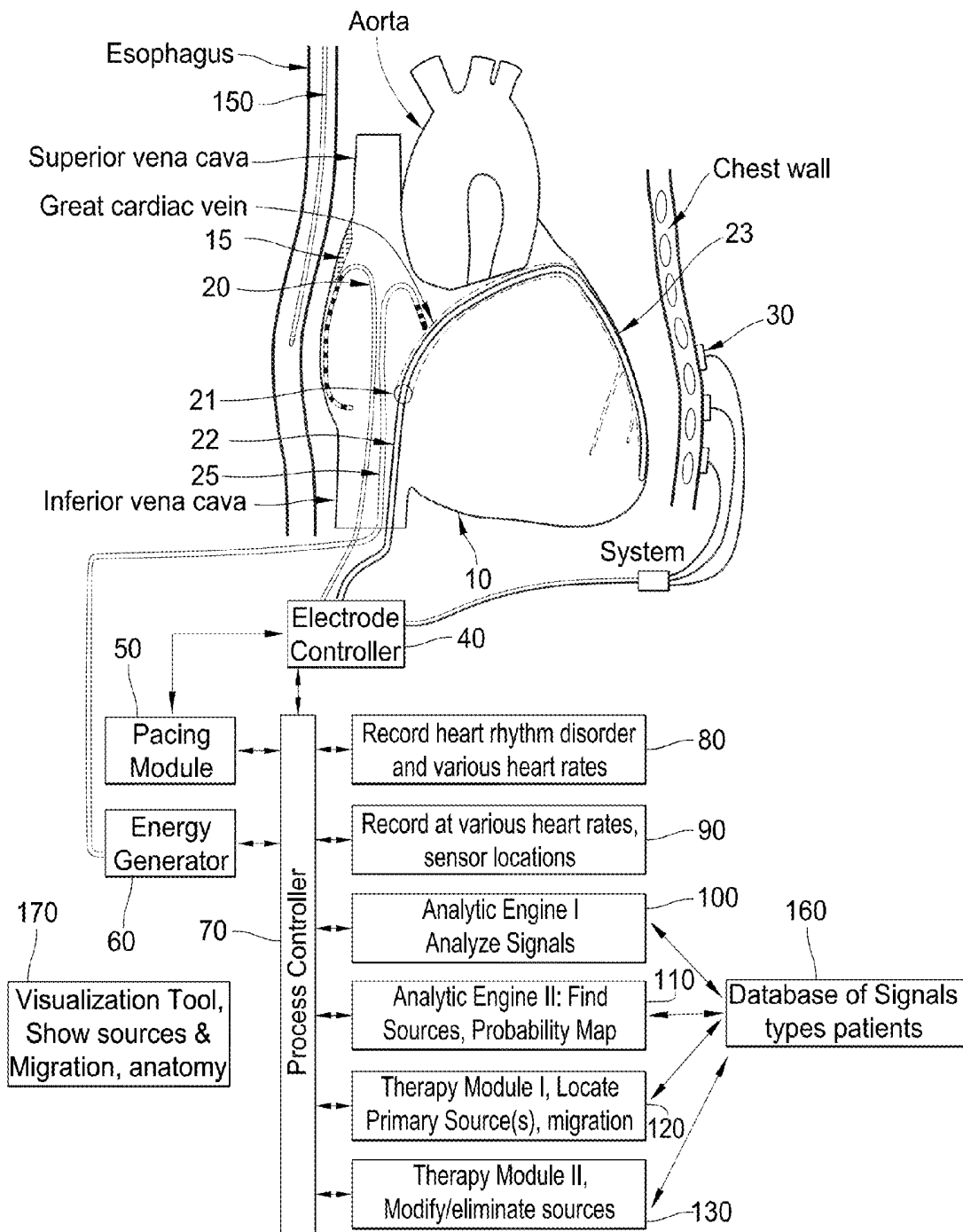

FIG. 1

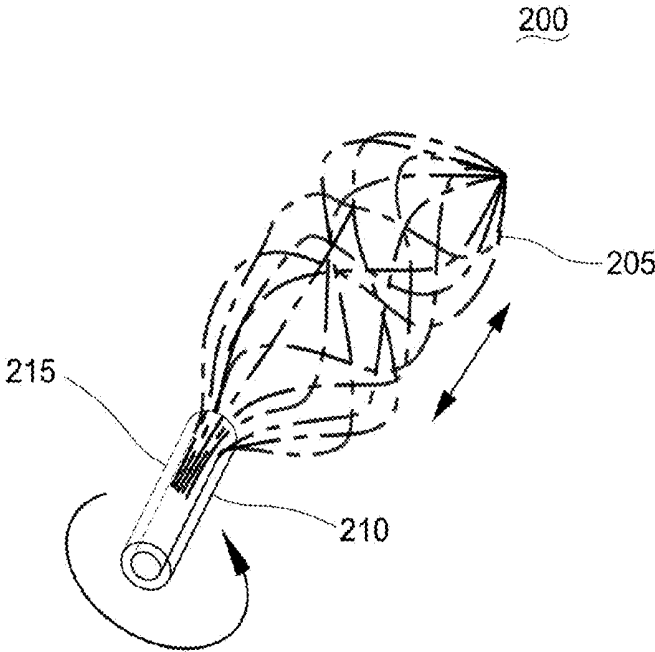

FIG. 2

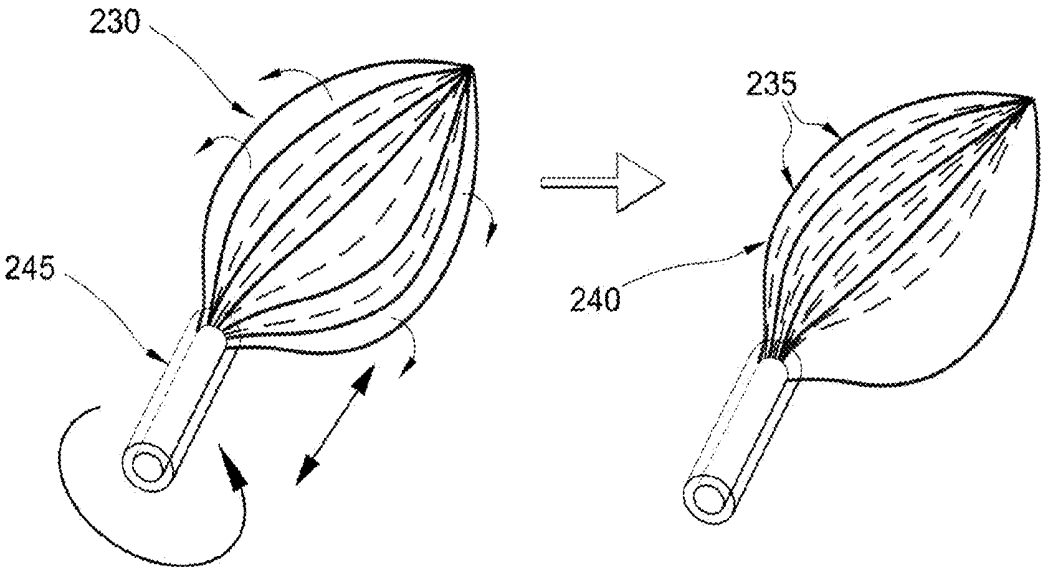

FIG. 3

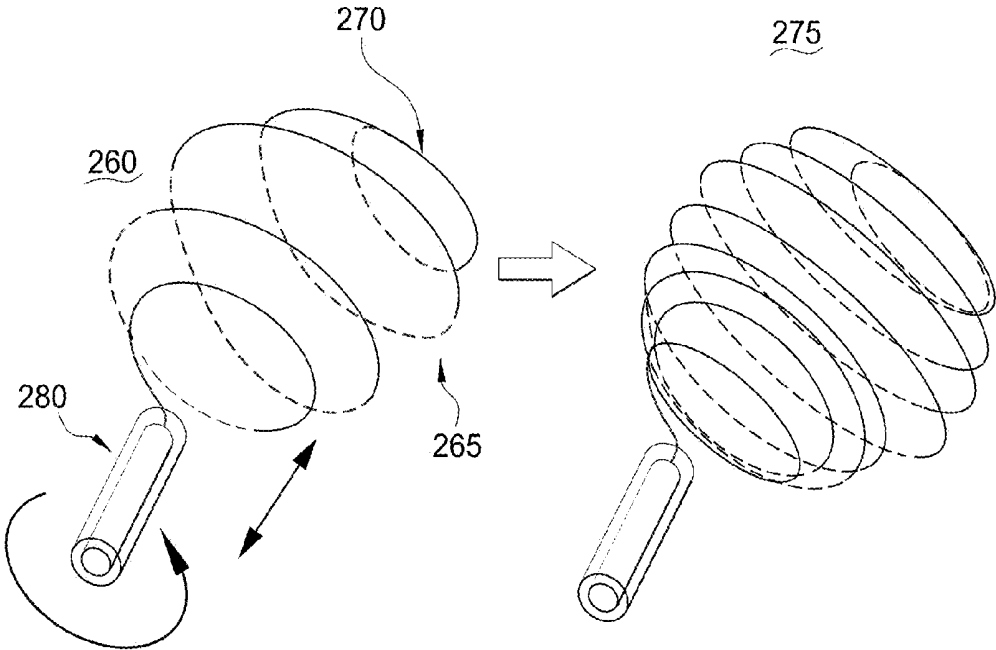

FIG. 4

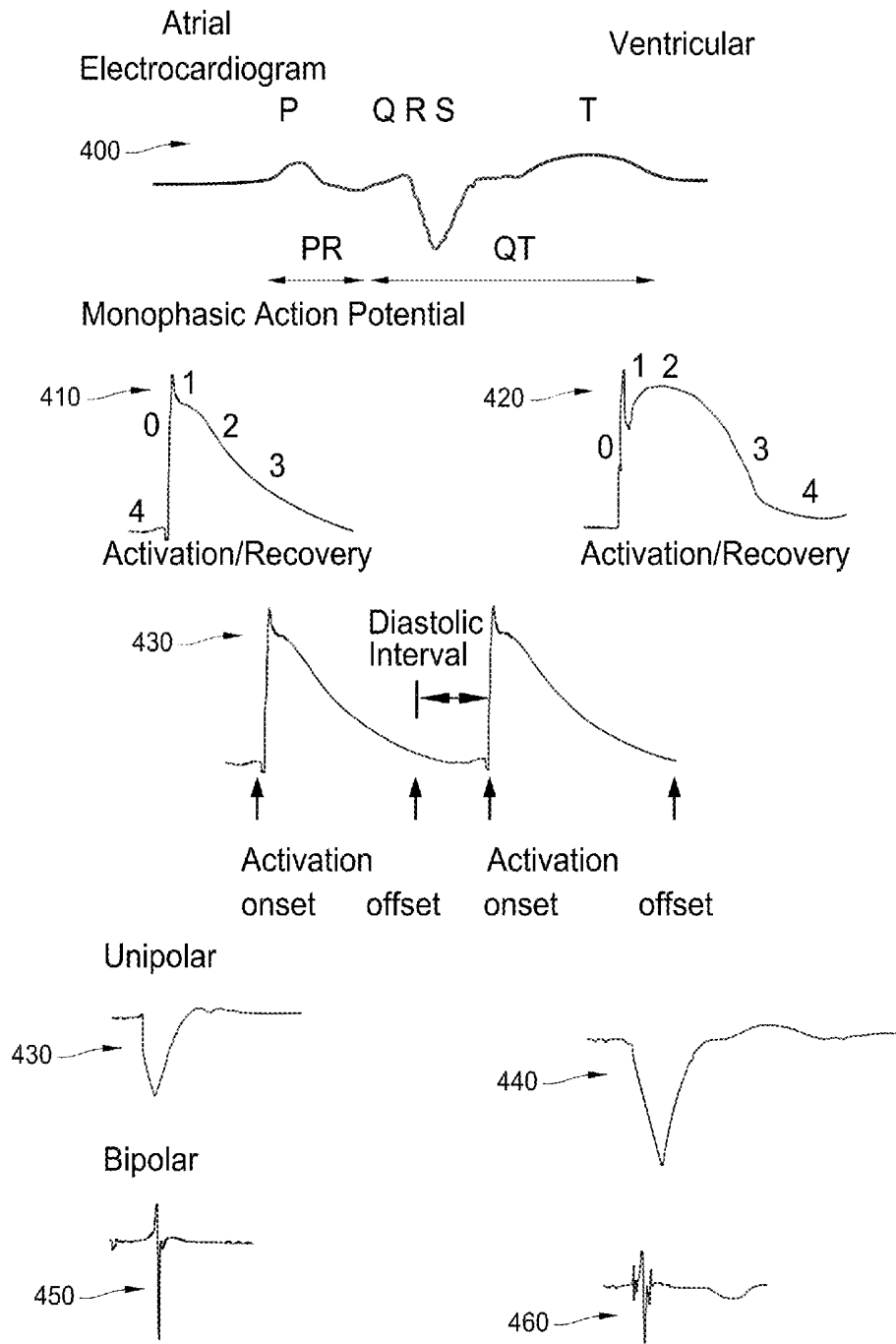

FIG. 5

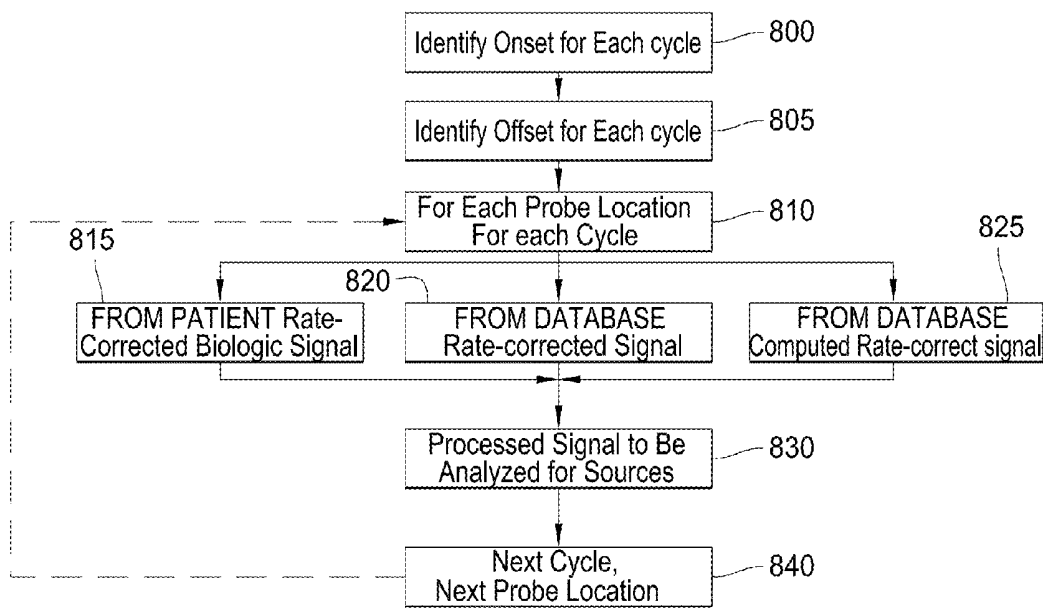

FIG. 6

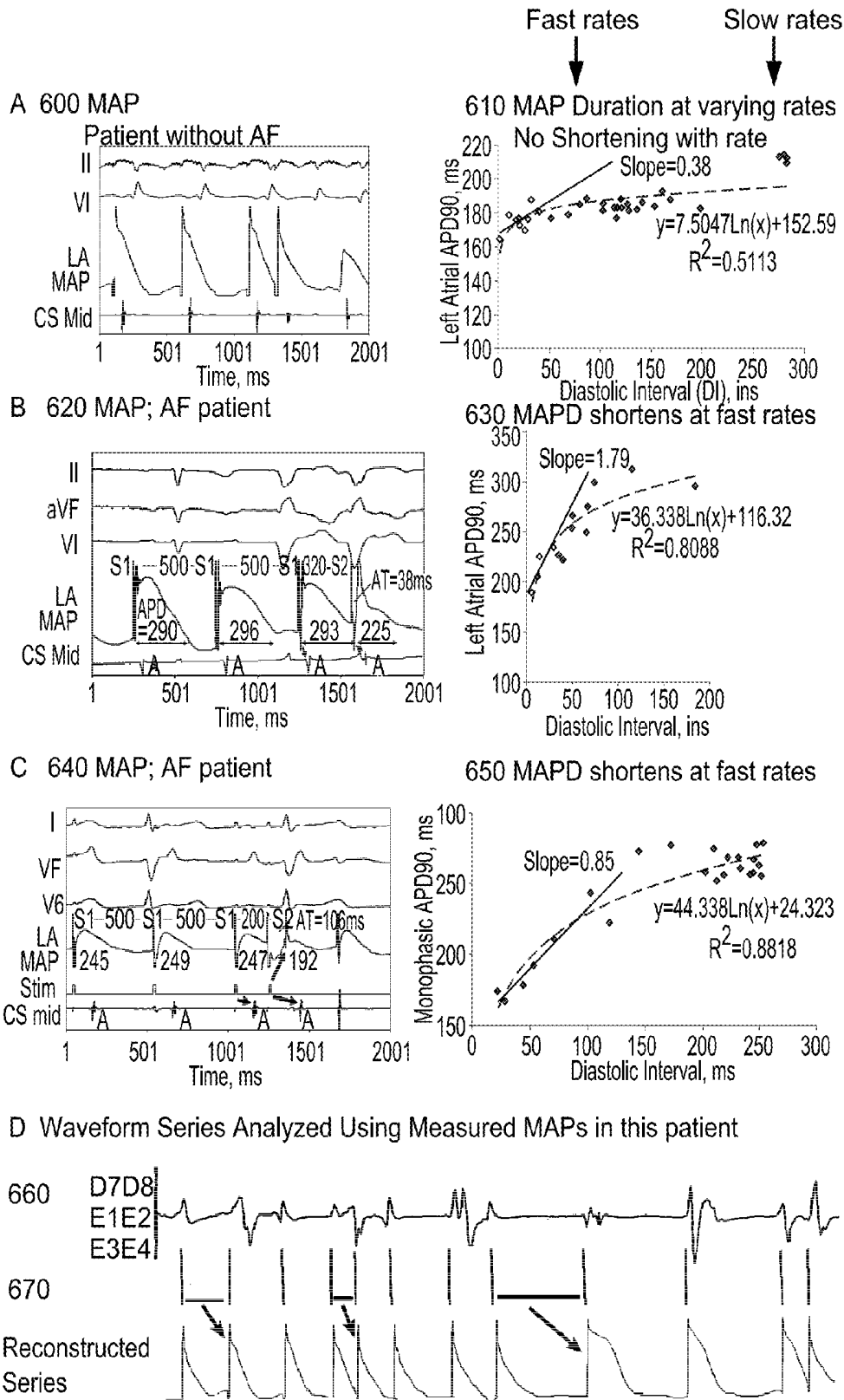

FIG. 7

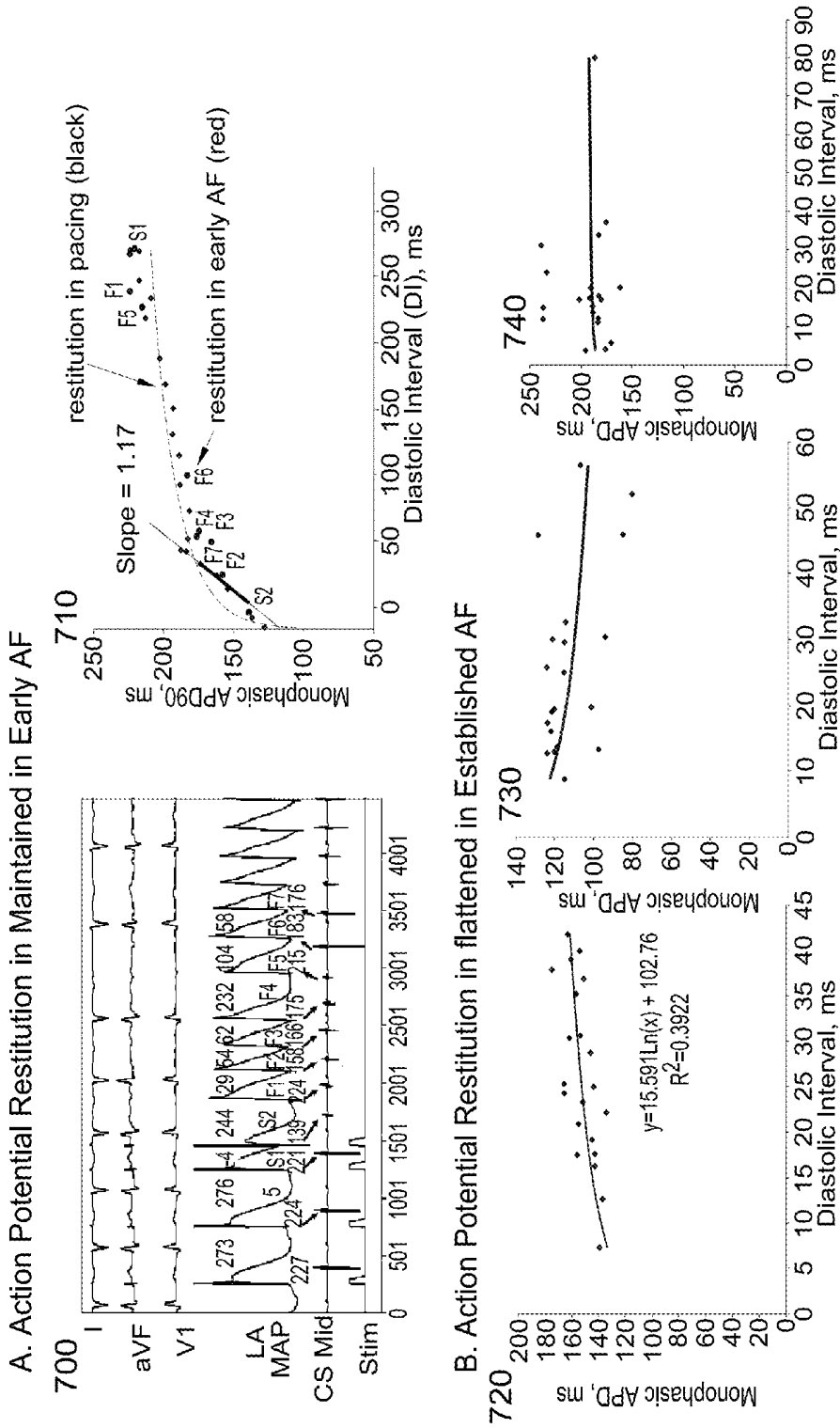

FIG. 8

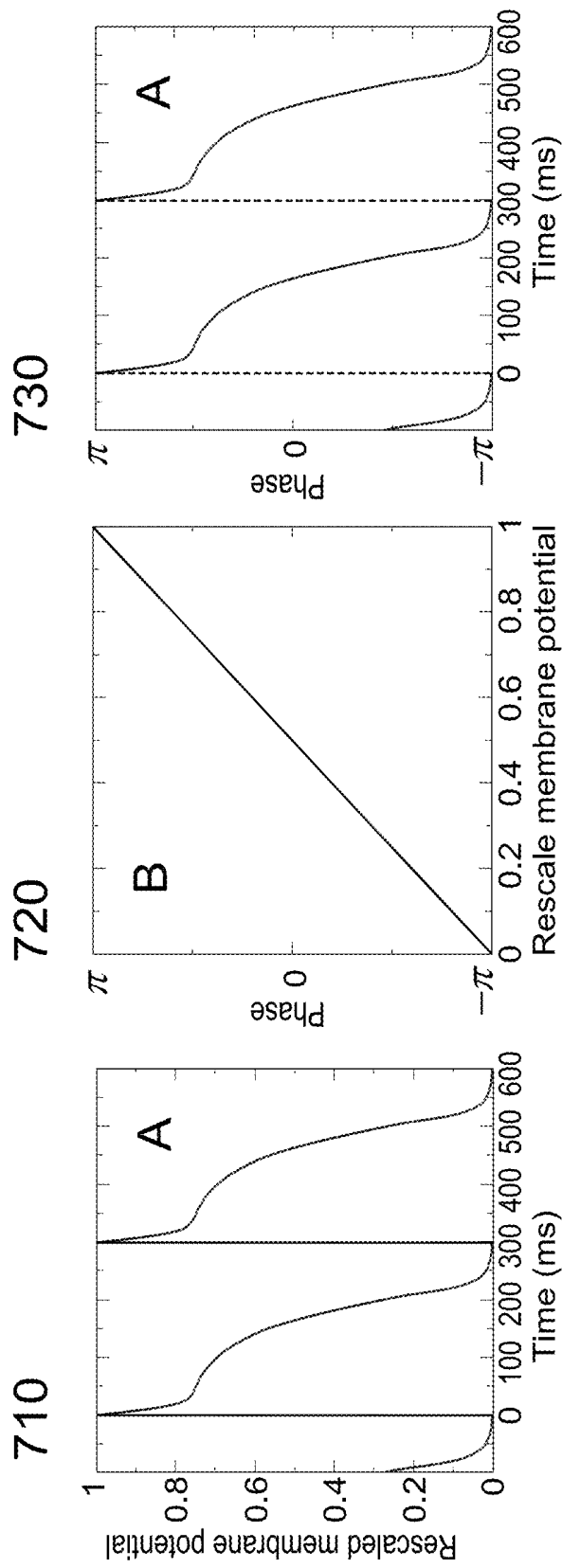

FIG. 9

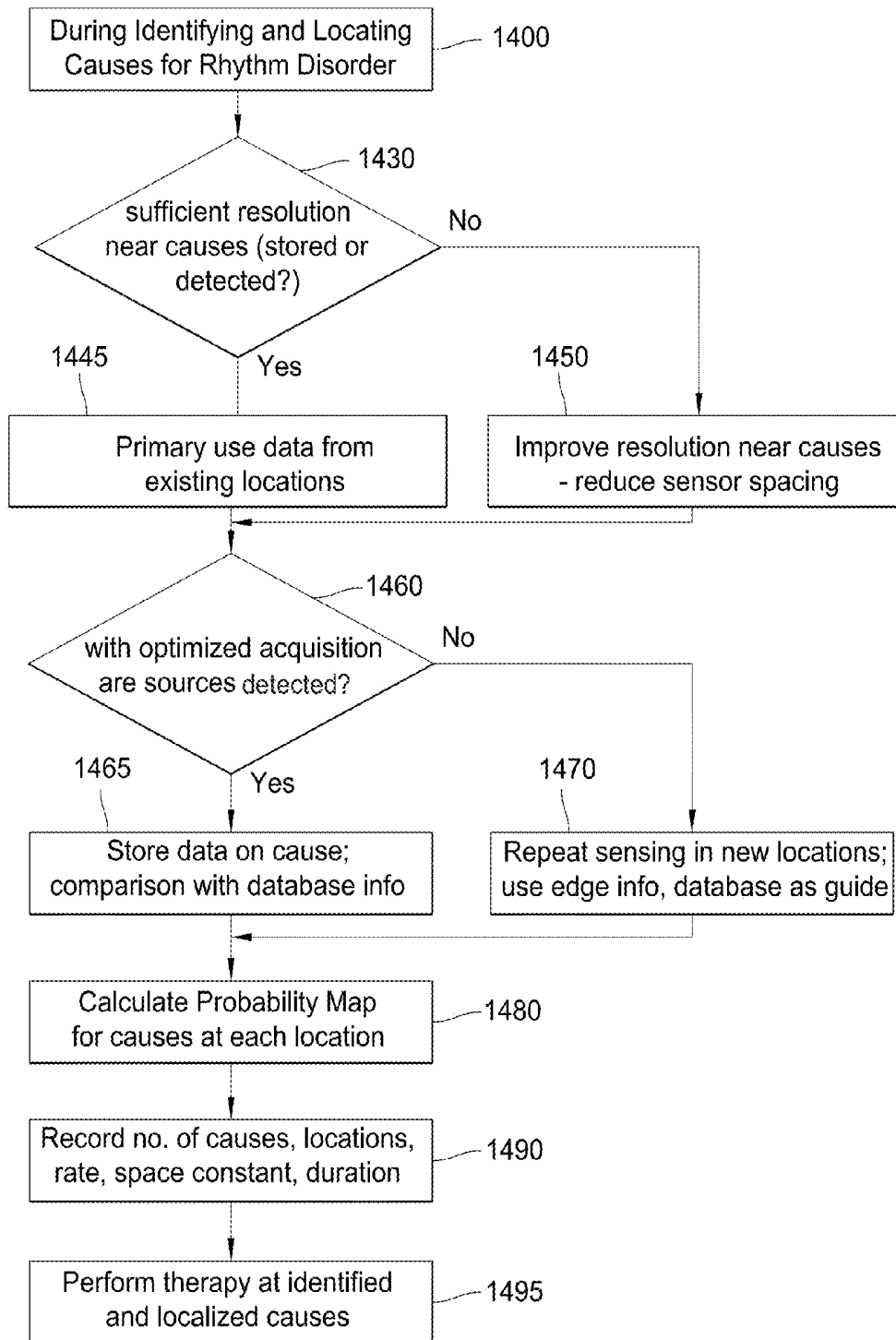

FIG. 10

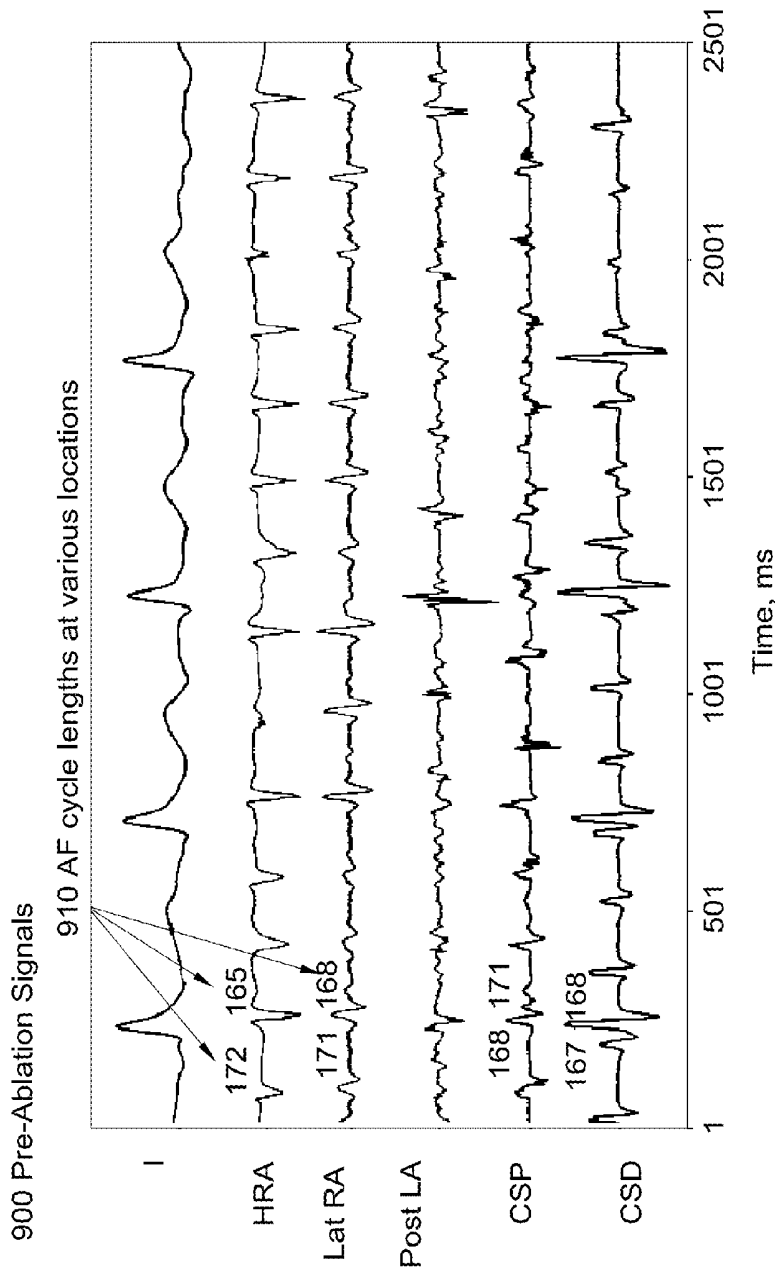

FIG. 11

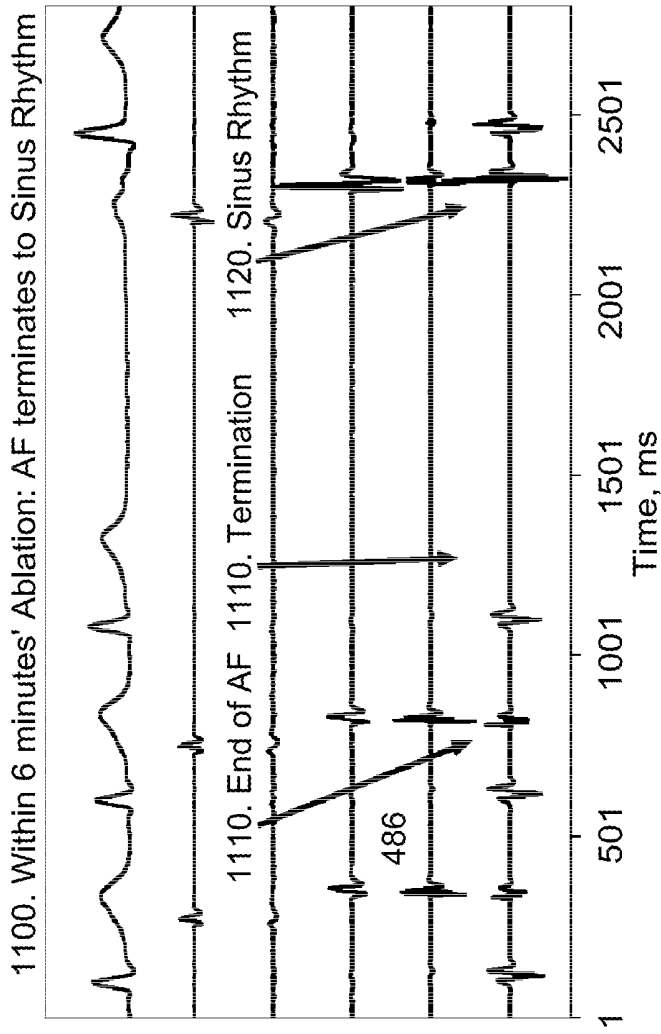

FIG. 13

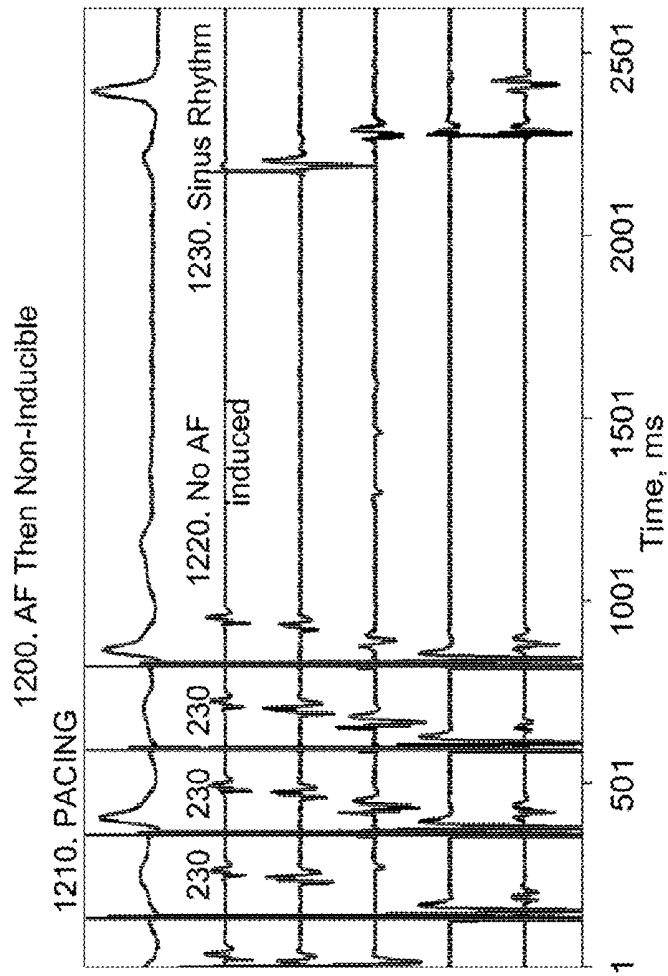
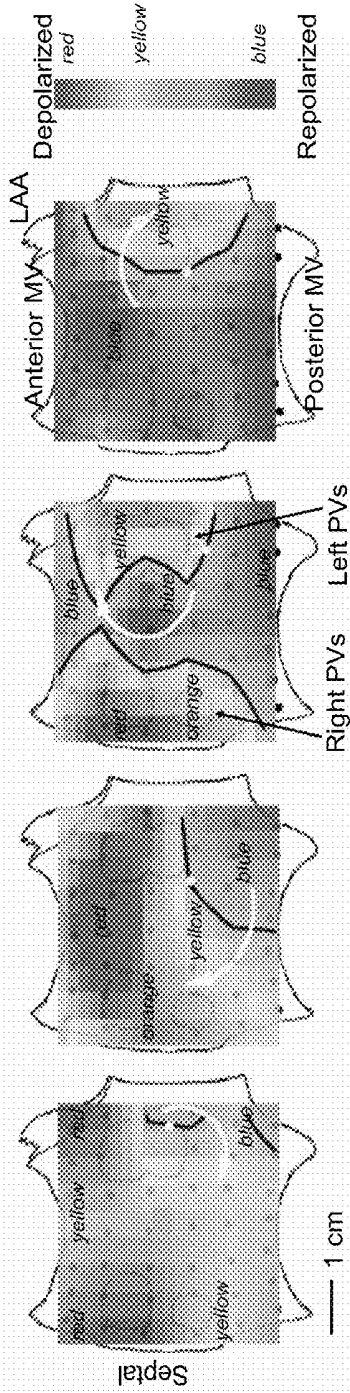

FIG. 14

900. Reentrant Rotor During Paroxysmal AF, Computed Using Hilbert Transform
Left Inferior PV Rotor (CL 180 ms) in Patient with Paroxysmal AF



910. Reentrant Rotor During Persistent AF, Computed Using Hilbert Transform
Posterior Wall Rotor (CL 140 ms) in Patient with Persistent AF

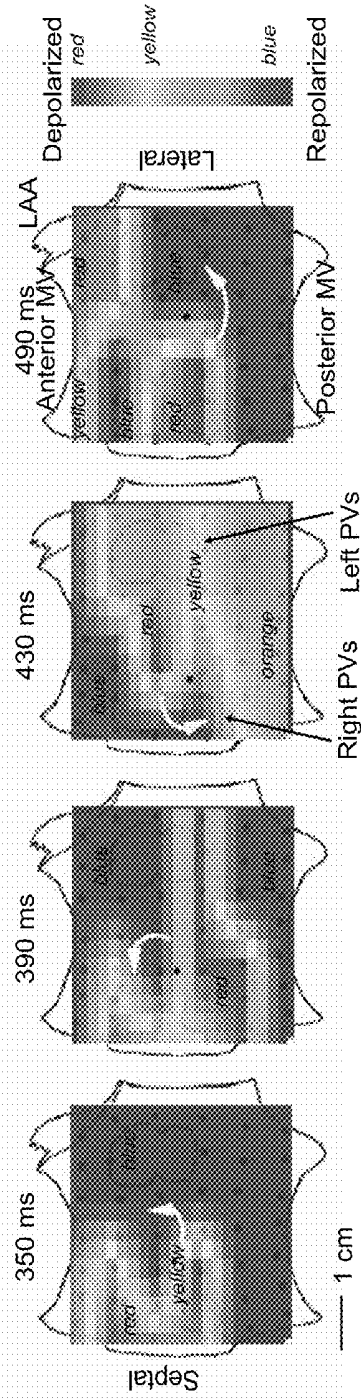

FIG. 15

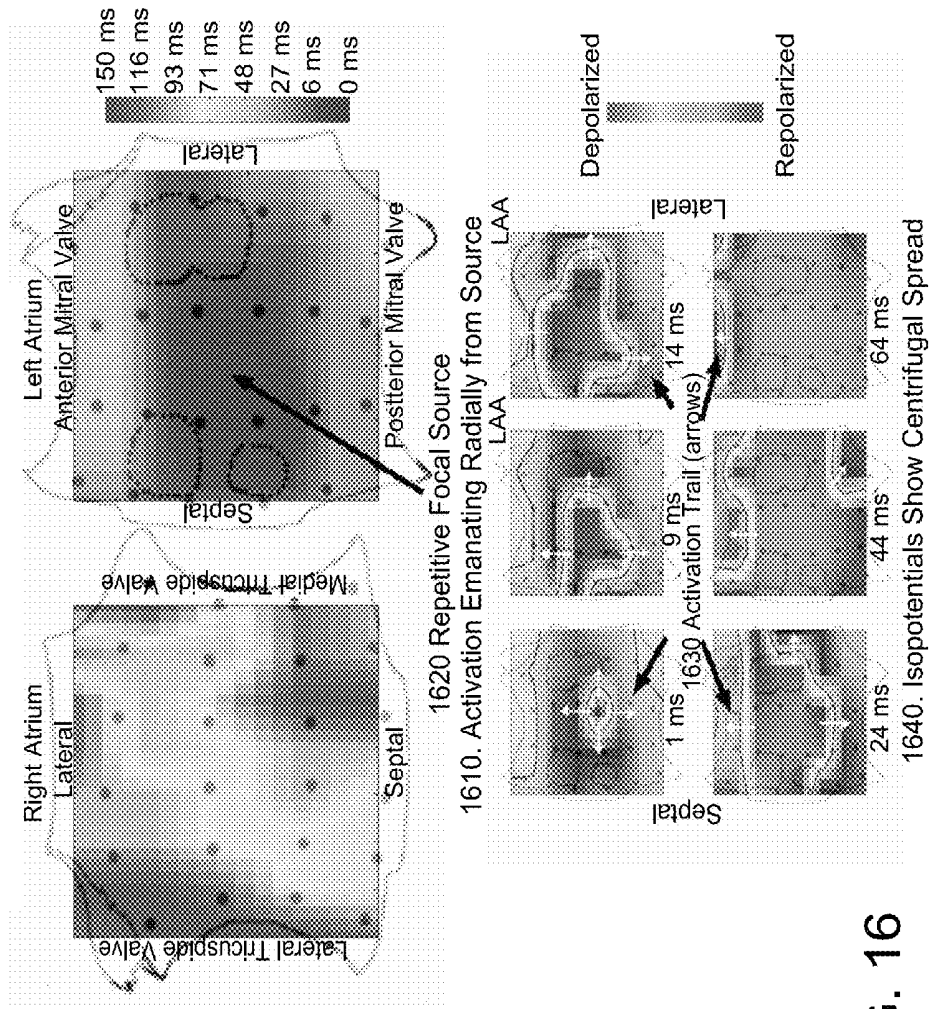

FIG. 16

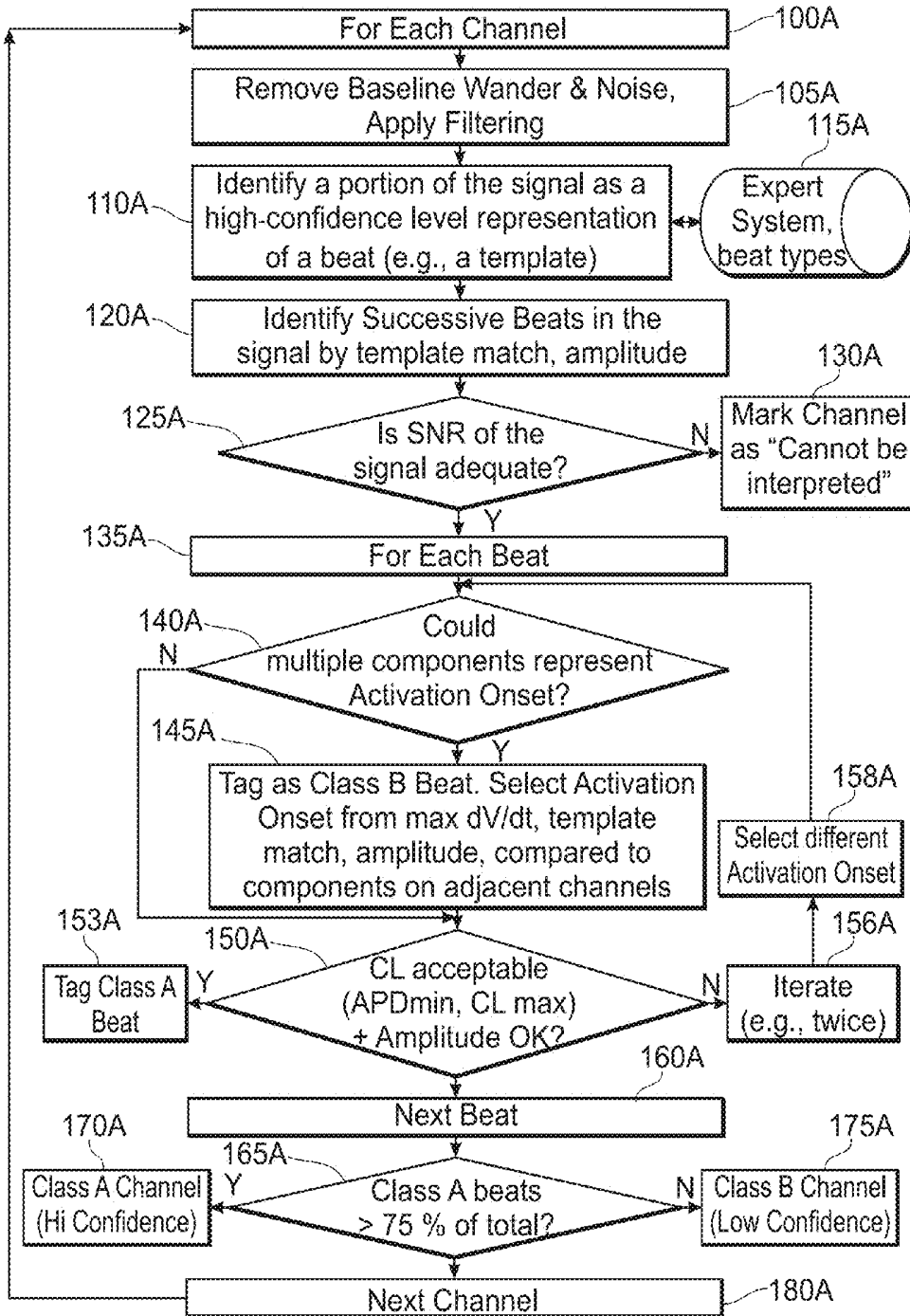

FIG. 17A

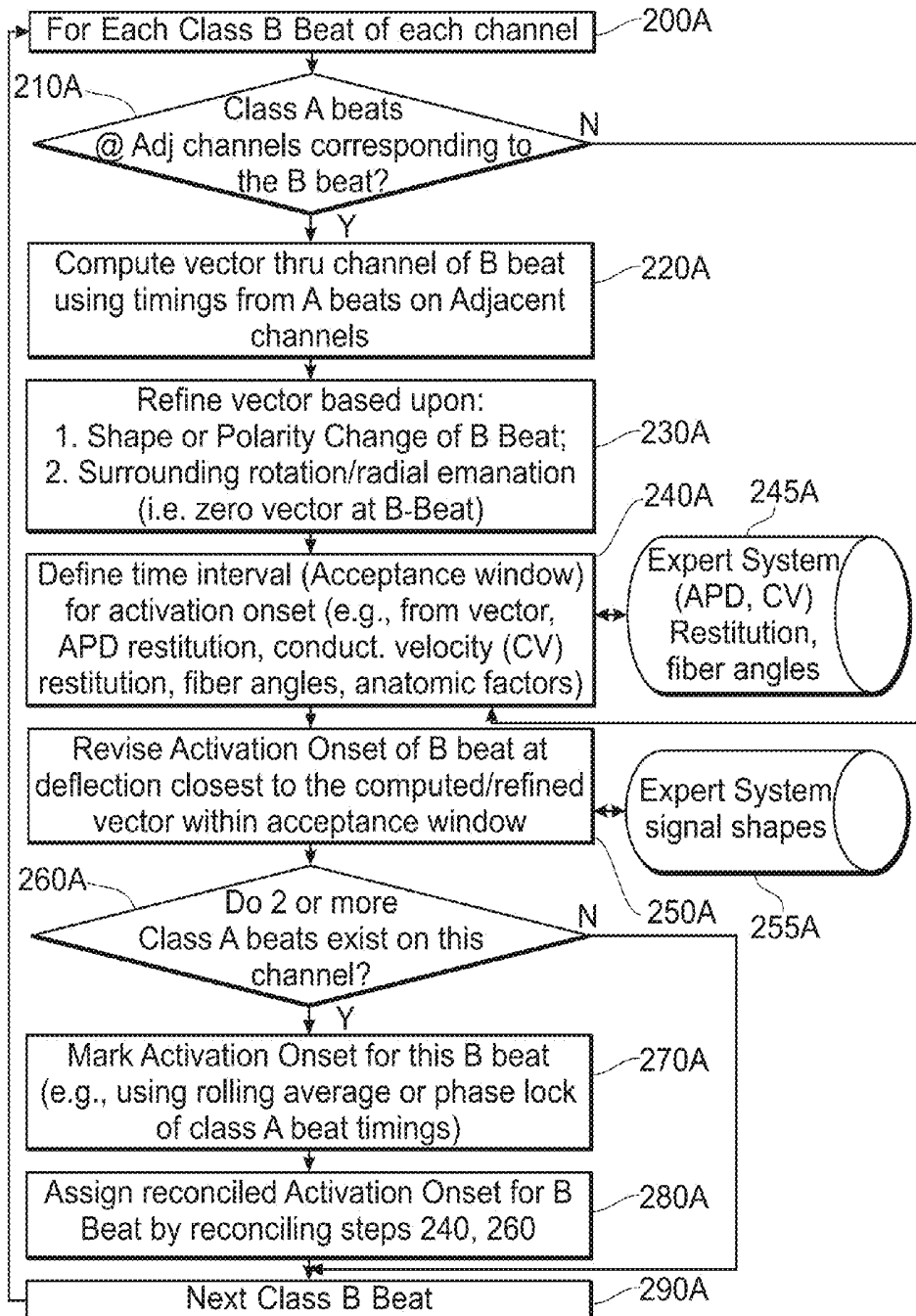

FIG. 17B

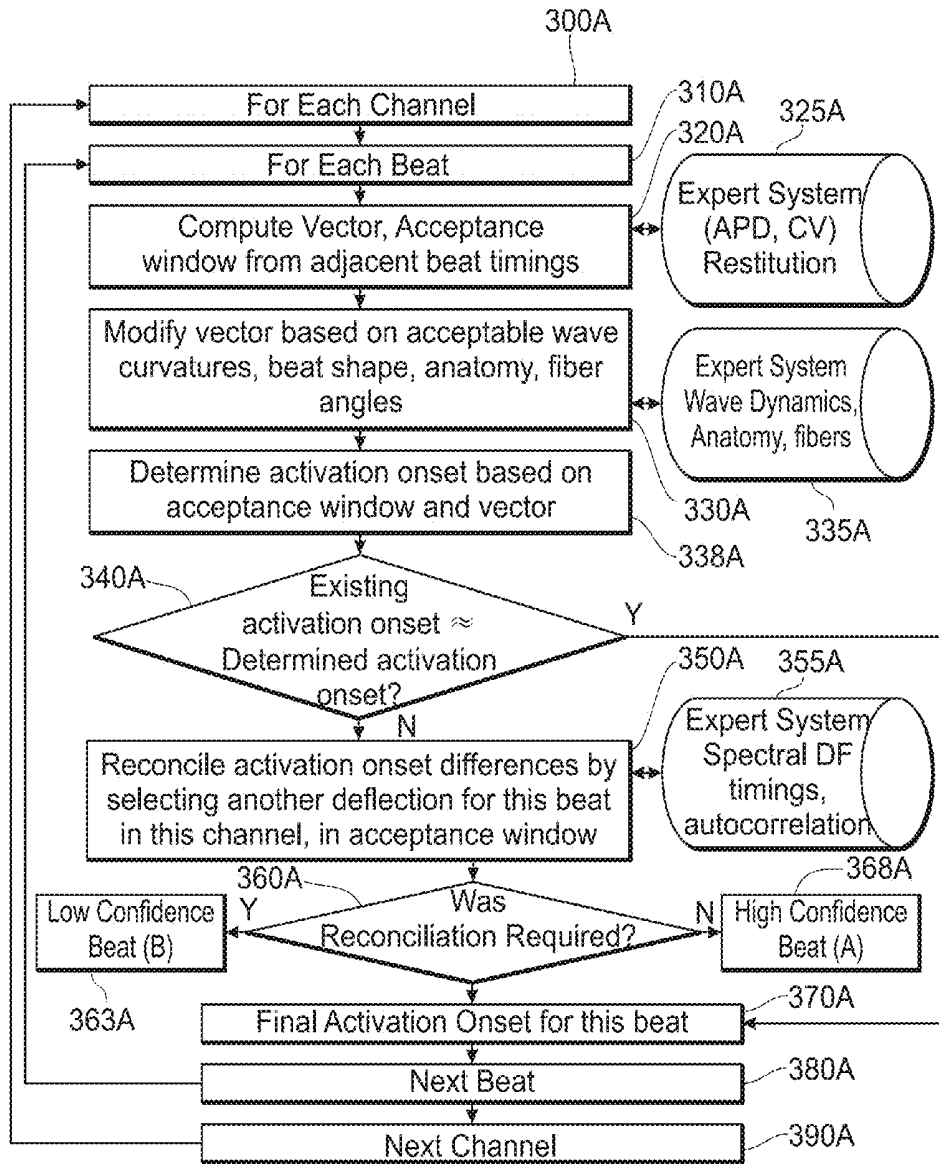

FIG. 17C

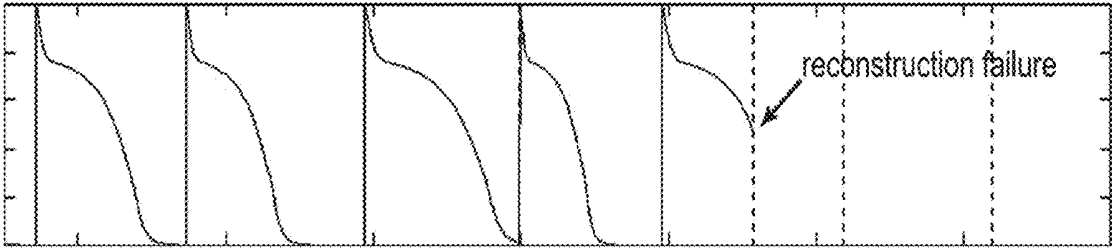

FIG. 18

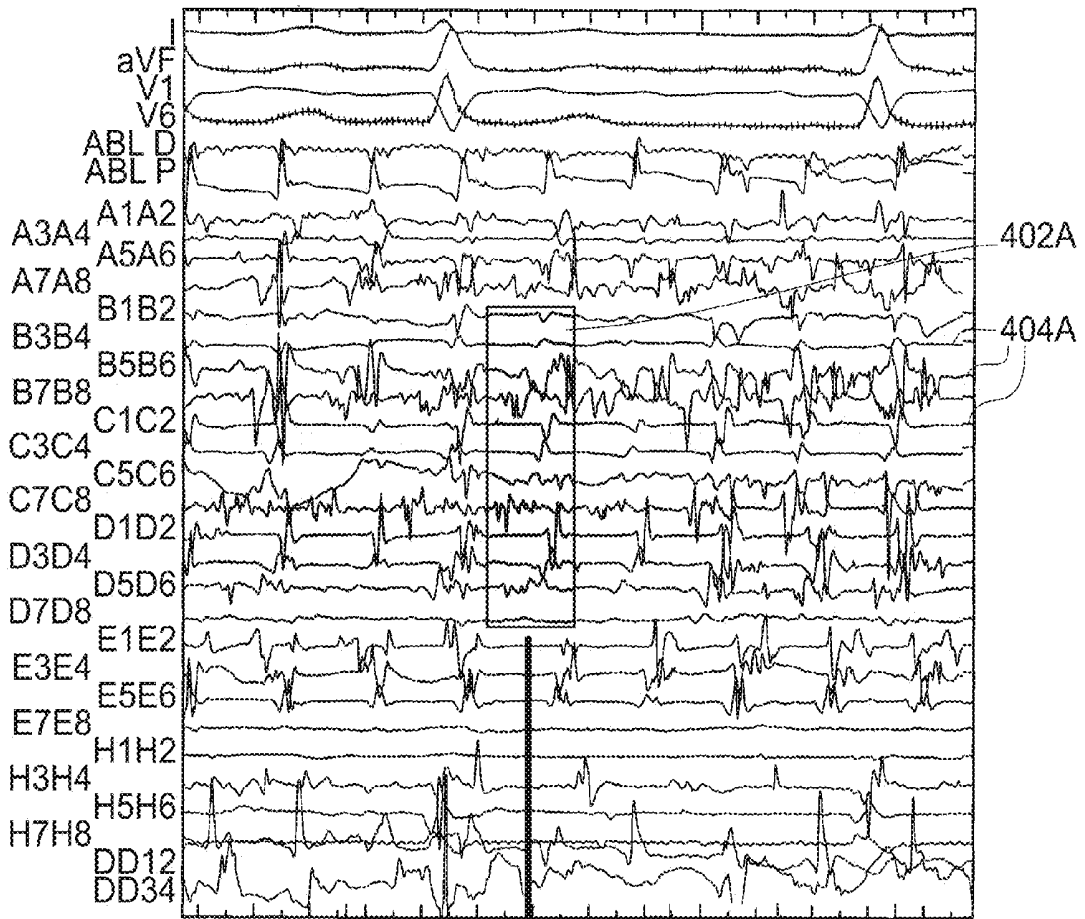

FIG. 19A

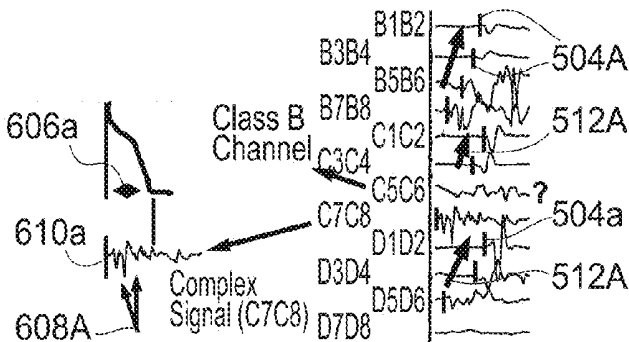

FIG. 19C

FIG. 19B

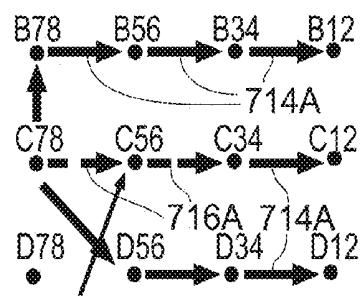

FIG. 19D

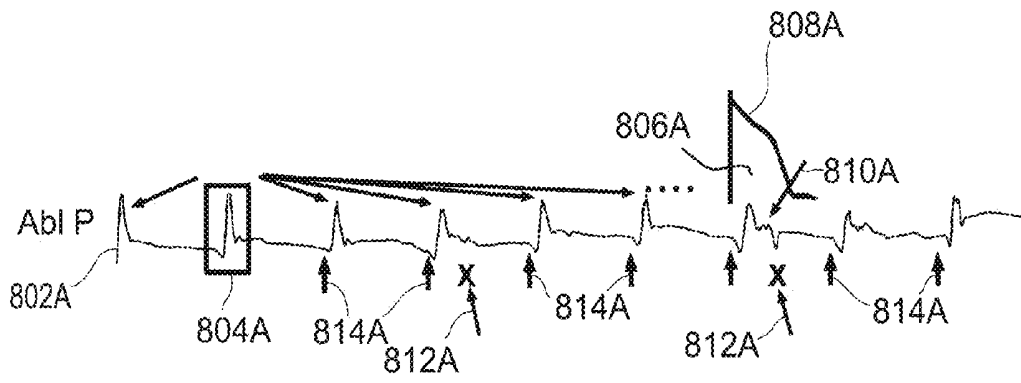

FIG. 20A

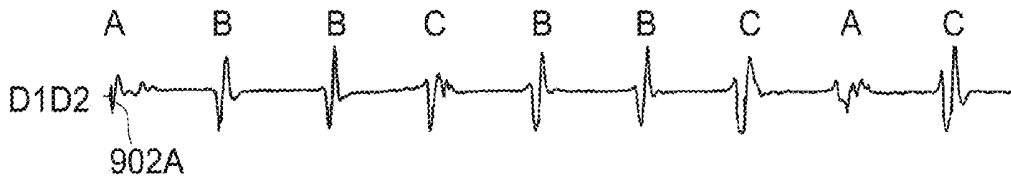

FIG. 20B

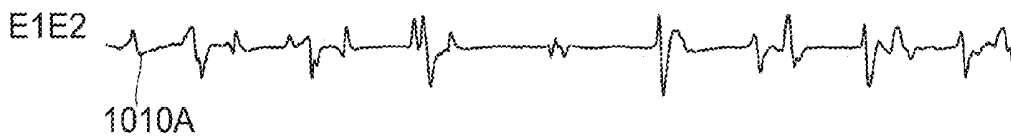

FIG. 20C

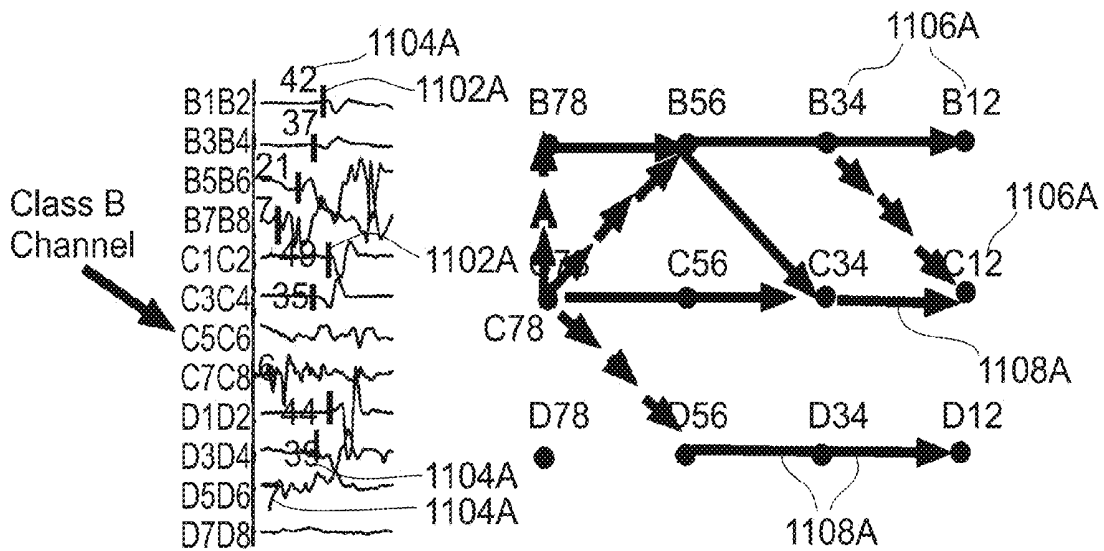

FIG. 21A

FIG. 21B

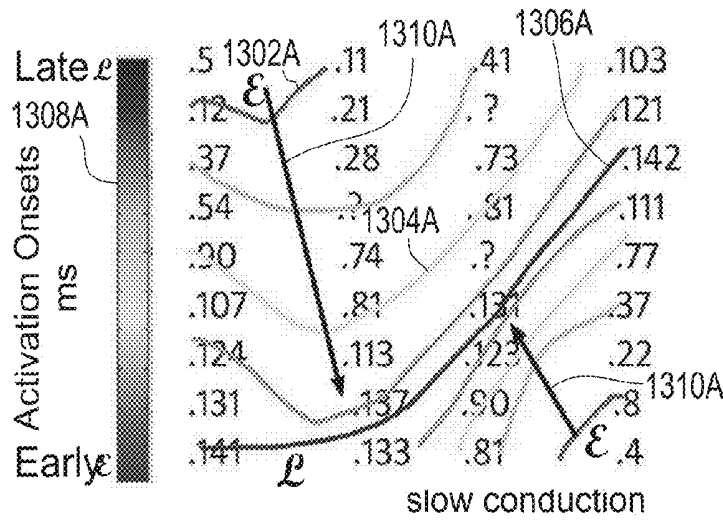

FIG. 22A

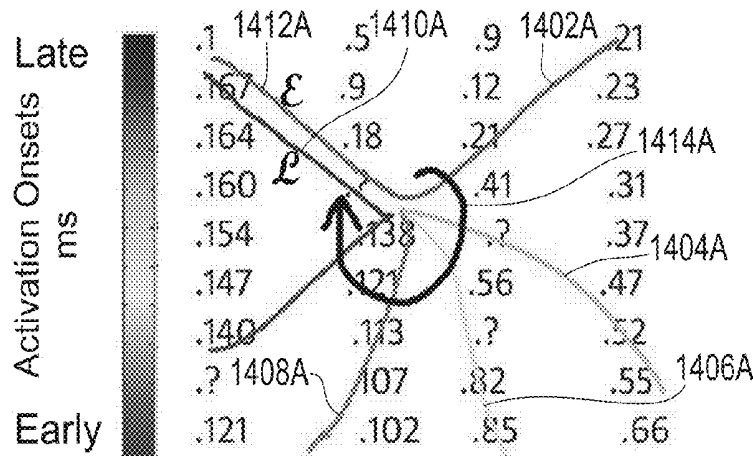

FIG. 22B

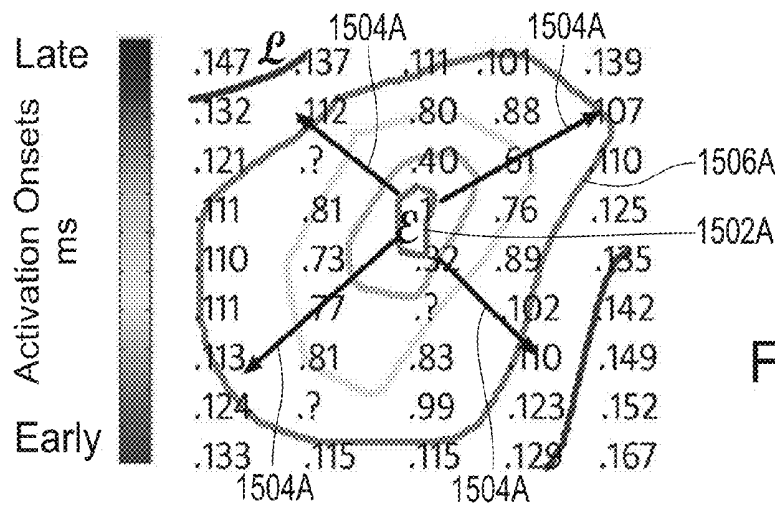

FIG. 22C

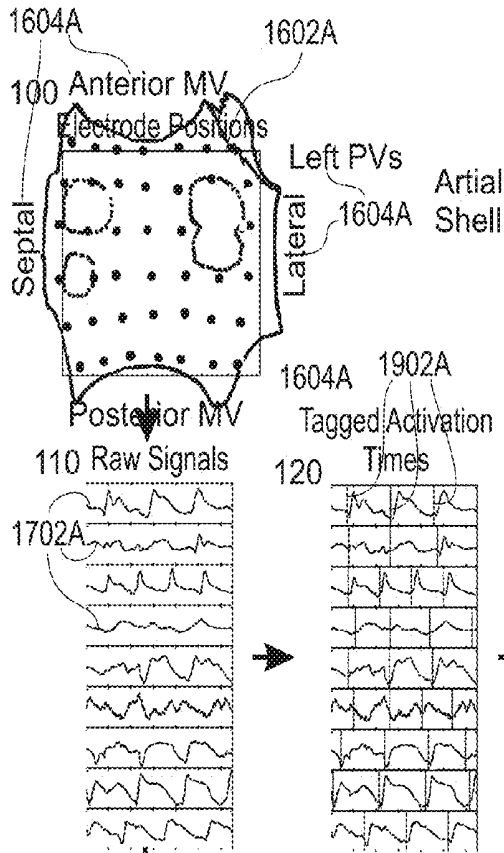

FIG. 23A

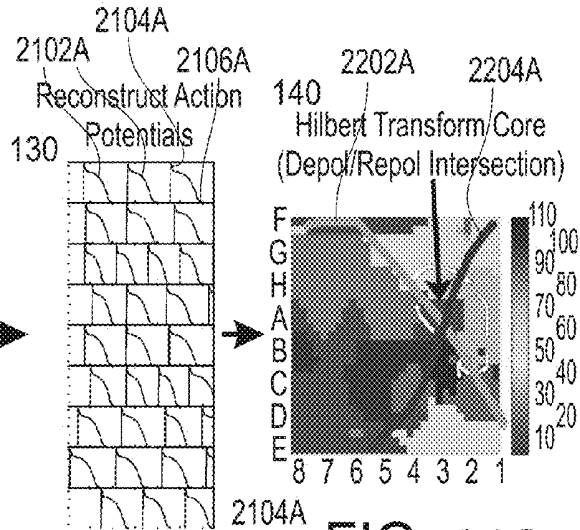

FIG. 24C

FIG. 23B

FIG. 23C

FIG. 23D

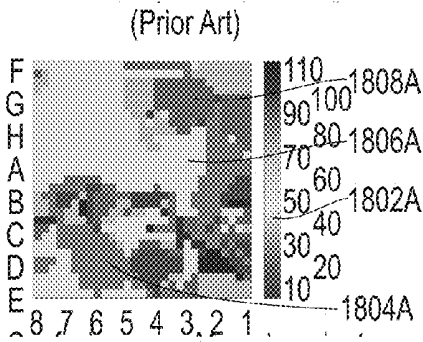

FIG. 24A

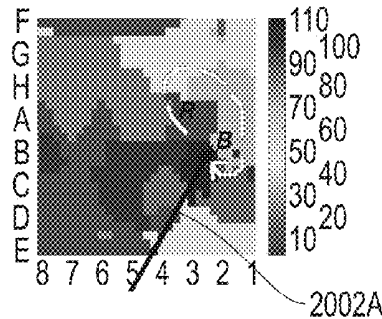

FIG. 24B

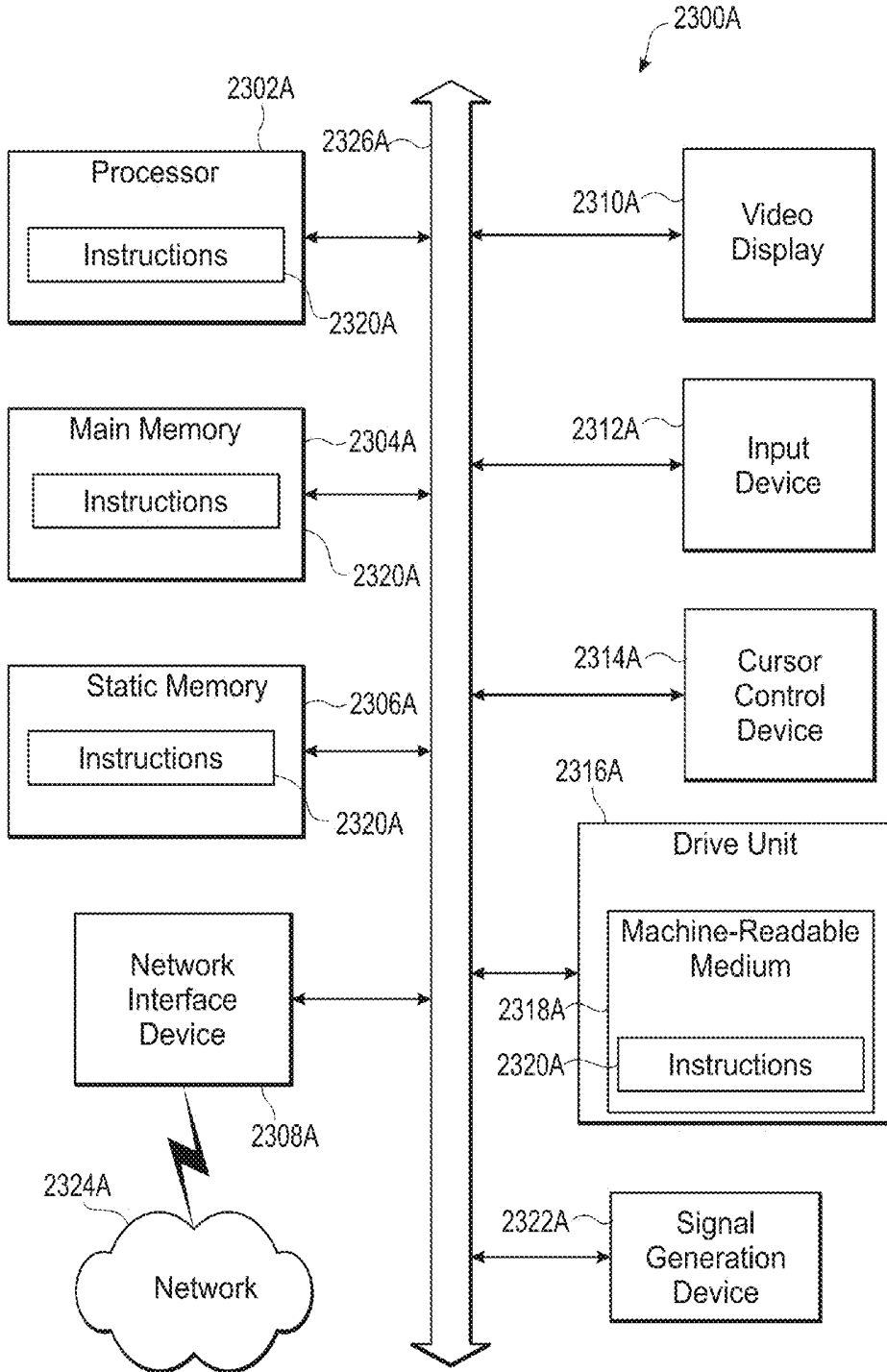

FIG. 25

METHOD AND SYSTEM FOR DETECTION OF BIOLOGICAL RHYTHM DISORDERS

RELATED APPLICATIONS

This application is a continuation of application Ser. No. 13/081,411, filed Apr. 6, 2011, now issued as U.S. Pat. No. 8,700,140, which claims priority to Provisional Application No. 61/342,016, filed Apr. 8, 2010, which is incorporated herein by reference in its entirety.

GOVERNMENT RIGHTS

This invention was made with government support under Grants R01 HL83359 and HL83359-S1 awarded by the National Institutes of Health. The government has certain rights in the invention.

BACKGROUND

1. Field

This invention relates generally to the field of medicine and more specifically to a method, system and machine for diagnosing, finding the source for and treating irregularities and other disorders of biological rhythms. In particular, the present invention can be applied to minimally invasive techniques or surgical techniques to detect, diagnose and treat the disorder. One embodiment directs this invention to disorders of heart rhythm, another to electrical disorders of the brain and nervous system and others to electrical or contractile disorders of the smooth muscle of the gastrointestinal and genitourinary systems.

2. Brief Description of the Related Art

Heart rhythm disorders are very common in the United States, and are significant causes of morbidity, lost days from work, and death. Heart rhythm disorders exist in many forms, of which the most complex and difficult to treat are atrial fibrillation (AF), ventricular tachycardia (VT) and ventricular fibrillation (VF). Other rhythms are more simple to treat, but may also be clinically significant including atrial tachycardia (AT), supraventricular tachycardia (SVT), atrial flutter (AFL), premature atrial complexes/beats (SVE) and premature ventricular complexes/beats (PVC). Under certain conditions, rapid activation of the normal sinus node can cause the heart rhythm disorder of inappropriate sinus tachycardia or sinus node reentry.

Treatment of heart rhythm disorders, particularly the complex ones of AF, VF and VT, can be very difficult. Pharmacologic therapy is particularly suboptimal for AF (Singh, Singh et al. 2005) and VT or VF (Bardy, Lee et al. 2005) and, as a result, there is considerable interest in non-pharmacologic therapy. Ablation is a promising and increasingly used therapy to eliminate heart rhythm disorders by maneuvering a sensor/probe to the heart through the blood vessels, or directly at surgery, then delivering energy to the cause(s) for the heart rhythm disorder to terminate it. Ablation was initially used for 'simple' disorders such as SVT, AFL, PVC, PAC, but is increasingly used for AF (Cappato, Calkins et al. 2005), VT (Reddy, Reynolds et al. 2007) and, to a lesser extent, VF (Knecht, Sacher et al. 2009).

However, ablation is often difficult because tools to identify and locate the cause of the heart rhythm disorder are poor, hindering attempts to deliver energy to the correct region to terminate and eliminate the disorder. In persistent AF, a highly prevalent form of AF, ablation has a one procedure success rate of only 50-60% (Cheema, Vasamreddy et al. 2006; Calkins, Brugada et al. 2007) despite lengthy 4-5 hour

procedures and a 5-10% rate of serious complications (Ellis, Culler et al. 2009) including death (Cappato, Calkins et al. 2009). Even for 'simple' disorders such as atrial tachycardia, tools do not exist to make the diagnosis and suggest a likely successful ablation location.

Even the most sophisticated known systems display data that the practitioner has to interpret, without directly identifying and locating the cause of the disorder to enable the practitioner to detect, diagnose and treat it. This includes currently used methods, described in U.S. Pat. No. 5,662,108, U.S. Pat. No. 5,662,108, U.S. Pat. No. 6,978,168, U.S. Pat. No. 7,289,843 and others by Beatty and coworkers, U.S. Pat. No. 7,263,397 by Hauck and Schultz, U.S. Pat. No. 7,043,292 by Tarjan and coworkers, U.S. Pat. No. 6,892,091 and other patents by Ben-Haim and coworkers and U.S. Pat. No. 6,920,350 by Xue and coworkers. These methods and instruments detect, analyze and display electrical potentials, often in sophisticated 3-dimensional anatomic representations, but still fail to identify and locate the cause of heart rhythm disorders, particularly for complex disorders such as AF. This is also true for patents by Rudy and coworkers (U.S. Pat. Nos. 6,975,900 and 7,016,719, among others) that use signals from the body surface to 'project' potentials on the heart.

Certain known methods for identifying and locating causes for heart rhythm disorders may work in simple rhythm disorders, but there are no known methods that have been successful with respect to identifying causes for complex disorders such as AF, VF or polymorphic VT. Activation mapping (tracing activation back to the earliest site) is useful only for simple tachycardias, works poorly for AFL (a continuous rhythm without a clear 'start'), and not at all for AF with variable activation paths. Entrainment mapping uses pacing to identify sites where the stimulating electrode is at the cause of a rhythm, yet pacing cannot be applied in AF and even some 'simple' rhythms such as atrial tachycardias due to automatic mechanisms. Stereotypical locations are known for the cause(s) of atrioventricular node reentry, typical AFL and patients with early (paroxysmal) AF, but not for the vast majority of patients with persistent AF (Calkins, Brugada et al. 2007), VF and other complex disorders. Thus, no methods yet exist to identify and locate the cause of complex heart rhythm disorders such as AF (Calkins, Brugada et al. 2007).

As an example of systems for 'simple' rhythms with consistent activation from beat to beat is given by U.S. Pat. No. 5,172,699 by Svenson and King. This system is based upon finding diastolic intervals, which can be defined in 'simple rhythms' but no complex rhythms such as atrial fibrillation (AF) or ventricular fibrillation (VF) (Calkins, Brugada et al. 2007; Waldo and Feld 2008). Moreover, this system does not identify or locate a cause, since it examines diastolic intervals (between activations) rather than activation itself. In addition, it is focused on ventricular tachycardia rather than AF or VF, since it analyzes periods of time between QRS complexes on the ECG.

Another example is U.S. Pat. No. 6,236,883 by Ciaccio and Wit. This invention uses a concentric array of electrodes to identify and localize reentrant circuits. Accordingly, this will not find non-reentrant causes such as focal beats. Moreover, this method of using feature and detection localization algorithms will not work for complex rhythms such as AF and VF, where activation within the heart changes from beat to beat. It identifies 'slow conduction within an isthmus of the reentry circuit', that are features of 'simple' arrhythmias such as ventricular tachycardia, but are not defined for AF and VF.

In a subsequent U.S. Pat. No. 6,847,839, Ciaccio and coworkers describe an invention to identify and localize a reentry circuit in normal (sinus) rhythm. Again, this will not

find causes for an arrhythmia that are not reentrant but focal, from where activation emanates radially. Second, this patent is based on the presence in sinus rhythm of an “isthmus” for reentry, which is accepted for ‘simple’ rhythms with consistent activation between beats such as VT (see (Reddy, Reynolds et al. 2007)). However, this is not accepted for complex rhythms with varying activation paths such as AF or VF.

U.S. Pat. No. 6,522,905 by Desai is an invention that uses the principle of finding the earliest site of activation, and determining this to be the cause of an arrhythmia. This approach will not work for simple arrhythmias due to reentry, in which there is no “earliest” site in reentry because activation is a continuous ‘circle’. This approach will also not work for complex arrhythmias in which activation varies from beat to beat, such as AF or VF.

However, even in simple heart rhythm disorders, it is often difficult to apply known methods to identify causes. For instance, ablation success for atrial tachycardias (a ‘simple’ disorder) may be as low as 70%. When surgeons perform heart rhythm disorder procedures (Cox 2004; Abreu Filho, 2005) it is ideal for them to be assisted by an expert in heart rhythm disorders (cardiac electrophysiologist). Thus, ablating the cause of a heart rhythm disorder can be challenging, and even experienced practitioners may require hours to ablate certain ‘simple’ rhythm disorders (with consistent beat-to-beat activation patterns) such as atrial tachycardia or atypical (left atrial) AFL. The situation is more difficult still for complex heart rhythm disorders such as AF and VF where activation sequences alter from beat-to-beat.

The prior art for diagnosing rhythm disturbances often measures times of activation at a sensor. However, such prior art has been applied to signals that, at each recording site, are quite consistent from beat to beat in shape and often timing. These prior art solutions are extremely difficult to apply to complex rhythms such as AF or VF where signals for each beat at any site (‘cycle’) may transition between one, several, and multiple deflections over a short period of time. When a signal, for instance in AF, comprises 5, 7, 11 or more deflections, it is difficult to identify which deflections is at the sensor (‘local’) versus a nearby site (‘far-field’), as noted in studies to analyze AF rate (Ng and coworkers, Heart Rhythm 2006). In another recent report, signals in rhythms, such as AF, require ‘interactive methods’ to identify local from far-field activations (Elvan et al. Circulation: Arrhythmias and Electrophysiology 2010).

In the absence of methods to identify and locate causes for human AF, physicians have often turned to the animal literature. In animal models, localized causes for complex and irregular AF (induced by artificial means) have been identified and located in the form of localized ‘electrical rotors’ or repetitive focal beats (Skanes, Mandapati et al. 1998; Warren, Guha et al. 2003). In animals, rotors are indicated by signals that show a high spectral dominant frequency (DF) (a fast rate) and a narrow DF (indicating regularity) (Kalifa, Tanaka et al. 2006). Such uses of spectral dominant frequencies are described in U.S. Pat. No. 7,117,030 issued to Berenfeld and coworkers.

Unfortunately, these animal data have not translated into effective human therapy. Animal models of AF and VF likely differ from human disease. For instance, animal AF is rarely spontaneous, it rarely initiates from pulmonary vein triggers (that are common in human paroxysmal AF). Both AF and VF are typically studied in young animals without the multiple co-existing pathology (Wijffels, Kirchhof et al. 1995; Gaspo, Bosch et al. 1997; Allesie, Ausma et al. 2002) seen in older humans who typically experience these conditions.

In AF patients, sites where rate is high (or, sites of high spectral dominant frequency, DF) have not been useful targets for ablation. A recent study by Sanders and coworkers showed that AF rarely terminated with ablation at sites of high DF (Sanders, Berenfeld et al. 2005a). Other studies show that sites of high DF are common in the atrium, and ablation at these sites does not acutely terminate AF (as would be expected if high DF sites were causes) (Calkins, Brugada et al. 2007). In part, this may be because the DF method that is effective in animals may be inaccurate in human AF for many reasons, as shown by many workers (Ng, Kadish et al. 2006; Narayan, Krummen et al. 2006d; Ng, Kadish et al. 2007). Nademanee and coworkers have suggested that signals of low amplitude with high-frequency components (complex fractionated atrial electrograms, CFAE) may indicate AF causes (Nademanee, McKenzie et al. 2004a). This diagnostic method has been incorporated into commercial systems by Johnson and Johnson/Biosense. However, this method has also been questioned. Oral and coworkers showed that ablation of CFAE does not terminate AF or prevent AF recurrence alone (Oral, Chugh et al. 2007) or when added to existing ablation (Oral, Chugh et al. 2009).

Several inventions in the prior art acknowledge what was felt true until now—that AF is a “cardiac arrhythmia with no detectable anatomical targets, i.e., no fixed aberrant pathways,” such as U.S. Pat. No. 5,718,241 by Ben-Haim and Zachman. This patent, as a result, does not identify and locate the cause for a heart rhythm disorder. Instead, it focuses treatment on heart geometry by delivering lines of ablation to “interrupt each possible geometric shape.” This patent creates maps of various parameters of the heart.

Many inventions use surrogates for the actual cause for a cardiac arrhythmia, without identifying and locating said cause. For instance, U.S. Pat. No. 5,868,680 by Steiner and Lesh uses measures of organization within the heart, that are constructed by comparing the activation sequence for one activation event (beat) to the activation sequence for subsequent beats, to determine if “any spatiotemporal order change has occurred”. However, that invention assumes that organization is greatest near a critical site for AF and is lower at other sites. However, this assumption may not be correct. In animal studies, indexes of organization fall with distance from an AF source, then actually increase again as activation re-organizes at more distant sites (Kalifa, Tanaka et al. 2006). Moreover, U.S. Pat. No. 5,868,680 requires more than one beat. As a result, methods such as U.S. Pat. No. 5,868,680 identify many sites, most of which most are not causes of AF. This lack of identifying and locating a cause for AF may explain why methods based on organization have not yet translated into improved treatment to acutely terminate AF. Similarly, U.S. Pat. No. 6,301,496 by Reisfeld is based on the surrogate of mapping physiologic properties created from a local activation time and vector function. This is used to map conduction velocity, or another gradient function of a physiologic property, on a physical image of the heart. However, this patent does not identify or locate a cause of a heart rhythm disorder. For instance, multiple activation paths in AF mean that the conduction path and thus conduction velocity is not known between the points used for triangulation. In addition, in the case of a rotor, activation sequences revolving around, or emanating symmetrically from, a core region may actually produce a net velocity of zero.

For these reasons, experts have stated that “no direct evidence of electrical rotors has been obtained in the human atria” in AF (Vaquero, Calvo et al. 2008). Thus, while it would be desirable to identify (and then locate) localized causes for human AF, this is not currently possible.

For human AF, particularly persistent AF, the absence of identified and located causes means that ablation is empiric and often involves damage to approximately 30-40% of the atrium that could theoretically be avoided if the cause(s) were identified and located for minimally invasive ablation and/or surgical therapy (Cox 2005).

Human VT or VF are significant causes of death that are poorly treated by medications (Myerburg and Castellanos 2006). Treatment currently involves placing an implantable cardioverter defibrillator (ICD) in patients at risk, yet there is increasing interest in using ablation to prevent repeated ICD shocks from VT/VF (Reddy, Reynolds et al. 2007). Identifying and locating causes for VT may be difficult and ablation is performed at specialized centers. In VF, animal data suggest that causes of VF lie at fixed regions near His-Purkinje tissue (Tabereaux, Walcott et al. 2007), but again this is very poorly understood in humans. The only prior descriptions of identifying and locating causes for VF required surgical exposure (Nash, Mourad et al. 2006) or were performed in hearts removed from the body after heart transplant (Masse, Downar et al. 2007)). Thus, minimally invasive ablation for VF focuses on identifying its triggers in rare cases (Knecht, Sacher et al. 2009) but cannot yet be performed in a wider population.

Existing sensing tools are also suboptimal for identifying and locating cause(s) for complex disorders such as AF, including single or multi-sensor designs exist (such as U.S. Pat. No. 5,848,972 by Triedman et al.). However, such tools typically have a limited field of view that is inadequate to identify causes for AF, that may lie anywhere in either atria and vary (Waldo and Feld 2008). Alternatively, they may require so many amplifiers for wide-area sampling that they are impractical for human use. Wide area sampling is advantageous and, in animals, is achieved by exposing the heart surgically (Ryu, Shroff et al. 2005) or removing it from the body (Skanes, Mandapati et al. 1998; Warren, Guha et al. 2003). In humans, even surgical studies only examine partial regions at any one time (for instance (Sahadevan, Ryu et al. 2004)), and introduce problems by exposing the heart to air, anesthesia and other agents that may alter the rhythm disorder from the form that occurs clinically.

Thus, prior methods have largely focused on mapping of the anatomy to identify whether a patient has a heart disorder, rather than determining the cause or source of the disorder. Thus, there is an urgent need for methods and tools to directly identify and locate causes for heart rhythm disorders in individual patients to enable curative therapy. This is particularly critical for AF and other complex rhythm disorders for which, ideally, a system would detect localized causes for ablation by minimally invasive, surgical or other methods.

SUMMARY

The present invention discloses systems, assemblies and methods to facilitate reconstruction of cardiac information representing a complex rhythm disorder associated with patient's heart to indicate a source of the heart rhythm disorder. The complex rhythm disorder can be treated by application of energy to modify the source of the rhythm disorder.

This invention is a significant advance over the prior art. For example, unlike U.S. Pat. No. 5,718,241, our invention identifies and locates causes (targets) for AF and other rhythm disorders that may stay at approximately the same location within the heart for hours (see our example in a 47 year old man). Unlike U.S. Pat. No. 6,847,839, the present invention is capable of finding sources that transiently appear or may move (they are "functional"), that may explain the variations

in AF. Unlike U.S. Pat. No. 5,868,680, our invention directly identifies and locates cause(s) for a heart rhythm disorder, using as little as one activation event (beat) as shown in our examples. Unlike U.S. Pat. No. 6,301,496, our invention directly identifies and locates electrical rotors, in which activation revolves around a core region, or focal beats with activation radiating radially therefrom.

In one aspect of the invention there is provided a system to reconstruct cardiac information representing a complex rhythm disorder associated with a patient's heart to indicate a source of the complex rhythm disorder, the system including:

at least one computing device configured to:

receive cardiac information signals from the patient's heart during the complex rhythm disorder,

classify the cardiac information signals into high and low confidence signals, wherein the high and low confidence signals are separated by a confidence threshold,

determine activation onsets associated with the low confidence signals within an acceptance window;

order the activation onsets associated with the low confidence signals and activation onsets associated with the high confidence signals; and

output the activation onsets associated with the high and low confidence signals to indicate a source of the complex cardiac rhythm disorder.

In another aspect of the invention there is provided an assembly to facilitate reconstruction of cardiac information representing a complex rhythm disorder associated with a patient's heart to indicate a source of the complex rhythm disorder, the assembly including:

a catheter comprising a plurality of sensors configured to provide cardiac information signals; and

a computer-readable medium operatively couplable to the sensors, the computer-readable medium comprising instructions, which when executed by a computing device, cause the computing device to reconstruct cardiac information representing a complex rhythm disorder associated with a patient's heart to indicate a source of the complex rhythm disorder by:

receiving cardiac information signals from a plurality of sensors during the complex rhythm disorder;

classifying the cardiac information signals into high and low confidence signals, wherein the high and low confidence signals are separated by a confidence threshold;

determining activation onsets associated with the low confidence signals within an acceptance window;

ordering the activation onsets associated with the low confidence signals and activation onsets associated with the high confidence signals; and

outputting the activation onsets associated with the high and low confidence signals to indicate a source of the complex cardiac rhythm disorder.

In yet another aspect of the invention there is included a method of reconstructing cardiac information representing a complex rhythm disorder associated with a patient's heart to indicate a source of the complex rhythm disorder, the method including:

receiving cardiac information signals from a plurality of sensors during the complex rhythm disorder;

classifying, by a computing device, the cardiac information signals into high and low confidence signals, wherein the high and low confidence signals are separated by a confidence threshold;

determining, by the computing device, activation onsets associated with the low confidence signals within an acceptance window;

ordering, by the computing device, the activation onsets associated with the low confidence signals and activation onsets associated with the high confidence signals; and

outputting, by the computing device, the activation onsets associated with the high and low confidence signals to indicate a source of the complex cardiac rhythm disorder.

In another aspect of the invention there is provided a system to reconstruct cardiac signals associated with a complex rhythm disorder received over a plurality of channels from a patient's heart, the system including:

at least one computing device configured to:

identify a plurality of discernable beats on high-confidence channels that are adjacent to a low-confidence channel, the discernable beats on the high-confidence channels corresponding to a non-discernable beat on the low-confidence channel;

compute a vector between at least two activation onsets of the identified discernable beats on the adjacent channels through the non-discernable beat on the low-confidence channel;

define a time interval associated with the non-discernable beat about a region where the wave path crosses the non-discernable beat, the time interval indicating how early the non-discernable beat can activate based on a previous beat on the low-confidence channel that has a selected or determined activation onset and how late the non-discernable beat can terminate based on at least one predetermined property; and

select a possible activation onset during the defined time interval that is closest to the computed wave path for the non-discernable beat

In another aspect of the invention there is provided an assembly to reconstruct cardiac signals associated with a complex rhythm disorder received over a plurality of channels from a patient's heart, the assembly including:

a catheter comprising a plurality of sensors to receive the cardiac signals; and

a computer-readable medium operatively couplable to the sensors, the computer-readable medium comprising instructions, which when executed by a computing device, cause the computing device to:

identify a plurality of discernable beats on high-confidence channels that are adjacent to a low-confidence channel, the discernable beats on the high-confidence channels corresponding to a non-discernable beat on the low-confidence channel;

compute a vector between at least two activation onsets of the identified discernable beats on the adjacent channels through the non-discernable beat on the low-confidence channel;

define a time interval associated with the non-discernable beat about a region where the defined vector crosses the non-discernable beat, the defined time interval indicating how early the non-discernable beat can activate based on a previous beat on the low-confidence channel that has a selected or determined activation onset and how late the non-discernable beat can terminate based on at least one predetermined property; and

select a possible activation onset during the defined time interval that is closest to the computed vector for the non-discernable beat.

In yet another aspect of the invention there is included a method a method of reconstructing cardiac signals associated with a complex rhythm disorder received over a plurality of channels from a patient's heart, the method including:

identifying a plurality of discernable beats on high-confidence channels that are adjacent to a low-confidence channel,

the discernable beats on the high-confidence channels corresponding to a non-discernable beat on the low-confidence channel;

computing a vector between at least two activation onsets of the identified discernable beats on the adjacent channels through the non-discernable beat on the low-confidence channel;

defining a time interval associated with the non-discernable beat about a region where the vector crosses the non-discernable beat, the time interval indicating how early the non-discernable beat can activate based on a previous beat on the low-confidence channel that has a selected or determined activation onset and how late the non-discernable beat can terminate based on at least one predetermined property; and

selecting a possible activation onset during the defined time interval that is closest to the computed vector for the non-discernable beat.

The systems, assemblies and methods are described hereinafter in greater detail.

BRIEF DESCRIPTION OF THE DRAWINGS

The drawings constitute a part of this specification and include exemplary embodiments to the invention, which may be embodied in various forms. It is to be understood that in some instances various aspects of the invention may be shown exaggerated or enlarged to facilitate an understanding of the invention.

FIG. 1 is a depiction of the heart showing the use of sensors, ablation catheter and the electronic processing components of the present invention which processes signals from the heart and orders them in accordance with the invention.

FIG. 2 shows a sensor apparatus design of the present invention that detects biosignals for a wide area of the heart chamber at low resolution, then for a narrower area at higher resolution.

FIG. 3 shows another sensor apparatus design of the present invention that detects biosignals for a wide area of the heart chamber at low resolution, then for a narrower area at higher resolution.

FIG. 4 shows another sensor apparatus design of the present invention that detects biosignals for a wide area of the heart chamber at low resolution, then for a narrower area at higher resolution.

FIG. 5 illustrates some signal types from the heart to be analyzed by the invention, and defines some selected terms including activation onset, activation offset and diastolic interval.

FIG. 6 is a flowchart showing analysis of signals at multiple locations to identify and locate causes for biological rhythm disorders in accordance with the present invention.

FIG. 7 shows an embodiment of the invention depicting computation of rate-behavior (restitution) curves for human signals, with insertion of physiological patterns in some cases.

FIG. 8 shows that rate-response (restitution) of human monophasic action potential duration may differ when measured between paced rhythms and AF.

FIG. 9 shows direct assignment of phase.

FIG. 10 is a flowchart of an embodiment, showing how sensed signals and stored data in a database can be used to create and use a probability map to improve clarity for identifying and localizing causes for a biological rhythm disorder.

FIG. 11 is an example of use of the invention in a 47 year old man. Shown is a selection of signals (electrograms) from within the left and right atria and coronary sinus of a patient with atrial fibrillation presenting for therapy.

FIG. 12 shows the results of using the method and system of the invention, which identified an electrical rotor and located it to the right atrium. The activation trail is seen to revolve around a core region. The core region is also shown in the atrial geometry from this patient as a dark dot in the lateral wall of the right atrium

FIG. 13 shows that, during direct ablation at the core region identified in FIG. 12 for less than 6 minutes, the AF slowed and terminated to normal rhythm (sinus rhythm), thus demonstrating that the cause of the AF had in fact been located and successfully treated.

FIG. 14 shows that, after the AF had been terminated, it was not possible to re-start the AF even by pacing the atria very rapidly (cycle length 230 ms, equivalent to over 260 beats/min). Faster rate pacing was now blocked (did not stimulate the atrium).

FIG. 15 shows other patient examples of localized causes of human AF detected with this invention. Electrical rotors are shown in two patients in the left atrium. To the best of our knowledge, these are the first actual demonstrations of the existence of electrical rotors in human AF.

FIG. 16 shows another example of a localized focal beat cause of AF in a 56 year old patient. The figure shows a focal beat cause in the left atrium where the activation trail shows activation emanating radially therefrom. Ablation at this location also acutely terminated AF.

FIGS. 17A-17C show a method of reconstructing cardiac signals associated with a complex rhythm disorder received over a plurality of channels from a patient's heart.

FIG. 18 shows a series of reconstructed action potentials and a failure of the reconstructed action potentials to conform to a detected activation onset.

FIG. 19A shows a plurality of time-varying signals obtained from sensors receiving cardiac (electrical) activity from a patient's heart during a complex rhythm disorder (atrial fibrillation). The multiple deflections present in many signals, and the varying signal characteristics even at the same sensor location are noted, and make determination of each signal onset challenging.

FIG. 19B shows just that portion of electrical activity within a window shown in FIG. 19A.

FIG. 19C shows an expanded view of a signal, for which a signal detection is excluded because it falls within the rate-adjusted activation potential duration (APD) and thus is taken as an artifact.

FIG. 19D is a two-dimensional representation of cardiac sensor positions or electrodes, which provides a grid on the patient's atrium.

FIG. 20A shows examples of various methods for detecting beats, determining activation onsets, and disregarding noise in the time-varying cardiac signals shown in FIGS. 19A and 19C.

FIG. 20B shows signals from a low-confidence channel.

FIG. 20C shows signals from complex and low-confidence channels, in which the shapes of individual beat signals vary widely from beat to beat and thus the activation onset is very difficult to determine.

FIGS. 21A and 21B provide additional details to those shown in FIGS. 19B and 19D, respectively, to define a method of determining activation onsets for class B-beats using vectors.

FIGS. 22A-22C show displays of the reconstructed wave paths in fibrillation from selected activation onsets according to the methods and systems described herein.

FIG. 23A shows a two-dimensional representation of a matrix of sensors, which are shown as points or electrode positions superimposed on a cardiac atrial surface.

FIG. 23B shows time-varying cardiac signals obtained from nine (9) of the cardiac electrodes or sensors shown in FIG. 23A.

FIG. 23C shows the result of tagging activation onsets for beats in each of the raw signals shown in FIG. 23B in accordance with the systems and methods described herein.

FIG. 23D shows a reconstruction of the activation potential duration (APD), which starts at the activation onsets determined in FIG. 23C and extends for a specified time or decay thereafter.

FIG. 24A shows an example display obtained from the raw signals shown in FIG. 23B using conventional methods known in the art.

FIG. 24B shows an example display derived from the tagging of activation onsets in FIG. 23C, in which a rotor is shown.

FIG. 24C shows a display in which the tagged activation times determined in FIG. 23C and the reconstructed APD's determined in FIG. 23D are used to define the intersection between a depolarization line and a repolarization line. This intersection is the core of the rotor, where therapy can be delivered to treat the rhythm disorder.

FIG. 25 is a block diagram of a computer system in accordance with the disclosed embodiments.

DETAILED DESCRIPTION

Definitions

For purposes of this invention the following definitions shall apply:

"Detecting/Diagnosing": The terms detecting and diagnosing a rhythm disorder are used interchangeably in this application.

"Activation time" means the time of activation onset for a given heart signal.

"Activation time duration" means the time period and the signal waveform between the times of activation onset and offset for the signal of a given heart beat. Diastolic interval is the time period from activation offset of the prior beat to activation onset of the present beat (FIG. 3).

"Activation trail" means the ordering of the activation time onset at the sensor locations to create a discernible signature pattern, for example, including without limitation a rotational pattern around a core region indicative of a rotor, a radially emanating pattern from a core region, indicative of a focal beat cause, or a dispersed pattern, requiring further signal sampling and repeating of above analysis steps.

"Identify and locate" means the process of discerning the presence of a localized or dispersed cause of the heart rhythm disorder, then locating said cause relative to sensor locations or relative to known anatomic positions in the heart.

"Heart rhythm disorder" means an abnormal rhythm, often requiring treatment. These include without limitation, rapid rhythms of the top chambers of the heart (atria) such as rapid and abnormal activation of the normal sinus node (inappropriate sinus tachycardia or sinus node reentry), atrial tachycardia (AT), supraventricular tachycardia (SVT), atrial flutter (AFL), premature atrial complexes/beats (PAC) and the complex rhythms of atrial fibrillation (AF) and certain forms of atypical atrial flutter. Rapid rhythms can also occur in the bottom chambers of the heart (ventricles), including such as ventricular tachycardia (VT), ventricular fibrillation (VF), torsades de pointes and premature ventricular complexes/beats (PVC). Heart rhythm disorders can also be slow, includ-

ing sinus bradycardia, ectopic atrial bradycardia junctional bradycardia, atrioventricular block and idioventricular rhythm.

“Cause of biological or heart rhythm disorder”, which is used interchangeably with “source of the biological or heart rhythm disorder” in this application, refers to, without limitation, a rotational pattern of activation sequence around a core region indicative of a rotor, a radially emanating pattern from a core region indicative of a focal beat cause, or a dispersed pattern. In this invention, when a dispersed cause is found, signal sampling is extended to additional multiple locations and the detection and analysis steps of the invention are repeated. These causes are directly responsible for the perpetuation of the heart rhythm disorder.

“Sensor”, which is used interchangeably with “electrode”, refers to an apparatus for detecting and transmitting signals from the heart or to the heart.

Prior to the discovery of the present invention, the causes of human biological rhythm disorders, and particularly heart rhythm disorders, had not been identified. The present invention represents the first known instance where a method of detecting, diagnosing and subsequently effectively treating, in an accurate and minimally invasive manner, the cause(s) that sustain, perpetuate, or ‘drive’ human biological disorders has been described. This method enables the physician to target these sources for modification or elimination to abolish the disorder. Although one preferred embodiment is for minimally invasive procedures for heart rhythm disorders, the invention can also be applied to surgical therapy, and for disorders of electrical impulse generation or propagation in organs such as the brain, central nervous system (where it may locate causes of epilepsy or seizure), peripheral nervous system (where it may detect tumors), skeletal muscle and smooth muscle such as the gastrointestinal tract, bladder and uterus.

In accordance with an embodiment of the invention, there is disclosed an apparatus to sample signals, for example a sensor device such as a electrode catheter from multiple locations within a human organ, such as the human heart, at varying spatial resolutions and fields of view and with apparatus to alter the number of sensing channels accordingly.

In accordance with an embodiment of the invention, there is disclosed a method to identify and localize electrical rotors, focal beats and other localized causes for heart rhythms, including complex rhythms such as AF, VF and polymorphic VT.

Embodiments of the invention may use processes and software methods such as ordering the activation sequence to create an activation trail, processes such as the Hilbert transform, other phase delay methods, spatial coherence analysis and other methods.

In one embodiment of the invention, data collected from sensors and analyzed is stored as data in a database that is automatically updated. This database is used to assist the physician in the diagnosis/detection of localized causes, or to classify a pattern of causes of rhythm disorders. This may take the form of a probability distribution map of causes in patients with specific characteristics.

In accordance with another embodiment of the invention, there is provided an apparatus to display causes for the biological rhythm in a format that can assist the physician in treatment. For example, a visual display screen may be connected to a processor to allow for viewing of the activation trail and to allow for visual location of the core of a rotor, focal source or other cause of the disorder. Audio formats may also be used alone or in combination with the visual format. For example, in addition to or instead of the visual depiction of the

source such that the core can be visually identified, the coordinates of the source and its core can be provided to the user by audio indications as to the location and cause of the disorder. Visual depiction is particularly desirable because it provides the practitioner with a clear representation of the cause and provides a reference for identifying the core of the cause, which greatly facilitates the selection of treatments. For example, a visual representation of the actual rotor or focal beat allows the practitioner to accurately determine where to direct the ablation catheter or other treatment.

In accordance with another embodiment of the invention, once the cause of the disorder is identified, use of a treatment device or method, to modify or destroy the site of an identified and localized source may be employed to treat or eliminate the rhythm disorder. Non-limiting examples of treatment devices and methods include the use of destructive energy (ablation) such as by ablation catheters, surgical ablation methods, surgical removal or using devices inside the heart such as implanted leads or other physical device, stimulating energy (pacing), direct delivery of pharmacologic agents, cellular therapy or other intervention techniques. In one embodiment, a catheter capable of sensing signals from the body, and particularly from the heart, may also include a means of treatment, such as the ability to delivery ablation energy, stimulation energy, drug therapy, cellular therapy such as stem cells or gene therapy, or other treatment means. Thus, such a catheter may be employed both in the detection and in the treatment of the disorder.

The present invention is particularly suited for the detection, diagnosis and treatment of complex heart rhythm disorders such as, for example, VF, polymorphic VT, torsade de pointes and AF, where once the localized cause is accurately identified and pinpointed, accurate and targeted ablation of the localized cause may be implemented. As discussed above, identification and physical location of the cause was previously not possible, and hence extraordinarily difficult even for experienced practitioners to treat successfully, much less substantially ameliorate or eliminate.

In addition to finding the cause of and subsequently treating complex heart rhythm disorders, the present invention may also be applied to help diagnose and treat ‘simple’ rhythms that emanate from a single site by accelerating and simplifying analysis for the practitioner. For heart rhythm disorders, such simple disorders include focal atrial tachycardias, multifocal atrial tachycardias (MAT), sinus nodal reentry or inappropriate sinus tachycardia, ventricular tachycardia (VT), premature atrial complexes (PACs) and premature ventricular complexes (PVCs).

Included in the invention are a process and system to collect data, including sensing devices and recording systems. The collected data includes at least the location of each sensor which transmitted one or more signals and the onset time at which each activation signal or activation time duration occurred. The processor receives this information and sequentially orders the activation onset times. The result of this computation is the creation of an activation trail which creates a signature pattern for the disorder and indicates both the location and the type of the cause to the disorder, i.e. whether it is a rotor, focal source or a dispersed pattern, i.e. no localized source, hence requiring further data to be collected from a different area of the heart or other body region. The data once ordered in this manner creates an activation trail which can visually be depicted on a visual display to show, in the case of a rotor source, the actual rotational pattern of the rotor such that the core of the rotor is visually apparent and can easily be identified and hence treated. The same hold true for the depiction of a radially emanating source, such as a

focal beat. The sequential ordering of the activation onset times at each sensor permits the location of focal rhythm disorders, such that the focal core can be easily located on the visual display for targeted and accurate treatment. Desirably, the rhythm sources or causes are displayed over a period of time to allow the practitioner to fully observe the causal point or area and to make a comfortable assessment as to the appropriate treatment at the causal location. In one embodiment the data and/or the visual displays of the processed data (i.e. a "movie" of the activation trail) elucidates the signature pattern of the cause of the rhythm disorder. Such stored information allows for the practitioner to consult previous patterns to aid in improving the identification, localization and treatment of similar causes. In some instances, such stored information allows for extrapolation of measured real-time data to provide predictive models or to clarify certain measured patterns using similar known patterns.

A further embodiment of the invention provides a process and system for the treatment of such causes, often by modification or destruction of tissue where causes reside. Sixth, a preferred embodiment enables the invention to be used in an 'offline', non-real-time review mode, rather than directly during a procedure to treat a patient.

The process and system of the invention may be employed to localize sources (i.e. find the physical location of the cause) for abnormal electrical impulse generation or propagation in the brain or central nervous system using the electroencephalogram or other index to guide invasive therapy (surgery) or external beam irradiation to identify and treat seizure or epileptic foci, or focal tumors (malignant or otherwise). The invention may also be used to identify sources for abnormal impulse propagation in striated muscle (such as injury in skeletal muscle), the gastrointestinal system (such as esophageal spasm), and the urogenital and respiratory systems. The invention may also be used to detect tumors (malignant or otherwise) in any body system. The invention also has applications outside of medicine, such as for locating the source of a seismic event or for locating energy sources in tandem with methods such as radar or sonar.

The invention has several aspects to its process and system for carrying out the process. By way of example and not of limitation, in one aspect of the invention, signals are detected from multiple locations in an organ in the rhythm disorder, altering the spacing between sensors to optimize clarity of said sensing. A particularly desirable embodiment also records these signals from a heart, or other body part, during a rhythm disorder and stores them in a data base. The location of each sensor associated with a particular signal, as well as the activation onset times at each sensor are transmitted to a processor for analysis including sequential ordering to form the activation trail identifying the cause of the disorder and its specific location in the body. Creating a database of causes, which may be manually or automatically updated allows for accessing the data base to assist in the identification and localization of disorder causes. This is used when data collection in the current patient is of limited quality, to compare the pattern in a patient to prior recorded rhythms in the patient to determine if the rhythm is the same or different, or to compare the pattern in a patient to that from another patient, such as one with similar clinical characteristics. Previously stored data from a previous case may be used to help identify, localize and display causes for the rhythm disorder in a present case.

Visually displaying the sources of the disorder is extremely useful to the practitioner because it serves as a visual guide to

the existence and location of the cause, and permits subsequent targeted and accurate treatment to ameliorate or eliminate the rhythm disorder.

In other aspects of the invention, previously stored data from another case may be used to identify, localize and display causes for the rhythm disorder in a present case. This can then be used to plan the use of this invention in a future procedure.

Description of Useful Components, Modules, and Devices

FIG. 1 shows a schematic of various useful components (modules) which may be used in the process and system of the invention. The modules may be separate from each other and cooperatively interfaced to provide their function, or one or more of them may be integrated with each other of contained in the processor, such that the system has less separate hardware units. FIG. 1 depicts an embodiment which allows a cause of the disorder to be localized during a minimally invasive percutaneous procedure, or other procedures such as using surface ECG, a magnetocardiogram, an echocardiographic and/or Doppler measurements from ultrasound, electromagnetic radiation, sound waves, microwaves, or electrical impedance changes.

In FIG. 1, electrical events in the heart 10 are recorded with sensing electrodes. These electrodes may be catheters 20 placed within the chambers or vasculature of the heart, including custom-designed recording catheters exemplified in FIGS. 2-4. The electrodes may also be extensions of leads from an implanted pacemaker or cardioverter-defibrillator, catheters used to record monophasic action potentials or other signals, that typically arrive via the vena cavae 20-21 or coronary sinus 22. Thus, although particularly useful in the invention, the process and system of the invention need not, however, employ the specialized catheters of FIGS. 2-4, as any catheters or sensing devices used inside or outside of the body which capable of accurately transmitting the activation times and location of their occurrence may be employed.

Electrodes 23 may record from the epicardial or pericardial surface of the heart, accessed via electrodes 21 in the coronary sinus, via the electrodes 23 in the pericardial space or other routes. Electrodes may be located in proximity to the nerves supplying the heart 15, which may be located in the left atrium and ventricles. Electrodes may be virtual (computed) electrodes from a computerized mapping system, routine or high-resolution ECG mapping electrodes 30, electrodes implanted under or on the skin, or derived from methods to non-invasively detect signals without directly contacting the heart or body. Electrode information may also be derived from stored electrograms in a database 160.

An electrode 25 placed near the heart may be used to modify or destroy regions that are near or at the cause(s) for a rhythm disorder. If the electrode is an ablation catheter, it interfaces to an energy generator 60. Other electrodes may interface with a controller 40, and a pacing module 50, and all desirably communicate with a process controller 70. Ablation or pacing can be directed to nerves supplying the heart 15, which are located at many locations of the heart. Internal ablation electrodes may be replaced with an external ablation system, such as external probes during surgery, or as in external focused irradiation or photon beam as for cancer therapy. In addition, modification of sources, i.e. treatment of the causes of the disorder, may be achieved by delivering appropriate pharmaceutical compositions, gene therapy, cell therapy, or by excluding tissue (at surgery or by using specialized devices).

The process controller 70 may include various components or modules. On such component or module includes a sampling module 80 which is capable of recording signals during

the rhythm disorder, recording at various rates not in the rhythm disorder (by pacing), and/or recording during rates that simulate the heart rhythm disorder (by pacing or other methods). Signal amplifiers (not shown) may be used to enhance the signal clarity and strength, and the process controller may also intelligently assign the fewest number of recording amplifiers to sense from a sufficient number of locations to identify and localize the cause. For instance, the system may use only 50-60 physical amplifier channels to record from 128 sensors (for example, from two commercially available multipolar catheters), by recording those 128 sensors on a 'time-share' basis by time-slicing, or by activating individual/multiple sensors close to a rhythm cause while deactivating others. This 'switching' functionality may be performed by a switching component that connects the sensor device with the electronic control system, and that may be embodied in one or more other components. Switching may be manual or automatic, determined for instance on where causes of the heart rhythm disorder lie. Module 90 interfaces with the pacing module to provide additional heart rates for sensing the biosignal. This is particularly useful for the non-real time mode (mode 6), described herein, because it can study the heart at different heart rates even when not in the particular heart rhythm disorder being diagnosed and treated.

The inventive method and system processes the collected data using analytical methods, which may be performed by analytic modules. For example, in FIG. 1, Module 100 is part I of an "Analytic Engine." This portion of the Analytic engine determines the onset and offset for the biologic signal over time, at each sensed location. This is implemented by creating a series of activation times (onset timing) and recovery times (offset timing) during the rhythm over time (illustrated in FIG. 6). The signal is typically represented as voltage over time (that is, as a voltage-time series). Activation time can be processed in many ways. The simplest includes manual assignment at each location. Automated or calculated assignment can be achieved by using zero of the first derivative to define maxima or minima, zero of the second derivative to indicate maximum upstroke or downstroke, or similar methods. Activation onset and offset times can also be assigned when the voltage time-series crosses a threshold. Another possible method to assign activation times is using pattern-matching. For instance, a pattern selected to represent the activation duration can be correlated to the signal at multiple timepoints over time. The time when said correlation values are high indicate recurrences of said template, and thus are considered activation times. The template used for this analysis can also be obtained from stored data in a database, or computed from a rate estimate for the rhythm at that location. Simultaneous recordings from multiple sensors can help in analyzing activation, particularly for complex rhythms such as AF or VF when signal quality may be noisy, of poor quality or show multiple components at different times. From simultaneous recordings, a reference signal is selected, preferably at a nearby location to the channel being analyzed. Signals on the reference channel are used to select signal or signal components on the channel being analyzed. This can be done by using components that retain a similar timing over time, using pattern matching or correlation functions, vectorial analysis or other methods. If many methods are required, heuristics, pattern recognition methods and so-called 'fuzzy logic' approaches can be applied, constrained by known pathophysiology of the atrium.

Module 110 is part II of the Analytic Engine that actually computes and localizes, i.e. determines the existence and location of sources (causes) for the heart rhythm disorder.

Some embodiments of the invention include a "Therapy Engine," which may contain one of more modules designed to cooperatively perform different functions in the system and process. For example, module 120 in FIG. 1 may be responsible for determining the location and migration pattern of sources for the rhythm disorder within the heart. This may be a first module of the Therapy Engine, and is used to compute the location and spatial region which is required to be modified in order to treat or eliminate the rhythm disorder. Treatment may be by delivery of ablation energy or other means as discussed herein, and is not simply one point or region if the source migrates during ablation. Module 130 is representative of another module of the Therapy Engine, and desirably directly interfaces with the energy generator to ablate (destroy), modify (ablate or pace) or stimulate (pace) tissue at sites likely to represent sources. Alternatively, the Module 130 may be used to modify tissue without destructive energy, for example by delivering pharmaceutical agents, or gene or cellular therapies.

Module 170 of the system shown in FIG. 1 is representative of a tool to display the identification or location of causes visually or in auditory fashion, to assist the physician in treating or eliminating the rhythm disorder. For example, this module may include a display screen which permits the textual, graphic and/or auditory visualization on the screen of the rotor, focal or other cause of the disorder to be clearly seen by the practitioner. In some embodiments, a "movie" clip of the disorder found will be presented on the screen. This clip is a real-time presentation of the actual cause and location of the disorder. For example, once the analysis of the data has been performed in accordance with the process of the invention, i.e. the location of the signals and their activation onset times have been sequentially ordered, the result of this analysis and computation will be shown on the screen in the form of an activation trail. If the pattern of the activation trail signifies a series of activations revolving around a central core, then a rotor has been found and is in fact a cause of the disorder. Similarly, if the pattern of the activation trail signifies a series of activations which emanate radially from a central core region, then a focal beat has been found and is in fact a cause of the disorder. Thus, the inventive process permits the direct finding of the cause of the disorder and the convenient visualization of the existence, type and location of the disorder for the practitioner. In the event that no discernable pattern is found, i.e. the activation trail is not localized, then additional signal sampling by moving the sensor locations and/or turning-on already placed sensors may be appropriate. The additional signal samples may then be processed in accordance with the invention and shown on the screen. If a cause is found via the additional sampling and processing of the data, then a decision as to the appropriate treatment may be made. In the event that a dispersed activation trail and pattern is found, further additional sampling may be advisable until such time as the practitioner feels is sufficient. In some instances, the result of the process will render a finding of the existence and location of a rotor or a radially emanating focus. In other instances, where a dispersed pattern remains even after repeated sampling and processing, a diagnosis may be made ruling out a rotor or focal beats as the cause. Thus, the finding of a rotor or a focal point (beat) will be essentially a detection and diagnosis concurrently, whereas the lack of such a finding will be a diagnosis which may rule out the presence of either of these causes of the disorder.

Mode 1. Signal Sampling (FIG. 1, Reference 80)

Signal sampling can be done in real time, during a procedure to ablate or treat the rhythm disorder, beforehand to plan for a procedure, or afterwards to review the disorder. As stated

above, signals are collected at one or more locations from the organ using a variety of sensor types. Contact sensors should maintain as good a contact with the tissue as possible. In the preferred mode, electrodes should record at multiple sites simultaneously or nearly simultaneously. The fastest heart rhythm disorders such as AF have cycle lengths >100 ms, so that signal acquisition for substantially less than this time is considered 'nearly simultaneous'. An alternative mode of operation allows moving a sensor to sequential sites. The invention may be used with any existing sensor apparatus.

Although a variety of commercially available electrode devices may be used to obtain signal sampling, particularly useful device embodiments for signal sampling are shown in FIGS. 2-4. These apparatuses use multiple sensors that may be individually activated or deactivated, or moved relative to one another. This enables adaptive spatial resolution, in that sensor spacing can be increased or decreased as desired. Widely-spaced sensors provide a wide field of view to 'survey' the rhythm for a large portion of the organ (e.g. left atrium of the heart). Once the source location is approximated, the configuration is desirably altered to reduce sensor spacing for higher spatial resolution over a narrow field of view. A tightly spaced sensor configuration is preferred for applying energy to a focused region to treat a source.

Adaptive spatial resolution is an important advantage of various embodiments of the present invention. This can be achieved by physically moving sensors. FIG. 2 shows concentric helices (element 200), with multiple sensing elements (electrodes or probes) for sensing signals and in some instances delivering energy or other treatment therapy (element 205). The helices are widely spaced when parts of the catheter remains non-deployed (element 210) inside the shaft (element 215). Rotating and advancing the assembly introduces more probes in the chamber, and reduces their spacing. FIG. 3 another embodiment of an inventive sensor catheter in the form of an adjustable fan catheter, with multiple meridians (element 230) each containing multiple sensing elements (electrodes or probes) (elements 240), also for sensing and in some instances for delivering energy or other treatment therapy. By a combination of twisting or torsional motion along the shaft axis (element 245), as depicted in the Figures, the meridians may be more widely spaced (element 230) or more closely spaced (element 235), i.e. spatially adjusted. FIG. 4 shows another embodiment of an inventive sensor catheter in the form of an adjustable corkscrew design, with a small number of spiral meridians (element 260) ending on a blunt non-traumatic end (element 270). As with the design structures of FIGS. 2 and 3, the meridians of FIG. 4 may include multiple elements (electrodes or probes) (elements 265). The corkscrew can be advanced or retracted into the sheath by manipulating the shaft (element 280), to increase or decrease the corkscrew size and/or probe spacing. These designs can be made larger or smaller to fit a larger or smaller organ (e.g. atria of varying sizes), or substructures including pulmonary veins or the superior vena cava that may be sources for rhythms such as AF. Physical movement can be achieved manually by the physician or automatically by using machines. Given the observed properties of sources for heart rhythm disorders observed by the inventors, it is desirable that the sensors sense from at least about 25% of the surface area of each one or more chambers of the heart. These designs are illustrative only, and are not intended to limit the actual physical design or application of this invention.

Optimal contact for each sensor can be monitored by the process controller 70 for adequacy in various ways. For example, the process controller 70 can verify contact via stability in the amplitude of sensed signals. Alternatively, the

process controller 70 can condition the pacing module 50 to emit signals through electrodes 20-30, and use the amplitude of evoked responses to verify contact. As a third alternative, the processing module 70 can determine contact by confirming stable tissue impedance (in AF, for instance, where pacing is not possible). As other alternatives, catheters designed to examine mild injury patterns, or designed to directly measure contact force, can be used. In addition, catheter manipulation can be controlled robotically in semi-automated or automated fashion, as well as manually.

Adaptive spatial resolution can also be achieved electronically. Sensors in this adjustable sensor device are connected to an electronic control system that may activate or deactivate individual sensors. This may be performed manually, such as if the physician wishes only to focus on one region of the organ, or automatically by the process controller in FIG. 1 to focus on a region determined to be where the heart rhythm source lies. An electronic switching apparatus controls independent switching of connections between the sensors and electronic control system, in order to maximize use of a practical number of amplifier channels. These electronic components may be embodied by various combinations of traditional (wired) electrodes, fiber optics, etched-wafer circuit designs, biologic sensors, chemical sensors, pharmaceutical sensors, piezoelectric sensors, infrared sensors, patient-compliant optical imaging, optodes, remote sensors and other designs.

Electronic switching may also be achieved by time-slicing. A large number of locations may need to be sensed, but the number of sensing channels may be limited. Signal time-slicing can record a larger number of sensing channels from a smaller number of channels. For instance, signals are often sampled every 1 ms (at 1 kHz) although data acquired every 10 milliseconds (ms) or so is often sufficient for AF or VF source analysis. Thus, the system can sense at location 1 for 3 ms, locations 2 and 3 for 3 ms each, then return to sensor 1 to repeat the cycle at the 10 ms timepoint. In this way, 90 locations can be sensed using 30 channels. Any appropriate configuration can be used, depending on the switching time in hardware or software, and allowing for noise factors when switching between channels. Many other methods can be used to increase the effective number of channels, including sending multiplexed signals along a fiber optic or other device, or storing signals in random access memory, then using off-line analysis to amplify and analyze each in turn.

Numbers of sensed locations can also be increased using a combination of sensors lying in contact with different heart planes. For instance, electrodes on the endocardial (inner) surface of the heart may be complemented by electrodes on the epicardial (outer) surface and possibly those in the heart muscle itself (via implanted electrodes) to increase overall spatial resolution. This is of particular value in the atrium, whose wall is thin and where epicardial and endocardial electrodes may target similar regions. In the ventricle, or in thick walled regions of the atrium, different planes may provide different information.

In certain preferred embodiments, sensing can be performed using one or more sensors (probes) moved sequentially within the organ during the heart rhythm disorder. When a single probe is used, signals from each location are aligned relative to a timing signal fiducial. This method is easy to apply when a rhythm is relatively regular within the heart, such as the 'simple' disorders of focal atrial tachycardia or atrial flutter. However, this method can also be used as an approximate guide if the rhythm is irregular within the heart, such as the complex rhythms of AF or VF. This has the advantage of requiring fewer sensors, and will work if sources

show some stability in space. For instance, while AF is irregular, activation may be regular at localized sources, for example at certain locations such as near the pulmonary veins.

One particularly useful embodiment for using sequential sensing at multiple locations is now illustrated for a moving probe with two sensors (such as the two bipoles of a clinical quadripolar catheter), although more sensors may be applied if available. At each location, one sensor is considered the reference and the onset times for successive cycles (beats) are fiducials. The difference in activation time at the second sensor is used to indicate relative timing. The probe is now moved so that one sensor overlies the previously sensed location. The second sensor now senses a fresh location and can record relative timing onsets for multiple beats here. The process is repeated for the entire region of interest. Because this process introduces stability in relative timing between locations, variability can be reintroduced stochastically using observed beat-to-beat timing variations at each location.

An alternative approach is to use gradients in rate and/or organization within the chamber, compared to stored data from a database for that rhythm (including AF or VF). After sensing sequential locations, the activation rate in both chambers is compared to stored patterns that describe this relationship at various sources (rotors or focal beats) and surrounding sites. An error-minimization approach (such as least-square-errors) may be used to estimate the source location. Estimates may be refined adaptively, based on similarity to subsets of stored patterns and using algorithmic, heuristic, fuzzy logic or other pattern recognition scheme. This process is repeated iteratively. For a spatially consistent source, second and subsequent iterations will add precision to the original estimate, and may be focused at locations closest to the estimated source.

Delivery of treatment therapy may be another feature of the sensor device, that will be described in detail later herein.

Mode 2. Computing Causes of Heart Rhythm Disorders

The first step in analysis is to determine the signal type, using a lookup table as illustrated in FIG. 5, reference numerals 400-460. This step determines if the signal arises from the heart (cardiac), brain, respiratory system, gastrointestinal tract, urogenital system, and so on. If cardiac, the signal may be a surface ECG, intracardiac, echocardiographic or other signal. If intracardiac, the signal is further classified as an action potential (monophasic action potential), bipolar electrogram, unipolar electrogram or other. Some of these signals provide high quality information (e.g. monophasic action potential recordings in the heart), while others do not. Lower quality signals are more likely to require pre-processing, filtering, averaging, comparison against stored signals in a database, in that patient at different times and other computational steps to allow source localization.

In FIG. 6, the signal is parsed between steps 800-840 to identify its type in the lookup table (from FIG. 5). This includes assigning activation onset and offset, and the interval between beats (diastolic interval) that depends upon the signal type illustrated in the lookup table in FIG. 5. The lookup table can be a comprehensive biosignal inventory, with data on the distinct physiological role of each component for computational purposes. Components may vary with rate and may fluctuate from beat to beat. Each signal component may reflect a distinct aspect of normal or abnormal physiology and thus indicate likelihood that the rhythm disorder may arise. Examples are not intended to limit the scope of the lookup table, which may include signals from other muscles (e.g. skeletal muscle, bladder and gastrointestinal tract), the brain and the nervous system.

The next step in analysis is to define, for each sensed location, the physiological signal to be analyzed. The goal is that the resulting signal best represents actual physiological activation and recovery occurring in the heart rhythm disorder at each location. When the recorded signal is 'clean' (has a high signal-to-noise ratio), this will be the physiological signal. If signals are noisy, then filtering, noise reduction and other schemes may be needed to reveal the physiological signal. Said noise schemes may require recording while the patient holds his/her breath for several seconds. For analysis of atrial rhythm disorders, the physiological signal is best recorded between ventricular activations (in the R-R interval), that may be facilitated if the heart beat is reduced (R-R interval is prolonged) using agents to slow ventricular rate or by reducing pacemaker rate in patients with such devices.

FIG. 7 panels 600-670 illustrate a particularly useful embodiment for constructing physiological signals using computational methods to compensate for limitations due to noisy or low quality data. First, the response to rate of each signal type (monophasic action potentials, MAP, illustrated in panels 600, 620, 640) is determined. This is performed by sensing signals at varying rates when in the rhythm disorder, or when not in the rhythm disorder (such as by pacing, see mode 6). The response of the signal duration (illustrated for MAP) to rate is shown in panels 610, 630, 650, and shows that MAP shortens at increasing rate (that is, when diastolic interval shortens). It is to be noted that the response to the same set of rates may vary when the patient is and is not in the heart rhythm disorder. FIG. 8, panels 700 to 740 show this. Pacing with delivery of a single extrabeat in panel 700 results in the restitution plot shown in FIG. 6, 710 as soon as AF begins. However, after several minutes, the restitution curve changes as shown in panels 720-740.

One approach embodied in the present invention is to create a 'hybrid' signal by inserting a physiological pattern at the time of each activation time onset (panels 660-670). The physiological pattern may be obtained by averaging recorded signals over time (algebraically, from the median beat average or other method), averaging signals at neighboring locations (spatial averaging), from monophasic action potentials at various locations (panels 660-670), by filtering existing unipolar or bipolar signals in the frequency or time-frequency domain, or by using stored patterns from a database (FIG. 1, 160). When stored signals are used, properties including duration of these physiological patterns may be adjusted for rate using rate-response (restitution) behavior. Stored signals may be obtained from this patient, another patient with similar characteristics or another stored relationship. These processes may be applied to individual activations, or to the entire signal.

This method results in a physiological representation of activity at each location over time that may otherwise be difficult to obtain in the beating heart of patients during minimally invasive procedures. It has applications outside of heart rhythm disorders. For instance, said physiological pattern may be a model of cellular ion function. This enables the function of these ion currents at each sensor to be modeled cells timed to each observed activation, for the study of dynamics of calcium fluxes, potassium currents or other processes within the beating heart of this patient. By way of a further example, this physiological pattern may be a model of a pharmacological ligand, allowing study on the behavior of the beating heart to specific pharmacologic agents. In the gastrointestinal tract, cellular hormone release models may be studied for each peristaltic 'beat'. In the brain, known kinetics of neurotransmitter or endorphin release for discrete brain waves (non-invasive, via the scalp electroencephalo-

gram or invasive, as surgery) may help to understand and treat various conditions. Treatment of conditions of epilepsy, for example, using the present invention is one embodiment of the invention. This invention also includes a method for determining the effect of a pharmacological or bioeffective agent on the body by correlating the behavior of the beating heart or rhythm of another body part with the release, binding capacity or rate, or other action of the agent on the body.

An activation trail is then determined from sequences of activation in the physiological signal at multiple locations. The simplest form of this analysis is to order activation at each location sequentially in time. In other embodiments, analysis may identify and locate causes for a rhythm disorder using frequency domain methods, time-domain methods or spatial-phase methods. Frequency domain methods include the Hilbert transform or wavelet transform or phase delay methods. Spatial phase methods involve analyzing the spatial interrelationships between sites showing activation at a certain location, in order to define the activation trail.

Pertaining to phase-space methods, a well-known technique assigns a phase ϕ to the signal at every electrode and at every time point. The phase at the exact location of the tip of the rotor is undefined and summing up the phase of neighboring electrodes results in a "phase jump" of 2π . Thus, a rotor location corresponds to a phase singularity. Mathematically, these phase singularities can be found by evaluating a line

integral over a closed curve as $\oint \vec{\nabla} \phi \cdot d\vec{l} = \pm 2\pi$ where the line integral is taken over a path l surrounding the phase singularity. Since the signal from the electrode is a single observable, the determination of the phase requires special attention. We will employ several different methods depending on the quality of the electrode signal.

The first phase-space method will be utilized if the signal from the electrodes is noisy and/or has a small amplitude. In this case, activation times for each electrode will be determined, followed by a novel analysis of wave front dynamics. As a first step, the spatial resolution of the probes and their activation times may be increased using a bi-linear interpolation scheme that interpolates activation using a fine regular grid created across the surface. In high quality physiological signals that contain activation, recovery and diastolic interval information, this results in a time trace $V(t)$ for each point of the refined grid.

Since the shape of the action potential may be stable between beats, the method next defines a mapping from the membrane potential V to the phase ϕ . This map assigns a unique value of ϕ to each value of V such that the maximum and minimum of the phase variable differs by 2π . The detailed form of this map is arbitrary and the phase is computed using $\phi = 2\pi(V - 0.5)$. The corresponding time trace of the phase variable results in construction of the signal and its phase instantaneously as in FIG. 8 (panels 710-730).

Once the phase map is constructed the method will calculate, for each time, the sum of the phase for all four points of the fine regular grid separated by a grid spacing that form a square (topological charge method). A result not equal to zero indicates the existence of a phase singularity and a rotor. The analysis will be further aided by the tracking of wave fronts. The location of these fronts will be computed using the regular fine grid by determining where and when V crosses a threshold value with a positive derivative dV/dt . Performing this calculation along the x and y direction of the fine regular grid and using linear interpolation between the grid points, will result in a set of points that lie on the wave front.

The wave front is then constructed by connecting these points. A similar analysis will be performed for phase, where isophase lines are tracked. A two-dimensional visual representation is then constructed that plots for each time point the value of the membrane potential using a grayscale or color scale, lines representing the wave fronts, lines representing similar phase (isophase lines), and symbols locating the phase singularities. This visual aid will greatly benefit the practitioner in interpreting the results of the inventive process and system. Note that the crossings of the lines representing the wave fronts and the isophase lines represent the phase singularity. Phase singularities indicate core regions, and thus can be used to localize the rotors.

The phase transform is able to demonstrate focal beats in AF—typically as centrifugal sources emanating from a localized area. A focal beat is characterized by a location that fulfills three criteria: 1) its activation time is earlier than at surrounding locations; 2) this region was previously inactive (in diastole) for a specified period of time; 3) the subsequent spread of activation emanates radially from the core region. Recognizing these 3 criteria, the invention finds these sources automatically. This algorithm will first determine locations that exhibit activation times ahead of their four nearest and four next-nearest neighbors and mark these as potential focal sources. Next, it determines the activation times at locations surrounding a potential focal source. If the activation times of these locations are earlier than their surrounding electrodes, the potential focal source is confirmed and is marked accordingly. These sites are plotted using our plotting technique as described above, greatly aiding the practitioner in localizing and interpreting these sources.

Alternatively, frequency domain methods may be used. On the physiological signal during the heart rhythm disorder, that may be the recorded signal or a signal derived after filtering, noise reduction and other strategies described above, one may employ several methods.

Once such method is the Hilbert transform. The Hilbert transform shifts the phase of the negative frequencies of a signal by $\pi/2$ and the phase of the positive frequencies by $-\pi/2$. In this approach, determination of the phase ϕ of the signal is achieved by plotting voltage against the Hilbert transform of the voltage. The particularly useful embodiment applies a detrending algorithm to set the voltages at the activation times (maximum dV/dt) to zero. The Hilbert transform is used to construct the phase plane of detrended signals. The Hilbert transform at all locations is interpolated across the fine regular grid created across the biological surface. Phase is then calculated from the state-space plot of voltage versus its Hilbert transform. Again, the spatial distributions of phase will be analyzed with the topological charge technique described above to locate phase singularities associated with phase singularities (the ends of wavefronts) such as at the tip of a reentrant wave. Activation wavefronts are constructed using the same technique as described above while isolines of zero phase will also be tracked. An example of our methods in the human atria is shown in FIG. 12 elements 1030 and 1040 which show rotors in the left atrium computed using frequency-domain methods.

Another useful method employs a time delay embedding technique to determine the phase of the signal. This technique consists of plotting $V(t+\tau) - V^*$ vs. $V(t) - V^*$ for a fixed time delay τ and offset V^* , resulting in a value of the phase ϕ for each time point and each location. In practice, the time delay and offset will be determined by the practitioner after examining these plots for several locations using different values for τ and V^* . Optimal values lead to trajectories that do not cross (that would lead to a non-unique value for the phase)

and that encircle the origin (ensuring that the minimum and maximum phase differs by 2π). Both the signal and the phase are interpolated across a fine regular grid created across the biological surface. The resulting phase map will then be examined for phase singularities and wave fronts will be tracked as described above.

Yet another useful method used to determine the phase of the signal is a wavelet transform. The exact form of this wavelet is variable, and an example includes the Haar wavelet. The wavelet transform will be computed for each location. The wavelet allows us to view the signal in multiple frequency resolutions. This will enable us to filter unwanted noise at specific frequencies (or frequency bands). In this approach, the phase transformation is achieved by plotting voltage against the phase shifted wavelet transform of the voltage. Once the phase ϕ has been calculated, we will precede as before, including refining the grid through bi-linear interpolation, finding phase singularity and tracking wave fronts.

Other information, such as locations within the organ of sites of rapid rate during the rhythm disorder, the presence of very regular sites surrounded by less regular sites, the presence of stable beat-to-beat configuration (shape) for successive signals as opposed to varying signal configurations, proximity to anatomic features known to be associated with particular rhythm disorders (such as pulmonary veins in AF, His-Purkinje system in VF), or a combination thereof may also assist in identifying and locating sources.

Several types of activation trails may result, producing corresponding discernible signature patterns for various types of causes for a rhythm disorder. An activation trail in which sequences of activation revolve around a central 'core' region is termed a rotor. An activation trail that emanates radially from a core region is termed a focal beat (or a site of repetitive focal activations or beats). Another activation trail type is a dispersed pattern, in which a localized source is not clearly identified. In particularly useful embodiment, in such cases, signal sensing is repeated at additional locations or for additional periods of time. Localization of a cause for a heart rhythm disorder is based on the location of the core region and additional activation from this region. Some embodiments identify the core region directly. For instance, the Hilbert Transform and direct phase assignment methods identify the core region as the site where real and imaginary parts of the analysis intersect. In contrast, the direct sequential ordering method of the present invention indicates a core region either visually or analytically.

FIG. 10, referenced by panels 1400-1495 describe the process of optimally identifying, locating and selecting cause(s) that are most likely to indicate primary causes of the rhythm disorder. In one particularly desirable embodiment, a probability map 1480 for sources of the disorder is constructed. This indicates a likelihood that each sensed location harbors a cause of the rhythm disorder, relative to other sensed locations. A higher relative likelihood is assigned for sites where core regions sustain for longer periods of time (or, for more rotations or beats), where the rate of activation is faster, where the rate of activation is more organized, that activate surrounding tissue in a 1:1 fashion (thus, there is electrogram linking) and activate larger regions of tissue in phase (and thus have a large space constant), when fewer concurrent sources are identified, for sources that lie near known regions of high likelihood for rhythm disorders such as the pulmonary veins in human AF, for sources with less migration over time, and for rotor versus focal beat types of source. In one particularly useful embodiment, probabilities are assigned after comparison with stored examples in a database; the comparison may take the form of a stepwise multivariate comparison.

In the limit case, a spatially fixed source, that is a solitary electrical rotor and that directly activates the entire organ is by definition a primary cause of that heart rhythm disorder.

Surrogates for the activation trail also exist. These are data that approximate the identification and localization provided by the invention using data from fewer locations, less lengthy or detailed recordings, or using information from other resources such as the ECG rather than from within the heart. Thus, surrogates enable approximation of the activation trail using a reduced number of sensor locations compared to an analysis that directly measures the activation trail. These surrogates, used independently or in combinations, include sites of rapid rate during the rhythm disorder, the presence of very regular sites surrounded by less regular sites, the presence of stable beat-to-beat configuration (shape) for successive signals as opposed to varying signal configurations, signals where amplitude is particularly low, signals that are very prolonged for each activation is very prolonged, proximity to anatomic features known to be associated with particular rhythm disorders (such as pulmonary veins in AF, His-Purkinje system in VF), or a combination thereof may also assist in identifying and locating sources.

Surrogates may be detected from the ECG, and thus be used to plan a procedure or guide therapy in a patient. Vectorial analyses of the ECG for regions of regularity and high rate, particularly if surrounded by regions of lower regularity and rate, indicate locations within the heart where sources lie.

FIG. 10, panels 1400-1495, summarize the approach to identify and locate sources. Panels 1400-1450 determine if sufficient sensor resolution is present to identify a cause. Criteria for sufficiency include the absence of discontinuities in the wave front calculation, and absence of jumps in the location of core regions, and an absolute sensor spacing that should not exceed approximately 1 cm. This is based upon computations that the minimum circumference of a reentry wave is >2 cm in the human atrium and larger in the human ventricle. Panels 1460-1490 then use a combination of optimized sensed data and stored data to compute sources, that are then treated, panel 1495. The present invention includes the wide use of filtered or unfiltered clinical data, data from a database including this and other patients, or computational estimates to represent the signal to be analyzed as well as the results of analysis. In addition, the hybrid use of existing patient-acquired data, signal processing methods, numerical methods and stored signals from a database are major advantages of the inventive process and system, particularly because high-resolution physiological data from human atria or ventricles may be extremely difficult, if not impossible, to obtain at clinical electrophysiologic study without open heart surgery.

All of the above approaches may be applied to any complex rhythm, including VF. Of course, these approaches may also be applied to "simple rhythms" such as reentry around an anatomical obstacle or rotors anchored at scar tissue (such as atrial flutter).

These inventive processes may be implemented in software, operated very quickly and are suitable for real-time, as well as off-line analysis, using small scale components such as those found in implantable devices, portable ambulatory machines, wristwatch-sized devices, as well as larger scale computers found in electrophysiology laboratories.

Mode 3. Storing Data on Heart Rhythm Sources in Database

Data on sources for rhythm disorders desirably may be stored in a database 160. This may be useful to classify sources in different patients, to help identify sources in a single patient, or to determine if a patient has returned with the same or a different source. Data in the database will thus

include the characteristics described above, including the number of concurrent sources, rate, variability in rate over time, duration, size of biological organ whose activation is directly caused by the source (the space constant), location, whether this location migrates over time, rate within multiple regions of the heart at the time that the source was detected (such as left and right atrial rate during AF), and the response of each source to ablation.

Additional information to be stored in the database include one or more clinical factors from a group comprising gender (male/female), age, weight, height, presence of diabetes mellitus, blood pressure, atrial size, ventricular size, regions of atrial or ventricular scar, the left ventricular ejection fraction.

In a particularly useful embodiment, the database of AF Sources **160** will be continuously updated, based upon new source localization from additional cases. This will be used to help source localization for practitioners studying new patients, by way of a software expert system that will match the new patient to already stored patterns.

Source data to be stored will be analyzed for consistency with existing data, matched by the above variables. Only raw data that meets rigorous standards for data integrity will be incorporated, others will be rejected. After ensuring data integrity, data will be added to the database to improve localization for future patients.

The invention and database interface may include an expert system that compares current data with stored data. Based on the closest match or matches, logic within the invention determines if additional heart rhythm sources or additional characteristic should be studied, and whether they may lie based on stored information. This uses a 'goodness of fit' against various stored parameters. This functionality is included because in practice, the number of sensed locations is limited by time constraints, in practice, many sensor locations may provide suboptimal data, thus limiting the actual sensed resolution, and because the inventor has observed that many patients show similar source locations and characteristics.

Database updates will be available to the practitioner regularly from a centrally located, secured database that contains the above information. No information on patient name, geographical location, study date or other items prohibited by the Health Information Portability Act (HIPAA) will be included. This database will be maintained at a remote location but available electronically by means including wired and wireless communication, electronic media such as CDs, DVDs, and solid state storage devices.

Mode 4. Display of Sources of Biological Rhythm Disorder

The invention includes methods and apparatus to communicate the identification, location and above characteristics of sources for biological rhythm disorders to the practitioner. This includes a visual display means, typically in the form of a graphical display on a computer monitor, or a printout showing the source in relation to cardiac anatomy, or a basic textual line summary of the location and/or sensor site where the source lies.

An auditory display may also be used, that vocalizes the identification, location and above characteristics of sources for biological rhythm disorders to the practitioner. In one embodiment, this would include the conclusions or a summary of analysis rather than the analysis results themselves.

Mode 5. Therapy at Causes of Biological Rhythm Disorder

In addition to the processes and systems of the invention used to detect and diagnose the cause of the rhythm disorder, the invention also includes devices and methods to treat the source for the biological rhythm disorder, in order to modify, ameliorate or eliminate said rhythm disorder.

Treatment of the source may employ any useful technique, including ablation with radiofrequency, freezing energy, microwaves or other sources. Modification may also include cell therapy (such as with stem cells), gene therapy, pharmaceutical delivery, ionizing or non-ionizing radiation delivered by devices inside or outside the heart, or other interventions.

Treatment is delivered to modify the cause. In a simple heart rhythm disorder such as atrial tachycardia or atrial flutter, energy is applied directly to eliminate the cause. In a complex rhythm disorder, such as AF, energy can be applied to ablate (destroy) the source, to isolate the source by destroying tissue between the source and the remainder of the viable heart chamber, or to modulate the interaction between different sources. This latter form of treatment is very novel and has been shown in experiments by the inventor to be extremely effective. Modulation may be performed in a stochastic fashion.

In a particularly desirable embodiment, therapy is targeted at the core region of an identified or localized cause for the rhythm disorder, with the intention of eliminating this cause to treat the heart rhythm disorder. This may be applied sequentially to identify, locate and treat more than one cause for said disorder.

Alternatively, therapy may be targeted at locations neighboring the core region for a source, with the intention of disconnecting the source from surrounding tissue.

Alternatively, therapy may be targeted at locations neighboring the core region for a source, with the intention of causing the source to migrate towards tissue where definitive treatment is more easily accomplished. For instance, if the source lies at a location where ablation is difficult due to anatomy, tissue thickness or other factors, ablation on one side of the source may cause it to migrate towards a location that is easier to ablate due to thinner tissue or anatomic factors.

Alternatively, therapy may be targeted at locations neighboring the core region for a source, with the intention of preventing movement of the source and thus compartmentalizing it.

Alternatively, therapy may be targeted at locations neighboring the core region for a source, with the intention of reducing the mass of tissue available for the source to sustain and thus causing it to terminate.

Treatment may take the form of ablation, delivered via a catheter in the heart (element **25** in FIG. 1), on the epicardial surface, or an electrode present on one of the multi-electrode catheter designs included herein, for example see FIGS. 2-4.

When a dispersed activation trail is observed, locations where sources may lie that are difficult to identify are targeted first. In patients with AF, such sites include the pulmonary veins and other thoracic veins, and the atrial appendages. Thus, pulmonary vein isolation is performed first, followed by therapy at additional sites if clinically suspected. Signal sensing is then repeated to identify and locate a cause.

In preferred particularly desirable embodiment, the multi sensor catheter (FIGS. 2-4) includes an assembly that can deliver therapy in the form of ablation. In this embodiment, sensors at locations where the source lies are activated to deliver ablation energy to modify or eliminate the source.

The system may deliver therapy in a spatial locus, as well as at fixed locations. In this system, the location of the source core region is analyzed constantly throughout therapy. Therapy, such as ablation energy, is directed at varying locations and potentially multiple locations to constrain movement of the source. An analogy is to construct a 'fence' of ablated tissue around a moving source in order to keep it in one location. This may require therapy delivery (such as

ablation) at multiple sensors of said poles of said assembly concurrently. This process is continued until the rhythm terminates or a remote source becomes dominant.

This invention is well suited to target therapy performed surgically in the operating room with direct exposure of the heart. This may be via a minimally invasive approach or traditional open chest heart exposure. The choice of recording electrode, sock, plaque or other equipment is up to the discretion of the surgeon and does not alter the principles of therapy.

Alternatively, said modulation can be applied by stimulating (pacing) the tissue. For pacing, the process controller 70 conditions the pacing module 50, to stimulate the heart using electrodes in the heart 20-25, electrodes on the body surface 30, or electrodes elsewhere such as from the esophagus 150. The electrode controller 40 receives signals from the electrodes before, during and after pacing. Pacing is used to increase heart rate and introduce extra beats.

In alternative embodiment, the invention can ablate or stimulate cardiac nerves to modify or eliminate the source. Thus, if sources lie at locations of heart ganglionic plexuses, ablation or pacing of such locations can be used to modify the source.

If the abnormal rhythm terminates after modify or eliminating sources, attempts can be made to restart the rhythm. In the case of heart rhythm disorders, this may include very rapid pacing, the administration of isoproterenol or other interventions. The entire application of this invention is then repeated.

In the event that the abnormal rhythm can no longer be initiated, the physician may exercise the discretion to modify additional regions that may be potential sources. This information may be available directly from stored data in the database, matching patients with a similar classification to the current patient.

Mode 6. Non-Real-Time Review Mode

In an important mode of operation, the invention can be used in a non-real time, offline analysis fashion. This review mode can be applied to data from this individual at another time, such as a prior electrophysiologic study, data from a different device (such as an implanted pacemaker or defibrillator) or even a prior failed ablation. This can be used to review results from a prior procedure, to review data from a patient prior to planning the application of this invention, or to assess if the same patient now presents with the same or a different source for their rhythm disorder.

Signals are first uploaded from stored electrograms in a database 160 to the processor controller 70. This database can be the master database that stores data on multiple patients, or a patient-specific database. Data storage and retrieval can be implemented for any signal type. Stored signals can be derived from another source, a catalogued source, or computed or virtual signals such as from Ensite 3000 or NavX by St Jude Medical, or Carto by Biosense-Webster. Signals may also be derived from a different individual, querying the database for a patient with similar demographics and heart rhythm disorder.

In a separate non-real-time mode, data obtained when the patient is not in the heart rhythm disorder can be used by the invention to identify and locate sources for a rhythm disorder. This may be useful, for example, if the heart rhythm disorder is not observed at the time of a procedure, and cannot be started using conventional methods. This mode uses biological properties of the chamber to predict locations where sources/causes may lie when in the heart rhythm disorder. Such locations include sites where the maximum slope of action potential duration restitution is >1 , sites where beat-to-beat oscillations in the repolarization signal shape or dura-

tion are observed, or where conduction velocity restitution is broad to indicate slowed conduction at critical rates.

In the preferred embodiment, to measure restitution it is necessary to sense signals for a wide range of rates at each location, as indicated in FIG. 1 element 90. This may be achieved using pacing. In this case, the process controller (FIG. 1, element 70) conditions the Pacing module 50, to stimulate the heart using electrodes in the heart 20-25, on the body surface 30, in the esophagus 150 or elsewhere. The wider the range of rates, particularly fast rates, the more comprehensive the data range for that signal for analysis of restitution. When pacing is not an option, the invention will prompt the user to increase heart rate using other options or to use stored information from a database.

In this embodiment, the rate-response ("restitution") curve is created at each rate for each component of signals shown in FIG. 5. For example, this step may compute how monophasic action potential duration (time from phase 0 to phase 3) varies with rate (APD rate restitution). Examples of atrial APD restitution are shown in FIGS. 5, 6 (items 600-720). Using pacing to increase the range of sampled heart rates provides a comprehensive assessment of rate response of each biosignal.

FIG. 7, references 600, 620, 640 show a useful embodiment, whereby recordings of human action potentials made by the inventor in the left atrium 420, each of which provides high quality information including depolarization (phase 0), repolarization (phases 1-3), phase 2 amplitude and action potential duration (time interval from phase 0 to phase 3). Phase 4 indicates the interval between one beat and the next. The invention may determine rate response (restitution) of multiple components, focusing on rate-response of AP duration (time from phase 0-3), and AP phase II amplitude.

Reference 400 (FIG. 5) is an ECG. This includes intratrial components (the P wave and PR interval), and ventricular components including depolarization (the QRS complex) and repolarization (the T wave). For atrium, the invention records how P-wave duration varies with rate, using analyses shown later in FIG. 7, 600-650. For the ventricle, the invention records how QT interval varies with rate as a measure of ventricular APD rate-behavior (restitution). Individual QRS complexes are aligned using one of several columnar techniques, including methods that align electrograms about the point of largest positive or negative slope, their peak values or minimize their mean square differences, or metrics based on derived signals. T-waves are identified and aligned similarly. Atrial activity is considered to lie in the intervening intervals.

If the signal is a unipolar electrogram, it is also analyzed in analogous fashion. Each is analyzed for waveform shape as well as duration. FIG. 5, Items 430-440 indicate unipolar electrograms from the human left atrium 430 and left ventricle 440 respectively, with depolarization and repolarization measured collectively as the activation-recovery interval, a surrogate for the monophasic action potential duration. The invention determines adjustment of various components for rate.

Signals can also be bipolar electrograms (items 450, 460), and the invention determines rate response of each component.

In an alternative embodiment, ECG and electrogram data are uploaded from a database 160 for analysis in an analogous fashion to the described real-time mode of operation. Data from the database can be from the same or different patients, recorded at any time and using any acquisition system.

In AF, MAP restitution may differ from MAP when not in AF. FIG. 8 element 700 shows the initiation of AF after pacing. Element 710 shows MAP restitution during pacing in black. Immediately after AF onset (red points), APDs track

previously derived MAP restitution. However, this may not be true for longer-lasting AF. Elements 720, 730 and 740 show patients with long-lasting AF, in whom APD restitution differs from that obtained in pacing prior to AF.

Thus, it may be advantageous to use APD restitution obtained from the patient in AF, at this time or a previous time, or from stored APDs in this or other patients, or filtered or computed data, for signal processing and analysis.

Locations where sources may arise during a subsequent heart rhythm disorder may now be predicted from these analyses. For monophasic action potentials, site where the maximum slope of MAPD rate-behavior (restitution) >1 may be immediately adjacent to causes for VF or AF. Other indexes of high likelihood for the initiation of heart rhythm disorders include broad rate-response (restitution) of conduction, since such sites of dynamic conduction slowing may indicate sites where heart rhythm causes lie.

The energy generator 70 may be activated to apply destructive energy (either radiofrequency, cryoablation or microwave radiation) via the ablation electrode 25. This electrode can be moved within the heart manually by an operator, that is the traditional approach, or remotely using robotic or computer assisted guidance.

The implementation of the system described herein may be based largely upon digital signal processing techniques. However, it should be appreciated that a person of ordinary skill in this technology area can easily adapt the digital techniques for analog signal processing.

Various features of the invention are set forth in the following claims.

While the invention has been described in connection with particularly desirable embodiments, it is not intended to limit the scope of the invention to the particular form set forth, but on the contrary, it is intended to cover such alternatives, modifications, and equivalents as may be included within the spirit and scope of the invention as defined by the appended claims.

EXAMPLES

Identification and Localization of Source for AF in 47 Year Old Man

FIG. 11 panels 900-910 illustrate a representative patient, a 47 year old man with persistent atrial fibrillation (AF) for over five years. The patient continued to have symptomatic racing of the heart, which required him to visit hospital emergency rooms for treatment, despite various therapy with amiodarone and other appropriate therapy, and despite prior ablation procedures for AF. Given the severity of his symptoms, the patient therefore elected to return to the electrophysiology laboratory for further evaluation and ablation.

FIG. 11 panels 900-910 shows signals from the right and left atria during AF at the commencement of electrophysiologic study. It can be seen that the AF cycle length (time between successive activation onset times) is quite short, shown as 172 ms and 165 ms for the first two cycles in the right atrium (panel 910), and varies, as is typical for AF. Notably, signals were more fractionated and disorganized in shape in the left atrium ('post LA') and coronary sinus ('CSP' proximal coronary sinus; 'CSD' distal coronary sinus) than in the right atrium ('HRA' high right atrium; 'Lat RA' lateral right atrium; 'post RA' posterior right atrium), as is common

These findings would normally guide ablation towards the left atrium. A typical procedure in this case would commence by ablating near the pulmonary veins and confirming isolation, followed by additional ablation selecting at sites includ-

ing: (a) left atrial sites of fractionated electrograms, linear ablation at the roof, linear ablation at the mitral annulus, other linear ablation, then (b) right atrial ablation including sites of fractionation and the cavotricuspid isthmus. This proposed procedure would take approximately 2-3 hours with a $<50\%$ chance of terminating AF, meaning that electrical cardioversion would be required to restore normal rhythm at the conclusion of the procedure (Calkins, Brugada et al. 2007).

Rather than use this known approach, an embodiment of the method and treatment of the present invention was applied. A catheter assembly containing 64 sensors (electrodes) was inserted via the femoral veins into the right atrium, and across a trans-septal puncture into the left atrium of the patient. These were connected via wire cables to a recording system for collecting signals at each sensor during AF. These signals were converted to digital form, and input into a computer program. Activation onset times were recorded for 2 seconds of AF at each sensor. While two seconds was used with this patient, any greater or lesser periods of time may be useful. Desirably, one second or less may be used. In some embodiments, milliseconds may be used. Activation onset times at each sensor location were sequentially ordered in time. Stored action potential tracings were used to create an electrograph (voltage-time series), by inserting said tracings at the activation time onsets for each sensor. Finally, a direct phase assignment technique was used to identify a core region. An activation trail is directly indicated by the relationship of these activation sequences to a core region—if they revolve around a core, then an electrical rotor is detected and considered to be a cause, but if they emanate radially from a core region, then a focal beat is detected and considered a cause. Results were displayed as an animation on a computer monitor for physician review.

The activation trail (panel 1035 in FIG. 12) revealed an electrical rotor as the cause for this man's AF. In FIG. 12 panel 1000, activation onset times can be seen to revolve around a core region in the right atrium at times gray-scale and alphabetically-coded from 10 ms (level "a") to 200 ms (level "f") (panel 1010). No localized cause was found in the left atrium (panel 1020). Panel 1040 displays this same rotor in a different form, as three snapshots in time of tissue that is depolarized (activated; "red") and repolarized (not activated, "blue"). Viewed chronologically (from left to right), these snapshots also trace activation sequences revolving around a core region (a rotor). This core region had a high likelihood of being a cause, since it was a solitary source that controlled electrical activation for almost all of the surrounding atrium (large space constant).

Clinically, it was surprising that this electrical rotor lay in the right atrium. The right atrial rotor site neither showed high spectral dominant frequency, nor low amplitude fractionated signals, and would not normally be identified or targeted for ablation.

Ablation commenced directly at the rotor core in the right atrium (panel 1050), at a site indicated by the darker dot in FIG. 12 panel 1060. Notably, AF slowed within 30 seconds of energy delivery to a cycle length of 227 ms. Subsequent ablation at immediately adjacent sites, indicated by white dots in FIG. 10 panel 1050, further slowed AF until it terminated to sinus rhythm within 6 minutes' ablation as shown in FIG. 13. In FIG. 13, panels 1100 to 1120, AF can be seen to stop (panel 1110), followed by the restoration of normal sinus rhythm (labeled 1120). At this point, AF could not be restarted using the typical technique of rapid pacing as shown in FIG. 14, where panel 1210 shows rapid pacing with capture of the atrium, panel 1220 shows no induction of AF and panel 1230 shows sinus rhythm after the end of pacing.

This result is paradigm-shifting compared to the current state-of-the-art, where slowing of AF typically occurs after lengthy ablation that is widely and empirically applied (to 30-40% of the atrium), yet termination of persistent AF is still uncommon. Conversely, we acutely slowed and acutely terminated AF with ablation of less than approximately 2-3% of the atrium. Ablating only at one site identified a priori in persistent AF, and seeing immediate slowing and termination of AF is not known to have been performed previously.

Other Examples of Identification and Localization of Sources for AF

A 77 year old man presented for ablation of atrial fibrillation (AF). His history was notable for paroxysmal AF despite multiple antiarrhythmic medications, a slightly enlarged left atrium (diameter 45 mm) and normal left ventricular ejection fraction (58%). At invasive electrophysiology study, catheters were inserted into the atria as described. The invention was applied to multiple sensors. In FIG. 15 panel 900 shows a localized source in the form of an electrical rotor near the left inferior pulmonary vein. Inspection of panels from left to right (forwards in time) shows that the depolarized (activated) tissue in warmer colors (red) revolves clockwise around a core region on the medial lip of the left inferior pulmonary vein (see outline as black hourglass). Ablation at this site terminated AF acutely.

A 40 year old patient with persistent AF presented for ablation. The AF was resistant to flecainide and other antiarrhythmic medications, his left atrial diameter was 52 mm and left ventricular ejection fraction was 69%. At invasive electrophysiology study, catheters were inserted into the atria as described above. The invention was applied to multiple sensors. FIG. 15 panel 910 shows a localized source in the form of an electrical rotor in the posterior wall of the left atrium. Again, viewing panels from left to right shows that activated (depolarized) tissue revolves counter-clockwise around a core region on the posterior wall of the left atrium between the pulmonary veins. After ablation at this site, the patient remains free of AF.

A 56 year old patient with paroxysmal AF and significant symptoms presented for ablation. The AF continued despite several anti-arrhythmic medications. His left atrium was moderately enlarged. At invasive electrophysiology study, catheters were inserted into the atria as described above. The invention was applied to multiple sensors. FIG. 16 panel 1610 shows the output of a localized source in the left atrium, between the pulmonary veins although not lying at these veins. The source was repetitive (panel 1620). In panel 1630, the activation trail (1630) shows activation emanating radially from this site. In panel 1640, left atrial activation is seen to be fibrillatory (disorganized). Ablation was applied to this focal beat cause, and AF terminated acutely. At the time of filing, the patient has been completely free from AF for several months. This is a paradigm shifting because normal ablation lesions in this patient, that circle the pulmonary veins, would have missed this source. Thus, this patient would likely have been one who would have recurred after ablation, if the prior art known techniques of treating AF were used.

FIGS. 17A-17C illustrate a method of reconstructing cardiac signals associated with a complex rhythm disorder received over a plurality of channels from a patient's heart. The cardiac signals can be electrocardiogram (ECG) signals, signals from inside the heart (electrograms), representations of these signals, including magnetocardiogram signals or representations of mechanical activity (echo-cardiography, with or without Doppler), or generally any signals that represent the patient's biological rhythms. The cardiac signals can be received and recorded on a storage medium. The signals are

captured by a plurality of sensors from the patient's heart and transmitted via the channels to at least one computing device. The at least one computing device is configured to reconstruct the cardiac signals in accordance with FIGS. 17A-17C. FIGS. 17A-17C also illustrate a constituent method of determining an activation time of a beat in the complex rhythm disorder. The at least one computing device is further configured to determine the activation time of the beat in accordance with FIGS. 17A-17C.

FIG. 17A illustrates a flowchart of an example method to classify the plurality of channels according to quality of beats in signals received over the channels. The method starts at operation 100A in which a channel is selected from the plurality of the channels. A signal (or part thereof) received over the channel is retrieved. At operation 105A, one or more filters are applied to the remove baseline wander and noise from the signal. Additional filtering of the signal can be performed, such as, frequency domain filtering (e.g., band-pass, high-pass, low-pass, and/or other frequency domain filtering) and time-domain filtering (e.g., median-beat filtering, template-matching to produce correlation filtering, and/or other time-domain filtering). At operation 110A, a portion of the received signal is identified or selected as a high-confidence level representation of a beat (e.g., template beat). For example, the template beat can be selected (algorithmically, from a database, or via user interaction) with one or more attributes including but not limited to: an acceptable amplitude (signal to noise ratio > 1), an acceptable cycle length (greater than the expected rate-related action potential duration), and absence of identifiable noise that may distort its signal shape. The selected template beat is used to identify other high-confidence beats in the signal. In one embodiment, the template beat can be selected using an expert system 115A from a library of beat types according to one more criteria associated with the patient or the signal. These criteria include, but are not limited to age, gender, AF type (paroxysmal or persistent), length of AF history, AF cycle length, signal amplitude, recording location within the atria (e.g., left atrial, right atrial, coronary sinus), left ventricular ejection fraction.

At operation 120A, successive beats are identified in the signal, such as by performing template matching using the selected template beat. Alternate methods of identifying beats in the signal may also be used, including voltage above a threshold or maximum rate of change of voltage (first derivative, dV/dt) exceeding a threshold. At operation 125A, a determination is made as to whether the selected signal has an acceptable signal-to-noise ratio (SNR). The SNR is generally greater than one (1) (i.e., the signal is larger than the noise floor) but can vary depending upon sensor location and nature of the noise. For example, if the signal and noise are periodic but with different periods, then each may be separated by their different spectral characteristics. If it is determined at operation 125A that the SNR of the signal is not acceptable, the channel is marked as a non-interpretable or non-usable channel at operation 130A. Alternatively, if it is determined at operation 125A that the SNR of the signal is acceptable, the example method continues with operations 135A-175A to classify the channel as a high-confidence channel or low-confidence channel according to the beats in the signal associated with this channel.

At operation 135A, an identified beat is selected from the plurality of identified beats in the signal of the selected channel. At operation 140A, a determination is made whether the selected beat includes multiple components that could represent an activation onset (e.g., deflections), one of which can be selected as the activation onset of the selected beat. If it is

determined at operation 140A that the selected beat has multiple components, then at operation 145A the selected beat is tagged as a "Class-B" beat and an activation onset is selected in association with a component of the selected beat. A Class-B beat is one in which the activation onset cannot be determined with a high-degree of confidence, as opposed to a "Class-A" beat, which is typically monophasic (i.e., a non-complex beat in which the activation onset is not in question) in a setting of low noise and thus considered a beat having a high-degree of confidence.

Activation onset is selected based on at least one of the following: maximum dV/dt of the selected beat; template match of the beat to a template (selected automatically, or from a database based on patient type and location within the heart, or interactively by the user); amplitude of the selected beat; a comparison of the components in the selected beat to components of corresponding beats on adjacent channels; and/or another one or more selection criteria. Thereafter, the method continues at operation 150A described hereinbelow. Alternatively, if it is determined at operation 140A that the selected beat does not have multiple components that could represent activation onset (e.g., Class-A beat, as defined above (typically, a monophasic beat in an area of low noise), an activation onset is then selected and the method also continues at operation 150A as described hereinbelow.

At operation 150A, a determination is made as to whether the cycle length of the selected beat based upon the selected activation onset is acceptable. An acceptable cycle length extending from the selected activation onset is defined as ranging from the minimum (rate-related action potential duration, APD) to the maximum (defined cycle length, CL). For example, in FIG. 19C, the deflections 608A are not acceptable since they fall within the minimum rate-related APD starting from that activation onset (depicted by 606A). The maximum CL is a measurement of time from the selected activation onset to the next beat. From the observations of the inventor, the minimum rate-related APD can range from 90 to 400 ms. The maximum CL can also range from about 90 ms to 400 ms. If at operation 150A it is determined that the cycle length is acceptable the selected beat is tagged as a "Class-A" beat at operation 153.

However, if at operation 150A the determined cycle length is not acceptable, then at operations 156A, 158A, the components (deflections) of the selected beat are iterated for a predetermined number of iterations (e.g., 2 iterations) until the cycle length extending from the activation onset of a selected component is determined to be acceptable at operation 150A. Beats that are considered to be "Class-A" (from operation 140A) are not typically modified, that is, their activation onset is not altered by these operations. Thereafter, at operation 160A a next beat is selected from the selected signal and the operations 135A-160A are repeated for the selected beat, until no beats remain on the selected signal (or for a predetermined number of examined beats).

At operation 165A, a determination is made as to whether "Class-A" beats make up a predetermined percentage of a total number of beats or number of beats examined in the signal of the selected channel. The predetermined percentage can be selected to be 75% of the total beats or examined beats. It is noted that other predetermined percentages can be used. If it is determined that there is a sufficient number of Class-A beats at operation 165A, then at operation 170A, the selected channel is classified as high-confidence channel. Alternatively, if it is determined that there is not a sufficient number of Class-A beats at operation 165A, then at operation 175A, the selected channel is classified as low-confidence channel. The method continues at operation 180A, where the next

channel from the plurality of channels is selected and the operations 100A-175A are repeated for this selected channel until the plurality of channels have been classified in accordance with the example method illustrated in FIG. 17A.

FIG. 17B illustrates a flowchart of an example method to revise or update selected activation onsets of certain quality beats in signals received over the channels. Specifically, the method of FIG. 17B iterates over Class-B beats of the plurality of channels to potentially revise or update selected activation onsets. Accordingly, the method starts at operation 200A in which a channel is selected and a Class-B beat is selected in the selected channel. Once Class-B beats are processed on the selected channel, the next channel having class-B beats is selected until Class-B beats of the plurality of channels are processed (excluding channels marked as non-interpretable in operation 130A of FIG. 17A).

At operations 210A, a determination is made as to whether there are Class-A beats that correspond to the selected Class-B beat (e.g., are within a predetermined time of the Class-B beat) in channels that are adjacent to the selected channel. If at operation 210A it is determined that there are corresponding Class-A beats in the signals of adjacent channels, the method continues with operations 220A-240A. Alternatively, if at operation 210A it is determined that there is no corresponding Class-A beat in the signals of adjacent channels, the method continues at operation 250A, as described below.

At operation 220A, a vector is computed using activation onsets of the corresponding (nearby) Class-A beats to guide selection of activation onset at the selected Class-B beat. At operation 230A, the computed vector is refined based on at least one property. The computed vector is defined by channel locations surrounding the channel of interest. As shown in FIG. 19B, activation onsets are defined for the beat under consideration in each of these channels. These activation onsets are used to define a set of plausible vectors as shown in FIG. 19D (knowing the spatial location of each channel). The vector based upon these surrounding channel locations will allow the best activation onset time to be determined for the channel of interest for that beat (e.g. FIGS. 19D, 21A, 22A-22C). The vector can also be refined based on the shape or polarity change of the selected beat, or whether activation from this site is rotational (i.e., a rotor) or radial (i.e., a focal beat) which both give zero vectors at the selected Class-B beat, and/or one or more other properties. Clearly, this vector may vary from beat-to-beat (cycle-to-cycle).

At operation 240A, a time interval (i.e., acceptance window) is defined for the selected Class-B beat. The time interval indicates the earliest permissible onset of the selected Class-B beat (relative to a prior beat) and the latest permissible onset the selected Class-B beat (based upon at least one property). The properties considered or used include the vector, APD restitution, conduction velocity (CV) restitution, diastolic interval (DI), fiber angles, one or more anatomical factors, as well as one or more additional properties. Specifically, the inventor has recorded conduction velocity measurements at various atrial regions at various rates in different patient types; these conduction velocity dynamics can be used to determine if a proposed signal deflection occurs too early or too late to be conducted along the computed vector. Similarly, the inventor has recorded measurements of action potential duration rate-dynamics, based upon fiber angle orientations at multiple atrial locations, as well as anatomic factors (such as the known propensity for regions such as the crista terminalis to show conduction block).

In one embodiment, the properties can be provided via an expert system 245A from a library of properties according to

one more criteria associated with the patient (e.g., whether the patient has advanced age or a very large atrium, both of which predict slower conduction) or the signal (e.g., if the signals are relatively simple or more complex). Parameters that are considered in the expert system 245A include age, gender, whether AF is paroxysmal or persistent, blood pressure, atrial volume, left ventricular ejection fraction, presence of diabetes mellitus, and one or more other criteria. The use of DI to define an acceptance window is described in greater detail hereinbelow.

At operation 250A, the previously selected activation onset of the selected Class-B beat is revised or updated by comparison against activation onsets of selected components (deflections) of the signal of the Class-B beat that are within the acceptance window. In one embodiment, a component that is closest to the computed vector through the selected Class-B beat can be selected. In another embodiment, an expert system 255A, which stores a library of signal shapes according to one more criteria associated with the patient or the signal, can be used to select a component of the selected Class-B beat within the acceptance window. For example, age, gender and one or more other criteria can be used to classify the signal shapes in the expert system 255A. Thus, the acceptance window can be defined per beat, based on rate, location, patient demographics and/or one or more other factors.

At operation 260A, a determination is made as to whether at least two Class-A beats exist on the selected channel. If it is determined at operation 260A that at least two Class-A beats exist on the selected channel, then the method continues at operation 265A to determine a cycle length time interval between the Class-A beats (e.g., by subtracting the activation onset time of the Class-A beats). At operation 270A, the determined time interval is successively advanced along the signal of the selected channel to determine whether a deflection of the signal lies at or close to this time interval within the acceptance window. In one embodiment, the time interval can be averaged (or median used) based on successive Class-A beats, if available in the signal of the selected channel. However, if it is determined at operation 260A that no Class-A beat exists on the selected channel, then the method continues at operation 290A.

At operation 280A, the revised or updated activation onset of the selected Class-B beat is reconciled with the second activation onset of the determined time interval and assigned a reconciled activation onset. In one embodiment, a deflection (within the acceptance window) that is closest to the average of these onsets can be selected as the reconciled activation onset. Other embodiments can use the deflection closest to one of these activation times (weighted in order of importance), or other outputs from operations 145A, 250A or 270A.

At operation 290A, a next Class-B beat is selected from the signal of the selected channel and the method iterates through operations 200A-290A for the next Class-B beat. Once Class-B beats are processed on the selected channel, the next channel having class-B beats is selected until Class-B beats of the plurality of channels are processed in accordance with FIG. 17B, excluding non-interpretable channels marked in FIG. 17A.

FIG. 17C illustrates a flowchart of an example method to select final activation onsets of all beats in signals received over the plurality of channels. Specifically, the method of FIG. 17C iterates over Class-A and Class-B beats over the plurality of channels (high-confidence and low-confidence channels, excluding non-interpretable channels marked of FIG. 17A) to finalize activation onsets associated with the beats. Accordingly, the method starts at operation 300 in

which a channel is selected. At operation 310A, a beat is selected in the selected channel.

At operation 320A, a vector is computed through the selected beat and an acceptance window is defined for the selected beat, as described in operations 220A and 240A of FIG. 17B, respectively. The operations of FIG. 17C differ from the previous operations in that vectors can now be computed from Class-A beats and Class-B beats (as revised in FIG. 17B). The purpose of is to ensure that activation onsets are consistent between all Class-A beats and Class-B beats. Final adjustment of activation onsets can be made to minimize inconsistencies that now arise. In one embodiment, an expert system 325A can be used to provide one or more properties to define the acceptance window, such as APD and CV restitution, DI, and/or other properties. At operation 330A, the computed vector is refined based on at least one property. For example, the computed vector can be refined based on wavefront curvature when mapped onto the atrium, beat signal shape, known anatomic factors such as conduction block at the crista terminalis, presumed fiber angles and/or one or more other properties. In one embodiment, these factors are quantified and coded in an expert system 335A, based upon patient age, gender, whether AF is paroxysmal or persistent, blood pressure, atrial volume, left ventricular ejection fraction, presence of diabetes mellitus, and one or more other criteria. At operation 338A, activation onset is determined for the selected beat within the acceptance window where the vector crosses the selected beat.

At operation 340A a determination is made as to whether the previous activation onset of the selected beat (from FIG. 17B) is approximately equivalent (e.g., within a predetermined threshold) to the currently determined activation onset of the selected beat. If it is determined at operation 340A that the previous activation onset of the selected beat is approximately equivalent, then the method continues at operation 370A below. Alternatively, if it is determined at operation 340A that the previous activation onset of the selected beat is not approximately equivalent, the method continues at operation 350A.

At operation 350A, the previous activation onset is reconciled with the current activation onset to obtain a reconciled activation onset. In one embodiment, a deflection (within the acceptance window) that is closest to the average of these activation onsets can be selected as the reconciled activation onset. An expert system 355A can be used to provide cycle length estimates, which can be used to estimate the position of each activation onset following a specific beat, with the assumption in this case that signals demonstrate regularity at this channel. At operation 360A, a determination is made as to whether reconciliation of activation onsets was required. If at operation 360A the reconciliation was required, then at operation 363A, the tagging of the selected beat is updated to a Class-B beat. However, if at operation 360A the reconciliation was not required, then at operation 368A, the tagging of the selected beat is updated to a Class-A beat.

After operations 363A and 368A, the method continues at operation 370A in which the reconciled activation onset, determined activation onset (from operation 338A), or existing activation onset (from operation 280A or as described with reference to operations 140A and 153A for class A beats) is selected as the final activation onset for the selected beat. At operation 380, a next beat is selected on the selected channel and operations 320A-370A are iterated for the selected beat until all beats are processed on the selected channel. Once all beats are processed on the selected channel, a next channel is selected at operation 390A and operations 310A-380A are iterated for the selected channel until all channels are pro-

cessed in accordance with FIG. 17C, excluding non-interpret-
able channels marked in FIG. 17A.

The diastolic interval (DI) and action potential duration (APD) relationship can be used to identify activation onsets in a beat of a signal. In complex rhythm disorders (e.g., cardiac
fibrillation), when a signal quality is insufficient to accurately
determine an activation onset of a Class-B beat in a signal
received over a channel, activation onset of a Class-A beat in
the signal can be used along with the APD dependence on a
previous DI to estimate an acceptance window for the
Class-B beat. More specifically, an APD can be defined for
each activation cycle based on a previous DI to reconstruct
an action potential (AP) trace from the signal.

An AP reconstruction attempt is deemed to have failed
when any defined APD is less than a predefined minimum
(e.g., 90 ms) or exceeds the available cycle length (CL) within
which the APD must fit. The AP trace shown in FIG. 18
illustrates such a failure.

For example, considering the dashed lines to be selected
activation onsets and the curved vertical lines to be an APDs
in the AP reconstruction, the fifth APD has not fallen to an
acceptable level for reactivation before the next activation
onset is reached. This is deemed a reconstruction failure and
implies that the APD-DI relationship used, paired with the
initial DI used to calculate the first APD (DI seed) is not valid
for representing the real APDs. It could be that the APD-DI
relationship was incorrect, the DI seed was incorrect, or both.

If the relationship between DIs and the following APDs is
known, then a patient-specific restitution curve can be used to
check a series of selected activation onsets without perform-
ing a number of calculations through a range of values for the
constants in the DI-APD relationship. In accordance with
patient specific restitution curve, a series of activation onsets
is considered incorrect if there are no DI seeds that result in
a correctly reconstructed AP trace. When reconstructing the AP
trace, if a disproportionately high number of reconstruction
attempts (for each DI seed) fails for any low confidence
activation onset (after the first four activation onsets), that
activation onset is deemed incorrect and should be re-evalu-
ated.

A linear or logarithmic function (algorithm) can be used to
relate DI and APD. For example, the linear function can be
 $APD=C1*DI+C2$. The logarithmic function can be
 $APD=C_1*\ln(DI)+C_2$. If the constants in the relation between
DI and APD are unknown, the linear function $APD=C1*DI+$
 $C2$ can be assumed. AP reconstructions can be performed for
plausible DI seeds and for plausible constants C1 and C2. The
total number of AP reconstruction failures can be tracked for
each activation onset that is marked. A largest number of
failures in AP reconstruction are expected to occur in the first
few activation onsets, as the incorrect DI seeds and constants
will usually fail to fit the sequence within the first few acti-
vation onsets. If a disproportionately large number of failures
occur later in the AP reconstruction, then the activation onset
is considered “implausible” and marked for review and/or
further analysis.

If an assumption is made that the relation between DI and
APD is invariant for all locations in the heart, then the accu-
racy of the calculation can be improved by excluding con-
stants C1 and C2 that lead to failed trace reconstructions in
signals that have high confidence activation onsets. In this
way, the foregoing algorithm will exclude all mathematical
DI-APD relationships that are not likely to apply to the spe-
cific patient being analyzed.

FIG. 19A shows a plurality of time-varying signals 404
obtained from sensors receiving cardiac (electrical) activity
from a patient's heart during a complex rhythm disorder. The

sensors can be included in a cardiac catheter that is introduced
inside the patient or the sensors can be disposed outside the
patient. Each of the signals is represented by a signal identi-
fier, such as “A1A2”, “B3B4”, and “B5B6”. An example
snapshot or window 402A, which is indicated by a shaded
portion in FIG. 19A, represents example activity on each of
twelve (12) of the cardiac signals 404A within a specified
time period (e.g., 2 ms). The cardiac signals 402A represent
electrical cardiac activity, during a complex rhythm disorder
such as atrial fibrillation (AF), of various locations in the
atrium, at which a corresponding sensor is located. It is to be
noted that the detection of the “earliest” activation onset is
impossible through mere visual inspection of the cardiac
signals 404A shown in FIG. 19A, as there is no discernable
quiescent period in the cardiac signals 404A to enable detec-
tion of the earliest activation onset from the signals 404A.

FIG. 19B shows just that portion of electrical activity
within the window 402A shown in FIG. 19A. The vertical
lines 504A represent activation onsets for each of the time-
varying cardiac signals. As can readily be seen from the
cardiac signals shown in FIG. 19B, the activation onsets 504A
for at least the signals identified by C5C6, C7C8, and D7D8
are not well-defined. Arrows 512A define a vector that con-
nects corresponding points in adjacent time-varying cardiac
signals. As can be seen there is no discernable earliest acti-
vation onset in the signals shown in FIG. 19B. In other words,
it is not possible to simply trace activation back to the earliest
channel (that, in this example, is channel C7C8). This is
because multiple co-existing waves may exist in AF (unlike
rhythms such as supraventricular tachycardia). FIG. 19D
shows some of these potential wave directions, indicating
multiple potential wavepaths. Considerations of maximum
and minimum potential conduction velocity, and other physi-
ological properties above, will determine the wave paths that
are more or less likely to explain the observed continuous,
varying, and complex signals at each electrode.

FIG. 19C shows an expanded view of the signal identified
by C7C8 for which an activation onset cannot be determined
due to multiple deflections, and an indication of the corre-
sponding rate-adjusted activation potential duration (APD)
item 606. The rate-adjusted APD 606 indicates that signals at
this particular channel C7C8 cannot occur until near the end
of the rate-adjusted APD 606A. This fact is used to eliminate
deflections of signal C7C8 that occur within the APD 606A,
as shown by arrows 608A, and avoid counting the deflections
as activation onsets. This is because the cardiac tissue is
unable to physically reactivate for the duration of the APD
 (“repolarization”) 606A. Naturally, the actual position of the
APD 606A depends on the timing of the prior activation onset
time 610A.

FIG. 19D is a two-dimensional representation of the posi-
tions of the cardiac sensors or electrodes, which provides a
grid on the patient's atrium. The representation of points on
the grid, such as “B78”, “C56”, and “D12”, correspond to the
electrodes or sensors that are used to provide the correspond-
ing time-varying cardiac signals, such as “B7B8”, “C5C6”,
and “D1D2”, respectively, as shown in FIGS. 19A and 19B.
Thus, sensor “B78” corresponds to time-varying cardiac sig-
nal “B7B8”, and sensor “C56” corresponds to cardiac signal
“C5C6”. Arrows 714A connecting specified sensors in FIG.
19D represent the vector directed between the corresponding
locations of the patient's atrium. Thus, using only informa-
tion in the cardiac signal C5C6, the activation onset associ-
ated with signal C5C6 can be determined using non-linear
interpolation of the vector from sensors C78 to C34, the
activations for which are both known. Alternative vectors,
such as that from sensors B34 to C34 are unlikely, since they

require a conduction velocity that is too rapid to be exhibited by the cardiac tissue. Cardiac signal D7D8 is typically discarded as an un-interpretable channel or signal.

FIG. 20A shows examples of various methods for detecting beats, determining activation onsets, and disregarding noise on the time-varying cardiac signals shown in FIG. 19A. A time-varying cardiac signal from a high-confidence channel is shown as signal 802A. In order to mark or tag the activation onsets in signal 802A, a template 804A can be derived from one of the more discernible deflections (or beats) in a given time period of the signal 802A. This template 804A can then be used to detect subsequent and prior beats in signal 802A by using correlation functions, or other methods. Another method that can be used to tag activation onsets in signal 802A is shown using a rate-adapted APD 806A, which was essentially described above in reference to FIG. 19C. That is, any deflections that occur in signal 802 before the end 808A of the APD 806A, are eliminated or classified as noise since the heart tissue is physically unable to reactivate during this time. Accordingly, the deflections pointed to by arrow 810 are eliminated from being considered activation onsets. Yet another method of accurately determining activation onsets is by filtering out noise within a specified frequency range or bandwidth, as shown by arrows 812A in FIG. 20A, which is then also eliminated from consideration as activation onsets. Activation onset times are determined using a combination of template match, crossing a predetermined voltage threshold, and a maximum dV/dt, which is defined as the maximum rate of change of the voltage with respect to time or slope of the time-varying cardiac signal.

FIG. 20B shows a signal 902A from a low-confidence channel. For low-confidence channels, different templates may be used to detect various shapes of signal components or deflections. Thus, a different template could be defined and used to detect activation onsets associated with each of a plurality of different shapes identified by "A", "B", and "C" in FIG. 20B.

FIG. 20C shows a signal 1010A from a complex channel, in which the shapes of the individual beat representations vary widely from beat to beat. The vector and APD restitution methods, are among the methods described above, which may be used to determine activation onsets for this type of signal.

FIGS. 21A and 21B provide additional details to those shown in FIGS. 19B and 19D, respectively, to define a method of determining activation onsets for class B-beats using vectors. As in FIG. 19B, the short vertical lines 1102A shown in FIG. 21A represent example activation onsets determined with respect to the time-varying cardiac signals. The numbers 1104A noted in proximity to each of the vertical lines represent the time of the activation onsets for the corresponding time-varying cardiac signal relative to a given starting time. For example, the activation onset time for cardiac signal B3B4, which is provided as "37", occurs before the activation onset time for cardiac signal B1B2, which is provided as "42". FIG. 21B shows the matrix or grid of sensors denoted by identifications 1106, such as "B34", "B12", "C12", and "D12". Likely vectors are shown in FIG. 21B as arrows or lines 1108A that connect specific sensors 1106A. For example, assume that the activation onset at cardiac signal C5C6, which is denoted as a B-channel, is to be determined using vectors from surrounding channels having determinate activation onsets. From FIG. 21B, the most likely vector paths through cardiac signal C5C6 (with the unknown activation onset) is from sensor C78 to C34 since alternate paths through, such as through sensor C56, would exhibit a conduction velocity that is either too fast (such as from sensor B56 to C56), or less probable (such as a zigzag progression

through sensors B78, B56, C78, and C56) than that from sensors C78 to C34. Accordingly, the outcome of the analysis indicates that the activation onset for the cardiac signal C5C6 is derived using a vector, which is not necessarily linear, between the activation onsets associated with sensors C78 and C34, and thus cardiac signals C7C8 and C3C4, respectively.

FIGS. 22A-22C show displays of the reconstructed wave paths in fibrillation from selected activation onsets according to the method and systems described in this application. The activation onsets are provided as numbers (in units of milliseconds) arranged in a two-dimensional array or grid. The grid shown in each of FIGS. 22A-22C of numbers corresponds to the grid of cardiac sensors shown in FIGS. 19B, 19D, and 21B, and thus represents activation onset times determined by corresponding cardiac sensors at the same location. For each channel, the beat under consideration is provided with a number representing its activation onset time in milliseconds, and hence the resulting activation vector over this two-dimensional space. It is to be noted that these activation times may indicate class-A beats, or also class-B beats after initial assignment from FIG. 17B. Low-confidence channels are indicated by a question mark. The wave paths are reconstructed as spatial contours of the same or similar activation onsets. For example, in FIG. 22A, a contour line 1302A is drawn connecting two sensors with very similar activation onsets (12 ms and 11 ms) to represent a location of the wavefront at approximately 11 ms to 12 ms. Similarly, contour line 1304A is drawn to connect sensors associated with similar activation onset times (90 ms, 81 ms, and 81 ms) to represent a location of the wavefront at approximately 81 ms to 90 ms. Each of the contour lines is marked to indicate the relative time of each contour line with respect to the remaining contour lines. Accordingly, the earliest contour line will be indicated with "E", and the latest contour line, identified as line 1306A, will be indicated as "L". Arrows 1310A, 1312A indicate the direction of the vector as the wave propagates across the contour lines. Thus, FIG. 22A shows a collision of two separate vectors 1310A, 1312A. The contour lines and vectors are used to define activation onsets at the low confidence signals marked with a question mark.

In addition, activation onsets are determined using APD restitution and repolarization times as well as fiber angles (anatomic paths). For instance, if fiber angles are perpendicular to the vector of propagation at the indicated collision, this adds confidence to the results. Otherwise, another iteration may be required to ensure that activation onset times were not skewed by particular deflections in class-B channels that gave this appearance of slowing. In general, it is expected that wave propagation perpendicular to fiber angles is slower than propagation parallel to fiber angles. Fiber angles are provided from experimentation, and from known angles and anisotropy at certain locations in the atrium, such as the posterior left atrial wall and the septopulmonary bundle of Papez.

Beat shape changes or path discontinuities are shown as blue lines. In general, it is considered that inversion of the beat signal polarity indicates that the wave is passing the bipolar recording electrode in the opposite direction. This information can be used as an additional verification step to determine if wave contours did indeed alter at times of substantial beat polarity change.

Similarly, FIG. 22B shows another example display, except that the wavefront defined thereby is a rotor or rotational pattern, as indicated by the progression of contour line 1402A-1412A from "E" to "L", and an arrow 1414A.

Similarly, FIG. 22C shows an example display that represents a focal beat emanating from a central location defined

by a contour line **1502A**, which proceeds outward along the arrows **1504A** towards a contour line **1506A**.

FIG. **23A** shows a two-dimensional representation of a matrix of sensors **1602A**, which are shown as points or electrode positions superimposed on a cardiac atrial surface, indicated by the hand-drawn shape. This shape indicates the left atrium, cut horizontally through the plane of the mitral valve with the two halves folded up and down. Thus, the top portion indicates the superior mitral valve and the bottom portion indicates the inferior mitral valve.

FIG. **23B** shows time-varying cardiac signals obtained from nine (9) of the cardiac electrodes or sensors **1602A** shown in FIG. **23A**. The cardiac signals are denoted as raw signals **1702A**, since they are obtained directly, or with a minimal amount of processing or filtering, from the cardiac sensors.

FIG. **23C** shows an example display obtained from the raw signals **1702A** shown in FIG. **23B** using conventional methods known in the art. Since the display is obtained directly from the raw signals the result is a confusing map with a plurality of transient patterns that do not indicate any pattern indicative of the origin or earliest activation onset associated with the complex rhythm disorder (i.e. it does not indicate an activation trail). The display of FIG. **24A** corresponds to the grid shown in FIG. **23A**, in that locations in the grid correspond to the position of the sensors as they relate to locations in a cardiac volume. The shaded areas shown in the display represent activation onsets relative to a given start time in accordance with the scale **1802A** on the right side of the display. The gray scale **1802A** indicates the shading associated with activation onsets (e.g., in milliseconds). Thus, for example, those portions of the display that are shown in area **1804A** have an earlier activation onset time than those portions shown in area **1806A**, which are earlier than those portions shown in area **1808A**.

FIG. **23C** shows the result of tagging activation onsets for beats in each of the nine raw signals in accordance with the systems and method described herein. The activation onsets are shown as dotted lines **1902A**. Processes outlined in FIGS. **17A-17C** are used to generate the activation times for each beat in each channel indicated by vertical lines in FIG. **23C**.

FIG. **24B** shows an example display derived from the tagging of activation onset times in FIG. **23C**, in which a rotor is shown as where the red area (indicated by "R") meets the blue area (indicated by "B") via the different shades of the gray scale between these shades, as shown by arrow **2002** around a core. This core is the fulcrum around which activation rotates to create a rotor. It is to be noted that the display in FIG. **24B** clearly indicates the rotor which was undetectable from the display shown in FIG. **24A**. It is also to be noted that the precise location of the rotor core may move in space (migrate) over time, but typically remains within a small location in space ("locus").

FIG. **23D** shows a reconstruction of the activation potential duration (APD) **2102A**, which starts at the activation onsets determined in FIG. **23C** and extends for a specified time or decay thereafter. Accordingly, the APD **2102A** begins with the activation onsets **2104A** and extends until the end **2106A** of the APD.

FIG. **24C** shows a display in which the tagged activation times determined in FIG. **23C** and the reconstructed APD determined in FIG. **23D**, are used to define the intersection between a depolarization line, which is indicated by a contour line **2202A**, and a repolarization line, which is indicated by a contour line **2204A**. Specifically, each reconstructed APD time series is used as an input to the Hilbert transform. A detrending algorithm is applied to set voltages at the activa-

tion times to zero. The Hilbert transform is used to construct the phase plane of detrended signals. Then, the Hilbert transform at all electrodes is interpolated across the fine regular grid. The spatial distributions of phase are analyzed with a topological charge technique to locate phase singularities associated with the ends of wavefronts such as at the tip of a reentrant wave. Activation wavefronts are then constructed by tracking isolines of zero phase using an active-edge technique. In summary, for a snapshot in time, line **2202A** indicates the leading edge of depolarization across the tissue, and line **2204A** indicates the trailing edge of repolarization. The intersection of these lines indicates the rotor core. It has been shown by clinical reduction to practice that this rotor core is the location where targeted ablation energy may terminate and eliminate AF. Other treatments, such as delivery of a depolarizing or repolarizing current, and delivery of gene therapy or other active agents can also be applied to the locus of tissue (spatial region) where the rotor lies.

It is to be noted that these exact techniques can also reveal a focal beat, for which the activation time contours and Hilbert transform would reveal activations emanating from a focal beat origin, with subsequent disorganization if the rhythm resulting in atrial fibrillation or ventricular fibrillation (for which a treatment example is described above).

FIG. **25** is a block diagram of a computer system **2300A**. The computer system **2300A** can include a set of instructions that can be executed to cause the computer system **2300A** to perform any one or more of the methods or computer-based functions disclosed herein with respect to FIGS. **17A-24C**. The computer system **2300A** or any portion thereof, may operate as a standalone device or may be connected (e.g., using a network **2324A**) to other computer systems or devices disclosed herein with respect to FIGS. **17A-24C**. For example, the computer system **2300A** can include or be included within any one or more of the catheter, computing device, server, biological sensor, and/or any other devices or systems disclosed herein with respect to FIGS. **1-24C**.

In a networked deployment, the computer system **2300A** may operate in the capacity of a server or a client machine in a server-client network environment, or a peer machine in a peer-to-peer (or distributed) network environment. The computer system **2300A** can also be implemented as or incorporated into various devices, such as a personal computer (PC), a tablet PC, a personal digital assistant (PDA), a web appliance, a communications device, a mobile device, a server, client or any other machine capable of executing a set of instructions (sequential or otherwise) that specify actions to be taken by that machine. Further, while a single computer system **2300A** is illustrated, the term "system" shall also be taken to include any collection of systems or sub-systems that individually or jointly execute a set, or multiple sets, of instructions to perform one or more computer functions.

As illustrated in FIG. **25**, the computer system **2300A** can include a processor **2302A**, e.g., a central processing unit (CPU), a graphics-processing unit (GPU), or both. Moreover, the computer system **2300A** can include a main memory **2304A** and a static memory **2306A** that can communicate with each other via a bus **2326A**. As shown, the computer system **2300A** may further include a video display unit **2310A**, such as a liquid crystal display (LCD), an organic light emitting diode (OLED), a flat panel display, a solid state display, or a cathode ray tube (CRT). Additionally, the computer system **2300A** may include an input device **2312A**, such as a keyboard, and a cursor control device **2314A**, such as a mouse. The computer system **2300A** can also include a disk

drive unit **2316A**, a signal generation device **2322A**, such as a speaker or remote control, and a network interface device **2308A**.

In a particular embodiment, as depicted in FIG. **25**, the disk drive unit **2316A** may include a machine or computer-readable medium **2318A** in which one or more sets of instructions **2320A** (e.g., software) can be embedded. Further, the instructions **2320A** may embody one or more of the methods, functions or logic as described herein with reference to FIGS. **1-24C**. In a particular embodiment, the instructions **2320A** may reside completely, or at least partially, within the main memory **2304A**, the static memory **2306A**, and/or within the processor **2302A** during execution by the computer system **2300A**. The main memory **2304A** and the processor **2302A** also may include computer-readable media.

In an alternative embodiment, dedicated hardware implementations, such as application specific integrated circuits, programmable logic arrays and other hardware devices, can be constructed to implement one or more of the methods, functions or logic described herein. Applications that may include the apparatus and systems of various embodiments can broadly include a variety of electronic and computer systems. One or more embodiments described herein may implement functions using two or more specific interconnected hardware modules or devices with related control and data signals that can be communicated between and through the modules, or as portions of an application-specific integrated circuit. Accordingly, the present system encompasses software, firmware, and hardware implementations.

In accordance with the various embodiments, the methods, functions or logic described herein may be implemented by software programs that are tangibly embodied in a processor-readable medium and that may be executed by a processor. Further, in an example, non-limited embodiment, implementations can include distributed processing, component/object distributed processing, as well as parallel processing. Alternatively, virtual computer system processing can be constructed to implement one or more of the methods, functionality or logic as described herein.

While the computer-readable medium is shown to be a single medium, the term "computer-readable medium" includes a single medium or multiple media, such as a centralized or distributed database, and/or associated caches and servers that store one or more sets of instructions. The term "computer-readable medium" shall also include any medium that is capable of storing, encoding or carrying a set of instructions for execution by a processor or that cause a computer system to perform any one or more of the methods, functions, logic or operations disclosed herein.

In a particular non-limiting, example embodiment, the computer-readable medium can include a solid-state memory such as a memory card or other package that houses one or more non-volatile read-only memories. Further, the computer-readable medium can be a random access memory or other volatile re-writable memory. Additionally, the computer-readable medium can include a magneto-optical or optical medium, such as a disk or tapes or other storage device to capture carrier wave signals such as a signal communicated over a transmission medium. A digital file attachment to an e-mail or other self-contained information archive or set of archives may be considered a distribution medium that is equivalent to a tangible storage medium. Accordingly, the disclosure is considered to include any one or more of a computer-readable medium or a distribution medium and other equivalents and successor media, in which data or instructions may be stored.

In accordance with various embodiments, the methods, functions or logic described herein may be implemented as one or more software programs running on a computer processor. Dedicated hardware implementations including, but not limited to, application specific integrated circuits, programmable logic arrays and other hardware devices can likewise be constructed to implement the methods described herein. Furthermore, alternative software implementations including, but not limited to, distributed processing or component/object distributed processing, parallel processing, or virtual machine processing can also be constructed to implement the methods, functions or logic described herein.

It should also be noted that software which implements the disclosed methods, functions or logic may optionally be stored on a tangible storage medium, such as: a magnetic medium, such as a disk or tape; a magneto-optical or optical medium, such as a disk; or a solid state medium, such as a memory card or other package that houses one or more read-only (non-volatile) memories, random access memories, or other re-writable (volatile) memories. A digital file attachment to e-mail or other self-contained information archive or set of archives is considered a distribution medium equivalent to a tangible storage medium. Accordingly, the disclosure is considered to include a tangible storage medium or distribution medium as listed herein, and other equivalents and successor media, in which the software implementations herein may be stored.

Thus, methods, systems and apparatuses for detection, diagnosis and treatment of biological (complex) rhythm disorders have been described. Although specific example embodiments have been described, it will be evident that various modifications and changes may be made to these embodiments without departing from the broader scope of the inventive subject matter described (invention) herein. Accordingly, the specification and drawings are to be regarded in an illustrative rather than a restrictive sense. The accompanying drawings that form a part hereof, show by way of illustration, and not of limitation, specific embodiments in which the subject matter may be practiced. The embodiments illustrated are described in sufficient detail to enable those skilled in the art to practice the teachings disclosed herein. Other embodiments may be utilized and derived therefrom, such that structural and logical substitutions and changes may be made without departing from the scope of this disclosure. This Detailed Description, therefore, is not to be taken in a limiting sense, and the scope of various embodiments is defined only by the appended claims, along with the full range of equivalents to which such claims are entitled.

Such embodiments of the inventive subject matter may be referred to herein, individually and/or collectively, by the term "invention" merely for convenience and without intending to voluntarily limit the scope of this application to any single invention or inventive concept if more than one is in fact disclosed. Thus, although specific embodiments have been illustrated and described herein, it should be appreciated that any arrangement calculated to achieve the same purpose may be substituted for the specific embodiments shown. This disclosure is intended to cover any and all adaptations or variations of various embodiments. Combinations of the above embodiments, and other embodiments not specifically described herein, will be apparent to those of skill in the art upon reviewing the above description.

In the foregoing description of the embodiments, various features are grouped together in a single embodiment for the purpose of streamlining the disclosure. This method of disclosure is not to be interpreted as reflecting that the claimed embodiments have more features than are expressly recited in

each claim. Rather, as the following claims reflect, inventive subject matter lies in less than all features of a single disclosed embodiment. Thus the following claims are hereby incorporated into the Description of the Embodiments, with each claim standing on its own as a separate example embodiment.

REFERENCES

- Abreu Filho, C. A. C., L. A. F. Lisboa, et al. (2005). "Effectiveness of the Maze Procedure Using Cooled-Tip Radiofrequency Ablation in Patients with Permanent Atrial Fibrillation and Rheumatic Mitral Valve Disease." *Circulation* 112(9_suppl): 1-20-25.
- Allessie, M. A., J. Ausma, et al. (2002). "Electrical, Contractile and Structural Remodeling during Atrial Fibrillation." *Cardiovasc Res* 54(2): 230-246.
- Bardy, G. H., K. L. Lee, et al. (2005). "Amiodarone or an Implantable Cardioverter-Defibrillator for Congestive Heart Failure." *N Engl J Med* 352(3): 225-237.
- Calkins, H., J. Brugada, et al. (2007). "HRS/EHRA/ECAS expert Consensus Statement on catheter and surgical ablation of atrial fibrillation: recommendations for personnel, policy, procedures and follow-up. A report of the Heart Rhythm Society (HRS) Task Force on catheter and surgical ablation of atrial fibrillation. European Heart Rhythm Association (EHRA); European Cardiac Arrhythmia Society (ECAS); American College of Cardiology (ACC); American Heart Association (AHA); Society of Thoracic Surgeons (STS)." *Heart Rhythm* 4(6): 816-61.
- Cappato, R., H. Calkins, et al. (2005). "Worldwide Survey on the Methods, Efficacy, and Safety of Catheter Ablation for Human Atrial Fibrillation." *Circulation* 111(9): 1100-1105.
- Cappato, R., H. Calkins, et al. (2009). "Prevalence and causes of fatal outcome in catheter ablation of atrial fibrillation." *J Am Coll Cardiol* 53(19): 1798-803.
- Cheema, A., C. R. Vasamreddy, et al. (2006). "Long-term single procedure efficacy of catheter ablation of atrial fibrillation." *J Interv Card Electrophysiol* 15(3): 145-155.
- Cox, J. L. (2004). "Cardiac Surgery For Arrhythmias." *J Cardiovasc Electrophysiol*. 15: 250-262.
- Cox, J. L. (2005). "The central controversy surrounding the interventional-surgical treatment of atrial fibrillation." *J Thorac. Cardiovasc. Surg.* 129(1): 1-4.
- Ellis, E. R., S. D. Culler, et al. (2009). "Trends in utilization and complications of catheter ablation for atrial fibrillation in Medicare beneficiaries." *Heart Rhythm* 6(9): 1267-73.
- Gaspo, R., R. F. Bosch, et al. (1997). "Functional Mechanisms Underlying Tachycardia-Induced Sustained Atrial Fibrillation in a Chronic Dog Model." *Circulation* 96(11): 4027-4035.
- Kalifa, J., K. Tanaka, et al. (2006). "Mechanisms of Wave Fractionation at Boundaries of High-Frequency Excitation in the Posterior Left Atrium of the Isolated Sheep Heart During Atrial Fibrillation." *Circulation* 113(5): 626-633.
- Knecht, S., F. Sacher, et al. (2009). "Long Term Follow-Up of Idiopathic Ventricular Fibrillation Ablation: A Multicenter Study." *J Am Coll Cardiol* 54(6): 552-528.
- Masse, S., E. Downar, et al. (2007). "Ventricular fibrillation in myopathic human hearts: mechanistic insights from in vivo global endocardial and epicardial mapping." *Am J Physiol Heart Circ Physiol* 292(6): H2589-97.
- Myerburg, R. J. and A. Castellanos (2006). "Emerging paradigms of the epidemiology and demographics of sudden cardiac arrest." *Heart Rhythm* 3(2): 235-239.
- Nademanee, K., J. McKenzie, et al. (2004a). "A new approach for catheter ablation of atrial fibrillation: mapping of the electrophysiologic substrate." *J. Am. Coll. Cardiol.* (11): 2044-2053.
- Narayan, S. M., D. E. Krummen, et al. (2006d). "Evaluating Fluctuations in Human Atrial Fibrillatory Cycle Length Using Monophasic Action Potentials." *Pacing Clin Electrophysiol* 29(11): 1209-1218.
- Nash, M. P., A. Mourad, et al. (2006). "Evidence for Multiple Mechanisms in Human Ventricular Fibrillation" *Circulation* 114: 536-542.
- Ng, J., A. H. Kadish, et al. (2006). "Effect of electrogram characteristics on the relationship of dominant frequency to atrial activation rate in atrial fibrillation." *Heart Rhythm* 3(11): 1295-1305.
- Ng, J., A. H. Kadish, et al. (2007). "Technical considerations for dominant frequency analysis." *J Cardiovasc Electrophysiol* 18(7): 757-64.
- Oral, H., A. Chugh, et al. (2007). "Radiofrequency catheter ablation of chronic atrial fibrillation guided by complex electrograms." *Circulation* 115(20): 2606-12.
- Oral, H., A. Chugh, et al. (2009). "A randomized assessment of the incremental role of ablation of complex fractionated atrial electrograms after antral pulmonary vein isolation for long-lasting persistent atrial fibrillation." *J Am Coll Cardiol* 53(9): 782-9.
- Reddy, V. Y., M. R. Reynolds, et al. (2007). "Prophylactic catheter ablation for the prevention of defibrillator therapy." *N Engl J Med* 357(26): 2657-65.
- Ryu, K., S. C. Shroff, et al. (2005). "Mapping of Atrial Activation During Sustained Atrial Fibrillation in Dogs with Rapid Ventricular Pacing Induced Heart Failure: Evidence for a Role of Driver Regions." *Journal of Cardiovascular Electrophysiology* 16(12): 1348-1358.
- Sahadevan, J., K. Ryu, et al. (2004). "Epicardial Mapping of Chronic Atrial Fibrillation in Patients: Preliminary Observations." *Circulation* 110(21): 3293-3299.
- Sanders, P., O. Berenfeld, et al. (2005a). "Spectral Analysis Identifies Sites of High-Frequency Activity Maintaining Atrial Fibrillation in Humans." *Circulation* 112(6): 789-797.
- Singh, B. N., S. N. Singh, et al. (2005). "Amiodarone versus Sotalol for Atrial Fibrillation." *N Engl J Med* 352(18): 1861-1872.
- Skanes, A. C., R. Mandapati, et al. (1998). "Spatiotemporal Periodicity During Atrial Fibrillation in the Isolated Sheep Heart." *Circulation* 98(12): 1236-1248.
- Tabereaux, P. B., G. P. Walcott, et al. (2007). "Activation patterns of Purkinje fibers during long-duration ventricular fibrillation in an isolated canine heart model." *Circulation* 116(10): 1113-9.
- Vaquero, M., D. Calvo, et al. (2008). "Cardiac fibrillation: From ion channels to rotors in the human heart." *Heart Rhythm*.
- Waldo, A. L. and G. K. Feld (2008). "Inter-relationships of atrial fibrillation and atrial flutter mechanisms and clinical implications." *J Am Coll Cardiol* 51(8): 779-86.
- Warren, M., P. K. Guha, et al. (2003). "Blockade of the inward rectifying potassium current terminates ventricular fibrillation in the guinea pig heart." *J Cardiovasc Electrophysiol* 14(6): 621-31.
- Wijffels, M. C., C. J. Kirchhof, et al. (1995). "Atrial fibrillation begets atrial fibrillation: a study in awake chronically instrumented goats." *Circulation* 92: 1954-1968.

The invention claimed is:

1. A system to reconstruct cardiac information associated with a patient's heart to indicate a source of the complex rhythm disorder, the system comprising:

at least one computing device configured to:

receive cardiac information signals from a plurality of sensors spatially related with the patient's heart during the complex rhythm disorder;

classify the cardiac information signals into high and low confidence signals, wherein the high and low confidence signals are separated by a confidence threshold, the confidence threshold associated with a predetermined percentage of beats having discernible activation onsets out of total beats associated with each of the high and low confidence signals;

determine an activation onset associated with at least one low confidence signal within an acceptance time window, the acceptance time window associated with the low confidence signal indicating an earliest activation and a latest termination for a beat in the low confidence signal;

order the activation onsets associated with the high and low confidence signals to indicate the source of the complex rhythm disorder; and

treatment means for modifying the indicated source.

2. The system according to claim 1, wherein the at least one computing device determines activation onsets associated with the low confidence signals within acceptance time windows, each of the acceptance time windows associated with a low confidence signal indicating an earliest activation and a latest termination for a beat in the low confidence signal.

3. The system according to claim 1, wherein the at least one computing device orders the activation onsets based on at least one of temporal, spatial and phase information.

4. The system according to claim 1, wherein the at least one computing device determines activation onsets associated with the low confidence signals using a time vector connecting at least two discernible activation onsets of the high confidence signals associated with spatially adjacent sensors.

5. The system according to claim 1, wherein the complex rhythm disorder comprises no discernible period during which the cardiac information signals are quiescent.

6. The system according to claim 1, wherein the complex rhythm disorder comprises no discernible earliest activation onset associated with the cardiac information signals.

7. The system according to claim 1, wherein the at least one computing device classifies the cardiac information signals into the high and low confidence signals using at least one of activation onset, cycle length (CL), action potential duration (APD), and amplitude, wherein the activation onsets are determined by using at least one of maximum dV/dt , template matching, frequency and amplitude.

8. The system according to claim 1, wherein the at least one computing device determines the acceptance time window using at least one of action potential duration (APD), conduction velocity (CV), fiber angle, time vector connecting at least two discernible activation onsets of the high confidence signals associated with spatially adjacent sensors, and anatomic factors.

9. The system according to claim 1, wherein the at least one computing device removes baseline wander and noise from the cardiac information signals, the computing device filtering the cardiac information signals.

10. The system according to claim 1, wherein the at least one computing device disregards at least one of the cardiac information signals using at least one of signal-to-noise ratio (SNR), template matching, frequency and amplitude.

11. The system according to claim 6, wherein the at least one computing device performs template matching by identifying high-confidence beats associated with the cardiac information signals as templates.

12. The system according to claim 7, further comprising an expert system, the expert system performing template matching.

13. The system according to claim 1, wherein the at least one computing device classifies beats associated with the cardiac information signals based on a shape associated with the beats.

14. The system according to claim 1, wherein the at least one computing device classifies beats associated with the cardiac information signals as high confidence beats in response to a cycle length (CL) associated with the beats being greater than or equal to a minimum action potential duration (APD) and less than or equal to a maximum CL.

15. The system according to claim 1, wherein the at least one computing device classifies beats associated with the cardiac information signals as low confidence beats in response to a cycle length (CL) associated with the beats being less than a minimum action potential duration (APD) or greater than a maximum CL.

16. The system according to claim 4, wherein the at least one computing device modifies the time vector using at least one of beat shape, beat polarity, surrounding rotating emanation and radial emanation.

17. The system according to claim 1, further comprising an expert system, the expert system determining the acceptance time window using at least one of action potential duration (APD), conduction velocity (CV), time vector connecting at least two discernible activation onsets of the high confidence signals associated with spatially adjacent sensors, frequency and fiber angle.

18. The system according to claim 1, further comprising an expert system, the expert system determining activation onsets using wave shapes.

19. The system according to claim 1, wherein the at least one computing device determines activation onsets associated with the low confidence signals using at least one of rolling average and phase lock.

20. The system according to claim 1, wherein the at least one computing device determines activation onsets associated with the low confidence signals by reconciling activation onsets determined by using at least two of the vector, acceptance window, rolling average, and phase lock.

21. The system according to claim 1, wherein the system further comprises:

at least one storage device configured to store the cardiac information signals received from the patient's heart, the at least one storage device operatively coupled to the at least one computing device to provide the signals to the at least one computing device.

22. The system according to claim 1, wherein the system further comprises:

a catheter comprising a plurality of sensors to receive the cardiac information signals from the patient's heart and operatively coupled to the at least one computing device to provide the cardiac information signals to the at least one computing device.

23. The system according to claim 1, wherein the treatment means is selected from the group consisting of ablation energy, stimulation energy, drug therapy, cellular therapy and gene therapy.

24. An assembly to facilitate reconstruction of cardiac information associated with a patient's heart to indicate a source of a complex rhythm disorder, the assembly comprising:

a catheter comprising a plurality of sensors configured to provide cardiac information signals; and

a computer-readable medium operatively coupled to the sensors, the computer-readable medium comprising instructions, which when executed by a computing device, cause the computing device to reconstruct cardiac information associated with a patient's heart to indicate a source of a complex rhythm disorder by:

receiving cardiac information signals from a plurality of sensors associated spatially with the patient's heart during the complex rhythm disorder;

classifying the cardiac information signals into high and low confidence signals, wherein the high and low confidence signals are separated by a confidence threshold, the confidence threshold associated with a predetermined percentage of beats having discernible activation onsets out of total beats associated with each of the high and low confidence signals;

determining an activation onset associated with at least one low confidence signals within an acceptance time window, the acceptance time window associated with the low confidence signal indicating an earliest activation and a latest termination for a beat in the low confidence signal;

ordering the activation onsets associated with the high and low confidence signals to indicate the source of the complex rhythm disorder; and treatment means for modifying the indicated source.

25. The assembly according to claim 24, wherein the computer-readable medium comprises instructions, which when executed by a computing device, cause the computing device to determine activation onsets associated with the low confidence signals within acceptance time windows, each of the acceptance time windows associated with a low confidence signal indicating an earliest activation and a latest termination for a beat in the low confidence signal.

26. The assembly according to claim 24, wherein the computer-readable medium comprises instructions, which when executed by a computing device, cause the computing device to order the activation onsets based on at least one of temporal, spatial and phase information.

27. The assembly according to claim 24, wherein the computer-readable medium comprises instructions, which when executed by a computing device, cause the computing device to reconstruct cardiac information associated with a patient's heart to indicate a source of the complex rhythm disorder by determining activation onsets associated with the low confidence signals using a time vector connecting at least two discernible activation onsets of the high confidence signals associated with spatially adjacent sensors.

28. The assembly according to claim 24, wherein the complex rhythm disorder comprises no discernible period during which the cardiac information signals are quiescent.

29. The assembly according to claim 24, wherein the complex rhythm disorder comprises no discernible earliest activation onset associated with the cardiac information signals.

30. The assembly according to claim 24, wherein the computer-readable medium comprises instructions, which when executed by a computing device, cause the computing device to reconstruct cardiac information associated with a patient's heart to indicate a source of the complex rhythm disorder by classifying the cardiac information signals into the high and low confidence signals using at least one of activation onset,

cycle length (CL), action potential duration (APD), and amplitude, wherein the activation onsets are determined by using at least one of maximum dV/dt , template matching, frequency and amplitude.

31. The assembly according to claim 24, wherein the computer-readable medium comprises instructions, which when executed by a computing device, cause the computing device to reconstruct cardiac information associated with a patient's heart to indicate a source of the complex rhythm disorder by determining the acceptance time window using at least one of action potential duration (APD), conduction velocity (CV), fiber angle, time vector connecting at least two discernible activation onsets of the high confidence signals associated with spatially adjacent sensors, and anatomic factors.

32. The assembly according to claim 24, wherein the computer-readable medium comprises instructions, which when executed by a computing device, cause the computing device to reconstruct cardiac information associated with a patient's heart to indicate a source of the complex rhythm disorder by: removing baseline wander and noise from the cardiac information signals; and filtering the cardiac information signals.

33. The assembly according to claim 24, wherein the computer-readable medium comprises instructions, which when executed by a computing device, cause the computing device to reconstruct cardiac information associated with a patient's heart to indicate a source of the complex rhythm disorder by disregarding at least one of the cardiac information signals using at least one of signal-to-noise ratio (SNR), template matching, frequency and amplitude.

34. The assembly according to claim 30, wherein the computer-readable medium comprises instructions, which when executed by a computing device, cause the computing device to reconstruct cardiac information associated with a patient's heart to indicate a source of the complex rhythm disorder by template matching by identifying high-confidence level beats associated with the cardiac information signals as templates.

35. The assembly according to claim 30, wherein the computer-readable medium comprises instructions, which when executed by a computing device, cause the computing device to reconstruct cardiac information associated with a patient's heart to indicate a source of the complex rhythm disorder by template matching using an expert system, the expert system using beat types to perform template matching.

36. The assembly according to claim 24, wherein the computer-readable medium comprises instructions, which when executed by a computing device, cause the computing device to reconstruct cardiac information associated with a patient's heart to indicate a source of the complex rhythm disorder by classifying beats associated with the cardiac information signals based on a shape associated with the beats.

37. The assembly according to claim 24, wherein the computer-readable medium comprises instructions, which when executed by a computing device, cause the computing device to reconstruct cardiac information associated with a patient's heart to indicate a source of the complex rhythm disorder by classifying beats associated with the cardiac information signals as high confidence beats in response to a cycle length (CL) associated with the beats being greater than or equal to a minimum action potential duration (APD) and less than or equal to a maximum CL.

38. The assembly according to claim 24, wherein the computer-readable medium comprises instructions, which when executed by a computing device, cause the computing device to reconstruct cardiac information associated with a patient's heart to indicate a source of the complex rhythm disorder by classifying beats associated with the cardiac information sig-

nals as low confidence beats in response to a cycle length (CL) associated with the beats being less than a minimum action potential duration (APD) or greater than a maximum CL.

39. The assembly according to claim 27, wherein the computer-readable medium comprises instructions, which when executed by a computing device, cause the computing device to reconstruct cardiac information associated with a patient's heart to indicate a source of the complex rhythm disorder by modifying the time vector using at least one of beat shape, beat polarity, surrounding rotating emanation and radial emanation.

40. The assembly according to claim 24, wherein the computer-readable medium comprises instructions, which when executed by a computing device, cause the computing device to reconstruct cardiac information associated with a patient's heart to indicate a source of the complex rhythm disorder by determining the acceptance time window using an expert system, the expert system using at least one of action potential duration (APD), conduction velocity (CV), time vector connecting at least two discernible activation onsets of the high confidence signals associated with spatially adjacent sensors, frequency and fiber angle.

41. The assembly according to claim 24, wherein the computer-readable medium comprises instructions, which when executed by a computing device, cause the computing device to reconstruct cardiac information associated with a patient's heart to indicate a source of the complex rhythm disorder by determining activation onsets using an expert system, the expert system comprising wave shapes.

42. The assembly according to claim 24, wherein the computer-readable medium comprises instructions, which when executed by a computing device, cause the computing device to reconstruct cardiac information representing a complex rhythm disorder associated with a patient's heart to indicate a source of the complex rhythm disorder by determining activation onsets associated with the low confidence signals using at least one of rolling average and phase lock.

43. The assembly according to claim 24, wherein the computer-readable medium comprises instructions, which when executed by a computing device, cause the computing device to reconstruct cardiac information representing a complex rhythm disorder associated with a patient's heart to indicate a source of the complex rhythm disorder by determining activation onsets associated with the low confidence signals using at least two of the vector, acceptance window, rolling average, and phase lock.

44. The assembly according to claim 24, wherein the treatment means is selected from the group consisting of ablation energy, stimulation energy, drug therapy, cellular therapy and gene therapy.

45. A method of reconstructing cardiac information associated with a patient's heart to indicate a source of a complex rhythm disorder, the method comprising a computing device: receiving cardiac information signals associated with a plurality of sensors spatially related with the patient's heart;

classifying, by the computing device, the cardiac information signals into high and low confidence signals, wherein the high and low confidence signals are separated by a confidence threshold, the confidence threshold associated with a predetermined percentage of beats having discernible activation onsets out of total beats associated with each of the high and low confidence signals;

determining, by the computing device, an activation onset associated with at least one low confidence signal within an acceptance time window, the acceptance time win-

dow associated with the low confidence signal indicating an earliest activation and a latest termination for a beat in the low confidence signal;

ordering, by the computing device, the activation onsets associated with the high and low confidence signals to indicate the source of the complex rhythm disorder; and applying a treatment means to modify the indicated source.

46. The method according to claim 45, wherein determining further comprises the computing device determining activation onsets associated with the low confidence signals within acceptance time windows, each of the acceptance time windows associated with a low confidence signal indicating an earliest activation and a latest termination for a beat in the low confidence signal.

47. The method according to claim 45, wherein ordering further comprises the computing device ordering the activation onsets based on at least one of temporal, spatial and phase information.

48. The method according to claim 45, wherein determining further comprises the computing device determining activation onsets associated with the low confidence signals using a time vector connecting at least two discernible activation onsets of the high confidence signals associated with spatially adjacent sensors.

49. The method according to claim 45, wherein the complex rhythm disorder comprises no discernible period during which the cardiac information signals are quiescent.

50. The method according to claim 45, wherein the complex rhythm disorder comprises no discernible earliest activation onset associated with the cardiac information signals.

51. The method according to claim 45, wherein classifying further comprises the computing device using at least one of activation onset, cycle length (CL), action potential duration (APD), and amplitude to classify the cardiac information signals into the high and low confidence signals, wherein the activation onsets are determined by using at least one of maximum dV/dt, template matching, frequency and amplitude.

52. The method according to claim 45, wherein the acceptance time window is determined using at least one of action potential duration (APD), conduction velocity (CV), fiber angle, time vector connecting at least two discernible activation onsets of the high confidence signals associated with spatially adjacent sensors, and anatomic factors.

53. The method according to claim 45, further comprising the computing device:

removing baseline wander and noise from the cardiac information signals; and filtering the cardiac information signals.

54. The method according to claim 45, further comprising the computing device disregarding at least one of the cardiac information signals using at least one of signal-to-noise ratio (SNR), template matching, frequency and amplitude.

55. The method according to claim 51, wherein template matching further comprises the computing device identifying high-confidence beats associated with the cardiac information signals as templates.

56. The method according to claim 51, wherein template matching is performed using an expert system, the expert system using beat types to perform template matching.

57. The method according to claim 45, further comprising the computing device classifying beats associated with the cardiac information signals based on a shape associated with the beats.

58. The method according to claim 45, wherein classifying the cardiac information signals further comprises the computing device classifying beats associated with the cardiac

53

information signals as high confidence beats in response to a cycle length (CL) associated with the beats being greater than or equal to a minimum action potential duration (APD) and less than or equal to a maximum CL.

59. The method according to claim 48, further comprising the computing device modifying the time vector using at least one of beat shape, beat polarity, surrounding rotating emanation and radial emanation.

60. The method according to claim 45, wherein classifying the cardiac information signals further comprises the computing device classifying beats associated with the cardiac information signals as low confidence beats in response to a cycle length (CL) associated with the beats being less than a minimum action potential duration (APD) or greater than a maximum CL.

61. The method according to claim 45, wherein determining the acceptance time window further comprises using an expert system, the expert system using at least one of action potential duration (APD), conduction velocity (CV), time vector connecting at least two discernible activation onsets of the high confidence signals associated with spatially adjacent sensors, frequency and fiber angle.

62. The method according to claim 45, wherein determining activation onsets further comprises using an expert system, the expert system comprising wave shapes.

63. The method according to claim 45, wherein determining activation onsets associated with the low confidence signals further comprises determining activation onsets using at least one of rolling average and phase lock.

64. The method according to claim 45, wherein determining activation onsets associated with the low confidence signals further comprises reconciling activation onsets determined by using at least two of the vector, acceptance window, rolling average, and phase lock.

54

65. The method according to claim 45, wherein the treatment means is selected from the group consisting of ablation energy, stimulation energy, drug therapy, cellular therapy and gene therapy.

66. A system to reconstruct cardiac information associated with a patient's heart to indicate a source of the complex rhythm disorder, the system comprising:

at least one computing device configured to:

receive cardiac information signals from a plurality of sensors spatially related with the patient's heart during the complex rhythm disorder,

classify the cardiac information signals into high and low confidence signals, wherein the high and low confidence signals are separated by a confidence threshold, the confidence threshold associated with a predetermined percentage of beats having discernible activation onsets out of total beats associated with each of the high and low confidence signals;

determine an activation onset associated with at least one low confidence signal within an acceptance time window, the acceptance time window associated with the low confidence signal indicating an earliest activation and a latest termination for a beat in the low confidence signal;

order the activation onsets associated with the high and low confidence signals; and

output the activation onsets associated with the high and low confidence signals as ordered to indicate the source of the complex cardiac rhythm disorder; and a device configured to administer treatment at the indicated source.

67. The system of claim 66, wherein treatment is one of ablation, pacing, drug therapy, cellular therapy, and gene therapy.

* * * * *

专利名称(译)	用于检测生物节律紊乱的方法和系统		
公开(公告)号	US8868169	公开(公告)日	2014-10-21
申请号	US14/137929	申请日	2013-12-20
[标]申请(专利权)人(译)	NARAYAN桑吉夫 SEHRA RUCHIR		
申请(专利权)人(译)	NARAYAN, 桑吉夫 SEHRA, RUCHIR		
当前申请(专利权)人(译)	加利福尼亚大学董事会 TOPERA INC. 美洲的美国为代表的退伍军人事务署		
[标]发明人	NARAYAN SANJIV SEHRA RUCHIR		
发明人	NARAYAN, SANJIV SEHRA, RUCHIR		
IPC分类号	A61B5/0464 A61B5/0452 A61B5/046 A61B5/0456 A61B5/042 A61B5/0472 A61B5/00		
CPC分类号	A61B5/0472 A61B5/0456 A61B5/726 A61B5/046 A61B5/0464 A61B5/0422 A61B5/0452 A61B5/04012 A61B5/7221 A61B5/0255 A61B5/04011 A61B5/0432 A61B5/044 A61B5/4857 A61B5/6852 A61B5/7264 A61B5/7278		
代理人(译)	作乐, 埃莉诺M.		
助理审查员(译)	CAREY, MICHAEL		
优先权	61/342016 2010-04-08 US		
其他公开文献	US20140114204A1		
外部链接	Espacenet USPTO		

摘要(译)

提供系统，组件和方法以便于重建表示与患者心脏相关的复杂节律紊乱的心脏信息，以指示心律紊乱的来源。可以通过施加能量来治疗复杂的节律紊乱以改变节律紊乱的来源。

