



US 20140247156A1

(19) **United States**  
(12) **Patent Application Publication**  
**Proud**

(10) **Pub. No.: US 2014/0247156 A1**  
(43) **Pub. Date: Sep. 4, 2014**

(54) **USER OR PATIENT MONITORING METHODS USING ONE OR MORE ANALYSIS TOOLS**

Continuation-in-part of application No. 13/923,543, filed on Jun. 21, 2013, Continuation-in-part of application No. 13/923,937, filed on Jun. 21, 2013.

(71) Applicant: **Hello Inc.**, San Francisco, CA (US)

(60) Provisional application No. 61/772,265, filed on Mar. 4, 2013, provisional application No. 61/823,502, filed on May 15, 2013.

(72) Inventor: **James Proud**, San Francisco, CA (US)

(73) Assignee: **Hello Inc.**, San Francisco, CA (US)

**Publication Classification**

(21) Appl. No.: **13/961,599**

(51) **Int. Cl.**  
**A61B 5/00** (2006.01)

(22) Filed: **Aug. 7, 2013**

(52) **U.S. Cl.**  
CPC ..... **A61B 5/0015** (2013.01)  
USPC ..... **340/870.16; 340/870.01**

**Related U.S. Application Data**

(63) Continuation-in-part of application No. 13/923,909, filed on Jun. 21, 2013, Continuation-in-part of application No. 13/923,637, filed on Jun. 21, 2013, Continuation-in-part of application No. 13/923,614, filed on Jun. 21, 2013, Continuation-in-part of application No. 13/923,809, filed on Jun. 21, 2013, Continuation-in-part of application No. 13/923,750, filed on Jun. 21, 2013, Continuation-in-part of application No. 13/923,583, filed on Jun. 21, 2013, Continuation-in-part of application No. 13/923,560, filed on Jun. 21, 2013,

(57) **ABSTRACT**

A method is provided for using telemetry data based on user habit information or user monitoring. One or more sensors of a monitoring device detects or measures user information selected from of at least one of, a user's activities, behaviors and habit information, and a user's health. The user information is received at a telemetry system with a database. One or more analysis tools at the telemetry system are used for the analysis. Analysis information is produced that is sent to the monitoring device.

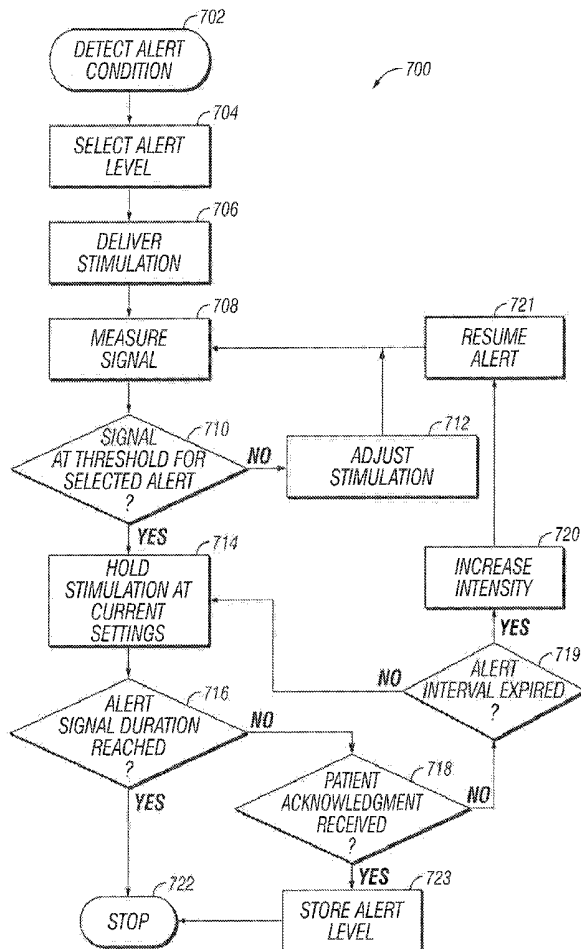

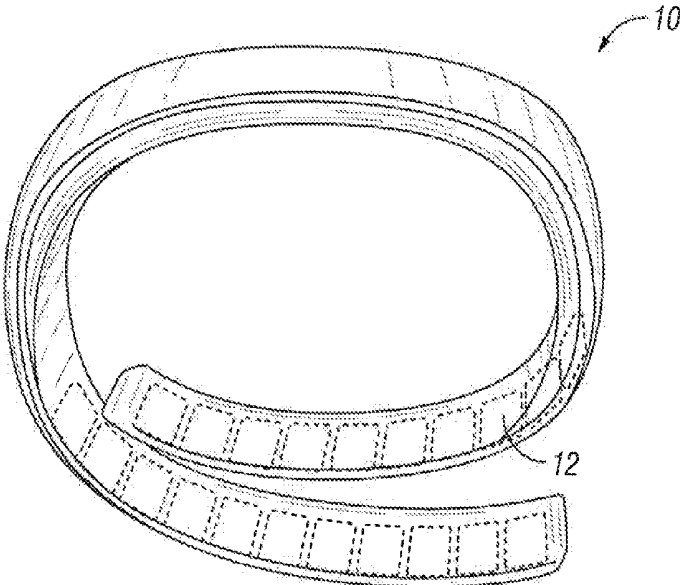

FIG. 1A

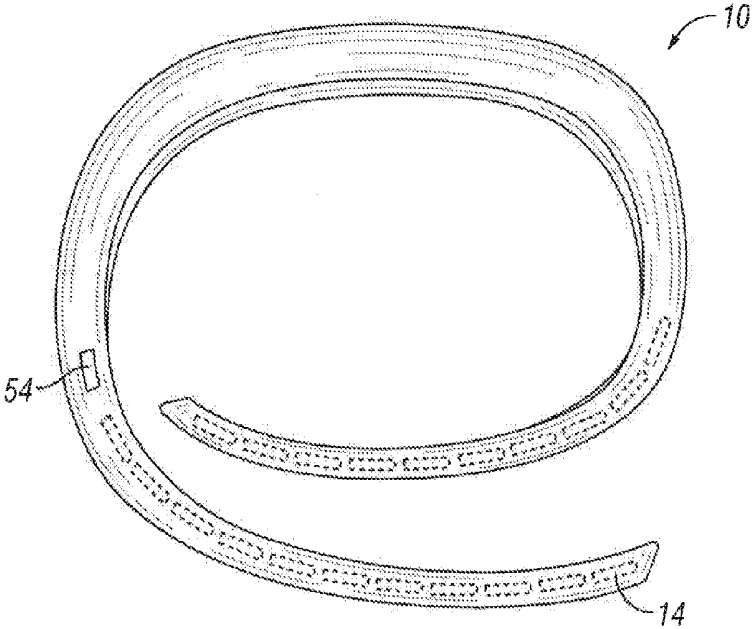

FIG. 1B

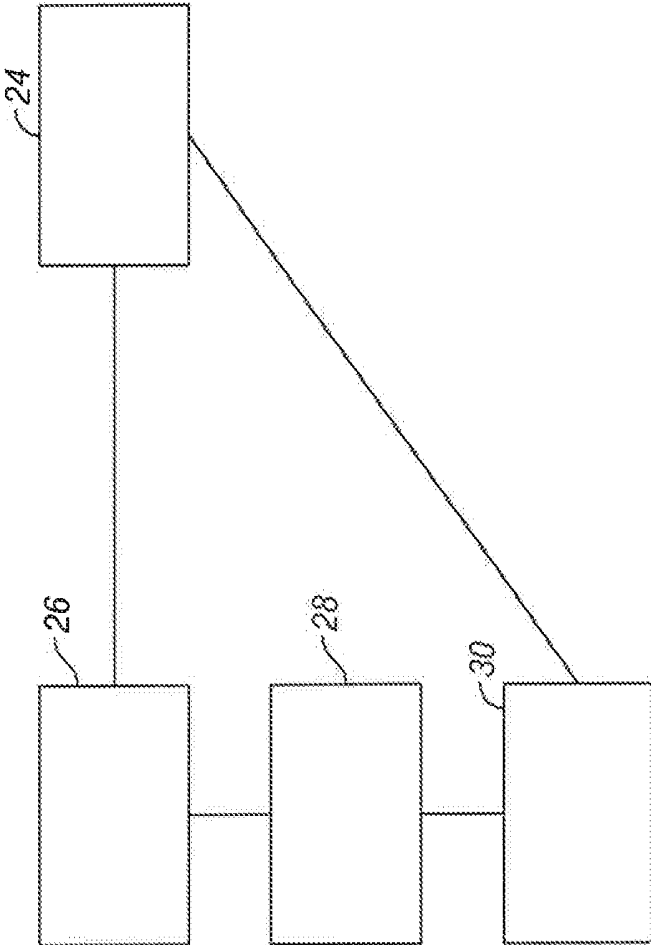

FIG. 2

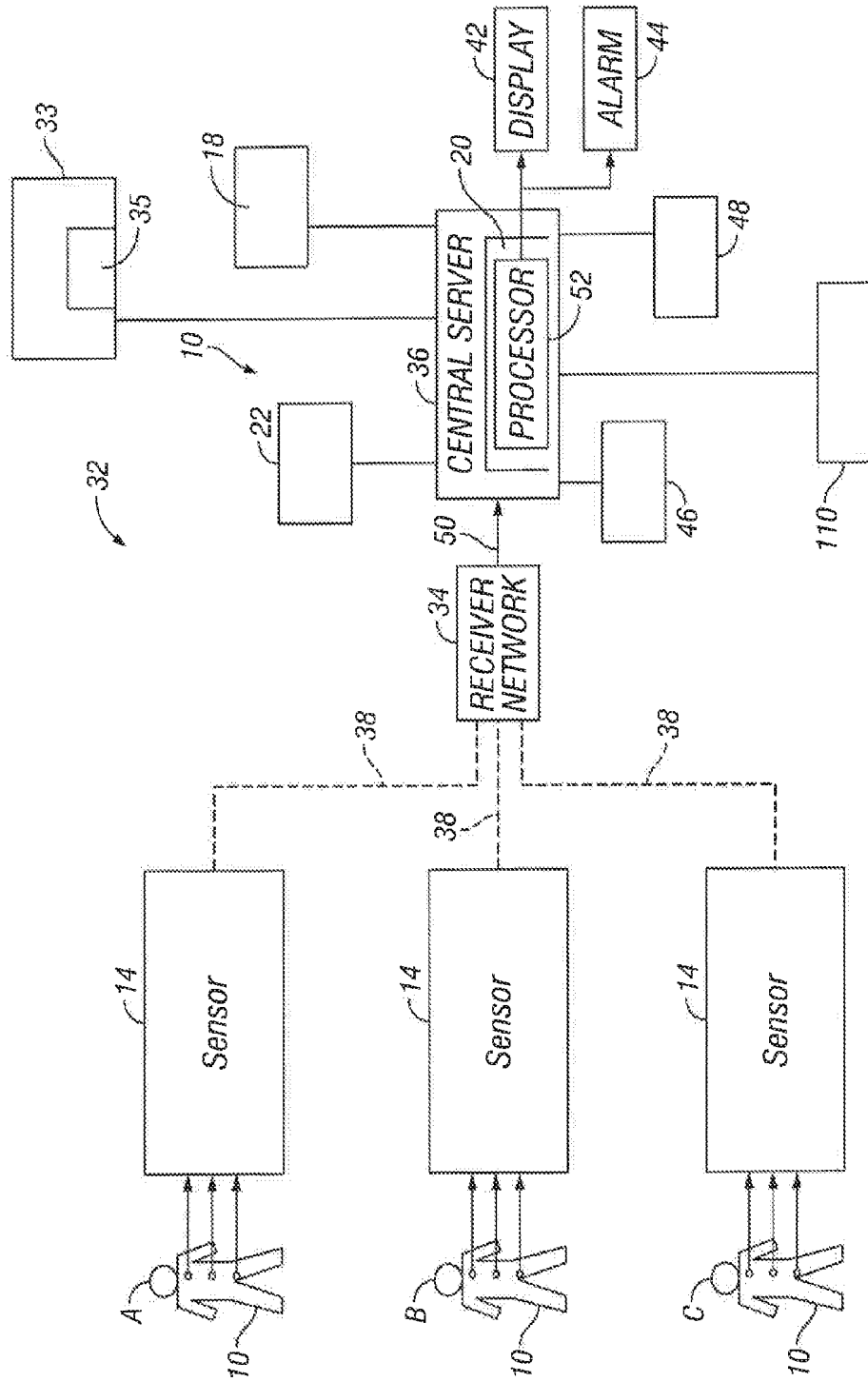

FIG. 3

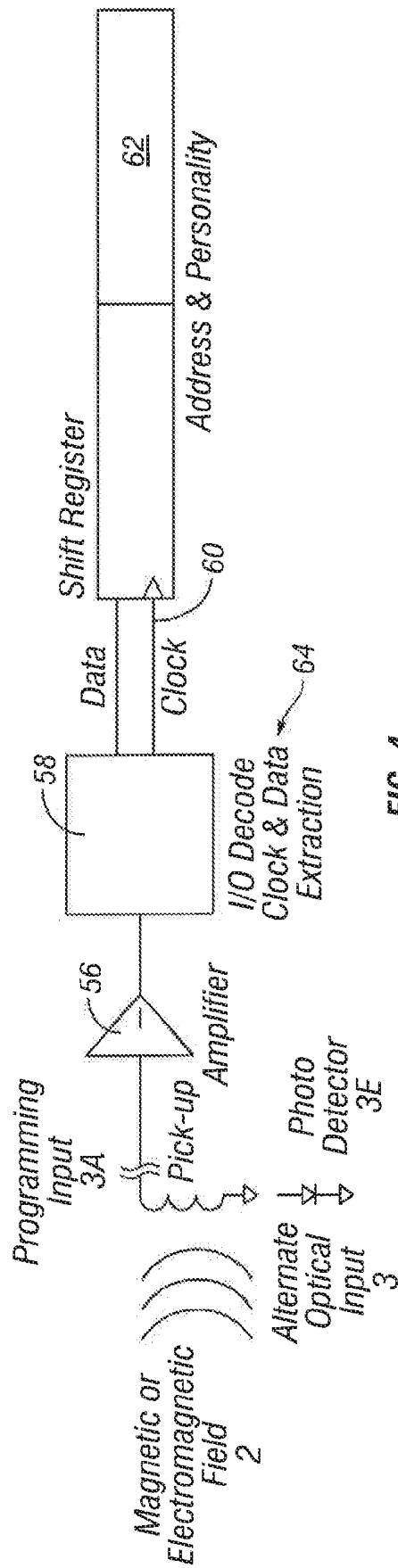

FIG. 4

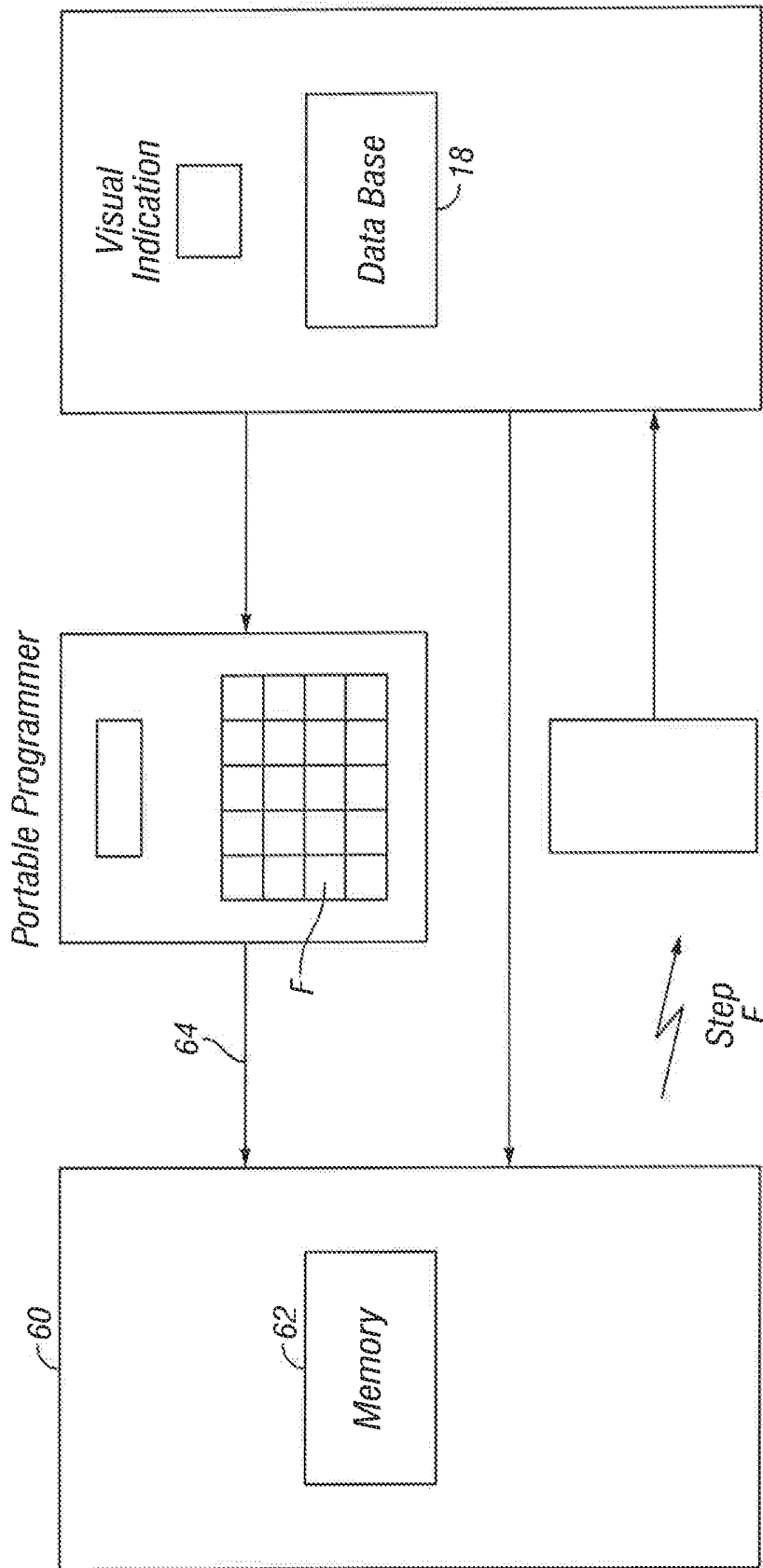

FIG. 5

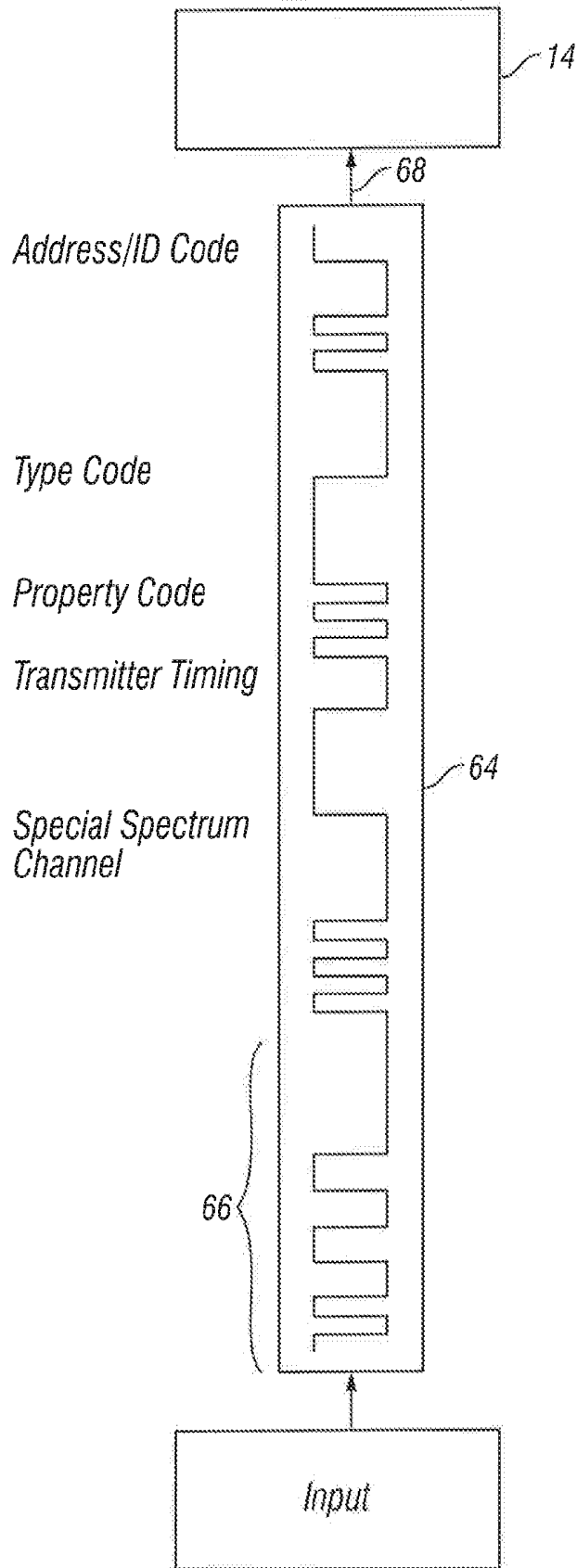

FIG. 6

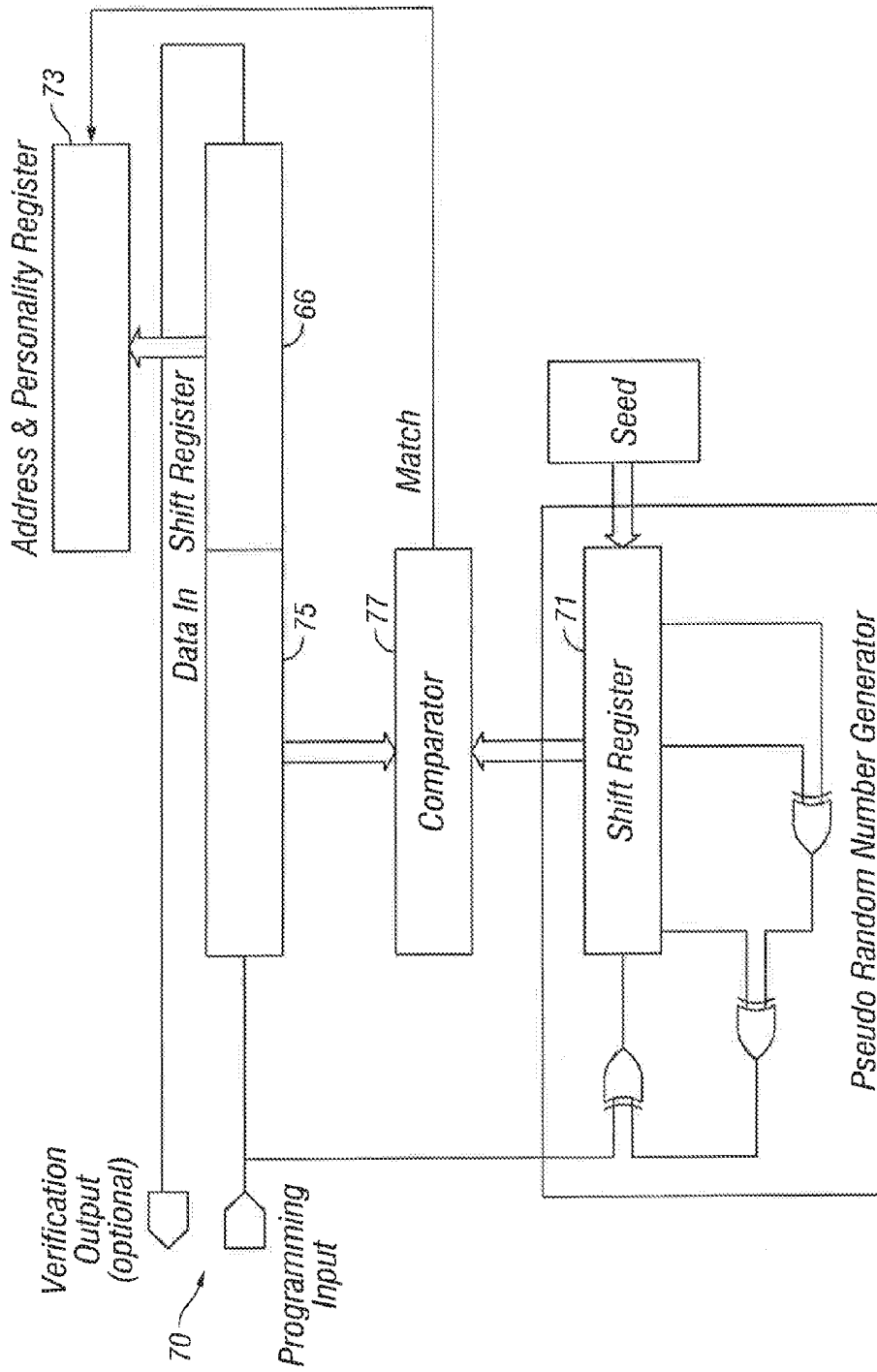

FIG. 7

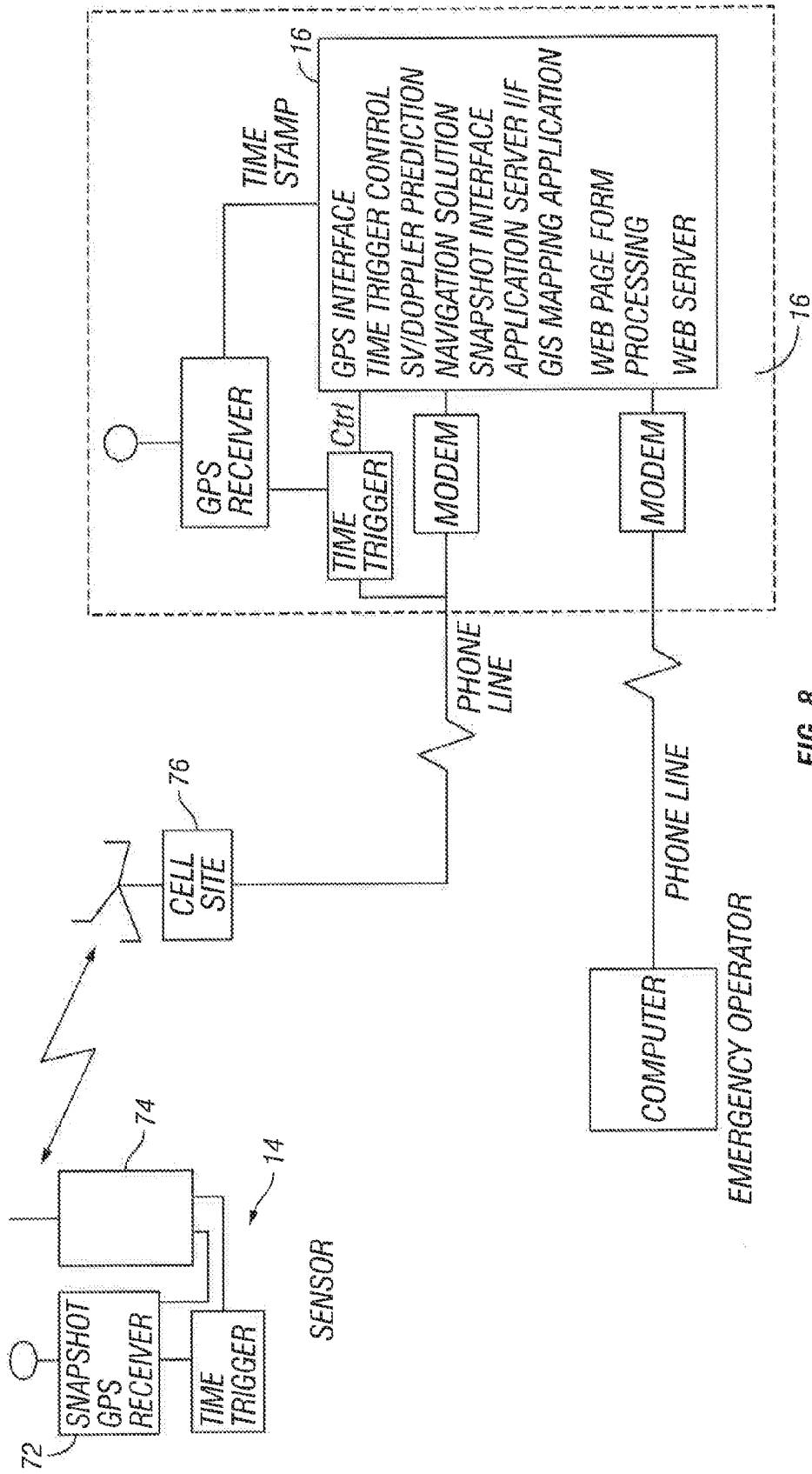

FIG. 8

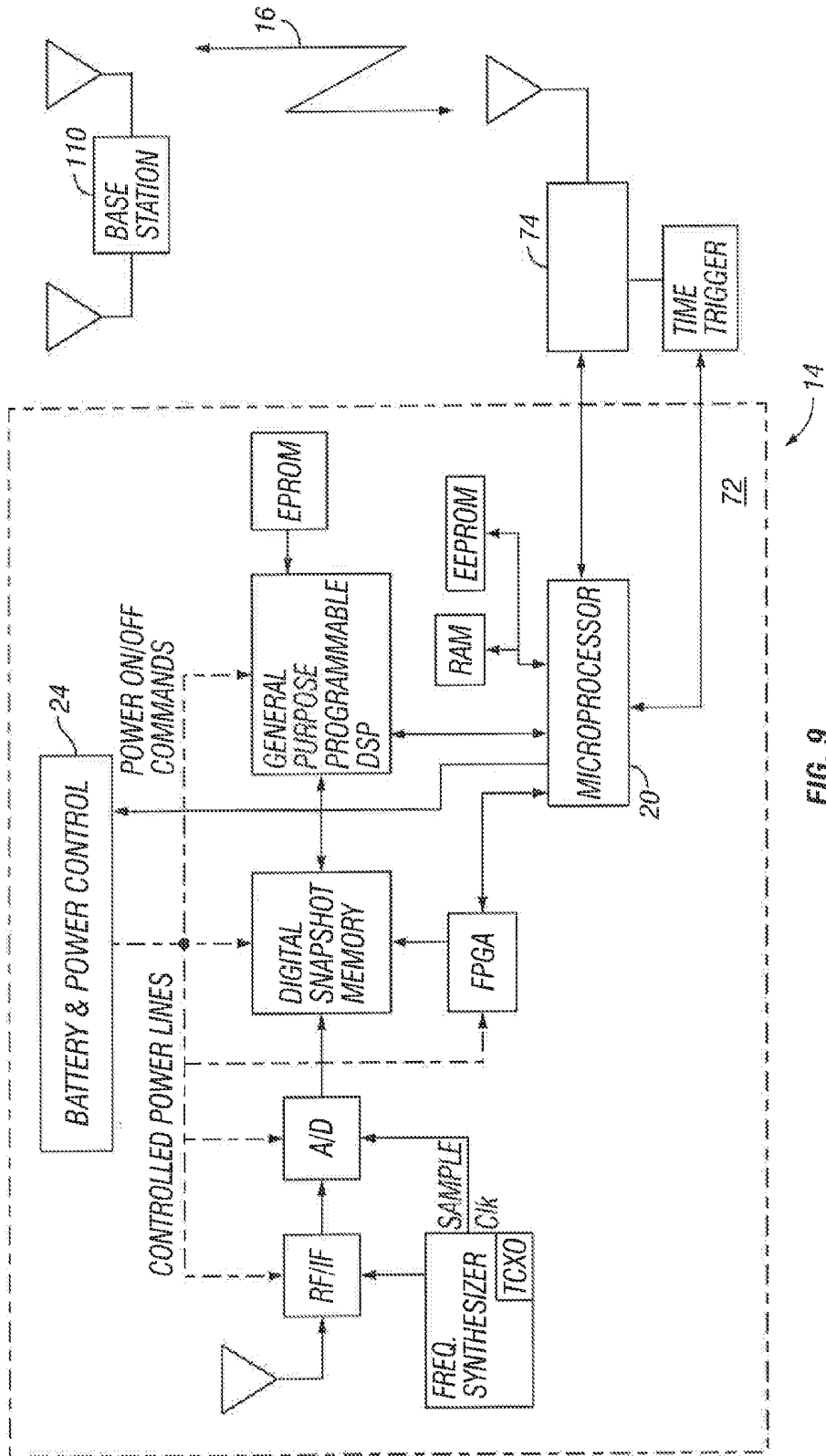

FIG. 9

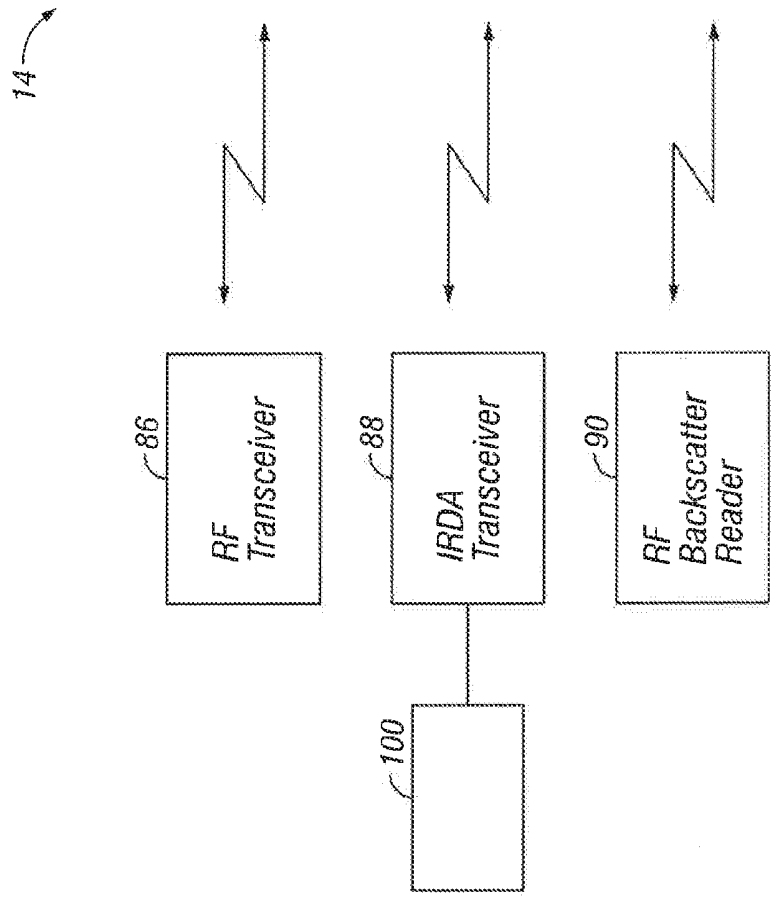
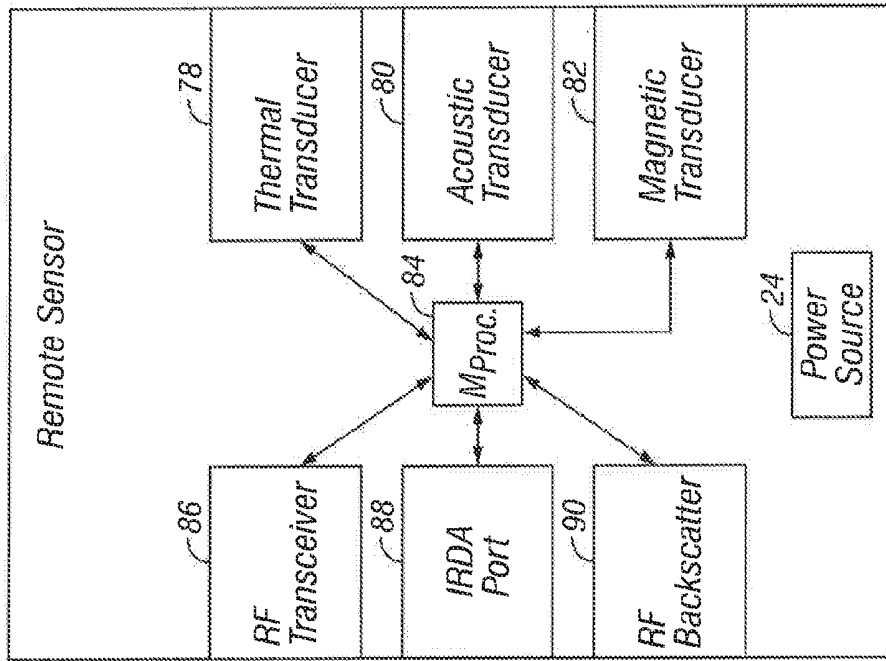

FIG. 10

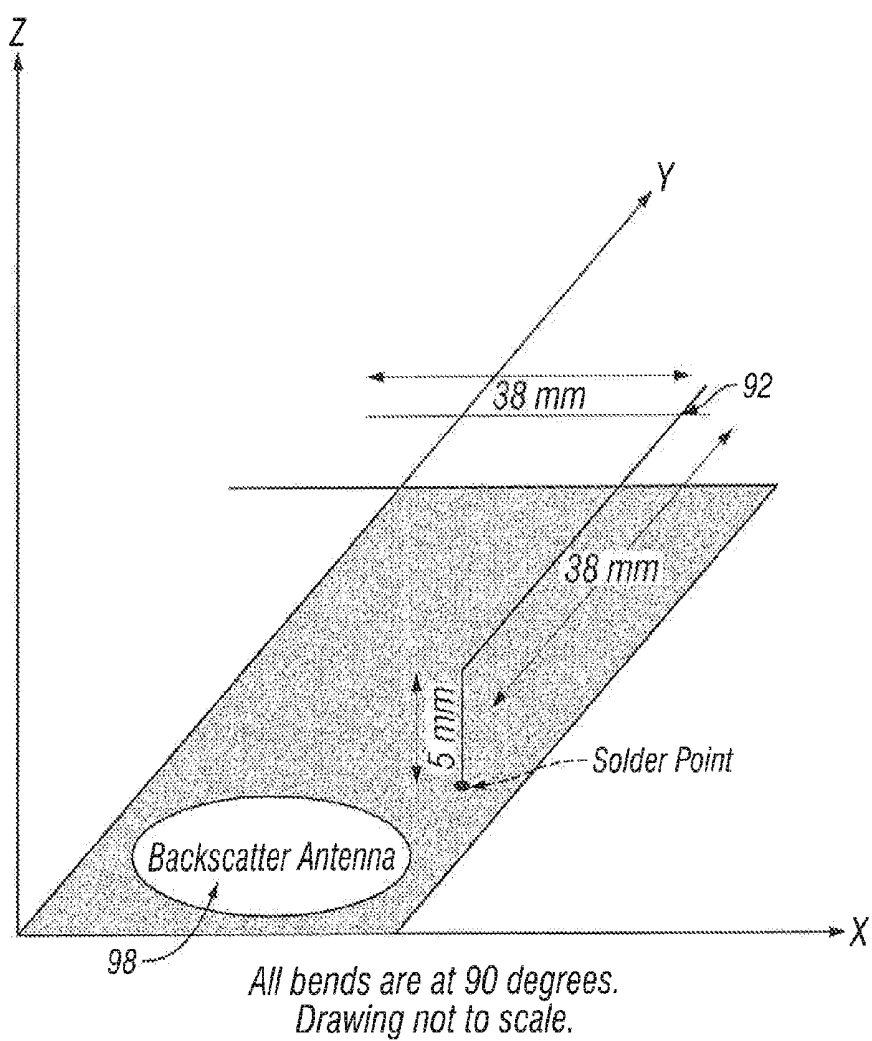

FIG. 11

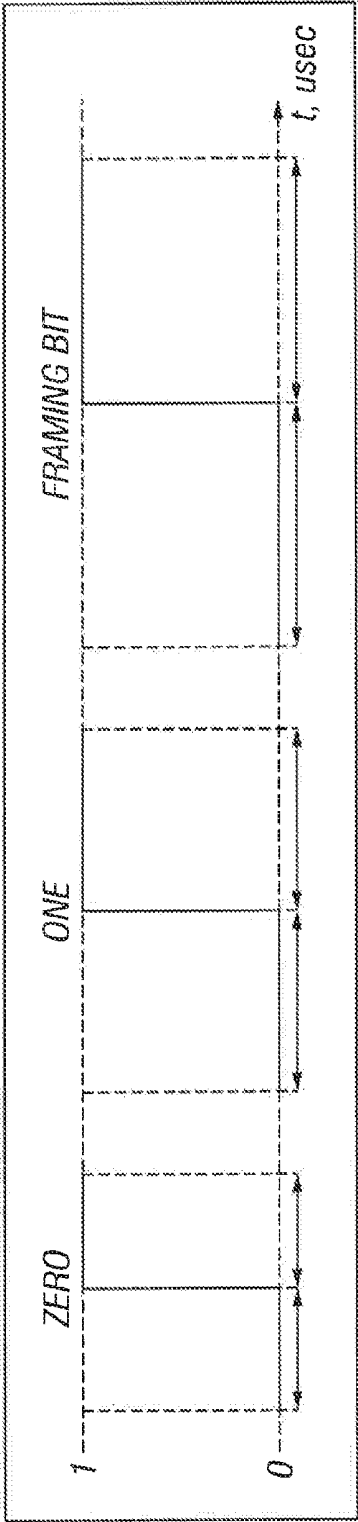

FIG. 12

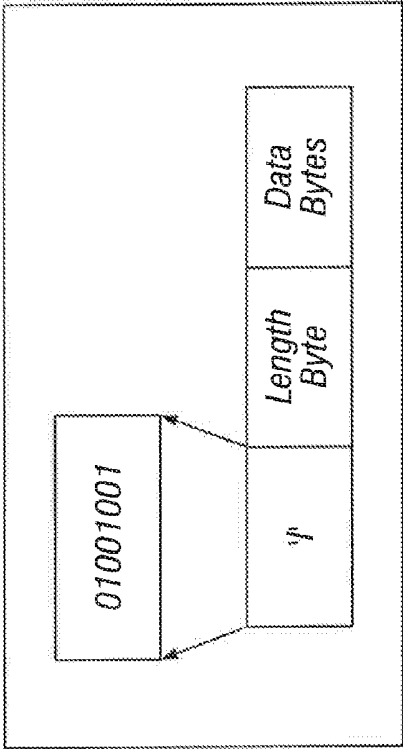

FIG. 13

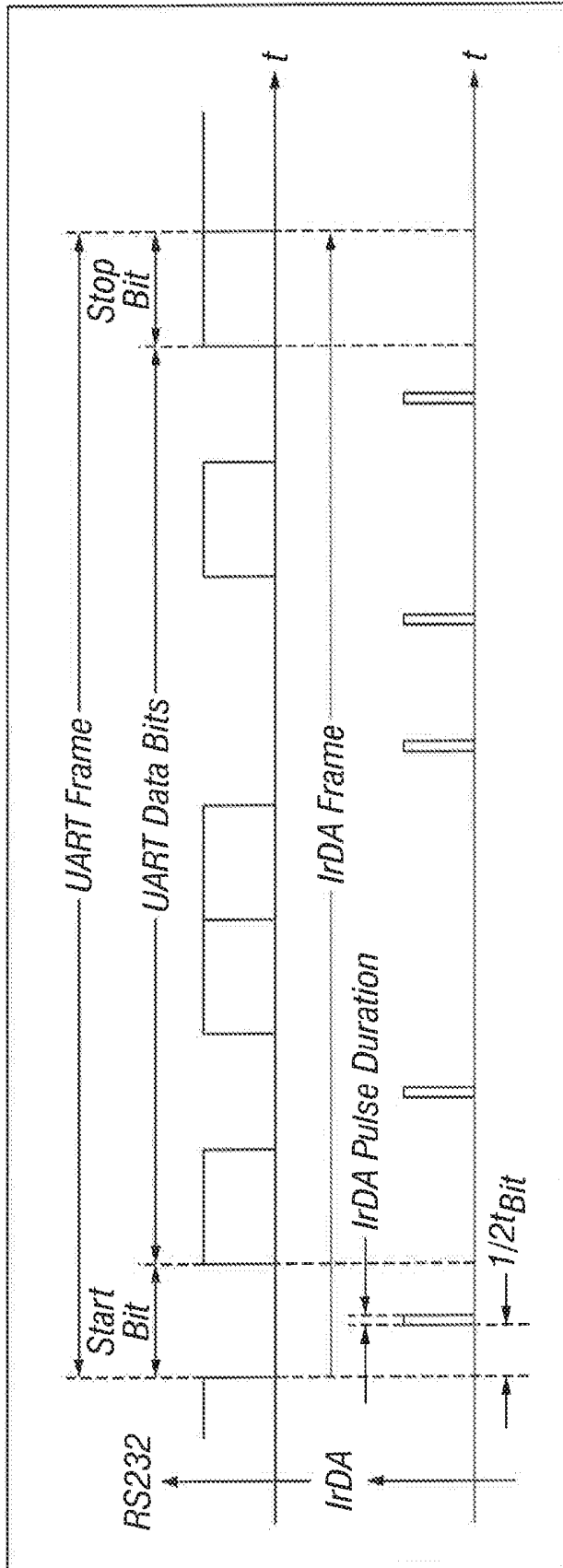

FIG. 14

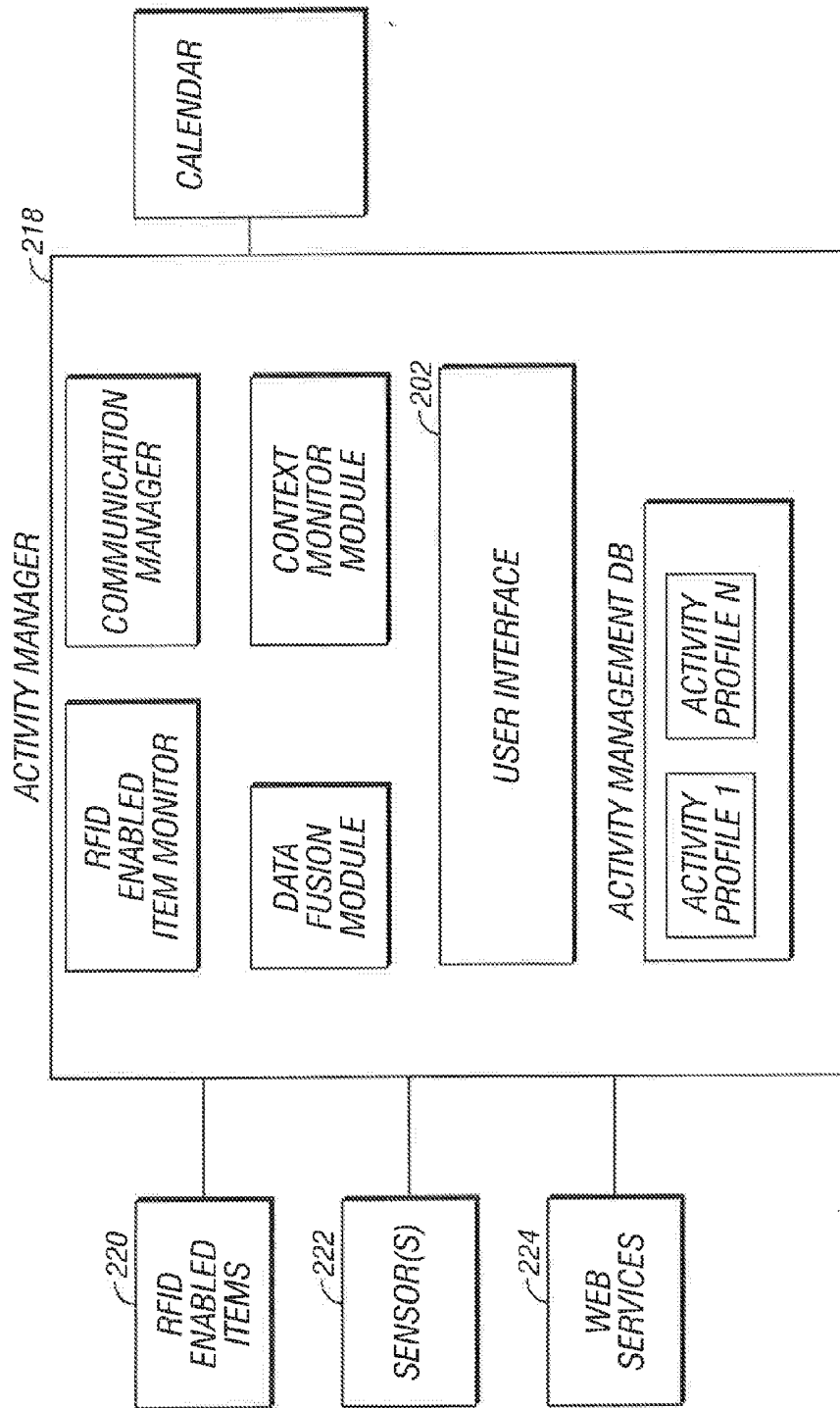

FIG. 15

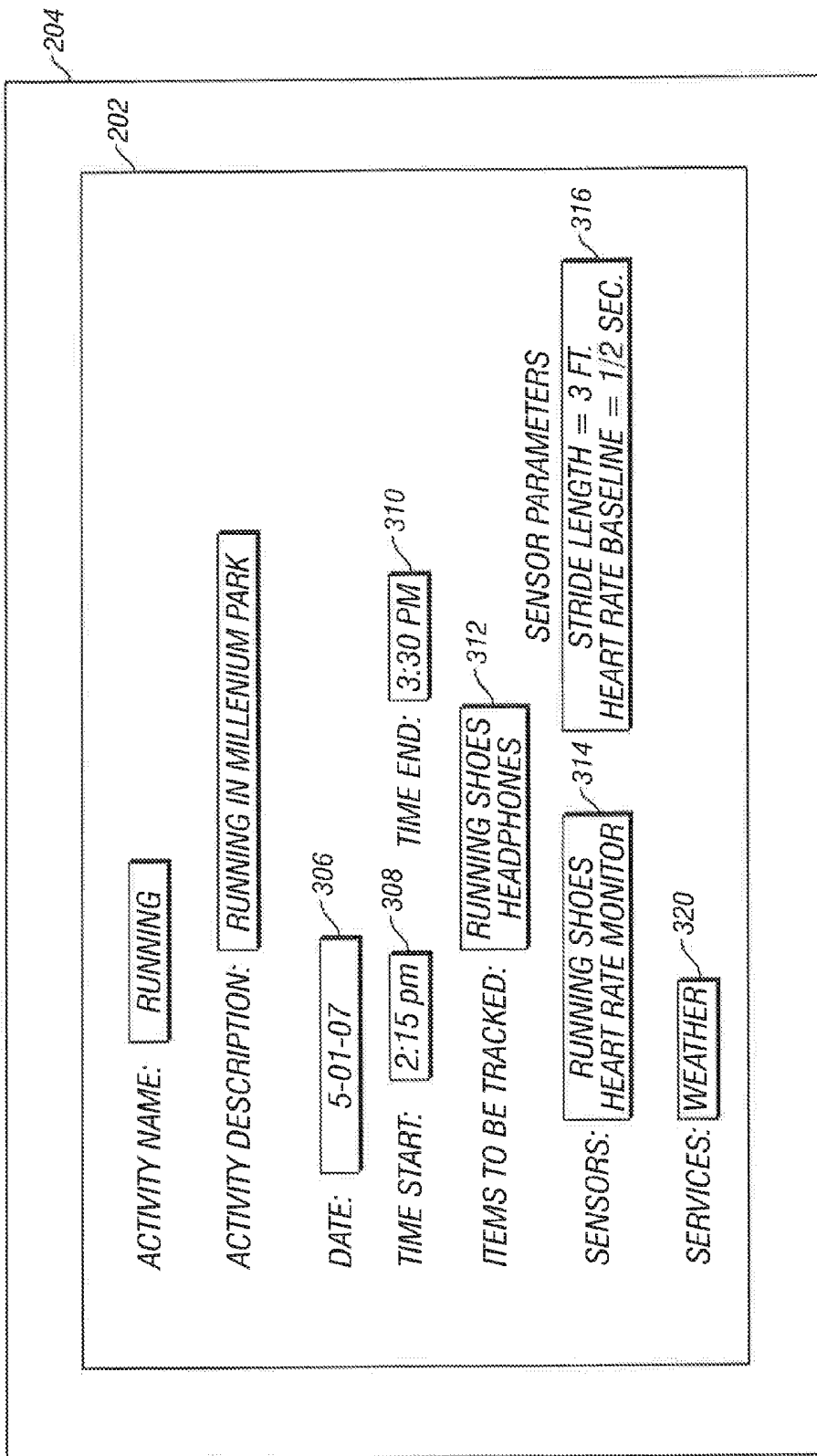

FIG. 16

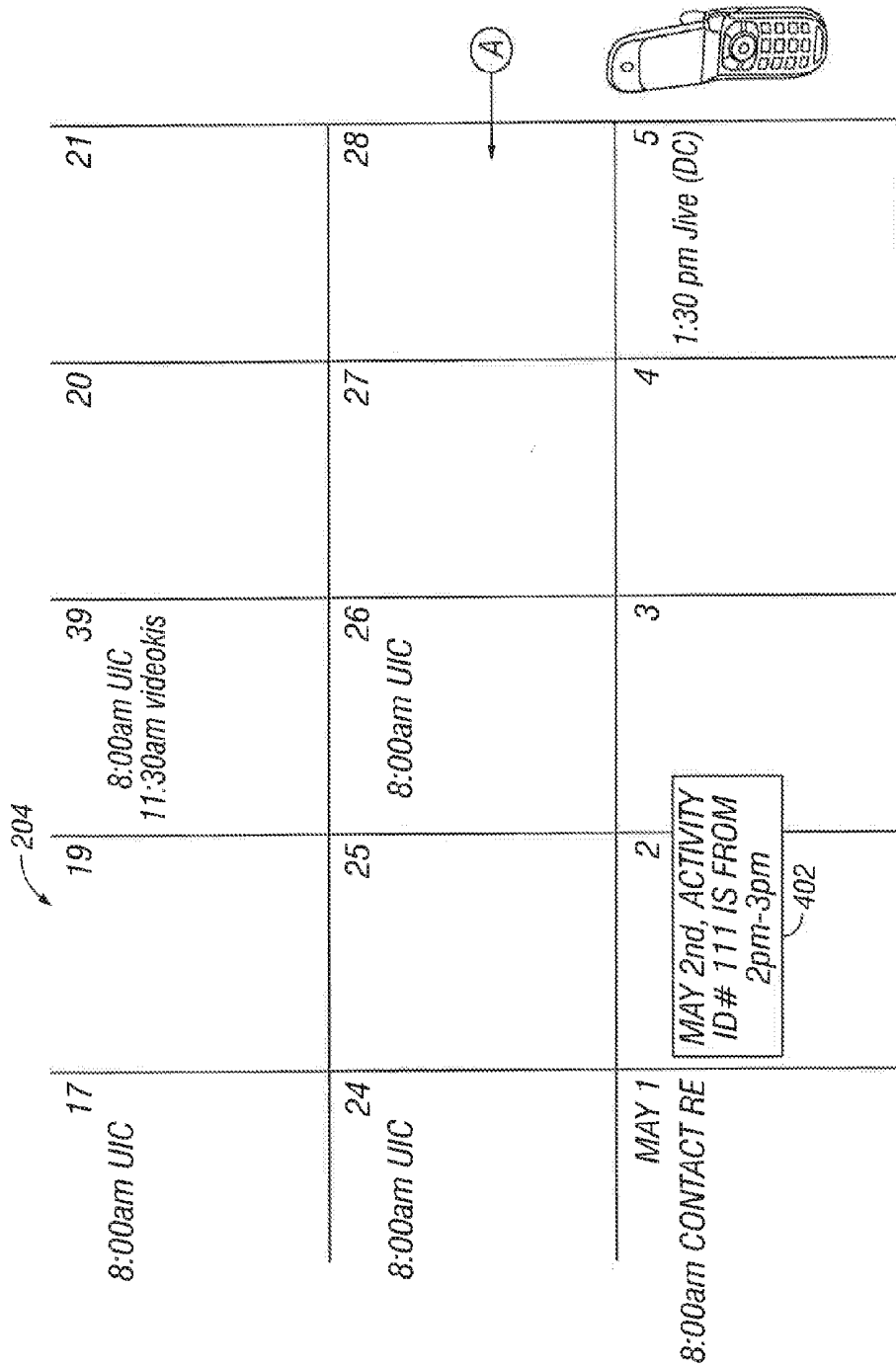

FIG. 17A

ACTIVITY	ACTIVITY ID	SENSOR/DEVICE NAME	SENSOR/DEVICE IP ADDRESS	DATA CONFIG
RUNNING	111	SHOES 1 HEART	1.23.342 1.23.341	HEART RATE BASELINE 1/2S OPTIMAL SAMPLING 1S BASELINE ALGORITHM OPTIMAL ALGORITHM SHOES: SAMPLING RATE: BASELINE: OPTIMAL SAMPLING:
SKATING	112	SKATES 1 JACKET	1.23.341 1.23.339	HEART RATE UTILIZATION CALORIES
WORK OUT	113	STAIR CLIMBER TREAD MILL	1.23.338 1.23.337	CALORIES FAT GRAMS % UTILIZED
COOKING/ DINNER	116	REFRIGERATOR CABINET 2 CABINET 3	1.23.340 1.23.341 1.23.342	ON/OFF CHANNEL
WATCH TV	115	TV CABLE BOX	1.23.344 1.23.346	

FIG. 17B

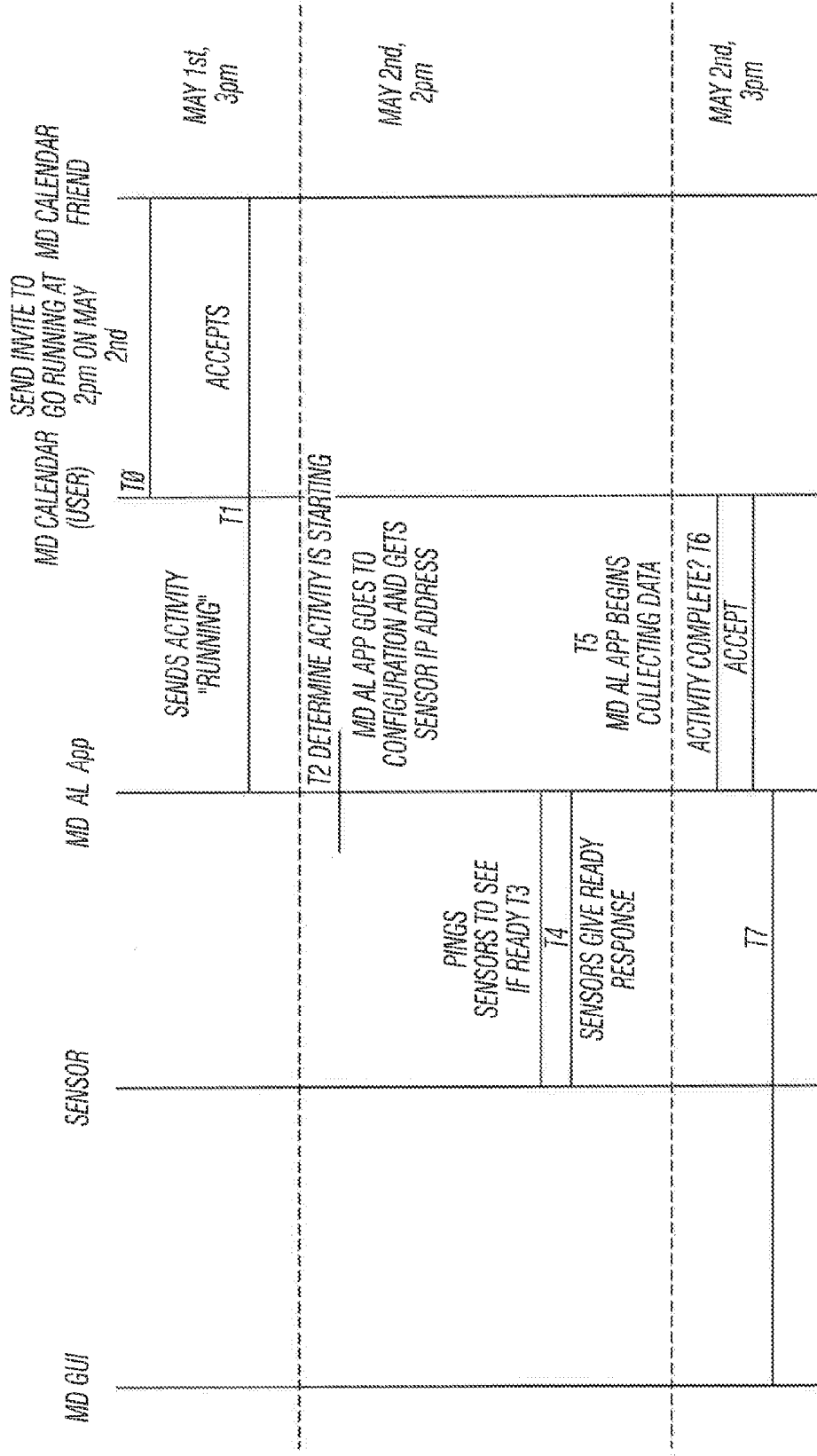

FIG. 18

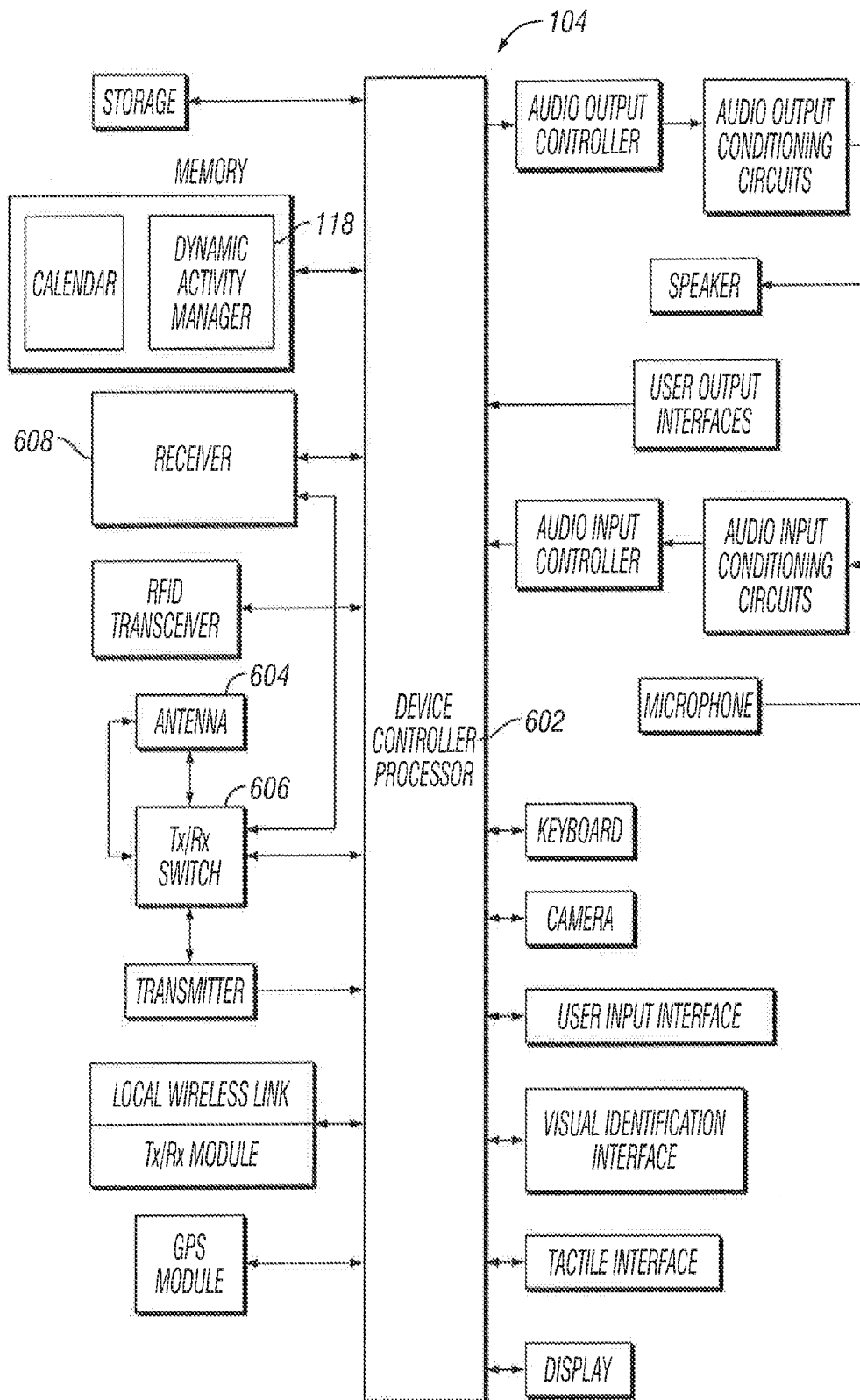

FIG. 19

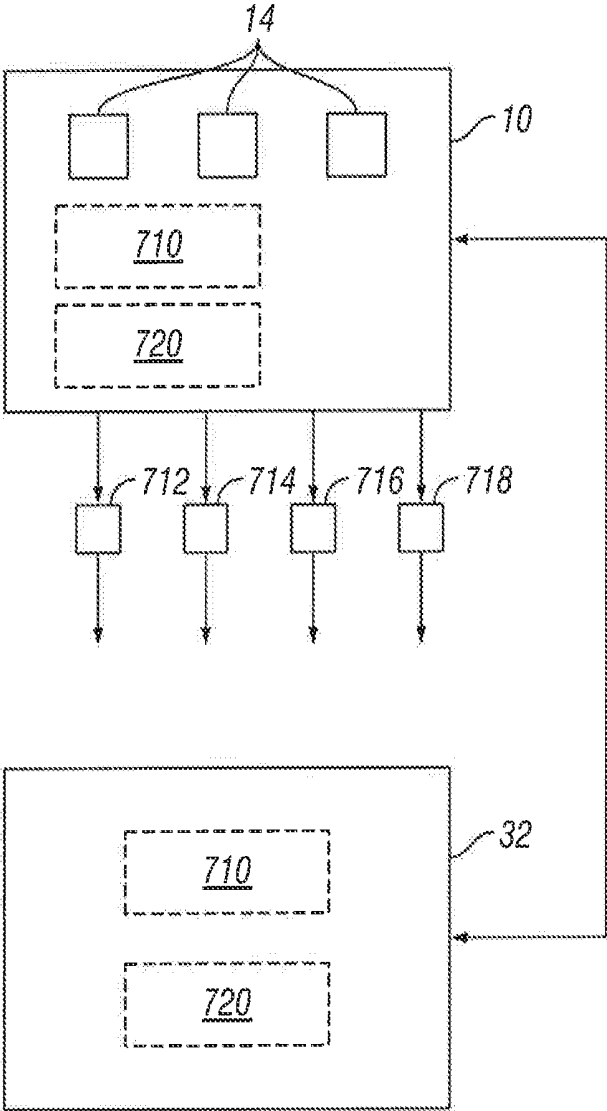

FIG. 20

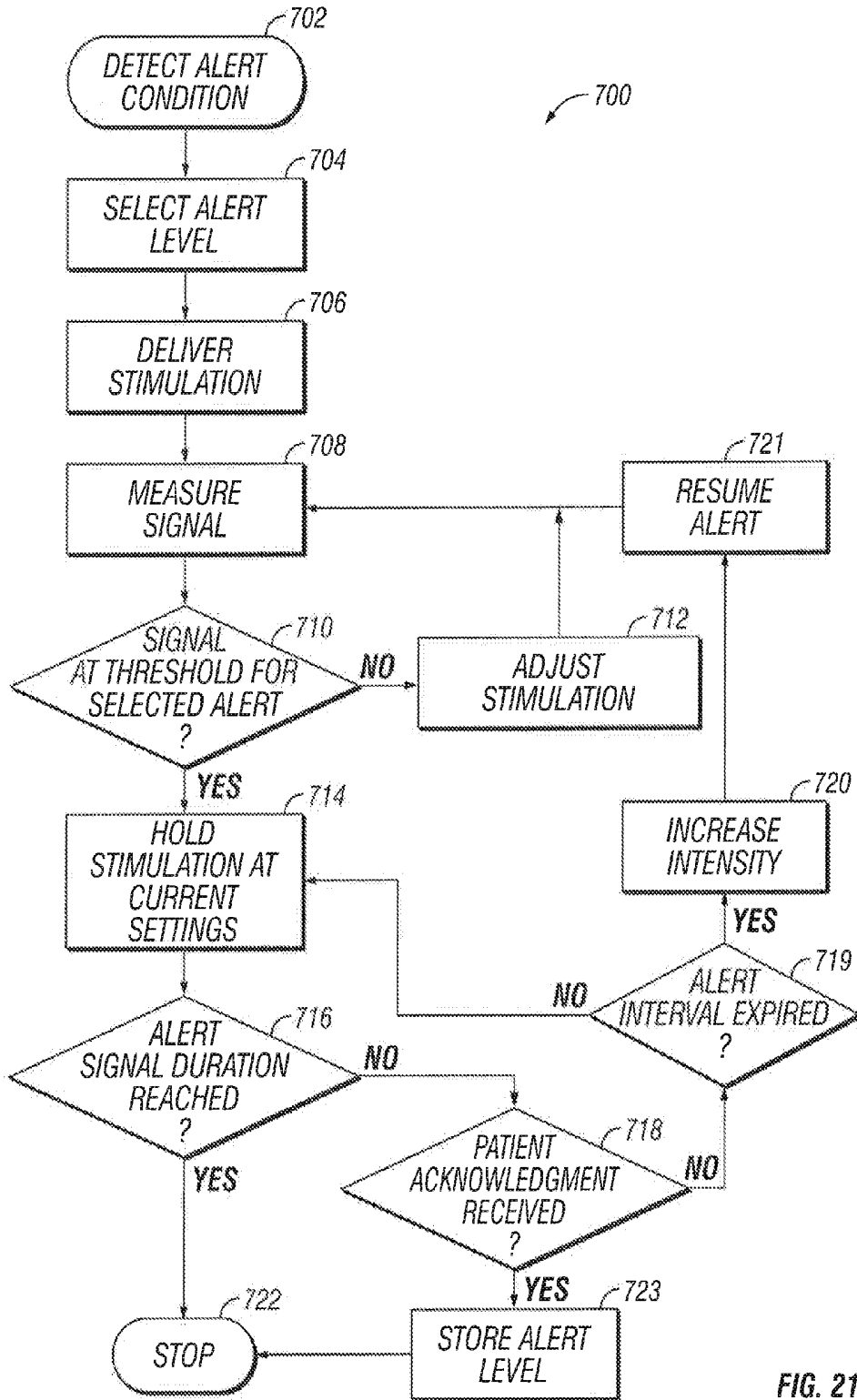

FIG. 21

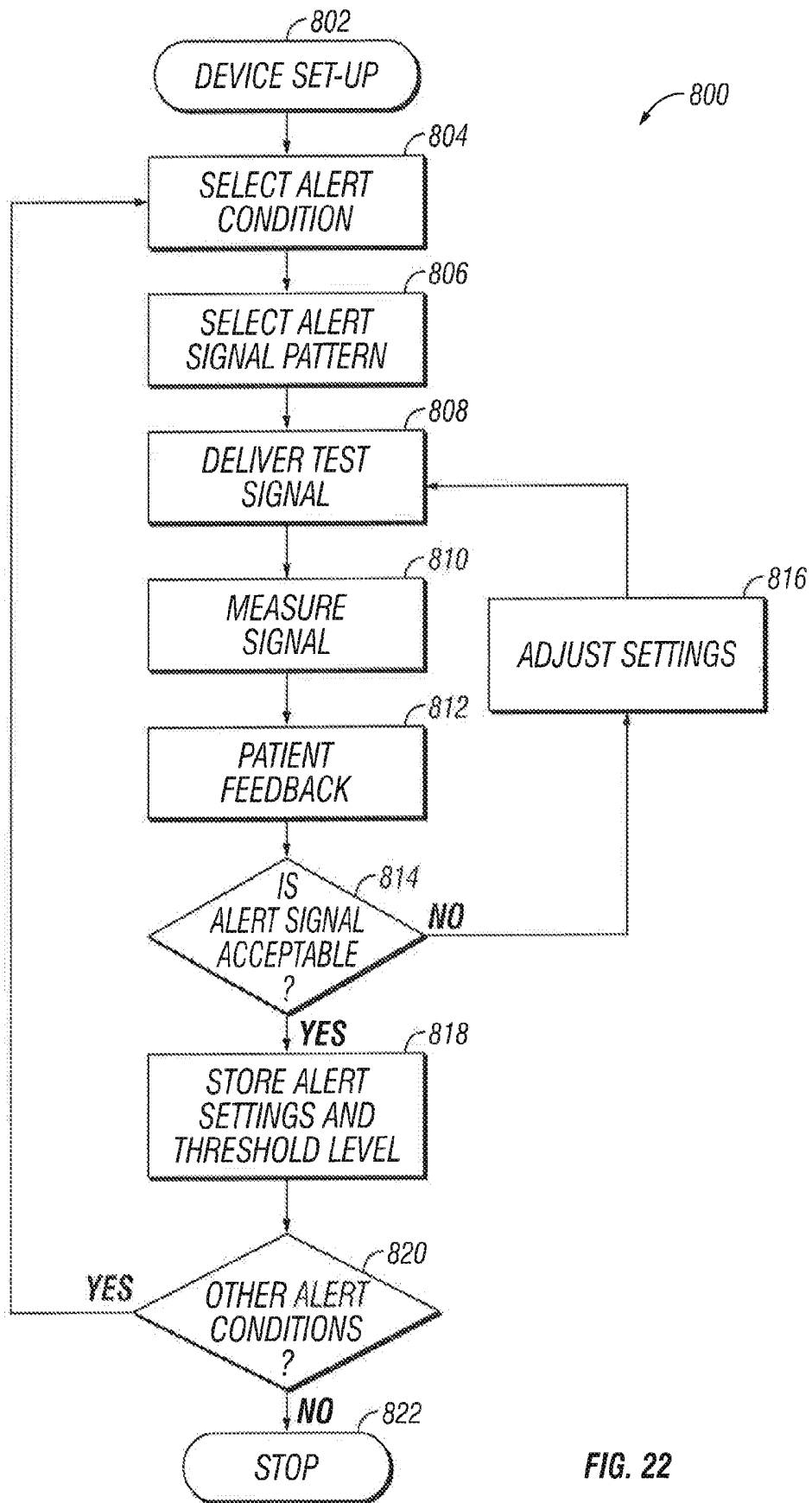

FIG. 22

**USER OR PATIENT MONITORING  
METHODS USING ONE OR MORE ANALYSIS  
TOOLS**

CROSS-REFERENCE TO RELATED  
APPLICATIONS

[0001] This application is a continuation in part of U.S. Ser. No. 13/923,909, U.S. Ser. No. 13/923,637, U.S. Ser. No. 13/923,614, U.S. Ser. No. 13/923,809, U.S. Ser. No. 13/923,750, U.S. Ser. No. 13/923,583, U.S. Ser. No. 13/923,560, U.S. Ser. No. 13/923,543, and U.S. Ser. No. 13/923,937, all filed Jun. 21, 2013 and all of which claim the benefit of U.S. 61/772,265, U.S. 61/812,083 and 61/823,502. All of the above-identified applications are fully incorporated herein by reference.

BACKGROUND

[0002] 1. Field of the Invention

[0003] The present invention is directed to methods for monitoring user or patient parameters, and more particularly to methods that use a user activity manager, feedback control in combination with a monitoring device with a unique user ID and a telemetry system to provide for monitoring a user's activities using one or more analysis tools and provide feedback.

[0004] 2. Description of the Related Art

[0005] Patient monitoring was accomplished by electronic equipment maintained at the user's bedside. Vital signs derived from physiological waveforms were monitored with the bedside equipment and alarms were generated if predetermined limits were exceeded by the vital signs. This bedside monitoring equipment became larger, more complex and expensive as each bedside unit undertook to monitor more physiological data and provide more sophisticated displays, e.g. color, more and better communications and more in-depth analysis of the data, such as calculation of vital signs and trends which required memory and processing capability. The provision of such units at each appropriate user bedside introduces considerable additional expense to the hospital user care costs.

[0006] With the introduction of bedside monitoring units, attempts were made to provide a measure of remote monitoring by transmitting analog waveforms of physiological data from the bedside unit to equipment at a central station such as a nurse's station. Subsequently remote monitoring efforts included analog waveforms plus digital representations for display. Both the bedside and remote monitoring activity acted to give alarms upon sensing an abnormal condition and to store data and analyze data to obtain vital signs and trends. But these systems are basically one-way systems reporting physiological data from the user. There is no communication with the user as a part of an interactive integrated system.

[0007] Telemetry systems can be implemented to acquire and transmit data from a remote source. Some telemetry systems provide information about a user's activities.

[0008] It is becoming commonplace to use wireless packet data service networks for effectuating data sessions with. In some implementations, unique identifications (ID) need to be assigned to the devices in order to facilitate certain aspects of service provisioning, e.g., security, validation and authentication, et cetera. In such scenarios, it becomes imperative that no two devices have the same indicium (i.e., collision). Further, provisioning of such indicia should be flexible so as to

maintain the entire pool of indicia to a manageable level while allowing for their widespread use in multiple service environments.

[0009] Medical telemetry systems may comprise an alarm adapted to identify high risk users and/or users requiring special assistance. Some medical procedures and diagnostic examinations require the removal of any telemetry system components attached directly to a user. One problem with conventional medical telemetry systems is that the process of removing telemetry system components for purposes of performing a medical procedure or diagnostic examination can generate a false alarm. False alarms unnecessarily tax hospital resources and interfere with the working environment.

[0010] There is a need for methods using telemetry devices configured to be used for user lifestyle management, monitoring user behavior, user activity and habits and health monitoring. There is a further need for wireless communication methods with monitoring devices that have sensors used for a monitoring user behavior, user activity and habits and health monitoring, analysis of the monitoring followed by feedback alerts.

SUMMARY OF THE INVENTION

[0011] An object of the present invention is to provide methods that provide tools for analysis and feedback for medical and lifestyle management.

[0012] Another object of the present invention is to provide methods for medical and lifestyle management using user habit information or user monitoring, analysis tools and feedback.

[0013] A further object of the present invention is to provide methods for medical and lifestyle management using monitoring devices with sensors that monitor one or more of a user's activities, behaviors and habit information, the use of analysis tools followed by providing user feedback.

[0014] Still another object of the present invention is to provide methods for medical and lifestyle management using one or more contexts selected from at least one of, time, location, type of user activity, duration of user activity and a status of the user activity, analysis tools used to provide user feedback.

[0015] Yet another object of the present invention is to provide methods that use an activity manager and feedback to manage and monitor user lifestyle or medical conditions in response to receiving information for a monitoring device with sensors that monitor one or more of a user's activities, behaviors and habit information, following by using analysis tools in response to the monitoring.

[0016] These and other objects of the present invention are achieved in a method for using telemetry data based on user habit information or user monitoring. One or more sensors of a monitoring device detects or measures user information selected from of at least one of, a user's activities, behaviors and habit information, and a user's health. The user information is received at a telemetry system with a database. One or more analysis tools at the telemetry system are used for the analysis. Analysis information is produced that is sent to the monitoring device.

BRIEF DESCRIPTION OF THE DRAWINGS

[0017] FIGS. 1(a) and 1(b) illustrate one embodiment of a wearable device of the present invention, where one size fits all.

[0018] FIG. 2 illustrates one embodiment of electronics that can be included in the wearable device.

[0019] FIG. 3 illustrates one embodiment of a telemetry system of the present invention.

[0020] FIG. 4 is a diagram of the programming input schematic of the secure sensor/transmitter array of FIG. 7.

[0021] FIG. 5 is a block diagram of the system of programming the sensor/transmitter(s) comprising the secure sensor/transmitter array of FIG. 7.

[0022] FIG. 6 is a block diagram of the jam command and security/randomization bits of the secure sensor/transmitter array of FIG. 7.

[0023] FIG. 7 is a logic circuit diagram of the sensor/transmitter programming input schematic in one embodiment of the present invention.

[0024] FIG. 8 is a block diagram of an embodiment of a computer implemented system for determining the location of a remote sensor utilizing the methods of the present invention.

[0025] FIG. 9 is a block diagram illustrating one embodiment of a SNAPSHOT GPS receiver for use according to the present invention.

[0026] FIG. 10 is a block diagram of a remote sensor shown in communication with two different external communication devices.

[0027] FIG. 11 is a diagram of the active RF and RF backscatter antennas.

[0028] FIG. 12 is a diagram of the encoding scheme for the symbols in the active RF protocol.

[0029] FIG. 13 is a diagram of the packet structure in the IRDA protocol.

[0030] FIG. 14 is a diagram of the encoding scheme in the IRDA protocol.

[0031] FIG. 15 illustrates one embodiment of an activity manager that is included in the monitoring device, the telemetry system or as a standalone device.

[0032] FIG. 16 illustrates one embodiment of an activity manager in one embodiment of the present invention.

[0033] FIG. 17(a) and (b) illustrate an exemplary user interface for an activity management application according to an embodiment of the present invention.

[0034] FIG. 18 is a timing diagram illustrating one example of monitoring an activity based on one or more contexts according to an embodiment of the present invention;

[0035] FIG. 19 is a block diagram illustrating one embodiment of a monitoring device of the present invention.

[0036] FIG. 20 illustrates an embodiment of the present invention that includes a feedback system or subsystem.

[0037] FIG. 21 is a flow chart illustrating one embodiment of providing feedback and/or alerts to a user or patient.

[0038] FIG. 22 is a flow chart illustrating one embodiment for a method of establishing control parameters for a monitoring device user or patient feedback or alert signal and a sensor signal threshold range for the feedback or alert signal.

#### DETAILED DESCRIPTION

[0039] As used herein, the term engine refers to software, firmware, hardware, or other component that can be used to effectuate a purpose. The engine will typically include software instructions that are stored in non-volatile memory (also referred to as secondary memory). When the software instructions are executed, at least a subset of the software instructions can be loaded into memory (also referred to as primary memory) by a processor. The processor then executes

the software instructions in memory. The processor may be a shared processor, a dedicated processor, or a combination of shared or dedicated processors. A typical program will include calls to hardware components (such as I/O devices), which typically requires the execution of drivers. The drivers may or may not be considered part of the engine, but the distinction is not critical.

[0040] As used herein, the term database is used broadly to include any known or convenient means for storing data, whether centralized or distributed, relational or otherwise.

[0041] As used herein a mobile device includes, but is not limited to, a cell phone, such as Apple's iPhone®, other portable electronic devices, such as Apple's iPod Touches®, Apple's iPads®, and mobile devices based on Google's Android® operating system, and any other portable electronic device that includes software, firmware, hardware, or a combination thereof that is capable of at least receiving the signal, decoding if needed, exchanging information with a transaction server to verify the buyer and/or seller's account information, conducting the transaction, and generating a receipt. Typical components of mobile device may include but are not limited to persistent memories like flash ROM, random access memory like SRAM, a camera, a battery, LCD driver, a display, a cellular antenna, a speaker, a BLUETOOTH® circuit, and WIFI circuitry, where the persistent memory may contain programs, applications, and/or an operating system for the mobile device.

[0042] As used herein, the terms "social network" and "SNET" comprise a grouping or social structure of devices and/or individuals, as well as connections, links and interdependencies between such devices and/or individuals. Members or actors (including devices) within or affiliated with a SNET may be referred to herein as "nodes", "social devices", "SNET members", "SNET devices", "user devices" and/or "modules". In addition, the terms "SNET circle", "SNET group" and "SNET sub-circle" generally denote a social network that comprises social devices and, as contextually appropriate, human SNET members and personal area networks ("PANs").

[0043] As used herein, the term "wearable device" is anything that can be worn by an individual and that has a back side that in some embodiments contacts a user's skin and a face side. Examples of wearable device include but are not limited to a cap, arm band, wristband, garment, and the like.

[0044] As used herein, the term "computer" is a general purpose device that can be programmed to carry out a finite set of arithmetic or logical operations. Since a sequence of operations can be readily changed, the computer can solve more than one kind of problem. A computer can include of at least one processing element, typically a central processing unit (CPU) and some form of memory. The processing element carries out arithmetic and logic operations, and a sequencing and control unit that can change the order of operations based on stored information. Peripheral devices allow information to be retrieved from an external source, and the result of operations saved and retrieved.

[0045] As used herein, the term "Internet" is a global system of interconnected computer networks that use the standard Internet protocol suite (TCP/IP) to serve billions of users worldwide. It is a network of networks that consists of millions of private, public, academic, business, and government networks, of local to global scope, that are linked by a broad array of electronic, wireless and optical networking technologies. The Internet carries an extensive range of information

resources and services, such as the inter-linked hypertext documents of the World Wide Web (WWW) and the infrastructure to support email. The communications infrastructure of the Internet consists of its hardware components and a system of software layers that control various aspects of the architecture.

**[0046]** As used herein, the term “extranet” is a computer network that allows controlled access from the outside. An extranet can be an extension of an organization’s intranet that is extended to users outside the organization that can be partners, vendors, and suppliers, in isolation from all other Internet users. An extranet can be an intranet mapped onto the public Internet or some other transmission system not accessible to the general public, but managed by more than one company’s administrator(s). Examples of extranet-style networks include but are not limited to:

**[0047]** LANs or WANs belonging to multiple organizations and interconnected and accessed using remote dial-up

**[0048]** LANs or WANs belonging to multiple organizations and interconnected and accessed using dedicated lines

**[0049]** Virtual private network (VPN) that is comprised of LANs or WANs belonging to multiple organizations, and that extends usage to remote users using special “tunneling” software that creates a secure, usually encrypted network connection over public lines, sometimes via an ISP.

**[0050]** As used herein, the term “Intranet” is a network that is owned by a single organization that controls its security policies and network management. Examples of intranets include but are not limited to:

**[0051]** A LAN

**[0052]** A Wide-area network (WAN) that is comprised of a LAN that extends usage to remote employees with dial-up access

**[0053]** A WAN that is comprised of interconnected LANs using dedicated communication lines

**[0054]** A Virtual private network (VPN) that is comprised of a LAN or WAN that extends usage to remote employees or networks using special “tunneling” software that creates a secure, usually encrypted connection over public lines, sometimes via an Internet Service Provider (ISP).

**[0055]** For purposes of the present invention, the Internet, extranets and intranets collectively are referred to as (“Network Systems”).

**[0056]** As used herein, the term “user” includes but is not limited to a person, under a physician’s care, interested in maintaining health, interested in maintaining a healthy lifestyle and/or physiologic balance, interested in monitoring lifestyle conditions, including but not limited to, the way a person goes about daily living including but not limited to, habits, exercise, diet, medical conditions and treatments, career, financial means, emotional status, and the like.

**[0057]** As used herein, the term “user monitoring” includes: (i) Cardiac monitoring, which generally refers to continuous electrocardiography with assessment of the user’s condition relative to their cardiac rhythm. A small monitor worn by an ambulatory user for this purpose is known as a Holter monitor. Cardiac monitoring can also involve cardiac output monitoring via an invasive Swan-Ganz catheter (ii) Hemodynamic monitoring, which monitors the blood pressure and blood flow within the circulatory system. Blood

pressure can be measured either invasively through an inserted blood pressure transducer assembly, or noninvasively with an inflatable blood pressure cuff. (iii) Respiratory monitoring, such as: pulse oximetry which involves measurement of the saturated percentage of oxygen in the blood, referred to as SpO<sub>2</sub>, and measured by an infrared finger cuff, capnography, which involves CO<sub>2</sub> measurements, referred to as EtCO<sub>2</sub> or end-tidal carbon dioxide concentration. The respiratory rate monitored as such is called AWRR or airway respiratory rate). (iv) Respiratory rate monitoring through a thoracic transducer belt, an ECG channel or via capnography, (v) Neurological monitoring, such as of intracranial pressure. Special user monitors can incorporate the monitoring of brain waves electroencephalography, gas anesthetic concentrations, bispectral index (BIS), and the like, (vi) Blood glucose monitoring using glucose sensors. (vii) Childbirth monitoring with sensors that monitor various aspects of childbirth. (viii) Body temperature monitoring which in one embodiment is through an adhesive pad containing a thermoelectric transducer. (ix) Stress monitoring that can utilize sensors to provide warnings when stress levels signs are rising before a human can notice it and provide alerts and suggestions. (x) Epilepsy monitoring. (xi) Toxicity monitoring, (xii) general lifestyle parameters and the like.

**[0058]** Additionally the present invention can be used to detect differences for a variety of blood tests, including but not limited to tests for the following: sodium, potassium, chloride, urea, creatinine, calcium, albumin, fasting glucose, amylase, carcinoembryonic antigen, glycosylated hemoglobin, hemoglobin, erythrocytes hemoglobin and the like.

**[0059]** In various embodiments, the present invention provides a user monitoring device **10**, including but not limited to, a wearable device, where one size fits all, Telemetry device **10** can be a sensor enabled item **10**, including but not limited to a wearable device, gym bag, wallet, file, shoes, skis, and the like that has its own unique ID. As illustrated in FIGS. **1(a)** and **1(b)**, in one embodiment of the present invention, the user monitoring device **10** include a plurality of magnets **12**, with adjacent magnets having opposite polarity, with a length suitable to be worn by all people. In one embodiment, the length of the user monitoring device **10** can be 10-12 inches. The magnets **12** are positioned along an interior of the user monitoring device **10** to be provided for good conformation to a user’s wrist.

**[0060]** One or more sensors **14** are coupled to the user monitoring device **10**. The sensors are measuring devices. As a non-limiting example, the measuring device or sensors **14** can include RTSS devices to detect a user’s activities, motions, physical parameters, and the like, including but not limited to, a heart rate monitor, a body temperature probe, a conventional pedometer, an accelerometer and the like.

**[0061]** Alternatively, multifunctional sensors **14** which can perform all the aforementioned functions of RTSS may be attached or embedded in user monitoring device **10**. In one embodiment, each sensor can be in communication and or connect electronically and/or RF to a telemetry module **16**. A variety of different sensors **14** can be utilized, including but not limited to, an accelerometer based sensor, and pressure based sensors, voltage resistance sensor, a radio frequency sensor, and the like, as recited above.

**[0062]** As a non-limiting example, an accelerometer, well known to those skilled in the art, detects acceleration and thus user activity. The accelerometer provides a voltage output that is proportional to the detected acceleration. Accordingly,

the accelerometer senses vibration. This voltage output provides an acceleration spectrum over time; and information about loft time can be ascertained by performing calculations on that spectrum. A microprocessor subsystem, such as disclosed in U.S. Pat. No. 8,352,211, incorporated herein by reference, stores the spectrum into memory and processes the spectrum information to determine activity. Other examples of suitable accelerometer sensors are disclosed in EP 2428774 A1, incorporated herein by reference. Suitable pressure sensors are disclosed in EP 1883798 B1, incorporated herein by reference. A suitable voltage resistance sensor is disclosed in EP 1883798 B1, incorporated herein by reference. A suitable radio frequency sensor is disclosed in EP 2052352 B1, incorporated herein by reference.

**[0063]** Referring to FIG. 2, in various embodiments, the user monitoring device 10, also known as the user monitoring device, can include a power source 24, such a battery that can be rechargeable. The battery 24 can be put into a sleep state when not actively used in order to preserve power. A wake up feature allows the battery 24 and other electronics of the user monitoring device 10 to “sleep” during non-use or and is initiated into the “wake up” mode by certain predestinated events.

**[0064]** In one embodiment, as illustrated in FIG. 3, a telemetry system server 16 is coupled to a database 18. Each user monitoring device 10 is assigned its own unique identification, ID.

**[0065]** The data transmitted by the user monitoring device 10 sensors 14 and its ID may be coded by appending a seed to digital data bits. As illustrated in FIG. 3 central processor unit 20 (CPU) validates or rejects received upon detection of the seed string appended to the digital data bits. In the alternative, the digital data bits may be coded and decoded by applying a scrambling algorithm utilizing the seed. A programming device 22 may be configured to transmit data to a sensor 14, also known as a user monitoring device, utilizing a variety of alternative transmission means, including, for example, RF, IR, optical, and the like, or a magnetic loop/induction system.

**[0066]** In one embodiment, sensors 14 are configured to be shipped to users in a non-programmable mode with all programming already performed at the factory. A random seed may be communicated to the programming device 22 can a variety of different mechanisms, including but not limited to, via scanning a bar code, manual input, magnetic strip, random number generation, and the like.

**[0067]** Referring again to FIG. 2, in one embodiment, the user monitoring device 10 includes a control unit 26 that puts the user monitoring device 10 in a low power state. A monitoring system 28 can be included that remains active. The monitoring system 28 wakes up the electronics 30 in the user monitoring device 10 from a low power state. The control unit 26 can be notified of awaking of the other components by the monitoring system 28. The control unit 26 can set a status bit on the monitoring system 28 only when the battery 24 needs to be in a full power state. The control unit 26 then forces a power cycle.

**[0068]** Referring to FIG. 3, one embodiment of a telemetry system 32 is illustrated. The telemetry system 32 is in the communication with the sensors 14 and or user monitoring device 14 and ID of the user monitoring device 10 and can include one or more receivers 34, a central server 36 with the CPU 20. The telemetry system 32 can optionally include a display 42 and an alarm 44. The telemetry system 32 receives information from sensors 14 and or the monitoring device of

a user's habits, activities, and the like, and then processes this information. Monitoring device 10 with its unique ID and sensors 14 is assigned to a specific user in order to track and/or monitor that user. For illustrative purposes assume that three users A, B AND C are being tracked and monitored by the telemetry system 32. It should, however, be appreciated that the telemetry system 32 may be implemented to track and/or monitor a much larger number of users.

**[0069]** In one embodiment of the present invention, radio frequency (RF) devices that are sensors 14 and/or chips may serve as the identifying devices. Each source, sensor 14, ID and the like can carry a fixed radio frequency chip encoded with identifying data which may be correlated to the individual participants, parts or objects.

**[0070]** Telemetry system 32 of the present invention may include a Real-Time Location System (RTLS) 46 and Real-Time Sensing System (RTSS) 48 with RF technology. The RF technology may include active and/or passive RFID sensors 14 and an RF wireless array system as a receiver 34. The RF technology in the RTLS 46 and RTSS 48 may include UWB technology (e.g., IEEE 802.15), WLAN technology (e.g., IEEE 802.11), SAW RFID positioning system technology, GPS technology, and the like.

**[0071]** The sensors 14 may communicate directly with each other and/or relay telemetry data directly to base receiving RF device(s) or base receivers 34. The base receivers 34 may forward the telemetry data to a base computer either through a direct link or through a Network System. Alternatively the telemetry data may be forwarded to end user devices, including but not limited to, laptops, mobile devices and the like, either directly or through a Network System. The comprehensive telemetry system 32 using RF technologies such as UWB, ZigBee, Wi-Fi, GPS data system can be utilized as described above.

**[0072]** The readers/antennae may be interconnected using a LAN, such as Ethernet to provide a Network System communication infrastructure for the computers and servers. Active and passive RFID sensors 14 may be employed. The active sensors 14 (RFID) may have a two-way communication function, which allows the base computer system to dynamically manage the sensors 14; vary update rates; send self-identification and telemetry data.

**[0073]** The active sensors 14 may employ dual-radio architecture. In one embodiment, active sensors 14 transmit radio pulses, which are used to determine precise two-dimensional or three-dimensional location and a conventional bi-directional radio, which is used as a control and telemetry channel with a sensor update rate.

**[0074]** The user monitoring device 10 gathers telemetry data, communicates that data to a base station, BLUETOOTH® enabled device, or smart phone and the like. From the base station, the user monitoring device 10 can receive firmware updates or via a BLUETOOTH® enabled device. The user monitoring device 10 can receive updates wirelessly. The base station can receive firmware updates from Network Systems, take telemetry data from the user monitoring device 10 and transfer it to Network Systems. Telemetry data received from the base station is analyzed by servers and presented to an end user. Any third party device can receive data from the user monitoring device 10 wirelessly and deliver information to the servers for processing.

**[0075]** In one embodiment, the user monitoring device 10 uses an accelerometer, gyroscope, GPS sensor, a BLUETOOTH® chip, and a heart rate monitor.

**[0076]** As a non-limiting example, for heart monitoring, the accelerometer, sensor **14**, determines when to sample the sensors **14** and to improve the accuracy of the heart rate monitor. The gyroscope detects movement and orientation and the GPS sensor is used to determine location of the user. A BLUETOOTH® chip allows the device to connect wirelessly to other third party devices.

**[0077]** As a non-limiting example, a heart rate monitor **14** detects the user's heart rate in order to accurately determine the user's activity level, behavioral patterns and the like.

**[0078]** An Artificial Intelligence (AI) or Machine Learning-grade algorithms is used to identify the user's activities, behaviors, behaviors and perform analysis. Examples of AI algorithms include Classifiers, Expert systems, case based reasoning, Bayesian Network Systems, and Behavior based AI, Neural networks, Fuzzy systems, Evolutionary computation, and hybrid intelligent systems. A brief description of these algorithms is provided in Wikipedia and stated below.

**[0079]** Classifiers are functions that can be tuned according to examples. A wide range of classifiers are available, each with its strengths and weaknesses. The most widely used classifiers are neural networks, support vector machines, k-nearest neighbor algorithms, Gaussian mixture models, naive Bayes classifiers, and decision trees. Expert systems apply reasoning capabilities to reach a conclusion. An expert system can process large amounts of known information and provide conclusions based on them.

**[0080]** A case-based reasoning system stores a set of problems and answers in an organized data structure called cases. A case based reasoning system upon being presented with a problem finds a case in its knowledge base that is most closely related to the new problem and presents its solutions as an output with suitable modifications. A behavior based AI is a modular method of building AI systems by hand. Neural networks are trainable systems with very strong pattern recognition capabilities.

**[0081]** Fuzzy systems provide techniques for reasoning under uncertainty and have been widely used in modern industrial and consumer product control systems. An Evolutionary Computation applies biologically inspired concepts such as populations, mutation and survival of the fittest to generate increasingly better solutions to the problem. These methods most notably divide into evolutionary algorithms (e.g., genetic algorithms) and swarm intelligence (e.g., ant algorithms). Hybrid intelligent systems are any combinations of the above. It is understood that any other algorithm, AI or otherwise, may also be used. Examples of suitable algorithms that can be used with the embodiments of the present invention are disclosed in, EP 1371004 A4, EP 1367534 A2, US 20120226639 and US 20120225719, all incorporated fully herein by reference.

**[0082]** In various embodiments, the user monitoring device **10** has additional features. In one embodiment, the user monitoring device **10** changes color, via infrared LEDs, to accurately match the wearer's skin tone. This creates a seamless and more personal integration of technology into the user's daily life. In this embodiment, there is skin contact with the user monitoring device **10**.

**[0083]** In another embodiment, the user monitoring device **10** remotely reminds and can be used to administer medications. As a non-limiting example, the user monitoring device **10** can inject adrenalin. In one embodiment, the user monitoring device **10** has sleep pattern recognition based on movement and heart rate.

**[0084]** In various embodiments, the user monitoring device **10** uses algorithms to determine activity type, behavioral patterns and user habits based on collected data.

**[0085]** In one embodiment, the user monitoring device **10** uses the accelerometer information to improve the heart rate monitor. As a non-limiting example, the user monitoring device **10** detects movement and speed. Addition of this data improves the accuracy of the heart rate monitor and corrects for any miscalculations in vibration, noise and skin color.

**[0086]** In one embodiment, velocity readouts and accelerometer data are used to measure when to sample heart rate. For example, if the user monitoring device **10** registers zero velocity readout, the user is probably at rest or engaged in a passive activity. Thus, the user monitoring device **10** knows not to sample heart rate. This results in conservation of time, energy and data storage.

**[0087]** User activity, performance and action can be based on the acceleration and angular velocity of the user monitoring device **10**. In one embodiment, the user monitoring device **10** has a feature where the user monitoring device **10** authorizes third party interaction based on hand gesture, on previous interactions or patterns of behavior. As a non-limiting example, if one purchases a coke every day for the last two weeks, the user monitoring device **10** can "orders" the person another one based on the prior history.

**[0088]** In one embodiment, the user monitoring device **10** features near-by user monitoring device **10** recognition that provides for other user monitoring device **10** devices to be recognized within a particular vicinity and are able to share and transfer data between them. The user monitoring device **10**'s data analysis and feedback can be based on current or previous sensor output. The user monitoring device **10** can alert the user when to charge the user monitoring device **10** and when it is the most convenient for the user.

**[0089]** In one embodiment, the user monitoring device **10** provides feedback via color change. An outer shell of the user monitoring device **10** can use visual feedback, including but not limited to pigment or color changes to indicate changes in user behavior or to prompt changes in user behavior. In one embodiment, the user monitoring device **10** is flexible in shape. As a non-limiting example, if the user puts the user monitoring device **10** over their hand it can expand or contract, morphing to change size and shape.

**[0090]** In one embodiment, the user monitoring device **10** can have a sync feature for multiple bands at the same time.

**[0091]** In one embodiment, the user monitoring device **10** has data transfer to an external device that can be included or not included in system **32**. Patient monitoring device **10** could be a data leaching device. For example, the user can relay information to someone else's device (intermediary device) to access Network Systems connected device.

**[0092]** In one embodiment, the user monitoring device **10** can disable the recording of one or more sensors **14** based on location, acceleration (or lack thereof) and the like.

**[0093]** In one embodiment, the user monitoring device **10** detects different types of transportation and activity based on sensor data. In one embodiment, user monitoring device **10** can unlock doors or cars. The user can turn it on and off. As a non-limiting example, it can be turned off by having a capacitor switch on top and bottom and is placed in a way that one couldn't accidentally turn it off. As a non-limiting example, turning it off can be done by rotating the user monitoring device **10** once.

**[0094]** In one embodiment, the user monitoring device **10** recognizes the wearer based on biometric information, previous data, movement pattern, and the like. In one embodiment, the user monitoring device **10** detects a new user based on an inability to match to user/usage patterns.

**[0095]** As non-limiting examples, a variety of different sensors **14** can be used such as, an altimeter, blood oxygen recognition, heart rate from wrist via sonar, Doppler, based on sound wave and movement, based on pressure, and the like. A pressure sensor **14** can be placed on a circulatory vessel such as a vein to detect pulse.

**[0096]** With the user monitoring device **10** of the present invention, mechanical actions of the user can be triggered, recognized and evaluated.

**[0097]** As a non-limiting example, with multiple users and wearable devices **10**, a separate user monitoring device **10** ID is assigned to each of the users A, B AND C, and thereafter the assigned transmitter/monitor **14** generates user activity data and/or user tracking data. For purposes of this disclosure, monitoring data is defined to include data acquired during the process of monitoring or evaluating a predefined characteristic. The user activity data tracks data from the sensors **14** is transferred to the receivers **34** via the wireless connections **38** represented by a dashed line.

**[0098]** A network of receivers **34** transfers the user activity and/or tracking data to system server **16** via connection **50**. System server **16** includes a processor **52** configured to process the user data in a known manner. For example, the processor **52** may convert raw user data acquired by the sensors **14** into more conveniently readable data.

**[0099]** As a non-limiting example, the display **42** can be implemented to graphically convey user information from system server **16** in a conveniently readable manner. As a non-limiting example, the user may be a cardiac user with user monitoring data graphically conveyed as a conventional ECG plot comprising a sequence of P-waves, a QRS complexes and a T-waves. As another example, user tracking data may be graphically conveyed as an icon superimposed onto a map to indicate the user's relative location. Alarm **44** may be included in this embodiment.

**[0100]** In some embodiments, system **32** ID circuitry delivers a unique ID to the wearable device from database **18**. BLUETOOTH® chips can be coupled with other wearable devices **10** in the area. This data is then stored, as more fully explained in the following paragraph. The unique ID can be utilized for a variety of different applications including but not limited to payments, social networking and the like.

**[0101]** The ID circuitry of system **32** can include a number of system/components: unique ID storage, communication system, which reads and transmits the unique ID from the unique ID storage, battery **24** or power system that provides power to enable communication with the user monitoring device **10**, a pathway system to route signals to through the circuitry, a cluster that crunches information, and a control system, to orchestrate the communication between different systems. All of these systems can be implemented in hardware, software or a combination thereof. Continuing with the telemetry system **32**, sensors **14** and sensing devices are disposed on wearable devices **10** worn by users. Data, such as movement, location, speed, acceleration, and the like, can be acquired, captured and provided to system **32**.

**[0102]** System **32** and an associated Network System can include an identification reference, including user activity, performance and reference information for each individual sensor **14** and location.

**[0103]** The user activity, performance metrics, data and the like captured by system **32** can be recorded into standard relational databases SQL server, and/or other formats and can be exported in real-time.

**[0104]** In various embodiments, the user monitoring device **10** and/or system **32** are fully sealed and have inductively charges. All communication is done wirelessly.

**[0105]** In one embodiment, there are no electrical contacts, physical contacts or connections with the user monitoring device **10**. The user monitoring device **10** is seamless. The telemetry system **32** can include a microprocessor with CPU **20**, memory, interface electronics and conditioning electronics **33** configured to receive a signal from the sensors **14**. In one embodiment, all or a portion of the conditioning electronics **33** are at the user monitoring device **10**.

**[0106]** In one embodiment, the CPU **20** includes a processor **52**, which can be a microprocessor, read only memory used to store instructions that the processor may fetch in executing its program, a random access memory (RAM) used by the processor **52** to store information and a master dock. The microprocessor is controlled by the master clock that provides a master timing signal used to sequence the microprocessor **52** through its internal states in its execution of each processed instruction. In one embodiment, the microprocessor **52**, and especially the CPU **20**, is a low power device, such as CMOS, as is the necessary logic used to implement the processor design. The telemetry system **32** can store information about the user's activity in memory.

**[0107]** This memory may be external to the CPU **20** but can reside in the RAM. The memory may be nonvolatile such as battery backed RAM or electrically erasable programmable read only memory (EEPROM). Signals from the sensors **14** can be in communication with conditioning electronics **33** that with a filter **35**, with scale and can determine the presence of certain conditions. This conditioning essentially cleans the signal up for processing by CPU **20** and in some cases pre-processes the information. These signals are then passed to interface electronics, which converts the analog voltage or currents to binary ones and zeroes understood by the CPU **20**. The telemetry system **32** can also provide for intelligence in the signal processing, such as achieved by the CPU **20** in evaluating historical data.

**[0108]** In one embodiment, the actions of the user wearing the user monitoring device **10** with the unique ID can be used for different activities and can have different classifications at system **32**.

**[0109]** The classification can be in response to the user's location, where the user spends it time, with which the user spends its time, determination of working relationships, family relationships, social relationships, and the like. These last few determinations can be based on the time of day, the types of interactions, comparisons of the amount of time with others, the time of day, a frequency of contact with others, the type of contact with others, the location and type of place where the user is at, and the like. These results are stored in database **18**.

**[0110]** In one embodiment, the user wearing the user monitoring device **10** can access this information from any place

where data is presented to the user, including but not limited to mobile devices, the WEB, applications program identifiers, and the like.

[0111] As a non-limiting example, the user monitoring device 10 communicates with a base station at system 32. The user monitoring device 10 can intelligently switch between data transfer and charging based on sensor readout. The user monitoring device 10 can represent data based on connected devices.

[0112] In one embodiment, the user monitoring device 10 has the capability of providing recommendations, popularity of locations or activities based on acquired data from the user.

[0113] In one embodiment, the user monitoring device 10 has the capability of introducing the user to other people or users based on their data and the user's data.

[0114] In one embodiment, the user monitoring device 10 can determine emotion of the user.

[0115] In one embodiment, the user monitoring device 10 uses incremental data transfer via BLUETOOTH® and the like. The user monitoring device 10 can transmit data through the inductive coupling for wireless charging. The user is also able to change the frequency of data transmission.

[0116] The user monitoring device 10 can engage in intelligent switching between incremental and full syncing of data based on available communication routes. As a non-limiting example, this can be via cellular Network Systems, WiFi, BLUETOOTH® and the like. In one embodiment, the user monitoring device 10 has data storage. As a non-limiting example, storage of telemetry data on user monitoring device 10 can be amounts up to about 16 mg.

[0117] In one embodiment, data transferred if it's in a selected proximity of a base station of system 32 or in proximity of an associated connected Network System. In one embodiment, the user monitoring device 10 has a dynamic change of data capture frequency. The user monitoring device 10 can be programmed to instantly change how often it samples any sensor 14 based upon the sensor data. Intelligent data sampling is based on sensor readout.

[0118] The user monitoring device 10 can receive firmware updates via a base station 110 of system 32. In one embodiment, the user monitoring device 10 presents analyzed data and feedback on a website. In one embodiment, the user monitoring device 10's software is based on unique human movement. The user monitoring device 10 is able to identify its wearer based on the unique patterns of movement, location check-ins and daily habits of the user.

[0119] In one embodiment, the app can be used on a mobile device, including but not limited to a smart phone and the like.

[0120] In one embodiment, a breakdown of recounting data that has been collecting is presented for analysis of that data. Observation or recommendations can be presented based on historical information and live information. The importance of the data can be based on past user behavior.

[0121] In one embodiment, the user monitoring device 10 has artificial intelligence. A wearable device processor 54 implements logic resources that exist on user monitoring device 10.

[0122] In one embodiment, user monitoring device 10 engages in the routing of user information to third parties based on predefined rules, based on system 32 analysis.

[0123] In one embodiment, user monitoring device 10 includes one or more processors 54 that implement intelligent algorithmic processing and transfer of information to third

parties. Feedback can be provided to the end user that is based on visual, tactile, gesture information and the like.

[0124] The ID can be sent from the user monitoring device 10 in a variety of different transmit modes, which may be provided as part of the firmware or software of an ID or sensor transmitter 14, and which may be utilized selectively during the operation of said sensor transmitter 14, may include "burst" transmit modes, wherein a burst of data information is transmitted, or "parcel" transmit modes, wherein timed data packets of data, which may, as desired, comprise partial data strings, are transmitted, and, if desired, repeated during time intervals. Further, the sensors 14 may have programmed therein diagnostic routines or other test modes which assist during manufacture and use, providing the operator with operational status and verification information on said sensor/transmitter 14, as needed. Referring to FIG. 4, system 32 includes data base 18 which contains the desired transmitter, sensor, 14 personality data, as well as, the address/device ID bits for each user monitoring device 10.

[0125] In one embodiment, the initial programming of the user monitoring device 10 for the ID, as well as optionally other personal information of the user, is done securely, as unauthorized future alteration of same thereafter can be utilized as a means of violating system integrity.

[0126] In one embodiment, an inductive field coil is used for programming the sensors 14 and ID of user monitoring device 10.

[0127] As illustrated in FIG. 4, the user monitoring device 10 can include a sensor 14 with an output that be received by an amplifier 56 and decoded by an I/O decoder 58 to determine I/O logic levels, as well as, both clock and data information 60. Many such methods are commonly available including ratio encoding, Manchester encoding, Non-Return to Zero (NRZ) encoding, or the like; alternatively, a UART type approach can be used. Once so converted, clock and data signals containing the information bits are passed to a memory 62. Any of these connections provides a logical link from the system's database 18 to the sensor 14, ID of the user monitoring device 10, as shown in FIG. 5.

[0128] In one embodiment, illustrated in FIG. 5, the system 32 chooses the necessary programmable sensor functions and stores them into database 18. In one embodiment, in order to insure that an unauthorized user cannot connect into and program user monitoring device 10 the following procedure may be used:

[0129] Both the sensor 14 and receiver 34 contain an identical, repeatable pseudo randomization algorithm in ROM or in ASIC logic.

[0130] Referring to FIG. 6, the algorithm is applied to outgoing programming data 64 from system 32 and produces a number of security/randomization bits 66 that can be appended to the outgoing programming message or message 68 and sent to a sensor 14.

[0131] Referring to FIG. 7 the sensor 14 likewise applies this pseudo randomization algorithm as the security/randomization bits 66 to the outgoing programming data, now forming the incoming programming data 70 to sensor 14 and produces a several bit result in the shift register 71. The scrambling algorithm is devised such that a small difference in the programming bit stream causes a great difference in the pseudo randomization result. As a non-limiting example, the present invention can use a 16 bit polynomial to produce this pseudo randomization.

[0132] Optionally, in one embodiment, before a sensor 14 accepts this programming, stored in an address and personality register 73, both the pseudo random code, stored in data in a shift register 75 from system 32 and a sensor 14, in a shift register 71 must match via a comparator ID, 77, indicating unauthorized acceptance use. In addition to insuring authorized access, this process also insures that the data itself is correct. The longer the polynomial sequence used, the greater the security.

[0133] In one embodiment, spread spectrum or other RF transmission is used and can include programming to determine that the frequency or spread spectrum code is unique to the area. If a spread spectrum code, system code, or frequency channel is found to be occupied at a future time of use. Re-programming of the user monitoring device 10 is then done with a new, unused spread spectrum code or system code or frequency channel can be selected, or, in the alternative, CPU 20.

[0134] As illustrated in FIG. 5, step "E" would include, for example, the step of the sensor 14, inputting the programming message and saving a seed in memory 62; with the sensor 14 utilizing the seed to code digital data bits transmitted.

[0135] As illustrated in FIG. 8, the location of a user monitoring device 10 with the ID and sensors 14 can be determined. As a non-limiting example, in one embodiment the user monitoring device 10 includes a sensor 14 that can provide a position signal having positioning data (e.g., raw GPD data or pseudo ranges) and the ID is transmitted from the user monitoring device 10 to system server 16. Server 16 receives the position signal and analyzes the signal to generate information representing the location of the user monitoring device 10. Server 16 transmits this location information to a client computer where the location of the user monitoring device 10, allowing a user to identify the location of the remote sensor 14.

[0136] In one embodiment, the position signal transmitted by the remote sensor 14 can also include an emergency code. For example, in the event of an emergency, such as a medical emergency or otherwise, a user may press a "panic button" that can be on the user monitoring device 10 or by use of a user's mobile device. Pressing the panic button may cause mobile device 74 to transmit an emergency signal to a cell site 76 where the emergency signal is relayed to server 16. In response, server 16 can transmit Doppler information regarding in-view satellites, a fix command and a time trigger signal to the user monitoring device 10.

[0137] When the location of the user monitoring device 10 has been determined, software running on server 16 configures server 16 such that a call or other signal is sent to a local emergency operator in the vicinity of remote sensor 14. When the call or signal is received at the emergency operator station, the location of remote sensor 14 is transmitted and displayed. In some cases, where separate panic buttons are available for identifying medical, police, fire or other types of emergencies, the nature of the emergency is also displayed for the emergency operator. Based on this information, the emergency operator can initiate an emergency response by providing the location of remote sensor 14 to the required emergency service (police, fire department, ambulance service, etc.). In other embodiments, instead of or in addition to a position report for the remote sensor 14, the emergency operator may also be provided with information which identifies an emergency response vehicle in close proximity to remote sensor 14.

[0138] As illustrated in FIG. 9, a sensor 14 of the user monitoring device 10 can include a SNAPSHOT GPS receiver 72. As described above, sensor 14 uses information transmitted from separately located base station 110, mobile devices, computers, and other devices, to assist in determining the position of the remote sensor 14, as more fully disclosed in U.S. Pat. No. 6,661,372, incorporated herein by reference.

[0139] As non-limiting examples, and as illustrated in FIG. 10, the sensors 14 can be a thermal transducer 78, an acoustic transducer 80, and a magnetic transducer 82. It will be appreciated that the present invention is not limited to the transducers 78, 80, and 82 in the user monitoring device 10 can communicate with a microprocessor 84 also located in the user monitoring device 10. The user monitoring device 10 can communicate with other devices via an RF transceiver 86, an IRDA transceiver 88, and/or an RF backscatter transceiver 90. Each of the components in the user monitoring device 10 receives power as necessary from the battery 24, which may include the rechargeable battery.

[0140] The acoustic transducer 80 may include a microphone, a low-pass filter, a gain amplifier, and a threshold comparator. The acoustic transducer 80 may include an omnidirectional microphone, although any other suitable acoustic transducer device would suffice. The microphone may be a surface mount MEMS device that has a frequency range of 100 Hz to 10 kHz. A single MCP602 operational amplifier is used on the acoustic sensor to amplify and low-pass filter the acoustic signal from the microphone. Another operational amplifier is used to generate a voltage reference used for single biasing and detection. The microphone output is biased to the midway point between the circuit supply voltage and ground to allow for both positive and negative signal swings. The biased signal is filtered with a second order low-pass Butterworth filter to remove upper frequency noise. It is then amplified with an adjustable gain that is controlled by a digital resistor potentiometer. This digital resistor operates on an I2C bus and is controlled by the microprocessor 84. Lastly, the amplified acoustic signal is threshold detected against a static voltage to detect sufficiently large acoustic signals. The digital output of the threshold detector is connected to the microprocessor 84 for processing.

[0141] The magnetic transducer 82 can include a magnetic sensor integrated circuit, a differential instrumentation amplifier, a low-pass filter, two gain amplifiers, and a threshold detector. The magnetic transducer 82 may include an NVE AA002-02 GMR (giant magneto resistive) field sensor, although any suitable magnetic sensor would suffice. This sensor has a saturation field of 15 Oe, a linear range of 0 to 10.5 Oe, and a sensitivity of 3 mV/V/Oe. Two MCP602 CMOS operational amplifiers are used on the magnetic sensor to amplify and low-pass filter the analog output signal. An INA122UA instrumentation amplifier is used as a difference amplifier for the differential output from the magnetic sensor. The magnetic sensor IC can be based on Spintronics technology. Its output includes a differential voltage pair proportional to the detected magnetic field. The differential voltage pair is amplified and converted to a single voltage by the instrumentation amplifier. The AC-coupled signal is then amplified and filtered with a low-pass filter to remove upper frequency noise and boost the low-voltage signal output. The signal is amplified a second time by an adjustable gain controlled by a digital resistor similar to the acoustic sensor. Lastly, the amplified magnetic signal is threshold detected

against a static voltage, to detect sufficiently large changes in magnetic fields. The digital output of the threshold detector can be connected to the microprocessor **84** for processing.

[0142] A DS1803E-010 digitally controlled 10 kOhm variable resistor can be used in both the acoustic and magnetic sensor circuits. It is used to adjust the gain of one gain stage in each circuit. The digital resistor is controlled through an I2C interface. A LMV393IPWR comparator is also used in both the magnetic and acoustic sensor circuits for determining when a sufficiently strong sensor signal has been detected. It compares the analog sensor signal against the voltage reference and its output is tied to the microprocessor **84** for data collection.

[0143] The thermal transducer **78** may include a Burr Brown TMP 100NA/250 12-bit digital temperature sensor, although any suitable thermal sensor would suffice. The digital temperature sensor has an operating range of  $-55$  to  $+120$ . degree C., an accuracy of 0.5.degree C. and a maximum resolution of 0.0625.degree C.

[0144] Even though it is a 12-bit sensor, suitable results are achieved with only 9-bit conversions with only the 8 most significant bits used. The sensor has an I2C interface and is normally kept in sleep mode for low power operation. When directed by the microprocessor **84**, the thermal transducer can perform a 9-bit temperature conversion in 75 milliseconds.

[0145] The RF transceiver **86** may include an RF Monolithic DR3000 transceiver, although any suitable transceiver or separate transmitter and receiver **34** would suffice. This transceiver **86** allows for both digital transmission and reception. The transceiver **86** can have an operating frequency of 916.5 MHz and is capable of baud rates between 2.4 kbps and 19.2 kbps. It can use OOK modulation and has an output power of 0.75 mW. It also can use digital inputs and outputs for direct connection with the microprocessor **84**. The transceiver **86** can use an antenna **92** (FIG. 11) that may include a 17 mil thick plain steel electric guitar G-string cut to a length of 8.18 cm. It is used in a monopole over ground configuration and can require a matching circuit of one inductor and one capacitor. Alternatively, Frequency Shift Keying (FSK), Quadrature Phase Shift Keying (QPSK), or any other suitable modulation scheme may be utilized.

[0146] The IRDA transceiver **88** may include a Sharp GP2W0110YPS infrared transceiver, although any suitable IRDA compliant infrared transceiver would suffice. This transceiver **88** can be IRDA v1.2 compliant and in one embodiment has an operating range of 0.7 meters. In one embodiment, it is capable of 115.2 kbps data speeds.

[0147] The RF backscatter transmission device **90** may include circuitry available from Alien Technology (of Morgan Hill, Calif.) for receiving and transmitting signals via RF backscatter. Battery **24** may be a 3.6 volt 1/2 AA lithium battery with a capacity of 1.2 amp hours. The battery **24** can be a power source **24** that can include a Texas Instruments TPS76930DBVT voltage regulator to regulate the output signal to 3 volts and with a maximum current of 100 mA. The voltage regulator can include a LDO.

[0148] The RF backscatter transceiver **86** in the user monitoring device **10** communicates with an RF backscatter reader **94** such as a class **3** reader from Alien Technology. The reader **94** transmits data to the backscatter transceiver **90** of the user monitoring device **10** by broadcasting encoded RF pulses and receives data back from the transceiver **86** by continually broadcasting RF energy to the sensor **10** and monitoring the modulated RF reflections from the sensor **10**.

[0149] The RF backscatter transceiver **90** can include a printed circuit board (PCB) patch antenna for RF reception, and RF modulation, a Schotky diode detector circuit, a comparator circuit for signal decoding, and a logic circuit for wake-up. The logic circuit monitors the incoming data, and when an appropriate wake-up pattern is detected, it triggers the microprocessor **84** so that data reception can begin. In one embodiment, the reader **94** has an operating frequency between 2402 MHz and 2480 MHz, and uses frequency hopping in this band to reduce noise interference. A modulation method used by the reader **94** can be On-Off Keying (OOK). In one embodiment, the transmission power is 1 watt. The operation of the reader **94** may be controlled by an external computer (not shown) as directed by Labview software via a RS-232 serial link.

[0150] The RF transceiver **86** can communicate with an external RF transceiver **96** such as a DR3000 transceiver from Radio Monolithics, Inc. In one embodiment, it operates at 916.5 MHz, uses OOK modulation, has a communication range of 100 meters line of sight, and a baud rate of 19.2 kbps. The active RF antenna **92** can be a quarter-wavelength monopole made from a guitar G-string and appropriate matching circuitry. Two control lines from the microprocessor **84** can be used to select the mode of operation, choosing from transmit, receive, and sleep. The active RF receiver **34** consumes the most power in receive mode compared to the other two communication links.

[0151] FIG. 6 shows the relative positioning and shape of the active RF antenna **92** and the RF backscatter antenna **98**.

[0152] The IRDA transceiver **88** of the user monitoring device **10** can communicate with an external IRDA transceiver **100** that may be identical to the IRDA transceiver **88**. Alternatively, the IRDA transceiver **100** can be one such as is provided in most personal digital assistants (PDA) as well as many other consumer devices. The IRDA communication link follows the standard IRDA signal and coding protocol and is modeled after a standard UART interface. In one embodiment, the IRDA transceiver **88** is capable of data speeds less than 115.2 kbps, and may only have a range of 0.7 meters for transmission. One advantage of the IRDA communication link is that it does not require any of the RF spectrums for operation, but it typically does require line-of-sight communication.

[0153] When any one of the transceivers **86**, **88** and **90** on the user monitoring device **10** detect the beginning of valid data on their respective communication link, all other transceivers are disabled, thereby preventing the corruption of incoming data with the noise or partial data packets on the other communication links. However, if the data on the active transceiver proves to be erroneous, the other transceivers will be re-enabled if appropriate to allow normal operation to continue. If the data received by the active transceiver is valid, however, the other transceivers will remain disabled for several hundred milliseconds longer in the high probability that the next data packet will be transmitted on the same communication link. If, after this extended delay, no additional packets are received, then the other transceivers will be re-enabled as appropriate.

[0154] In one embodiment, the active RF protocol has no wake-up or synchronization packets, and the packets sent to and from the sensor are identical. In one embodiment, the format of an active RF packet is shown in FIG. 16. It can include a preamble to reset and spin-up the state machine of the RF receiver **34** and to properly bias the receiver's **34** data

slicer/threshold detector for optimum noise rejection and signal regeneration, two framing bits to indicate the beginning and end of the data bytes, and the data bytes themselves.

[0155] Furthermore, the encoding scheme for the three symbols is shown in FIG. 12. The entire packet is DC balanced to maintain an optimal level on the data slicer/threshold detector and the receiver 34. Data is sent most significant bit first.

[0156] The IRDA communication link can follow the standard IRDA protocol for bit encoding and UART protocol for byte transmission. Packets transmitted on the IRDA link can contain no preamble or framing bits, but they do have a header that contains two bytes. The first byte is an ASCII "P" which denotes the beginning of a valid IRDA packet. The second byte equals the number of preceding bytes in the packet. This value is used by the receiver 34 to determine when the entire packet has been received and processing of information can begin. The packet structure is shown in FIG. 13 and the IRDA/UART encoding scheme is shown in FIG. 14.

[0157] The data bytes contained in a packet transmitted to the sensor 10 through any of the communication links conform to a packet format. The CMD section of a packet is a single byte that identifies the type of packet being sent. The CMD byte appears above the beginning and end of the packet and the two must be identical. The reason for including the redundant byte is to further eliminate the chance of a packet's CMD identifier being corrupted at the receiver 34, even if the CHECKSUM is correct.

[0158] The PAYLOAD contains all of the data that must be sent to, or returned from, the sensor. The PAYLOAD is broken down into individual bytes with the overall number of bytes and their content dependent on the type of packet being sent.

[0159] The CHECKSUM is a 16-bit CRC that is performed on all bytes in the data packet excluding the end CMD byte in packets generated by the external device. The CHECKSUM is sent most significant byte first.

[0160] The transceivers 86, 88 and 90 may be required to communicate over a greater distance than do the components described herein. Upgrading these components to be suitable for longer distance transmission is considered to be within the spirit of this invention. The type of transducer is not limited to the specific transducer types described herein. In addition, the logic described herein for arbitrating between which communication device to use to communicate with the outside world and which sensor data to provide at what time is but one possible approach to arbitration logic within such a remote sensor 10.

[0161] In one embodiment, illustrated in FIG. 15, an activity manager 218 is provided that is used for managing lifestyle activities of the user. Activity manager 218 can be a standalone device, or as part of the telemetry system 32 or monitoring device 10. The dynamic activity manager 218 can associate one or more contexts such as time, location, and the like to an activity entered by a user. The dynamic activity manager 218 also manages an activity and any device or item associated with the activity.

[0162] In one embodiment, one or more of sensors 14 can be a lifestyle sensor. For example, the sensor 14 can be a physiological sensor such as a heart rate sensor, body temperature sensor, caloric sensor, or the like. Another example of a sensor is a pedometer. It should be noted that any sensor or device capable of taking measurements is applicable to the present invention. These sensors can be embedded, for example, in clothing and/shoes or can be stand-alone items.

One specific example of these types of sensors is a sensor that is embedded in running shoes. As a user walks or runs, the sensor 14 monitors various functions such as speed, stride length, body functions (heart rate, temperatures, hydration, and the like), and the like.

[0163] This information can then be relayed back to the dynamic activity manager 218 if desired. A web service 224 can be any type of service subscribed to by the user over the Internet. For example, a user can be subscribed to a weather service that is used by the dynamic activity manager 218 when monitoring an activity such as running. The dynamic activity manager 218, identifier enable items, including but not limited to RFID enabled items 220, sensors 14, and Network System 224 are discussed in greater detail below.

[0164] The dynamic activity manager 218 provides management for managing user lifestyle activities and is preferably included as part of the telemetry system 32. In one embodiment, the activity manager 218 is in communication to a user interface 202, which can be at the monitoring device 10, for allowing a user to enter information associated with an activity that the user wants managed and/or monitored. As a non-limiting example, FIG. 17 shows one example of the user interface 202 being displayed on the monitoring device 14. It will be appreciated the sensors can generate this information and communicate it with telemetry system. It should be noted that some fields can be automatically populated based on user activity entry, activity history, rules, or the like.

[0165] In one embodiment, a name entry field 302 can be used that allows the user to enter the name of an existing activity or the field 302 can be a drop down box including existing activities. In another embodiment, the monitoring device 10 or the telemetry system 32 can perform this activity and function.

[0166] FIG. 16 show that a user has entered the activity of "running". Therefore, the user is configuring the activity manager 218 to manage and monitor a running activity. The user interface 202 can also include an activity description field 304, which allows a user to enter a description of the activity. A date entry field 306 is also included on the user interface 202. The date field 306 allows a user to enter the date or dates when the activity is to occur. A time start field 308 and an end time field 310 are also provided in the user interface 202. The start time field 308 indicates when the activity begins and the end time field 310 indicates when the activity ends.

[0167] A user may also want the activity manager 218 to track specific items associated with the activity. For example, with respect to the running activity, a user may want to have her running shoes and headphones tracked to ensure that she has these items when she begins the activity. This information can be entered in the items to be tracked field 312. The tracking process is discussed in further detail below. The user may also want to use specific sensors 14 during the activity such as sensors 14 in the running shoes and a heart rate monitor. The sensor IDs or names can be added into the sensor field 314. A user can also configure the sensor parameters that she wants used during the activity. Alternatively, the sensor parameters can be transparent to a user. For example, the parameters can be pre-populated based on success of data collection of prior activity history. This information is entered in a sensor parameter field 316. In addition to having items tracked and sensors 14 monitored during the activity, the user may want to associate a web service with the activity.

[0168] For example, a user may want to associate a weather service with the running activity so that the activity manager 218 can automatically and dynamically adjust settings on the sensors 14; determine to track different items; and the like. For example, the activity manager 218 can monitor the web service to determine if the weather is sunny, cloudy, raining, or the like. If the weather is sunny, the activity manager may determine that a first pair of running shoes, sun glasses, and the like need to be tracked. On the other hand, if the weather is raining, the activity manager 218 can determine not to track sunglasses and to track a second pair of running shoes. It should be noted that the term “tracked” as used throughout this discussion refers to use of the ID of the monitoring device.

[0169] Alternatively, a user can setup rules that allow a web service to perform a function based on contexts. For example, if the weather is rainy, a user can have a rule setup that has a web service make a reservation at an indoor track. FIG. 16 also shows a web sensor rule(s) entry field 320. The web service field 320 allows a user to enter various rules associated with Network Systems. For example, a user can setup a web service via the web service rules field 320 to reserve a running track if the temperature outside is less than 60° F. or if it is raining.

[0170] It should also be noted that the user interface of FIG. 16 is only one example of a user interface applicable to the present invention. One or more fields may be added or deleted. For example, the user interface 218 can also provide a mechanism to a user for reviewing all entered activities, deleting activities, and the like. It should also be noted that the user interface 202 can also reside on an information processing system coupled to the monitoring device 14. For example, the activity manager 218 can have software loaded on a personal computer that allows the user to enter the above information or to interact with the activity manager 218. The activity manager 218 can then sync with database 18 to update its data. In yet another embodiment, a user can enter information directly at an identifier enabled item 220 or a sensor 14. For example, a sensor 14 can include a user interface with a calendar. Any information entered here can then be synced with the activity manager 216. Any configuration parameters such as a heart rate baseline, stride length, and the like are then communicated to the activity manager 218.

[0171] Referring again to FIG. 15, the information received from a user, for example, via the user interface 202 can also be provided to a calendar 204 residing within the monitoring device 14. Alternatively, information from the calendar 204 can also be extracted by the activity manager 218. For example, if the activity manager 218 determines that a user has entered a new activity in the calendar 204, the activity manager 218 can prompt the user to determine if the user wants the activity manager 218 to monitor and manage that activity. Although shown residing outside of the activity manager 218, the activity manager 218 can include an internal calendar for monitoring lifestyle activities. In other words, the monitoring device 14 can include a calendar and the activity manager 218 can also include an internal calendar used in conjunction with the wireless device calendar 204.

[0172] Based upon the received activity information, the activity manager 218 creates activity profiles 210, 212 that are stored in an activity management database 208. FIGS. 17(a) and (b) shows an example of an activity profile 210 for a variety of activities. Although FIGS. 17(a) and (b) show a single table that includes multiple activities, each activity can

be stored within a separate activity profile. FIG. 18 also shows a calendar 204 comprising calendar events associated with an activity. The activity profile 210 includes various information associated with an activity such as a name 404 of an activity, an activity ID 406, a sensor or device name 408 associated with the activity, an identifier/device IP address 410 if available, data configuration 412 for the sensor/device and the like.

[0173] Also, FIGS. 17(a) and (b) show Network Systems 414 and web service rules 416 associated with a web service. For example, a web service A is associated with the “running” activity. A web service rule is associated with the web service A that indicates that if the temperature outside is less than 60° F. then reserve an indoor track. As can be seen, the activity profile associates a sensor/device context with activity. The sensor/device context indicates what sensors 14/devices or associated with the activity and their current configurations.

[0174] In the example of FIG. 18, the information within the activity profile 210 is independent of a time context or location context associated with an activity. In one embodiment, the calendar 204 associates a time context with and activity and an optional location context. For example, FIG. 18 shows a calendar event 402 set for May 2nd with a “running” activity from 2 p.m. to 3 p.m. The calendar 204 can also show the location of the activity such as “Millennium Park”. Therefore, the “running” activity has a time context and a location context associated with it. The information within the activity profile 210 can be used by the activity manager 218 regardless of the time and location contexts.

[0175] For example, if the user has defined a “running” activity on two different days at two different times and at two different locations, the activity manager 218 can still refer to the “running” activity profile and use the information included therein for the two instances of the “running” activity. Therefore, the activity manager 218 monitors both the calendar 402 and the activity management database 208. However, the activity profiles 210 can also include time and location contexts as well. In this example, a separate activity profile is stored in the activity management database for each instance of an activity.

[0176] Returning now to FIG. 16, the activity manager 218 also includes a context monitoring module 210. In one embodiment, the content monitoring module 210 allows the activity manager to determine whether an activity is about to start, has started, or has ended and either monitor for identifier enabled items 220 and/or initialize sensors 14 associated with the activity. For example, the context monitoring module 210 monitors context such as time, location, device, and the like. The context monitoring module 210 can monitor the calendar 204, GPS, or information entered by the user to determine the current and/or location of the wireless device. The activity manager 218 can compare activity profiles and/or calendar events with the determined time and/or location to determine whether an activity is starting, ending, or the like.

[0177] In one embodiment, the dynamic activity manager 218 is communicatively coupled to a GPS module 246 and a display 244. The GPS module can be used by the dynamic activity manager 218 to determine the location of the monitoring device 14. The display 244 can be used for, among other things, to display data/information, visual alerts to a user.

[0178] As discussed above, the activity manager 218 manages and monitors identifier, enabled items 220, sensors 14, and Network Systems 224 associated with a user activity. The identifier enabled items 220 can be any item that is coupled to

an identifier or other communication tag. The activity manager 218 monitors identifier enabled items 220 via an identifier enabled item monitor 206, herein referred to as the “identifier monitor” 206. The identifier monitor 206, in one embodiment, can be an identifier transceiver embedded with monitoring software or can be a separate monitoring software module coupled to an identifier transceiver.

[0179] The identifier monitor 206 can be configured by the user to automatically start monitoring for items associated with an activity or to continuously monitor for identifier enabled items 220. For example, when the activity manager determines, based on a time context and/or a location context associated with an activity, that it is time for an activity to start, the activity manager 218 can begin monitoring for associated identifier enabled items 220. For example, if the activity manager 218 determines that the running activity is about to begin, the identifier monitor analyzes the activity profile 210 to determine what items are needed for the activity. The identifier monitor 206 then determines if items such as running shoes and heart beat monitor are present. In other words, the identifier monitor 206 determines if an identifier signal from the running shoes and the heartbeat monitor has been detected. The activity manager 218 can then visually, audibly, and/or tactilely notify the user of the presence or non-presence of the items 220.

[0180] Based on the activity profiles 210, calendar 204, and/or an internal clock the activity manager 218 can determine that the user has not left for work, to go running, or whatever the activity may be. For example, a user can have a calendar entry or an activity defined for “leave for work”, which begins at 8:00 a.m. Therefore, if the time is 7:30 a.m. the activity manager 218 can determine that the user has not left for work. In another example, a user can have an activity defined for “running”. The activity manager 218 can detect that the user has left the house, entered his/her car or the like either by passing an identifier sensor at a door or via GPS and analyzes the activity profiles 210 accordingly.

[0181] The activity manager 218, based on activity profiles and/or calendar events determines that the user is going straight from work to her running activity. Therefore, the activity manager 218 monitors for the items associated with the running activity. The activity manager 218 then notifies the user if these items have been protected

[0182] In addition to monitoring for associated identifier enabled items 220 when an activity is to begin, the activity manager 218 manages sensors 14 associated with the activity. For example, when an activity is about to begin, the activity manager 218 analyzes the activity profile 210 associated with the activity and identifies the sensors 14 associated with the activity. If the sensor 14 has not been initialized, the activity manager 218 initializes the sensor 14 using the configuration parameters in the activity profile 210. For example, the sensors 14 and the monitoring device 14 can communicate via a communication manager 212 within the activity manager 218. The sensors 14 and the monitoring device 14 can communicate using a wireless connection such as BLUETOOTH®, Zigbee, or the like. In one embodiment, the dynamic activity manager also includes a data fusion module 214 for performing data fusion with respect to health and fitness information monitored by the sensors 14.

[0183] FIG. 18 shows a timing diagram for one example of initializing a sensor 14 based on the activity manager 218 detecting the start of an activity. In the example of FIG. 18, a user has a “running” activity defined on the user’s monitoring

device 14 and wants to invite a friend to the activity. At time T0 the activity manager 218 sends an invite associated with the “running” activity to another wireless device. The invite includes the time context, e.g., May 2nd at 2 p.m., and can include an optional location context. At time T1 the invitee wireless device sends an acceptance message to user’s monitoring device 14. At time T2, the activity manager 218 determines that the time is 2:00 p.m. and queries the activity management database 208 to identify the sensors 14 associated with the “running” activity. The activity manager 218 also obtains the IP address of the sensor(s) 14. The IP address is used by the communication manager 212 to communicate with the sensor 14. In one example, the sensors 14 associated with the running activity are a sensor within running shoes that measures average speed, distance traveled, and the like. Another sensor can be a heart rate monitor worn in the wrist or an audio headset of the user.

[0184] At time T3 the activity manager 218 pings the sensors 14 to determine if they have been initialized. If the sensors 14 have not been initialized the activity manager 218 identifies that configurations parameters of the sensor from the activity profile 210 and initializes the sensors 14 accordingly. The sensors 14, at time T4, send a ready response to the activity manager 218. At time T5 the activity manager 218 begins collecting data from the sensors 14. The activity manager 218, at time T6, determines that the activity has completed. At time T7, the activity manager 218 displays collected data from the sensors 14 to the user via the user interface 202.

[0185] In another embodiment, a user can configure the activity manager 218 to only collect specific data from a sensor 14 or not all data. Also, the activity manager 218 does not have to communicate with a sensor 14 during an activity. For example, a user may have forgotten the monitoring device 10 at her house. The application manager 218 determines that an activity is starting, but sensors 14 are not in the vicinity. When sensors 14 come back into range with the monitoring device 14, e.g., the user comes home from running, the activity manager 218 queries the sensor 14 for the data collected during the activity. In one example, the sensors 14 collect data continuously and in another example the sensor 14 only collects data during scheduled activities. For example, a user’s watch may have a biometric sensor that collects data throughout the day. However, the user may only be concerned with plotting data during athletic activities such as bicycling. Therefore, the activity manager 218 can query the sensor 14 for data only collected during a bicycling activity. In the above embodiments, the sensors include memory for storing data.

[0186] As illustrated in FIG. 2, the activity manager 218 can also monitor and manage Network Systems 224 associated with an activity. For example, a user can define rules associated with Network Systems 124 that are to be applied to the activity manager 218 with respect to an activity. One example is where a user subscribes to a weather service. The user can define a rule that states if the weather is rainy during the time period associated with an activity, then delay any monitoring or managing for that activity for 1 hour. Another rule can state to delay any managing or monitoring until a user prompt is received. The activity manager 218 can query the web service 124 at the start or prior to an activity starting to obtain the required information.

[0187] The activity manager 218 can also make dynamic decisions for when to monitor and/or manage an activity. For

example, a user has an activity defined for “pick up dry-cleaning” at 3:00 p.m. However, at 12:00 p.m. the user runs errands and is approaching the dry cleaners. The activity manager 218 can detect the location of the user via GPS and determines that the user is near the dry cleaners. The activity manager then determines that the user needs to pick up the dry cleaning and prompts the user to pick up the dry cleaning even though the time is prior to the 3:00 p.m. scheduled pickup time.

[0188] FIG. 19 is a block diagram illustrating a detailed view of the wireless device 104 according to an embodiment of the present invention. The wireless device 104 operates under the control of a device controller/processor 602, that controls the sending and receiving of wireless communication signals. In receive mode, the device controller 602 electrically couples an antenna 604 through a transmit/receive switch 606 to a receiver 608. The receiver 608 decodes the received signals and provides those decoded signals to the device controller 602.

[0189] Referring now to FIG. 20, monitoring device 10 and/or telemetry system 32 can include a feedback system or subsystem 710 coupled to processor 20 and/or 34 to communicate feedback data back to the monitoring device 10. In one embodiment, the feedback system or subsystem 710 can generate and communicate closed-loop control data (“CCD”) 712 to monitoring device 10. For example, closed-loop control data 712 can provide feedback to the monitoring device user or patient. It will be appreciated that feedback system or system 710 can be included in monitoring device, telemetry system 32 or be a standalone system or subsystem.

[0190] In another embodiment, feedback system or subsystem 710 can generate and communicate signals 714 for video/audio data communication to the monitoring device user or patient.

[0191] In another embodiment feedback system or subsystem 710 can generate and communicate monitoring device user or patient control data (“PCD”) 716 to the monitoring device user or patient. In another embodiment, feedback system or subsystem 710 generates and communicates sensing control data (“SCD”) 718 to a feedback system 720 associated with the monitoring device 10 for providing feedback to the monitoring device user or patient. Signals and data 712 through 718 can be converted into signals for executing feedback information, visual, audio and the like, to the monitoring device user or patient.

[0192] An example of feedback system or subsystem 710 includes, but is not limited to, a feedback engine installed as software and/or firmware on any type at the telemetry system 32. In one embodiment, the feedback system or subsystem 710 is at monitoring device 10 and receives feedback signals from telemetry system.

[0193] FIG. 21 is a flow chart 700 illustrating one embodiment of providing feedback and/or alerts to a user through or without monitoring device 10. Flow chart 700 and other flow charts presented herein are intended to illustrate the functional operation of the device feedback system or subsystem 710 and should not be construed as reflective of a specific form of software or hardware necessary to practice the methods described. It is believed that the particular form of software will be determined primarily by the particular system architecture employed in the device and by the particular detection and electrical stimulation delivery methodologies employed by the device.

[0194] At block 702, user or patient feedback is detected. Examples of feedback include but are not limited to lifestyle parameters, medical conditions, lifestyle events, exercise parameters, battery 24 life of the monitoring device 10, battery 24 replacement required, lead or sensor 14 function, pending therapy delivery, and the like. The type of feedback and alert conditions detected can vary.

[0195] At block 704, a feedback or alert is selected that is associated with a detected feedback or alert condition. Selection of a feedback or alert signal may involve the selection of any of the above listed parameters listed above relative to user or patient, used to control the feedback or alert signal. At block 706 the feedback or alert signal is delivered according to settings selected at block 704.

[0196] At block 708, a sensor 14 signal is measured at telemetry system 32 or monitoring device 10, analyzed and compared to a threshold level corresponding to the selected alert level at block 710. An alert threshold level may be predefined or tailored to a given monitoring device user or patient. If the measured sensor 14 response does not correspond to an expected threshold signal level or characteristic pattern of the selected feedback or alert signal, the feedback or alert signal is adjusted at block 712 in a closed-loop feedback method until the sensor signal measured at block 708 falls within a desired range of an expected threshold level, as determined at block 710. Once the desired feedback or alert signal level is reached, the feedback or alert signal stimulation parameters are maintained at the current settings at block 714 to maintain the sensor signal measurement within a desired range of the threshold. Maintaining the feedback or alert signal response within a desired threshold range promotes the reliability of the feedback or alert signal in informing the monitoring device user or patient of a detected parameter described above.

[0197] Determining that the sensor signal corresponds to a selected feedback or alert threshold at block 710 may involve detecting a magnitude of the a sensor signal amplitude or frequency, and/or recognizing an intended alert pattern (e.g. short-long burst sequences, strong-weak burst sequences, or the like) based on a morphology of the sensor signal. As such, measuring the sensor signal at block 708 may involve measuring signal magnitude as well as frequency characteristics during the feedback or alert signal delivery.

[0198] Additionally or alternatively, frequency characteristics of the sensor signal may be determined to detect sensor 10 signals. The frequency power band of the sensor may be analyzed for correspondence to frequency, amplitude and the like. Additionally, a sensor waveform may be evaluated for correspondence to a frequency or amplitude. A combination of the amplitude and frequency of the sensor signal may also be measured to determine a monitoring device user or patient medical or lifestyle condition.

[0199] The feedback or alert signal may be terminated if a predetermined maximum alert duration has expired, as determined at block 716. If a maximum feedback or alert signal duration is not reached, the feedback or alert signal may continue to be held at the current stimulation signal settings at block 714 until the alert expires. Alternatively, the process may return to block 708 to continue monitoring the sensor signal throughout the duration of the alert delivery in order to make further adjustments at block 712 as needed to maintain a desired strength and pattern of the monitoring device user or

patient feedback or alert signal. If the feedback or alert signal maximum duration is reached, the signal may be immediately terminated at block 722.

[0200] In some embodiments, if a monitoring device user or patient acknowledgement signal is received prior to the maximum signal duration expiring, as determined at decision block 718, the feedback or alert signal is terminated at block 722. A monitoring device user or patient acknowledgment may be in a variety of forms.

[0201] In one specific embodiment, if monitoring device user or patient acknowledgement is not received or detected at block 718, the intensity of the feedback or alert signal may be increased at block 720, steadily or in step-wise, pre-determined intervals within a feedback or alert signal maximum duration. It will be appreciated that monitoring device user or patient acknowledgement is not required. The intensity may be increased at block 720 according to a predefined pattern by increasing pulse amplitude (up to some maximum), increasing pulse width, increasing pulse frequency or other adjustment that causes a relatively stronger contraction, i.e., greater recruitment of the muscle being stimulated. Adjusting the intensity of the feedback or alert signal at block 720 may also be performed using sensor signal feedback control by returning to block 708 to compare measured sensor signal characteristics to a next higher feedback or alert signal threshold level. In other words, the sensor signal is compared to a different, increased intensity, threshold than an initial threshold in order to control the feedback or alert signal to elicit a stronger response as compared to the initial feedback or alert signal settings. Thus for a given alert condition, multiple alert intensity levels may be stored in the telemetry system 32 memory along with multiple expected sensor signal responses or thresholds for each intensity level. The sensor signal is used in a closed-loop feedback method to adjust feedback or alert signal control parameters to achieve a feedback or alert signal with the desired intensity at each level.

[0202] The feedback or alert signal may be delivered continuously, with continuous or stepwise increasing intensity according to a predefined pattern, until either a maximum alert duration is reached or a monitoring device user or patient acknowledgement is received. In other embodiments, a feedback or alert signal may be delivered intermittently until monitoring device user or patient acknowledgement or expiration of a maximum feedback or alert signal duration, whichever occurs earlier. When delivered intermittently, the feedback or alert signal is delivered at an initial intensity for a predefined alert interval. The feedback or alert signal is held at the current settings at block 714 until the alert interval has expired as determined at block 719. If the alert interval expires, the intensity is increased at block 720 and the feedback or alert signal is resumed for another feedback or alert signal interval at block 721. A pause between differing feedback and alert signal intensities may be applied. As a non-limiting example, the feedback or alert signal may be delivered for a 30 second interval at an initial intensity. This process may continue until a maximum alert duration is reached as determined at block 716, or monitoring device user or patient acknowledgement is received at block 718.

[0203] As non-limiting examples, a maximum alert duration may be set at 5 minutes, 10 minutes, 30 minutes, one hour or more and may be set differently for different alert conditions, e.g. according to the seriousness of a particular alert condition. Alert intervals applied during the maximum alert duration may be set differently for different alert conditions

and different alert intervals may be applied during a given maximum alert duration. For example, the alert intervals may increase in length as feedback or alert signal intensity is increased.

[0204] The same is true relative to the amplitude and duration of the alert signal.

[0205] If a maximum alert duration is not reached the alert is terminated at block 722 and optionally repeated at a later time. As described above, a maximum alert duration may correspond to a continuously delivered feedback or alert signal, which may be increased in intensity according to a predefined pattern, or an intermittently delivered feedback or alert signal that includes successive intervals of increasing intensity of the feedback or alert signal with intervening pauses of no feedback or alert signal.

[0206] In some embodiments, initial feedback or alert signal settings may be "learned" over time, based on a monitoring device user or patient's response to prior alerting attempts. When a monitoring device user or patient acknowledgement is received at block 718, the feedback or alert signal control parameters are stored at block 723. These alert settings may be used as the initial feedback or alert signal settings the next time the same alert condition is detected (or another condition using the same feedback or alert signal). These stored settings can also be used for further analysis. In one embodiment, the user or patient can provide input relative to the feedback or alert signal. This input can be used to adjust the thresholds for the alerts. In this way, if a previous alert was generated and no monitoring device user or patient acknowledgement occurred until a particular sensor signal amplitude or frequency measurement was reached, the next time the alert is generated, the alert is delivered using a lower setting at which a monitoring device user or patient acknowledgement occurred to improve responsiveness of the monitoring device user or patient to feedback or alert signals.

[0207] Adjustment of user or patient parameters at block 712, as the result of an input provided by the user or patient can be provided for maintaining a feedback or alert signal within a targeted threshold level.

[0208] The monitoring device 10 and/or the telemetry system 32 can include a feedback loop. User and patient profiles can be stored in database 18, which can include a non-volatile memory. A user or patient can input information 64 about the desired circumstances or parameters relative to a parameter that is measured by a sensor 14. The processor 20 and/or 34 can include a variety of different user and patient profiles relating to information obtained from sensors 14. The processor 20 and/or 34 can customize by either scaling or modifying the user or patient profile based on additional user or patient input information.

[0209] Furthermore, feedback or alert signals corresponding to different alert conditions may be distinguished by the monitoring device user or patient by delivering the feedback or alert signals to different body locations. When feedback or alert signals are delivered to different body locations, multiple sensors may be required in the telemetry system 32 system such that a sensor signal responsive to alert stimulation at each body location is available. Depending on the number of body locations and relative distance there between, one or more sensors may be implanted in order to provide at least one sensor in operative relation to each of the targeted alert stimulation sites.

[0210] FIG. 22 is a flow chart, illustrating one embodiment for a method of establishing control parameters for a moni-

toring device user or patient feedback or alert signal and a sensor signal threshold range for the feedback or alert signal. At block 802, a set-up procedure is initiated. In one embodiment, this can be achieved using an external programmer having a user interface. In another embodiment, information from the telemetry system database 18 that has been collected is utilized, along with any user or patient input. The process shown in flow chart 800 may be performed at any time. In one embodiment, it is done at the time the user or patient is connected to monitoring device 10. In another embodiment, it is done at a time subsequent the initial connection of the user or patient to the monitoring device 10. The process allows the establishment alert conditions and corresponding feedback or alert signals tailored to a particular monitoring device user or patient's needs. An alert condition is selected at block 804, which may be any of the parameters listed above, that receive input from a sensor 14. Alert conditions may be predefined or customized for a monitoring device user or patient.

[0211] At block 806, a feedback or alert signal pattern for the alert is selected from a person or from telemetry system database 18, and the like, which may be a default pattern for a selected alert condition or customized using any combination signals from sensors 14. Various parameters controlling the alert signal may be programmable.

[0212] Optionally, at block 808 a test signal is delivered to the monitoring device user or patient according to a selected sensor signal value. In one embodiment, the sensor signal is measured during the test signal at block 810, which may include measurements of both signal magnitude and frequency characteristics. At block 812, the patient/user may optionally provide input to establish whether the test signal is adequately perceivable and distinct from any other feedback or alert signals that have already been established. User or patient feedback may be received by a user interface included in a monitoring device 10, home monitor, device programmer, or other external device in communication with the telemetry system 32. User or patient feedback may be received by a variety of different ways known in the art when the signal is acceptable or using a signal transmitted by telemetry system 32 or monitoring device 10. A feedback or alert signal may be unacceptable to the monitoring device user or patient.

[0213] If the signal is not acceptable to the monitoring device user or patient, or not adequately measured by a sensor 14 to facilitate closed-loop feedback of the signal, as determined at block 814, one or more feedback or alert signal control parameters is adjusted at block 816, and the process at blocks 808 through 814 repeats until an acceptable feedback or alert signal is established. The feedback or alert signal settings and the sensor signal characteristic(s) associated with the acceptable feedback or alert signal are stored at block 818 to establish a threshold range of the magnitude and/or frequency characteristics of the sensor signal for the given feedback or alert signal.

[0214] If additional alert conditions can be detected by the telemetry system 32, as determined at block 820, a unique feedback or alert signal pattern can be selected for the next alert condition by returning to block 804 and repeating the process shown in blocks 804 through 818. Each alert condition may be assigned a unique monitoring device user or patient feedback or alert signal that is established by storing expected sensor signal characteristics with corresponding feedback or alert signal parameters. The monitoring device user or patient can provide feedback such that each feedback

or alert signal is easily perceived, recognized and distinguished from other feedback or alert signals.

[0215] For each acceptable feedback or alert signal, a sensor threshold level is established, which may include both a magnitude component and a frequency component. The stored sensor signal thresholds allow the feedback or alert signal to be adjusted as needed during an actual monitoring device user or patient alert to most closely match the magnitude and/or frequency characteristics of the established feedback or alert signal. The monitoring device user or patient can be "trained" to recognize different feedback or alert signal patterns, intensities (strength or duration of the muscle response), and/or locations and their correspondence to different alert conditions.

[0216] Once all sensor-based threshold characteristics have been stored for all alert conditions, the process is terminated at block 822. The stored sensor signal data can then be used in a closed-loop feedback method for controlling feedback or alert signal stimulation parameters during normal operation of the telemetry system 32 as described in conjunction with FIG. 21.

[0217] As illustrated in FIG. 21, one or more analysis tools 724 at the telemetry system 32 the user information and produces analysis information that is sent to the telemetry system 32. The one or more analysis tools 724 can be part of or separate from the database 18.

[0218] The database includes base standards for at least one of user, activities, behaviors, habit information and health information that is indicative of a healthy lifestyle of activities, behaviors, habit information, exercise programs and health condition. The user information received from the monitoring device 10 is analyzed relative to the base standards in the database. In one embodiment, the base standards in operation are updatable. The update information includes updated base standards.

[0219] The foregoing description of various embodiments of the claimed subject matter has been provided for the purposes of illustration and description. It is not intended to be exhaustive or to limit the claimed subject matter to the precise forms disclosed. Many modifications and variations will be apparent to the practitioner skilled in the art. Particularly, while the concept "component" is used in the embodiments of the systems and methods described above, it will be evident that such concept can be interchangeably used with equivalent concepts such as, class, method, type, interface, module, object model, and other suitable concepts. Embodiments were chosen and described in order to best describe the principles of the invention and its practical application, thereby enabling others skilled in the relevant art to understand the claimed subject matter, the various embodiments and with various modifications that are suited to the particular use contemplated.

What is claimed is:

1. A method for using telemetry data based on user habit information or user monitoring, comprising:

detecting or measuring with one or more sensors of a monitoring device user information selected from of at least one of, a user's activities, behaviors and habit information, and a user's health, the monitoring device including ID circuitry with an ID storage that contains a unique user ID, a communication system which reads and transmits the unique user ID from the ID storage, a power source and a pathway system;

receiving the user information at a telemetry system that includes a database; and  
analyzing the user information with one or more analysis tools at the telemetry system; and  
producing analysis information that is sent to the monitoring device.

2. The method of claim 1, further comprising:  
providing feedback to the user in response to producing the analysis information.

3. The method of claim 1, further comprising:  
providing an alert to the user in response to producing the analysis information.

4. The method of claim 1, further comprising: providing a list of actions for a user to take in response to the producing the analysis information.

5. The method of claim 4, further comprising:  
accessing from the database base standards selected from at least one of user, activities, behaviors, habit information and health information that is indicative of a healthy lifestyle of activities, behaviors, habit information, exercise programs and health condition.

6. The method of claim 5, further comprising:  
using at least one of the base standards in the database to analyze the user information from the telemetry system.

7. The method of claim 5, further comprising:  
updating the base standards.

8. The method of claim 1, further comprising:  
associating one or more contexts of a user activity or health parameter.

9. The method of claim 1, further comprising:  
using an activity manager to associate the one or more contexts of the user activity or health parameter.

10. The method of claim 11, further comprising:  
communicating one or more feedback signals or alerts to the user.

11. The method of claim 11, further comprising:  
providing control data to the monitoring device.

12. The method of claim 1, further comprising:  
communicating feedback at the telemetry device to the user using an audio device or display.

13. The method of claim 10, wherein the feedback signal or alert is selected from at least one of, lifestyle parameters,

medical conditions, lifestyle events, exercise parameters, battery of the monitoring device, sensor function, pending therapy delivery, medical alerts, a status of a medical condition and a medical measurement or parameter.

14. The method of claim 1, further comprising:  
comparing a measured sensor signal from a sensor from the monitoring device to a threshold level.

15. The method of claim 14, further comprising:  
predefining or tailoring the threshold level to a monitoring device user or patient.

16. The method of claim 14 further comprising:  
adjusting the measured sensor signal until it falls within a desired range of an expected threshold level when the measured sensor signal does not equal or exceed the threshold level.

17. The method of claim 14, further comprising:  
maintaining feedback or alert signal responses at current settings when a desired feedback signal or alert level is reached to maintain a measured sensor signal within a desired range of the threshold.

18. The method of claim 10, further comprising:  
detecting an amplitude or frequency of a measured sensor signal.

19. The method of claim 18, further comprising:  
providing feedback to the user in response to detecting amplitude or frequency of the measured sensor signal.

20. The method of claim 10, recognizing an intended alert pattern based on a morphology of a measured sensor signal.

21. The method of claim 13, wherein the feedback system or subsystem in operation analyzes a frequency power band of the measured sensor signal for correspondence to frequency and amplitude.

22. The method of claim 13, wherein the feedback system or subsystem in operation evaluates a measured sensor signal waveform for correspondence to a frequency or amplitude.

23. The method of claim 10, wherein the feedback system or subsystem in operation terminates the feedback signal or alert if a predetermined maximum alert duration has expired.

24. The method of claim 1, wherein when a maximum feedback signal or alert duration is not reached, the feedback signal or alert is held at current signal settings.

\* \* \* \* \*

专利名称(译)	使用一个或多个分析工具的用户或患者监测方法		
公开(公告)号	<a href="#">US20140247156A1</a>	公开(公告)日	2014-09-04
申请号	US13/961599	申请日	2013-08-07
[标]申请(专利权)人(译)	你好		
申请(专利权)人(译)	HELLO INC.		
当前申请(专利权)人(译)	HELLO INC.		
[标]发明人	PROUD JAMES		
发明人	PROUD, JAMES		
IPC分类号	A61B5/00		
CPC分类号	A61B5/0015 A61B5/002 A61B5/0022 A61B5/0205 A61B5/02055 A61B5/1118 A61B5/486 A61B5/681 A61B5/6831 A61B5/7275 A61B2560/0214 A61B2560/0219 A61B2562/08 G16H40/67 H02J7/00034 H02J7/025 H02J50/10 H02J50/80 H04L67/12 H04L67/22 H04W4/70 H04M11/002		
优先权	61/772265 2013-03-04 US 61/823502 2013-05-15 US		
其他公开文献	US9149189		
外部链接	<a href="#">Espacenet</a> <a href="#">USPTO</a>		

摘要(译)

提供了一种基于用户习惯信息或用户监控使用遥测数据的方法。监视设备的一个或多个传感器检测或测量从用户的活动，行为和习惯信息以及用户的健康中的至少一个中选择的用户信息。在具有数据库的遥测系统处接收用户信息。遥测系统中的一个或多个分析工具用于分析。生成分析信息，该信息被发送到监视设备。

