



US010098556B2

(12) **United States Patent**
Monif

(10) **Patent No.:** **US 10,098,556 B2**
(45) **Date of Patent:** **Oct. 16, 2018**

(54) **SYSTEMS AND METHODS TO MEASURE FLUID IN A BODY SEGMENT**

(58) **Field of Classification Search**
CPC A61B 5/0537; A61B 5/6833
See application file for complete search history.

(71) Applicant: **King Saud University**, Riyadh (SA)

(56) **References Cited**

(72) Inventor: **Mamdouh Monif Monif**, Riyadh (SA)

U.S. PATENT DOCUMENTS

(73) Assignee: **King Saud University**, Riyadh (SA)

4,008,712 A * 2/1977 Nyboer A61B 5/0537
600/547

(*) Notice: Subject to any disclaimer, the term of this patent is extended or adjusted under 35 U.S.C. 154(b) by 0 days.

6,511,438 B2 1/2003 Bernstein et al.
2008/0275352 A1 11/2008 Shapira et al.
2009/0259132 A1 10/2009 Bernstein

(21) Appl. No.: **15/189,118**

OTHER PUBLICATIONS

(22) Filed: **Jun. 22, 2016**

International Search Report dated Jun. 22, 2012 for International Appl. No. PCT/US2011/062486, 3 pp.

(65) **Prior Publication Data**

US 2016/0302675 A1 Oct. 20, 2016

* cited by examiner

Related U.S. Application Data

Primary Examiner — Michael D Abreu

(74) *Attorney, Agent, or Firm* — Hauptman Ham, LLP

(60) Division of application No. 14/287,974, filed on May 27, 2014, and a continuation of application No. PCT/US2011/062486, filed on Nov. 29, 2011.

(57) **ABSTRACT**

The present disclosure introduces systems and methods to measure fluid in a body segment. In one embodiment, a computer system used to measure fluid in a body segment is described. A current generation module may be used to emit an electrical current through at least one body segment. The electrical current may be used to measure fluid-volume content of the at least one body segment. An electrode module having a plurality of electrodes may be attached to the current generation module. A signal-processing module may be used to measure changes in the electrical current through at least one body segment. Further, an impedance module may be used to calculate fluid-volume change in at least one body segment and determine the flow of fluid through the at least one body segment. Other embodiments also are described.

(51) **Int. Cl.**

A61B 5/00 (2006.01)
A61B 5/0295 (2006.01)
A61B 5/0456 (2006.01)
A61B 5/0205 (2006.01)
A61B 5/0245 (2006.01)
A61B 5/053 (2006.01)

4 Claims, 6 Drawing Sheets

(52) **U.S. Cl.**

CPC **A61B 5/0295** (2013.01); **A61B 5/0205** (2013.01); **A61B 5/0245** (2013.01); **A61B 5/0456** (2013.01); **A61B 5/053** (2013.01); **A61B 5/0535** (2013.01); **A61B 5/6814** (2013.01); **A61B 5/6822** (2013.01); **A61B 5/7278** (2013.01); **A61B 5/742** (2013.01)

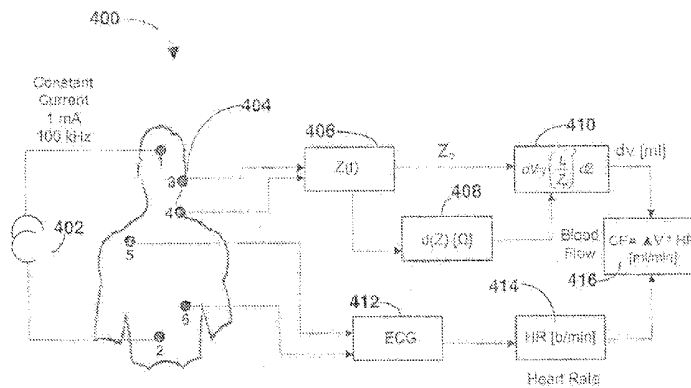

Key:
1 and 2: Current Electrodes
3 and 4: Measurement (voltage) Electrodes
5 and 6: ECG Electrodes

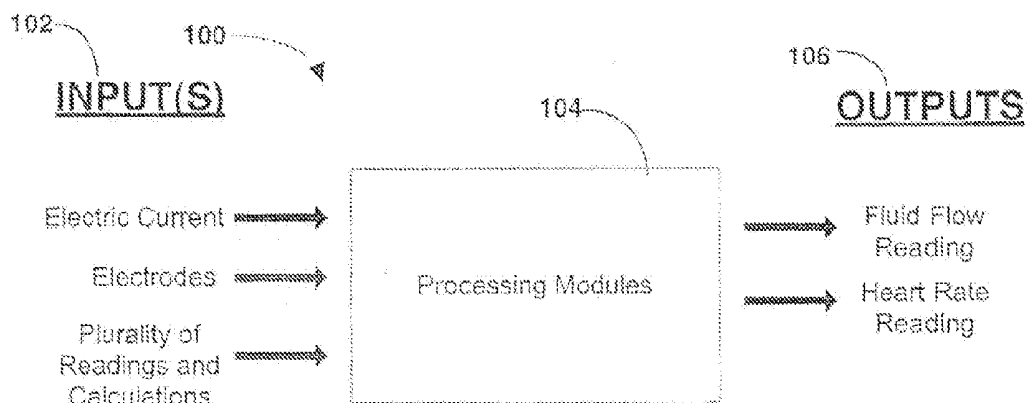

FIG. 1

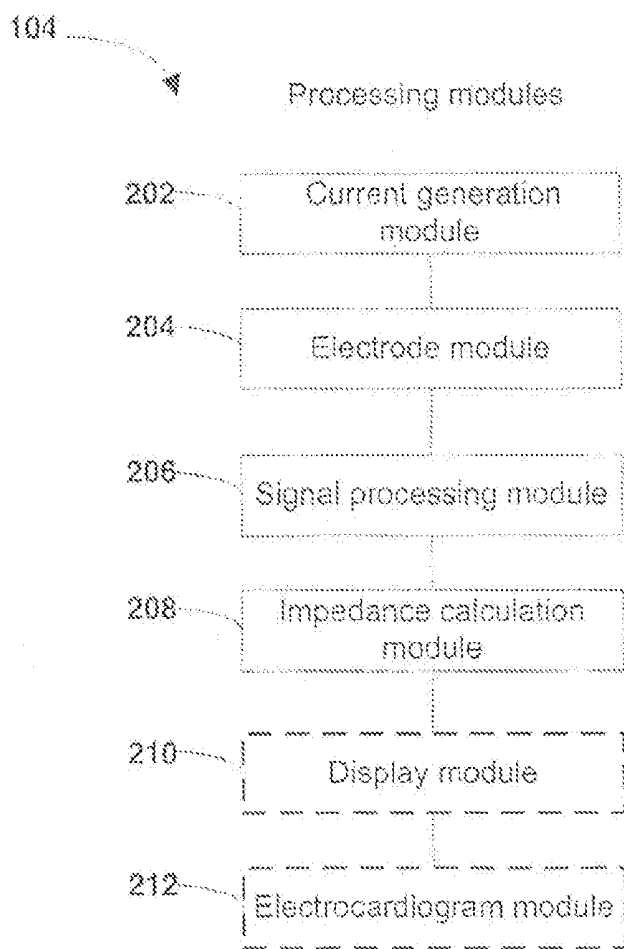

FIG. 2

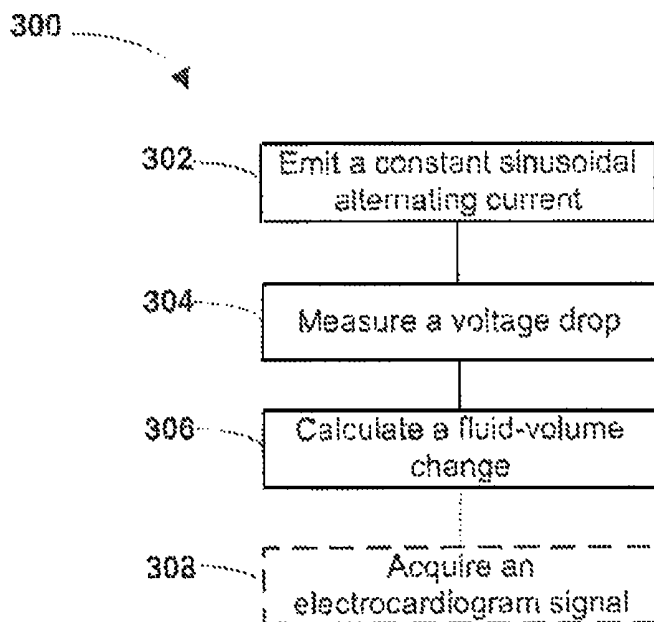
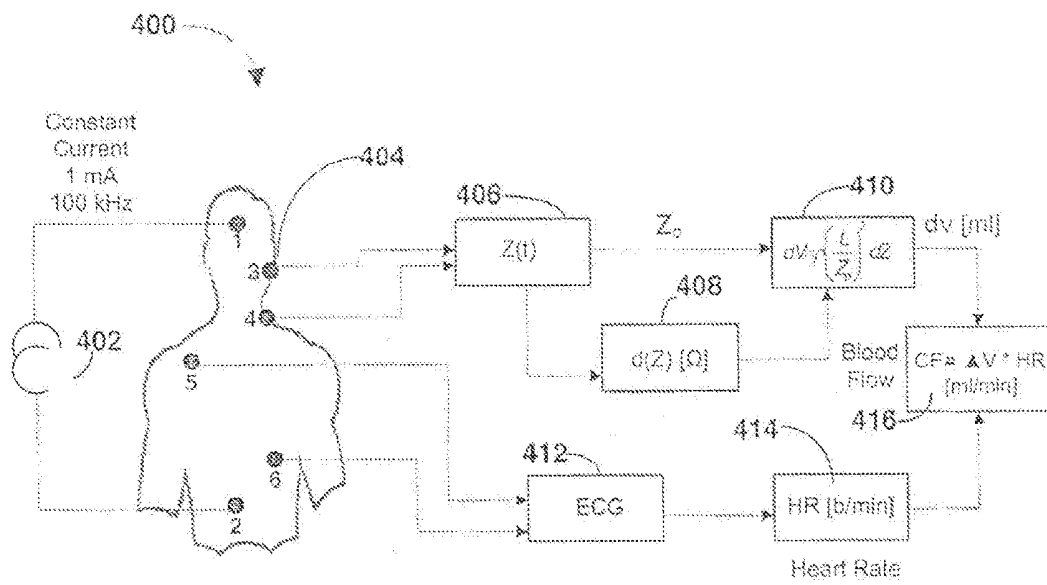
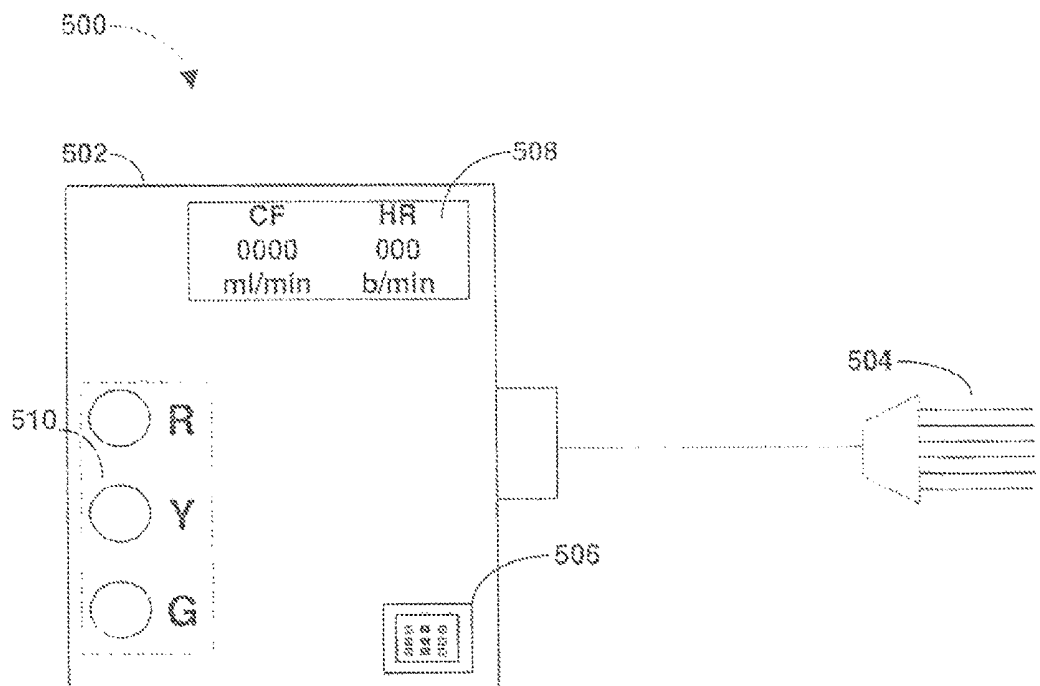

FIG. 3



Key:
 1 and 2: Current Electrodes
 3 and 4: Measurement (voltage) Electrodes
 5 and 6: ECG Electrodes

FIG. 4



Key:
 1 and 2: Current Electrodes
 3 and 4: Measurement (Voltage) Electrodes
 5 and 6: ECG Electrodes
 R: Red LED indicates dangerous case
 Y: Yellow LED indicates the going to dangerous case
 G: Green LED indicates the safe case
 HR: Heart Rate [b/min]
 CF: Blood Flow into brain [ml/min]

FIG. 5

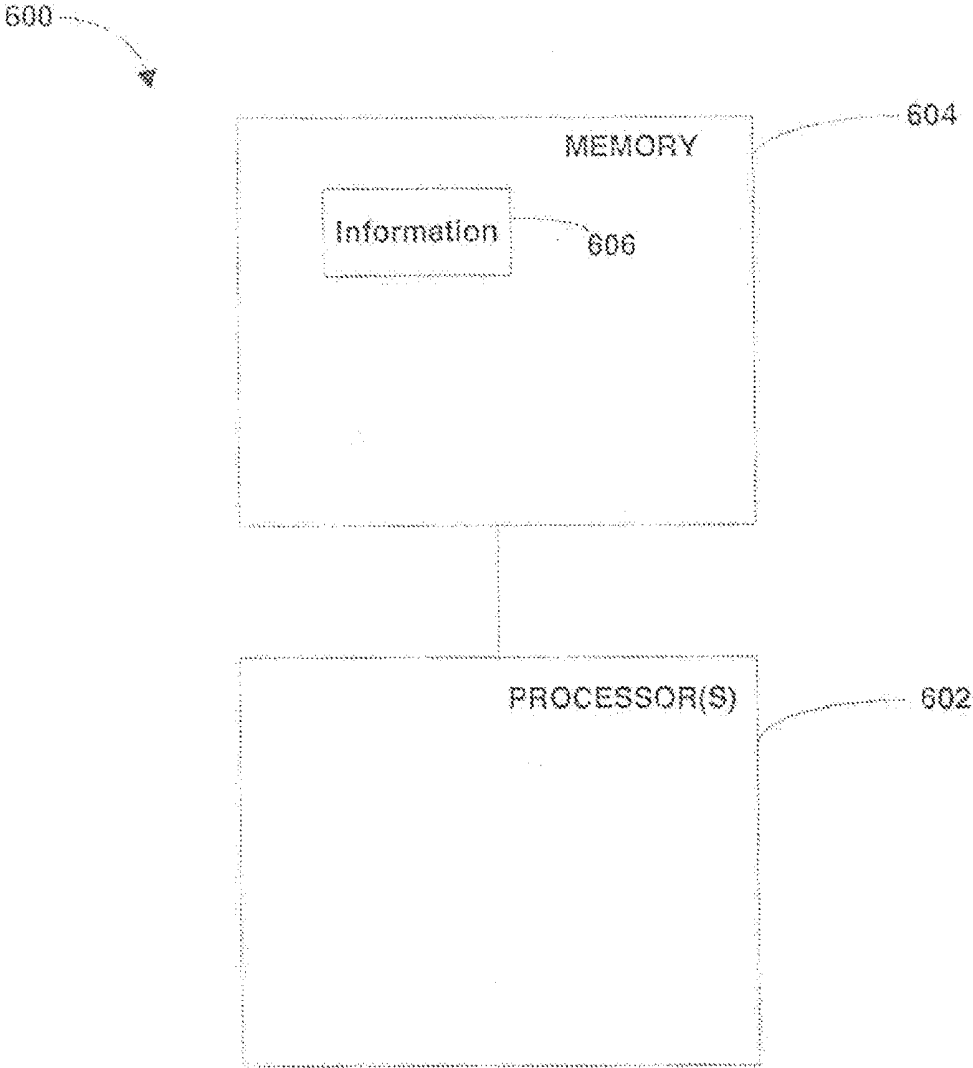

FIG. 6

SYSTEMS AND METHODS TO MEASURE FLUID IN A BODY SEGMENT

CROSS REFERENCE TO RELATED APPLICATIONS

The present application is a Divisional of U.S. patent application Ser. No. 14/287,974, filed May 27, 2014, which is a continuation of PCT/US2011/62486, filed Nov. 29, 2011, the disclosures of which are incorporated herein by reference in their entirety.

BACKGROUND

Impedance plethysmography is a medical test, which measures small changes in electrical resistance throughout body segments. Such measurements can be useful in determining fluid volume changes in a body segment. Measuring fluid flow through a body segment may be useful in helping medical professionals determine the presence of existing or potential health issues in a patient. Importantly, impedance plethysmography accomplishes this task in a manner that is not invasive to a patient.

SUMMARY

The present disclosure introduces systems and methods to measure fluid in a body segment. In one embodiment, a computer system used to measure fluid in a body segment is described. A current generation module may be used to emit an electrical through at least one body segment. The electrical current may be used to measure fluid-volume content of the at least one body segment. An electrode module having a plurality of electrodes may be attached to the current generation module. A signal-processing module may be used to measure changes in the electrical current through at least one body segment. Further, an impedance module may be used to calculate fluid-volume change in at least one body segment and determine the flow of fluid through the at least one body segment. Other embodiments are also described.

This summary is provided to introduce a selection of concepts in a simplified form that are further described below in the detailed description. This summary is not intended to identify key features or essential features of the claimed subject matter, nor is it intended to be used to limit the scope of the claimed subject matter.

BRIEF DESCRIPTION OF THE DRAWINGS

The detailed description is set forth with reference to the accompanying figures, in which the left-most digit of a reference number identifies the figure in which the reference number first appears. The use of the same reference numbers in different figures indicates similar or identical items or features.

FIG. 1 is a block diagram illustrating a general overview of a fluid measurement system, according to an example embodiment.

FIG. 2 is a block diagram illustrating a set of computer program modules to enable fluid measurement of a body segment into a computer system, according to an example embodiment.

FIG. 3 is a block diagram illustrating a method to measure fluid in a body segment, according to one embodiment.

FIG. 4 is a diagram illustrating exemplary measurement principles to measure fluid flow in a body segment, according to an example embodiment.

FIG. 5 is a perspective view of an apparatus to measure blood flow, according to an example embodiment.

FIG. 6 is a block diagram illustrating a fluid measurement system, according to an example embodiment.

DETAILED DESCRIPTION

The following detailed description is divided into several sections. A first section presents a system overview. A next section provides methods of using example embodiments. The following section describes example implementations. The next section describes the hardware and the operating environment in conjunction with which embodiments may be practiced. The final section presents the claims.

System Level Overview

FIG. 1 comprises a block diagram illustrating a general overview of a fluid measurement system according to an example embodiment **100**. Generally, the fluid measurement system **100** may be used to measure the flow of fluid through a body segment. The fluid measurement system **100** is designed to measure blood flow to a body segment in a continuous and non-invasive manner. For example, system **100** can be used to measure the volume of blood in the carotid artery noninvasively using bioimpedance in association with the timing of the heartbeat to calculate the volume of blood that is fed to the brain. In this exemplary implementation, the fluid measurement system **100** comprises inputs **102**, computer program processing modules **104**, and outputs **106**.

In one embodiment, the fluid measurement system **100** may be a computer system such as shown in FIG. 6. Inputs **102** are received by processing modules **104** and processed into outputs **106**. Inputs **102** may include an electric current, a plurality of electrodes, and a plurality of readings and calculations.

A first input **102** is an electric current, which may be generated and applied through at least one body segment of a patient. A patient may be any living being, including humans and animals. The electric current may be produced by an electrical source. An electrical source may be any device or apparatus capable of generating an electric current. One example of an electric source may be a current generator circuit. In order to measure the fluid in a body segment continuously, the electric current should be constant. The electric current may be a constant sinusoidal alternating current.

A second input **102** may be a plurality of electrodes. The electric current may run through a plurality of electrodes connected to a body segment. In one embodiment, some of the plurality of electrodes may also be directly connected to the electrical energy source. In an alternative embodiment, each of the plurality of electrodes may be connected to the electrical source. Electrical impedance of the plurality of electrodes may be measured by applying a constant current through the body segment. Changes in flow of an electrical current through a body segment may occur because of changes in fluid-volume content of the body segment. In an exemplary embodiment, the fluid of a body segment may be blood. Blood is a conductive electrolyte, and the electrical impedance of a given body segment is dependent on the amount of blood within the segment. As blood enters the body segment, during each cardiac cycle or as a result of

fluid redistribution, its impedance decreases. This change in electrical impedance may be measured by the plurality of electrodes.

A third input **102** may be a plurality of readings and calculations. The plurality of readings may be electrical impedance readings including both original impedance readings and changes in fluid-volume content of a body segment. The plurality of calculations may include applying mathematical equations such as a Nyboer formula to the electrical impedance readings to determine patient vital signs. Patient vital signs may be physiological statistics taken to assess basic bodily functions. Some common patient vital signs may include blood flow to a particular body segment and also heart rate. Please refer to the “example implementations” section of this detailed description for additional reference to the Nyboer formula.

Processing modules **104** generally include routines, computer programs, objects, components, data structures, etc., that perform particular functions or implement particular abstract data types. The processing modules **104** receive inputs **102** and apply the inputs **102** to capture and process data producing outputs **106**. The processing modules **104** are described in more detail by reference to FIG. 2.

Outputs **106** are produced by receiving the inputs **102** and applying processing modules **104** to the inputs **102**. The outputs **106** may include a fluid flow reading and a heart rate reading. The fluid flow reading may be determined by using the plurality of calculations to calculate the fluid-volume change occurring in a body segment and multiplying that value by the heart rate reading. A heart rate reading can be determined from the electrical impedance readings. These outputs **106** may provide an indication of a patient’s health status.

FIG. 2 is a block diagram of the processing modules **104** of the system shown in FIG. 1, according to various embodiments. Processing modules **104**, for example, comprise a current generation module **202**, an electrode module **204**, a signal-processing module **206**, and an impedance calculation module **208**. Alternative embodiments are also described below.

The first module, a current generation module **202**, may be used to generate an electric current. The generated electric current may be emitted through at least one body segment. The emitted electric current may be used to measure a fluid-volume content of the at least one body segment over a period of time. In one embodiment, the current generated by the current generation module **202** may be continuous. Providing a continuous and constant current through a body segment may allow accurate capturing of changes in the fluid-volume content of the body segment. The current generation module may be connected to an electrical source to generate an electrical current. In an exemplary embodiment, a current generator circuit may be used to produce a constant sinusoidal alternating current, which can be applied through a body segment.

The second module, an electrode module **204**, may have a plurality of electrodes connected to the current generation module **202** to conduct the electrical current. A plurality of electrodes may be attached to at least one body segment of a patient. In one embodiment, the plurality of electrodes may be attached to multiple body segments of a patient, to measure fluid flow more accurately throughout the body of a patient. Any type of electrode may be used including bare or shielded electrodes comprised of mild steel, high-carbon steel, special alloy steel, cast iron, or nonferrous materials, among others.

The third module, a signal processing module **206**, may be used to measure changes in flow of the electrical current through at least one body segment. Changes in the electrical current may occur as the fluid-volume of a body segment changes. In one embodiment, the signal-processing module **206** may use a four (4)-electrode method to determine impedance changes of the electrical current through a body segment. A constant sinusoidal alternating current may be applied by the circuit generation module **202**, which may pass longitudinally through a first set of electrodes (part of the electrode module **204**). Next, a voltage drop is measured between a second set of electrodes (part of electrode module **204**). The change in voltage of the constant sinusoidal alternating current may be used by the impedance calculation module **208** to calculate a fluid-volume content change in a body segment.

A fourth module, an impedance calculation module **208** may be used to calculate a fluid flow through a body segment. Determining a fluid-volume change in the body segment and applying a Nyboer formula calculation may do this. Changes in the electrical impedance of a body segment may occur as the fluid-volume content changes. Changes in electrical impedance readings may be recorded and as the fluid-volume content changes. In one embodiment, the fluid of a body segment may be blood. As blood enters a body segment, during each cardiac cycle or as a result of fluid redistribution, its impedance decreases. The fluid-volume content change may be determined and used in a calculation to determine fluid flow in a body segment by applying a Nyboer formula. Please refer to the “example implementations” section of this detailed description for a breakdown of the Nyboer formula.

In an alternative embodiment, an additional processing module **104**, namely, a display module **210** may be used to illustrate a representation of the electrical current through the at least one body segment. The display module **210** may be used to represent electrical impedance readings and calculations. The display module **210**, to visually project impedance readings and calculations, may use a monitor or screen display. In one example embodiment, the display module **210** may illustrate numerical values of patient vital signs. In another embodiment, the display module **210** may illustrate more complex graphical and pictorial representations of patient vital signs.

Yet another alternative embodiment, an additional processing module **104**, namely, an electrocardiogram (“ECG”) module **212** may be used to synchronize signal processing and calculation of a heart rate. The ECG module **212** may produce an ECG signal, which can measure the activity of a heart over a period of time. The ECG module **212** may detect the R-wave-to-R-wave interval (“RR interval”), which may be used to measure electric stimulus as it passes through the heart. The RR interval may be used to determine a heart rate reading. A heart rate reading can be used in the calculation to determine flow of fluid through a body segment.

Exemplary Methods

In this section, particular methods to measure fluid in a body segment and example embodiments are described by reference to flow charts. The methods to be performed may constitute computer programs made up of computer-executable instructions.

FIG. 3 is a block diagram illustrating a method to measure fluid in a body segment, according to an example embodiment. The method **300** represents one embodiment of a fluid measurement system such as the fluid measurement system **100** described in FIGS. 1 and 6, respectively. The method

300 may be implemented by emitting a constant sinusoidal alternating current through a first set of electrodes attached to at least one body segment (block **302**), measuring a voltage drop between a second set of electrodes attached to the at least one body segment (block **304**), and calculating a fluid-volume change in the at least one body segment (block **306**).

A constant sinusoidal alternating current is emitted through a first set of electrodes at block **302**. The constant sinusoidal alternating current of block **302** may be a constant current of one (1) milliamperes (“mA”) and one hundred (100) kilohertz (“kHz”). In an exemplary embodiment, the constant sinusoidal alternating current of block **302** may pass longitudinally through the first set of electrodes. The first set of electrodes of block **302** may be attached to at least one body segment. In one embodiment, the first set of electrodes may be attached to multiple body segments. An electrical source may be used to generate the constant sinusoidal alternating current of block **302**. One example of an electric source used to produce an electrical current may be a current generator circuit.

At block **304**, a voltage drop is measured between a second set of electrodes attached to the at least one body segment. Voltage drop between electrodes may be measured using a voltmeter or calculated using Ohms law. Calculating a voltage drop between electrodes may be useful in determining the fluid-volume content change of a body segment.

A fluid volume change in the at least one body segment is calculated at block **306**. The fluid-volume change in the at least one body segment may be calculated by applying a Nyboer formula. Please refer to the “example implementations” section of this detailed description for a breakdown of the Nyboer formula. The fluid volume change may be calculated after the occurrence of a fluid distribution into a body segment. In one embodiment, the occurrence of fluid redistribution may occur during a cardiac cycle. The determination of fluid-volume change in a body segment may be used to measure the fluid flow in a body segment by multiplying the fluid-volume change amount by the heart rate of a patient.

An alternative embodiment to FIG. **3** further comprises acquiring an electrocardiogram (block **308**). The electrocardiogram of block **308** may be used for R-wave detection between RR intervals to synchronize signal processing and calculation of a heart rate. Determining a heart rate may be useful in measuring the fluid flow in a body segment.

Exemplary Implementations

Various examples of computer systems and methods for embodiments of the present disclosure have been described above. Listed and explained below are alternative embodiments, which may be utilized to measure fluid in a body segment. Specifically, an example embodiment of calculating a fluid change volume in at least one body segment is explained in the description of FIG. **4** below.

FIG. **4** is system illustrating exemplary measurement principles to measure fluid flow in a body segment, according to an example embodiment. The system **400** represents one embodiment of a fluid measurement system such as the fluid measurement system **100** described in FIGS. **1** and **6**, respectively. Further, the system **400** of FIG. **4** comprises a constant current **402** running through a body segment, a plurality of electrodes **404** attached to the body segment, and a plurality of calculations **406-414** used to determine patient vital signs. Patient vital signs may be physiological statistics taken to assess basic bodily functions. A patient may be any living being including humans and animals. In an exemplary

embodiment, the fluid in the body segment may be blood. The related patient vital signs measured may include rate of blood flow and heart rate.

A constant current **402** runs through a body segment of a patient. The constant current **402** may be generated by an electrical energy source. An electrical energy source may be any device or apparatus capable of generating an electric current. An example embodiment of an electrical energy source may be a current generator circuit. In one embodiment, the constant current **402** may be a constant sinusoidal alternating current of one (1) mA and one hundred (100) kHz.

The constant current **402** may pass through a plurality of electrodes **404** attached to at least one body segment. In an example embodiment, the constant current **402** may pass longitudinally through the plurality of electrodes **404**. In one embodiment, some of the plurality of electrodes **404** may be directly connected to the electrical energy source. In an alternative embodiment, each of the plurality of electrodes **404** may be connected to the electrical source. The plurality of electrodes **404** may be comprised of multiple sets of electrodes attached to various body segments. In an exemplary embodiment, the plurality of electrodes **404** may have three sets of electrodes. A first set of electrodes may be current electrodes. Current electrodes may be directly connected to the electrical source and used to measure the constant current **402**. A second set of electrodes, voltage electrodes, may be used to measure the voltage drop between the voltage electrodes placed on various body segments. In one embodiment, the voltage electrodes may be placed on the neck and head of a patient to gain electrical impedance readings in the neck and carotid artery of a patient. A third set of electrodes, electrocardiogram (“ECG”) electrodes, may be used to produce an electrocardiographic reading of the patient. The ECG reading may be useful in evaluating cardiovascular activity of the heart over a period of time including determining a heart rate.

A plurality of calculations **406-414** may be used to determine patient vital signs. As previously described, patient vital signs may include evaluating blood flow to a body segment. One exemplary embodiment of a body segment could be a brain. The system **400** may be used to determine blood flow to the brain. The plurality of calculations **406-414** may include applying the Nyboer formula to calculate fluid volume change of a body segment. Assuming that you have two body segments with different cross-sections, the following formula may be applied:

$$dV = \rho \frac{L^2}{Z_0} dZ$$

$$dV = \rho \frac{L^2}{Z_0} dZ$$

where:

dV=volume change of blood [ml]

ρ_b =specific resistance of blood [Ω cm]

L=distance between the measurement electrodes [cm]

Z_0 =basic impedance between the measurement electrodes [Ω]

dZ=impedance change during blood flow through the artery carotid

In measuring blood flow to the brain, the Nyboer formula may be applied to the neck and carotid artery, assuming that the neck and carotid artery form two paraxial cylinders with different cross-sections.

At block **406**, the electrical impedance reading of the voltage electrodes may be determined. At block **408**, the impedance change during blood flow through the carotid artery is calculated. Both the electrical impedance reading of the voltage electrodes and the impedance change during blood flow through the carotid artery may be used in the Nyboer calculation at block **410**. The resulting calculation from block **410** produces the change in fluid volume (in milliliters “mL”) of a body segment. In an exemplary embodiment, this value may be used to calculate the blood flow to a body segment such as the brain.

The ECG electrodes may be read at block **412**. A heart rate may be determined from the ECG reading at block **414**. A blood flow calculation **416** representing blood flow to a body segment can be determined by taking the change in fluid volume of the body segment and multiplying that value by the heart rate of the patient.

Exemplary Hardware and Operating Environment

This section provides an overview of one example of hardware and an operating environment in conjunction with which embodiments of the present disclosure may be implemented. In this exemplary implementation, a software program may be launched from a non-transitory computer-readable medium in a computer-based system to execute functions defined in the software program. Various programming languages may be employed to create software programs designed to implement and perform the methods disclosed herein. The programs may be structured in an object-orientated format using an object-oriented language such as Java or C++. Alternatively, the programs may be structured in a procedure-orientated format using a procedural language, such as assembly or C. The software components may communicate using a number of mechanisms well known to those skilled in the art, such as application program interfaces or inter-process communication techniques, including remote procedure calls. The teachings of various embodiments are not limited to any particular programming language or environment. Thus, other embodiments may be realized, as discussed regarding FIGS. **5** and **6** below.

FIG. **5** is a perspective view of an apparatus to measure blood flow, according to an example embodiment. The apparatus **500** comprises a current generator circuit **502** having a plurality of channels, a plurality of electrodes **504** connected to the current generator circuit **502**, a processor **506** attached to the current generator circuit **502**, and a display unit **508** connected to the processor **506**. The apparatus may be used to measure blood flow to a body segment in a continuous and non-invasive manner.

The current generator circuit **502** may be used to provide a constant and sinusoidal current to the apparatus **500**. In one embodiment, a constant and sinusoidal alternating current of 1 mA and 100 kHz may be passed through the apparatus **500**. Additionally, the current generator circuit **502** may have a plurality of channels. The plurality of channels may communicate with each other to relay information. In an example embodiment, the plurality of channels may include an electrical impedance channel. The electrical impedance channel may allow for a number of electrical impedance readings to be detected and registered by the plurality of electrodes **504** and used in the plurality of calculations performed on the processor **506**. In another example embodiment, the current generator circuit **502** may have an ECG channel. The ECG channel may be used to provide an ECG signal and detect the RR interval, which may be used to calculate heart rate, and also in a calculation to determine blood flow of at least one body segment.

A plurality of electrodes **504** may be connected to the current generator circuit **502**. The plurality of electrodes **504** may also be attached to at least one body segment of a patient. A patient may be any living being for which vital signs may be detected, including humans and animals. The plurality of electrodes **504** may be used to determine a plurality of electrical impedance readings by applying a four-electrode method to the plurality of electrodes. In the example 4-electrode method, a constant sinusoidal alternating current is passed longitudinally through a first set of electrodes (one (1) and two (2)). A voltage drop is measured between a second set of electrodes (three (3) and four (4)). In an exemplary embodiment, the plurality of electrodes **504** may have more than four electrodes connected to body segments of the patient including ECG electrodes to measure an ECG signal used to evaluate a heart rate of a patient.

Electrical impedance measures the opposition to alternating current in a circuit. Measuring electrical impedance may capture relative amplitude, voltages and related phases of the current. Applying a constant current through a body segment may allow the plurality of electrodes **504** to capture the changes in flow of the electrical current as the fluid-volume content changes. The plurality of electrical impedance readings may include a blood flow reading and a heart rate reading. An original electrical impedance reading may be detected by connecting the plurality of electrodes **504** to a body segment. As the fluid-volume content changes in a body segment, derivative impedance may be detected. Both the original electrical impedance reading and the derivative electrical impedance reading may be used in the calculation of blood flow to a body segment.

A processor **506** may be attached to the current generator circuit **502** to compute a plurality of calculations. The plurality of calculations may include applying a Nyboer formula to the plurality of electrical impedance readings to determine blood flow in a body segment. Please refer to the “example implementations” section of the detailed description for a breakdown of the Nyboer formula. Other calculations related to patient vital signs may also be included in the plurality of calculations.

A display unit **508** may be connected to the processor **506**. The display unit **508** may be used to display numeric values of both the plurality of electrical impedance readings and the plurality of calculations. Both of these readings may be used to indicate the patient’s vital signs. Patient vital signs detected may include blood flow and heart rate. In one example embodiment, the display unit **508** may numerically illustrate the patient’s heart rate and also the calculated blood flow to a body segment. In another embodiment, the display unit **508** may illustrate more complex graphical and pictorial representations of the patient’s vital signs. The processor **506** may generate such representations.

An alternative embodiment of the apparatus **500** to measure blood flow may further comprise a plurality of indicators **510** connected to the processor **506**. The plurality of indicators **510** may be used to indicate a health status of a patient. A patient’s health status may be determined from the combination of the results of the plurality of electrical impedance readings and the plurality of calculations. In one example embodiment, the plurality of indicators **510** may be color-coded lights to visibly alert a health professional of the health status of the patient. In one embodiment, the plurality of indicator **510** lights may be light-emitting diodes (“LEDs”). For example, a red LED may be used to indicate that the condition of a patient’s health status is dangerous and attention is needed. A yellow LED may be used to indicate that the patient’s health status is heading towards a

dangerous condition and should be monitored. A green LED light may be used to indicate that the patient's health status is safe. In another embodiment, the plurality of indicators 510 may be auditory.

FIG. 6 is a block diagram illustrating a fluid measurement system, according to an example embodiment. Such embodiments may comprise a computer, a memory system, a magnetic or optical disk, some other storage device, or any type of electronic device or system. The computer system may include one or more processor(s) 602 coupled to a non-transitory machine-accessible, medium such as memory 604 (e.g., a memory including electrical, optical, or electro-magnetic elements). The medium may contain associated information 606 (e.g. computer program instructions, data, or both) which when accessed, results in a machine (e.g. the processor(s) 602) performing the activities previously described herein.

Conclusion

This has been a detailed description of some exemplary embodiments of the present disclosure contained within the disclosed subject matter. The detailed description refers to the accompanying drawings that form a part hereof and which show by way of illustration, but not of limitation, some specific embodiments of the present disclosure, including a preferred embodiment. These embodiments are described in sufficient detail to enable those of ordinary skill in the art to understand and implement the present disclosure. Other embodiments may be utilized and changes may be made without departing from the scope of the present disclosure. Thus, although specific embodiments have been illustrated and described herein, any arrangement calculated to achieve the same purpose may be substituted for the specific embodiments shown. This disclosure is intended to cover any and all adaptations or variations of various embodiments. Combinations of the above embodiments, and other embodiments not specifically described herein, will be apparent to those of skill in the art upon reviewing the above description.

In the foregoing Detailed Description, various features are grouped together in a single embodiment for the purpose of streamlining the disclosure. This method of disclosure is not to be interpreted as reflecting an intention that the claimed embodiments require more features than are expressly recited in each claim. Rather, as the following claims reflect,

the present disclosure lies in less than all features of a single disclosed embodiment. Thus, the following claims are hereby incorporated into the Detailed Description, with each claim standing on its own as a separate preferred embodiment. It will be readily understood to those skilled in the art that various other changes in the details, material, and arrangements of the parts and method stages which have been described and illustrated in order to explain the nature of this disclosure may be made without departing from the principles and scope as expressed in the subjoined claims.

It is emphasized that the Abstract is provided to comply with requirements for an Abstract that will allow the reader to quickly ascertain the nature and gist of the technical disclosure. It is submitted with the understanding that it will not be used to interpret or limit the scope or meaning of the claims.

The invention claimed is:

1. A method to measure fluid in a body segment comprising:

a first set of electrodes emitting a constant sinusoidal alternating current through said first set of electrodes attached to at least one body segment of a patient;

a second set of electrodes attached to the at least one body segment of the patient and measuring a voltage drop between said second set of electrodes;

calculating a fluid volume change in the at least one body segment by applying a Nyboer formula after an occurrence of fluid distribution;

wherein the at least one body segment is the heart of the patient; and

further comprising acquiring an electrocardiogram signal and using the electrocardiogram for R-wave detection to synchronize signal processing and calculation of a heart rate; and

wherein emitting uses a current generator circuit to produce the constant sinusoidal alternating current and wherein a plurality of indicator lights indicate the health status of the patient.

2. The method of claim 1, wherein the constant sinusoidal alternating current passes longitudinally through the first set of electrodes.

3. The method of claim 1, wherein the occurrence of fluid redistribution occurs during a cardiac cycle.

4. The method of claim 1, wherein the constant sinusoidal alternating current is one mA and one hundred kHz.

* * * * *

专利名称(译)	测量身体部分中的流体的系统和方法		
公开(公告)号	US10098556	公开(公告)日	2018-10-16
申请号	US15/189118	申请日	2016-06-22
[标]申请(专利权)人(译)	沙特阿拉伯国王大学		
申请(专利权)人(译)	沙特国王大学		
当前申请(专利权)人(译)	沙特国王大学		
[标]发明人	MONIF MAMDOUH MONIF		
发明人	MONIF, MAMDOUH MONIF		
IPC分类号	A61B5/00 A61B5/0295 A61B5/053 A61B5/0245 A61B5/0205 A61B5/0456		
CPC分类号	A61B5/0295 A61B5/0205 A61B5/0245 A61B5/0456 A61B5/742 A61B5/0535 A61B5/6814 A61B5/6822 A61B5/7278 A61B5/053		
其他公开文献	US20160302675A1		
外部链接	Espacenet		

摘要(译)

本公开介绍了测量身体部分中的流体的系统和方法。在一个实施例中，描述了用于测量身体部分中的流体的计算机系统。电流生成模块可用于通过至少一个主体段发射电。电流可用于测量至少一个主体段的流体体积含量。具有多个电极的电极模块可以附接到电流生成模块。信号处理模块可用于测量通过至少一个主体段的电流的变化。此外，阻抗模块可用于计算至少一个身体部分中的流体体积变化并确定通过至少一个身体部分的流体流量。还描述了其他实施例。

