



(19) **United States**

(12) **Patent Application Publication**
Hoss et al.

(10) **Pub. No.: US 2017/0258377 A1**
(43) **Pub. Date: Sep. 14, 2017**

(54) **ANALYTE SENSORS HAVING
TEMPERATURE INDEPENDENT
MEMBRANES**

(71) Applicant: **Abbott Diabetes Care Inc.**, Alameda,
CA (US)

(72) Inventors: **Udo Hoss**, Castro Valley, CA (US);
Benjamin J. Feldman, Berkeley, CA
(US); **Tianmei Ouyang**, Fremont, CA
(US)

(21) Appl. No.: **15/607,099**

(22) Filed: **May 26, 2017**

Related U.S. Application Data

(63) Continuation of application No. 14/798,047, filed on
Jul. 13, 2015, now Pat. No. 9,662,055, which is a
continuation of application No. 13/192,184, filed on
Jul. 27, 2011, now Pat. No. 9,085,790.

(60) Provisional application No. 61/368,553, filed on Jul.
28, 2010.

Publication Classification

(51) **Int. Cl.**
A61B 5/1468 (2006.01)
C12Q 1/00 (2006.01)
A61B 5/00 (2006.01)
A61B 5/145 (2006.01)
A61B 5/1486 (2006.01)
(52) **U.S. Cl.**
CPC *A61B 5/1468* (2013.01); *A61B 5/14507*
(2013.01); *A61B 5/14532* (2013.01); *A61B*
5/14546 (2013.01); *A61B 5/1486* (2013.01);
A61B 5/14865 (2013.01); *A61B 5/4839*
(2013.01); *C12Q 1/002* (2013.01)

(57) **ABSTRACT**

Embodiments of the present disclosure relate to analyte determining methods and devices (e.g., electrochemical analyte monitoring systems) that have a membrane structure with an analyte permeability that is substantially temperature independent. The devices also include a sensing layer disposed on a working electrode of in vivo analyte sensors, e.g., continuous and/or automatic in vivo monitoring using analyte sensors and/or test strips. Also provided are systems and methods of using the, for example electrochemical, analyte sensors in analyte monitoring.

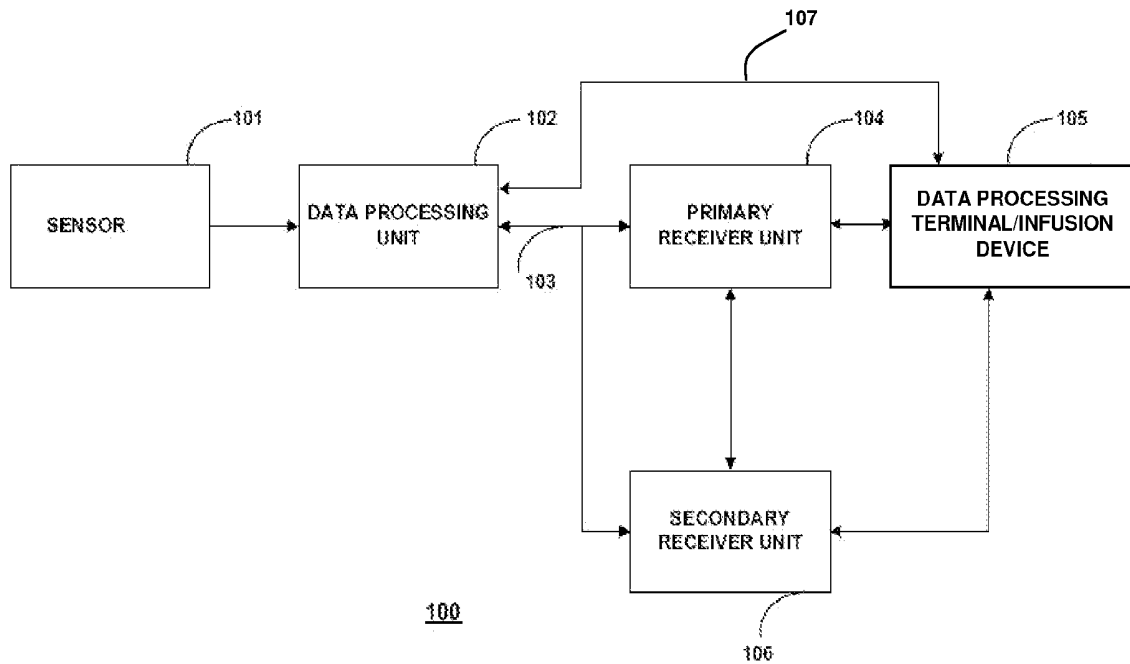

10



FIG. 1

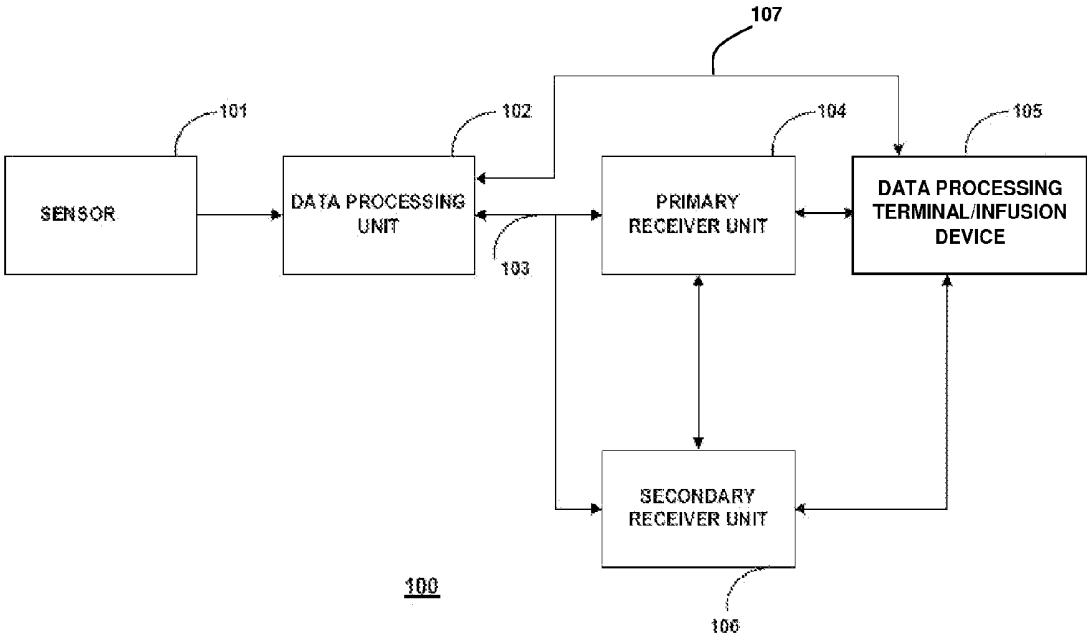

FIG. 2

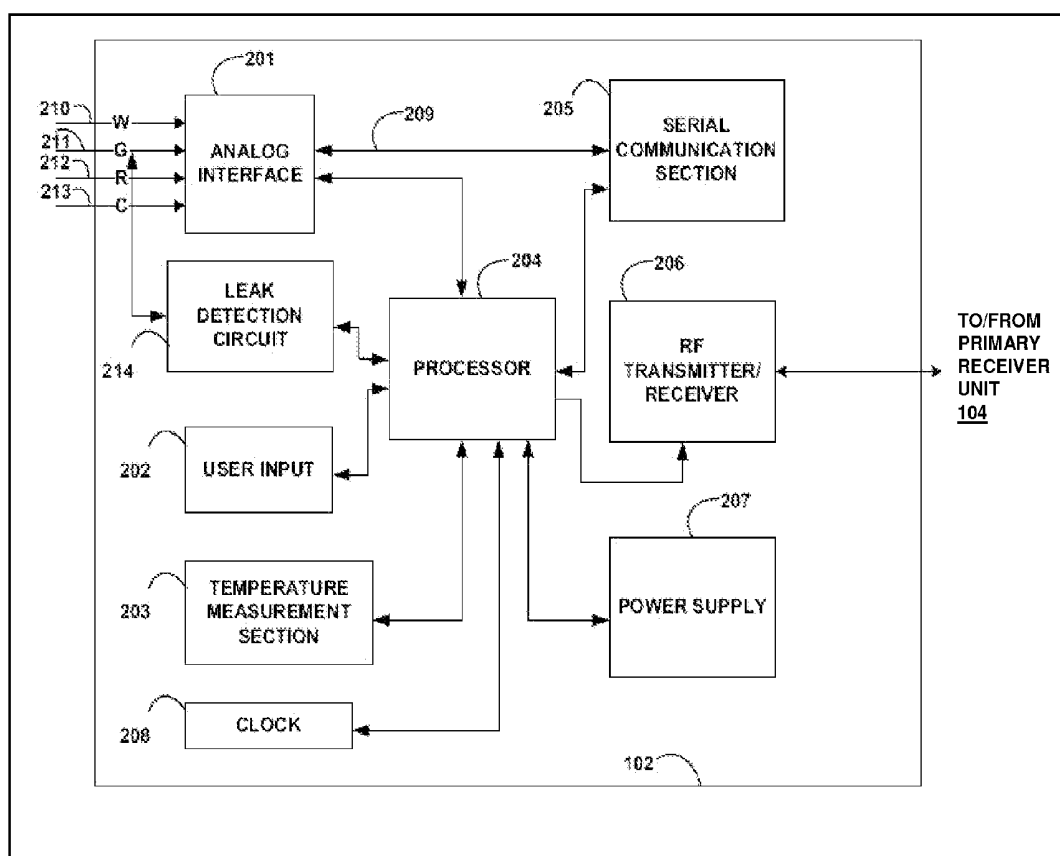

FIG. 3

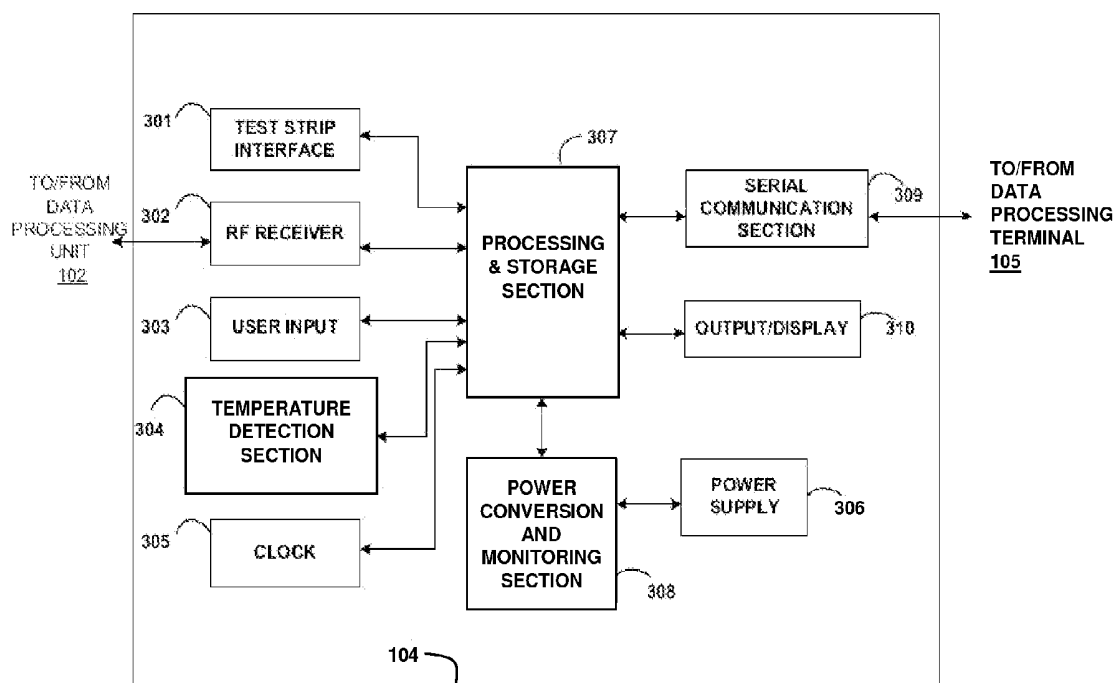

FIG. 4

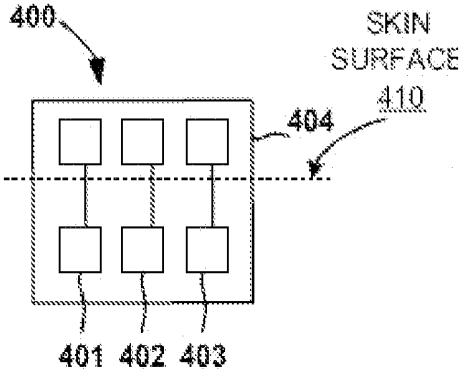

FIG. 5

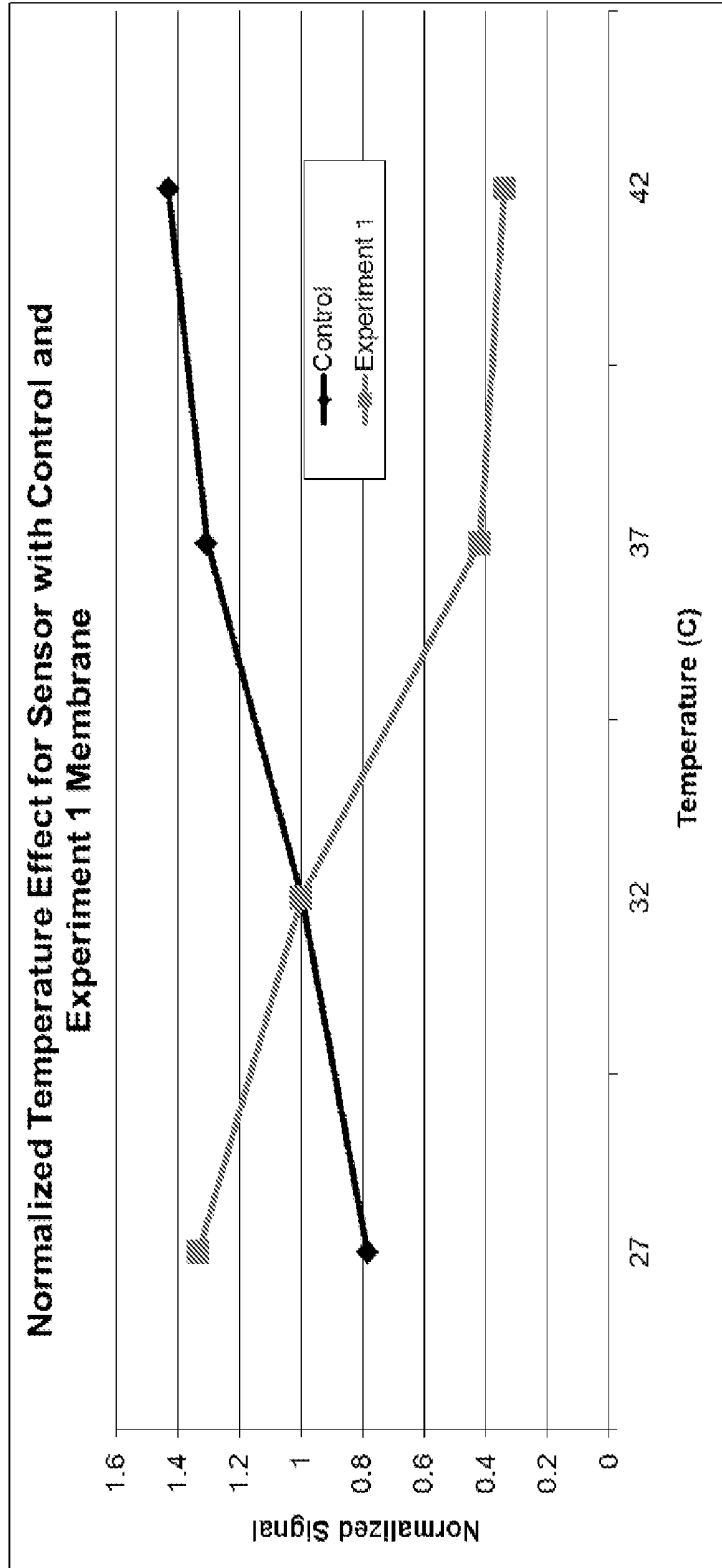

FIG. 6

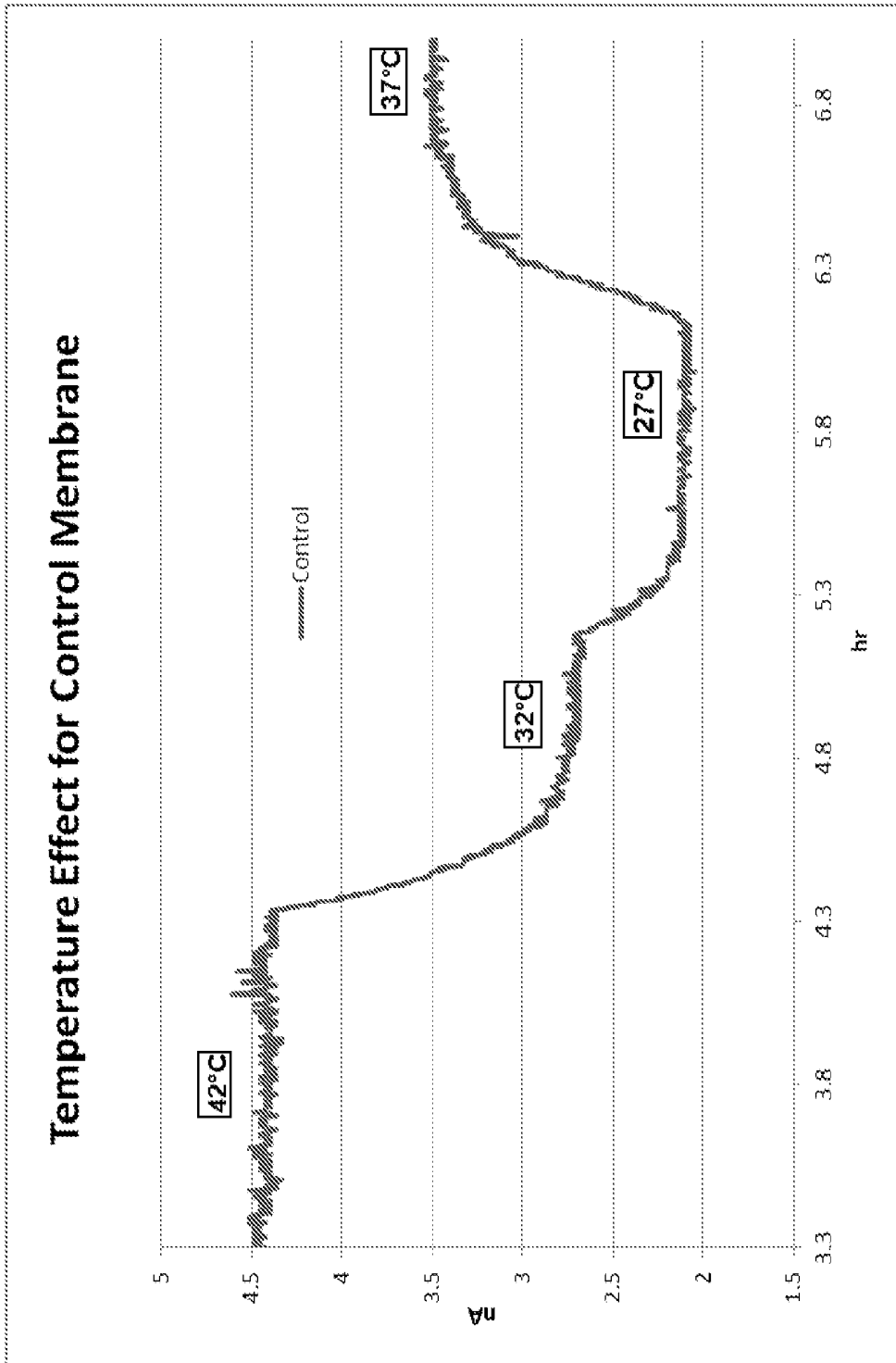

FIG. 7

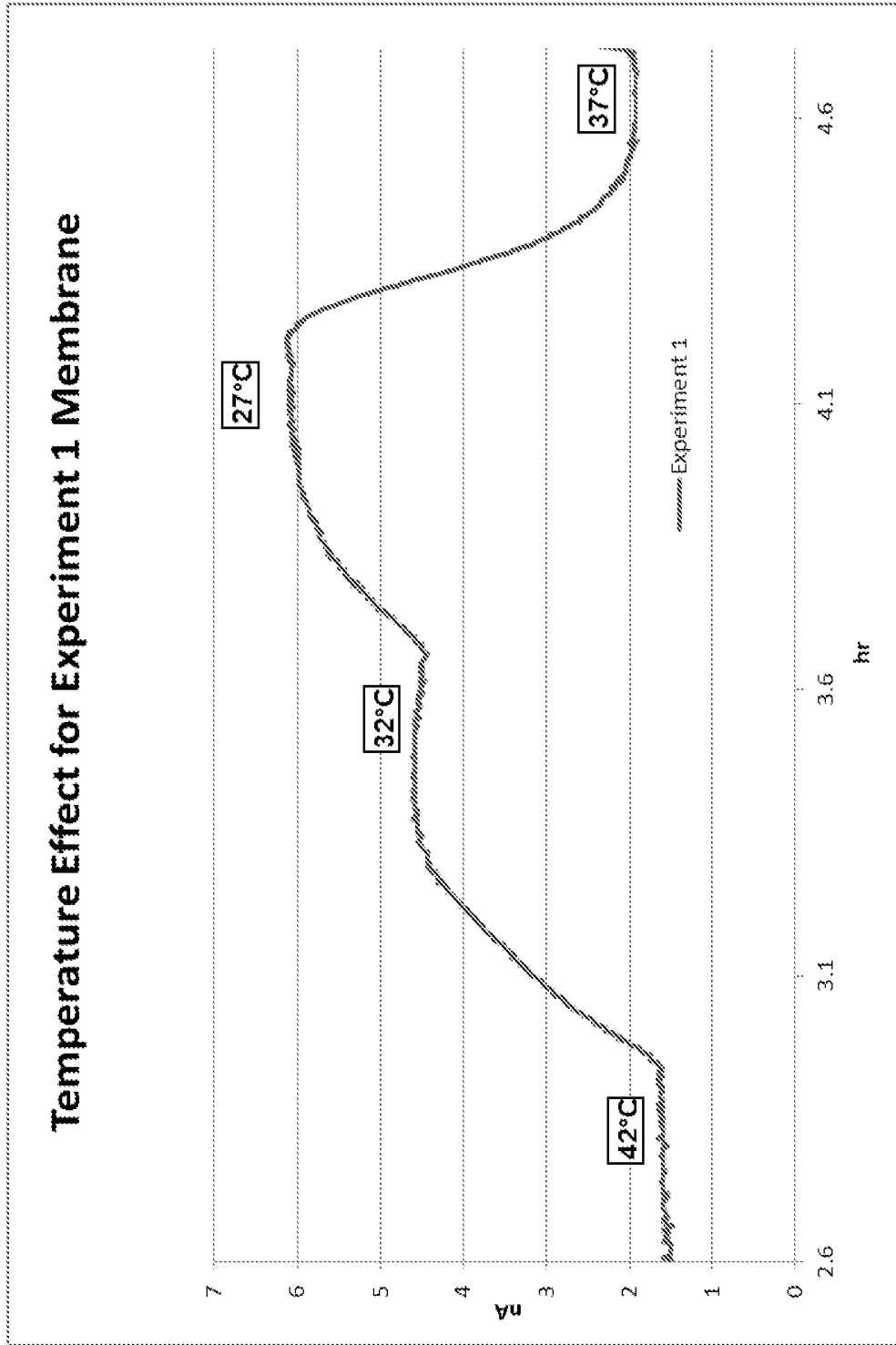

FIG. 8

**ANALYTE SENSORS HAVING
TEMPERATURE INDEPENDENT
MEMBRANES**

CROSS-REFERENCE TO RELATED
APPLICATION

[0001] This patent application claims the benefit of priority under 35 U.S.C. §119(e) to U.S. Provisional Patent Application No. 61/368,553, filed Jul. 28, 2010, the disclosure of which is hereby incorporated by reference in its entirety.

INTRODUCTION

[0002] In many instances it is desirable or necessary to regularly monitor the concentration of particular constituents in a fluid. A number of systems are available that analyze the constituents of bodily fluids such as blood, urine and saliva. Examples of such systems conveniently monitor the level of particular medically significant fluid constituents, such as, for example, cholesterol, ketones, vitamins, proteins, and various metabolites or blood sugars, such as glucose. Diagnosis and management of patients suffering from diabetes mellitus, a disorder of the pancreas where insufficient production of insulin prevents normal regulation of blood sugar levels, requires carefully monitoring of blood glucose levels on a daily basis. A number of systems that allow individuals to easily monitor their blood glucose are currently available. Such systems include electrochemical biosensors, including those that comprise a glucose sensor that is adapted for insertion into a subcutaneous site within the body for the continuous monitoring of glucose levels in bodily fluid of the subcutaneous site (see for example, U.S. Pat. No. 6,175,752 to Say et al).

[0003] In an implantable amperometric biosensor, the working electrode is typically constructed of a sensing layer, which is in direct contact with the conductive material of the electrode, and a diffusion-limiting membrane layer on top of the sensing layer. The membrane is often beneficial or necessary for regulating or limiting the flux of glucose to the sensing layer. By way of explanation, in a glucose sensor without a membrane, the flux of glucose to the sensing layer increases linearly with the concentration of glucose. When all of the glucose arriving at the sensing layer is consumed, the measured output signal is linearly proportional to the flux of glucose and thus to the concentration of glucose. However, when the glucose consumption is limited by the rate of one or more of the chemical or electrochemical reactions in the sensing layer, the measured output signal is no longer controlled by the flux of glucose and is no longer linearly proportional to the flux or concentration of glucose. In this case, only a fraction of the glucose arriving at the sensing layer is contributing to the current. The current no longer increases linearly with the glucose concentration but becomes saturated, meaning that it increases less and less for a given increment of glucose concentration, and eventually stops increasing with the concentration of glucose. In a glucose sensor equipped with a diffusion-limiting membrane, on the other hand, the membrane reduces the flux of glucose to the sensing layer such that the sensor does not become saturated, or becomes saturated only at much higher glucose concentrations and can therefore operate effectively resolve an increase in the concentration of glucose when the glucose concentration is high.

[0004] In addition, the permeability of typical diffusion-limiting membrane layers is usually temperature dependent, such that a change in temperature at the sensor results in a change in the signal generated by the sensor. The change in signal can be compensated for mathematically by measuring the temperature. However, this requires an additional component (e.g., a temperature measurement device, such as a thermistor), and it may be difficult to measure the temperature at the sensor, especially if the sensor is an implantable biosensor.

[0005] While continuous glucose monitoring is desirable, there are several challenges associated with analyte sensors constructed for in vivo use. Accordingly, further development of analyte sensors, including manufacturing techniques and methods, as well as analyte-monitoring devices, systems, or kits employing the same, is desirable.

SUMMARY

[0006] Embodiments of the present disclosure relate to analyte determining methods and devices (e.g., electrochemical analyte monitoring systems) that have a membrane structure with an analyte permeability that is substantially temperature independent. The devices also include a sensing layer disposed on a working electrode of in vivo analyte sensors, e.g., continuous and/or automatic in vivo monitoring using analyte sensors and/or test strips. Also provided are systems and methods of using the, for example electrochemical, analyte sensors in analyte monitoring.

INCORPORATION BY REFERENCE

[0007] The following patents, applications and/or publications are incorporated herein by reference for all purposes: U.S. Pat. No. 7,041,468; U.S. Pat. No. 5,356,786; U.S. Pat. No. 6,175,752; U.S. Pat. No. 6,560,471; U.S. Pat. No. 5,262,035; U.S. Pat. No. 6,881,551; U.S. Pat. No. 6,121,009; U.S. Pat. No. 7,167,818; U.S. Pat. No. 6,270,455; U.S. Pat. No. 6,161,095; U.S. Pat. No. 5,918,603; U.S. Pat. No. 6,144,837; U.S. Pat. No. 5,601,435; U.S. Pat. No. 5,822,715; U.S. Pat. No. 5,899,855; U.S. Pat. No. 6,071,391; U.S. Pat. No. 6,120,676; U.S. Pat. No. 6,143,164; U.S. Pat. No. 6,299,757; U.S. Pat. No. 6,338,790; U.S. Pat. No. 6,377,894; U.S. Pat. No. 6,600,997; U.S. Pat. No. 6,773,671; U.S. Pat. No. 6,514,460; U.S. Pat. No. 6,592,745; U.S. Pat. No. 5,628,890; U.S. Pat. No. 5,820,551; U.S. Pat. No. 6,736,957; U.S. Pat. No. 4,545,382; U.S. Pat. No. 4,711,245; U.S. Pat. No. 5,509,410; U.S. Pat. No. 6,540,891; U.S. Pat. No. 6,730,200; U.S. Pat. No. 6,764,581; U.S. Pat. No. 6,299,757; U.S. Pat. No. 6,461,496; U.S. Pat. No. 6,503,381; U.S. Pat. No. 6,591,125; U.S. Pat. No. 6,616,819; U.S. Pat. No. 6,618,934; U.S. Pat. No. 6,676,816; U.S. Pat. No. 6,749,740; U.S. Pat. No. 6,893,545; U.S. Pat. No. 6,942,518; U.S. Pat. No. 6,514,718; U.S. Pat. No. 5,264,014; U.S. Pat. No. 5,262,305; U.S. Pat. No. 5,320,715; U.S. Pat. No. 5,593,852; U.S. Pat. No. 6,746,582; U.S. Pat. No. 6,284,478; U.S. Pat. No. 7,299,082; U.S. Patent Application No. 61/149,639, entitled "Compact On-Body Physiological Monitoring Device and Methods Thereof", U.S. patent application Ser. No. 11/461,725, filed Aug. 1, 2006, entitled "Analyte Sensors and Methods"; U.S. patent application Ser. No. 12/495,709, filed Jun. 30, 2009, entitled "Extruded Electrode Structures and Methods of Using Same"; U.S. Patent Application Publication No. US2004/0186365; U.S. Patent Application Publication No. 2007/0095661; U.S. Patent Application

Publication No. 2006/0091006; U.S. Patent Application Publication No. 2006/0025662; U.S. Patent Application Publication No. 2008/0267823; U.S. Patent Application Publication No. 2007/0108048; U.S. Patent Application Publication No. 2008/0102441; U.S. Patent Application Publication No. 2008/0066305; U.S. Patent Application Publication No. 2007/0199818; U.S. Patent Application Publication No. 2008/0148873; U.S. Patent Application Publication No. 2007/0068807; US patent Application Publication No. 2010/0198034; and U.S. provisional application No. 61/149,639 titled "Compact On-Body Physiological Monitoring Device and Methods Thereof", the disclosures of each of which are incorporated herein by reference in their entirety.

BRIEF DESCRIPTION OF THE FIGURES

[0008] A detailed description of various embodiments of the present disclosure is provided herein with reference to the accompanying drawings, which are briefly described below. The drawings are illustrative and are not necessarily drawn to scale. The drawings illustrate various embodiments of the present disclosure and may illustrate one or more embodiment(s) or example(s) of the present disclosure in whole or in part. A reference numeral, letter, and/or symbol that is used in one drawing to refer to a particular element may be used in another drawing to refer to a like element.

[0009] FIG. 1 shows a cross-sectional schematic drawing of an embodiment of an analyte sensor that includes a membrane structure configured to have an analyte permeability that is substantially temperature independent according to embodiments of the present disclosure.

[0010] FIG. 2 shows a block diagram of an embodiment of an analyte monitoring system according to embodiments of the present disclosure.

[0011] FIG. 3 shows a block diagram of an embodiment of a data processing unit of the analyte monitoring system shown in FIG. 2.

[0012] FIG. 4 shows a block diagram of an embodiment of the primary receiver unit of the analyte monitoring system of FIG. 2.

[0013] FIG. 5 shows a schematic diagram of an embodiment of an analyte sensor according to the embodiments of the present disclosure.

[0014] FIG. 6 shows a graph of normalized sensor signal at different temperatures for a control and a membrane formulation with a negative correlation with temperature, according to embodiments of the present disclosure.

[0015] FIG. 7 shows a graph of the effect of temperature on the current (nA) for a sensor coated with a control membrane.

[0016] FIG. 8 shows a graph of the effect of temperature on the current (nA) for a sensor coated with a membrane formulation with a negative correlation with temperature, according to embodiments of the present disclosure.

DETAILED DESCRIPTION

[0017] Before the embodiments of the present disclosure are described, it is to be understood that this invention is not limited to particular embodiments described, as such may, of course, vary. It is also to be understood that the terminology used herein is for the purpose of describing particular embodiments only, and is not intended to be limiting, since

the scope of the embodiments of the invention will be limited only by the appended claims.

[0018] Where a range of values is provided, it is understood that each intervening value, to the tenth of the unit of the lower limit unless the context clearly dictates otherwise, between the upper and lower limits of that range is also specifically disclosed. Each smaller range between any stated value or intervening value in a stated range and any other stated or intervening value in that stated range is encompassed within the invention. The upper and lower limits of these smaller ranges may independently be included or excluded in the range, and each range where either, neither or both limits are included in the smaller ranges is also encompassed within the invention, subject to any specifically excluded limit in the stated range. Where the stated range includes one or both of the limits, ranges excluding either or both of those included limits are also included in the invention.

[0019] In the description of the invention herein, it will be understood that a word appearing in the singular encompasses its plural counterpart, and a word appearing in the plural encompasses its singular counterpart, unless implicitly or explicitly understood or stated otherwise. Merely by way of example, reference to "an" or "the" "analyte" encompasses a single analyte, as well as a combination and/or mixture of two or more different analytes, reference to "a" or "the" "concentration value" encompasses a single concentration value, as well as two or more concentration values, and the like, unless implicitly or explicitly understood or stated otherwise. Further, it will be understood that for any given component described herein, any of the possible candidates or alternatives listed for that component, may generally be used individually or in combination with one another, unless implicitly or explicitly understood or stated otherwise. Additionally, it will be understood that any list of such candidates or alternatives, is merely illustrative, not limiting, unless implicitly or explicitly understood or stated otherwise.

[0020] Various terms are described below to facilitate an understanding of the invention. It will be understood that a corresponding description of these various terms applies to corresponding linguistic or grammatical variations or forms of these various terms. It will also be understood that the invention is not limited to the terminology used herein, or the descriptions thereof, for the description of particular embodiments. Merely by way of example, the invention is not limited to particular analytes, bodily or tissue fluids, blood or capillary blood, or sensor constructs or usages, unless implicitly or explicitly understood or stated otherwise, as such may vary.

[0021] The publications discussed herein are provided solely for their disclosure prior to the filing date of the application. Nothing herein is to be construed as an admission that the embodiments of the invention are not entitled to antedate such publication by virtue of prior invention. Further, the dates of publication provided may be different from the actual publication dates which may need to be independently confirmed.

Analyte Sensors Having Temperature Independent Membranes

[0022] Embodiments of the present disclosure relate to systems for improving the performance of one or more components of a sensor by inclusion of a membrane struc-

ture configured to have an analyte permeability that is substantially temperature independent, where the components are disposed on a sensing layer of an analyte sensor, such as in vivo analyte sensor, including, for example, continuous and/or automatic in vivo analyte sensors. For instance, embodiments of the present disclosure provide for inclusion of a first membrane and a second membrane, where the first and second membranes together are configured to have an analyte permeability that is substantially temperature independent, resulting in a membrane structure that has a permeability to an analyte (such as glucose) that does not substantially vary with changes in temperature. Also provided are systems and methods of using the analyte sensors in analyte monitoring.

[0023] Permeability refers to a physical property of a substance that is related to the rate of diffusion of a permeate (e.g., a mobile substance) through the substance (e.g., a solid, semi-solid, gel, hydrogel, membrane, and the like). Permeability relates to the grade of transmissibility of the substance, meaning how much of the permeate diffuses through the substance in a specific time. In some instances, the permeability of a substance depends on the type of permeate, the concentration of the permeate, the size of the permeate, the pressure, the temperature, the type of substance, the thickness of the substance, the surface area of the substance, the pore size of the substance, the tortuosity of the substance, the density of the substance, and the like.

[0024] The term “permeability”, as used herein, includes substances that are semi-permeable. Semi-permeability refers to the property of a material to be permeable only for some substances and not for others. For example, a semi-permeable membrane (also termed a selectively-permeable membrane, a partially-permeable membrane or a differentially-permeable membrane) is a membrane that will only allow certain molecules or ions to pass through it by diffusion. The rate of passage may depend on the pressure, concentration, and temperature of the molecules or solutes on either side, as well as the permeability of the membrane to each solute. Depending on the membrane and the solute, permeability may depend on solute size, solubility, other properties as described above, and the like.

[0025] Aspects of the present disclosure include an analyte sensor. In certain embodiments, the analyte sensor includes a working electrode, a counter electrode and a sensing layer disposed on the working electrode. In some cases, the analyte sensor also includes a membrane structure disposed over the sensing layer, where the membrane structure is configured to have an analyte permeability that is substantially temperature independent. In certain instances, the membrane structure includes a plurality of membrane layers disposed over the sensing layer. For example, the membrane structure may include two or more membranes, such as three or more membranes, four or more membranes, five or more membranes, six or more membranes, seven or more membranes, eight or more membranes, nine or more membranes, ten or more membranes, etc., where the membrane structure as a whole has an analyte permeability that is substantially temperature independent.

[0026] By “temperature independent” is meant that a value does not substantially vary with changes in temperature. For example, the value may vary by 20% or less, such as 15% or less, including 10% or less, 5% or less, or 4% or less, or 3% or less, or 2% or less, or 1% or less as the temperature changes. In some instances, analyte sensors that include a

temperature independent membrane structure (e.g., analyte sensors that generate signals that are substantially temperature independent over a range of temperatures) generate signals over a temperature range that are within 80% or more of each other, such as within 85% or more of each other, including within 90% or more of each other, for example within 95% or more of each other, or within 96% or more of each other, or within 97% or more of each other, or within 98% or more of each other, or within 99% or more of each other. In some cases, analyte sensors that include a temperature independent membrane structure generate signals over a temperature range that are within 80% or more of each other over the temperature range at a constant analyte concentration, such as within 85% or more of each other, including within 90% or more of each other, for example within 95% or more of each other, or within 96% or more of each other, or within 97% or more of each other, or within 98% or more of each other, or within 99% or more of each other over the temperature range at a constant analyte concentration. As set forth above, the analyte sensor includes a membrane structure disposed over a sensing layer, where the membrane structure is configured to have an analyte permeability that is substantially temperature independent. The membrane structure as a whole may have an analyte permeability to an analyte (such as glucose) that does not substantially vary with changes in temperature. For instance, the permeability of the membrane structure as a whole to an analyte (such as glucose) may vary by 20% or less, such as 15% or less, including 10% or less, 5% or less, or 2% or less, or 1% or less as the temperature changes over the temperature range.

[0027] In some cases, the membrane structure includes a plurality of membrane layers, where the membrane structure as a whole has an analyte permeability that is substantially temperature independent. Each individual membrane layer in the membrane structure may be the same or different, as desired, such that the membrane structure as a whole has an analyte permeability that is substantially temperature independent. For example, the membrane structure may include a first membrane disposed over the sensing layer and a second membrane disposed over the first membrane. The first membrane may be the same or different from the second membrane.

[0028] In some instances, the first membrane is chemically bound to the sensing layer. By “chemically bound” is meant that two or more compounds are associated with each other in a covalent, ionic, or coordinate bonding interaction. For example, the polymers in the first membrane may be chemically bound to the polymers in the sensing layer. In certain embodiments, the second membrane is chemically bound to the first membrane. Additional membrane layers, if present, may be chemically bound to the second membrane, and each successive membrane layer may be chemically bound to the underlying membrane. In some instances, the first membrane layer is laminated to the sensing layer. In certain cases, the second membrane is laminated to the first membrane. Each successive membrane layer, if present, may be laminated to the underlying membrane. In certain embodiments, the first membrane is crosslinked to the sensing layer. By “crosslink” is meant that one polymer chain is bonded to another polymer chain through covalent, ionic, or coordinate bonds. In some instances, the second membrane is crosslinked to the first membrane. Each successive membrane layer, if present, may be crosslinked to the underlying

membrane. Chemically bonding, laminating and crosslinking may facilitate immobilization of the membrane layers onto the sensor, such that the membrane layers do not substantially delaminate, slough, chip and/or peel off the sensor.

[0029] Embodiments of the membrane structures, as disclosed herein, may have physical properties that vary with temperature. For instance, the membrane structure may have a pore size, tortuosity, density, etc., that changes as the temperature changes. In some cases, the membrane structure is configured to be a diffusion-limiting membrane structure. By “diffusion-limiting” is meant that the membrane structure decreases the rate of diffusion of a substance as the substance traverses the membrane structure, as compared to the rate of diffusion of the substance in the absence of the membrane structure. Diffusion-limiting membranes may be configured to limit the maximum rate of diffusion of the substance through the membrane. In certain instances, diffusion-limiting membranes are configured to limit the rate of diffusion of substances through the membrane while still allowing the substances to eventually traverse the membrane. Diffusion-limiting membranes may have a permeability that is substantially temperature independent, that varies directly with temperature or that varies inversely with temperature, as described below.

[0030] In some cases, the membrane structure is configured to be a size-exclusion membrane structure. By “size-exclusion” is meant that the membrane structure is permeable only for substances that have a size below a certain threshold and is not permeable for other substances that have a size above the threshold. For example, a size-exclusion membrane may be a membrane that will only allow certain sized molecules or ions to pass through it by diffusion. In certain instances, size-exclusion membranes are configured to substantially inhibit the diffusion of large substances through the membrane while still allowing smaller substances to traverse the membrane. Size-exclusion membranes may have a permeability that is substantially temperature independent, that varies directly with temperature or that varies inversely with temperature, as described below.

[0031] In certain embodiments, the first membrane may be configured to have an analyte permeability that varies inversely with temperature, and the second membrane may be configured to have an analyte permeability that varies directly with temperature. By “vary inversely with temperature” is meant that a value decreases as the temperature increases, or the value increases as the temperature decreases. By “vary directly with temperature” is meant that a value increases as temperature increases, or the value decreases as temperature decreases. For example a permeability that varies inversely with temperature means that the permeability decreases as the temperature increases, or the permeability increases as the temperature decreases. A permeability that varies directly with temperature means that the permeability increases as temperature increases, or the permeability decreases as temperature decreases. In other embodiments, the first membrane may be configured to have an analyte permeability that varies directly with temperature, and the second membrane may be configured to have an analyte permeability that varies inversely with temperature. In certain instances, the first and second membranes together have an analyte permeability that is substantially temperature independent. For example, the first and second

membranes together may have a permeability to an analyte (such as glucose) that does not substantially vary with changes in temperature.

[0032] In certain embodiments, the membrane structure is configured to have a temperature coefficient that is substantially zero. The “temperature coefficient” is the relative change of a physical property when the temperature is changed by 1 K. If the temperature coefficient is zero, then the physical property does not change as the temperature changes. For example, in certain embodiments, a membrane is configured to have a temperature coefficient for permeability to an analyte (such as glucose) that is substantially zero. In these cases, the membrane is configured to have an analyte permeability to the analyte that does not substantially vary as the temperature changes. In some cases, a membrane is configured to have a positive temperature coefficient for permeability to an analyte (such as glucose). In these cases, the membrane is configured such that the permeability of the membrane to the analyte increases directly with temperature. For example, a membrane with a positive temperature coefficient for permeability to an analyte indicates that the membrane is configured such that diffusion of the analyte through the membrane increases as temperature increases. In other instances, a membrane is configured to have a negative temperature coefficient for permeability to an analyte (such as glucose). In these cases, the membrane is configured such that the permeability of the membrane to the analyte varies inversely with temperature. For example, a membrane with a negative temperature coefficient for permeability to an analyte indicates that the membrane is configured such that diffusion of the analyte through the membrane decreases as temperature increases.

[0033] In certain embodiments, the current produced by the sensor in response to the presence of an analyte may depend on the temperature coefficient for permeability to the analyte (such as glucose). For example, a membrane may be configured to have a temperature coefficient for permeability to an analyte (such as glucose) that is substantially zero. In these cases, the membrane is configured to have an analyte permeability to the analyte that does not substantially vary as the temperature changes, and thus the sensor is configured to produce a current that does not substantially vary as the temperature changes (assuming a constant concentration of analyte). In some cases, a membrane is configured to have a positive temperature coefficient for permeability to an analyte (such as glucose). In these cases, the membrane is configured such that the permeability of the membrane to the analyte increases directly with temperature, and thus the sensor is configured to produce a current that increases as the temperature increases (assuming a constant concentration of analyte). Similarly, a membrane with a positive temperature coefficient for permeability to an analyte indicates that the sensor is configured to produce a current that decreases as the temperature decreases (assuming a constant concentration of analyte). In other instances, a membrane is configured to have a negative temperature coefficient for permeability to an analyte (such as glucose). In these cases, the membrane is configured such that the permeability of the membrane to the analyte varies inversely with temperature, and thus the sensor is configured to produce a current that decreases as the temperature increases (assuming a constant concentration of analyte). Similarly, a membrane with a negative temperature coefficient for permeability to an analyte indicates that the sensor is configured to produce a

current that increases as the temperature decreases (assuming a constant concentration of analyte).

[0034] In certain embodiments, the membrane structure as a whole is configured to have a total temperature coefficient that is substantially zero. Each individual membrane layer in the membrane structure may have the same or different temperature coefficient, as desired, such that the sum of the temperature coefficients of the membrane layers in the membrane structure is substantially zero. For example, the membrane structure may include a first membrane disposed over the sensing layer and a second membrane disposed over the first membrane. The first membrane may have the same or different temperature coefficient as the second membrane. For instance, the first membrane may be configured to have a negative temperature coefficient, and the second membrane may be configured to have a positive temperature coefficient. In other embodiments, the first membrane may be configured to have a positive temperature coefficient, and the second membrane may be configured to have a negative temperature coefficient. In certain instances, sum of the temperature coefficients of the first and second membranes is substantially zero.

[0035] As described above, in certain embodiments, the analyte sensor includes a membrane structure configured to have an analyte permeability that is substantially temperature independent. As such, in certain embodiments, the analyte sensor is configured to generate signals that are substantially temperature independent over a range of temperatures. Stated another way, in certain instances, the analyte sensor is configured such that the signals generated by the analyte sensor do not depend on the temperature of the analyte sensor. For example, the analyte sensor may generate signals that are substantially temperature independent over a range of temperatures, where the range of temperatures is from 0° C. to 50° C., such as from 15° C. to 45° C., including from 25° C. to 45° C. Because the analyte sensor is configured to generate signals that are substantially temperature independent, in certain embodiments it is not necessary to correct the signals generated by the analyte sensor for changes in temperature. Thus, analyte sensors having a temperature independent membrane structure may be used to determine a level of an analyte over a period of time without correcting for temperature variation at the sensor. For instance, determining the level of the analyte over a period of time may include monitoring the level of the analyte in a subject in the absence of correcting for temperature variation at the sensor. In addition, because the analyte sensor is configured to generate signals that are substantially temperature independent, in some cases embodiments of the analyte sensors do not include a temperature measurement device, such as a thermistor.

[0036] Examples of membranes that have a negative temperature coefficient suitable for use with the subject methods, compositions and kits include, but are not limited to, polymers that have a lower critical solution temperature (LCST) at about body temperature in water. The “lower critical solution temperature” is the critical temperature below which a mixture is miscible in all proportions. Raising the temperature of the mixture above its LCST may result in phase separation. For instance, membranes that have a negative temperature coefficient may include, but are not limited to, polymers, such as: poly(styrene-co-maleic anhydride) (SMA polymer); dodecylamine; poly(propylene glycol)-block-poly(ethylene glycol)-block-poly(propylene glycol)

(2-aminopropyl ether) (Jeffamine M-600); poly(propylene glycol)-block-poly(ethylene glycol)-block-poly(propylene glycol) bis(2-aminopropyl ether) (Jeffamine ED-900); poly(n-isopropyl acrylamide); copolymers of poly(styrene-co-maleic anhydride) (SMA polymer) and poly(propylene glycol)-block-poly(ethylene glycol)-block-poly(propylene glycol) (2-aminopropyl ether) (Jeffamine M-600); copolymers of poly(styrene-co-maleic anhydride) (SMA polymer), poly(propylene glycol)-block-poly(ethylene glycol)-block-poly(propylene glycol) (2-aminopropyl ether) (Jeffamine M-600) and poly(propylene glycol)-block-poly(ethylene glycol)-block-poly(propylene glycol) bis(2-aminopropyl ether) (Jeffamine ED-900); copolymers of poly(ethylene oxide) and poly(propylene oxide); copolymers of poly(n-isopropyl acrylamide) and a hydrophobic polymer; copolymers of poly(ethylene oxide) and a hydrophobic polymer; copolymers of poly(propylene oxide) and a hydrophobic polymer; combinations thereof; and the like. In certain embodiments, a polymer having a negative temperature coefficient includes SMA polymer and Jeffamine M-600. The copolymer of SMA polymer and Jeffamine M-600 may be crosslinked with Jeffamine ED-900. In some cases, a polymer having a negative temperature coefficient includes SMA polymer, dodecylamine and Jeffamine M-600 crosslinked with Jeffamine ED-900.

[0037] The term “polymer” refers to a large molecule (e.g., a macromolecule) that includes repeating structural units (e.g., monomers). These subunits are typically connected by covalent chemical bonds. Polymers may be branched or unbranched. Polymers may be homopolymers, which are polymers formed by polymerization of a single type of monomer. In other embodiments, polymers are heteropolymers (e.g., copolymers) that include two or more different types of monomers. Copolymers can have alternating monomer subunits, or in some cases, may be block copolymers, which include two or more homopolymer subunits linked by covalent bonds. For example, block copolymers with two blocks of two distinct chemical species (e.g., A and B) are called diblock copolymers, and block copolymers with three blocks of two distinct chemical species (e.g., A and B) are called triblock copolymers.

[0038] In certain embodiments, polymers are crosslinked by a crosslinker (e.g., a crosslinking agent). A “crosslinker” is a molecule that contains at least two reactive groups capable of linking at least two molecules (e.g., polymers) together, or linking at least two portions of the same molecule together. Linking of at least two molecules is called intermolecular crosslinking, while linking of at least two portions of the same molecule is called intramolecular crosslinking. A crosslinker having more than two reactive groups may be capable of both intermolecular and intramolecular crosslinkings at the same time.

[0039] Examples of membranes that have a positive temperature coefficient suitable for use with the subject methods, compositions and kits include, polymers, such as, but not limited to, polyvinylpyridine, a derivative of polyvinylpyridine, polyvinylimidazole, a derivative of polyvinylimidazole, combinations thereof, and the like. In certain embodiments, membranes that have a positive temperature coefficient include a mass transport limiting layer, as described in more detail below. A mass transport limiting layer, e.g., an analyte flux modulating layer, may act as a diffusion-limiting barrier to reduce the rate of mass transport

of the analyte, for example, glucose or lactate, into the region around the working electrodes.

[0040] In certain embodiments, the permeability of a membrane depends on the thickness of the membrane. For example, the magnitude of the temperature coefficient of a membrane may increase as the thickness of the membrane increases. In some cases, the magnitude of the temperature coefficient of a membrane decreases as the thickness of the membrane increases. In certain embodiments, the membrane structure includes a plurality of membrane layers, where each membrane layer has the same or different thickness, as desired, such that the membrane structure as a whole is configured to have an analyte permeability that is substantially temperature independent. For instance, the membrane structure may have a first membrane disposed over the sensing layer and a second membrane disposed over the first membrane. In some cases, the first and second membranes have temperature coefficients with opposite signs. For example, the first membrane may have a negative temperature coefficient and the second membrane may have a positive temperature coefficient, or the first membrane may have a positive temperature coefficient and the second membrane may have a negative temperature coefficient. In certain embodiments, the first membrane has a first thickness and the second membrane has a second thickness, such that the magnitude of the temperature coefficient of the first membrane is substantially the same as the magnitude of the temperature coefficient of the second membrane. As such, the sum of the temperature coefficients of the first and second membranes may be substantially zero.

[0041] Additional embodiments of analyte sensors that may be suitably formulated with a membrane structure configured to have an analyte permeability that is substantially temperature independent are described in U.S. Pat. Nos. 5,262,035, 5,262,305, 6,134,461, 6,143,164, 6,175,752, 6,338,790, 6,579,690, 6,654,625, 6,736,957, 6,746,582, 6,932,894, 6,605,200, 6,605,201, 7,090,756, 6,746,582 as well as those described in U.S. patent application Ser. Nos. 11/701,138, 11/948,915, all of which are incorporated herein by reference in their entirety.

[0042] FIG. 1 shows a cross-sectional schematic drawing of an embodiment of an analyte sensor that includes a membrane structure configured to have an analyte permeability that is substantially temperature independent, according to embodiments of the present disclosure. The analyte sensor **10** includes a substrate **11**. Disposed on the substrate **11** is an electrode **12**. The electrode **12** may be a working electrode or a counter electrode. In certain embodiments, the electrode **12** is a working electrode, the analyte sensor **10** includes a sensing layer **13** disposed on the working electrode **12**. The sensing layer **13** may be disposed on at least a portion of the working electrode **12**, such as disposed on at least a portion of the working electrode **12** implanted in skin of a user. The analyte sensor **10** also includes a membrane structure (**14** and **15**) disposed on the sensing layer **13**. The membrane structure may include a plurality of membrane layers, such as, for example a first membrane **14** disposed on the sensing layer **13** and a second membrane **15** disposed on the first membrane **14**. As described above, the membrane structure is configured to have an analyte permeability that is substantially temperature independent. For example, the sum of the temperature coefficients of the membrane layers may be substantially zero. Although the

thickness of each structure in the analyte sensor **10** is shown to have approximately equal thicknesses, the drawings presented here are not necessarily to scale. Thus, in some embodiments, the thickness of each structure in the analyte sensor **10** may be substantially the same, while in other embodiments the thicknesses may be different. Similarly, the width of each structure in the analyte sensor **10** may be substantially the same in some cases, but in other embodiments the widths may be different.

Electrochemical Sensors

[0043] Embodiments of the present disclosure relate to methods and devices for detecting at least one analyte, including glucose, in body fluid. Embodiments relate to the continuous and/or automatic in vivo monitoring of the level of one or more analytes using a continuous analyte monitoring system that includes an analyte sensor at least a portion of which is to be positioned beneath a skin surface of a user for a period of time and/or the discrete monitoring of one or more analytes using an in vitro blood glucose (“BG”) meter and an analyte test strip. Embodiments include combined or combinable devices, systems and methods and/or transferring data between an in vivo continuous system and an in vivo system. In some embodiments, the systems, or at least a portion of the systems, are integrated into a single unit.

[0044] A sensor as described herein may be an in vivo sensor or an in vitro sensor (i.e., a discrete monitoring test strip). Such a sensor can be formed on a substrate, e.g., a substantially planar substrate. In certain embodiments, the sensor is a wire, e.g., a working electrode wire inner portion with one or more other electrodes associated (e.g., on, including wrapped around) therewith. The sensor may also include at least one counter electrode (or counter/reference electrode) and/or at least one reference electrode or at least one reference/counter electrode.

[0045] Accordingly, embodiments include analyte monitoring devices and systems that include an analyte sensor at least a portion of which is positionable beneath the skin surface of the user for the in vivo detection of an analyte, including glucose, lactate, and the like, in a body fluid. Embodiments include wholly implantable analyte sensors and analyte sensors in which only a portion of the sensor is positioned under the skin and a portion of the sensor resides above the skin, e.g., for contact to a sensor control unit (which may include a transmitter), a receiver/display unit, transceiver, processor, etc. The sensor may be, for example, subcutaneously positionable in a user for the continuous or periodic monitoring of a level of an analyte in the user’s interstitial fluid. For the purposes of this description, continuous monitoring and periodic monitoring will be used interchangeably, unless noted otherwise. The sensor response may be correlated and/or converted to analyte levels in blood or other fluids. In certain embodiments, an analyte sensor may be positioned in contact with interstitial fluid to detect the level of glucose, which detected glucose may be used to infer the glucose level in the user’s bloodstream. Analyte sensors may be insertable into a vein, artery, or other portion of the body containing fluid. Embodiments of the analyte sensors may be configured for monitoring the level of the analyte over a time period which may range from seconds, minutes, hours, days, weeks, to months, or longer.

[0046] In certain embodiments, the analyte sensors, such as glucose sensors, are capable of in vivo detection of an

analyte for one hour or more, e.g., a few hours or more, e.g., a few days or more, e.g., three or more days, e.g., five days or more, e.g., seven days or more, e.g., several weeks or more, or one month or more. Future analyte levels may be predicted based on information obtained, e.g., the current analyte level at time t_0 , the rate of change of the analyte, etc. Predictive alarms may notify the user of a predicted analyte levels that may be of concern in advance of the user's analyte level reaching the future predicted analyte level. This provides the user an opportunity to take corrective action.

[0047] In an electrochemical embodiment, the sensor is placed, transcutaneously, for example, into a subcutaneous site such that subcutaneous fluid of the site comes into contact with the sensor. In other in vivo embodiments, placement of at least a portion of the sensor may be in a blood vessel. The sensor operates to electrolyze an analyte of interest in the subcutaneous fluid or blood such that a current is generated between the working electrode and the counter electrode. A value for the current associated with the working electrode is determined. If multiple working electrodes are used, current values from each of the working electrodes may be determined. A microprocessor may be used to collect these periodically determined current values or to further process these values.

[0048] If an analyte concentration is successfully determined, it may be displayed, stored, transmitted, and/or otherwise processed to provide useful information. By way of example, raw signal or analyte concentrations may be used as a basis for determining a rate of change in analyte concentration, which should not change at a rate greater than a predetermined threshold amount. If the rate of change of analyte concentration exceeds the predefined threshold, an indication maybe displayed or otherwise transmitted to indicate this fact. In certain embodiments, an alarm is activated to alert a user if the rate of change of analyte concentration exceeds the predefined threshold.

[0049] As demonstrated herein, the methods of the present disclosure are useful in connection with a device that is used to measure or monitor an analyte (e.g., glucose), such as any such device described herein. These methods may also be used in connection with a device that is used to measure or monitor another analyte (e.g., ketones, ketone bodies, HbA1c, and the like), including oxygen, carbon dioxide, proteins, drugs, or another moiety of interest, for example, or any combination thereof, found in bodily fluid, including subcutaneous fluid, dermal fluid (sweat, tears, and the like), interstitial fluid, or other bodily fluid of interest, for example, or any combination thereof. In general, the device is in good contact, such as thorough and substantially continuous contact, with the bodily fluid.

[0050] According to embodiments of the present disclosure, the measurement sensor is one suited for electrochemical measurement of analyte concentration, for example glucose concentration, in a bodily fluid. In these embodiments, the measurement sensor includes at least a working electrode and a counter electrode. Other embodiments may further include a reference electrode. The working electrode is typically associated with a glucose-responsive enzyme. A mediator may also be included. In certain embodiments, hydrogen peroxide, which may be characterized as a mediator, is produced by a reaction of the sensor and may be used to infer the concentration of glucose. In some embodiments, a mediator is added to the sensor by a manufacturer, i.e., is

included with the sensor prior to use. The redox mediator may be disposed relative to the working electrode and is capable of transferring electrons between a compound and a working electrode, either directly or indirectly. The redox mediator may be, for example, immobilized on the working electrode, e.g., entrapped on a surface or chemically bound to a surface.

[0051] FIG. 2 shows a data monitoring and management system such as, for example, an analyte (e.g., glucose) monitoring system 100 in accordance with certain embodiments. Aspects of the subject disclosure are further described primarily with respect to glucose monitoring devices and systems, and methods of glucose detection, for convenience only and such description is in no way intended to limit the scope of the embodiments. It is to be understood that the analyte monitoring system may be configured to monitor a variety of analytes at the same time or at different times.

[0052] Analytes that may be monitored include, but are not limited to, acetyl choline, amylase, bilirubin, cholesterol, chorionic gonadotropin, glycosylated hemoglobin (HbA1c), creatine kinase (e.g., CK-MB), creatine, creatinine, DNA, fructosamine, glucose, glucose derivatives, glutamine, growth hormones, hormones, ketones, ketone bodies, lactate, peroxide, prostate-specific antigen, prothrombin, RNA, thyroid stimulating hormone, and troponin. The concentration of drugs, such as, for example, antibiotics (e.g., gentamicin, vancomycin, and the like), digitoxin, digoxin, drugs of abuse, theophylline, and warfarin, may also be monitored. In embodiments that monitor more than one analyte, the analytes may be monitored at the same or different times.

[0053] The analyte monitoring system 100 includes an analyte sensor 101, a data processing unit 102 connectable to the sensor 101, and a primary receiver unit 104. In some instances, the primary receiver unit 104 is configured to communicate with the data processing unit 102 via a communication link 103. In certain embodiments, the primary receiver unit 104 may be further configured to transmit data to a data processing terminal 105 to evaluate or otherwise process or format data received by the primary receiver unit 104. The data processing terminal 105 may be configured to receive data directly from the data processing unit 102 via a communication link 107, which may optionally be configured for bi-directional communication. Further, the data processing unit 102 may include a transmitter or a transceiver to transmit and/or receive data to and/or from the primary receiver unit 104 and/or the data processing terminal 105 and/or optionally a secondary receiver unit 106.

[0054] Also shown in FIG. 2 is an optional secondary receiver unit 106 which is operatively coupled to the communication link 103 and configured to receive data transmitted from the data processing unit 102. The secondary receiver unit 106 may be configured to communicate with the primary receiver unit 104, as well as the data processing terminal 105. In certain embodiments, the secondary receiver unit 106 may be configured for bi-directional wireless communication with each of the primary receiver unit 104 and the data processing terminal 105. As discussed in further detail below, in some instances, the secondary receiver unit 106 may be a de-featured receiver as compared to the primary receiver unit 104, for instance, the secondary receiver unit 106 may include a limited or minimal number of functions and features as compared with the primary receiver unit 104. As such, the secondary receiver unit 106

may include a smaller (in one or more, including all, dimensions), compact housing or embodied in a device including a wrist watch, arm band, PDA, mp3 player, cell phone, etc., for example. Alternatively, the secondary receiver unit **106** may be configured with the same or substantially similar functions and features as the primary receiver unit **104**. The secondary receiver unit **106** may include a docking portion configured to mate with a docking cradle unit for placement by, e.g., the bedside for night time monitoring, and/or a bi-directional communication device. A docking cradle may recharge a power supply.

[0055] Only one analyte sensor **101**, data processing unit **102** and data processing terminal **105** are shown in the embodiment of the analyte monitoring system **100** illustrated in FIG. 2. However, it will be appreciated by one of ordinary skill in the art that the analyte monitoring system **100** may include more than one sensor **101** and/or more than one data processing unit **102**, and/or more than one data processing terminal **105**. Multiple sensors may be positioned in a user for analyte monitoring at the same or different times. In certain embodiments, analyte information obtained by a first sensor positioned in a user may be employed as a comparison to analyte information obtained by a second sensor. This may be useful to confirm or validate analyte information obtained from one or both of the sensors. Such redundancy may be useful if analyte information is contemplated in critical therapy-related decisions. In certain embodiments, a first sensor may be used to calibrate a second sensor.

[0056] The analyte monitoring system **100** may be a continuous monitoring system, or semi-continuous, or a discrete monitoring system. In a multi-component environment, each component may be configured to be uniquely identified by one or more of the other components in the system so that communication conflict may be readily resolved between the various components within the analyte monitoring system **100**. For example, unique IDs, communication channels, and the like, may be used.

[0057] In certain embodiments, the sensor **101** is physically positioned in or on the body of a user whose analyte level is being monitored. The sensor **101** may be configured to at least periodically sample the analyte level of the user and convert the sampled analyte level into a corresponding signal for transmission by the data processing unit **102**. The data processing unit **102** is coupleable to the sensor **101** so that both devices are positioned in or on the user's body, with at least a portion of the analyte sensor **101** positioned transcutaneously. The data processing unit may include a fixation element, such as an adhesive or the like, to secure it to the user's body. A mount (not shown) attachable to the user and mateable with the data processing unit **102** may be used. For example, a mount may include an adhesive surface. The data processing unit **102** performs data processing functions, where such functions may include, but are not limited to, filtering and encoding of data signals, each of which corresponds to a sampled analyte level of the user, for transmission to the primary receiver unit **104** via the communication link **103**. In some embodiments, the sensor **101** or the data processing unit **102** or a combined sensor/data processing unit may be wholly implantable under the skin surface of the user.

[0058] In certain embodiments, the primary receiver unit **104** may include an analog interface section including an RF receiver and an antenna that is configured to communicate

with the data processing unit **102** via the communication link **103**, and a data processing section for processing the received data from the data processing unit **102** including data decoding, error detection and correction, data clock generation, data bit recovery, etc., or any combination thereof.

[0059] In operation, the primary receiver unit **104** in certain embodiments is configured to synchronize with the data processing unit **102** to uniquely identify the data processing unit **102**, based on, for example, an identification information of the data processing unit **102**, and thereafter, to periodically receive signals transmitted from the data processing unit **102** associated with the monitored analyte levels detected by the sensor **101**.

[0060] Referring again to FIG. 2, the data processing terminal **105** may include a personal computer, a portable computer including a laptop or a handheld device (e.g., a personal digital assistant (PDA), a telephone including a cellular phone (e.g., a multimedia and Internet-enabled mobile phone including an iPhone™, a Blackberry®, an Android™ phone, or similar phone), an mp3 player (e.g., an iPod™, etc.), a pager, and the like), and/or a drug delivery device (e.g., an infusion device), each of which may be configured for data communication with the receiver via a wired or a wireless connection. Additionally, the data processing terminal **105** may further be connected to a data network (not shown) for storing, retrieving, updating, and/or analyzing data corresponding to the detected analyte level of the user.

[0061] The data processing terminal **105** may include a drug delivery device (e.g., an infusion device) such as an insulin infusion pump or the like, which may be configured to administer a drug (e.g., insulin) to the user, and which may be configured to communicate with the primary receiver unit **104** for receiving, among others, the measured analyte level. Alternatively, the primary receiver unit **104** may be configured to integrate an infusion device therein so that the primary receiver unit **104** is configured to administer an appropriate drug (e.g., insulin) to users, for example, for administering and modifying basal profiles, as well as for determining appropriate boluses for administration based on, among others, the detected analyte levels received from the data processing unit **102**. An infusion device may be an external device or an internal device, such as a device wholly implantable in a user.

[0062] In certain embodiments, the data processing terminal **105**, which may include an infusion device, e.g., an insulin pump, may be configured to receive the analyte signals from the data processing unit **102**, and thus, incorporate the functions of the primary receiver unit **104** including data processing for managing the user's insulin therapy and analyte monitoring. In certain embodiments, the communication link **103**, as well as one or more of the other communication interfaces shown in FIG. 2, may use one or more wireless communication protocols, such as, but not limited to: an RF communication protocol, an infrared communication protocol, a Bluetooth enabled communication protocol, an 802.11x wireless communication protocol, or an equivalent wireless communication protocol which would allow secure, wireless communication of several units (for example, per Health Insurance Portability and Accountability Act (HIPPA) requirements), while avoiding potential data collision and interference.

[0063] FIG. 3 shows a block diagram of an embodiment of a data processing unit **102** of the analyte monitoring system shown in FIG. 2. User input and/or interface components may be included or a data processing unit may be free of user input and/or interface components. In certain embodiments, one or more application-specific integrated circuits (ASIC) may be used to implement one or more functions or routines associated with the operations of the data processing unit (and/or receiver unit) using for example one or more state machines and buffers.

[0064] As can be seen in the embodiment of FIG. 3, the analyte sensor **101** (FIG. 2) includes four contacts, three of which are electrodes: a work electrode (W) **210**, a reference electrode (R) **212**, and a counter electrode (C) **213**, each operatively coupled to the analog interface **201** of the data processing unit **102**. This embodiment also shows an optional guard contact (G) **211**. Fewer or greater electrodes may be employed. For example, the counter and reference electrode functions may be served by a single counter/reference electrode. In some cases, there may be more than one working electrode and/or reference electrode and/or counter electrode, etc.

[0065] FIG. 4 is a block diagram of an embodiment of a receiver/monitor unit such as the primary receiver unit **104** of the analyte monitoring system shown in FIG. 2. The primary receiver unit **104** includes one or more of: a test strip interface **301**, an RF receiver **302**, a user input **303**, an optional temperature detection section **304**, and a clock **305**, each of which is operatively coupled to a processing and storage section **307**. In certain embodiments, as described above, because the sensor includes a membrane structure configured to have an analyte permeability that is substantially temperature independent, the analyte monitoring system does not include a temperature detection section. The primary receiver unit **104** also includes a power supply **306** operatively coupled to a power conversion and monitoring section **308**. Further, the power conversion and monitoring section **308** is also coupled to the processing and storage section **307**. Moreover, also shown are a receiver serial communication section **309**, and an output **310**, each operatively coupled to the processing and storage section **307**. The primary receiver unit **104** may include user input and/or interface components or may be free of user input and/or interface components.

[0066] In certain embodiments, the test strip interface **301** includes an analyte testing portion (e.g., a glucose level testing portion) to receive a blood (or other body fluid sample) analyte test or information related thereto. For example, the test strip interface **301** may include a test strip port to receive a test strip (e.g., a glucose test strip). The device may determine the analyte level of the test strip, and optionally display (or otherwise notice) the analyte level on the output **310** of the primary receiver unit **104**. Any suitable test strip may be employed, e.g., test strips that only require a very small amount (e.g., 3 microliters or less, e.g., 1 microliter or less, e.g., 0.5 microliters or less, e.g., 0.1 microliters or less), of applied sample to the strip in order to obtain accurate glucose information. Embodiments of test strips include, e.g., FreeStyle® blood glucose test strips from Abbott Diabetes Care Inc. (Alameda, Calif.). Glucose information obtained by an in vitro glucose testing device may be used for a variety of purposes, computations, etc. For example, the information may be used to calibrate sensor **101**, confirm results of sensor **101** to increase the confidence

thereof (e.g., in instances in which information obtained by sensor **101** is employed in therapy related decisions), etc.

[0067] In further embodiments, the data processing unit **102** and/or the primary receiver unit **104** and/or the secondary receiver unit **106**, and/or the data processing terminal/infusion device **105** may be configured to receive the analyte value wirelessly over a communication link from, for example, a blood glucose meter. In further embodiments, a user manipulating or using the analyte monitoring system **100** (FIG. 2) may manually input the analyte value using, for example, a user interface (for example, a keyboard, keypad, voice commands, and the like) incorporated in one or more of the data processing unit **102**, the primary receiver unit **104**, secondary receiver unit **106**, or the data processing terminal/infusion device **105**.

[0068] Additional detailed descriptions are provided in U.S. Pat. Nos. 5,262,035; 5,264,104; 5,262,305; 5,320,715; 5,593,852; 6,175,752; 6,650,471; 6,746,582, and 7,811,231, each of which is incorporated herein by reference in their entirety.

[0069] FIG. 5 schematically shows an embodiment of an analyte sensor **400** in accordance with the embodiments of the present disclosure. This sensor embodiment includes electrodes **401**, **402** and **403** on a base **404**. Electrodes (and/or other features) may be applied or otherwise processed using any suitable technology, e.g., chemical vapor deposition (CVD), physical vapor deposition, sputtering, reactive sputtering, printing, coating, ablating (e.g., laser ablation), painting, dip coating, etching, and the like. Materials include, but are not limited to, any one or more of aluminum, carbon (including graphite), cobalt, copper, gallium, gold, indium, iridium, iron, lead, magnesium, mercury (as an amalgam), nickel, niobium, osmium, palladium, platinum, rhenium, rhodium, selenium, silicon (e.g., doped polycrystalline silicon), silver, tantalum, tin, titanium, tungsten, uranium, vanadium, zinc, zirconium, mixtures thereof, and alloys, oxides, or metallic compounds of these elements.

[0070] The analyte sensor **400** may be wholly implantable in a user or may be configured so that only a portion is positioned within (internal) a user and another portion outside (external) a user. For example, the sensor **400** may include a first portion positionable above a surface of the skin **410**, and a second portion positioned below the surface of the skin. In such embodiments, the external portion may include contacts (connected to respective electrodes of the second portion by traces) to connect to another device also external to the user such as a transmitter unit. While the embodiment of FIG. 5 shows three electrodes side-by-side on the same surface of base **404**, other configurations are contemplated, e.g., fewer or greater electrodes, some or all electrodes on different surfaces of the base or present on another base, some or all electrodes stacked together, electrodes of differing materials and dimensions, etc.

[0071] In certain embodiments, the analyte sensor has a first portion positionable above a surface of the skin, and a second portion that includes an insertion tip positionable below the surface of the skin, e.g., penetrating through the skin and into, e.g., the subcutaneous space, in contact with the user's biofluid, such as interstitial fluid. Contact portions of a working electrode, a reference electrode, and a counter electrode may be positioned on the first portion of the sensor situated above the skin surface. A working electrode, a reference electrode, and a counter electrode may be included on the second portion of the sensor, for example at the

insertion tip. Traces may be provided from the electrodes at the tip to the contact. It is to be understood that greater or fewer electrodes may be provided on a sensor. For example, a sensor may include more than one working electrode and/or the counter and reference electrodes may be a single counter/reference electrode, etc.

[0072] The electrodes of the sensor as well as the substrate and the dielectric layers may be provided in a layered configuration or construction. For example, in one embodiment, the sensor (such as the analyte sensor unit **101** of FIG. **2**), includes a substrate layer, and a first conducting layer such as carbon, gold, etc., disposed on at least a portion of the substrate layer, and which may provide the working electrode. In certain embodiments, disposed on at least a portion of the first conducting layer is a sensing layer.

[0073] A first insulation layer, such as a first dielectric layer in certain embodiments, may be disposed or layered on at least a portion of the first conducting layer, and further, a second conducting layer may be disposed or stacked on top of at least a portion of the first insulation layer (or dielectric layer). The second conducting layer may provide the reference electrode, and in one aspect, may include a layer of silver/silver chloride (Ag/AgCl), gold, etc.

[0074] A second insulation layer, such as a second dielectric layer in certain embodiments, may be disposed or layered on at least a portion of the second conducting layer. Further, a third conducting layer may be disposed on at least a portion of the second insulation layer and may provide the counter electrode. Finally, a third insulation layer may be disposed or layered on at least a portion of the third conducting layer. In this manner, the sensor may be layered such that at least a portion of each of the conducting layers is separated by a respective insulation layer (for example, a dielectric layer). In some instances, the layers may have different lengths. In certain instances, some or all of the layers may have the same or different lengths and/or widths.

[0075] In certain embodiments, some or all of the electrodes may be provided on the same side of the substrate in the layered construction as described above, or alternatively, may be provided in a co-planar manner such that two or more electrodes may be positioned on the same plane (e.g., side-by side (e.g., parallel) or angled relative to each other) on the substrate. For example, co-planar electrodes may include a suitable spacing therebetween and/or include a dielectric material or insulation material disposed between the conducting layers/electrodes. Furthermore, in certain embodiments, one or more of the electrodes may be disposed on opposing sides of the substrate. In such embodiments, contact pads may be on the same or different sides of the substrate. For example, an electrode may be on a first side and its respective contact may be on a second side, e.g., a trace connecting the electrode and the contact may traverse through the substrate.

[0076] In certain embodiments, the sensing layer may be described as the active chemical area of the biosensor. The sensing layer formulation, which can include a glucose-transducing agent, may include, for example, among other constituents, a redox mediator, such as, for example, a hydrogen peroxide or a transition metal complex, such as a ruthenium-containing complex or an osmium-containing complex, and an analyte-responsive enzyme, such as, for example, a glucose-responsive enzyme (e.g., glucose oxidase, glucose dehydrogenase, etc.) or lactate-responsive enzyme (e.g., lactate oxidase). In certain embodiments, the

sensing layer includes glucose oxidase. The sensing layer may also include other optional components, such as, for example, a polymer and a bi-functional, short-chain, epoxide cross-linker, such as polyethylene glycol (PEG).

[0077] In certain instances, the analyte-responsive enzyme is distributed throughout the sensing layer. For example, the analyte-responsive enzyme may be distributed uniformly throughout the sensing layer, such that the concentration of the analyte-responsive enzyme is substantially the same throughout the sensing layer. In some cases, the sensing layer may have a homogeneous distribution of the analyte-responsive enzyme. In certain embodiments, the redox mediator is distributed throughout the sensing layer. For example, the redox mediator may be distributed uniformly throughout the sensing layer, such that the concentration of the redox mediator is substantially the same throughout the sensing layer. In some cases, the sensing layer may have a homogeneous distribution of the redox mediator. In certain embodiments, both the analyte-responsive enzyme and the redox mediator are distributed uniformly throughout the sensing layer, as described above.

[0078] As noted above, analyte sensors may include an analyte-responsive enzyme to provide a sensing component or sensing layer. Some analytes, such as oxygen, can be directly electrooxidized or electroreduced on a sensor, and more specifically at least on a working electrode of a sensor. Other analytes, such as glucose and lactate, require the presence of at least one electron transfer agent and/or at least one catalyst to facilitate the electrooxidation or electroreduction of the analyte. Catalysts may also be used for those analytes, such as oxygen, that can be directly electrooxidized or electroreduced on the working electrode. For these analytes, each working electrode includes a sensing layer proximate to or on a surface of a working electrode. In many embodiments, a sensing layer is formed near or on only a small portion of at least a working electrode.

[0079] The sensing layer includes one or more components constructed to facilitate the electrochemical oxidation or reduction of the analyte. The sensing layer may include, for example, a catalyst to catalyze a reaction of the analyte and produce a response at the working electrode, an electron transfer agent to transfer electrons between the analyte and the working electrode (or other component), or both.

[0080] A variety of different sensing layer configurations may be used. In certain embodiments, the sensing layer is deposited on the conductive material of a working electrode. The sensing layer may extend beyond the conductive material of the working electrode. In some cases, the sensing layer may also extend over other electrodes, e.g., over the counter electrode and/or reference electrode (or counter/reference is provided).

[0081] A sensing layer that is in direct contact with the working electrode may contain an electron transfer agent to transfer electrons directly or indirectly between the analyte and the working electrode, and/or a catalyst to facilitate a reaction of the analyte. For example, a glucose, lactate, or oxygen electrode may be formed having a sensing layer which contains a catalyst, including glucose oxidase, glucose dehydrogenase, lactate oxidase, or laccase, respectively, and an electron transfer agent that facilitates the electrooxidation of the glucose, lactate, or oxygen, respectively.

[0082] In other embodiments the sensing layer is not deposited directly on the working electrode. Instead, the

sensing layer may be spaced apart from the working electrode, and separated from the working electrode, e.g., by a separation layer. A separation layer may include one or more membranes or films or a physical distance. In addition to separating the working electrode from the sensing layer, the separation layer may also act as a mass transport limiting layer and/or an interferent eliminating layer and/or a bio-compatible layer.

[0083] In certain embodiments which include more than one working electrode, one or more of the working electrodes may not have a corresponding sensing layer, or may have a sensing layer which does not contain one or more components (e.g., an electron transfer agent and/or catalyst) needed to electrolyze the analyte. Thus, the signal at this working electrode may correspond to background signal which may be removed from the analyte signal obtained from one or more other working electrodes that are associated with fully-functional sensing layers by, for example, subtracting the signal.

[0084] In certain embodiments, the sensing layer includes one or more electron transfer agents. Electron transfer agents that may be employed are electroreducible and electrooxidizable ions or molecules having redox potentials that are a few hundred millivolts above or below the redox potential of the standard calomel electrode (SCE). The electron transfer agent may be organic, organometallic, or inorganic. Examples of organic redox species are quinones and species that in their oxidized state have quinoid structures, such as Nile blue and indophenol. Examples of organometallic redox species are metallocenes including ferrocene. Examples of inorganic redox species are hexacyanoferrate (III), ruthenium hexamine, etc. Additional examples include those described in U.S. Pat. Nos. 6,736,957, 7,501,053 and 7,754,093, the disclosures of each of which are incorporated herein by reference in their entirety.

[0085] In certain embodiments, electron transfer agents have structures or charges which prevent or substantially reduce the diffusional loss of the electron transfer agent during the period of time that the sample is being analyzed. For example, electron transfer agents include but are not limited to a redox species, e.g., bound to a polymer which can in turn be disposed on or near the working electrode. The bond between the redox species and the polymer may be covalent, coordinative, or ionic. Although any organic, organometallic or inorganic redox species may be bound to a polymer and used as an electron transfer agent, in certain embodiments the redox species is a transition metal compound or complex, e.g., osmium, ruthenium, iron, and cobalt compounds or complexes. It will be recognized that many redox species described for use with a polymeric component may also be used, without a polymeric component.

[0086] Embodiments of polymeric electron transfer agents may contain a redox species covalently bound in a polymeric composition. An example of this type of mediator is poly(vinylferrocene). Another type of electron transfer agent contains an ionically-bound redox species. This type of mediator may include a charged polymer coupled to an oppositely charged redox species. Examples of this type of mediator include a negatively charged polymer coupled to a positively charged redox species such as an osmium or ruthenium polypyridyl cation. Another example of an ionically-bound mediator is a positively charged polymer including quaternized poly(4-vinyl pyridine) or poly(l-vinyl imidazole) coupled to a negatively charged redox species

such as ferricyanide or ferrocyanide. In other embodiments, electron transfer agents include a redox species coordinatively bound to a polymer. For example, the mediator may be formed by coordination of an osmium or cobalt 2,2'-bipyridyl complex to poly(l-vinyl imidazole) or poly(4-vinyl pyridine).

[0087] Suitable electron transfer agents are osmium transition metal complexes with one or more ligands, each ligand having a nitrogen-containing heterocycle such as 2,2'-bipyridine, 1,10-phenanthroline, 1-methyl, 2-pyridyl biimidazole, or derivatives thereof. The electron transfer agents may also have one or more ligands covalently bound in a polymer, each ligand having at least one nitrogen-containing heterocycle, such as pyridine, imidazole, or derivatives thereof. One example of an electron transfer agent includes (a) a polymer or copolymer having pyridine or imidazole functional groups and (b) osmium cations complexed with two ligands, each ligand containing 2,2'-bipyridine, 1,10-phenanthroline, or derivatives thereof, the two ligands not necessarily being the same. Some derivatives of 2,2'-bipyridine for complexation with the osmium cation include but are not limited to 4,4'-dimethyl-2,2'-bipyridine and mono-, di-, and polyalkoxy-2,2'-bipyridines, including 4,4'-dimethoxy-2,2'-bipyridine. Derivatives of 1,10-phenanthroline for complexation with the osmium cation include but are not limited to 4,7-dimethyl-1,10-phenanthroline and mono-, di-, and polyalkoxy-1,10-phenanthrolines, such as 4,7-dimethoxy-1,10-phenanthroline. Polymers for complexation with the osmium cation include but are not limited to polymers and copolymers of poly(l-vinyl imidazole) (referred to as "PVI") and poly(4-vinyl pyridine) (referred to as "PVP"). Suitable copolymer substituents of poly(l-vinyl imidazole) include acrylonitrile, acrylamide, and substituted or quaternized N-vinyl imidazole, e.g., electron transfer agents with osmium complexed to a polymer or copolymer of poly(l-vinyl imidazole).

[0088] Embodiments may employ electron transfer agents having a redox potential ranging from about -200 mV to about +200 mV versus the standard calomel electrode (SCE). The sensing layer may also include a catalyst which is capable of catalyzing a reaction of the analyte. The catalyst may also, in some embodiments, act as an electron transfer agent. One example of a suitable catalyst is an enzyme which catalyzes a reaction of the analyte. For example, a catalyst, including a glucose oxidase, glucose dehydrogenase (e.g., pyrroloquinoline quinone (PQQ), dependent glucose dehydrogenase, flavine adenine dinucleotide (FAD) dependent glucose dehydrogenase, or nicotinamide adenine dinucleotide (NAD) dependent glucose dehydrogenase), may be used when the analyte of interest is glucose. A lactate oxidase or lactate dehydrogenase may be used when the analyte of interest is lactate. Laccase may be used when the analyte of interest is oxygen or when oxygen is generated or consumed in response to a reaction of the analyte.

[0089] In certain embodiments, a catalyst may be attached to a polymer, cross linking the catalyst with another electron transfer agent, which, as described above, may be polymeric. A second catalyst may also be used in certain embodiments. This second catalyst may be used to catalyze a reaction of a product compound resulting from the catalyzed reaction of the analyte. The second catalyst may operate with an electron transfer agent to electrolyze the product compound to generate a signal at the working electrode.

Alternatively, a second catalyst may be provided in an interferent-eliminating layer to catalyze reactions that remove interferents.

[0090] In certain embodiments, the sensor operates at a low oxidizing potential, e.g., a potential of about +40 mV vs. Ag/AgCl. This sensing layer uses, for example, an osmium (Os)-based mediator constructed for low potential operation. Accordingly, in certain embodiments the sensing element is a redox active component that includes (1) osmium-based mediator molecules that include (bidentate) ligands, and (2) glucose oxidase enzyme molecules. These two constituents are combined together in the sensing layer of the sensor.

[0091] A mass transport limiting layer (not shown), e.g., an analyte flux modulating layer, may be included with the sensor to act as a diffusion-limiting barrier to reduce the rate of mass transport of the analyte, for example, glucose or lactate, into the region around the working electrodes. The mass transport limiting layers are useful in limiting the flux of an analyte to a working electrode in an electrochemical sensor so that the sensor is linearly responsive over a large range of analyte concentrations and is easily calibrated. Mass transport limiting layers may include polymers and may be biocompatible. A mass transport limiting layer may provide many functions, e.g., biocompatibility and/or interferent-eliminating functions, etc.

[0092] The mass transport limiting layer may be a membrane structure, as described above, configured to have an analyte permeability that is substantially temperature independent. The mass transport limiting layer may include a plurality of membranes, as described above, where the mass transport limiting layer as a whole has an analyte permeability that is substantially temperature independent. As set forth above, each membrane layer in the mass transport limiting layer may have a temperature coefficient, where the sum of the temperature coefficients of the membrane layers is substantially zero.

[0093] In certain embodiments, a mass transport limiting layer is a membrane composed of crosslinked polymers containing heterocyclic nitrogen groups, such as polymers of polyvinylpyridine and polyvinylimidazole. Embodiments also include membranes that are made of a polyurethane, or polyether urethane, or chemically related material, or membranes that are made of silicone, and the like.

[0094] A membrane may be formed by crosslinking in situ a polymer, modified with a zwitterionic moiety, a non-pyridine copolymer component, and optionally another moiety that is either hydrophilic or hydrophobic, and/or has other desirable properties, in an alcohol-buffer solution. The modified polymer may be made from a precursor polymer containing heterocyclic nitrogen groups. For example, a precursor polymer may be polyvinylpyridine or polyvinylimidazole. Optionally, hydrophilic or hydrophobic modifiers may be used to "fine-tune" the permeability of the resulting membrane to an analyte of interest. Optional hydrophilic modifiers, such as poly(ethylene glycol), hydroxyl or polyhydroxyl modifiers, may be used to enhance the biocompatibility of the polymer or the resulting membrane.

[0095] A membrane may be formed in situ by applying an alcohol-buffer solution of a crosslinker and a modified polymer over an enzyme-containing sensing layer and allowing the solution to cure for about one to two days or other appropriate time period. The crosslinker-polymer solution may be applied to the sensing layer by placing a droplet

or droplets of the membrane solution on the sensor, by dipping the sensor into the membrane solution, by spraying the membrane solution on the sensor, and the like. Generally, the thickness of the membrane is controlled by the concentration of the membrane solution, by the number of droplets of the membrane solution applied, by the number of times the sensor is dipped in the membrane solution, by the volume of membrane solution sprayed on the sensor, or by any combination of these factors. A membrane applied in this manner may have any combination of the following functions: (1) mass transport limitation, i.e., reduction of the flux of analyte that can reach the sensing layer, (2) biocompatibility enhancement, or (3) interferent reduction.

[0096] In some instances, the membrane may form one or more bonds with the sensing layer. By bonds is meant any type of an interaction between atoms or molecules that allows chemical compounds to form associations with each other, such as, but not limited to, covalent bonds, ionic bonds, dipole-dipole interactions, hydrogen bonds, London dispersion forces, and the like. For example, in situ polymerization of the membrane can form crosslinks between the polymers of the membrane and the polymers in the sensing layer. In certain embodiments, crosslinking of the membrane to the sensing layer facilitates a reduction in the occurrence of delamination of the membrane from the sensing layer.

[0097] In certain embodiments, the sensing system detects hydrogen peroxide to infer glucose levels. For example, a hydrogen peroxide-detecting sensor may be constructed in which a sensing layer includes enzyme such as glucose oxidase, glucose dehydrogenase, or the like, and is positioned proximate to the working electrode. The sensing layer may be covered by one or more layers, e.g., a membrane that is selectively permeable to glucose. Once the glucose passes through the membrane, it is oxidized by the enzyme and reduced glucose oxidase can then be oxidized by reacting with molecular oxygen to produce hydrogen peroxide.

[0098] Certain embodiments include a hydrogen peroxide-detecting sensor constructed from a sensing layer prepared by combining together, for example: (1) a redox mediator having a transition metal complex including an Os polypyridyl complex with oxidation potentials of about +200 mV vs. SCE, and (2) periodate oxidized horseradish peroxidase (HRP). Such a sensor functions in a reductive mode; the working electrode is controlled at a potential negative to that of the Os complex, resulting in mediated reduction of hydrogen peroxide through the HRP catalyst.

[0099] In another example, a potentiometric sensor can be constructed as follows. A glucose-sensing layer is constructed by combining together (1) a redox mediator having a transition metal complex including Os polypyridyl complexes with oxidation potentials from about -200 mV to +200 mV vs. SCE, and (2) glucose oxidase. This sensor can then be used in a potentiometric mode, by exposing the sensor to a glucose containing solution, under conditions of zero current flow, and allowing the ratio of reduced/oxidized Os to reach an equilibrium value. The reduced/oxidized Os ratio varies in a reproducible way with the glucose concentration, and will cause the electrode's potential to vary in a similar way.

[0100] The substrate may be formed using a variety of non-conducting materials, including, for example, polymeric or plastic materials and ceramic materials. Suitable

materials for a particular sensor may be determined, at least in part, based on the desired use of the sensor and properties of the materials.

[0101] In some embodiments, the substrate is flexible. For example, if the sensor is configured for implantation into a user, then the sensor may be made flexible (although rigid sensors may also be used for implantable sensors) to reduce pain to the user and damage to the tissue caused by the implantation of and/or the wearing of the sensor. A flexible substrate often increases the user's comfort and allows a wider range of activities. Suitable materials for a flexible substrate include, for example, non-conducting plastic or polymeric materials and other non-conducting, flexible, deformable materials. Examples of useful plastic or polymeric materials include thermoplastics such as polycarbonates, polyesters (e.g., Mylar™ and polyethylene terephthalate (PET)), polyvinyl chloride (PVC), polyurethanes, polyethers, polyamides, polyimides, or copolymers of these thermoplastics, such as PETG (glycol-modified polyethylene terephthalate).

[0102] In other embodiments, the sensors are made using a relatively rigid substrate to, for example, provide structural support against bending or breaking. Examples of rigid materials that may be used as the substrate include poorly conducting ceramics, such as aluminum oxide and silicon dioxide. An implantable sensor having a rigid substrate may have a sharp point and/or a sharp edge to aid in implantation of a sensor without an additional insertion device.

[0103] It will be appreciated that for many sensors and sensor applications, both rigid and flexible sensors will operate adequately. The flexibility of the sensor may also be controlled and varied along a continuum by changing, for example, the composition and/or thickness of the substrate.

[0104] In addition to considerations regarding flexibility, it is often desirable that implantable sensors should have a substrate which is physiologically harmless, for example, a substrate approved by a regulatory agency or private institution for in vivo use.

[0105] The sensor may include optional features to facilitate insertion of an implantable sensor. For example, the sensor may be pointed at the tip to ease insertion. In addition, the sensor may include a barb which assists in anchoring the sensor within the tissue of the user during operation of the sensor. However, the barb is typically small enough so that little damage is caused to the subcutaneous tissue when the sensor is removed for replacement.

[0106] An implantable sensor may also, optionally, have an anticlotting agent disposed on a portion of the substrate which is implanted into a user. This anticlotting agent may reduce or eliminate the clotting of blood or other body fluid around the sensor, particularly after insertion of the sensor. Blood clots may foul the sensor or irreducibly reduce the amount of analyte which diffuses into the sensor. Examples of useful anticlotting agents include heparin and tissue plasminogen activator (TPA), as well as other known anti-clotting agents.

[0107] The anticlotting agent may be applied to at least a portion of that part of the sensor that is to be implanted. The anticlotting agent may be applied, for example, by bath, spraying, brushing, or dipping, etc. The anticlotting agent is allowed to dry on the sensor. The anticlotting agent may be immobilized on the surface of the sensor or it may be allowed to diffuse away from the sensor surface. The quantities of anticlotting agent disposed on the sensor may be

below the amounts typically used for treatment of medical conditions involving blood clots and, therefore, have only a limited, localized effect.

Insertion Device

[0108] An insertion device can be used to subcutaneously insert the sensor into the user. The insertion device is typically formed using structurally rigid materials, such as metal or rigid plastic. Materials may include stainless steel and ABS (acrylonitrile-butadiene-styrene) plastic. In some embodiments, the insertion device is pointed and/or sharp at the tip to facilitate penetration of the skin of the user. A sharp, thin insertion device may reduce pain felt by the user upon insertion of the sensor. In other embodiments, the tip of the insertion device has other shapes, including a blunt or flat shape. These embodiments may be useful when the insertion device does not penetrate the skin but rather serves as a structural support for the sensor as the sensor is pushed into the skin.

Sensor Control Unit

[0109] The sensor control unit can be integrated in the sensor, part or all of which is subcutaneously implanted or it can be configured to be placed on the skin of a user. The sensor control unit is optionally formed in a shape that is comfortable to the user and which may permit concealment, for example, under a user's clothing. The thigh, leg, upper arm, shoulder, or abdomen are convenient parts of the user's body for placement of the sensor control unit to maintain concealment. However, the sensor control unit may be positioned on other portions of the user's body. One embodiment of the sensor control unit has a thin, oval shape to enhance concealment. However, other shapes and sizes may be used.

[0110] The particular profile, as well as the height, width, length, weight, and volume of the sensor control unit may vary and depends, at least in part, on the components and associated functions included in the sensor control unit. In general, the sensor control unit includes a housing typically formed as a single integral unit that rests on the skin of the user. The housing typically contains most or all of the electronic components of the sensor control unit.

[0111] The housing of the sensor control unit may be formed using a variety of materials, including, for example, plastic and polymeric materials, such as rigid thermoplastics and engineering thermoplastics. Suitable materials include, for example, polyvinyl chloride, polyethylene, polypropylene, polystyrene, ABS polymers, and copolymers thereof. The housing of the sensor control unit may be formed using a variety of techniques including, for example, injection molding, compression molding, casting, and other molding methods. Hollow or recessed regions may be formed in the housing of the sensor control unit. The electronic components of the sensor control unit and/or other items, including a battery or a speaker for an audible alarm, may be placed in the hollow or recessed areas.

[0112] The sensor control unit is typically attached to the skin of the user, for example, by adhering the sensor control unit directly to the skin of the user with an adhesive provided on at least a portion of the housing of the sensor control unit which contacts the skin or by suturing the sensor control unit to the skin through suture openings in the sensor control unit.

[0113] When positioned on the skin of a user, the sensor and the electronic components within the sensor control unit are coupled via conductive contacts. The one or more working electrodes, counter electrode (or counter/reference electrode), optional reference electrode, and optional temperature probe are attached to individual conductive contacts. For example, the conductive contacts are provided on the interior of the sensor control unit. Other embodiments of the sensor control unit have the conductive contacts disposed on the exterior of the housing. The placement of the conductive contacts is such that they are in contact with the contact pads on the sensor when the sensor is properly positioned within the sensor control unit.

Sensor Control Unit Electronics

[0114] The sensor control unit also typically includes at least a portion of the electronic components that operate the sensor and the analyte monitoring device system. The electronic components of the sensor control unit typically include a power supply for operating the sensor control unit and the sensor, a sensor circuit for obtaining signals from and operating the sensor, a measurement circuit that converts sensor signals to a desired format, and a processing circuit that, at minimum, obtains signals from the sensor circuit and/or measurement circuit and provides the signals to an optional transmitter. In some embodiments, the processing circuit may also partially or completely evaluate the signals from the sensor and convey the resulting data to the optional transmitter and/or activate an optional alarm system if the analyte level exceeds a threshold. The processing circuit often includes digital logic circuitry.

[0115] The sensor control unit may optionally contain a transmitter for transmitting the sensor signals or processed data from the processing circuit to a receiver/display unit; a data storage unit for temporarily or permanently storing data from the processing circuit; a temperature probe circuit for receiving signals from and operating a temperature probe; a reference voltage generator for providing a reference voltage for comparison with sensor-generated signals; and/or a watchdog circuit that monitors the operation of the electronic components in the sensor control unit.

[0116] Moreover, the sensor control unit may also include digital and/or analog components utilizing semiconductor devices, including transistors. To operate these semiconductor devices, the sensor control unit may include other components including, for example, a bias control generator to correctly bias analog and digital semiconductor devices, an oscillator to provide a clock signal, and a digital logic and timing component to provide timing signals and logic operations for the digital components of the circuit.

[0117] As an example of the operation of these components, the sensor circuit and the optional temperature probe circuit provide raw signals from the sensor to the measurement circuit. The measurement circuit converts the raw signals to a desired format, using for example, a current-to-voltage converter, current-to-frequency converter, and/or a binary counter or other indicator that produces a signal proportional to the absolute value of the raw signal. This may be used, for example, to convert the raw signal to a format that can be used by digital logic circuits. The processing circuit may then, optionally, evaluate the data and provide commands to operate the electronics.

Calibration

[0118] Sensors may be configured to require no system calibration or no user calibration. For example, a sensor may be factory calibrated and need not require further calibrating. In certain embodiments, calibration may be required, but may be done without user intervention, i.e., may be automatic. In those embodiments in which calibration by the user is required, the calibration may be according to a predetermined schedule or may be dynamic, i.e., the time for which may be determined by the system on a real-time basis according to various factors, including, but not limited to, glucose concentration and/or temperature and/or rate of change of glucose, etc.

[0119] In addition to a transmitter, an optional receiver may be included in the sensor control unit. In some cases, the transmitter is a transceiver, operating as both a transmitter and a receiver. The receiver may be used to receive calibration data for the sensor. The calibration data may be used by the processing circuit to correct signals from the sensor. This calibration data may be transmitted by the receiver/display unit or from some other source such as a control unit in a doctor's office. In addition, the optional receiver may be used to receive a signal from the receiver/display units to direct the transmitter, for example, to change frequencies or frequency bands, to activate or deactivate the optional alarm system and/or to direct the transmitter to transmit at a higher rate.

[0120] Calibration data may be obtained in a variety of ways. For instance, the calibration data may be factory-determined calibration measurements which can be input into the sensor control unit using the receiver or may alternatively be stored in a calibration data storage unit within the sensor control unit itself (in which case a receiver may not be needed). The calibration data storage unit may be, for example, a readable or readable/writable memory circuit.

[0121] Calibration may be accomplished using an *in vitro* test strip (or other reference), e.g., a small sample test strip such as a test strip that requires less than about 1 microliter of sample (for example FreeStyle® blood glucose monitoring test strips from Abbott Diabetes Care Inc., Alameda, Calif.). For example, test strips that require less than about 1 nanoliter of sample may be used. In certain embodiments, a sensor may be calibrated using only one sample of body fluid per calibration event. For example, a user need only lance a body part one time to obtain a sample for a calibration event (e.g., for a test strip), or may lance more than one time within a short period of time if an insufficient volume of sample is firstly obtained. Embodiments include obtaining and using multiple samples of body fluid for a given calibration event, where glucose values of each sample are substantially similar. Data obtained from a given calibration event may be used independently to calibrate or combined with data obtained from previous calibration events, e.g., averaged including weighted averaged, etc., to calibrate. In certain embodiments, a system need only be calibrated once by a user, where recalibration of the system is not required.

[0122] Alternative or additional calibration data may be provided based on tests performed by a health care professional or by the user. For example, it is common for diabetic individuals to determine their own blood glucose concentration using commercially available testing kits. The results of this test is input into the sensor control unit either directly,

if an appropriate input device (e.g., a keypad, an optical signal receiver, or a port for connection to a keypad or computer) is incorporated in the sensor control unit, or indirectly by inputting the calibration data into the receiver/display unit and transmitting the calibration data to the sensor control unit.

[0123] Other methods of independently determining analyte levels may also be used to obtain calibration data. This type of calibration data may supplant or supplement factory-determined calibration values.

[0124] In some embodiments of the invention, calibration data may be required at periodic intervals, for example, every eight hours, once a day, or once a week, to confirm that accurate analyte levels are being reported. Calibration may also be required each time a new sensor is implanted or if the sensor exceeds a threshold minimum or maximum value or if the rate of change in the sensor signal exceeds a threshold value. In some cases, it may be necessary to wait a period of time after the implantation of the sensor before calibrating to allow the sensor to achieve equilibrium. In some embodiments, the sensor is calibrated only after it has been inserted. In other embodiments, no calibration of the sensor is needed.

Analyte Monitoring Device

[0125] In some embodiments of the invention, the analyte monitoring device includes a sensor control unit and a sensor. In these embodiments, the processing circuit of the sensor control unit is able to determine a level of the analyte and activate an alarm system if the analyte level exceeds a threshold value. The sensor control unit, in these embodiments, has an alarm system and may also include a display, such as an LCD or LED display.

[0126] A threshold value is exceeded if the datapoint has a value that is beyond the threshold value in a direction indicating a particular condition. For example, a datapoint which correlates to a glucose level of 200 mg/dL exceeds a threshold value for hyperglycemia of 180 mg/dL, because the datapoint indicates that the user has entered a hyperglycemic state. As another example, a datapoint which correlates to a glucose level of 65 mg/dL exceeds a threshold value for hypoglycemia of 70 mg/dL because the datapoint indicates that the user is hypoglycemic as defined by the threshold value. However, a datapoint which correlates to a glucose level of 75 mg/dL would not exceed the same threshold value for hypoglycemia because the datapoint does not indicate that particular condition as defined by the chosen threshold value.

[0127] An alarm may also be activated if the sensor readings indicate a value that is outside of (e.g., above or below) a measurement range of the sensor. For glucose, the physiologically relevant measurement range is typically 30-400 mg/dL, including 40-300 mg/dL and 50-250 mg/dL, of glucose in the interstitial fluid.

[0128] The alarm system may also, or alternatively, be activated when the rate of change or acceleration of the rate of change in analyte level increase or decrease reaches or exceeds a threshold rate or acceleration. For example, in the case of a subcutaneous glucose monitor, the alarm system may be activated if the rate of change in glucose concentration exceeds a threshold value which may indicate that a hyperglycemic or hypoglycemic condition is likely to occur. In some cases, the alarm system is activated if the acceleration of the rate of change in glucose concentration

exceeds a threshold value which may indicate that a hyperglycemic or hypoglycemic condition is likely to occur.

[0129] A system may also include system alarms that notify a user of system information such as battery condition, calibration, sensor dislodgment, sensor malfunction, etc. Alarms may be, for example, auditory and/or visual. Other sensory-stimulating alarm systems may be used including alarm systems which heat, cool, vibrate, or produce a mild electrical shock when activated.

Drug Delivery System

[0130] The subject invention also includes sensors used in sensor-based drug delivery systems. The system may provide a drug to counteract the high or low level of the analyte in response to the signals from one or more sensors. Alternatively, the system may monitor the drug concentration to ensure that the drug remains within a desired therapeutic range. The drug delivery system may include one or more (e.g., two or more) sensors, a processing unit such as a transmitter, a receiver/display unit, and a drug administration system. In some cases, some or all components may be integrated in a single unit. A sensor-based drug delivery system may use data from the one or more sensors to provide necessary input for a control algorithm/mechanism to adjust the administration of drugs, e.g., automatically or semi-automatically. As an example, a glucose sensor may be used to control and adjust the administration of insulin from an external or implanted insulin pump.

[0131] Each of the various references, presentations, publications, provisional and/or non-provisional U.S. patent applications, U.S. patents, non-U.S. patent applications, and/or non-U.S. patents that have been identified herein, is incorporated herein by reference in its entirety.

[0132] Other embodiments and modifications within the scope of the present disclosure will be apparent to those skilled in the relevant art. Various modifications, processes, as well as numerous structures to which the embodiments of the invention may be applicable will be readily apparent to those of skill in the art to which the invention is directed upon review of the specification. Various aspects and features of the invention may have been explained or described in relation to understandings, beliefs, theories, underlying assumptions, and/or working or prophetic examples, although it will be understood that the invention is not bound to any particular understanding, belief, theory, underlying assumption, and/or working or prophetic example. Although various aspects and features of the invention may have been described largely with respect to applications, or more specifically, medical applications, involving diabetic humans, it will be understood that such aspects and features also relate to any of a variety of applications involving non-diabetic humans and any and all other animals. Further, although various aspects and features of the invention may have been described largely with respect to applications involving partially implanted sensors, such as transcutaneous or subcutaneous sensors, it will be understood that such aspects and features also relate to any of a variety of sensors that are suitable for use in connection with the body of an animal or a human, such as those suitable for use as fully implanted in the body of an animal or a human. Finally, although the various aspects and features of the invention have been described with respect to various embodiments and specific examples herein, all of which may be made or

carried out conventionally, it will be understood that the invention is entitled to protection within the full scope of the appended claims.

[0133] The following examples are put forth so as to provide those of ordinary skill in the art with a complete disclosure and description of how to make and use the embodiments of the invention, and are not intended to limit the scope of what the inventors regard as their invention nor are they intended to represent that the experiments below are all or the only experiments performed. Efforts have been made to ensure accuracy with respect to numbers used (e.g., amounts, temperature, etc.) but some experimental errors and deviations should be accounted for. Unless indicated otherwise, parts are parts by weight, molecular weight is weight average molecular weight, temperature is in degrees Centigrade, and pressure is at or near atmospheric.

Example 1

Membrane Formulations Included in a Temperature Independent Membrane Structure

[0134] Experiments were performed to test membrane formulations that may be included a temperature independent membrane structure.

[0135] The membrane formulations were prepared and tested as follows.

Control Membrane Formulation

[0136] Control membranes were formulated as described in U.S. patent application Ser. No. 11/734,272, the disclosure of which is incorporated herein by reference in its entirety. Control membranes had a positive correlation with temperature (e.g., sensor current increased as temperature increased, and sensor current decreased as temperature decreased). Control analyte sensors were dip coated with the control membrane formulation and cured for at least 24 hours before use.

Experiment 1 Membrane Formulation

[0137] The Experiment 1 membrane formulation was prepared as follows: 164 mg/mL (0.43 mmol/mL) poly(styrene-co-maleic anhydride) polymer (SMA polymer) was mixed with 20 mg/mL (0.109 mmol/mL) dodecylamine (MW=184) and 70 mg/mL (0.117 mmol/mL) poly(propylene glycol)-block-poly(ethylene glycol)-block-poly(propylene glycol) (2-aminopropyl ether) (Jeffamine® M-600, Huntsman International LLC) in 1,4-dioxane. This solution was crosslinked with 100 mg/mL (0.222 mmol/mL) poly(propylene glycol)-block-poly(ethylene glycol)-block-poly(propylene glycol) bis(2-aminopropyl ether) crosslinker (Jeffamine® ED-900 crosslinker, Huntsman International LLC) to form the Experiment 1 membrane solution. The Experiment 1 analyte sensors were dip coated with the Experiment 1 membrane formulation and cured for at least 24 hours before use.

Testing Method

[0138] Sensors were tested in 1 liter of PBS buffer (pH 7) containing 5 mM glucose with a temperature ranging from 27° C. to 42° C. The temperature was controlled by a circulated water bath system with a digital temperature controller.

[0139] Table 1 shows the current at different temperatures for the control and Experiment 1 membrane formulations.

TABLE 1

Current at Different Temperatures (nA, 5 mM glucose)				
	27° C.	32° C.	37° C.	42° C.
Control	2.10575	2.68575	3.5095	3.8472
Experiment 1	6.1035	4.5775	1.9225	1.5565

[0140] Table 2 shows the percent increase per degree under air for the control and Experiment 1 membrane formulations.

TABLE 2

% Increase per Degree under Air (5 mM glucose)			
	27° C. to 32° C.	32° C. to 37° C.	37° C. to 42° C.
Control	5.0%	5.5%	1.9%
Experiment 1	-5.6%	-15.9%	-4.1%

[0141] FIG. 6 shows a graph of normalized sensor signal at different temperatures for the control and Experiment 1 membrane formulations. As demonstrated in FIG. 6, sensors that included the Experiment 1 membrane formulation had a negative correlation with temperature, such that the sensor signal decreased as the temperature increased (e.g., from 27° C. to 42° C.) (and vice versa, the sensor signal increased as the temperature decreased, e.g., from 42° C. to 27° C.).

[0142] FIG. 7 shows a graph of the effect of temperature on the current for a sensor coated with the control membrane. Current (nA) was measured over time (hr) at various temperatures (e.g., 27° C. to 42° C.). As demonstrated in FIG. 7, sensors that included a control membrane formulation had a positive correlation with temperature, such that the sensor current decreased as the temperature decreased (e.g., from 42° C. to 32° C. and from 32° C. to 27° C.) and increased as temperature increased (e.g., from 27° C. to 37° C.).

[0143] FIG. 8 shows a graph of the effect of temperature on the current for a sensor coated with the Experiment 1 membrane. Current (nA) was measured over time (hr) at various temperatures (e.g., 27° C. to 42° C.). As demonstrated in FIG. 8, sensors that included the Experiment 1 membrane formulation had a negative correlation with temperature, such that the sensor current increased as the temperature decreased (e.g., from 42° C. to 32° C. and from 32° C. to 27° C.) and decreased as temperature increased (e.g., from 27° C. to 37° C.).

[0144] The results from these experiments demonstrate that membrane formulations may have a negative correlation with temperature, where the sensor current increases as the temperature decreases and the sensor current decreases as temperature increases. These experiments also indicate that a membrane having a negative correlation with temperature (e.g., the Experiment 1 membrane) may be combined (in the appropriate thickness) with a membrane having a positive correlation with temperature (e.g., the control membrane) to produce a layered membrane structure that is substantially temperature independent as described herein.

1-65. (canceled)

67. A method of fabricating an electrode for use in an analyte sensor, the method comprising:

contacting an electrode with a sensing layer; and either contacting the sensing layer with a first membrane having a negative temperature coefficient, and then contacting the first membrane with a second membrane having a positive temperature coefficient, or contacting the sensing layer with a second membrane having a positive temperature coefficient, and then contacting the second membrane with a first membrane having a negative temperature coefficient, wherein the stacked membrane structure has an analyte permeability that is substantially temperature independent.

68. The method of claim **67**, wherein the analyte sensor generates signals that are substantially temperature independent over a range of temperatures.

69. The method of claim **68**, wherein the range of temperatures is from 25° C. to 45° C.

70. The method of claim **68**, wherein the analyte sensor generates signals that are within 90% or more of each other over the temperature range at a constant analyte concentration.

71. The method of claim **68**, wherein the analyte sensor generates signals that are within 95% or more of each other over the temperature range at a constant analyte concentration.

72. The method of claim **67**, wherein the stacked membrane structure is configured to have a total temperature coefficient that is substantially zero.

73. The method of claim **67**, wherein the first membrane is configured to have an analyte permeability that varies inversely with temperature, and the second membrane is configured to have an analyte permeability that varies directly with temperature.

74. The method of claim **67**, wherein the first membrane comprises: poly(styrene-co-maleic anhydride), dodecylamine and poly(propylene glycol)-block-poly(ethylene glycol)-block-poly(propylene glycol) (2-aminopropyl ether) cross-linked with poly(propylene glycol)-block-poly(ethylene glycol)-block-poly(propylene glycol) bis(2-aminopropyl

ether); poly(n-isopropyl acrylamide); or a copolymer of poly(ethylene oxide) and poly(propylene oxide).

75. The method of claim **67**, wherein the second membrane comprises polyvinylpyridine, a derivative of polyvinylpyridine, polyvinylimidazole, a derivative of polyvinylimidazole, or a combination thereof.

76. The method of claim **67**, wherein the first and second membranes are chemically bound to each other.

77. The method of claim **67**, wherein the first and second membranes are laminated to each other.

78. The method of claim **67**, wherein the first and second membranes are crosslinked to each other.

79. The method of claim **67**, wherein the stacked membrane structure is chemically bound to the sensing layer.

80. The method of claim **67**, wherein the stacked membrane structure is laminated to the sensing layer.

81. The method of claim **67**, wherein the stacked membrane structure is crosslinked to the sensing layer.

82. The method of claim **67**, wherein the stacked membrane structure is configured to be a diffusion-limiting membrane structure.

83. The method of claim **67**, wherein the stacked membrane structure is configured to be a size-exclusion membrane structure.

84. The method of claim **67**, wherein the sensing layer comprises an analyte-responsive enzyme and a redox mediator.

85. The method of claim **84**, wherein at least one of the analyte-responsive enzyme and the redox mediator is chemically bound to a polymer.

86. The method of claim **84**, wherein at least one of the analyte-responsive enzyme and the redox mediator is cross-linked to a polymer.

87. The method of claim **84**, wherein the redox mediator comprises a ruthenium-containing complex or an osmium-containing complex.

88. The method of claim **84**, wherein the analyte sensor is a glucose sensor.

* * * * *

专利名称(译)	具有温度独立膜的分析物传感器		
公开(公告)号	US20170258377A1	公开(公告)日	2017-09-14
申请号	US15/607099	申请日	2017-05-26
[标]申请(专利权)人(译)	雅培糖尿病护理公司		
申请(专利权)人(译)	雅培糖尿病INC.		
当前申请(专利权)人(译)	雅培糖尿病INC.		
[标]发明人	HOSS UDO FELDMAN BENJAMIN J OUYANG TIANMEI		
发明人	HOSS, UDO FELDMAN, BENJAMIN J. OUYANG, TIANMEI		
IPC分类号	A61B5/1468 C12Q1/00 A61B5/00 A61B5/145 A61B5/1486		
CPC分类号	A61B5/1468 A61B5/14507 A61B5/14532 C12Q1/002 A61B5/1486 A61B5/14865 A61B5/4839 A61B5/14546		
优先权	61/368553 2010-07-28 US		
其他公开文献	US10022076		
外部链接	Espacenet USPTO		

摘要(译)

本公开的实施方案涉及分析物确定方法和装置(例如,电化学分析物监测系统),其具有膜结构,其具有基本上与温度无关的分析物渗透性。所述装置还包括设置在体内分析物传感器的工作电极上的传感层,例如使用分析物传感器和/或测试条的连续和/或自动体内监测。还提供了在分析物监测中使用例如电化学分析物传感器的系统和方法。

