



US010062456B2

(12) **United States Patent**
Baronov et al.

(10) **Patent No.: US 10,062,456 B2**
(45) **Date of Patent: Aug. 28, 2018**

(54) **SYSTEMS AND METHODS FOR
TRANSITIONING PATIENT CARE FROM
SIGNAL BASED MONITORING TO RISK
BASED MONITORING**

(71) Applicant: **Etiometry Inc.**, Boston, MA (US)

(72) Inventors: **Dimitar V. Baronov**, Boston, MA (US);
Evan J. Butler, New Haven, CT (US);
Jesse M. Lock, Winchester, MA (US);
Michael F. McManus, Halifax, MA
(US)

(73) Assignee: **Etiometry Inc.**, Boston, MA (US)

(*) Notice: Subject to any disclaimer, the term of this patent is extended or adjusted under 35 U.S.C. 154(b) by 90 days.

(21) Appl. No.: **14/727,696**

(22) Filed: **Jun. 1, 2015**

(65) **Prior Publication Data**

US 2015/0347704 A1 Dec. 3, 2015

Related U.S. Application Data

(63) Continuation of application No. 13/826,441, filed on Mar. 14, 2013, which is a continuation-in-part of (Continued)

(51) **Int. Cl.**
G16H 50/30 (2018.01)
G16H 50/50 (2018.01)

(Continued)

(52) **U.S. Cl.**
CPC **G16H 50/30** (2018.01); **A61B 5/0205** (2013.01); **A61B 5/7275** (2013.01); **A61B 5/742** (2013.01);

(Continued)

(58) **Field of Classification Search**
CPC . G06F 19/345; G06F 19/3431; G06F 19/3487
(Continued)

(56) **References Cited**

U.S. PATENT DOCUMENTS

6,067,466 A 5/2000 Selker et al. 600/513
7,149,756 B1 12/2006 Schmitt et al.
(Continued)

FOREIGN PATENT DOCUMENTS

EP 0 765 134 B1 7/2007 A61B 5/00
RU 2 345 705 C2 2/2009 A61B 5/02
(Continued)

OTHER PUBLICATIONS

Rose, Cedric, "A Dynamic Bayesian Network for Handling Uncertainty in a Decision Support System Adapted to the Monitoring of Patients Treated by Hemodialysis," Proceedings of the 17th IEEE International Conference on Tools with Artificial Intelligence (ICTAI '05), 2005 (Year: 2005).*

(Continued)

Primary Examiner — Elaine Gort

Assistant Examiner — John P Go

(74) *Attorney, Agent, or Firm* — Sunstein Kann Murphy & Timbers LLP

(57) **ABSTRACT**

A risk-based patient monitoring system for critical care patients combines data from multiple sources to assess the current and the future risks to the patient, thereby enabling providers to review a current patient risk profile and to continuously track a clinical trajectory. A physiology observer module in the system utilizes multiple measurements to estimate Probability Density Functions (PDF) of a number of Internal State Variables (ISVs) that describe a components of the physiology relevant to the patient treatment and condition. A clinical trajectory interpreter module in the system utilizes the estimated PDFs of ISVs to identify under which probable patient states the patient can be currently categorized and assign a probability value that the patient will be in each of the identified states. The combi-

(Continued)

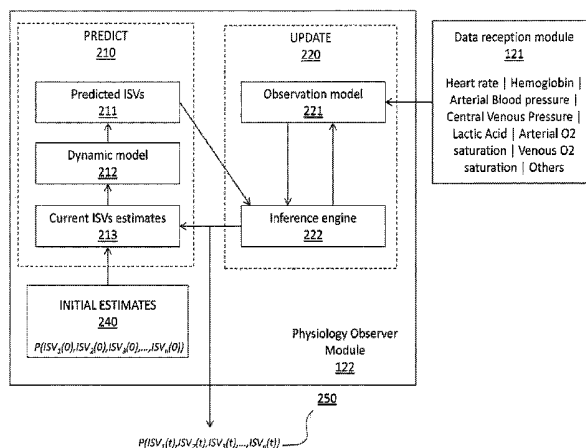

nation of patient states and their probabilities is defined as the clinical risk to the patient.

8 Claims, 49 Drawing Sheets

Related U.S. Application Data

application No. 13/689,029, filed on Nov. 29, 2012, now abandoned, and a continuation-in-part of application No. 13/328,411, filed on Dec. 16, 2011, now abandoned.

- (60) Provisional application No. 61/727,820, filed on Nov. 19, 2012, provisional application No. 61/699,492, filed on Sep. 11, 2012, provisional application No. 61/684,241, filed on Aug. 17, 2012, provisional application No. 61/620,144, filed on Apr. 4, 2012, provisional application No. 61/614,861, filed on Mar. 23, 2012, provisional application No. 61/614,846, filed on Mar. 23, 2012, provisional application No. 61/774,274, filed on Mar. 7, 2013.

(51) **Int. Cl.**

- G16H 50/20* (2018.01)
- A61B 5/00* (2006.01)
- G06Q 50/22* (2018.01)
- A61B 5/0205* (2006.01)
- A61B 5/024* (2006.01)
- A61B 5/0402* (2006.01)
- A61B 5/145* (2006.01)

(52) **U.S. Cl.**

- CPC *G06Q 50/22* (2013.01); *G16H 50/20* (2018.01); *G16H 50/50* (2018.01); *A61B 5/024* (2013.01); *A61B 5/0402* (2013.01); *A61B 5/14532* (2013.01); *A61B 5/14542* (2013.01); *A61B 5/14546* (2013.01); *A61B 2505/03* (2013.01)

(58) **Field of Classification Search**

- USPC 705/2, 3, 4
- See application file for complete search history.

(56)

References Cited

U.S. PATENT DOCUMENTS

7,590,550 B2	9/2009	Schoenberg	
2002/0035315 A1 *	3/2002	Ali	A61B 5/1455 600/300
2002/0077863 A1 *	6/2002	Rutledge	G06F 19/322 705/3
2003/0050568 A1	3/2003	Green et al.	600/538
2003/0065535 A1 *	4/2003	Karlov	G06Q 50/22 705/2
2003/0233250 A1	12/2003	Joffe et al.	
2004/0064357 A1	4/2004	Hunter et al.	705/10
2004/0078232 A1 *	4/2004	Troiani	G06Q 50/22 705/2
2004/0097460 A1	5/2004	Ivey et al.	514/44
2004/0158132 A1	8/2004	Zaleski	600/301
2004/0199332 A1	10/2004	Iliff	702/19
2004/0230105 A1	11/2004	Geva et al.	600/301
2005/0010444 A1 *	1/2005	Iliff	G06Q 50/22 705/2
2005/0240444 A1	10/2005	Wooten et al.	705/3
2006/0265249 A1	11/2006	Follis et al.	
2006/0289020 A1	12/2006	Tabak et al.	128/898
2007/0010723 A1	1/2007	Uutela et al.	600/301
2007/0031902 A1 *	2/2007	Pestano	B82Y 30/00 435/7.23

2007/0055552 A1	3/2007	St. Clair et al.	705/3
2007/0185391 A1	8/2007	Morgan	600/301
2007/0239043 A1	10/2007	Patel et al.	600/508
2007/0239409 A1	10/2007	Alan	703/2
2007/0260285 A1	11/2007	Libbus et al.	607/9
2008/0147763 A1	6/2008	Levin	708/400
2008/0172214 A1	7/2008	Col et al.	703/11
2008/0208631 A1	8/2008	Morita et al.	
2008/0228531 A1	9/2008	Kenedy et al.	705/4
2008/0235057 A1	9/2008	Weidenhaupt et al.	
2008/0300449 A1	12/2008	Gerber et al.	600/30
2009/0125333 A1	5/2009	Heywood et al.	705/3
2009/0300417 A1	12/2009	Bonissone et al.	714/26
2010/0057490 A1	3/2010	Kocis et al.	705/2
2010/0205138 A1	8/2010	Zhang et al.	706/52
2010/0324437 A1 *	12/2010	Freeman	A61B 5/085 600/529
2011/0004071 A1	1/2011	Faiola et al.	600/300
2011/0010197 A1	1/2011	Schoenberg	
2011/0112380 A1	5/2011	Robinson	
2011/0119212 A1	5/2011	De Bruin et al.	706/12
2011/0276342 A1 *	11/2011	Kazmierczak	G06F 19/3443 705/2
2012/0022336 A1	1/2012	Teixeira	
2013/0185096 A1	7/2013	Giusti et al.	705/3

FOREIGN PATENT DOCUMENTS

RU	2 442 531 C2	2/2012	A61B 5/00
WO	WO-2008036212 A2 *	3/2008	A61B 5/14551
WO	WO 2009/103156 A1	8/2009	G06F 19/00
WO	WO 2012/033771	3/2012	

OTHER PUBLICATIONS

Moons et al., Limitations of Sensitivity, Specificity, Likelihood Ratio, and Bayes' Theorem in Assessing Diagnostic Probabilities: A Clinic Example, *Epidemiology*, vol. 8, No. 1, dated Jan. 1997, pp. 12-17.

Harle et al, Information Visualization for Chronic Disease Risk Assessment, *AI & Health*, IEEE Computer Society, Nov./Dec. 2012, 5 pages.

International Searching Authority; Authorized Officer: M. Smirnov, International Search Report—International Application No. PCT/US2013/031512, dated Jul. 11, 2013, together with the Written Opinion of the International Searching Authority, 6 pages.

Unites States Patent and Trademark Office, Non-final Office Action dated Dec. 27, 2013, pertaining to U.S. Appl. No. 13/826,441, 59 pages.

Unites States Patent and Trademark Office, Non-Final Office Action, dated Apr. 10, 2014, pertaining to U.S. Appl. No. 13/328,411, 27 pages.

Unites States Patent and Trademark Office, Notice of Allowance and Fees Due, dated May 12, 2014, pertaining to U.S. Appl. No. 13/826,441, 45 pages.

Unites States Patent and Trademark Office, Non-Final Office Action, dated Jun. 6, 2014, pertaining to U.S. Appl. No. 13/689,029, 25 pages.

Unites States Patent and Trademark Office, Non-Final Office Action, dated Jul. 14, 2014, pertaining to U.S. Appl. No. 13/826,441, 16 pages.

Unites States Patent and Trademark Office, Final Office Action, dated Nov. 12, 2014, pertaining to U.S. Appl. No. 13/826,441, 9 pages.

European Patent Office, Supplemental European Search Report—Application No. EP 13764131, 10 pages, dated Oct. 21, 2015.

McMahon et al., "Comparison of non-invasive and invasive blood pressure in aeromedical care," *Anaesthesia* 2012, 67, pp. 1343-1347.

Parati et al., "Comparison of Finger and Intra-arterial Blood Pressure Monitoring at Rest and During Laboratory Testing," *Hypertension*, vol. 13, No. 6, Part 1, pp. 647-655.

European Patent Office, Communication pursuant to Article 94(3) EPC in European Patent Application No. 13764131.2, 14 pages, dated Sep. 29, 2016.

(56)

References Cited

OTHER PUBLICATIONS

Japanese Patent Office, Japanese Office Action for Japanese Patent Application No. 2015-503307, 3 pages, dated Feb. 2017.

Checchia et. al., *The Cardiac Intensive Care Unit Perspective on Hemodynamic Monitoring of Oxygen Transport Balance*, *Pediat. Crit. Care Med.* 2001, vol. 12, No. 14 (Suppl), pp. S69-S71.

United States Patent and Trademark Office: Before the Patent Trial and Appeal Board (PTAB), Examiner's Decision on Appeal—Affirmed, dated Oct. 20, 2017, pertaining to U.S. Appl. No. 13/826,441, 12 pages.

* cited by examiner

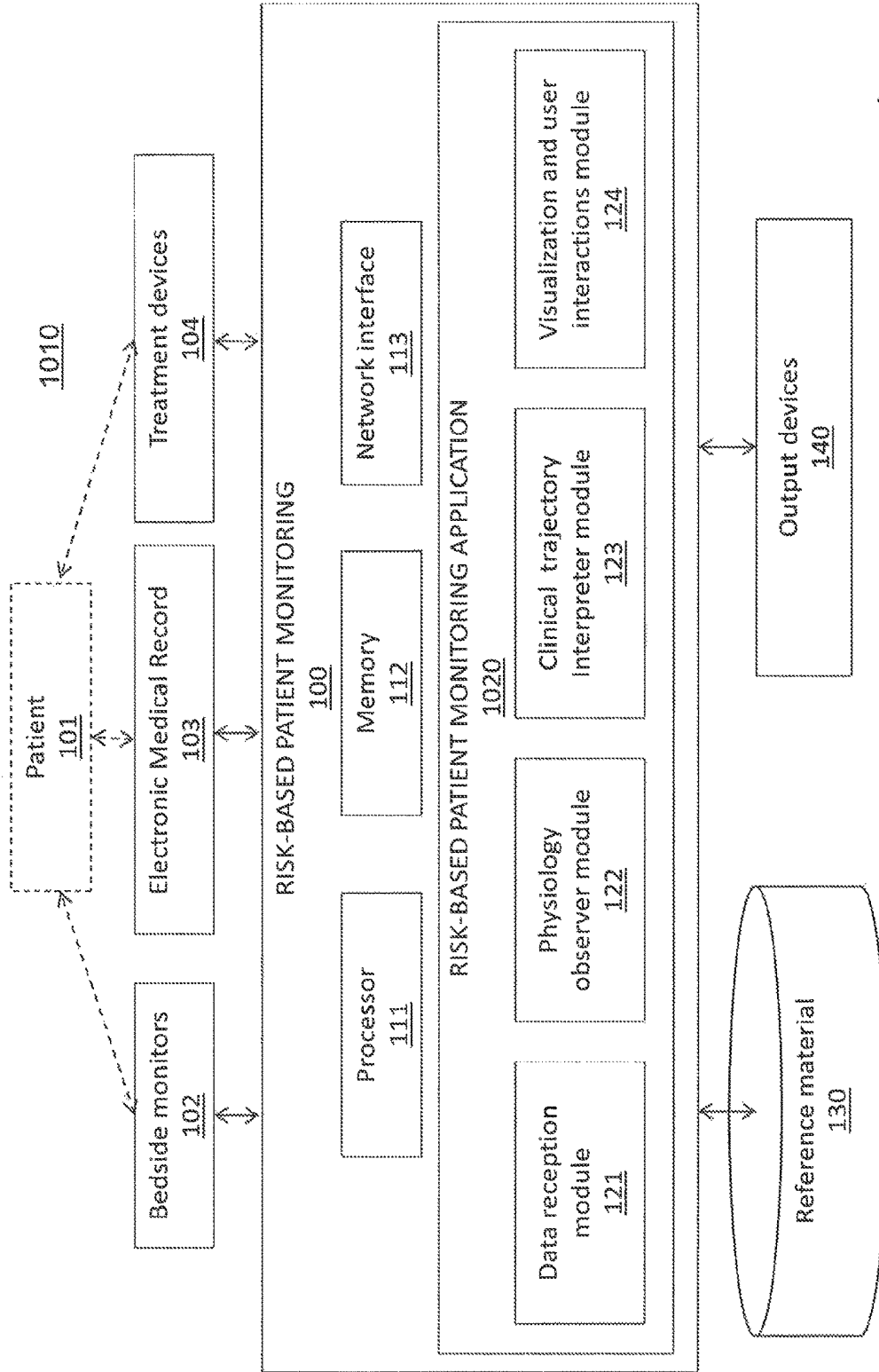

Fig. 1

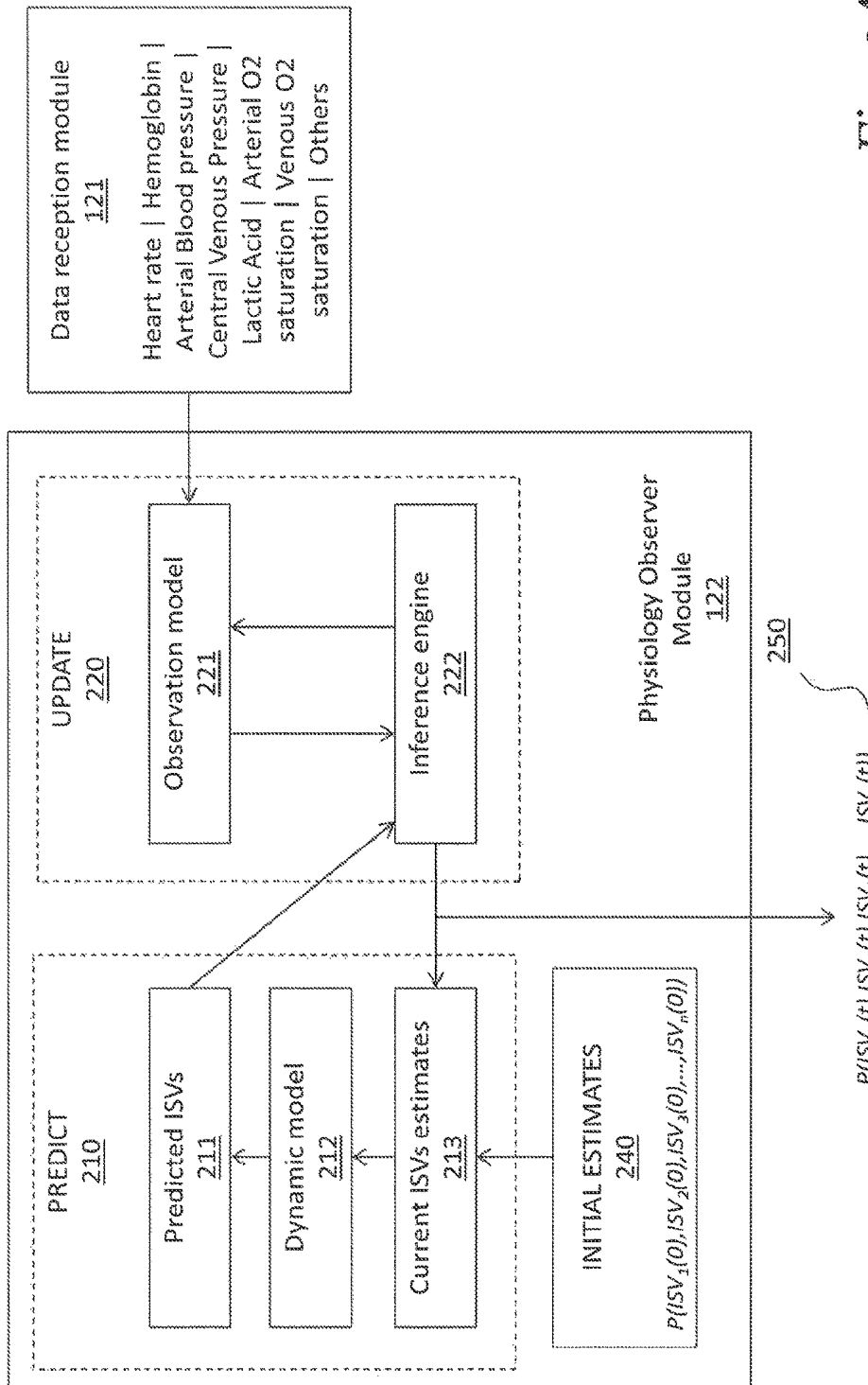

Fig. 2A

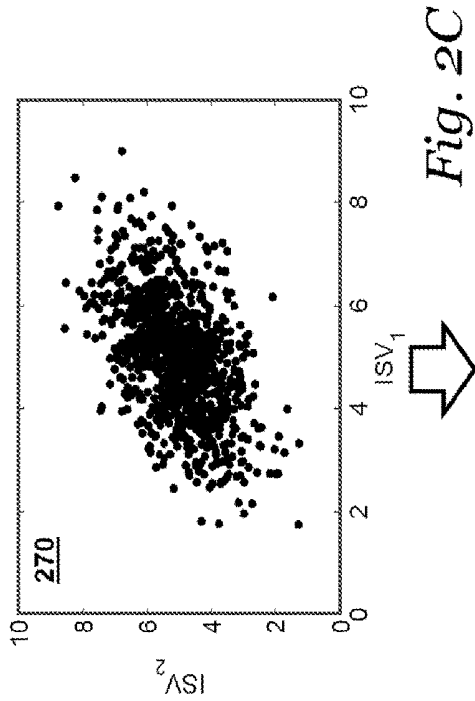

Fig. 2C

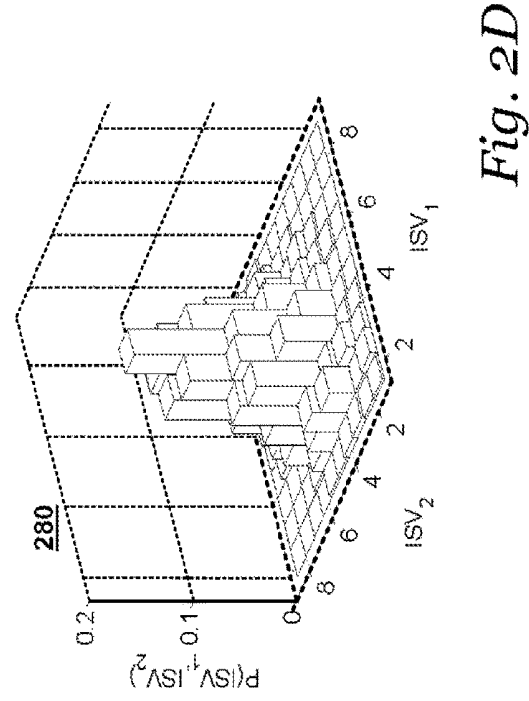

Fig. 2D

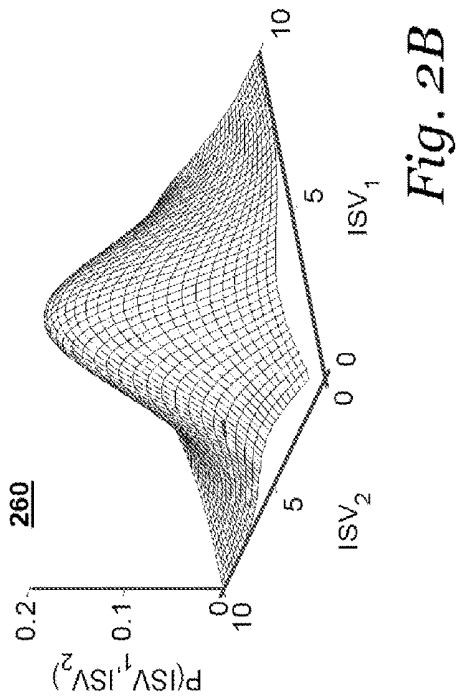

Fig. 2B

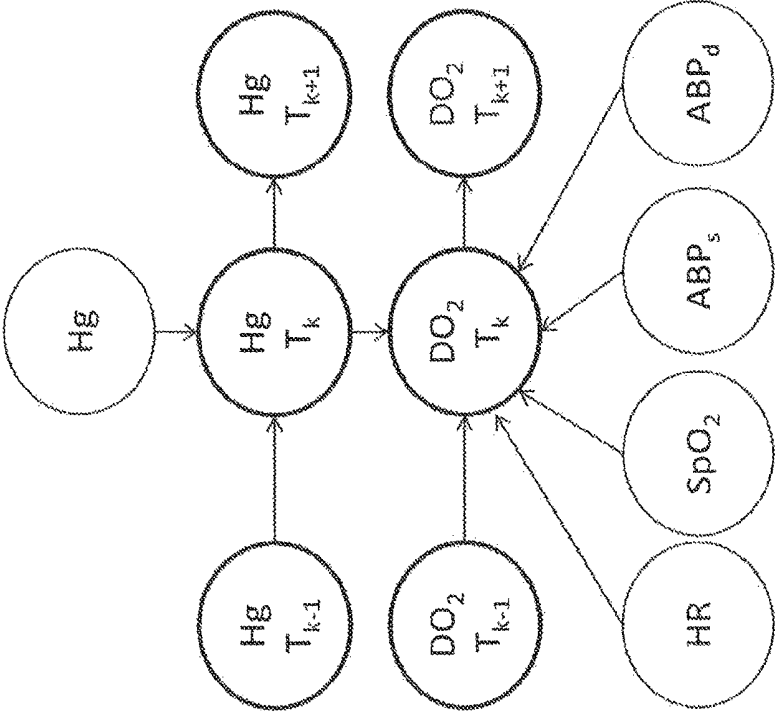

Fig. 3

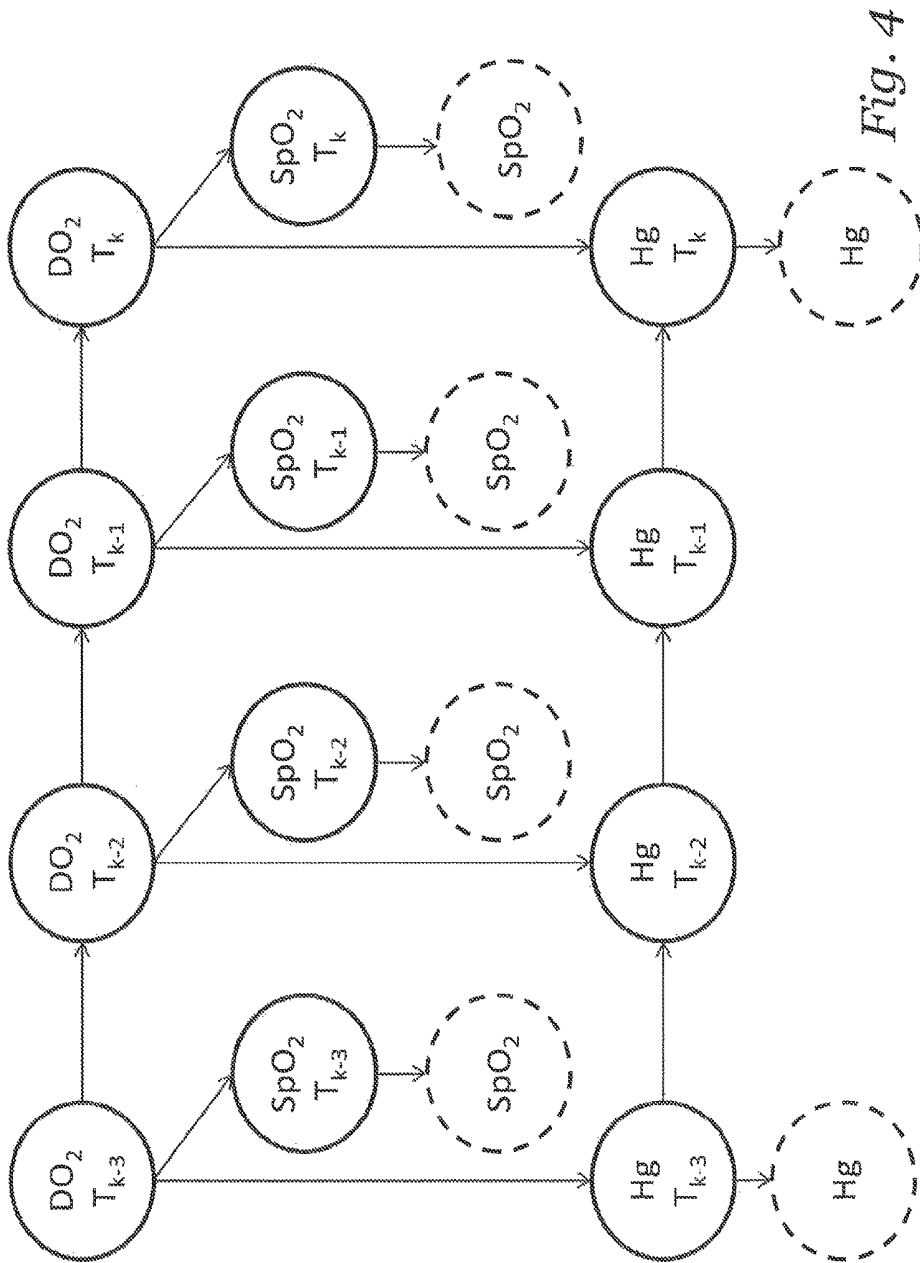
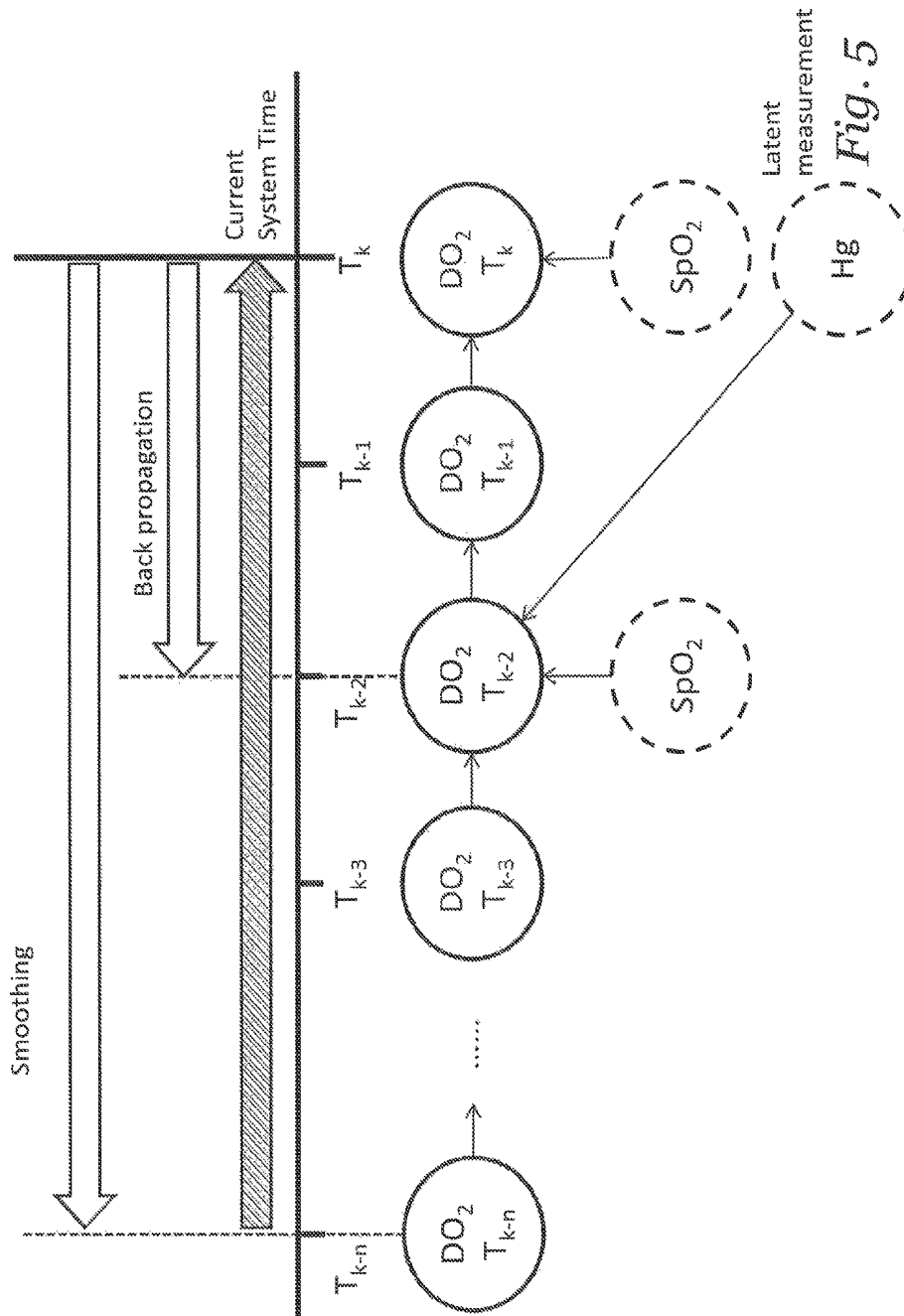

Fig. 4



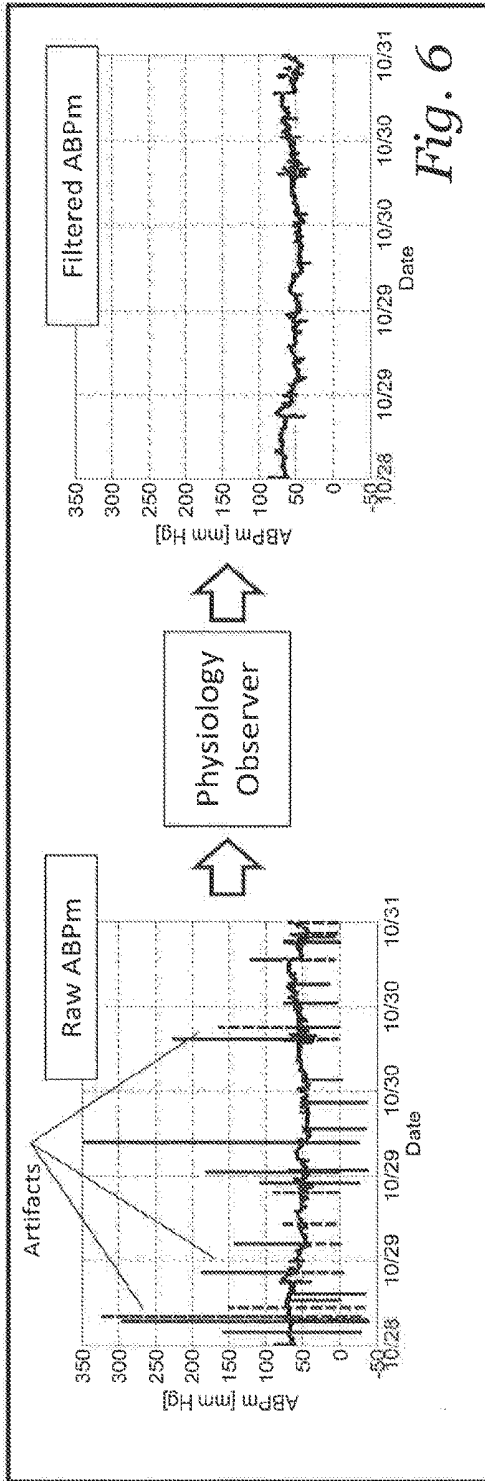

Fig. 6

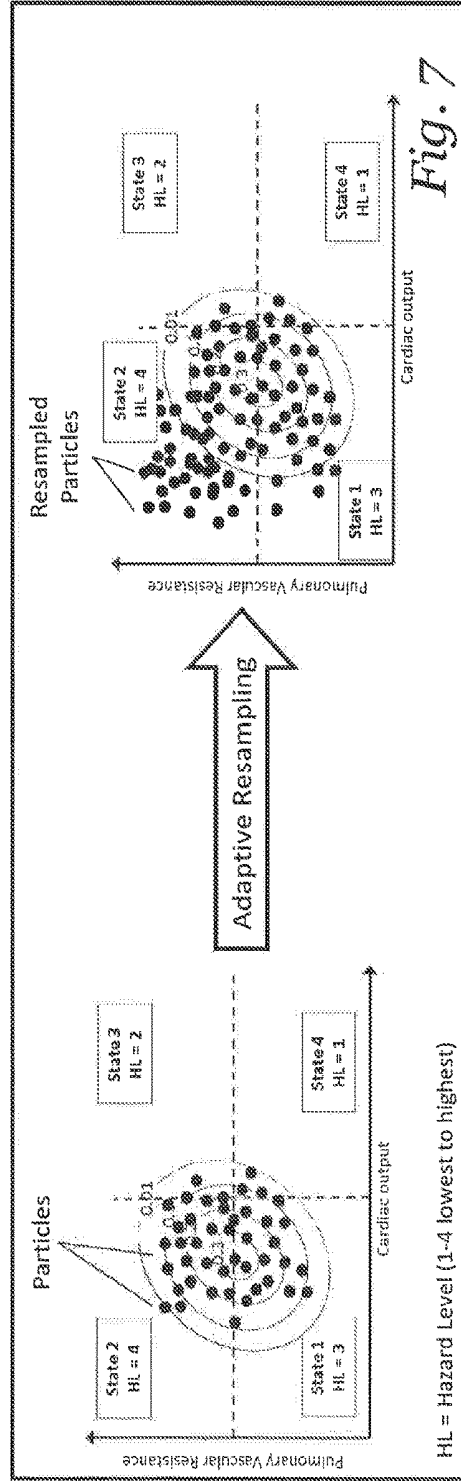

Fig. 7

HL = Hazard Level (1-4 lowest to highest)

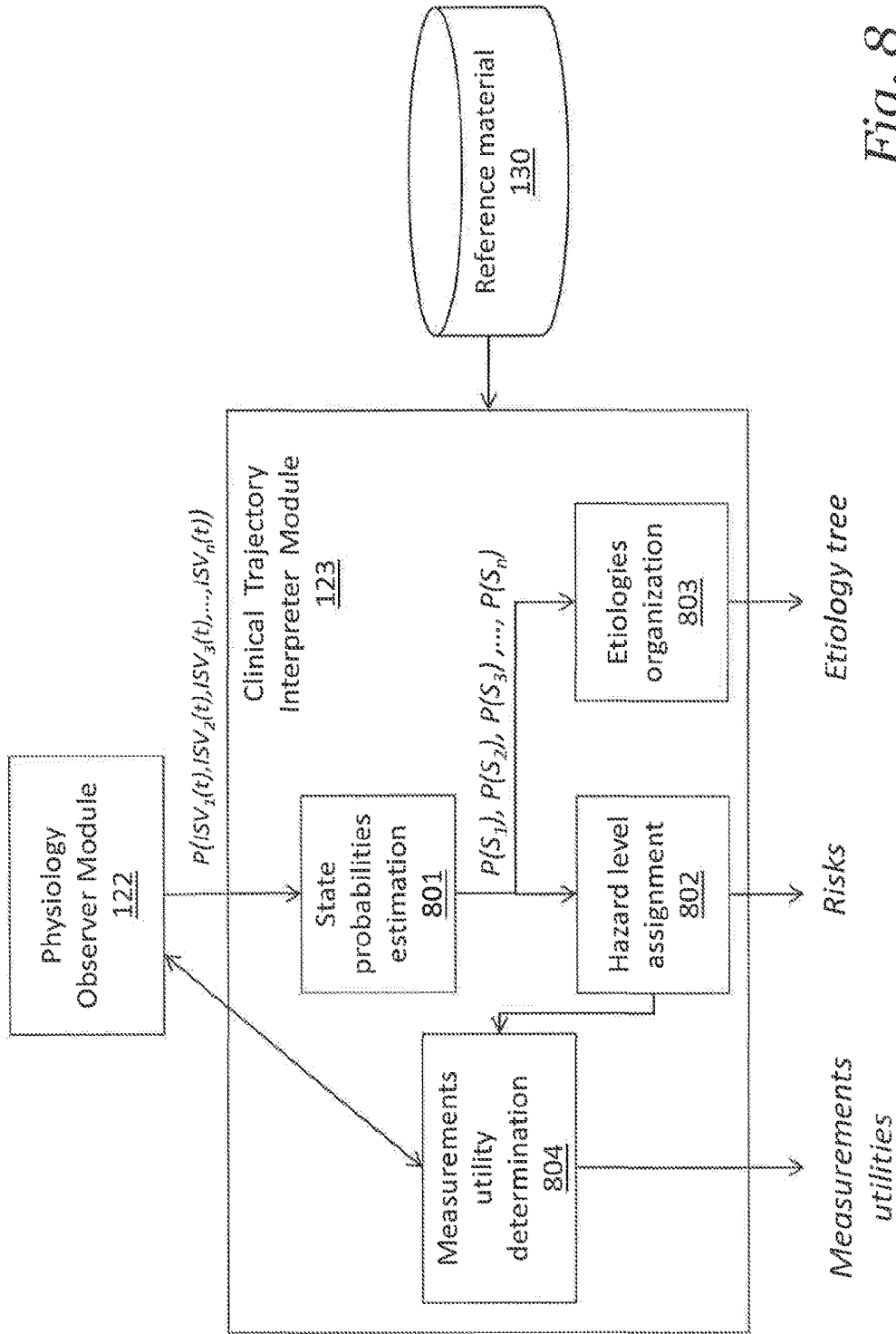

Fig. 8

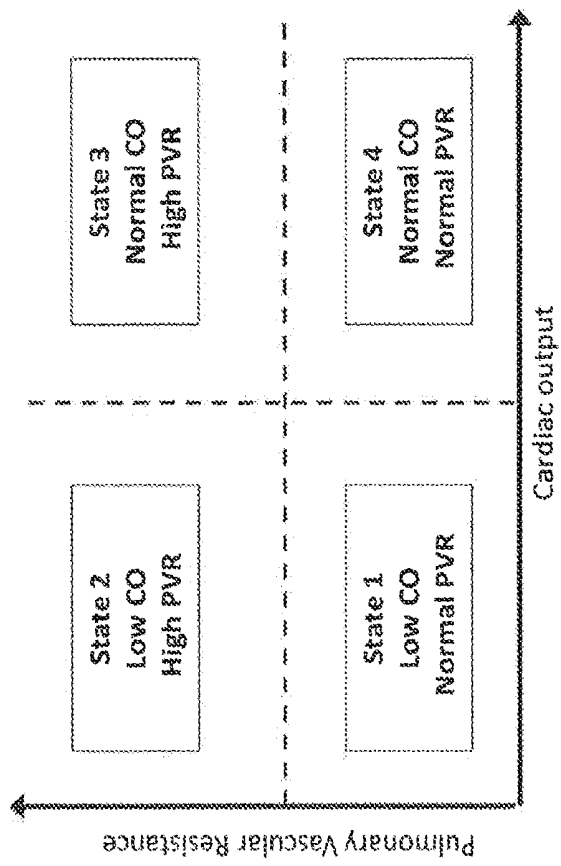

Fig. 9

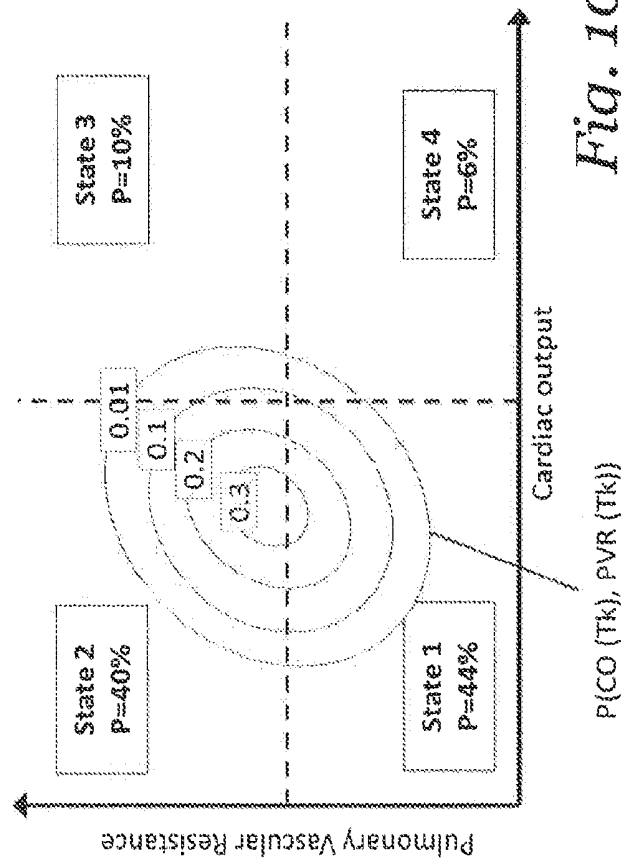

Fig. 10

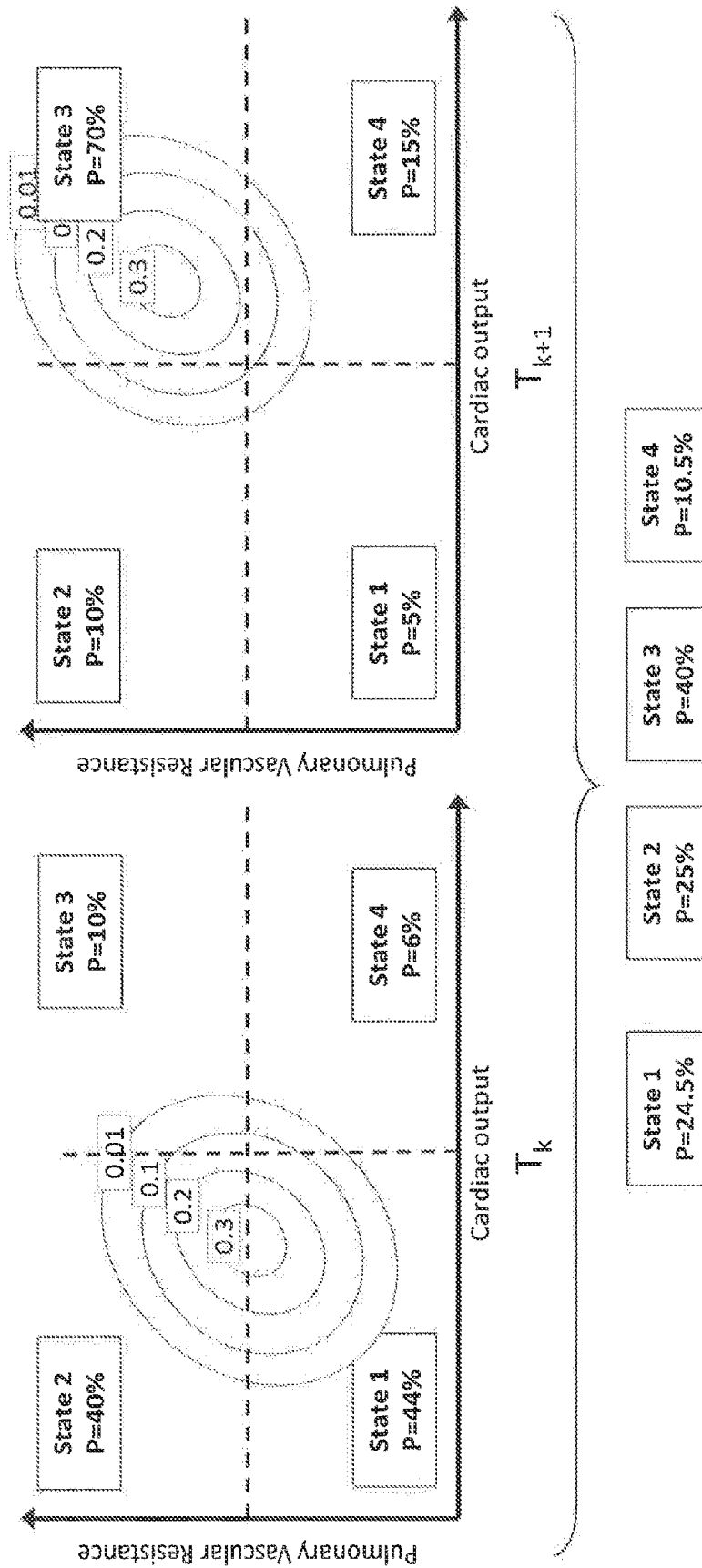

Fig. 11

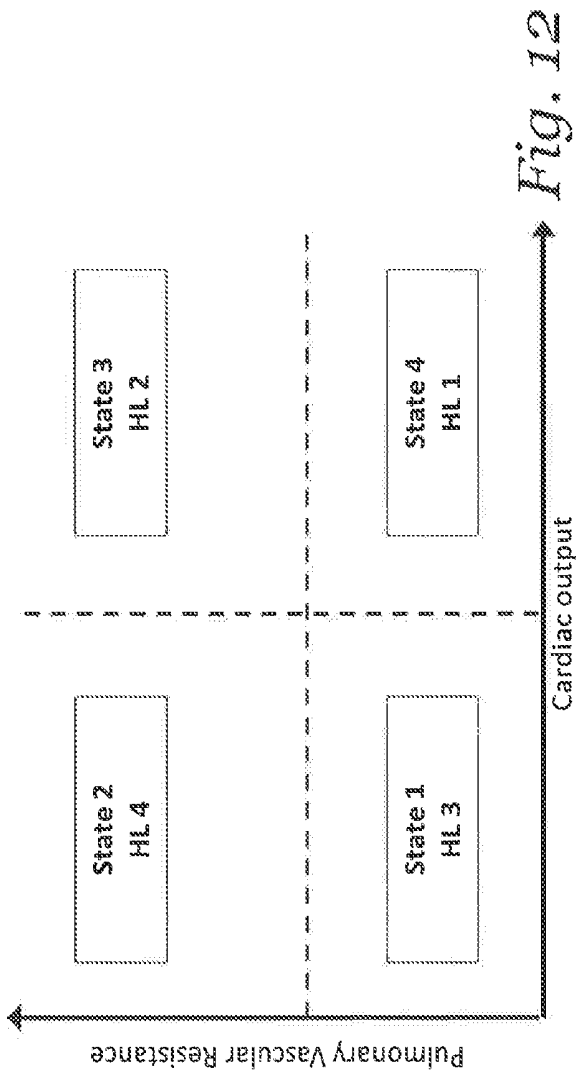

Fig. 12

Hazard Levels (HL)
1 – Minimal risk.
2 – Mild risk.
3 – Medium risk.
4 – Severe risk.

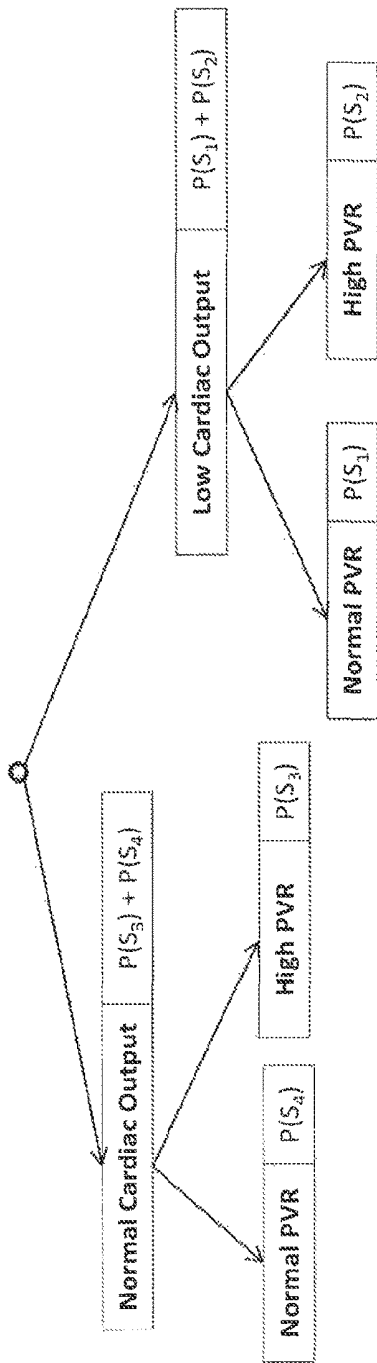

Fig. 13

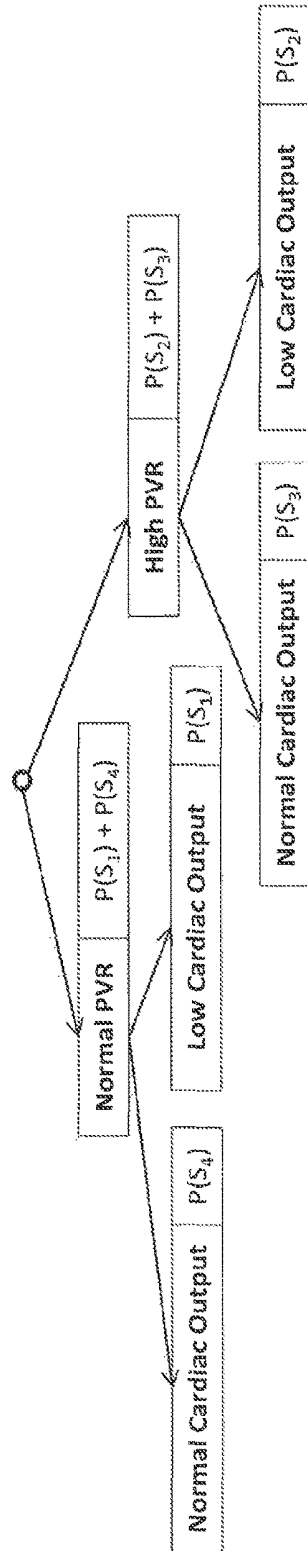

Fig. 14

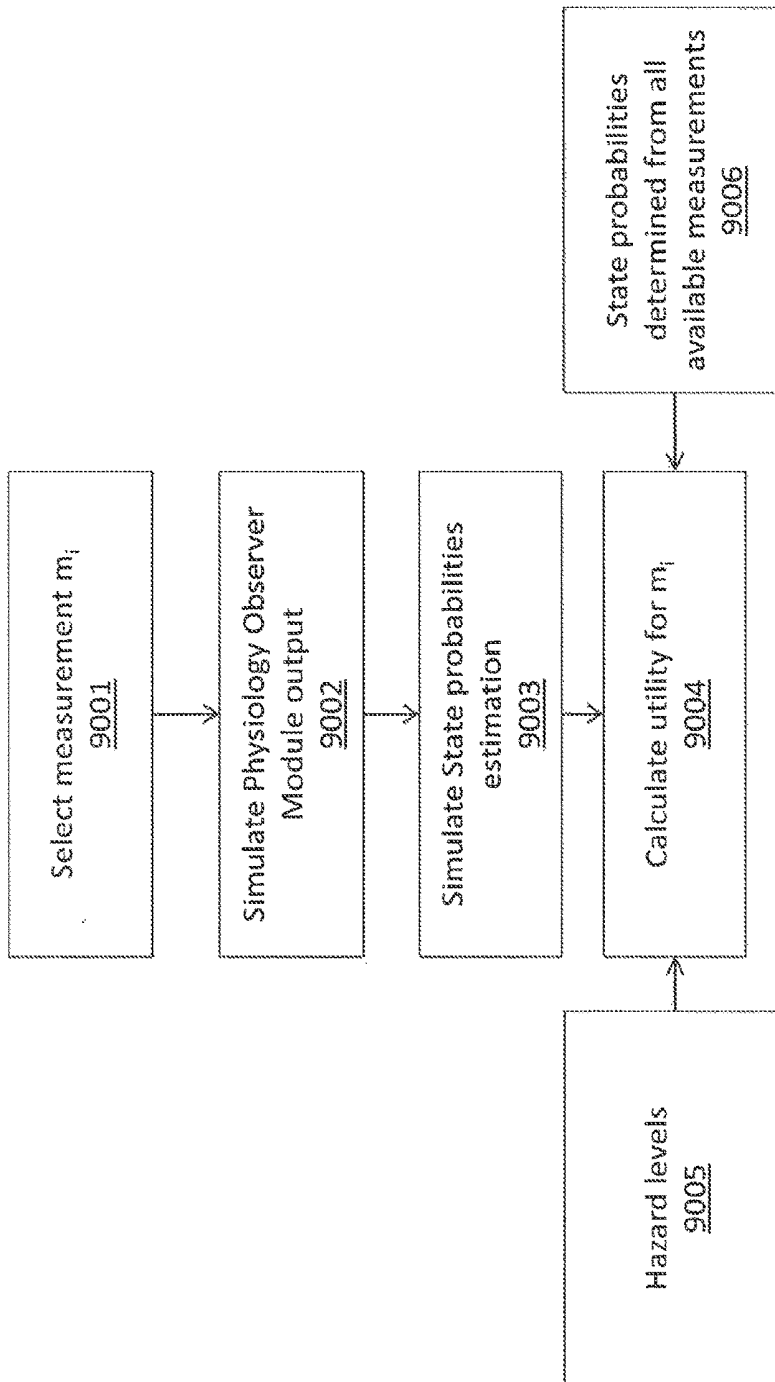

Fig. 15

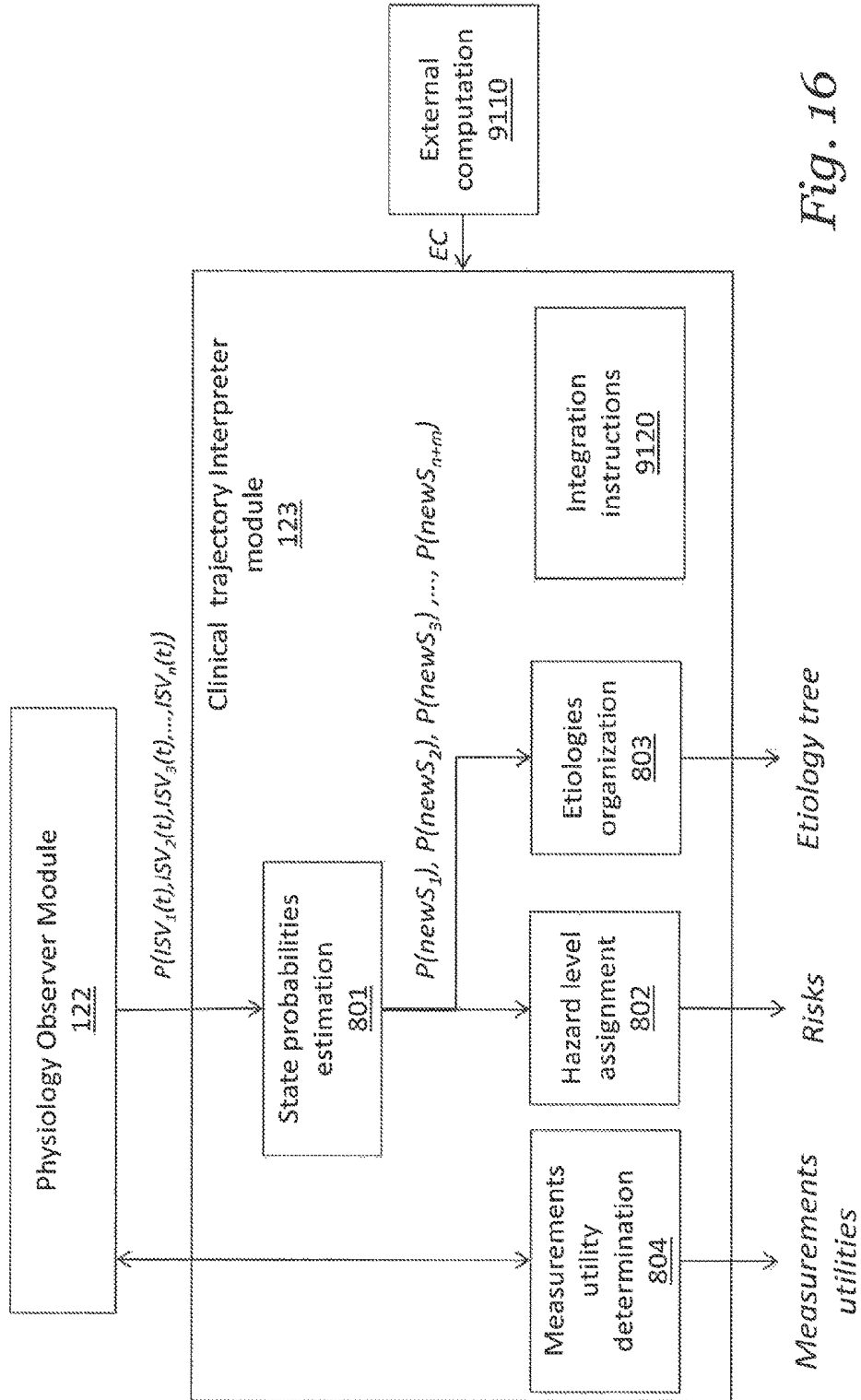

Fig. 16

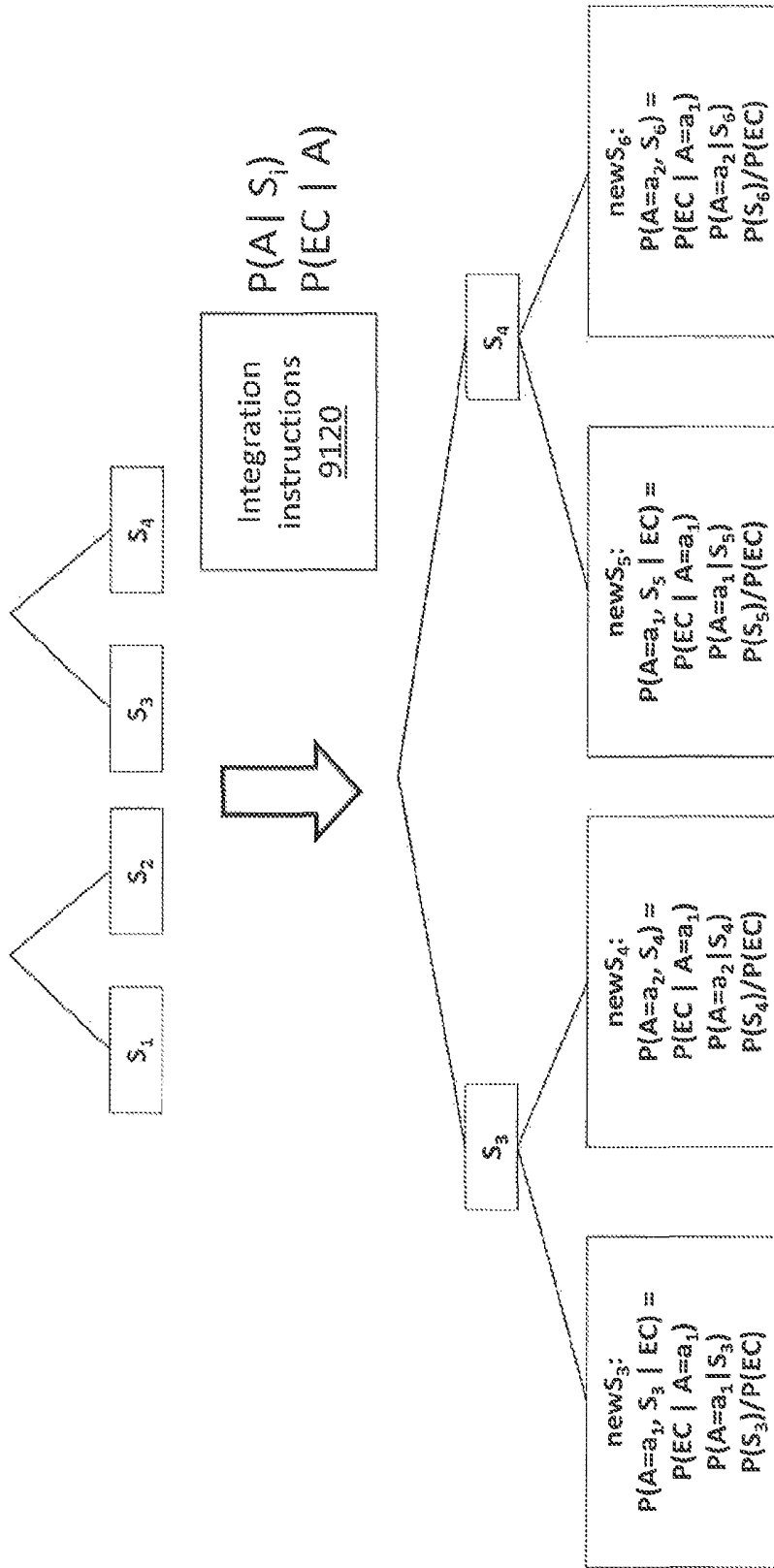

Fig. 17

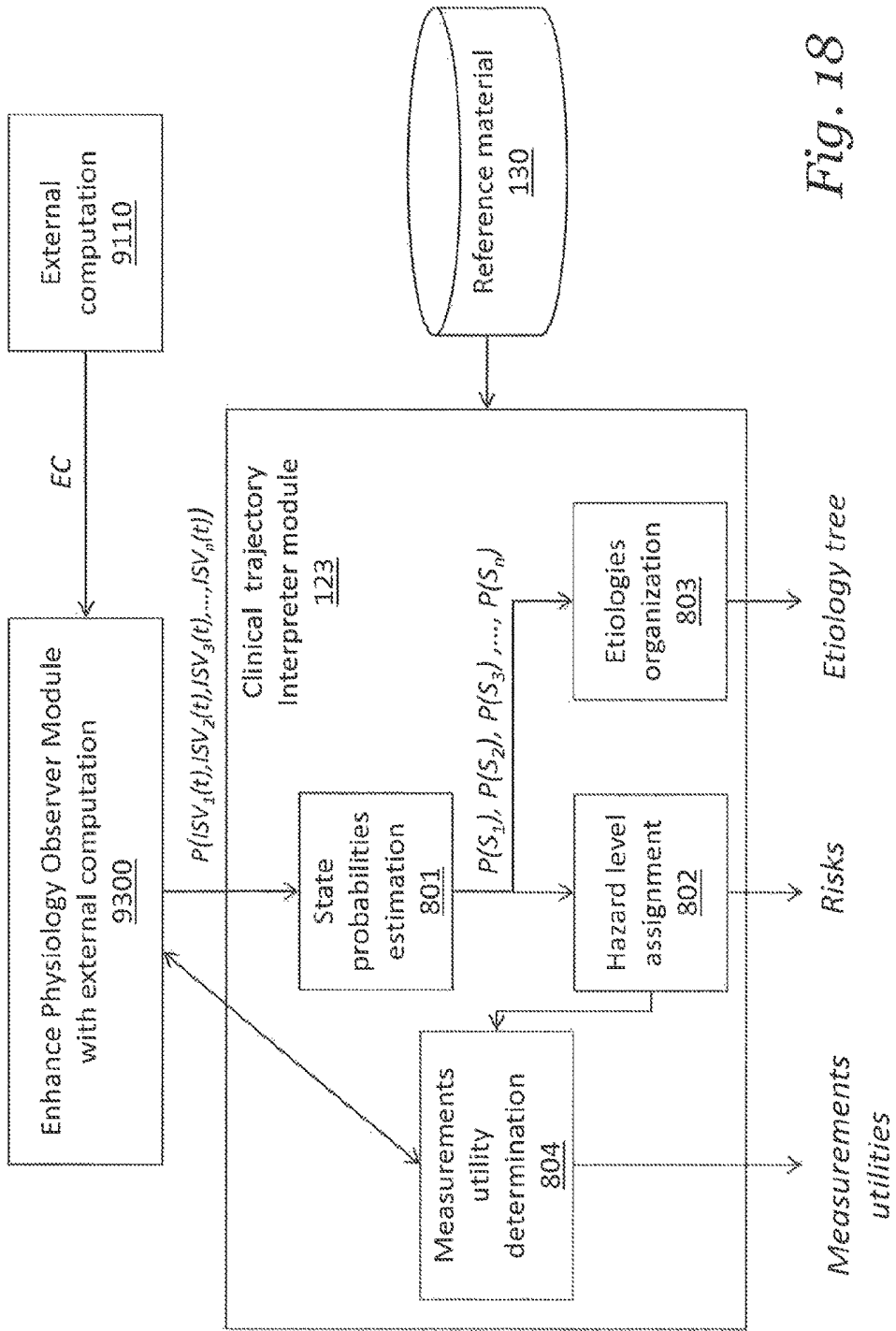

Fig. 18

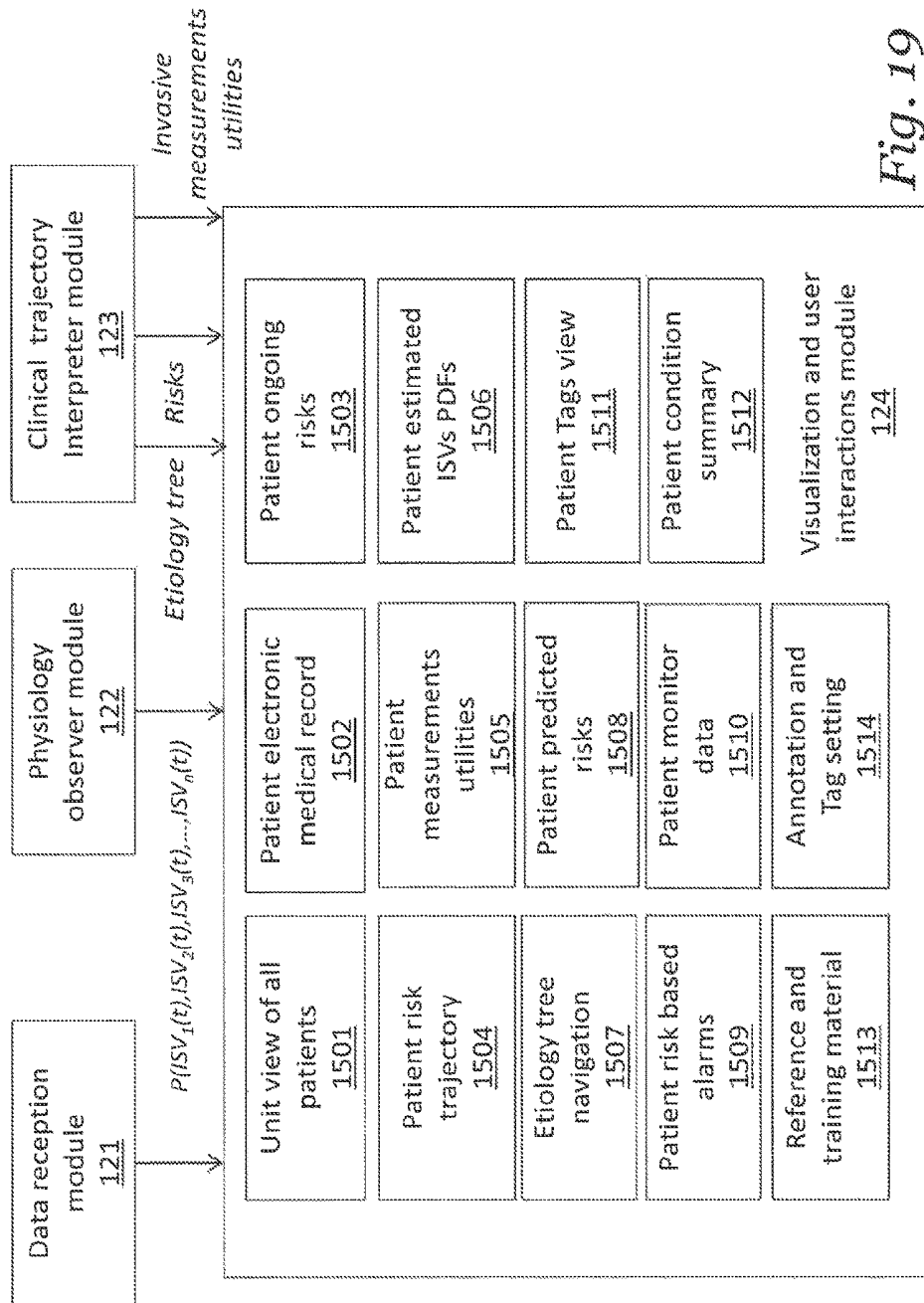
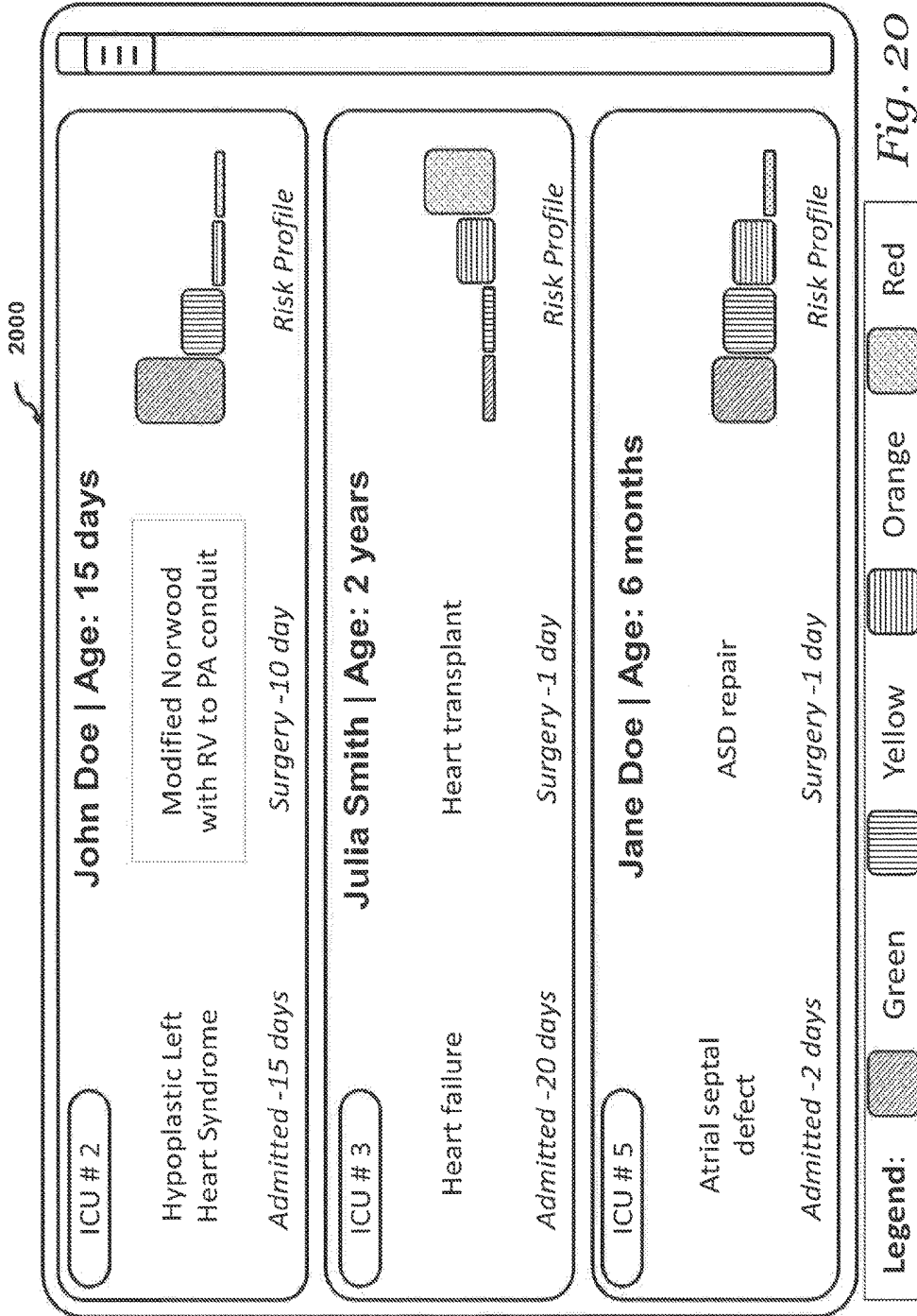
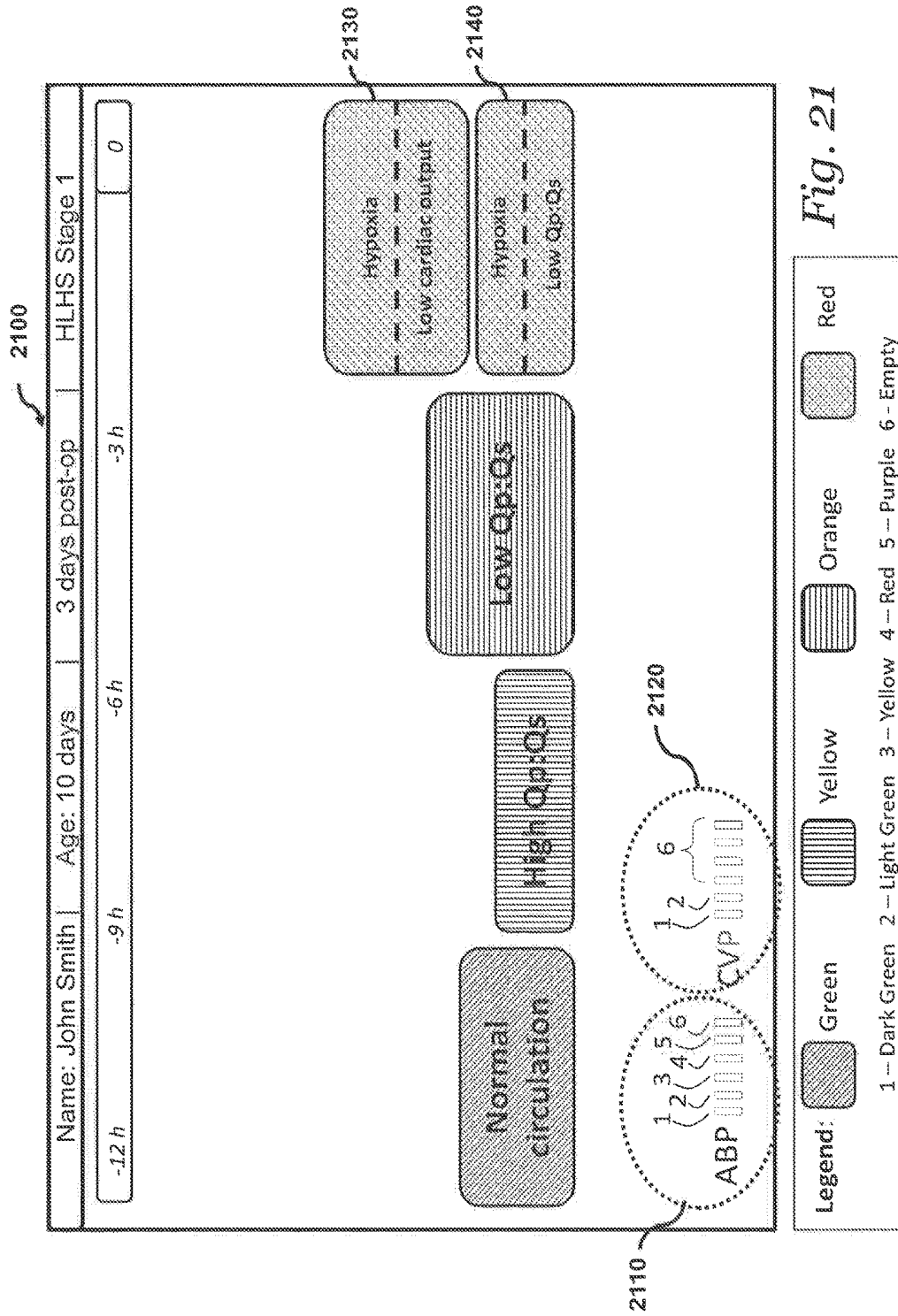
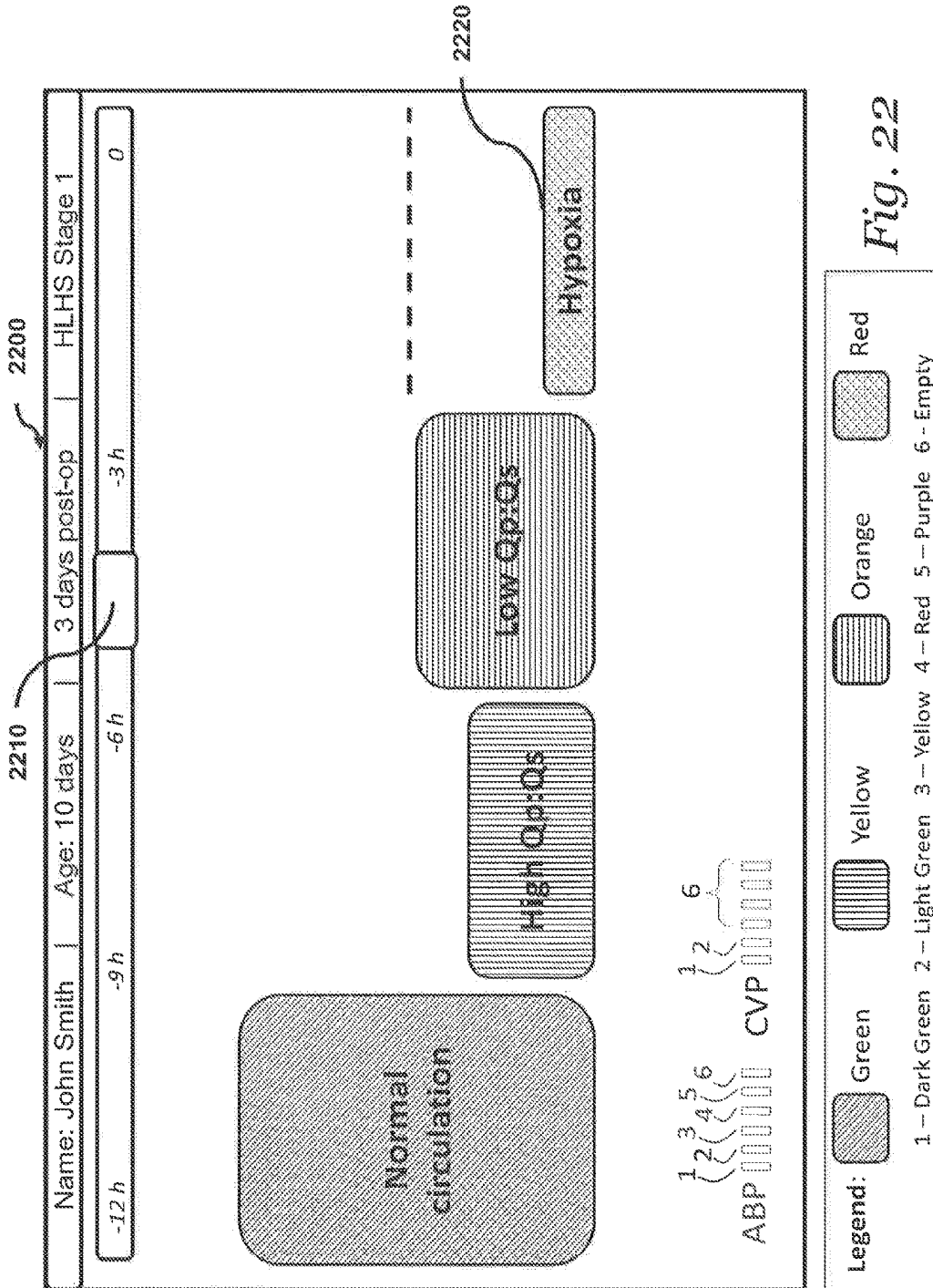
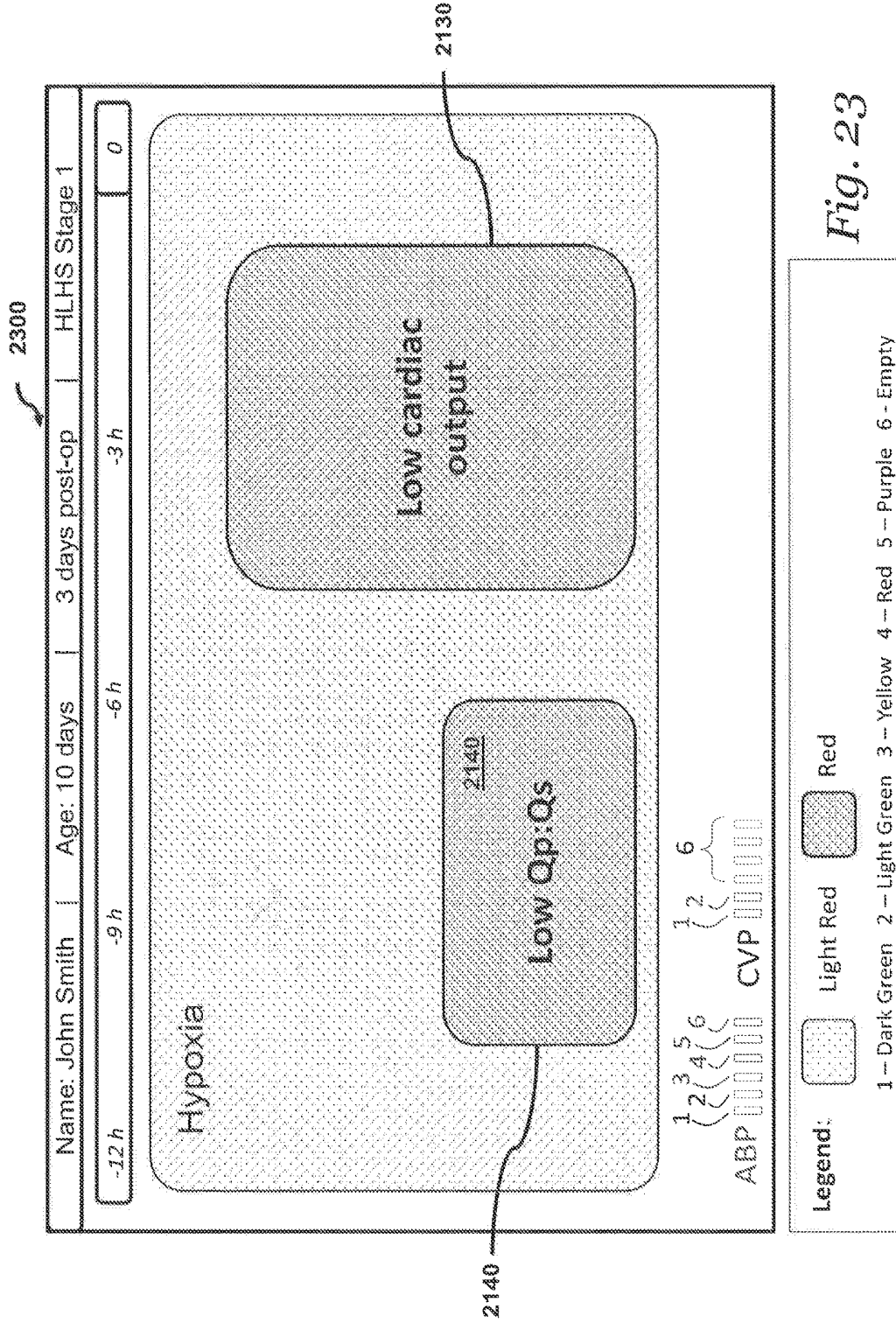

Fig. 19









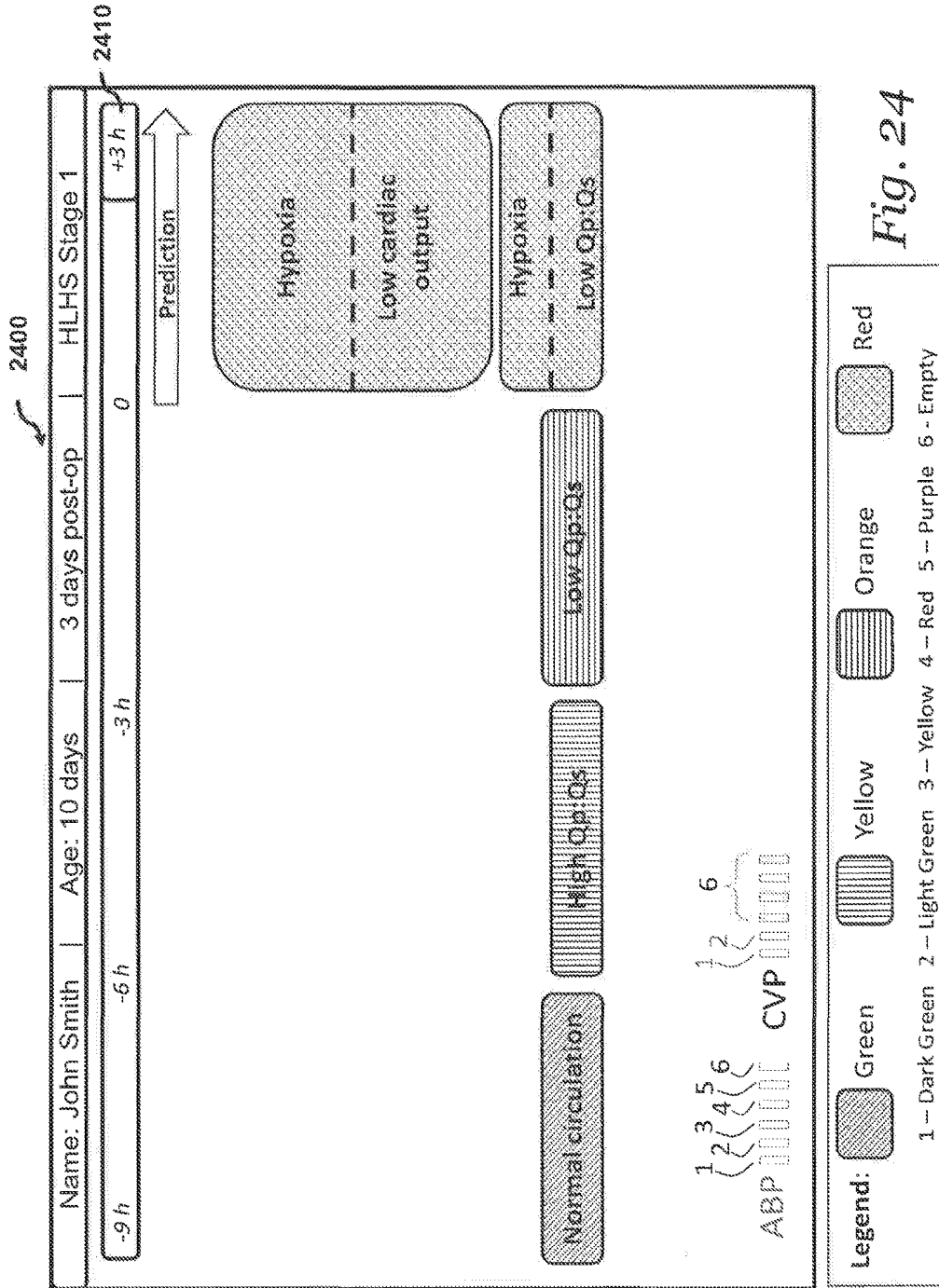

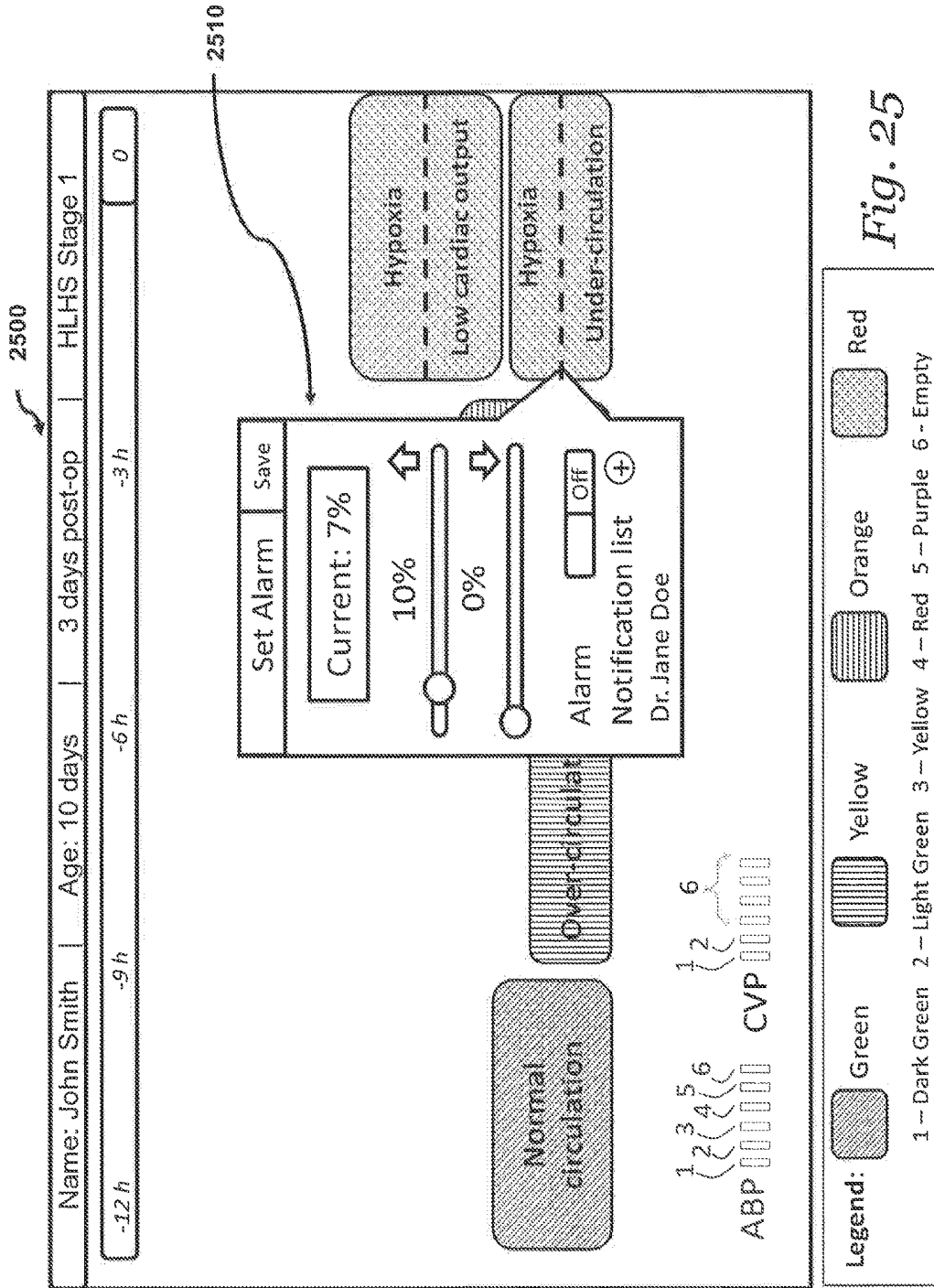

2600

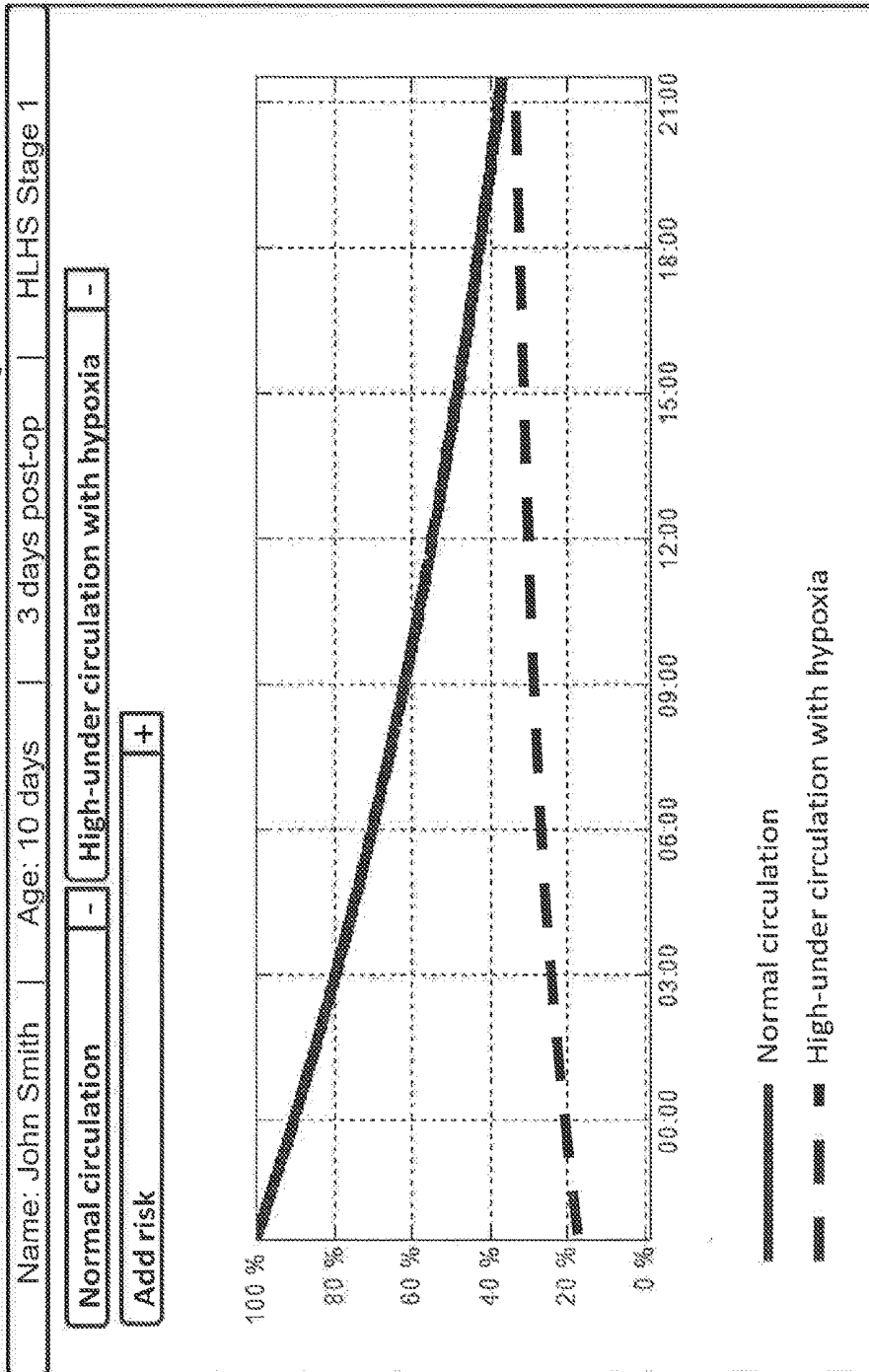

Fig. 26

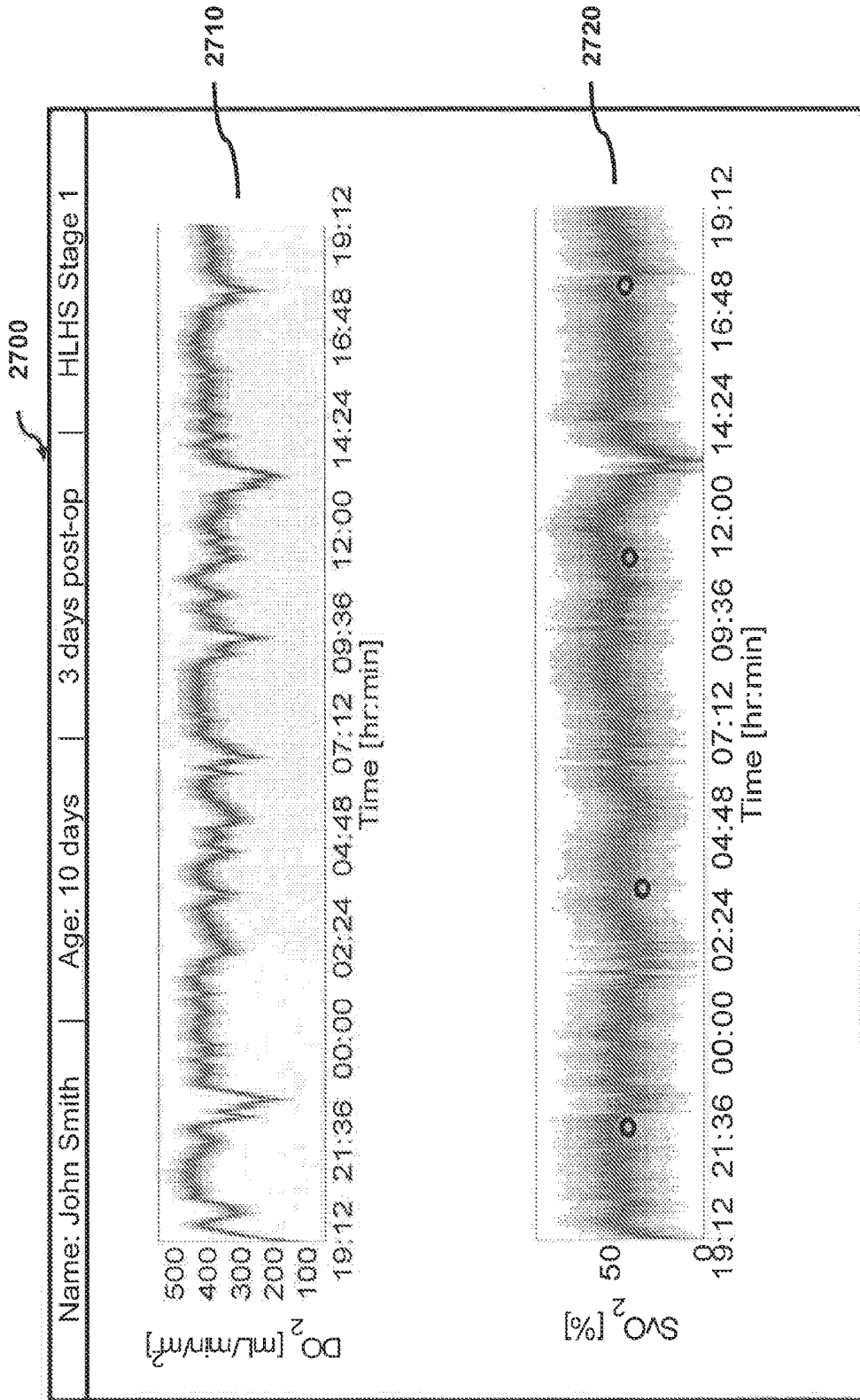
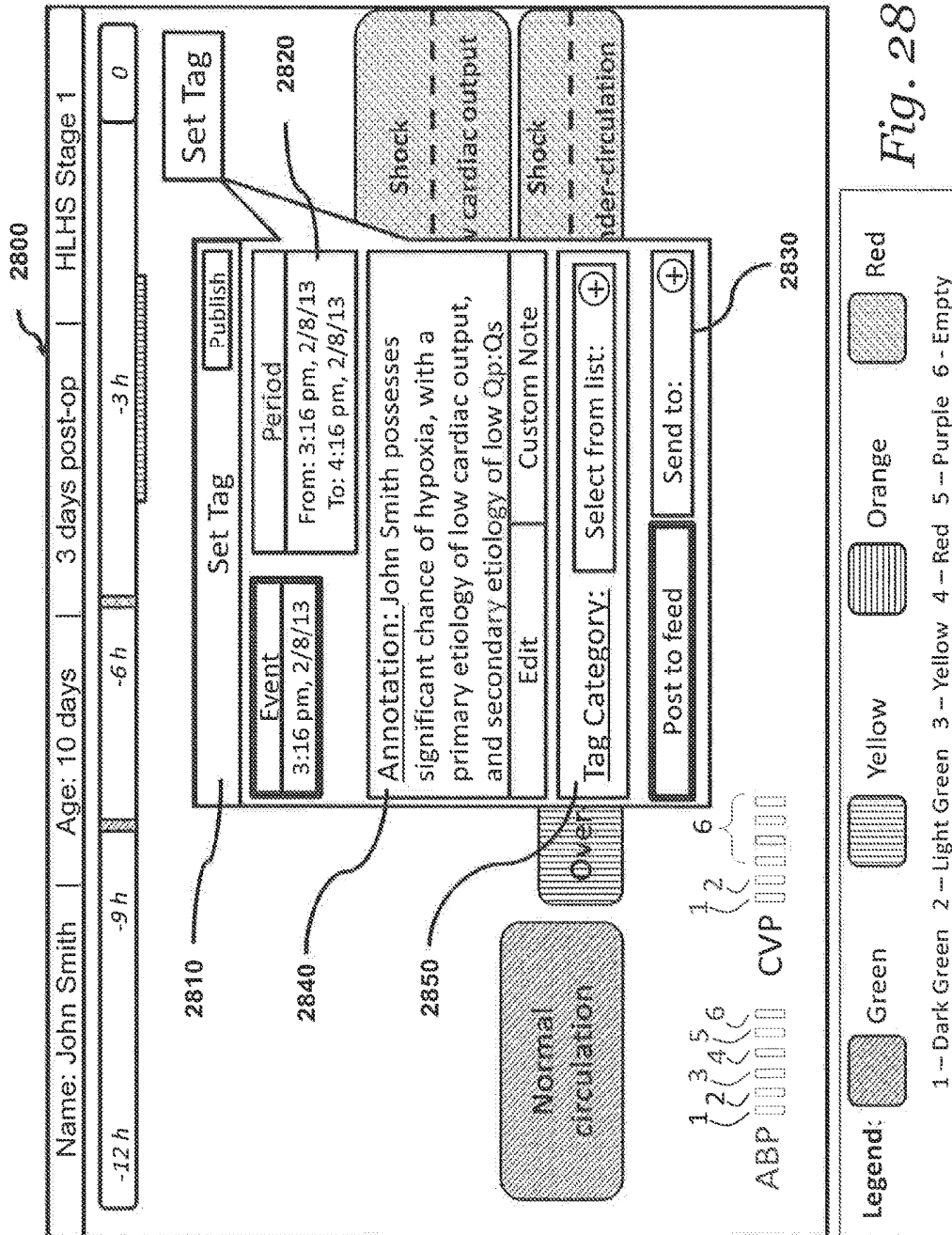
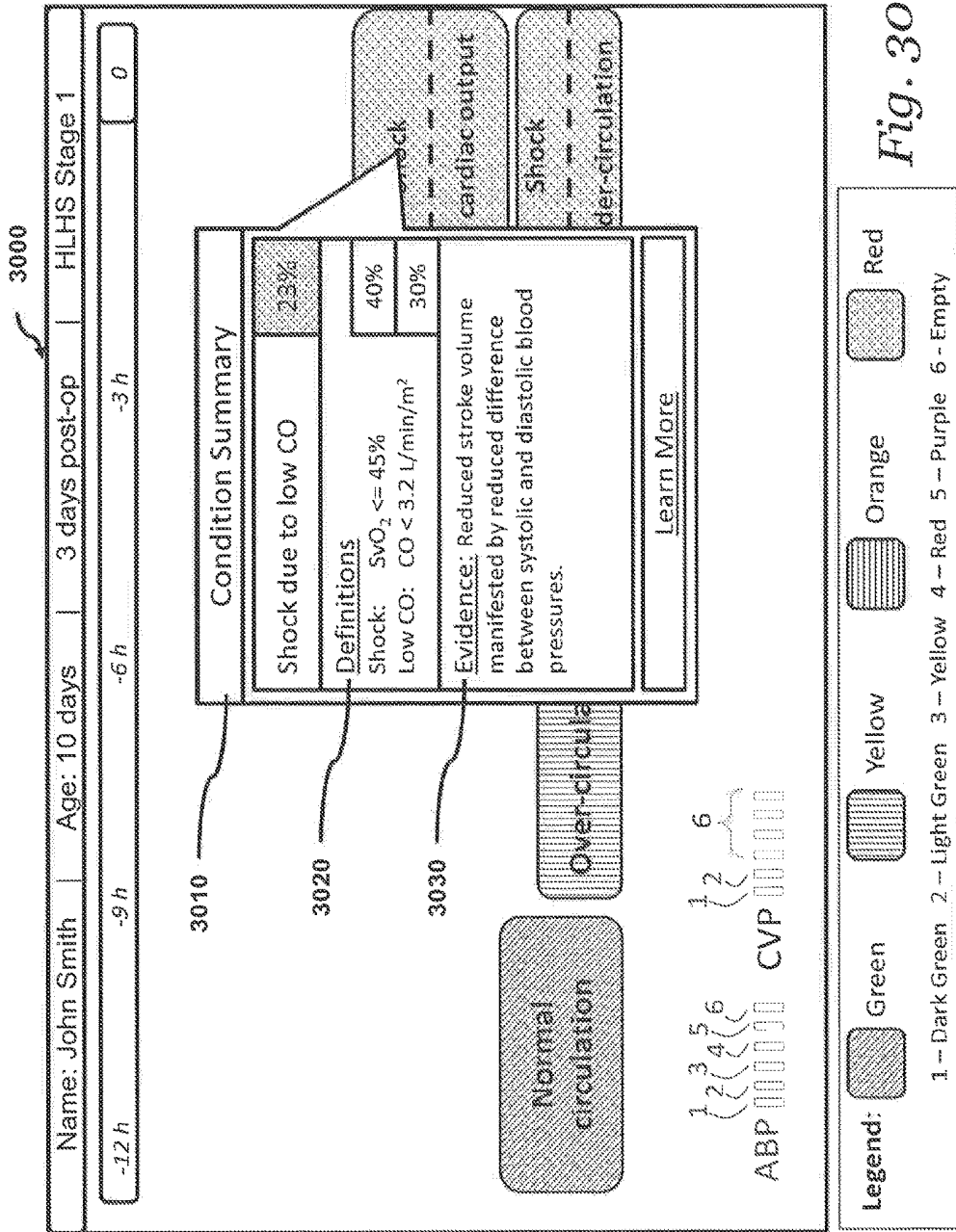
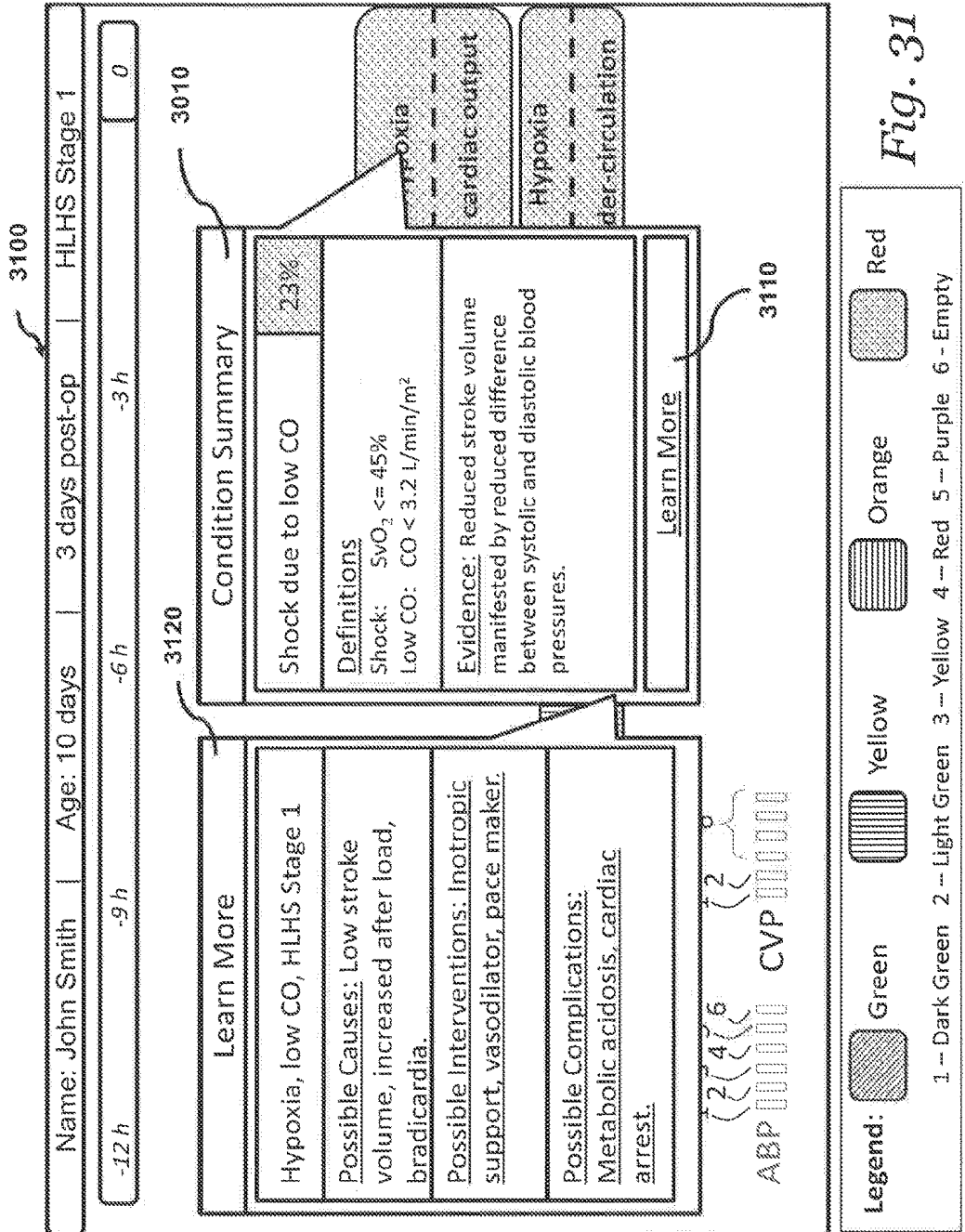

Fig. 27







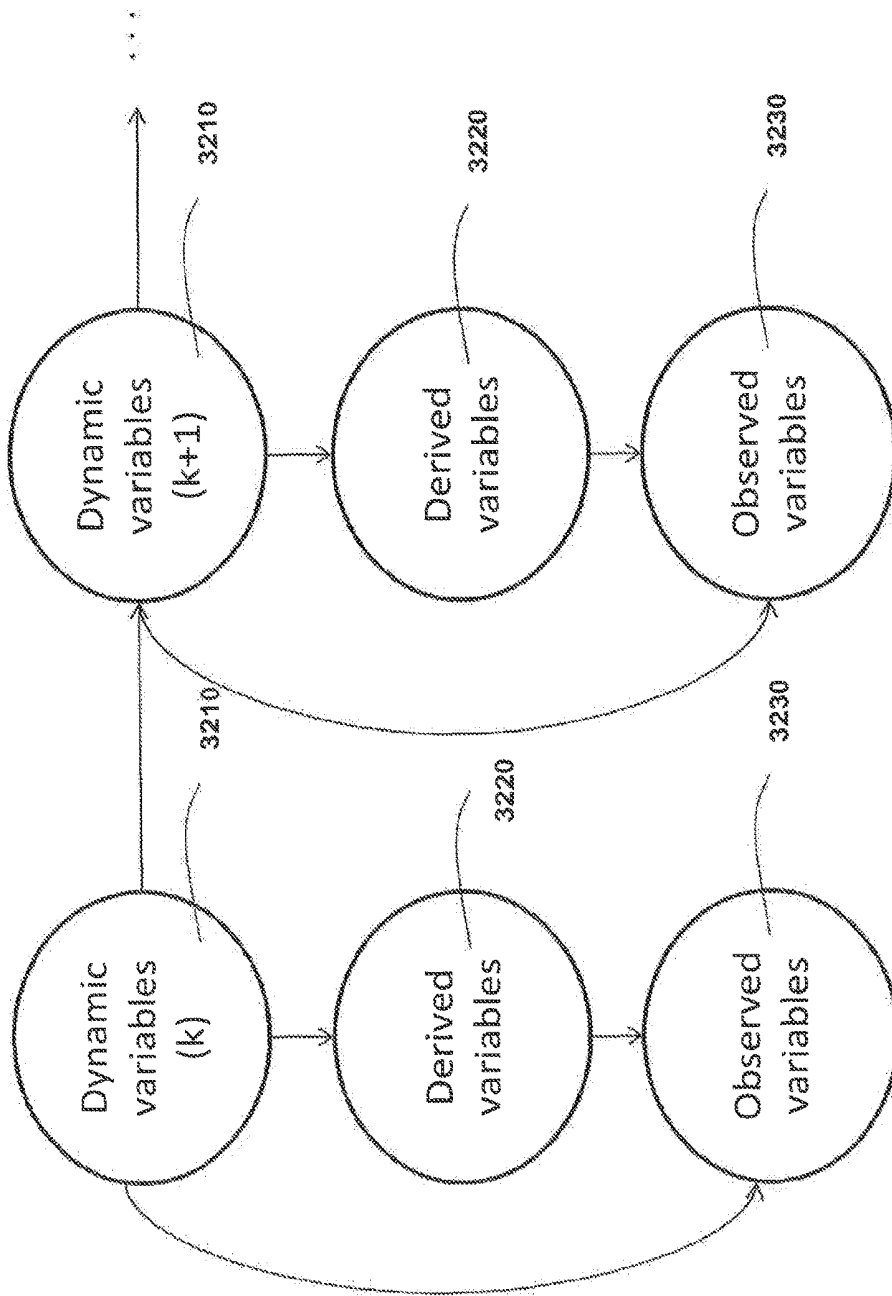

Fig. 32

HLHS Dynamics Model

$$DO_{2k} = DO_{2k-1} + c_{DO_2}(\overline{DO_2} - DO_{2k-1}) + w_{kDO_2} \quad (1)$$

$$VO_{2k} = VO_{2k-1} + c_{VO_2}(\overline{VO_2} - VO_{2k-1}) + w_{kVO_2} \quad (2)$$

$$PVR_k = PVR_{k-1} + \Delta PVR_{k-1} + w_{kPVR} \quad (3)$$

$$SVR_k = SVR_{k-1} + \Delta SVR_{k-1} + w_{kSVR} \quad (4)$$

$$\Delta PVR_k = \Delta PVR_{k-1} + w_{k\Delta PVR} \quad (5)$$

$$\Delta SVR_k = \Delta SVR_{k-1} + w_{k\Delta SVR} \quad (6)$$

$$Hb_k = Hb_{k-1} + c_{Hb}(\overline{Hb} - Hb_{k-1}) + w_{kHb} \quad (7)$$

$$HR_k = HR_{k-1} + w_{kHR} \quad (8)$$

$$SpvO_{2k} = 100 - w_{kSpvO_2} \quad (9)$$

$$\eta_k \sim N(0, \Sigma_\eta) \quad (10)$$

$$CVP_k \sim \text{gamma}(A_{CVP}, B_{CVP}) \quad (11)$$

Fig. 33

HLHS Derived Variables

$$SaO_2 = \frac{DO_{2k}SVR_k SpvO_{2k}}{VO_{2k}PVR_k + DO_{2k}SVR_k} \tag{12}$$

$$SpvO_{2k} = \left(1 - \frac{VO_{2k}}{DO_{2k}}\right) \frac{SVR_k SpvO_{2k}}{VO_{2k}PVR_k + DO_{2k}SVR_k} \tag{13}$$

$$\Delta P_k = \frac{VO_{2k}PVR_k + DO_{2k}SVR_k}{HR_k SVR_k \left(-c_3(VO_{2k}PVR_k + DO_{2k}SVR_k - c_5 SpvO_{2k} Hb_k (c_3 CVP_k + c_4 + \eta_k))\right)} \tag{14}$$

$$ABPm_k = \frac{VO_{2k}PVR_k + DO_{2k}SVR_k}{c_5 SpvO_{2k} Hb_k} + CVP_k \tag{15}$$

$$CO_k = \frac{VO_{2k}PVR_k + DO_{2k}SVR_k}{c_5 SpvO_{2k} Hb_k} \left(\frac{1}{SVR_k} + \frac{1}{PVR_k}\right) \tag{16}$$

$$Q_p:Q_s_k = \frac{SVR_k}{PVR_k} \tag{17}$$

$$\Delta Q_p:Q_s_k = \frac{SVR_k}{PVR_k} \left(\frac{\Delta SVR_k}{\Delta t} - \frac{\Delta PVR_k}{\Delta t}\right) \tag{18}$$

Fig. 34

HLHS Observation Model

$$\overline{SaO_{2k}} = SaO_2 + n_{k_{SaO_2}}$$

$$n_{k_{SaO_2}} \sim N(0, R_{SaO_2}) \quad (19)$$

$$\overline{SvO_{2k}} = SvO_2 + n_{k_{SvO_2}}$$

$$n_{k_{SvO_2}} \sim N(0, R_{SvO_2}) \quad (20)$$

$$\overline{\Delta P_k} = \Delta P_k + n_{k_{\Delta P}}$$

$$n_{k_{\Delta P}} \sim N(0, R_{\Delta P}) \quad (21)$$

$$\overline{ABP}m_k = ABPm_k + n_{k_{ABPm}}$$

$$n_{k_{ABPm}} \sim N(0, R_{ABPm}) \quad (22)$$

$$\overline{HR}_k = HR_k + n_{k_{HR}}$$

$$n_{k_{HR}} \sim N(0, R_{HR}) \quad (23)$$

$$\overline{CVP}_k = CVP_k + n_{k_{CVP}}$$

$$n_{k_{CVP}} \sim N(0, R_{CVP}) \quad (24)$$

$$\overline{Hb}_k = Hb_k + n_{k_{Hb}}$$

$$n_{k_{Hb}} \sim N(0, R_{Hb}) \quad (25)$$

Fig. 35

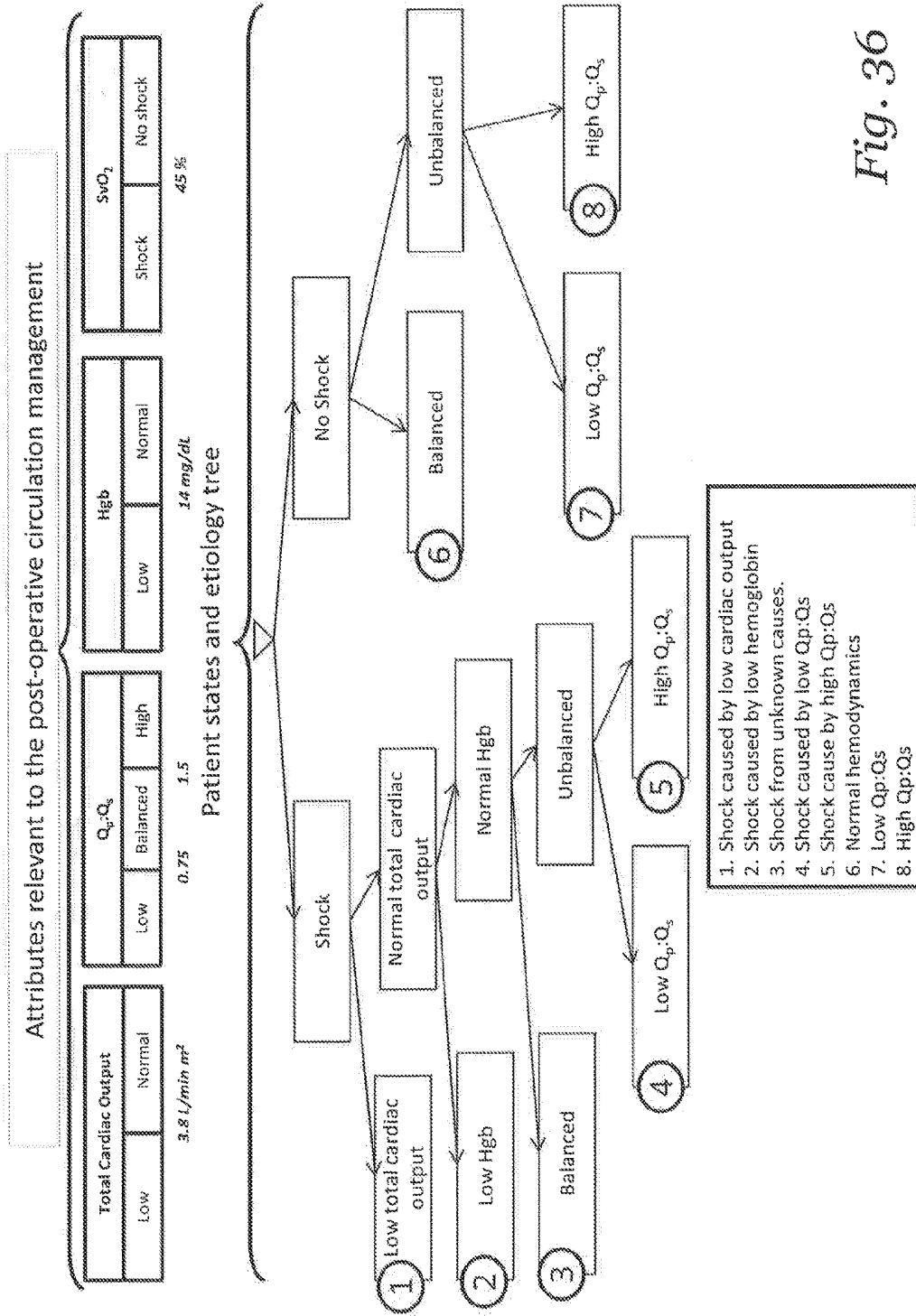

Fig. 36

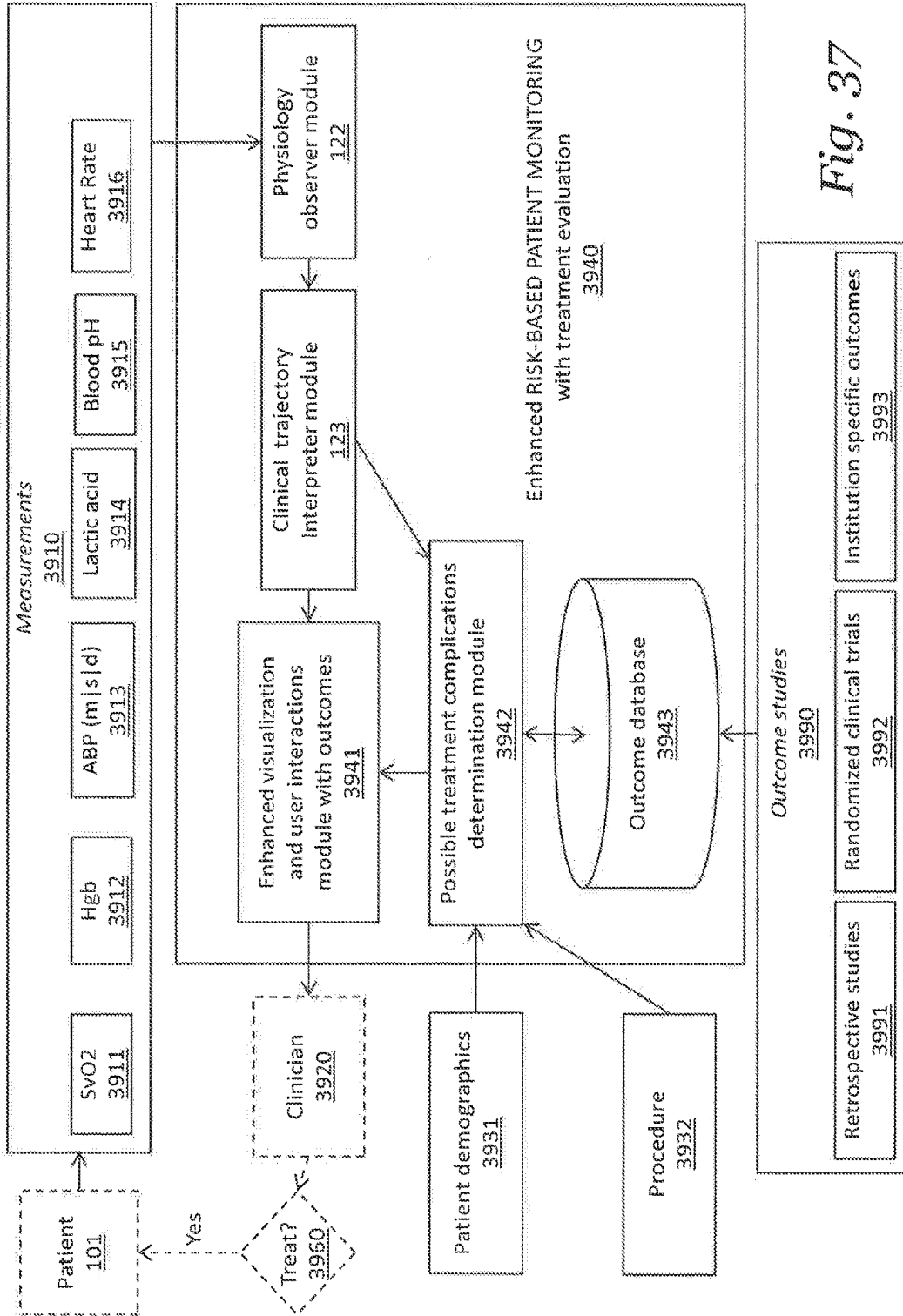

Fig. 37

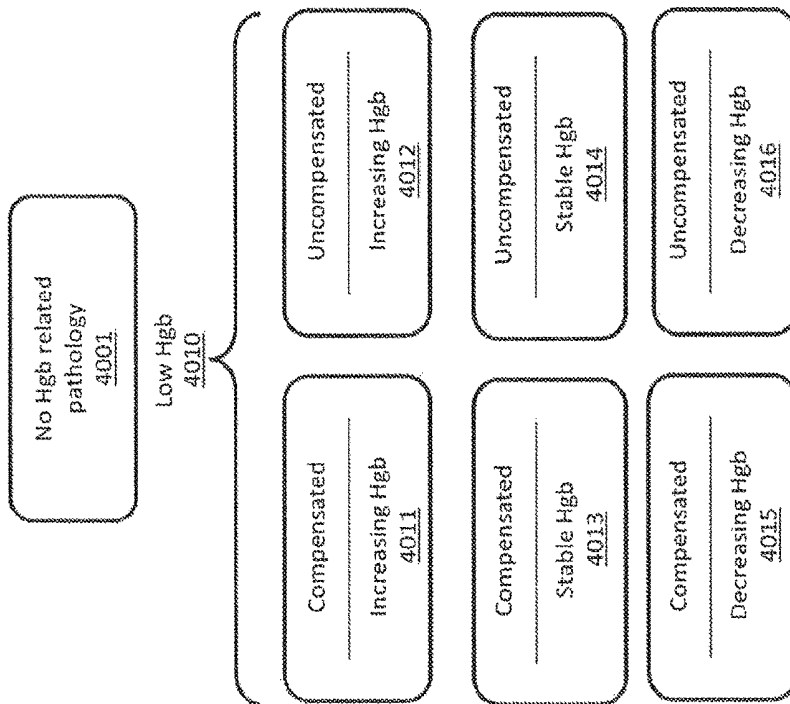

Fig. 38

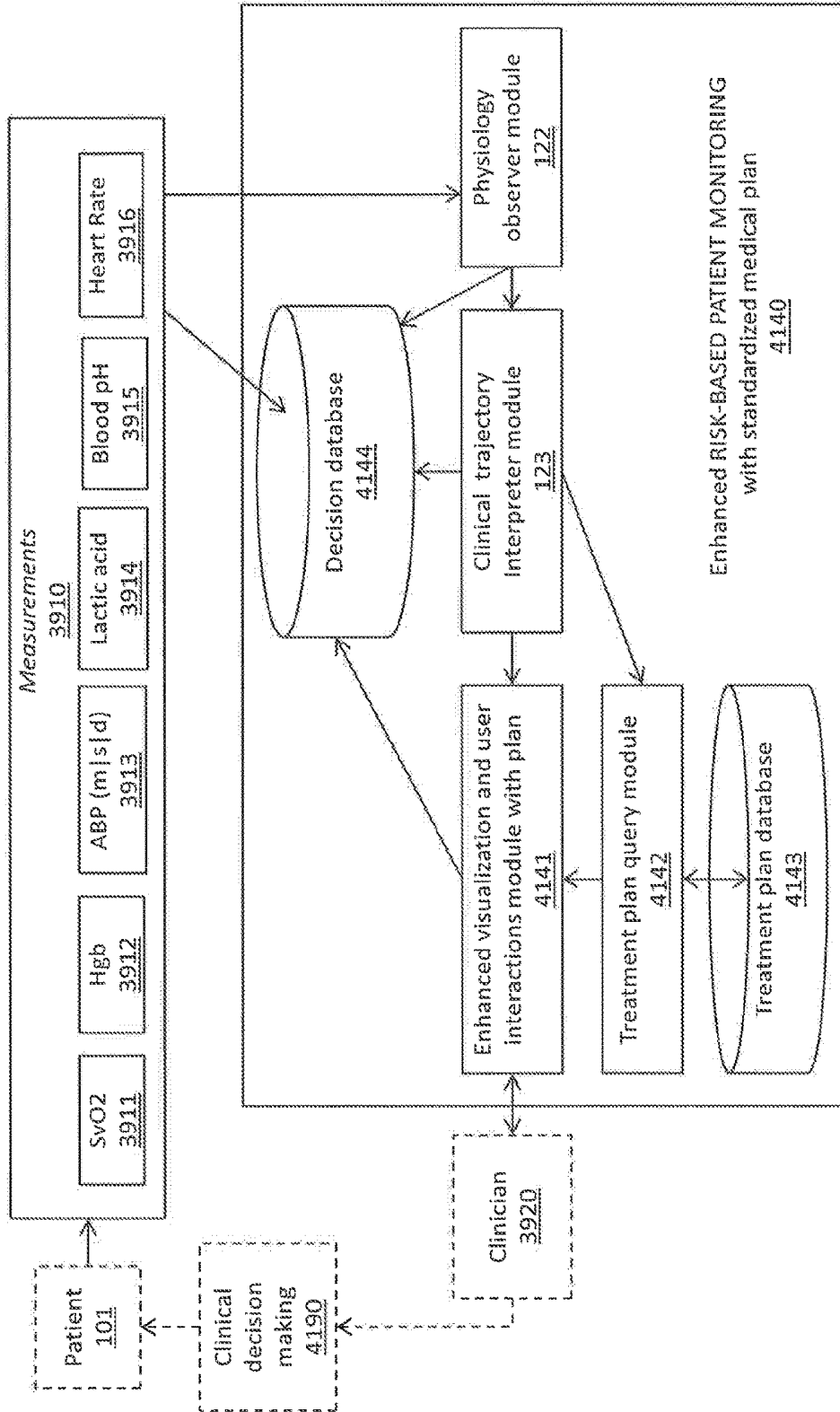

Fig. 39

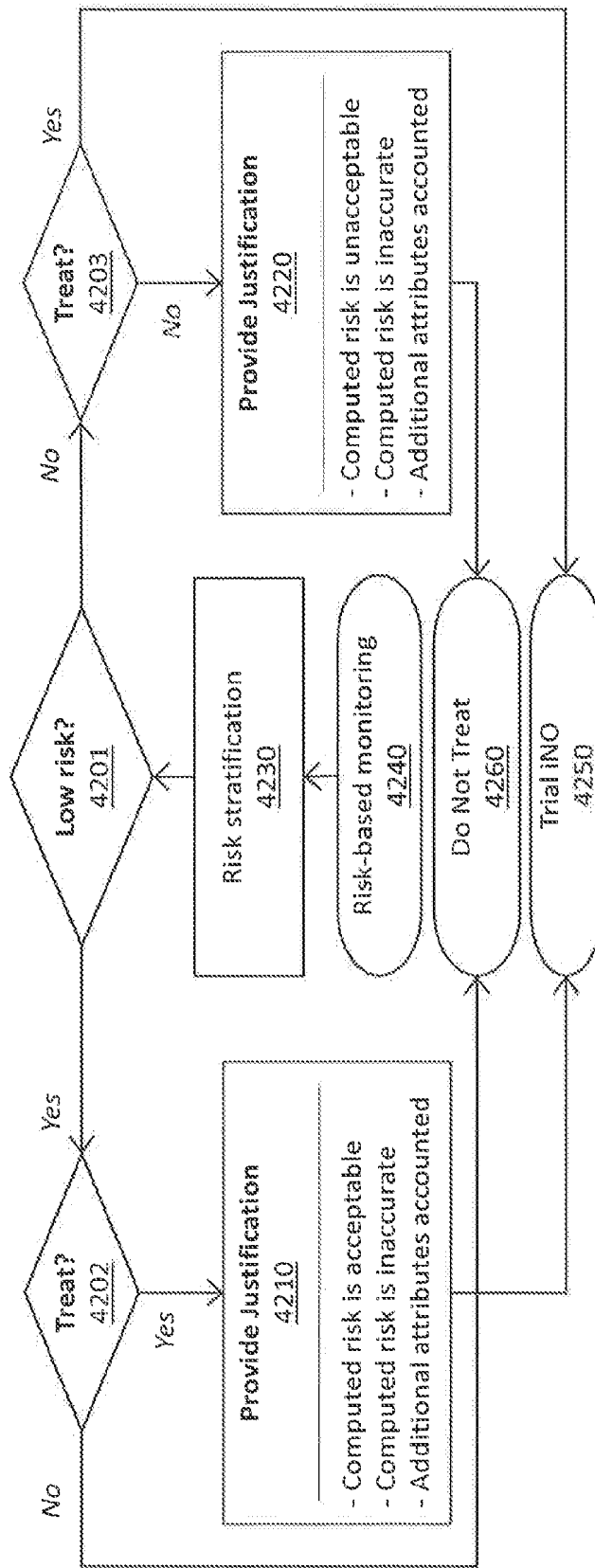

Fig. 40

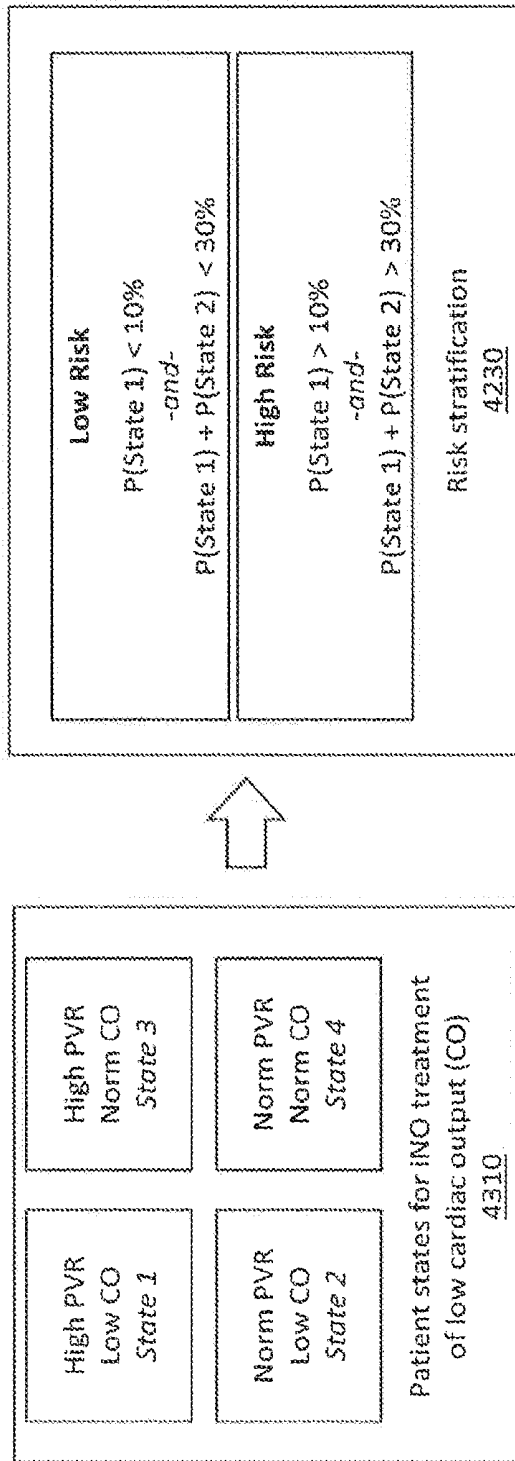

Fig. 41

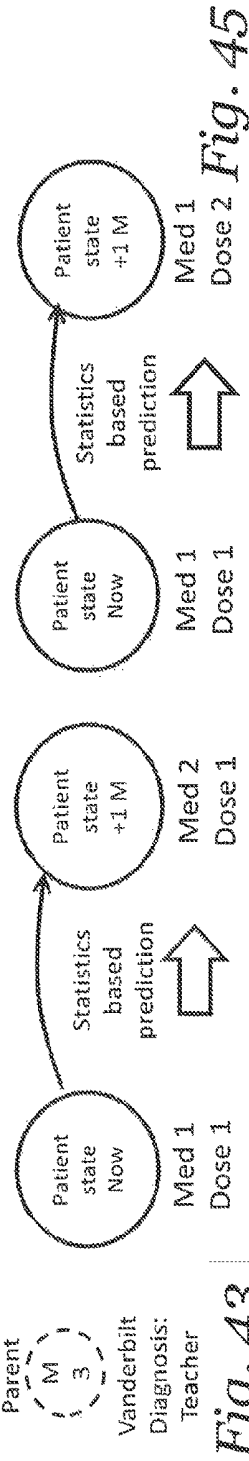
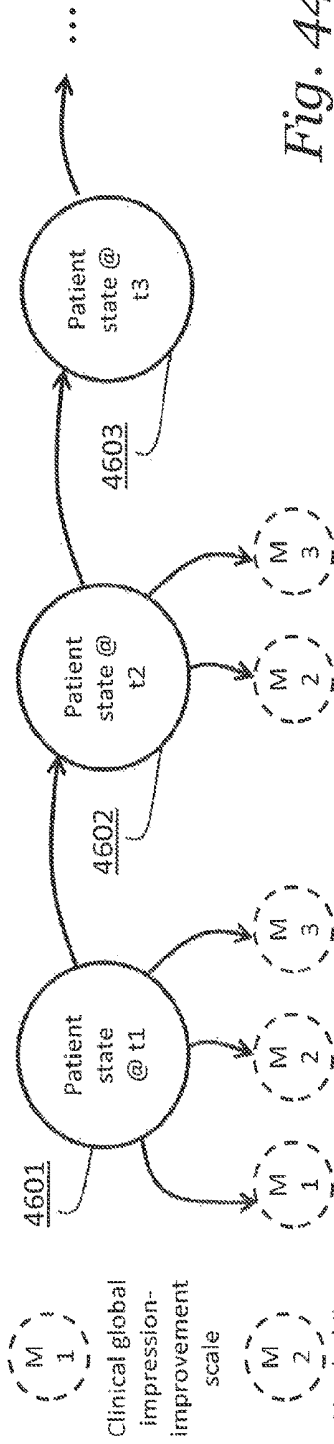
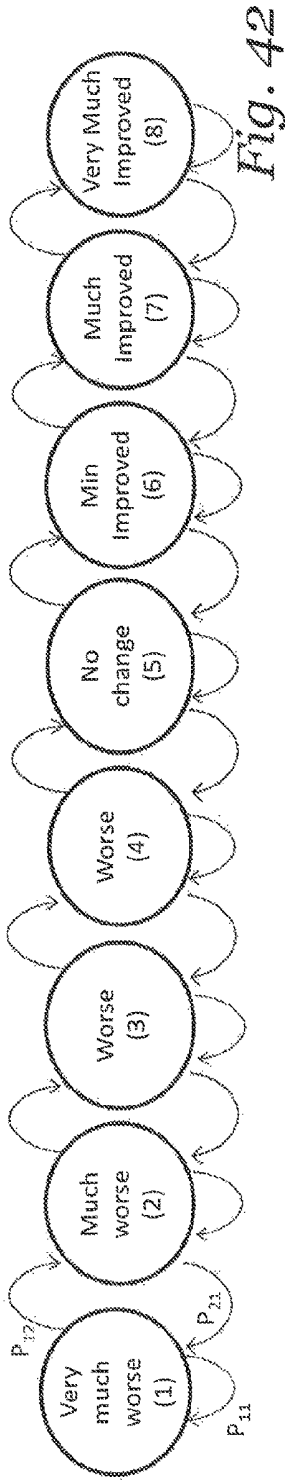

Fig. 43

Fig. 45

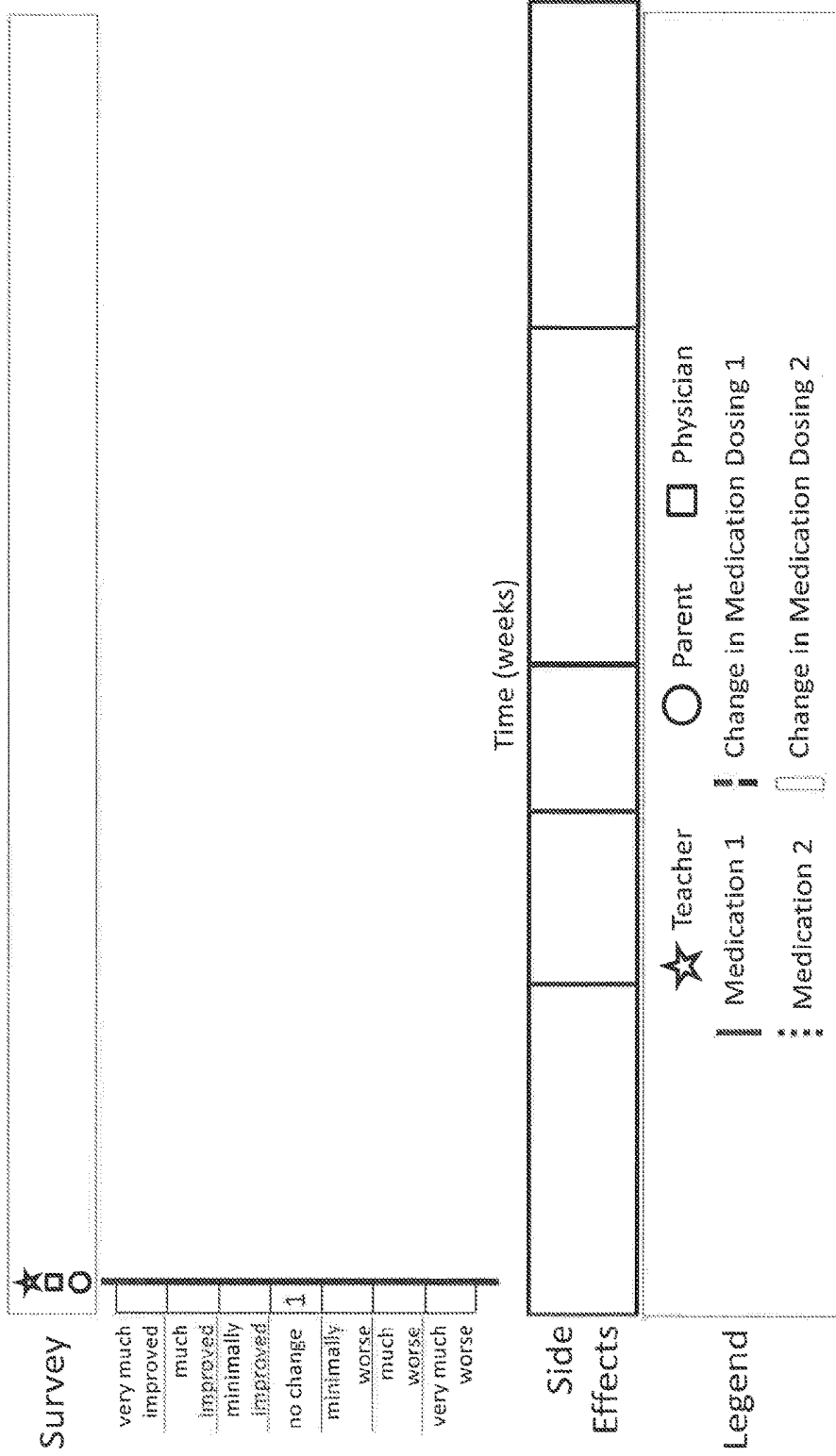

Fig. 46

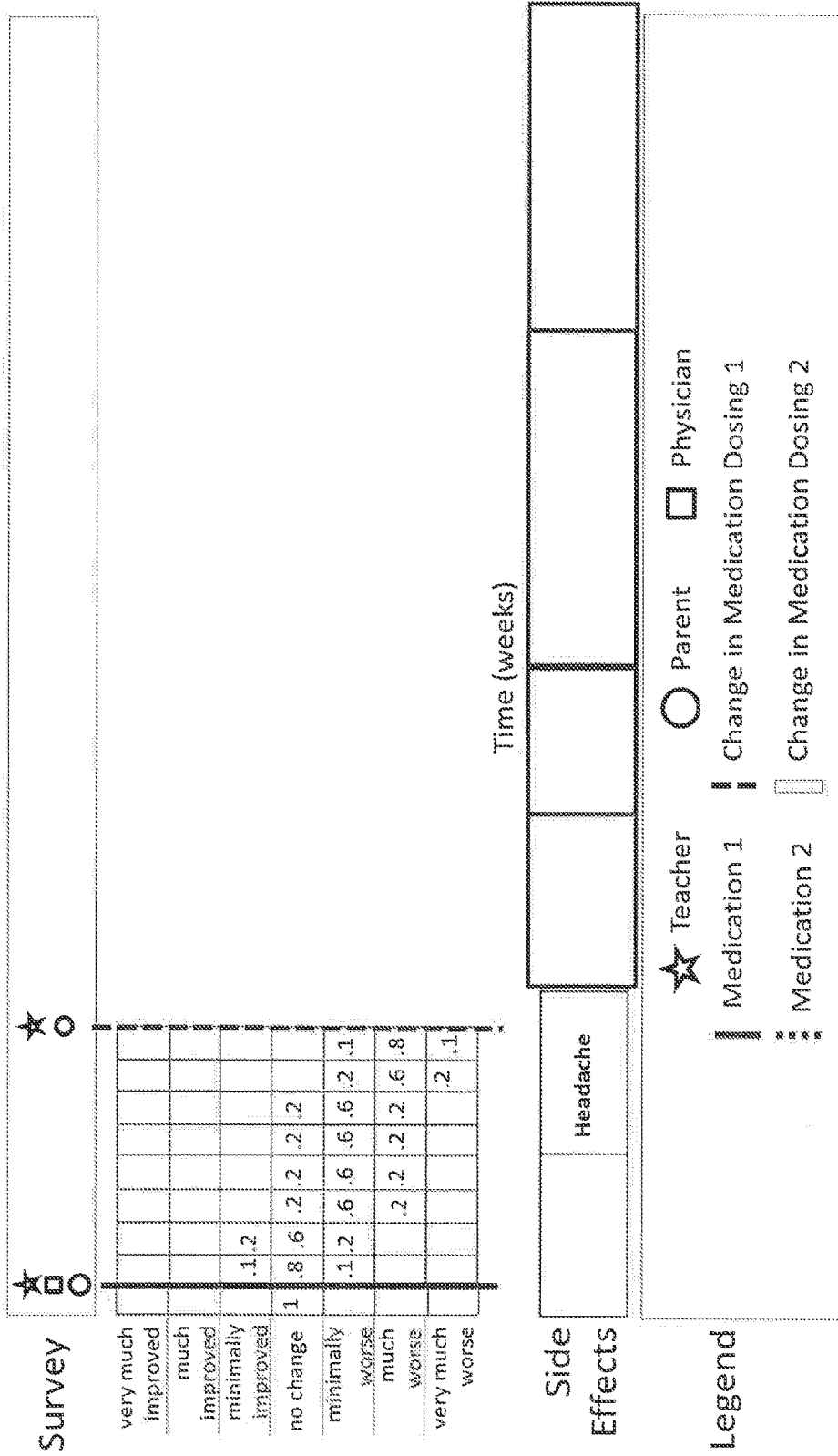

Fig. 47

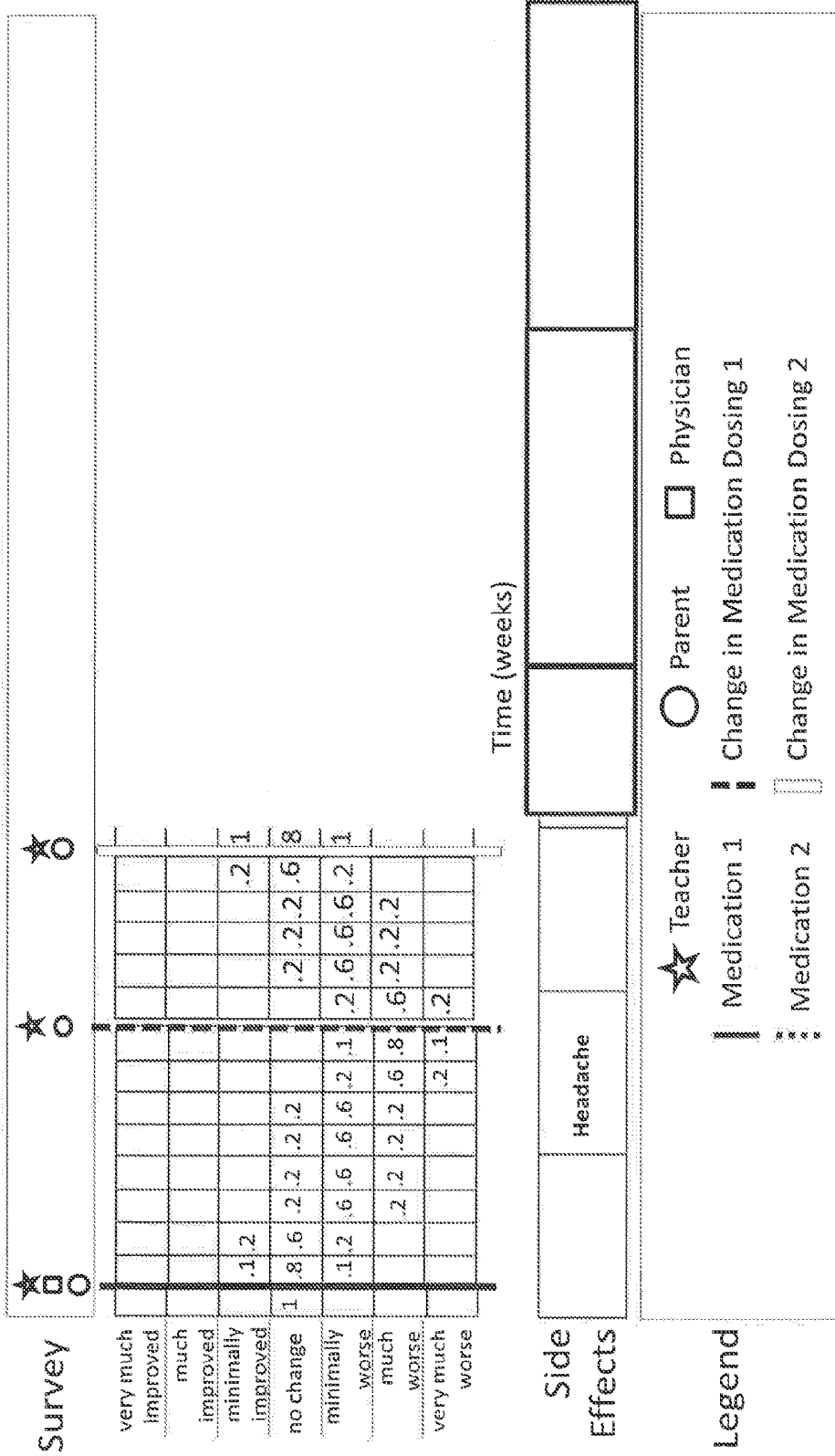

Fig. 48

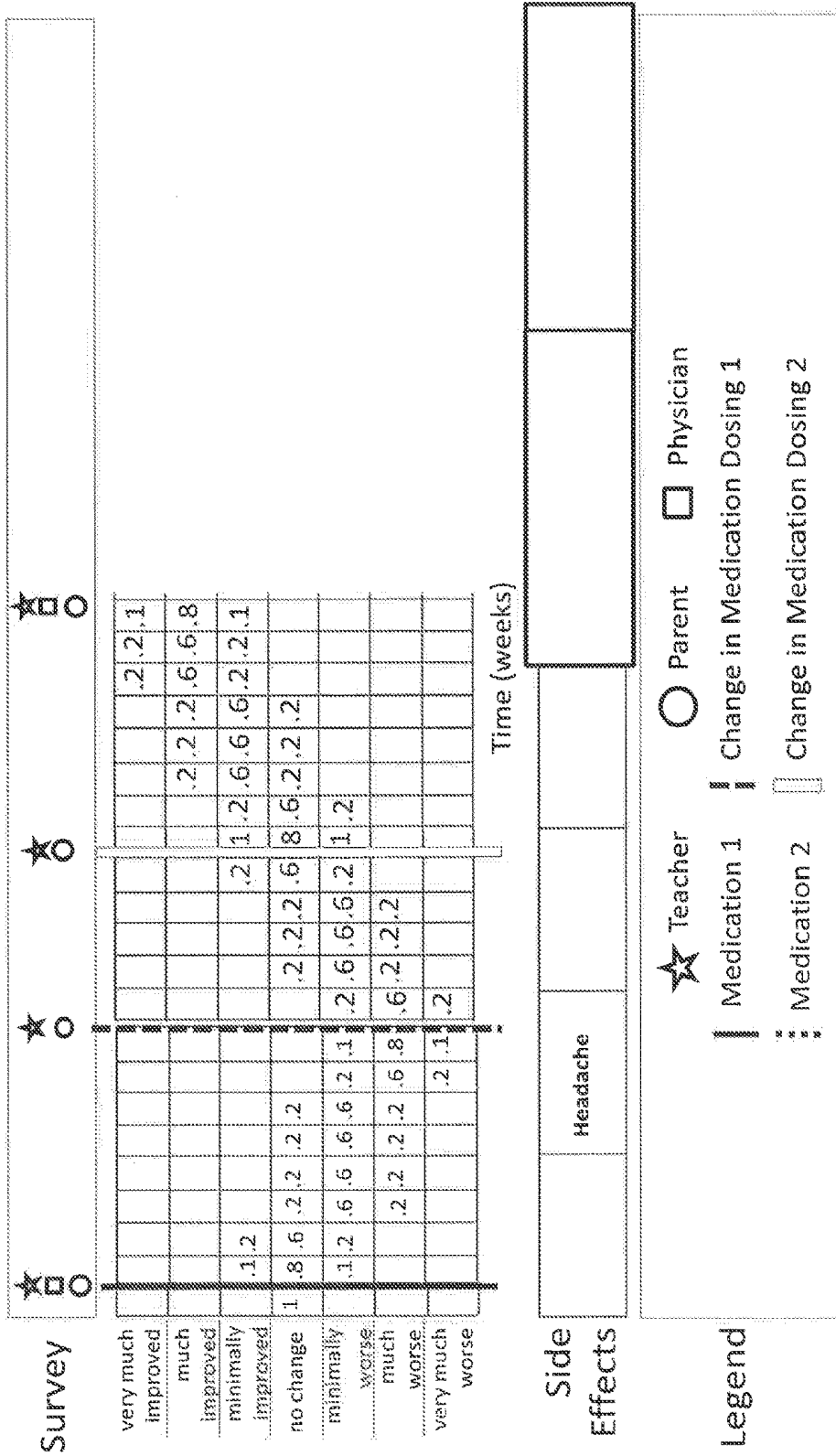

Fig. 49

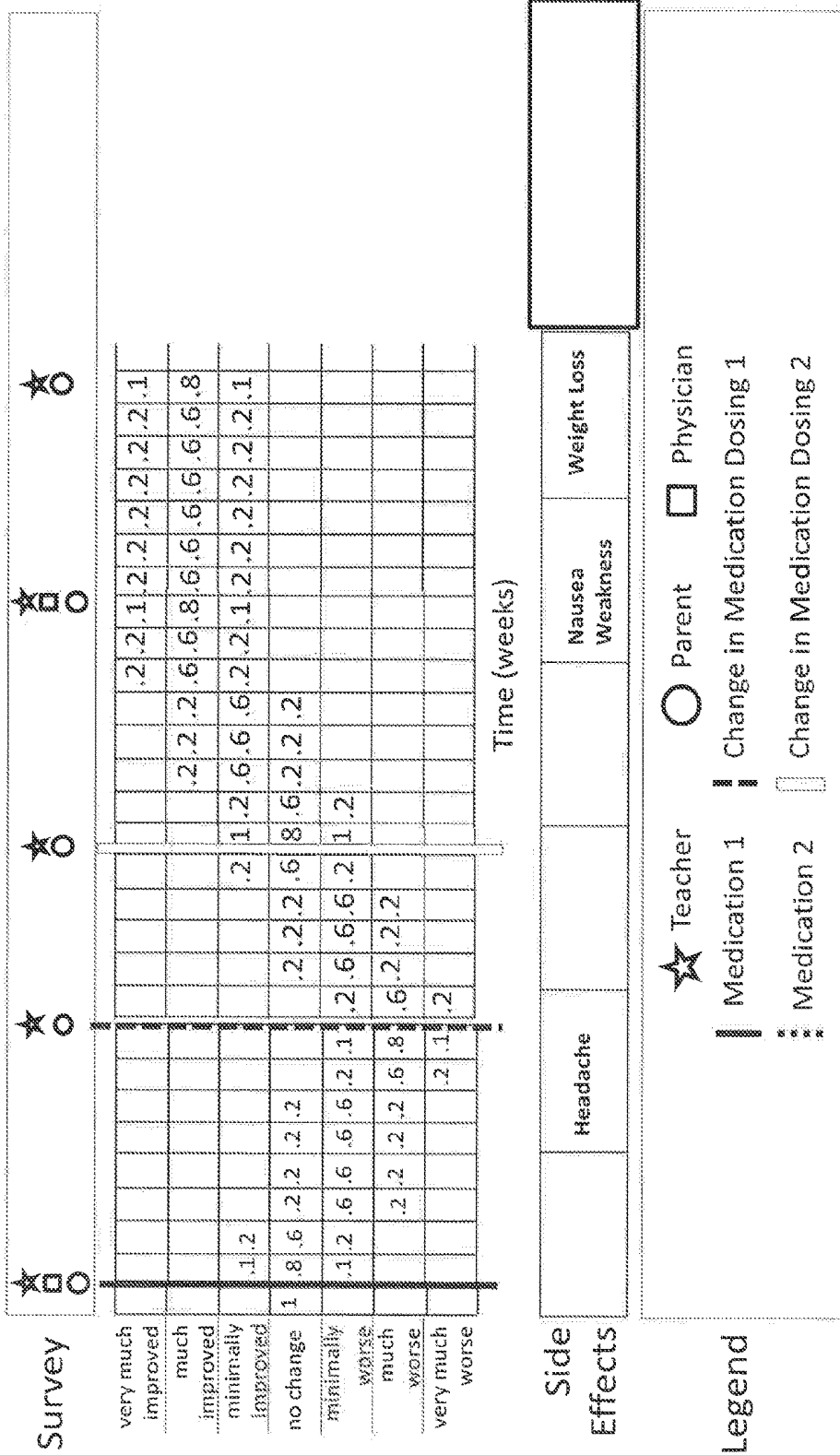

Fig. 50

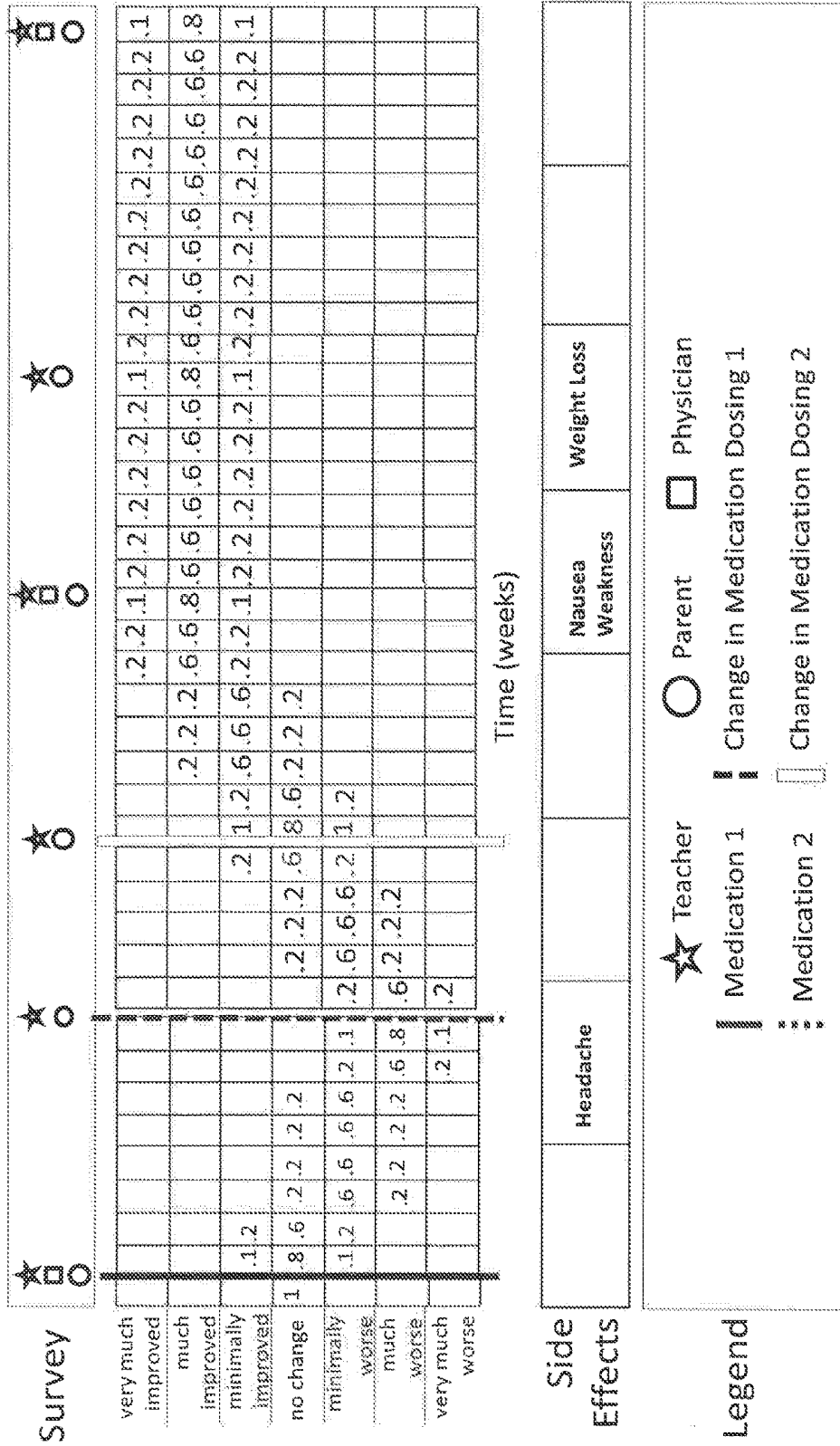

Fig. 52

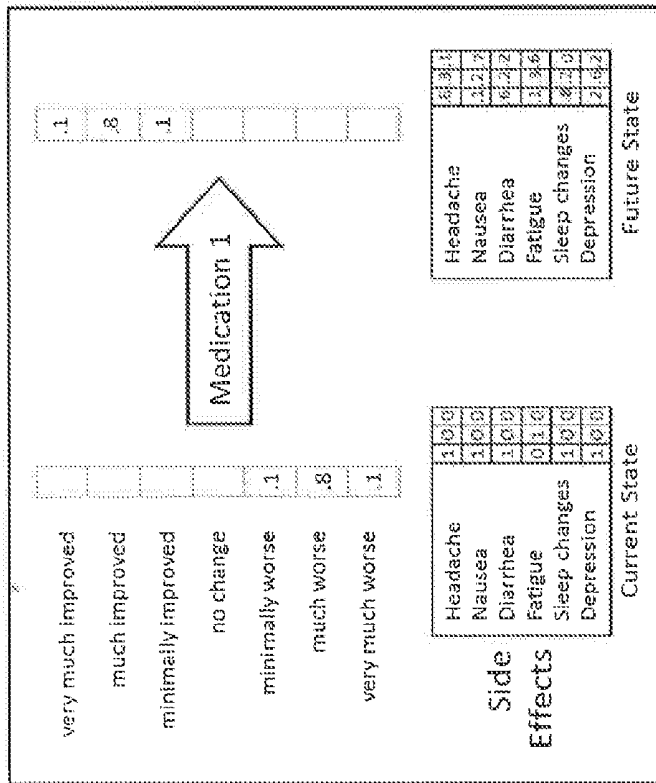
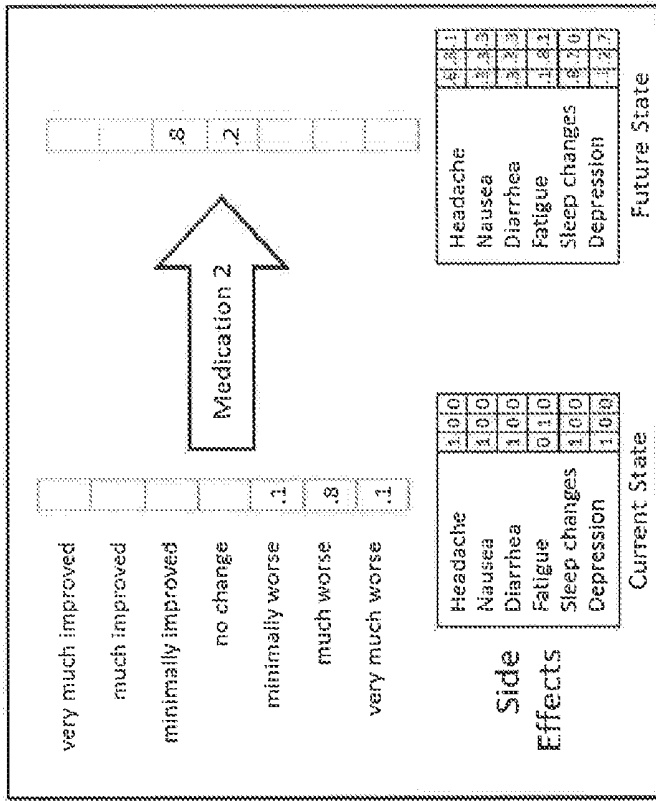

Fig. 53

**SYSTEMS AND METHODS FOR
TRANSITIONING PATIENT CARE FROM
SIGNAL BASED MONITORING TO RISK
BASED MONITORING**

PRIORITY CLAIM

This application is a continuation of U.S. non-provisional patent application Ser. No. 13/826,441, filed Mar. 14, 2013 and entitled "Systems and Methods for Transitioning Patient Care from Signal-Based Monitoring to Risk-Based Monitoring, which is a Continuation-In-Part of the following non-provisional patent applications:

U.S. patent application Ser. No. 13/689,029, filed on Nov. 29, 2012, entitled SYSTEMS AND METHODS FOR OPTIMIZING MEDICAL CARE THROUGH DATA MONITORING AND FEEDBACK TREATMENT, and

U.S. application Ser. No. 13/328,411, filed on Dec. 16, 2011, entitled METHOD AND APPARATUS FOR VISUALIZING THE RESPONSE OF A COMPLEX SYSTEM TO CHANGES IN A PLURALITY OF INPUTS,

and also claims priority to the following provisional patent applications:

U.S. Provisional Application No. 61/727,820, filed on Nov. 19, 2012, entitled USER INTERFACE DESIGN FOR RAHM,

U.S. Provisional Application No. 61/699,492, filed on Sep. 11, 2012, entitled SYSTEMS AND METHODS FOR EVALUATING CLINICAL TRAJECTORIES AND TREATMENT STRATEGIES FOR OUTPATIENT CARE,

U.S. Provisional Application No. 61/684,241, filed on Aug. 17, 2012, entitled SYSTEM AND METHODS FOR PROVIDING RISK ASSESSMENT IN ASSISTING CLINICIANS WITH EFFICIENT AND EFFECTIVE BLOOD MANAGEMENT,

U.S. Provisional Application No. 61/620,144, filed on Apr. 4, 2012, entitled SYSTEMS AND METHODS FOR PROVIDING MOBILE ADVANCED CARDIAC SUPPORT,

U.S. Provisional Application No. 61/614,861, filed on Mar. 23, 2012 entitled SYSTEMS AND METHODS FOR REDUCING MORBIDITY AND MORTALITY WHILE REDUCING LENGTH OF STAY IN A HOSPITAL SETTING,

U.S. Provisional Application No. 61/614,846, filed Mar. 23, 2012, entitled SYSTEMS AND METHODS FOR PROVIDING MOBILE ADVANCED CARDIAC SUPPORT, and

U.S. Provisional Application No. 61/774,274, filed on Mar. 7, 2013, entitled SYSTEMS AND METHODS FOR TRANSITIONING PATIENT CARE FROM SIGNAL-BASED MONITORING TO RISK-BASED MONITORING,

the entire subject matter of each of the foregoing applications being incorporated herein by this reference for all purposes.

STATEMENT REGARDING FEDERALLY
SPONSORED RESEARCH OR DEVELOPMENT

This invention was made with government support under R43HL117340 awarded by the National Heart, Lung, And Blood Institute of the National Institutes of Health. The government has certain rights in the invention.

BACKGROUND ART

The present disclosure relates to systems and methods for risk-based patient monitoring. More particularly, the present

disclosure relates to systems and methods for assessing the current and future risks of a patient by combining data of the patient from various different sources.

Practicing medicine is becoming increasingly more complicated due to the introduction of new sensors and treatments. As a result, clinicians are confronted with an avalanche of patient data, which needs to be evaluated and well understood in order to prescribe the optimal treatment from the multitude of available options, while reducing patient risks. One environment where this avalanche of information has become increasingly problematic is the Intensive Care Unit (ICU). There, the experience of the attending physician and the physician's ability to assimilate the available physiologic information have a strong impact on the clinical outcome. It has been determined that hospitals which do not maintain trained intensivists around the clock experience a 14.4% mortality rate as opposed to a 6.0% rate for fully staffed centers. It is estimated that raising the level of care to that of average trained physicians across all ICUs can save 160,000 lives and \$4.3 Bn annually. As of 2012, there is a shortage of intensivists, and projections estimate the shortage will only worsen, reaching a level of 35% by 2020.

The value of experience in critical care can be explained by the fact that clinical data in the ICU is delivered at a rate far greater than even the most talented physician can absorb, and studies have shown that errors are six times more likely under conditions of information overload and eleven times more likely with an acute time shortage. Moreover, treatment decisions in the ICU heavily rely on clinical signs that are not directly measurable, but are inferred from other physiologic information. Thus clinician expertise and background play a more significant role in the minute to minute decision making process. Not surprisingly, this leads to a large variance in hidden parameter estimation. As an example, although numerous proxies for cardiac output are continuously monitored in critical care, studies have demonstrated poor correlation between subjective assessment by clinicians, and objective measurement by thermodilution. Experienced intensivists incorporate this inherent uncertainty in their decision process by effectively conducting risk management, i.e. prescribing the treatment not only based on the most probable patient state, but also weighing in the risks of the patient being in other more adverse states. From this perspective, experienced intensivists confront the data overload in intensive care by converting the numerous heterogeneous signals from patient observations into a risk assessment.

Therefore, there is a clear need for a decision support system in the ICU that achieves a paradigm shift from signal-based patient monitoring to risk based patient monitoring, and consequently helps physicians overcome the barrage of data in the ICU.

BRIEF SUMMARY

Disclosed herein is a risk-based patient monitoring system for critical care patients that combines data from any of bedside monitors, electronic medical records, and other patient specific information, to assess the current and the future risks to the patient. The system may be also embodied as a decision support system that prompts the user with specific actions according to a standardized medical plan, when patient specific risks pass a predefined threshold. Yet another embodiment of the described technologies is an outpatient monitoring system which combines patient and family evaluation, together with information about medication regimens and physician evaluations to produce a risk

profile of the patient, continuously track its clinical trajectory, and provide decision support to clinicians regarding when to schedule a visit or additional tests.

According to one implementation, a risk based monitoring application executing on a system processor comprises a data reception module, a physiology observer module, a clinical trajectory interpreter module, and a visualization and user interaction module. In an exemplary embodiment, the data reception module may be configured to receive data from bedside monitors, electronic medical records, treatment device, and any other information that may be deemed relevant to make informed assessment regarding the patient's clinical risks, and any combination thereof of the preceding elements.

The physiology observer module utilizes multiple measurements to estimate Probability Density Functions (PDF) of Internal State Variables (ISVs) that describe the components of the physiology relevant to the patient treatment and condition. The clinical trajectory interpreter module may be configured with multiple possible patient states, and determine which of those patient states are probable and with what probability, given the estimated probability density functions of the internal state variables.

In various embodiments, the clinical trajectory interpreter module determines the patient conditions under which a patient may be categorized and is capable of also determining the probable patient states under which the patient can be currently categorized, given the estimated probability density functions of the internal state variables. In this way, each of the possible patient states is assigned a probability value from 0 to 1. The combination of patient states and their probabilities is defined as the clinical risk to the patient.

The visualization and user interactions module takes i) time series of physiologic measurements acquired continuously or intermittently and patient specific identifiers such as condition, demographics, visual examinations from the data reception module; ii) time series of probability density functions of internal state variables estimated from the physiology observer module; and time series of the probabilities that the patient is at particular state and the hazard level of the respective risks from the clinical trajectory interpreter module. Then it visualizes this data on graphs which represent the dependence of the variables with time, by either directly plotting them on a screen, or in the case of probability density functions plotting them by encoding the likelihood at particular point of time and at particular value with a color scheme. The visualization and user interactions module may also visualize the current risks to the patient by representing them with boxes of different size and color, the size of the box corresponding to the probability of a patient state at particular point in time and the color of the box corresponding to its hazard level. Additionally, the visualization and user interactions module can allow the users to set alarms based on the patient state probabilities, share those alarms with other users, take notes related to the patient risks and share those notes with other users, and browse other elements of the patient medical history.

According to one aspect of the disclosure, a computer-implemented medium and method for risk based monitoring of patients comprises: A) acquiring, with a computer, data associated with a plurality of the internal state variables each describing a parameter physiologically relevant to one of a treatment and a condition of a patient; B) storing, in a computer accessible memory, the acquired data associated with the plurality of the internal state variables; C) generating, with a computer, estimated probability density functions for the plurality of the internal state variables; and D)

identifying, with a computer, from the generated probability density functions of the internal state variables, into which of a plurality of possible patient states the patient is currently categorizable and generating a probability value associated with each identified possible patient state. In one embodiment, the probability value associated with the identified possible patient states is between 0 and 1. In another embodiment, the method further comprises: E) presenting on a screen the probability values and their associated respective identified possible patient states, wherein the combination of identified possible patient states and their associated respective probability values is defined as the clinical risk to the patient.

According to another aspect of the disclosure, a risk based monitoring system for monitoring patients comprises: a processor; a memory coupled to the processor; a data reception module, operably coupled to a plurality of sources of information relative to a patient, for acquiring data associated with a plurality of the internal state variables each describing a parameter physiologically relevant to one of a treatment and a condition of a patient; a physiology observer module, in communication with the data reception module, and configured to generate probability density functions of the internal state variables; a clinical trajectory interpreter module, in communication with the physiology observer module, and configured to identify into which of a plurality of possible patient states the patient is currently categorizable and to generate a probability value associated with each identified possible patient state. In one embodiment, the method further comprises: a user interaction module, in communication with the clinical trajectory interpreter and the data reception module and memory, for presenting the probability values and their associated respective identified possible patient states, wherein the combination of identified possible patient states and the associated respective probability values is defined as the clinical risk to the patient.

According to still other aspects of the disclosure, certain measurements, such as Hemoglobin, are available to the system with an unknown amount of time latency, meaning the measurements are valid in the past relative to the current time and the time they arrive over the data communication links. The physiology observer module may handle such out of sequence measurements using back propagation, in which the current estimates of the ISVs are projected back in time to the time of validity of the measurements, so that the information from the latent measurement can be incorporated correctly. Accordingly, in accordance with another aspect of the disclosure, a computer-implemented method for risk based monitoring of patients, comprises: A) acquiring, with a computer, data associated with a plurality of the internal state variables each describing a parameter physiologically relevant to one of a treatment and a condition of a patient, not all of the data associated with the plurality of the internal state variables with at the same periodicity; B) storing, in a computer accessible memory, the acquired data associated with the plurality of the internal state variables; C) generating, with a computer, estimated probability density functions for the plurality of the internal state variables; and D) identifying, with a computer, from the generated probability density functions of the internal state variables, into which of a first plurality of possible patient states $P(S_1)$, $P(S_2)$, $P(S_3)$, . . . , $P(S_n)$, the patient could have previously been categorizable and generating a probability value associated with each identified possible prior patient state. In one embodiment, generating estimated probability density functions comprises: C1) generating estimated probability density functions for the first plurality of the internal state

variables at a current time step t_k ; and C2) generating probability density functions for the plurality of the internal state variables at a another time step t_{k-N} , where N is an integer value greater than 1, by evolving backwards from the probability estimates at time step t_k to the time step t_{k-N} using a defined transition probability kernel.

BRIEF DESCRIPTION OF THE DRAWINGS

It should be understood at the outset that although illustrative implementations of one or more embodiments of the present disclosure are provided below, the disclosed systems and/or methods may be implemented using any number of techniques, whether currently known or in existence. The disclosure should in no way be limited to the illustrative implementations, drawings, and techniques illustrated below, including the exemplary designs and implementations illustrated and described herein, but may be modified within the scope of the appended claims along with their full scope of equivalents.

In the drawings;

FIG. 1 illustrates conceptually a medical care risk based monitoring environment in accordance with the disclosure;

FIG. 2A illustrates conceptually a basic schematic of the physiology observer module in accordance with the disclosure;

FIGS. 2B-D illustrate conceptually exemplary graphs of probability density functions for select ISVs as generated by the physiology observer module in accordance with the disclosure;

FIG. 3 illustrates conceptually a non-limiting example of a physiology observer process in accordance with the disclosure;

FIG. 4 illustrates conceptually a non-limiting example of the physiology observer process in accordance with the disclosure;

FIG. 5 illustrates conceptually a time line, wherein back propagation is used to incorporate information in accordance with the disclosure;

FIG. 6 illustrates conceptually an example of a process involving mean arterial blood pressure (ABPm) in accordance with the disclosure;

FIG. 7 illustrates conceptually an example of resampling in accordance with the disclosure;

FIG. 8 illustrates conceptually a clinical trajectory interpreter module using joined Probability Density Functions of ISVs and performing state probability estimation to calculate the probabilities of different patient states in accordance with the disclosure;

FIG. 9 illustrates conceptually a non-limiting example of a definition of a patient state employed by the clinical trajectory interpreter module in accordance with the disclosure;

FIG. 10 illustrates conceptually a non-limiting example of how a clinical trajectory interpreter module may employ the definition of patient states to assign probabilities that the patient may be classified under each of the four possible patient states at a particular point of time;

FIG. 11 illustrates conceptually an alternative approach of estimating the probabilities for different patient states in accordance with the disclosure;

FIG. 12 illustrates conceptually a non-limiting example of a definition of patient states assigned with hazard levels by the clinical trajectory interpreter module in accordance with the disclosure;

FIG. 13 illustrates conceptually patient states and their respective probabilities organized into tree graphs called etiologies in accordance with the disclosure;

FIG. 14 illustrates conceptually an exemplary etiology tree for a given set of patient states and physiologic variables in accordance with the disclosure;

FIG. 15 illustrates conceptually a method for calculating the utility of different measurements in accordance with the disclosure;

FIG. 16 illustrates conceptually one possible realization of integration of external computation generated from third party algorithms in accordance with the disclosure;

FIG. 17 illustrates conceptually an example of integration instructions of an external computation in accordance with the disclosure;

FIG. 18 illustrates conceptually an additional example of integration instructions of an external computation in accordance with the disclosure;

FIG. 19 illustrates conceptually example functionalities of the visualization and user interactions module in accordance with the disclosure;

FIG. 20 illustrates conceptually an example of a summary view that may convey on a single screen a risk profile for each patient in a particular hospital unit in accordance with the disclosure;

FIG. 21 illustrates conceptually one possible realization of a view describing the ongoing risks of the patient in accordance with the disclosure;

FIG. 22 illustrates conceptually how the slider on top of the patient view may be utilized in reviewing the history of the patient risks in accordance with the disclosure;

FIG. 23 illustrates how the user can navigate the etiology tree by clicking on the composite patient state and viewing the constituent patient states in accordance with the disclosure;

FIG. 24 illustrates conceptually how in the same framework the user may view the predicted risks for the patient by sliding the slider ahead of current time in accordance with the disclosure;

FIG. 25 illustrates conceptually how the user may choose to set an alarm for a particular risk in accordance with the disclosure;

FIG. 26 illustrates conceptually yet another possible visualization of the patient risk trajectory, i.e., the evolution of the patient states' probabilities associated with particular risks in accordance with the disclosure;

FIG. 27 illustrates conceptually how the system may directly visualize the probability density functions of various internal state variables in accordance with the disclosure;

FIG. 28 illustrates conceptually an example of a tagging feature that a user interface may implement in accordance with the disclosure;

FIG. 29 illustrates conceptually a Newsfeed view of the user interface in accordance with the disclosure;

FIG. 30 illustrates conceptually a Condition Summary View of the user interface in accordance with the disclosure;

FIG. 31 illustrates conceptually the ability for the user interface to include and display reference material, which may be accessed through the Internet; or stored within the system in accordance with the disclosure;

FIG. 32 illustrates conceptually a general Dynamic Bayesian Network (DBN) that may be employed to capture the physiology model of the HLHS stage 1 palliation patients in accordance with the disclosure;

FIG. 33 illustrates conceptually several equations that may be used to model the dynamics of the HLHS stage 1 physiology in accordance with the disclosure;

FIG. 34 illustrates conceptually example equations that may be used to abstract the relationships between the dynamic variables in the model and the derived variables in accordance with the disclosure;

FIG. 35 illustrates conceptually a possible observation model that may be used to relate the derived variables with the available sensor data in accordance with the disclosure;

FIG. 36 illustrates conceptually possible attributes, patient states, and etiology tree that may be used by the clinical trajectory interpreter module in the case of the HLHS Stage 1 population in accordance with the disclosure;

FIG. 37 illustrates conceptually one possible environment in which the risk based monitoring system can be applied to assist clinicians in deciding whether to apply a particular treatment in accordance with the disclosure;

FIG. 38 illustrates conceptually a non-limiting example set of patient states relevant to blood transfusion that may be used to inform the blood transfusion decision in accordance with the disclosure;

FIG. 39 illustrates conceptually another application of the risk-based monitoring system, applying standardized medical plans in accordance with the disclosure;

FIG. 40 illustrates conceptually an example application of the risk based monitoring system combined with a specific type of standardized clinical plan in accordance with the disclosure;

FIG. 41 illustrates conceptually an example risk stratification that may be employed by the system in the context of Nitric Oxide treatment in accordance with the disclosure;

FIG. 42 illustrates conceptually possible patient states that may describe the clinical trajectory of an ADHD patient in accordance with the disclosure;

FIG. 43 lists the available patient evaluation modalities as M1, M2, and M3;

FIG. 44 illustrates conceptually a dynamic model of the patient evolution from state to state abstracted by a Dynamic Bayesian Network in accordance with the disclosure;

FIG. 45 illustrates conceptually an alternative embodiment for two predictions of how the patient state can transition in a single month given medication change or a dosage change in accordance with the disclosure;

FIG. 46 illustrates conceptually one possible embodiment and scenario of visualization displaying the patient clinical trajectory and risks in accordance with the disclosure;

FIG. 47 illustrates conceptually an evaluation of the patient and the patient trajectory at week 9 at which point risk based patient monitoring system determines a probability distribution function for the state of the patient for each of the past nine weeks in accordance with the disclosure;

FIG. 48 shows a follow-up evaluation based on teacher and parent Vanderbilt diagnosis in accordance with the disclosure;

FIG. 49 shows consequent evaluation based on all available measurements—office visit, parent and teacher evaluation, which establishes high probability for significant improvement in accordance with the disclosure;

FIG. 50 shows yet another follow-up at which point it is established that the patient is most probably stably improved, and has been stably improved between the two evaluations in accordance with the disclosure;

FIG. 51 shows a follow-up evaluation of the patient and the patient trajectory in the absence of measurements, wherein due to the lack of recent observation, the uncertainty is increasing in accordance with the disclosure;

FIG. 52 shows the state of this uncertainty given a full patient evaluation (all measurement modalities) in accordance with the disclosure; and

FIG. 53 illustrates yet another possible visualization from the described system output. It shows possible patient state transitions under changes of treatment plan, e.g., change of medication in accordance with the disclosure.

DETAILED DESCRIPTION OF SPECIFIC EMBODIMENTS

Technologies are provided herein for providing risk-based patient monitoring of individual patients to clinical personnel. The technologies described herein can be embodied as a monitoring system for critical care, which combines data from various bedside monitors, electronic medical records, and other patient specific information to assess the current and the future risks to the patient. The technologies can be also embodied as a decision support system that prompts the user with specific actions according to a standardized medical plan, when patient specific risks pass a predefined threshold. Yet another embodiment of the described technologies is an outpatient monitoring system which combines patient and family evaluation, together with information about medication regiments and physician evaluations to produce a risk profile of the patient, continuously track its clinical trajectory, and provide decision support to clinicians as regarding when to schedule a visit or additional tests.

System Modules and Interaction

Referring now to the Figures, FIG. 1 illustrates a medical care risk based monitoring environment 1010 for providing health providers, such as physicians, nurses, or other medical care providers, risk-based monitoring in accordance with various embodiments of the present disclosure. A patient 101 may be coupled to one or more physiological sensors or bedside monitors 102 that may monitor various physiological parameters of the patient. These physiological sensors may include but are not limited to, a blood oximeter, a blood pressure measurement device, a pulse measurement device, a glucose measuring device, one or more analyte measuring devices, an electrocardiogram recording device, amongst others. In addition, the patient may be administered routine exams and tests and the data stored in an electronic medical record (EMR) 103. The electronic medical record 103 may include but is not limited to stored information such as hemoglobin, arterial and venous oxygen content, lactic acid, weight, age, sex, ICD-9 code, capillary refill time, subjective clinician observations, patient self-evaluations, prescribed medications, medications regiments, genetics, etc. In addition, the patient 101 may be coupled to one or more treatment devices 104 that are configured to administer treatments to the patient. In various embodiments, the treatments devices 104 may include extracorporeal membrane oxygenator, ventilator, medication infusion pumps, etc.

By way of the present disclosure, the patient 101 may be afforded improved risk-based monitoring over existing methods. A patient specific risk-based monitoring system, generally referred to herein as system 100, may be configured to receive patient related information, including real-time information from bed-side monitors 102, EMR patient information from electronic medical record 103, information from treatment devices 104, such as settings, infusion rates, types of medications, and other patient related information, which may include the patient's medical history, previous treatment plans, results from previous and present lab work, allergy information, predispositions to various conditions, and any other information that may be deemed relevant to make an informed assessment of the possible patient conditions and states, and their associated probabilities. For the sake of simplicity, the various types of information listed

above will generally be referred to hereinafter as “patient-specific information”. In addition, the system may be configured to utilize the received information, determine the clinical risks, which then can be presented to a medical care provider, including but not limited to a physician, nurse, or other type of clinician.

The system, in various embodiments, includes one or more of the following: a processor **111**, a memory **112** coupled to the processor **111**, and a network interface **113** configured to enable the system to communicate with other devices over a network. In addition, the system may include a risk-based monitoring application **1020** that may include computer-executable instructions, which when executed by the processor **111**, cause the system to be able to afford risk based monitoring of the patients, such as the patient **101**.

The risk based monitoring application **1020** includes, for example, a data reception module **121**, a physiology observer module **122**, a clinical trajectory interpreter module **123**, and a visualization and user interaction module **124**. In an exemplary embodiment, the data reception module **121** may be configured to receive data from bedside monitors **102**, electronic medical records **103**, treatment devices **104**, and any other information that may be deemed relevant to make an informed assessment regarding the patient’s clinical risks, and any combination thereof of the preceding elements.

The physiology observer module **122** utilizes multiple measurements to estimate probability density functions (PDF) of internal state variables (ISVs) that describe the components of the physiology relevant to the patient treatment and condition in accordance with a predefined physiology model. The ISVs may be directly observable with noise (as a non-limiting example, heart rate is a directly observable ISV), hidden (as a non-limiting example, oxygen delivery (DO_2) defined as the flow of blood saturated oxygen through the aorta cannot be directly measured and is thus hidden), or measured intermittently (as a non-limiting example, hemoglobin concentration as measured from Complete Blood Count tests is an intermittently observable ISV).

In one embodiment, instead of assuming that all variables can be estimated deterministically without error, the physiology observer module **122** of the present disclosure provides probability density functions as an output. Additional details related to the physiology observer module **122** are provided herein.

The clinical trajectory interpreter module **123** may be configured, for example, with multiple possible patient states, and may determine which of those patient states are probable and with what probability, given the estimated probability density functions of the internal state variables. A patient state is defined as a qualitative description of the physiology at a particular point of a clinical trajectory, which is recognizable by medical practice, and may have implications to clinical decision-making. Examples of particular patient states include, but are not limited to, hypotension with sinus tachycardia, hypoxia with myocardial depression, compensated circulatory shock, cardiac arrest, hemorrhage, amongst others. In addition, these patient states may be specific to a particular medical condition, and the bounds of each of the patient states may be defined by threshold values of various physiological variables and data. In various embodiments, the clinical trajectory interpreter module **123** may determine the patient conditions under which a patient may be categorized using any of information gathered from reference materials, information provided by health care providers, other sources of information. The reference materials may be stored in a database or other storage device **130**

that is accessible to the risk based monitoring application **1020** via network interface **113**, for example. These reference materials may include material synthesized from reference books, medical literature, surveys of experts, physician provided information, and any other material that may be used as a reference for providing medical care to patients. In some embodiments, the clinical trajectory interpreter module **123** may first identify a patient population that is similar to the subject patient being monitored. By doing so, the clinical trajectory interpreter module **123** may be able to use relevant historical data based on the identified patient population to help determine the possible patient states.

The clinical trajectory interpreter module **123** is capable of also determining the probable patient states under which the patient can be currently categorized, given the estimated probability density functions of the internal state variables, as provided by physiology observer module **122**. In this way, each of the possible patient states is assigned a probability value from 0 to 1. The combination of patient states and their probabilities is defined as the clinical risk to the patient. Additional details related to the clinical trajectory interpreter module **123** are provided herein.

Visualization and user interactions module **124** may be equipped to take the outputs of the data reception module **121** the physiology observer module **122**, and the clinical trajectory interpreter module **123** and present them to the clinical personnel. The visualization and user interactions module **124** may show the current patient risks, their evolution through time, the probability density functions of the internal state variables as functions of time, and other features that are calculated by the two modules **122** and **123** as by-products and are informative to medical practice. Additionally, visualization and user interactions module **124** enables the users to set alarms based on the patient state probabilities, share those alarms with other users, take notes related to the patient risks and share those notes with other users, and browse other elements of the patient medical history. Additional details related to the visualization and user interactions module **124** are provided herein.

Physiology Observer

FIG. 2 illustrates a basic schematic of the physiology observer module **122**, which utilizes two models of the patient physiology: a dynamic model **212** and an observation model **221**. The dynamic model **212** captures the relationship arising between the internal state variables at some time t_k and another close time t_{k+1} , thereby enabling modeling of the patient physiology as a system whose present state has information about the possible future evolutions of the system. Given the propensity of the patient physiology to remain at homeostasis through auto-regulation, there is a clear rationale of introducing such memory in internal state variables that are indicative of the homeostasis, e.g., oxygen delivery and oxygen consumption.

The observation model **221** may capture the relationships between measured physiology variables and other internal state variables. Examples of such models include: a) the dependence of the difference between systolic and diastolic arterial blood pressures (also called pulse pressure) on the stroke volume; b) the relationship between heart rate, stroke volume, and cardiac output; c) the relationship between hemoglobin concentration, cardiac output and oxygen delivery; d) the relationship between the Vanderbilt Assessment Scale and the clinical state of an attention deficit and hyperactivity disorder patient; and e) any other dependence between measurable and therefore observable parameters and internal state variables.

The physiology observer module 122 functions as a recursive filter by employing information from previous measurements to generate predictions of the internal state variables and the likelihood of probable future measurements and then comparing them with the most recently acquired measurements. Specifically the physiology observer module 122 utilizes the dynamic model 212 in the predict step or mode 210 and the observation model 221 in the update step or mode 220. During the prediction mode 210, the physiology observer module 122 takes the estimated PDFs of ISVs 213 at a current time step t_k and feeds them to the dynamic model 212, which produces predictions of the ISVs 211 for the next time step t_{k+1} . This is accomplished using the following equation:

$$P(ISVs(t_{k+1})|M(t_k)) = \int_{ISVs \in ISV} P(ISVs(t_{k+1})|ISVs(t_k)) P(ISVs(t_k)|M(t_k)) dISVs$$

where $ISVs(t_k) = \{ISV_1(t_k), ISV_2(t_k), ISV_3(t_k), \dots, ISV_n(t_k)\}$ and $M(t_k)$ is the set of all measurements up to time t_k . The probability $P(t_{k+1}|ISVs(t_k))$ defines a transition probability kernel describing the dynamic model 212, which defines how the estimated PDFs evolve with time. The probabilities $P(ISVs(t_k)|M(t_k))$ are provided by the inference engine 222 and are the posterior probabilities of the ISVs given the measurements acquired at the previous time step. During the update mode 210 of the physiology observer module 122, the predicted ISVs 211 are compared against the received measurements from data reception module 121 with the help of the observation model 221, and as a result the ISVs are updated to reflect the new available information. The inference engine 222 of module 122 achieves this update by using the predicted PDFs as a-priori probabilities, which are updated with the statistics of the measurements to achieve the posterior probabilities reflecting the current ISVs PDFs estimates 213. The inference engine 222 accomplished the update step 220 with the following equation which is Bayes' Theorem,

$$P(ISVs(t_{k+1})|M(t_{k+1})) = \frac{P(m_1(t_{k+1}), m_2(t_{k+1}), \dots, m_n(t_{k+1})|ISVs(t_{k+1})) P(ISVs(t_{k+1})|M(t_k))}{P(M(t_{k+1}))}$$

where $P(m_1(t_{k+1}), m_2(t_{k+1}), \dots, m_n(t_{k+1})|ISVs(t_{k+1}))$ is the conditional likelihood kernel provided by the observation model 221 that determines how likely the currently received measurements are given the currently predicted ISVs.

At the initialization time, e.g., $t=0$, when no current estimate of ISVs PDFs is available, the physiology observer module 122 may utilize initial estimates 250, which may be derived from an educated guess of possible values for the ISVs or statistical analysis of previously collected patient data.

FIG. 3 illustrates a non-limiting example of models that enable the physiology observer in accordance with the present disclosure. While not directly observable, the management of oxygen delivery, DO2, is an important part of critical care. Therefore, precise estimation of DO2 can inform improved clinical practice. In the illustrated example, this estimation is achieved through the measurements of hemoglobin concentration (Hg), heart rate (HR), diastolic and systolic arterial blood pressures, and SpO2. The dynamic model 212 assumes that oxygen delivery is driven by a feedback process which stabilizes it against stochastic disturbances. Similarly, hemoglobin concentration is controlled around the norm value of 15 mg/dL. The observation model 221 takes into account the relationship between

arterial oxygen saturation SpO2, hemoglobin concentration and arterial oxygen content CaO2, the dependence of the difference between systolic, ABPs, and diastolic, ABPd, arterial blood pressures (also called pulse pressure) on the stroke volume, and the relationship between heart rate, HR, stroke volume, SV, and cardiac output. The two models are abstracted as a Dynamic Bayesian Network (DBN), and the physiology observer module 122 utilizes the DBN to continuously track the oxygen delivery. A Dynamic Bayesian Network is a systematic way to represent statistical dependencies in terms of a graph whose vertices signify variables (observable and unobservable), and whose edges show causal relationships. Further descriptions of an exemplary DBN for DO2 estimation can be found in U.S. Provisional Application No. 61/699,492, filed on Sep. 11, 2012, entitled SYSTEMS AND METHODS FOR EVALUATING CLINICAL TRAJECTORIES AND TREATMENT STRATEGIES FOR OUTPATIENT CARE, and U.S. Provisional Application No. 61/684,241, filed on Aug. 17, 2012, entitled SYSTEM AND METHODS FOR PROVIDING RISK ASSESSMENT IN ASSISTING CLINICIANS WITH EFFICIENT AND EFFECTIVE BLOOD MANAGEMENT, to which priority is claimed, the disclosure of which is incorporated herein by reference.

FIG. 4 depicts a non-limiting example of the physiology observer described above tracking DO2, but over a longer time interval, i.e., 4 time steps. In the observer, the main hidden ISV is the oxygen delivery variable (DO2). The two types of measurements, Hemoglobin (Hg) and oximetry (SpO2) are in dashed circles in FIG. 4. SpO2 is an example of the continuous or periodic measurements that the physiology observer module 122 receives from sensors, such as bedside monitors 102 and treatment devices 104 connected to the patient 101 that continuously report information. Hemoglobin (Hg) is an example of an intermittent or aperiodic measurement extracted from patient lab work that is available to the observer on a sporadic and irregular basis, and latent at times, relative to current system time. The physiology observer module 122 is capable of handling both types of measurements because, along with tracking the hidden ISVs, e.g. DO2, module 122 also continuously maintains estimates of the observed values for all types of measurements, even when measurements are not present. FIG. 4 depicts these estimates for the case of SpO2 and Hg. As can be seen, the SpO2 measurements are available regularly at each time step, whereas Hg is only available at two of the time steps.

As mentioned above, certain measurements, such as Hemoglobin, are available to the system with an unknown amount of time latency, meaning the measurements are valid in the past relative to the current time and the time they arrive over the data communication links. The physiology observer module 122 may handle such out of sequence measurements using back propagation, in which the current estimates of the ISVs are projected back in time to the time of validity of the measurements, so that the information from the latent measurement can be incorporated correctly. FIG. 5 depicts such time line. In FIG. 5, hemoglobin arrives at the current system time, t_k , but is valid and associated back to the ISV (DO2) at time T_{k-2} . Back propagation is the method of updating the current ISVs probability estimates $P(ISVs(t_k)|M(t_k))$ with a measurement that is latent relative to the current time, $m(t_{k-n})$. Back propagation is accomplished in a similar manner to the prediction method described previously. There is a transition probability kernel, $P(ISVs(t_{k-n})|ISVs(t_k))$, that defines how the current probabilities evolve backwards in time. This can then be used to compute

probabilities of the ISVs at time t_{k-n} given the current set of measurements which excludes the latent measurement, as follows:

$$P(\text{ISVs}(t_{k-n})|M(t_k)) = \int_{\text{ISVs} \in \text{ISV}} P(\text{ISVs}(t_{k-n})|\text{SVs}(t_k)) P(\text{ISVs}(t_k)|M(t_k)) d\text{ISVs}$$

Once these probabilities are computed, the latent measurement information is incorporated using Bayes' rule in the standard update:

$$P(\text{ISVs}(t_{k-n})|M(t_k), m(t_{k-n})) = \frac{P(m(t_{k-n})|\text{ISVs}(t_{k-n}))P(\text{ISVs}(t_{k-n})|M(t_k))}{P(M(t_k), m(t_{k-n}))}$$

The updated probabilities are then propagated back to the current time t_k using the prediction step described earlier. Back propagation can be used to incorporate the information.

Another functionality of the physiology observer module 122 includes smoothing. The care provider using the system 100 may be interested in the patient state at some past time. With smoothing, the physiology observer module 122 may provide a more accurate estimate of the patient ISVs at that time in the past by incorporating all of the new measurements that the system has received since that time, consequently providing a better estimate than the original filtered estimate of the overall patient state at that time to the user, computing $P(\text{ISVs}(t_{k-n})|M(t_k))$. This is accomplished using the first step of back propagation in which the probability estimates at time t_k which incorporate all measurements up to that time are evolved backwards to the time of interest t_{k-n} using the defined transition probability kernel. This is also depicted in FIG. 5, in which the user is interested in the patient state at t_{k-n} and the estimates are smoothed back to that time.

Because physiology observer module 122 maintains estimates of each of the measurements available to the system 100 based on physiologic and statistical models, module 122 may filter artifacts of the measurements that are unrelated to the actual information contained in the measurements. This is performed by comparing the newly acquired measurements with the predicted likelihoods of probable measurements given the previous measurements. If the new measurements are considered highly unlikely by the model, they are not incorporated in the estimation. The process of comparing the measurements with their predicted likelihoods effectively filters artifacts and reduces noise. FIG. 6 shows an example of such a process involving mean arterial blood pressure (ABPm). Because ABPm is collected using an intravenous catheter, the measured signals are often corrupted with artifacts that result in incorrect measurements when the catheter is used for medical procedures such as blood draws or line flushes. FIG. 6 shows the raw ABPm measurements prior to being processed by the physiology observer with the measurement artifacts identified, as well as the filtered measurements after being processed by the physiology observer module 122. As can be seen, the measurement artifacts have been removed and the true signal is left.

In various embodiments, physiology observer module 122 may utilize a number of algorithms for estimation or inference. Depending on the physiology model used, the physiology observer module 122 may use exact inference schemes, such as the Junction Tree algorithm, or approximate inference schemes using Monte Carlo sampling such as a particle filter, or a Gaussian approximation algorithms such as a Kalman Filter or any of its variants.

As discussed, the physiology model used by physiology observer module 122 may be implemented using a probabilistic framework known as a Dynamic Bayesian Network, which graphically captures the causal and probabilistic relationship between the ISVs of the system, both at a single instance of time and over time. Because of the flexibility this type of model representation affords, the physiology observer module 122 may utilize a number of different inference algorithms. The choice of algorithm is dependent on the specifics of the physiology model used, the accuracy of the inference required by the application, and the computational resources available to the system. Used in this case, accuracy refers to whether or not an exact or approximate inference scheme is used. If the physiology observer model is of limited complexity, then an exact inference algorithm may be feasible to use. In other cases, for more complex physiology observer models, no closed form inference solution exists, or if one does exist, it is not computationally tractable given the available resources. In this case, an approximate inference scheme may be used.

The simplest case in which exact inference may be used, is when all of the ISVs in the physiology model are continuous variables, and relationships between the ISVs in the model are restricted to linear Gaussian relationships. In this case, a standard Kalman Filter algorithm can be used to perform the inference. With such algorithm, the probability density function over the ISVs is a multivariate Gaussian distribution and is represented with a mean and covariance matrix.

When all of the ISV's in the model are discrete variables, and the structure of the graph is restricted to a chain or tree, the physiology observer module 122 may use either a Forward-backward algorithm, or a Belief Propagation algorithm for inference, respectively. The Junction Tree algorithm is a generalization of these two algorithms that can be used regardless of the underlying graph structure, and so the physiology observer module 122 may also use this algorithm for inference. Junction Tree algorithm comes with additional computational costs that may not be acceptable for the application. In the case of discrete variables, the probability distribution functions can be represented in a tabular form. It should be noted that in the case where the model consists of only continuous variables with linear Gaussian relationships, these algorithms may also be used for inference, but since it can be shown that in this case these algorithms are equivalent to the Kalman Filter, the Kalman Filter is used [hc1] the example algorithm.

When the physiology model consists of both continuous and discrete ISVs with nonlinear relationships between the variables, no exact inference solution is possible. In this case, the physiology observer module 122 may use an approximate inference scheme that relies on sampling techniques. The simplest version of this type of algorithm is a Particle Filter algorithm, which uses Sequential Importance Sampling. Markov Chain Monte Carlo (MCMC) Sampling methods may also be used for more efficient sampling. Given complex and non-linear physiologic relationships, this type of approximate inference scheme affords the most flexibility. A person reasonably skilled in the relevant arts will recognize that the model and the inference schemes employed by the physiology observer module may be any combination of the above described or include other equivalent modeling and inference techniques.

When using particle filtering methods, a resampling scheme is necessary to avoid particle degeneracy. The physiology observer may utilize an adaptive resampling scheme. As described in detail below, regions of the ISV

state space may be associated with different patient states, and different levels of hazard to the patient. The higher the number, the more hazardous that particular condition is to the patient's health. In order to ensure accurate estimation of the probability of a particular patient condition, it may be necessary to have sufficient number of sampled particles in the region. It may be most important to maintain accurate estimates of the probability of regions with high hazard level and so the adaptive resampling approach guarantees sufficient particles will be sampled in high hazard regions of the state space. FIG. 7 illustrates an example of this resampling. State 1 and State 2 have the highest hazard level. The left plot depicts the samples generated from the standard resampling. Notice there are naturally more particles in state 1 and state 2 region because these states are most probable. The right plot shows the impact of the adaptive resampling. Notice how the number of samples in the areas of highest risk has increased significantly.

Clinical Trajectory Interpreter

Referring now to FIG. 8, the Clinical Trajectory Interpreter **123** takes the joint Probability Density Functions of the ISVs from physiology observer module **122**, and performs state probability estimation **801** to calculate the probabilities of different patient states. The Probability Density Functions of the ISVs may be defined in closed form, for example multidimensional Gaussians **260**, or approximated by histogram **280** of particles **270**, as illustrated in FIGS. 2B-D. In both cases, the probability density functions of the ISVs can be referred to as: $P(\text{ISV}_1(t), \text{ISV}_2(t), \dots, \text{ISV}_n(t))$, where t is the time they refer to. Given the internal state variables the patient state may be defined by a conditional probability density function:

$P(\text{S}|\text{ISV}_1, \text{ISV}_2, \dots, \text{ISV}_n)$, where $\text{S} \in \text{S}_1, \text{S}_2, \dots, \text{S}_N$ represents all possible patient states S_i

Then determining the probability of the patient being in a particular state S_i may be performed by the equation:

$$P(\text{S}_i(t)) = \int_{-\infty}^{\infty} \dots \int_{-\infty}^{\infty} P(\text{S}|\text{ISV}_1, \text{ISV}_2, \dots, \text{ISV}_n) P(\text{ISV}_1(t), \text{ISV}_2(t), \dots, \text{ISV}_n(t)) d\text{ISV}_1 \dots d\text{ISV}_n$$

In case that $P(\text{ISV}_1(t), \text{ISV}_2(t), \dots, \text{ISV}_n(t))$ is defined by a closed form function such as multidimensional Gaussian **260**, the integration may be performed directly. In case that $P(\text{ISV}_1(t), \text{ISV}_2(t), \dots, \text{ISV}_n(t))$ is approximated by a histogram **280** of particles **270** and $P(\text{S}|\text{ISV}_1, \text{ISV}_2, \dots, \text{ISV}_n)$ is defined by a partition of the space spanned by $\text{ISV}_1, \text{ISV}_2, \dots, \text{ISV}_n$ into regions as shown in FIG. 9, the probability $P(\text{S}_i(t))$ may be calculated by calculating the fraction of particles **270** in each region.

Once patient state probabilities are estimated, the clinical trajectory interpreter module **123** may assign different hazard levels **802** for each patient state or organize the states into different etiologies **803**. The clinical trajectory interpreter module **123**, in conjunction with the physiology observer module **122**, may perform measurements utility determination **804** to determine the utility of different invasive measurements such as invasive blood pressures or invasive oxygen saturation monitoring. In one embodiment, the Clinical trajectory interpreter Module **123** determines the probabilities that the patient is in a particular state, rather than the exact state that the patient is in.

FIG. 9 illustrates a non-limiting example of a definition of a patient state that may be employed by the clinical trajectory interpreter module **123**. Specifically, it assumes that the function $P(\text{S}|\text{ISV}_1, \text{ISV}_2, \dots, \text{ISV}_n)$ may be defined by partitioning the domain spanned by the internal state variables $\text{ISV}_1, \text{ISV}_2, \dots, \text{ISV}_n$. The particular example assumes that the patient physiology is described by two

internal state variables: Pulmonary Vascular Resistance (PVR) and Cardiac Output (CO). The particular risks and respective etiologies that may be captured by these two ISVs emanate from the effects of increased pulmonary vascular resistance on the circulation. Specifically, high PVR may cause right-heart failure and consequently reduced cardiac output. Therefore, PVR can be used to define the attributes of Normal PVR and High PVR, and CO to define the attributes of Normal CO and Low CO, by assigning thresholds with the two variables. By combining these attributed, four separate states can be defined: State 1: Low CO, Normal PVR; State 2: Low CO, High PVR; State 3: Normal CO, High PVR; State 4: Normal CO Normal PVR.

FIG. 10 illustrates a non-limiting example of how the clinical trajectory interpreter module **123** may employ the definition of patient states to assign probabilities that the patient may be classified under each of the four possible patient states at a particular point of time. In the example, the clinical trajectory interpreter module **123** takes the joint probability density function of $P(\text{Cardiac Output (Tk)}, \text{Pulmonary Vascular Resistance (Tk)})$ and integrates it over the regions corresponding to each particular state, which produces $P(\text{S1}(\text{Tk}))$, $P(\text{S2}(\text{Tk}))$, $P(\text{S3}(\text{Tk}))$, and $P(\text{S4}(\text{Tk}))$. In this way, the clinical trajectory interpreter module **123** assigns a probability that a particular patient state is ongoing, given the information provided by the physiology observer module **122**. Note that if the output of the physiology observer module **122** is not a closed form function **260** but a histogram **280** of particles **270**, the clinical interpreter will not perform integration but just calculate the relative fraction of particles **270** within each region.

FIG. 11 illustrates an alternative approach of estimating the probabilities for different patient states. In this alternative approach, to calculate the probabilities $P(\text{S1})$, $P(\text{S2})$, $P(\text{S3})$ and $P(\text{S4})$, the clinical trajectory interpreter module **123** employs the joint probability functions of the ISVs for two consecutive time windows T_k and T_{k+1} to calculate a moving window average. Note in the example that the size of the window is doubled for two time instances, which indicates that the window may be of an arbitrary, suitable size. As a result of this moving window averaging, the clinical trajectory interpreter module **123** performs a dynamic analysis of the trajectory of the ISVs. That is, it gives a metric of the probability that the physiology trajectory, as described by the ISVs, may be found in a particular region in a particular time frame. In other words, this probability calculation gives an estimate of the probability that a particular patient state may be ongoing in the chosen time-frame, as opposed to just at a chosen time instance.

Clinical trajectory interpreter module **123** may also assign hazard levels to each particular state. FIG. 12 illustrates a non-limiting example of a definition of patient states assigned with hazard levels by the clinical trajectory interpreter module **123**. The hazard levels may be informed from clinician surveys, reference literature or any other clinical sources. In the particular example, the clinical trajectory interpreter module **123** distinguishes between four different hazard levels: 1—Minimal risk, 2—Mild risk, 3—Medium risk, and 4—Severe risk. The combination of the probability of a patient state and its hazard level will be referred from hereon as a "Patient risk."

FIG. 13 illustrates how the patient states and their respective probabilities may be organized into tree graphs called etiologies. In particular, the attributes normal and low associated with the cardiac output ISV are the base nodes of the graph. Each of these vertexes has two children associated with the attributes of the pulmonary vascular resistance. This

organization leads to each patient state being a leaf (end vertex) on the tree. This particular tree will be referred to as an etiology tree. The etiology tree may be further employed by the visualization and user interaction module **124** to provide a layered view of the various patient risks as further described herein.

FIG. **14** illustrates that the etiology tree may not be unique for a given set of patient states and physiologic variables. Specifically, FIG. **14** provides an alternative etiology tree for the example from FIG. **13**. The root of the alternative etiology tree starts from the attributes associated with the pulmonary vascular resistance, instead of the attributes associated with cardiac output. It can be appreciated that different rules may be employed for generating the trees depending on various factors and the context of use. For example, one etiology tree may be preferred against another realization in different clinical situations or depending on the preference of the users. Moreover, the tree may dynamically change as the risks change and the clinical situation evolves.

Utility of Different Measurements

During hospital care, there exist measurements that may harm the patient or slow down their recovery. Examples of such harmful measurements are all measurements coming from catheters such as invasive blood pressures and blood oximetry, which have been shown to significantly increase the risk of infection. Therefore, it may be useful if, during the care process, the clinician is provided with an assessment of the utility of each of the potentially harmful measurements. FIG. **15** illustrates a method for calculating the utility of different measurements.

Referring to FIG. **15**, the risk-based system **100** and the clinical trajectory interpreter module **123** may calculate the utility of a particular measurement with the illustrated procedure. Particularly, in step **9001**, a measurement m_i may be selected. Given measurement m_i and a current time ($t_{current}$), in step **9002**, the clinical trajectory interpreter module **123** may submit an instruction to the physiology observer module **122** to simulate the physiology observer module output (the probability density functions of the internal state variables) from a given arbitrary point back from the current time ($t_{current}-T$) to the current time $t_{current}$ with removal of measurement m_i from the algorithm output. Then, in step **9003**, the clinical trajectory interpreter module **123** may simulate the state probabilities estimation given the simulated output of the physiology observer and arrive with a set of patient state probabilities, i.e., $P_{sim}(S_1(t_{current}))$, $P_{sim}(S_2(t_{current}))$, . . . , $P_{sim}(S_n(t_{current}))$. Then, in step **9004**, using the state probabilities determined from all available measurements, i.e., $P(S_1(t_{current}))$, $P(S_2(t_{current}))$, . . . , $P(S_n(t_{current}))$, the clinical trajectory interpreter module **123** may calculate the utility of the measurement m_i using the formula:

$$U(m_i) = D(P_{sim} | P) = \sum_{i=1}^n P(S_i(t_{current})) \log \left(\frac{P(S_i(t_{current}))}{P_{sim}(S_i(t_{current}))} \right),$$

which is also the Kullback-Leibler divergence between the patient state distribution given all available measurements and the patient state distribution given the measurement m_i has been removed for a time interval T .

Alternatively, in step **9005**, the clinical trajectory interpreter module **123** may calculate utility for m_i by employing the hazard levels, r_i , assigned to each state S_i by the formula:

$$U(m_i) = D_{weighted}(P_{sim} | P) = \sum_{i=1}^n r_i P(S_i(t_{current})) \log \left(\frac{P(S_i(t_{current}))}{P_{sim}(S_i(t_{current}))} \right).$$

In a similar manner, the clinical trajectory interpreter module **123** can perform the utility calculation not only for a particular measurement, but also for any group of measurements. The utility calculation can also include a component that captures the potential harm associated with a particular measurement. For example, the invasive catheter measurement described above would have a large level of harm associated with it. In this way, the calculation trades the harm associated with the measurement against the value of information it provides. An example of this modified utility calculation is given by the following formula:

$$U(m_i) = D_{weighted}(P_{sim} | P) - H(m_i),$$

where $H(m_i)$ defines a function that describes the harm of each available measure.

The risk-based monitoring system **100** can also integrate external computation generated from third party algorithms implemented either on the same computation medium as the patient-based monitoring system or as a part of an external device. FIG. **16** illustrates one possible realization of integration of an external computation generated from third party algorithms. Particularly, the output from the external computation **9110** is provided to the clinical trajectory interpreter module **123** which implements integration instructions **9120**. As a result the state probability estimation **801** produces new states $P(\text{new}S_1)$, $P(\text{new}S_2)$, $P(\text{new}S_3)$, . . . , $P(\text{new}S_{n+m})$, which may result in an increased number of states $n+m$ from the original number of n states. Similarly, integration instructions **9120** may be provided to the hazard level assignment **802** and the etiology organization **803**.

FIG. **17** illustrates an example of integration instructions. In the example, it is assumed that the external computation, EC, provides information about particular binary attributes $A=a_1$ or $A=a_2$, and the specific of how the provided information is captured in the integration instructions by the conditional probability $P(EC|A)$. Also, given four original states S_1 , S_2 , S_3 , and S_4 , the integration instruction may specify how the states S_3 and S_4 may be updated with two additional attributes $A=a_1$ and $A=a_2$, and turn into four new states $\text{new}S_3$, $\text{new}S_4$, $\text{new}S_5$, and $\text{new}S_6$. To perform this update, the integration instruction may also employ prior probabilities $P(A|S_3)$ and $P(A|S_4)$. These prior probabilities may be derived from retrospective studies by analyzing what fractions of patients exhibiting S_3 or S_4 have concomitantly exhibited $A=a_1$ or $A=a_2$.

Another way to derive the prior probabilities is by soliciting the opinion of clinicians.

By utilizing the integration instructions, the state probabilities estimation **801** of the new states may then be derived from the formula:

$$P(A=a_p, S_i | EC) = P(EC|A=a_p) P(A=a_p | S_i) P(S_i) / P(EC),$$

where i in $\{3,4\}$ and j in $\{1,2\}$, and where $P(S_j)$ are the original patient state probabilities derived from the output of the physiology observer module **122**.

FIG. **18** illustrates an additional example of integration instructions of an external computation. Again, the risk-based monitoring system **100** can perform the integration, as shown in FIG. **18**, both in the case that the external computation **9110** is generated on the same computational medium as the patient-based monitoring system, or as a part of an external device. In this case, it is assumed that the

external computation **9110** provides direct information about a particular internal state variable estimated by the physiology observer module **122** (or enhanced physiology observer module **9300**). Therefore, to integrate the external computation, the physiology observer module **122** can treat the external computation **9110** as an additional measurement and integrate it directly into the observation model **221**.

Visualization and User Interaction|[DB2]

FIG. **19** illustrates example functionalities of the visualization and user interactions module **124**. Specifically, module **124** may receive all available patient information and data including, the data from the data reception module **121**, the joint probability density function produced by the physiology observer module **122**, and the etiology tree, the risks, and the invasive measurements utilities estimated by the clinical trajectory interpreter module **123**. By utilizing this information, the visualization and user interactions module **124** may produce: 1) a unit view **1501** of patients describing their risks, diagnoses, etc.; 2) a view **1502** of a patient's electronic medical record including laboratory results, prescribed medication, diagnoses, etc.; 3) a view **1503** of a patient's ongoing risks; 4) a view **1504** of a patient's risk trajectory, i.e., how the probabilities for particular patient states have evolved in a particular time frame; 5) a view **1505** of a patient's measurements utilities in the estimation of the particular patient risks; 6) a plot of a patient estimated ISVs' PDFs **1506** describing the time evolution of the ISVs' PDFs; 7) a view **1507** enabling to navigate through the etiology tree of the patient and thus visualize different levels of the tree; 8) a view **1508** showing a patient's predicted risks; 9) a view **1509** enabling clinicians to view and set patient risk based alarms; 10) a view **1510** of a patient's physiology monitoring data and its evolution against time; and 11) any combination of the above described. In addition, the visualization and user interactions module **124** may also produce a patient tags view **1511**, a patient condition summary **1512**, reference and training material **1513**, and annotation and tag setting **1514**.

FIG. **20** illustrates an example of a summary view **2000** that may convey in a single screen a risk profile for each patient in a particular hospital unit. The risk profile represents what is the cumulative probability of the patient being in a particular hazard level. It is calculated by summing the current probabilities of all states at particular hazard level. In the example, the summed probabilities, hazard levels are represented by the height of four bars, each bar corresponding to a particular hazard level. In this specific example, these hazard levels may be Green (slanted hatching)—Minimal risk, Yellow (vertical hatching)—Mild risk, Orange (horizontal hatching)—Medium risk, and Red (dotted hatching)—Severe risk.

FIG. **21** illustrates one possible realization of a view **2100** describing the ongoing risks of the patient. Each rounded-cornered box corresponds to a particular risk: the color corresponds to the hazard level with Green (slanted hatching)—Minimal risk, Yellow (vertical hatching)—Mild risk, Orange (horizontal hatching)—Medium risk, and Red (dotted hatching)—Severe risk; the height of the box corresponds to the probability of the particular patient state. Risks are grouped in columns based on their hazard levels. The screen and the respective risks are updated in real-time as new data becomes available.

Still referring to FIG. **21**, in addition to the visualization of the ongoing patient risks, the system **100** may provide information about the utility of the various invasive measurements in determining these risks. Specifically, the illustrated example gives the utilities of invasive arterial blood

pressure (ABP) and invasive central venous pressure (CVP) measurements. The utility may be represented by filled bars **2110** and **2120**, and the maximum utility may correspond to six filled bars. The six filled bars may be displayed in color gradient from 1—dark green, 2—light green, 3—yellow, 4—red, 5—purple, to 6—white or empty. In this particular embodiment, the filled bars **2110** for ABP show all six colors, while two of the filled bars **2120** for CVP respectfully show 1—dark green and 2—light green and the remaining filled bars **2110** show 6—white or empty.

FIG. **22** illustrates a view **2200** and how a slider **2210** or other graphic element on top of the patient view may be utilized in reviewing the history of the patient risks. Specifically, in the example, the slider **2210** is moved to show the patient risks at approximately four hours back from current time. This enables clinicians to review the continuous evolution of the patient risks and compare them with the applied treatment or any other external factors. In various embodiments, slider **2210** may be moved on the user interface with a pointing device, a command, or, if utilized in conjunction with touch sensitive displays, through touching and dragging the slider or other graphic element to designate the desired time period.

Referring now to both FIGS. **21** and **22**, the etiology tree is used to combine the two states State A **2130**: Hypoxia with low cardiac output and State B **2140**: hypoxia with low Qp:Qs from FIG. **21** to represent them by a single patient state (Hypoxia) **2220**. In the particular example, this is used to fit the text into the smaller box of FIG. **22** relative to FIG. **21**. The user can navigate the etiology tree in view **2300** by clicking on the composite patient state **2220** and viewing its constituent patient states **2130** and **2140**, as illustrated in FIG. **23**.

FIG. **24** illustrates in view **2400** how in the same framework the user may view the predicted risks for the patient by moving the slider **2410** ahead of current time. |[DB3]

FIG. **25** illustrates in view **2500** an interactive dialog box **2510** through which the user may define the conditions to set an alarm for a particular risk. The user achieves this by selecting the particular risk and then setting upper and lower thresholds for the patient state probability associated with this risk. No alarm is activated as long as the patient state probability is between the upper and the lower threshold. The alarm is activated when the patient state probability crosses the threshold. Once the alarm is activated the system **100** may notify a list of chosen people, or send the notification to another clinical system. Any of module **122-124** may actually store their respective threshold data ranges and initiate the trigger depending on the specific parameter.

FIG. **26** illustrates in view **2600** yet another possible visualization of the patient risk trajectory, i.e. the evolution of the patient states' probabilities associated with particular risks. The user may choose what time series of patient state probabilities he/she wants to display, and the system plots these probabilities against time.

FIG. **27** illustrates in view **2700** how the system **100** may directly present the probability density functions of various internal state variables. Specifically, in the example, the estimated PDF of oxygen delivery is plotted in graph **2710** as a function of time, with darker colors corresponding to higher likelihood. Similarly, the estimated PDF of mixed venous oxygenation saturation (SvO₂) is plotted in graph **2720** and compared with actual measurements (dark circles).

Information Sharing Among Users

FIG. **28** in view **2800** illustrates an example of a tagging definition interface **2810** that enables clinicians to mark specific instances of time or specific periods of time **2820**

that are of interest or represent important points in the clinical course, i.e. a tag. Tags may be shared or sent via dialog box **2830** to specified recipients, or may be included in notes or any other part of the user interface. Users may be able to annotate a tag with particular comments or observations via dialog box **2840**, and tags may be classified into categories from menu list **2850**, for example, a tag may represent a change in medication dosing, an intervention, a note regarding monitors or measuring equipment, etc. Tags and their respective time-series markings may be color coded to indicate various properties, such as their category. For example, green tag-marks on a time series may represent changes in medication, red tag-marks may represent interventions, and yellow tag marks may represent periods of heightened concern. When setting a tag, the user may be prompted to define time instance or the time period, the category of the tag, the annotation for the tag, and how the tag should be handled by the system. Furthermore, annotations may be suggested by using natural language processing to convert the etiologies of the condition into note form.

FIG. **29** illustrates in view **2900** a Newsfeed view **2910** comprising tags, notes, or information taken from external sources, such as the time of a blood draw as taken from an electronic medical record (EMR). The Newsfeed **2910** may allow clinicians to view and post events, periods of interest, interventions, notes, tags, etc., which are posted by other clinicians. Clinicians may view the entire Newsfeed, or sort it based on Tag category, hazard level, etc. Further, clinicians may search for tags based on keywords, intervention type, time of stay, source of information, etc. Entries **2920-2926** on Newsfeed **2910** may indicate any of the category, source of tag, and patient overview, either in words, or as a picture, such as the risk profile.

FIG. **30** illustrates in view **3000** a Condition Summary View **3010** through which the clinician may request a condition summary by selecting or clicking a particular patient state. The Condition Summary View **3010** then may present clinicians with a description of a particular state, including both definitions in window **3020** of the state, and information regarding how the system arrived at the conclusion about this patient state probability. This view **3010** may provide the likelihood and hazard level of the patient state, the definition of the patient state in terms of ISV thresholds, and the likelihood of each attribute defining the state, as illustrated and can also provide a natural language description and evidence window **3030** of evidence contributing to the patient state, by translating the ISVs PDFs into a qualitative textual description, or by directly presenting numerical information regarding the evidence. As an example, FIG. **30** illustrates the Condition Summary View **3010** for the patient state shock due to low cardiac output.

Here, the Condition Summary View **3010** presents the probability of the “shock due to low cardiac output” state, and the hazard level of the state shown in color or dotted hatching. Further, the definitions of shock (mixed venous saturation below or equal to 45%), and low cardiac output (cardiac output below 3.2 liters per minute per meter squared), along with the probabilities that each of these are satisfied (e.g., 40% for shock and 30% for low CO) is presented. The evidence window **3030** conveys the information which leads to the assessment of “Shock due to low CO”. In this example, the system has converted the information regarding the probabilities of the etiologies into a textual form, specifically that the estimated probability is mainly driven by the fact that there is sub nominal pulse pressure (systolic blood pressure minus diastolic blood pressure) indicating reduced stroke volume.

FIG. **31** further illustrates in view **3100** the ability for the user interface to include and display reference material, which may be accessed through the Internet, or stored within the system **100** or remotely accessible thereby. Selecting the Learn More button **3110** in the Condition Summary View **3010** may bring up a Learn More View **3120**, which shows reference information associated with the Condition Summary View **3010**. Reference information may include causes, interventions, common comorbidities, anatomy, relevant publications, etc. Furthermore, this feature may serve as a training tool to familiarize clinicians with managing the particular patient population, or treatment strategies.

HLHS Stage 1 Example

The following description explains how the disclosed system **100** and techniques can be applied to the modeling of the clinical course of a specific patient population under intensive care—post-operatively recovering Hypoplastic Left Heart Syndrome patients after stage one palliation.

Hypoplastic Left Heart Syndrome is a congenital heart defect, which is manifested by an underdeveloped left ventricle and left atrium. As a result, patients suffering from this condition do not have separated systemic and pulmonary blood flows, but instead the right ventricle is responsible for pumping blood to both the body and the lungs. Therefore, the hemodynamic optimization during intensive care involves managing the fractions of the blood flow that pass through the lungs (pulmonary flow Q_p) and the body (systemic flow Q_s). The optimal hemodynamic state is reached when, adequate tissue oxygen delivery, DO_2 , is achieved for a pulmonary to systemic blood flow ratio, denoted Q_p/Q_s , of 1. Often, to reach this optimal state, the patient physiology passes through other less beneficial states, and the correct identification of these states and the application of a proper treatment strategy for each one of them define the quality of the post-operative care.

TABLE 1

Variable	Description	Units	Type
DO_2	Indexed Oxygen Delivery	mL O_2 /min/m ²	Dynamic
VO_2	Indexed Oxygen Consumption	mL O_2 /min/m ²	Dynamic
PVR	Pulmonary Vascular Resistance	mm Hg/L/min/m ²	Dynamic
SVR	System Vascular Resistance	mm Hg/L/min/m ²	Dynamic
Δ PVR	Change in PVR per time step	mm Hg/L/min/m ²	Dynamic
Δ SVR	Change in SVR per time step	mm Hg/L/min/m ²	Dynamic
Hb	Hemoglobin	g/dL	Dynamic/Observed
HR	Heart Rate	Beats per min	Dynamic/Observed
SpvO ₂	Pulmonary Venous Oxygen Saturation	%	Dynamic
SaO ₂	Arterial Oxygen Saturation	%	Derived/Observed
SvO ₂	Systemic Venous Oxygen Saturation	%	Derived/Observed
SpO ₂	Pulmonary Venous Oxygen Saturation	%	Observed
η	Aortic Compliance		Dynamic

TABLE 1-continued

Variable	Description	Units	Type
ABPm	Mean Arterial Blood Pressure	mm Hg	Derived/Observed
CVP	Central Venous Pressure	mm Hg	Dynamic/Observed
LAP	Left Atrial Pressure	mm Hg	Dynamic/Observed
RAP	Right Atrial Pressure	mm Hg	Dynamic/Observed
AP	Pulse Pressure	mm Hg	Derived/Observed
CO	Total Cardiac Output	L/min/m ²	Derived
Q _p	Pulmonary rate of blood flow	L/min/m ²	Derived
Q _s	Systemic rate of blood flow	L/min/m ²	Derived
Q _p :Q _s	Ratio of Q _p to Q _s		Derived
ΔQ _p :Q _s	Change in Ratio of Q _p to Q _s per time step		Derived
c _{DO2}	Oxygen Delivery feedback constant	—	—
c _{VO2}	Oxygen Consumption feedback constant	—	—
c _{Hb}	Hemoglobin feedback constant	—	—
c ₃	Aortic compliance scaling constant	—	—
c ₄	Aortic compliance offset	—	—
c ₅	Hemoglobin oxygen carrying capacity	—	—

Table 1 lists state variables that may be used in the model of HLHS physiology after stage 1 palliation, the variable description, units, and type of variable. A person reasonably skilled in the relevant arts will recognize that though these variables encompass circulation, hemodynamic, and the oxygen exchange components of HLHS physiology, the models can be altered or enhanced with any additional physiologic components such as ventilation, metabolism, etc. without altering the premise of the disclosed invention.

FIG. 32 depicts a general Dynamic Bayesian Network (DBN) that may be employed to capture the physiology model of the HLHS stage 1 palliation patients. The graphical model illustrated conceptually in FIG. 32 captures the causal and probabilistic relationship between the variables of the model. In the DBN, the state variables are organized into three groups: dynamic variables 3210, derived variables 3220, and observed variables 3230. Dynamic variables 3210 are variables whose values change over time based on a dynamic probabilistic model to be described below. Derived variables 3220 are quantities that depend on the dynamic variables with some functional relationship. These variables are computed or derived when required from the latest dynamic variables and are therefore also dynamic in nature. Observed variables 3230 are those variables that are measured directly by one of the sensors connected to the system and the patient. Observed variables 3230 represent instances of the true dynamic or derived states variables that have been observed under noise.

FIG. 33 lists several equations that may be used to model the dynamics of the HLHS stage 1 physiology. The model consists of four main types of stochastic models. The first type of model is a stochastic feedback control model (eqs. 1, 2, and 7). These variables have a nominal value that the body maintains, but are disturbed by some random process off of this nominal value. The strength at which the body attempts to maintain these values is decided by the feedback constant. The second type of model is a drift diffusion process (eqs. 3 and 4). These variables are driven over time by a random white noise process and a drift rate process. The third type of model is a simple random walk process (eqs. 5, 6, and 8). The last type of dynamic model is a memory-less process model in which the variable has no relationship to the variable at the previous time period, but is simply a random variable which value changes at each time instance according to some predefined distribution over the proper support of the variable, i.e. a gamma distribution over the entire positive real line with parameters A and B. (eqs. 9, 10, and

11). With the exception of equations 9, 10, and 11, the driving noise for each dynamic model is independent white Gaussian noise.

FIG. 34 depicts example equations that may be used to abstract the relationships between the dynamic variables in the model and the derived variables. Some of these functional relationships are true for general human physiology, but many are the result of the parallel circulation physiology that is specific to the HLHS population. Equations 12-15 describe relationships for variables that are measured directly. Equations 16-18 describe functional relationships for variables that are of highest interest when managing care of HLHS patients post-surgery, specifically Cardiac Output (CO) and Pulmonary to Systemic Flow ratio (Q_p:Q_s). These variables cannot be measured directly without complex procedures.

Given these functional relationships and the definition of the dynamic states, FIG. 35 now provides a possible observation model that may be used to relate the derived variables with the available sensor data. Each observation model is a conditional Gaussian relationship. Under this model, the measurement received from the sensor represents a direct observation of the underlying state variable corrupted by additional independent Gaussian White noise with some variance. The figure depicts the observed quantity as the underlying state variable with a tilde over the variable name. In this implementation, different sensors can map to the same underlying state variable, but with potentially different noise levels. For example, SpO₂ as reported by a pulse oximeter measures the underlying physiology state, SaO₂ or arterial oxygen saturation non-invasively. An intravenous catheter inserted directly into the arterial blood stream also measures this quantity but in an invasive way. The catheter measurement should be a more accurate measurement than the pulse oximetry. In this model, this is handled with a smaller measurement variance, R.

In the HLHS physiology observer, inference over the DBN is performed using a particle filter. As described earlier, a particle filter is an example of an approximate inference scheme that uses Monte Carlo samples of the internal state variables to approximate the probability density function of each state variables with an empirical distribution based on the number of particles. The filter uses a process known as Sequential Importance Sampling (SIS) to continuously resample particles from the most recent approximate probability distribution. In the filter, each particle is assigned a weight. When a new observation or measurement arrives, the weights of each particle are

updated based on the likelihood of the particular particle given the observation. The particles are then resampled based on their relative updated weights, the particles with the highest weights being more likely to be resampled than those with lower weights.

FIG. 36 illustrates possible attributes, patient states, and an etiology tree that may be used by the clinical trajectory interpreter module 123 in the case of the HLHS Stage 1 population. The variable total cardiac output defined as the sum of the systemic and the pulmonary blood flows is used to define low and normal total cardiac output, the Qp:Qs ratio is used to derive low, balanced, and high Qp:Qs ratio, the value of hemoglobin concentration Hgb is used to derive low and normal hemoglobin, and the value of the mixed venous oxygen saturation, SvO₂, is used to derive the attributes hemodynamic shock and no hemodynamic shock. This results in eight possible states defined as follows: 1) Shock caused by low total cardiac output, as the presence of both of the attributes Shock and low total cardiac output; 2) Shock caused by low hemoglobin as the state with attributes shock, normal total cardiac output, and low hemoglobin; 3) shock from unknown causes as the state with the attributes shock, normal total cardiac output, normal hemoglobin, and balanced circulation; 4) shock cause by low Qp:Qs as the state with the attributes shock, normal total cardiac output, normal hemoglobin, and low Qp:Qs; 5) shock cause by high Qp:Qs as the state with the attributes shock, normal total cardiac output, normal hemoglobin, and high Qp:Qs; 6) normal circulation as a state with the attributes of no shock and normal circulation; 7) low Qp:Qs as the state defined by the attributes of no shock and low Qp:Qs; and 8) high Qp:Qs as the state defined by the attributes of no shock and high Qp:Qs. FIG. 35 also illustrates a possible realization of an etiology tree describing the relationships between the attributes and the patient states. Using the particles approximation of internal state variables the probability of the eight states can be calculated by calculating the relative fraction of particles within each state.

Example of Applying the Risk-Based Monitoring System in Conjunction with Evaluating Consequences of a Possible Treatment

Another possible application of the risk based monitoring system is to assist clinicians when deciding whether to apply a particular treatment, one example being blood transfusion. Transfusion of blood and blood products is a common in-hospital procedure. Despite that blood transfusion indications and policies are neither well established nor consistently applied within or between medical centers. Multiple studies have demonstrated variation in transfusion practices among different hospitals, practitioners, and procedures. This variation persists even when applied to a single procedure (e.g. coronary artery bypass graft surgery).

Moreover, blood transfusion has been increasingly recognized as an independent risk factor for morbidity and mortality. Specific events and outcomes associated with transfusion include sepsis, organ ischemia, increased time on ventilation support, increased hospital length of stay, and short- and long-term morbidity. This relationship is proportional to the transfusion volume, and evidence suggests that high hematocrit values may be detrimental. Understandably, researchers conventionally recommend transfusion policies aimed at achieving an informed tradeoff between the risks and benefits.

Setting robust and effective transfusion policies has been proven to be a difficult task. The consensus in the medical community is that simple policies—such as hemoglobin threshold policies—do not provide adequate guidance. This

is due to the compensatory nature of hemodynamic physiology; patients have a variable capacity to tolerate low hemoglobin. Consequently, effective transfusion decision-making must integrate factors such as compensatory reserve, intravascular volume, hemodynamic stability, procedure type, and other patient data. Thus, there is an essential need for blood management policies that will utilize the full spectrum of relevant clinical variables and determine the risk/benefit ratio of transfusion. This is exactly afforded by applying the risk based monitoring system.

FIG. 37 illustrates one possible environment in which the risk based monitoring system can be applied to assist clinicians in deciding whether to apply a particular treatment. Consistent with the disclosure, a patient 101 is being monitored with multiple measurements 3910, both intermittently and persistently. The persistent measurements may include mixed venous oxygen saturation (SvO₂) 3911, systolic, diastolic and mean arterial blood pressures (ABP s/d/m) 3913, heart rate 3916, monitored via a bedside monitor. The intermittent measurements may include blood pH 3915, hemoglobin concentration (Hgb) 3912, and lactic acid concentration 3914 monitored through periodic blood works. These measurements 3910 are fed into an enhanced risk based monitoring system 3940 with treatment evaluation, which, in addition to the previously disclosed physiology observer module 122 and clinical trajectory interpreter module 123, consists of several other modules. A possible treatment complications determination module 3924 receives information from the clinical trajectory interpreter module 123, together with information about the patient demographics 3931 and type of procedure 3932. With the information, this module 3924 queries an outcome database 3943 and receives back information of what the probability of different complications can be given that a) the patient is in particular patient states with particular probabilities; b) the patient is of certain demographics (age, sex, etc); c) the patient has had a particular type of procedure; d) and any combinations thereof of a) b) and c). On the other hand, the outcome database 3943 can be populated by using outcome studies 3990 derived from retrospective studies 3991, randomized clinical trials 3992, institution specific outcomes 3993 determined from previously collected patient data for a particular institution, and any combination thereof of the preceding elements.

When the possible treatment complications determination module 3942 determines the possible complications, it feeds this information back to an enhanced visualization and user interactions module 3941. The enhanced visualization and user interactions module 3941 combines the patient-specific risk based monitoring performed by the physiology observer module 122 and the clinical trajectory interpreter module 122, with the evaluation of probable complication. This affords the system to provide a superior vantage point from which the clinician 3920 can better recognize risks and benefits of treatments such as blood transfusion, and respectively more efficiently and effectively decide whether to administer this treatment 3960 or not.

FIG. 38 shows a non-limiting example set of patient states relevant to blood transfusion that may be used to inform the blood transfusion decision. The states contain information about the dynamics of the hemoglobin (decreasing/stable/increasing) and the hemodynamic compensation for reduced blood oxygen carrying capacity. In uncompensated patients, the hemodynamic auto-regulation mechanisms become incapable of overcoming the depleted blood oxygen carrying capacity, marking the onset of anaerobic metabolism. These seven states can be determined through three internal state

variables: oxygen delivery, hemoglobin, and rate of hemoglobin production/loss. Specifically, when hemoglobin is above 13 mg/dL, it is assumed that there is no Hgb related pathology **4001**. When Hgb is lower than 13 mg/dL, there are six other states, determined through five different attributes. From the oxygen delivery ISV, the system can determine whether the patient is compensated or uncompensated, e.g., it may be assumed that DO₂ above 400 ml/min/m², for ventilated and paralyzed patient, indicates compensation, and below this value uncompensated patient. The other three attributes are determined from the Hgb rate ISV and are stable **4013** and **4014** (the rate is close to zero), increasing **4011** and **4012** (the rate is positive), and decreasing **4015** and **4016** (the rate is negative).

Using the Risk Based Monitoring System with Standardized Clinical Plan

Yet another application of the risk based monitoring system is in applying standardized medical plans. FIG. **39** illustrates one possible embodiment of this application. Specifically, the data from the clinical trajectory interpreter module **123** is fed to a treatment query module **4142**. The treatment query module **4142** queries a treatment plan database **4143** based on the determined patient risks. The treatment plan database **4143** specifies a map between patient risks and treatments. When the database **4143** returns a treatment plan, it is represented to the clinician **3920** by an enhanced visualization and user interactions module **4141** with plan. The clinician **3920** can then make clinical decision **4190** with respect to patient **101**. The user decision, the context under which it was taken, (the calculated patient risks, the estimated ISVs, and other possible patient data at the time of the decision) are then recorded to a decision data base **4144**. The decision database **4144** then can be compared to patient outcomes and utilized in the improvement of the treatment plan.

FIG. **40** illustrates an example application of the risk based monitoring system **4240** combined with a specific type of standardized clinical plan. The particular example considers the medical decision whether to treat the patient with nitric oxide. Nitric oxide is a pulmonary vasodilator and is used to treat high pulmonary vascular resistance and ensuing pulmonary hypertension, which can cause reduced cardiac output. In the example, the medical plan uses the risks calculated by the clinical trajectory interpreter module **123** and stratifies **4230** them into two categories: low risk and high risk. If the risks are low **4201** the recommended decision is not to treat **4202**, respectively, if the patient is classified as being in high risk the recommended decision is to treat **4203**. The provider can then make a decision to either follow the recommendations **4250** or disregard them **4260**. If the provider chooses to disregard the treatment recommendation for a high risk patient, he needs to provide justification **4220**. Likewise, if the provider chooses to treat a low risk patient, he also needs to provide justification **4210**. Justifications **4210** and **4220** in conjunction with patient outcomes may be utilized to refine the risk stratification **4230** and risk-based monitoring system **100**.

FIG. **41** illustrates the example risk stratification that may be employed by the system in the context of Nitric Oxide treatment. Specifically, it assumes that the patient can be in four different states: State 1: Low CO, Normal PVR; State 2: Low CO, High PVR; State 3: Normal CO, High PVR; State 4: Normal CO Normal PVR. A patient being in low risk may be defined as $P(\text{State } 1) < 10\%$ and $P(\text{State } 1) + P(\text{State } 2) < 30\%$. Similarly high risk may be defined as: $P(\text{State } 1) > 10\%$ and $P(\text{State } 1) + P(\text{State } 2) > 30\%$.

Using the Clinical Risk Assessment System in Outpatient Care of Chronic Conditions

Yet another embodiment of the present disclosure allows the clinical trajectory tracking in outpatient care. Outpatient care of chronic conditions involves sporadic patient assessment from intermittent visits, patient self-evaluations, and observations from caregivers. This leads to uncertainties in determining the patient clinical course and the efficiency of the prescribed treatment strategy. To achieve effective patient care management, clinicians must understand and reduce these uncertainties. They have two main decisions at their disposal: 1) schedule visits, prescribe tests, or solicit self-evaluation (or caregiver evaluations) to improve their understanding of the clinical trajectory; and/or 2) prescribe changes of medication or medication dosing to achieve a better trade-off between the likelihood of improvement and possible side-effects. To inform this decision making process, there is a need for processing the available patient information in a way that conveys the clinical trajectory, the uncertainty in its estimation, and the expected effect that different treatment strategies may have on the future evolution of the clinical trajectory.

As a non-limiting example embodiment of the risk based monitoring system to outpatient clinical trajectory tracking, we consider its application to the outpatient care of Attention Deficit and Hyperactivity Disorder (ADHD) of pediatric patients. FIG. **42** illustrates possible patient states that may describe the clinical trajectory of an ADHD patient. They are the same as the ones used by the Clinical global impression-improvement scale: 1) very much worse; 2) much worse; 3) worse; 4) No change; 5) Minimally Improved; 6) Much improved; 7) Very much improved. The Patient State Distribution (PSD) is the set of probabilities that the patient is in any of the seven states, given all available information and observations.

To evaluate the patient state, a clinician may either schedule an office visit for direct examination, or may request a Vanderbilt diagnostic test from family members or teachers (the test is modified depending on the respondent, teacher or parent). FIG. **43** lists the available patient evaluation modalities as **M1**, **M2** and **M3**. Models may be used to map the test questions and answers into the states of the patient. Both the clinical evaluation and the test-based evaluation are associated with uncertainty that prohibits the exact determination in which of the seven states the patient currently resides.

The dynamic model or the patient evolution from state to state may be abstracted by a Dynamic Bayesian Network (DBN) as the one shown in FIG. **44**. In FIG. **44**, the arcs' directions signify statistical dependence, i.e., the connection from "Patient state @t1" **4601** to "M1", signifies the probability density function (PDF): $P(M1|Patient\ state\ @t1)$. Similarly, the depicted DBN illustrates that "Patient state @t2" **4602** (the patient state at a particular time t2), is conditioned on the "Patient state @t1" (the patient state at the previous time increment t1). In the spirit of the present disclosure, this model enables the estimation of the patient state distribution even in the absence of some or all possible measurements, e.g., as illustrated in the figure at time instance t2 when **M1** is missing, and at time instance t3 ("Patient state @ t3" **4603**), when all measurements are missing.

FIG. **45** illustrates an alternative embodiment for two predictions of how the patient state can transition in a single month given medication change or a dosage change. This prediction is performed based on a statistical model derived in the following fashion: Step 1: Isolate a group of patients

from retrospective data which at some point of their treatment have passed through State A and received a change of treatment (Med1 Dose1→Med 2 Dose 2); Step 2: For each patient, set the time instance that this particular event occurred to t_0 ; 3) step 3: for each patient identify what is the patient state at time t_0+1 Month (1M) (or any desired time step unit). 4) calculate the fraction of patients that transition State A→State i where i stands for all seven possible patient states; 5) set the fraction as the probabilities for transition under the particular treatment change.

FIG. 46 shows one possible embodiment and scenario of visualization displaying the patient clinical trajectory and risks. The user interface denotes that the patient is at “no change” state, and that this has been established by three separate measurements: office visit, teacher based Vanderbilt diagnosis, and parent based Vanderbilt diagnosis. The solid line on the screen signifies that a medication has been prescribed to the patient (Medication 1) at week 1 of the treatment.

FIG. 47 shows an evaluation of the patient and the patient trajectory at week 9 at which point the clinical risk assessment system determines a probability density function for the state of the patient for each of the past six weeks. The available measurements at this point are teacher and parent Vanderbilt diagnosis. In the illustrated example, due to a high probability of a deteriorating patient state, the clinician prescribes a change of medication dosing, which is depicted by a dashed red line. Additionally, the user interface shows the side effect reported by the patient—headache.

FIG. 48 shows a follow-up evaluation based on teacher and parent Vanderbilt diagnosis. In the example, the clinician decides a medication change depicted by a hollow line.

FIG. 49 shows consequent evaluation based on all available measurements—office visit, parent and teacher evaluation, which establishes high probability for significant improvement.

FIG. 50 shows yet another follow-up at which point it is established that the patient is most probably stably improved, and has been stably improved between the two evaluations. Note that due to the applied inference, the PDF for the patient trajectory is continuously estimated. However, the precision (the concentration of the PDF) is higher in the presence of a measurement.

FIG. 51 shows a follow-up evaluation of the patient and the patient trajectory in the absence of measurements. Due to the lack of recent observations, the uncertainty is increasing.

FIG. 52 shows the state of this uncertainty given a full patient evaluation (all measurement modalities). The inference engine propagates this uncertainty back in time to produce a more precise estimation of the patient trajectory, which helps the clinician to deduct that the patient is stable.

FIG. 53 illustrates yet another possible visualization from the described system output. It shows possible patient state transitions under changes of treatment plan, e.g., change of medication. It also conveys what possible side-effects can be expected. For every side effect, there are three stages of manifestation—mild, moderate, and severe represented with the three boxes next to each side effect in the figure. The coloring corresponds to the probability of a particular severity manifestation for each particular side-effect, with darker colors indicating higher probability.

Various examples and embodiments consistent with the present disclosure have been described in detailed above. It is to be understood that these examples and embodiments of the present disclosure are provided for exemplary and illustrative purposes only. Various modifications and changes

may be made to the disclosed embodiments by persons skilled in the art without departing from the scope of the present disclosure as defined in the appended claims.

What is claimed is:

1. A risk: based monitoring system for transforming measured data, including heart rate and blood oxygen, of a critical care patient into hidden internal state data that is not directly measurable with sensors, the hidden internal state being monitored by the system, the system comprising:

a processor;

a memory coupled to the processor;

a display operably coupled to the processor;

a data reception module, the data reception module having a set of inputs for a plurality of sensors including at least a heart rate sensor and an SpO2 sensor, the plurality of sensors being coupleable to the critical care patient, wherein the plurality of sensors provide, to the data reception module, data associated with a corresponding plurality of internal state variables m_s , $S=1, \dots, n$, over a series of time steps t_k , $K=0, 1, \dots, Z$ each internal state variable m_s characterizing a parameter physiologically relevant to at least one of a treatment and a condition of the patient;

a physiology observer module, in communication with the data reception module, the physiology observer module configured to

update, via a first and second computer processes, the data provided by the sensors to the data reception module, wherein:

the first computer process generates a conditional likelihood kernel for the internal state variables m_s at time t_k , the conditional likelihood kernel comprising a set of probability density functions, each such probability density function being for a distinct internal state variable m_s at time t_k ; and
the second computer process generates,

using Bayes theorem, posterior predicted conditional probability density functions for each of the internal state variables m_s for the time step t_k given the conditional likelihood kernel for the internal state variables at time t_k and a predicted conditional probability density function of each of the internal state variables for time t_k ; and

a clinical trajectory interpreter module, in communication with the physiology observer module, configured to determine, based on the generated posterior predicted conditional probability density functions of the internal state variables m_s at time step t_k , a set of possible states of a hidden internal state variable to generate a probability value representing the likelihood that the patient's oxygen delivery, which cannot be directly measured, is inadequate; and

a user interaction module configured to:

display, on the display device, a plurality of graphical indicators, each of the plurality of graphical indicators corresponding to one of the states of the set of possible states of the hidden internal state variable, each of the plurality of graphical indicators graphically identifying the probability that the hidden internal state variable is in a corresponding state at a given point in a range of time, the plurality of graphical indicators configured to indicate a hazard level.

2. The system of claim 1, wherein the user interaction module is further configured to:

display, on the display device, a clinical trajectory of the patient based on the conditional probability density

function of the hidden internal state variable over at least some of the series of time steps.

3. The system of claim 1, wherein the physiology observer module compares a newly received measurement associated with an internal state variable m_s at time t_k with a predetermined predicted likelihood of probable measurements given previously received measurements, and does not generate a conditional probability density function for the associated internal state variable m_s , if the newly received measurement is not within the predetermined predicted likelihood of probable measurements for the associated internal state variable m_s .

4. The system of claim 1, further comprising a timeline controller configured to allow a user to dynamically select a plurality of points in time over the series of time steps t_k , the graphical indicators changing dynamically in response to a specification by the user of one of the plurality of points in time to display the evolution of the hidden internal state variable.

5. The system of claim 1, wherein:

the physiology observer module is further configured to generate, at time step t_k , a predicted conditional probability density function for each of the internal state variables m_s for time t_{k+1} based on the posterior predicted probability density functions for each of the internal state variable m_s for the time step t_k .

6. The system of claim 5, wherein the conditional probability density functions for the time step t_{k+1} are generated using the posterior conditional probability density functions for each of the internal state variables m_s from a preceding time step t_k , using the formula:

$$P(ISVs(t_{k+1})|M(t_k)) = \int_{ISVs(t_k)} P(ISVs(t_{k+1})|ISVs(t_k)) P(ISVs(t_k)|M(t_k)) dISVs.$$

7. A method of transforming measured data, including heart rate and blood oxygen, of a critical care patient into hidden internal state data which is not directly measurable with sensors, the method comprising:

providing a plurality of sensors including at least a heart rate sensor and an SpO₂ sensor, the plurality of sensors being configured to be physically attachable with the critical care patient;

attaching the plurality of sensors to the patient; substantially continuously acquiring, by a computer, from the plurality of sensors connected with the patient, physiological data associated with a corresponding plurality of internal state variables m_s , $S=1, \dots, n$, over a series of time steps t_k , $K=0, 1, \dots, Z$;

generating, by the computer, a conditional likelihood kernel for the internal state variables m_s at time t_k , the conditional likelihood kernel comprising a set of probability density functions of the internal state variables m_s for the time step t_k , each of the internal state variables describing a parameter physiologically relevant to at least one of a treatment and a condition of said patient at time step t_k ;

generating, with the computer and using Bayes theorem, posterior predicted conditional probability density functions for the plurality of the internal state variables m_s for the time step t_k given the conditional likelihood kernel for the internal state variables m_s at time t_k and predicted probability density functions of each of the internal state variables m_s for time step t_k ; and

identifying, with the computer, from the generated posterior predicted conditional probability density functions of the internal state variables m_s at time step t_k , a set of possible states of a hidden internal state variable associated with oxygen delivery (DO₂), and generating a probability value representing the likelihood that the patient's oxygen delivery (DO₂) is inadequate, which cannot be directly measured

generating a probability value associated with the hidden internal state; and

substantially continuously displaying a clinical trajectory of the patient on a graphical user interface, the user interface being configured to display the probability of the hidden internal state variable as function of a plurality of time steps.

8. The method of claim 7, wherein the probability value associated with the hidden internal state variable indicates risk that the patient's oxygen delivery is inadequate and the patient may be in a state of shock.

* * * * *

专利名称(译)	用于将患者护理从基于信号的监测转变为基于风险的监测的系统和方法		
公开(公告)号	US10062456	公开(公告)日	2018-08-28
申请号	US14/727696	申请日	2015-06-01
[标]申请(专利权)人(译)	ETIOMETRY		
申请(专利权)人(译)	ETIOMETRY INC.		
当前申请(专利权)人(译)	ETIOMETRY INC.		
[标]发明人	BARONOV DIMITAR V BUTLER EVAN J LOCK JESSE M MCMANUS MICHAEL F		
发明人	BARONOV, DIMITAR V. BUTLER, EVAN J. LOCK, JESSE M. MCMANUS, MICHAEL F.		
IPC分类号	G16H50/30 A61B5/00 G16H50/50 G16H50/20 A61B5/0205 G06Q50/22 A61B5/0402 A61B5/145 A61B5/024		
CPC分类号	G16H50/30 A61B5/0205 A61B5/7275 A61B5/742 G06Q50/22 G16H50/20 G16H50/50 A61B2505/03 A61B5/024 A61B5/0402 A61B5/14532 A61B5/14542 A61B5/14546 G06F19/00		
代理机构(译)	桑斯坦KANN墨菲原料林律师事务所		
优先权	61/727820 2012-11-19 US 61/699492 2012-09-11 US 61/684241 2012-08-17 US 61/620144 2012-04-04 US 61/614861 2012-03-23 US 61/614846 2012-03-23 US 61/774274 2013-03-07 US		
其他公开文献	US20150347704A1		
外部链接	Espacenet		

摘要(译)

针对重症监护患者的基于风险的患者监测系统将来自多个来源的数据组合以评估患者的当前和未来风险，从而使提供者能够查看当前患者风险概况并持续跟踪临床轨迹。系统中的生理学观察者模块利用多个测量来估计许多内部状态变量 (ISV) 的概率密度函数 (PDF) ，其描述与患者治疗和病症相关的生理学的组成部分。系统中的临床轨迹解释器模块利用ISV的估计PDF来识别患者当前可分类的可能患者状态，并且分配患者将处于每个所识别状态中的概率值。患者状态及其概率的组合被定义为患者的临床风险。

