



US 20140206974A1

(19) **United States**
(12) **Patent Application Publication**
Volpe et al.

(10) **Pub. No.: US 2014/0206974 A1**
(43) **Pub. Date: Jul. 24, 2014**

(54) **WEARABLE MONITORING AND TREATMENT DEVICE**

Publication Classification

(71) Applicant: **Zoll Medical Corporation**, Chelmsford, MA (US)

(51) **Int. Cl.**
A61B 5/00 (2006.01)
A61N 1/39 (2006.01)
A61B 5/0205 (2006.01)

(72) Inventors: **Shane S. Volpe**, Saltsburg, PA (US);
Thomas E. Kaib, North Huntingdon, PA (US)

(52) **U.S. Cl.**
CPC *A61B 5/6804* (2013.01); *A61B 5/0205* (2013.01); *A61N 1/3968* (2013.01)
USPC **600/388**; 607/7

(73) Assignee: **ZOLL MEDICAL CORPORATION**, Chelmsford, MA (US)

(21) Appl. No.: **14/161,017**
(22) Filed: **Jan. 22, 2014**

(57) **ABSTRACT**

A wearable therapeutic device to facilitate care of a subject is provided. The wearable therapeutic device can include a garment having a sensing electrode. The garment includes at least one of an inductive element and a capacitive element, and a controller identifies an inductance of the inductive element or a capacitance of the capacitive element, and determines a confidence level of information received from the sensing electrode based on the inductance or the capacitance. The wearable therapeutic device also includes an alarm module coupled with the controller and configured to provide a notification to a subject based on the confidence level.

Related U.S. Application Data

(63) Continuation of application No. 13/598,380, filed on Aug. 29, 2012, now Pat. No. 8,644,925.
(60) Provisional application No. 61/679,143, filed on Aug. 3, 2012, provisional application No. 61/530,261, filed on Sep. 1, 2011.

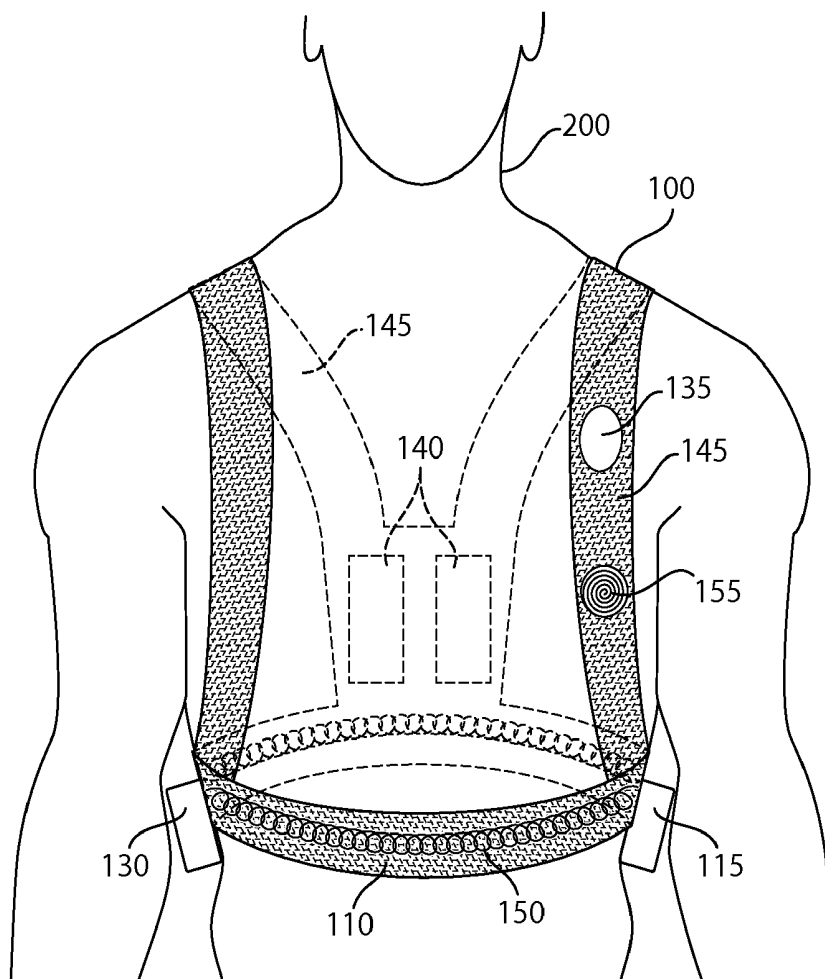

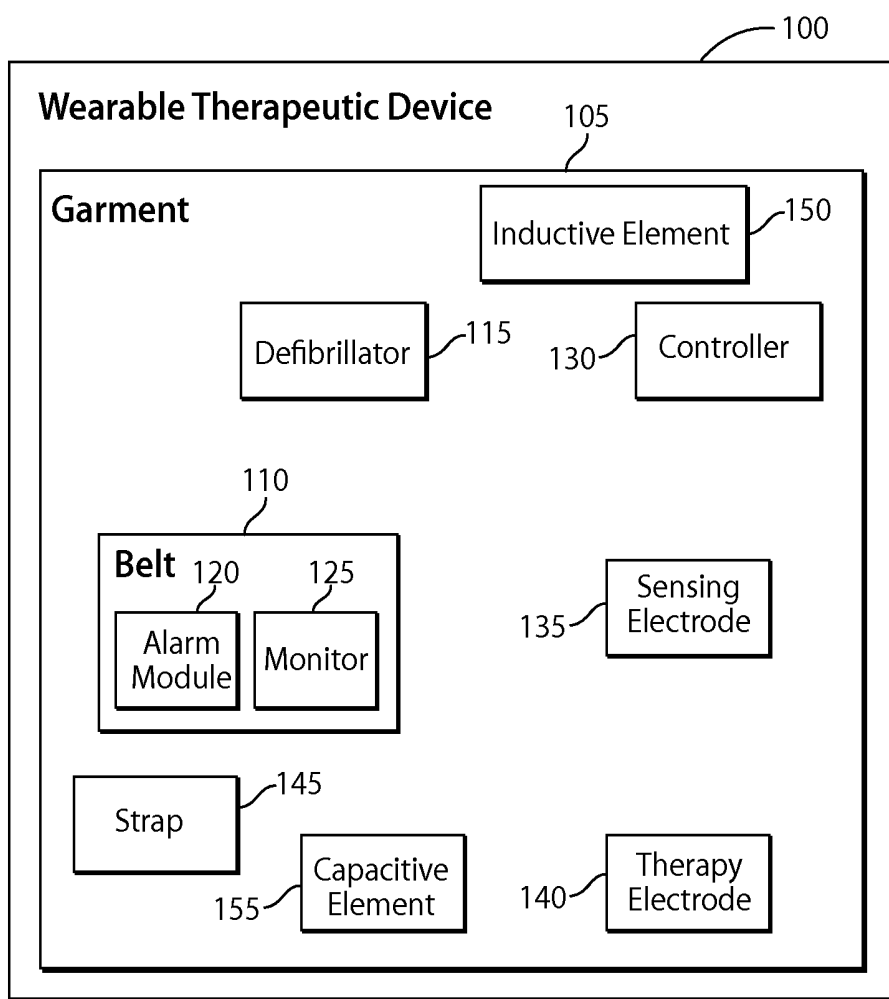

Fig. 1

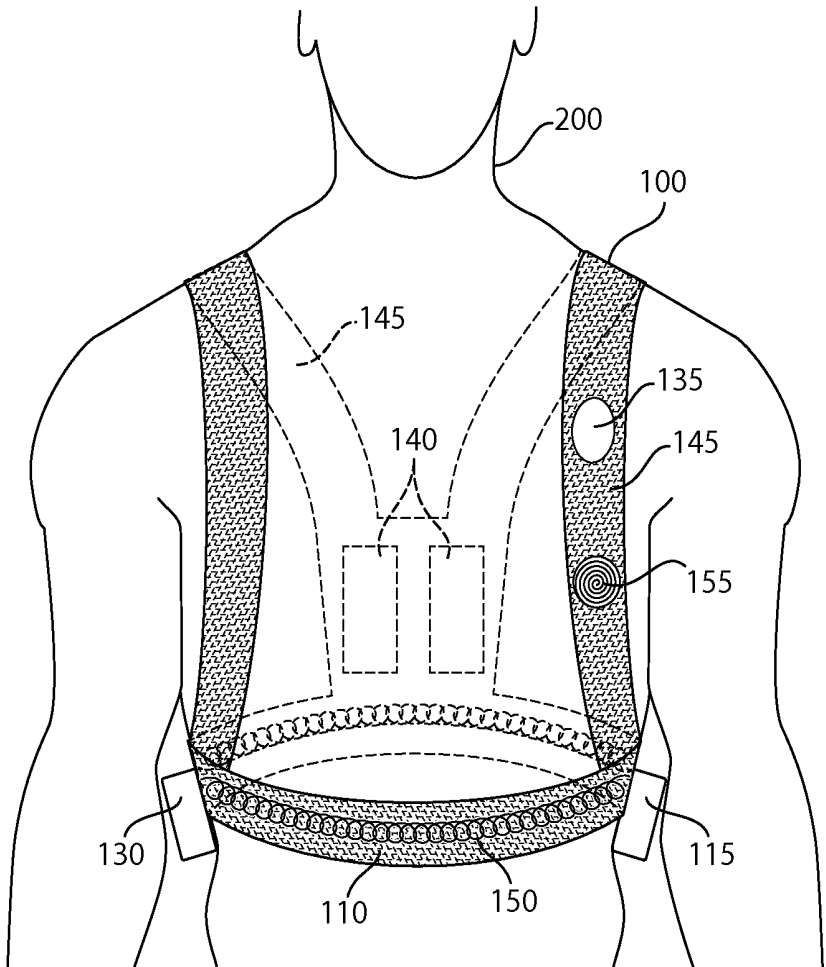

Fig. 2

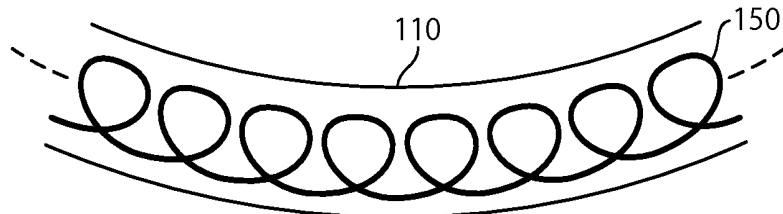

Fig. 3A

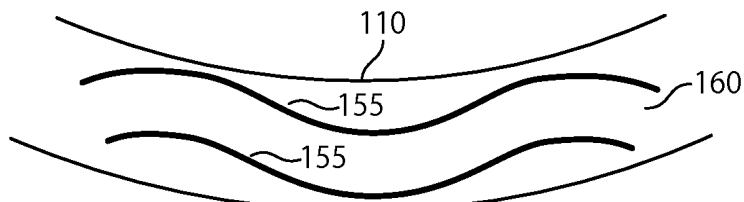

Fig. 3B

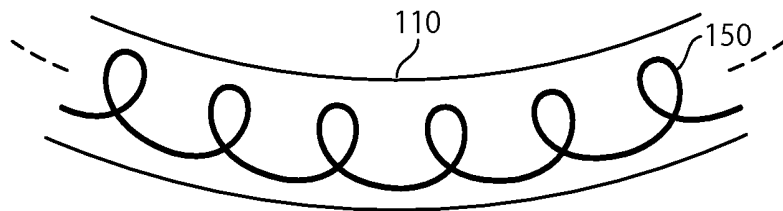

Fig. 4A

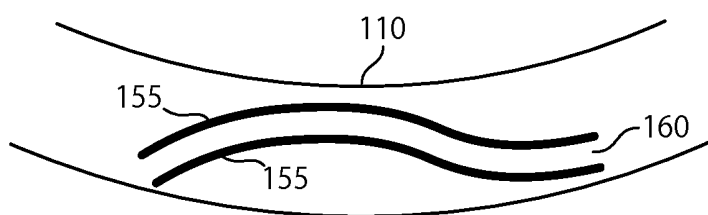

Fig. 4B

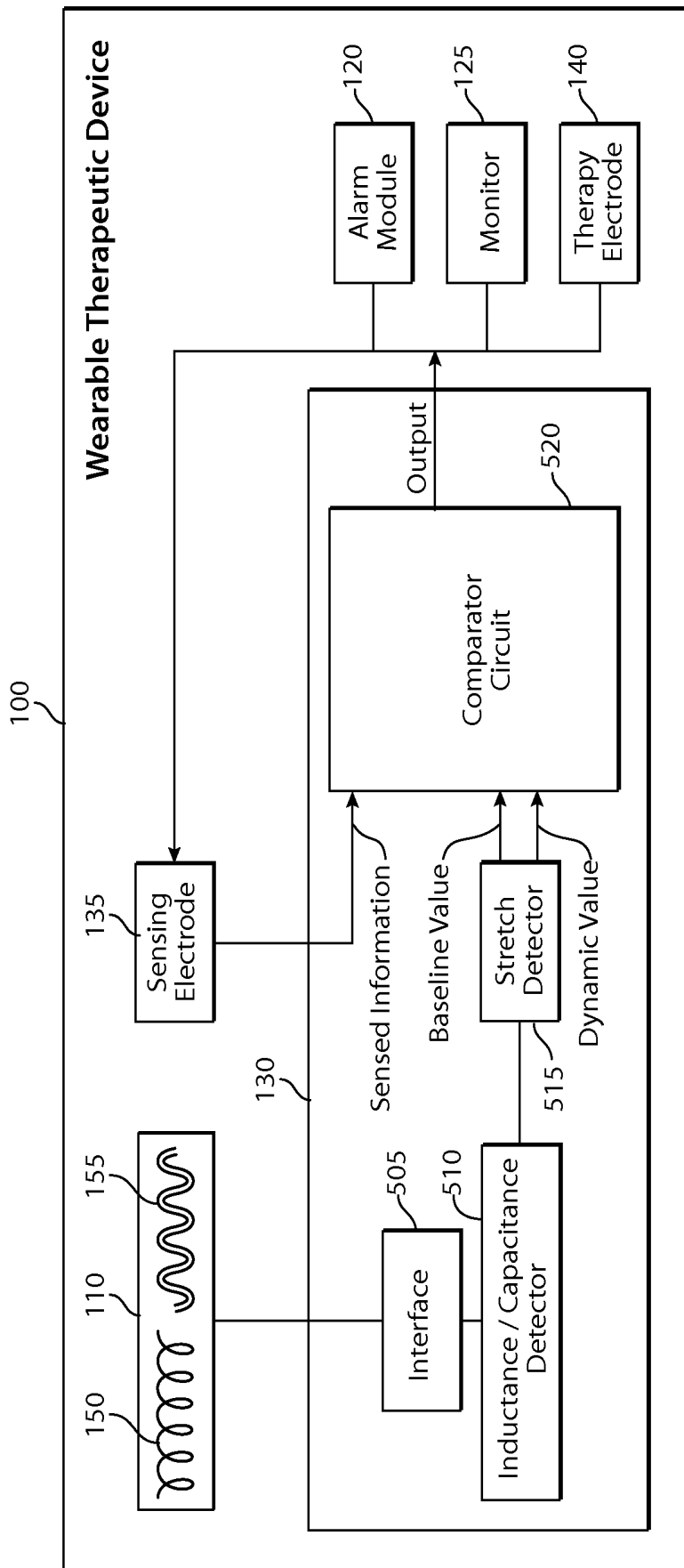

Fig. 5

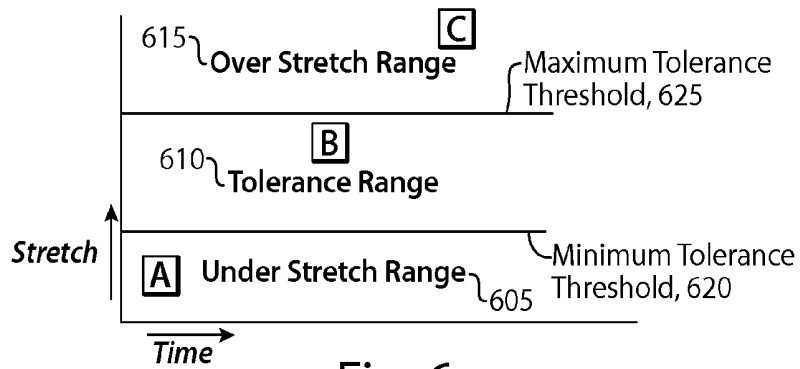

Fig. 6

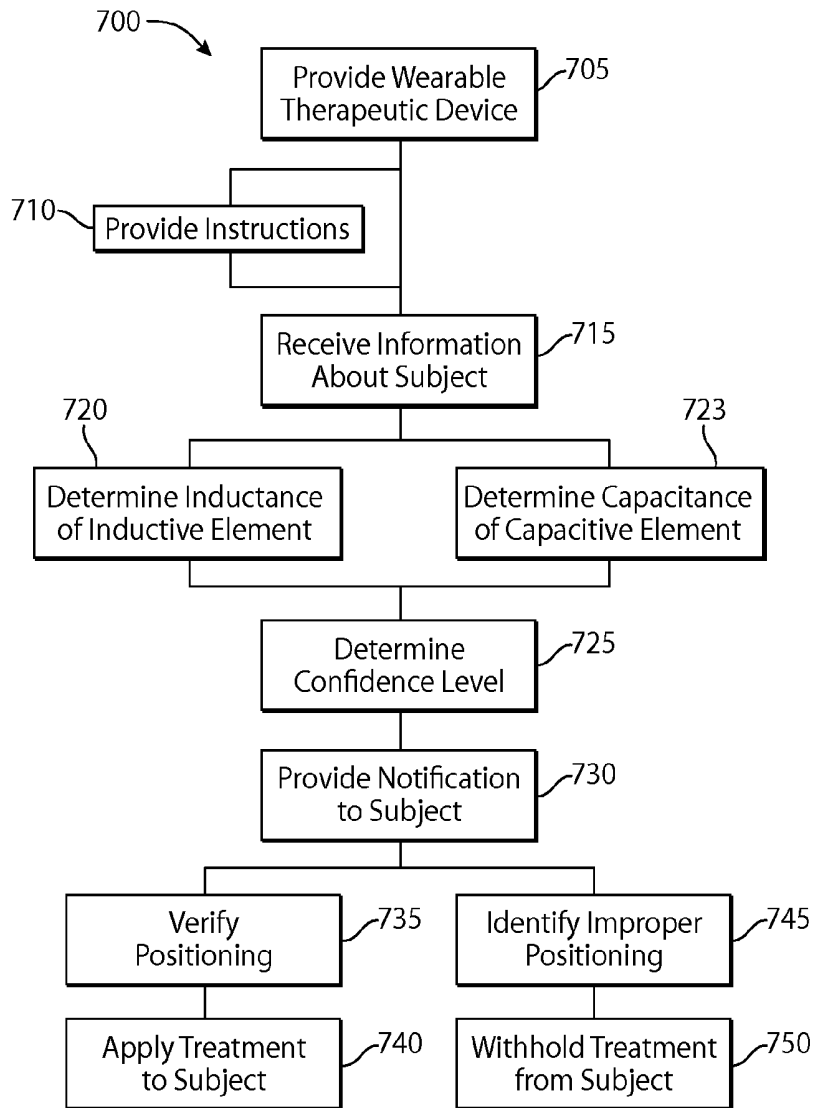

Fig. 7

WEARABLE MONITORING AND TREATMENT DEVICE

CROSS REFERENCE TO RELATED APPLICATIONS

[0001] This application claims priority under 35 U.S.C. §120 to U.S. application Ser. No. 13/598,380, titled "WEARABLE MONITORING AND TREATMENT DEVICE", filed Aug. 29, 2012, which claims priority under 35 U.S.C. §119(e) to U.S. Provisional Application Ser. No. 61/530,261 titled "WEARABLE MONITORING AND TREATMENT DEVICE," filed Sep. 1, 2011, and to U.S. Provisional Application Ser. No. 61/679,143 titled "WEARABLE MONITORING AND TREATMENT DEVICE," filed Aug. 3, 2012, each of which is incorporated herein by reference in its entirety.

BACKGROUND OF THE INVENTION

[0002] 1. Field of the Invention

[0003] At least one embodiment of the present invention relates generally to a wearable therapeutic device, and more specifically, to a wearable therapeutic device configured to monitor or treat a subject.

[0004] 2. Discussion of Related Art

[0005] Cardiac arrest and other health ailments are a major cause of death worldwide. Various resuscitation efforts aim to maintain the body's circulatory and respiratory systems during cardiac arrest in an attempt to save the life of the victim. The sooner these resuscitation efforts begin, the better the victim's chances of survival. Health care professionals also attempt to detect and prevent conditions conducive to cardiac ailments by treating patients with drugs or by suggesting lifestyle changes. These efforts are expensive and have a limited success rate, and cardiac arrest, among other conditions, continues to claim the lives of victims.

SUMMARY OF THE INVENTION

[0006] Aspects and embodiments of the present invention are directed to a wearable therapeutic device that is configured to be worn by a subject. Electrodes sense information about the subject's health, and can apply treatment to the subject. At least one inductive or capacitive element is included in a portion of the therapeutic device. Characteristics of the inductive or capacitive element, such as its radius or shape, change when the wearable therapeutic device expands, stretches, or otherwise changes shape, which changes the inductance of the inductive element or the capacitance of the capacitive element. Based at least in part on changes in the inductance or the capacitance as the wearable therapeutic device changes shape, the wearable therapeutic device can provide notifications to the subject regarding arrhythmias, cardiac events, the condition of the wearable therapeutic device, and the positioning of electrodes or other wearable therapeutic device components relative to the subject.

[0007] At least one aspect is directed to a wearable therapeutic device. The wearable therapeutic device includes a garment that is configured to include a sensing electrode. At least one of an inductive element and a capacitive element is included in at least part of the garment, and a controller is configured to determine a confidence level of information received from the sensing electrode based on at least one of an inductance of the inductive element and a capacitance of the capacitive element.

[0008] At least one other aspect is directed to a method of facilitating care of a subject. The method provides a wearable therapeutic device configured to include a sensing electrode, and receives, from the sensing electrode, information about the subject. The method also determines inductance of an inductive element or capacitance of a capacitive element included in the wearable therapeutic device, and determines a confidence level of the information about the subject based on the inductance or the capacitance.

[0009] At least one other aspect is directed to a non-transitory computer readable medium having stored thereon sequences of instruction. The instructions include instructions that will cause a processor to receive, from a sensing electrode of a wearable therapeutic device, information about a subject, and to determine inductance of an inductive element or capacitance of a capacitive element included in the wearable therapeutic device. The instructions also cause the processor to determine a confidence level of the information about the subject based on the inductance or the capacitance.

[0010] In some embodiments, the wearable therapeutic device includes an alarm module coupled with the controller and configured to provide a notification to a subject based on the confidence level. In one embodiment, the controller determines at least one of the inductance of the inductive element or the capacitance of the capacitive element. Based on the confidence level, in some embodiments a notification to the subject is provided regarding at least one of a diagnosis and information about the wearable therapeutic device.

[0011] In various embodiments, a therapy electrode is included in the garment. The controller can determine information regarding positioning of the therapy electrode or the sensing electrode based on the inductance of the inductive element or the capacitance of the capacitive element. A defibrillator is coupled to the therapy electrode and together with the therapy electrode can apply treatment to the subject, based on the confidence level of the information received from the sensing electrode. The controller can identify, based on the inductance or the capacitance, an expansion of the garment, and can determine, based on the expansion, that positioning of at least one of the sensing electrode and the therapy electrode is outside a tolerance range. In one embodiment, the controller can withhold treatment of the subject based on the positioning of at least one of the sensing electrode and the therapy electrode. The controller can determine, based on the expansion of the garment, respiratory function of the subject. In one embodiment, the alarm module can provide instructions to the subject regarding positioning of the sensing electrode or the therapy electrode based on the expansion of the garment. The controller can determine a second inductance value of the inductive element and can determine the confidence level based on a differential between the first inductance value and the second inductance value. The controller can also determine a second capacitance value of the capacitive element and can determine the confidence level based on a differential between the first capacitance value and the second capacitance value.

[0012] In some embodiments, a belt or a strap is configured to include at least one of the inductive element and the capacitive element, and at least one of the sensing electrode, the controller, the alarm module, a therapy electrode, and a defibrillator. In one embodiment in which the belt or strap includes an inductive element, the belt can include a core, wherein the inductive element is coiled around the core. The notification can indicate that the garment is properly posi-

tioned about the subject, too loose about the subject, too tight about the subject, soiled, or expired.

[0013] In some embodiments, the information received from the sensing electrode includes electrocardiograph information of the subject, and the confidence level can be determined based on the expansion of the garment and the electrocardiograph information of the subject. An arrhythmic cardiac event can be identified based on the confidence level, positioning of the therapy electrode can be verified, and the therapy electrode can be instructed to apply treatment to the subject. The controller can determine the confidence level based on the electrocardiograph information of the subject. The controller can also determine an absence of an arrhythmic cardiac event based on the inductance of the inductive element or the capacitance of the capacitive element and the electrocardiograph information of the subject.

[0014] In some embodiments, the wearable therapeutic device includes a therapy electrode and a defibrillator. The positioning of the sensing electrode or the therapy electrode can be verified based on the inductance of the inductive element or the capacitance of the capacitive element. Treatment can be applied to the subject using the therapy electrode and the defibrillator. The inductive element or the capacitive element can be included in a belt of the wearable therapeutic device, and an expansion of a circumference of the belt can be identified based on the inductance of the inductive element or the capacitance of the capacitive element. The confidence level of the information about the subject can be determined based on the expansion of the circumference of the belt. In one embodiment, the inductive element or the capacitive element is in a garment of the wearable therapeutic device, and an expansion of the garment can be identified based on the inductance of the inductive element or the capacitance of the capacitive element. Instructions can be provided to the subject regarding positioning of the sensing electrode or the therapy electrode based on the expansion of the garment.

[0015] In various embodiments, the diagnosis includes a diagnosis of an arrhythmic cardiac event. Electrocardiograph information of the subject can be sensed, and an expansion of a portion of the wearable therapeutic device that includes at least one of the inductive element and the capacitive element can be identified. The confidence level can be determined based on the expansion of the portion of the wearable therapeutic device and the electrocardiograph information of the subject, and the arrhythmic cardiac event can be identified based on the confidence level. An absence of an arrhythmic cardiac event can also be determined based on the confidence level.

[0016] In one embodiment, improper positioning of the sensing electrode or the therapy electrode can be identified based on the expansion. An absence of an arrhythmic cardiac event can be identified based on the improper positioning of the sensing electrode. In one embodiment, treatment of the subject can be withheld based on the improper positioning of the sensing electrode or the therapy electrode.

[0017] In some embodiments, instructions to operate the wearable therapeutic device can be provided. In one embodiment, instructions can cause a processor to receive sensed electrocardiograph information of the subject, and identify an expansion of a portion of the wearable therapeutic device that includes the inductive element or the capacitive element. The instructions can cause the processor to determine the confidence level based on the expansion of the portion of the wearable therapeutic device and the electrocardiograph infor-

mation of the subject, and to identify an arrhythmic cardiac event based on the confidence level. The instructions can cause the processor to control the therapy electrode of the wearable therapeutic device to apply treatment to the subject. In one embodiment, the instructions can cause the processor to determine an absence of an arrhythmic cardiac event based on the confidence level.

[0018] Other aspects and embodiments are discussed in detail below. The foregoing information and the following detailed description include illustrative examples of various aspects and embodiments, and are intended to provide an overview or framework for understanding the nature and character of the claimed aspects and embodiments. The drawings provide illustration and a further understanding of the various aspects and embodiments, and are incorporated in and constitute a part of this specification. The drawings, together with the remainder of the specification, serve to describe and explain the claimed aspects and embodiments.

BRIEF DESCRIPTION OF THE DRAWINGS

[0019] The accompanying drawings are not intended to be drawn to scale. In the drawings, each identical or nearly identical component that is illustrated in various figures is represented by a like numeral. For purposes of clarity, not every component may be labeled in every drawing. In the drawings:

[0020] FIG. 1 is a block diagram depicting a wearable therapeutic device in accordance with an embodiment;

[0021] FIG. 2 is a schematic diagram depicting a wearable therapeutic device in accordance with an embodiment;

[0022] FIG. 3A is a schematic diagram depicting a portion of a wearable therapeutic device that includes an inductive element in an unstretched position in accordance with an embodiment;

[0023] FIG. 3B is a schematic diagram depicting a portion of a wearable therapeutic device that includes a capacitive element in an unstretched position in accordance with an embodiment;

[0024] FIG. 4A is a schematic diagram depicting a portion of a wearable therapeutic device that includes an inductive element in a stretched position in accordance with an embodiment;

[0025] FIG. 4B is a schematic diagram depicting a portion of a wearable therapeutic device that includes a capacitive element in a stretched position in accordance with an embodiment;

[0026] FIG. 5 is a functional block diagram depicting a wearable therapeutic device controller in accordance with an embodiment;

[0027] FIG. 6 is a graph depicting tolerance stretch ranges of a wearable therapeutic device in accordance with an embodiment; and

[0028] FIG. 7 is a flow chart depicting a method of facilitating care of a subject in accordance with an embodiment.

DETAILED DESCRIPTION

[0029] The systems and methods described herein are not limited in their application to the details of construction and the arrangement of components set forth in the description or illustrated in the drawings. The systems and methods described herein are capable of other embodiments and of being practiced or of being carried out in various ways. Also, the phraseology and terminology used herein is for the pur-

pose of description and should not be regarded as limiting. The use of “including” “comprising” “having” “containing” “involving” and variations thereof herein, is meant to encompass the items listed thereafter, equivalents thereof, and additional items, as well as alternate embodiments consisting of the items listed thereafter exclusively.

[0030] Various aspects and embodiments are directed to a wearable therapeutic device. The wearable therapeutic device includes at least a sensing electrode. An inductive or capacitive element is integrated into the wearable therapeutic device. Inductance of the inductive element or capacitance of the capacitive element varies as these elements change shape, for example due to stretching with use of the wearable therapeutic device. A controller determines the inductance of the inductive element or capacitance of the capacitive element and together with an alarm module or other interface or output, can provide a notification to the subject regarding, for example, the wearable treatment device, a diagnosis, or a treatment regimen.

[0031] FIG. 1 is a block diagram of a wearable therapeutic device **100** in accordance with an embodiment. In one embodiment, the wearable therapeutic device **100** can be a wearable cardioverter defibrillator as described in commonly owned U.S. patent application Ser. No. 13/109,079, titled “Wearable Therapeutic Device,” filed on May 17, 2011, which is incorporated by reference herein in its entirety.

[0032] Wearable therapeutic device **100** can include at least one garment **105** in the shape of a vest or shirt. Garment **105** may also include at least one belt **110**. Belt **110** may be worn about a subject’s waist, at a higher location about the subject’s chest, or at other locations between the subject’s waist and shoulders. Components of wearable therapeutic device **100**, including garment **105**, can be worn under, over, or partially under and partially over a subject’s clothes.

[0033] In one embodiment, wearable therapeutic device **100** includes at least one of the following elements: garment **105**, belt **110**, defibrillator **115**, alarm module **120**, monitor **125**, controller **130**, sensing electrode **135**, therapy electrode **140**, strap **145**, inductive element **150**, and capacitive element **155**. In one embodiment, at least one of defibrillator **115**, alarm module **120**, monitor **125**, controller **130**, sensing electrode **135**, therapy electrode **140**, inductive element **150**, and capacitive element **155** are included in or attached to belt **110** or strap **145**. For example, wearable therapeutic device **100** components can be fitted into open or closed pockets of belt **110** or strap **145**, or otherwise attached to these elements via buckles, hook and loop fasteners, holsters, loops, or sleeves that form part of belt **110** or strap **145**. These elements may also be integrated into belt **110** or strap **145**, and these elements may be a permanent part of belt **110** or strap **145**, or releasable from belt **110** or strap **145**. Garment **105** may include a series of belts **110** or straps **145**, and need not constitute an article of clothing. Wearable therapeutic device **100** may include one, more than one, or all of the above mentioned elements, as well as additional elements such as at least one power supply to provide power to controller **130**, defibrillator **115**, alarm module **120**, monitor **125**, sensing electrodes **135**, or therapy electrodes **140**.

[0034] Defibrillator **115** can be included as part of wearable therapeutic device **100**. For example, defibrillator **115** can be included in garment **105**, attached to strap **145**, or disposed in belt **110**. In one embodiment, defibrillator **115** is electrically coupled to therapy electrode **140**. Defibrillator **115** can be an external defibrillator. Wearable therapeutic device **100** may

include at least one receptacle having a conductive fluid encapsulated therein and housed in garment **105**. For example, the receptacle can be disposed in belt **110** or strap **145**, proximate to at least one of sensing electrode **135** and therapy electrode **140**. In one embodiment, electrodes **135** and **140** are dry electrodes. Controller **130** or defibrillator **115** can release the conductive fluid from the receptacles to enhance an electrical connection between sensing electrode **135** or therapy electrode **140** and a subject wearing wearable therapeutic device **100** to, for example, sense electrocardiograph information about the subject or to apply treatment to the subject. The receptacles can be replaced after their conductive fluid has been released, or upon their expiration. When a shock is applied, therapy electrodes **140**, the subject’s body, and defibrillator **115** form at least part of a current path. One embodiment includes at least one sensing electrode **135**, one therapy electrode **140** disposed in front of the subject, e.g., proximate to the subject’s chest, and two therapy electrodes **140** disposed in back of the subject, e.g. proximate to the subject’s back.

[0035] Garment **105** can hold electrodes **135** and **140** in position, for example against the subject’s skin around the subject’s torso. Clothes or other material may be present between garment **105** and the subject’s skin. When positioned against the subject, sensing electrodes **135** can sense electrocardiogram signals used by controller **130** to monitor the subject’s cardiac activity. When controller **130** identifies an arrhythmia or other cardiac event, therapy electrodes **140**, when positioned against the subject can deliver defibrillating energy to the subject to convert the arrhythmia to a normal sinus rhythm.

[0036] In one embodiment, sensing electrodes **135** and therapy electrodes **140** are securely positioned against the subject’s body in order for sensing electrodes **135** to sense cardiac, respiratory, or other information about the subject; and for therapy electrodes **140** to apply treatment to the subject. For example, sensing electrode **135** can include electrocardiogram electrodes that directly or indirectly (e.g., via clothes, a conductive protective barrier, or a conductive fluid) contact the subject’s skin to sense an electrocardiogram signal with minimal artifacts. Further, therapy electrode **140** can directly or indirectly contact the subject’s skin to reduce impedance between therapy electrode **140** and the subject’s skin and to efficiently deliver defibrillating energy to the subject, without causing burns, blisters, inflammation, or other damage to the subject’s skin. In one embodiment, conductive fluid is released from replaceable receptacles that are disposed in wearable therapeutic device **100** to contact the subject’s skin and surfaces of sensing electrode **135** or therapy electrode **140** to reduce impedance and improve the quality of sensed electrocardiogram signals.

[0037] In one embodiment, controller **130** includes at least one processor as described in commonly owned U.S. patent application Ser. No. 12/833,096, titled “System and Method for Conserving Power in a Medical Device,” filed on Jul. 9, 2010 (hereinafter “the ’096 application”), which is incorporated by reference herein in its entirety. The ’096 application generally describes a processing architecture configured to conserve energy and which may be used in a wearable therapeutic device, such as a wearable defibrillator. Controller **130** can monitor a subject’s condition and control wearable therapeutic device **100** operations. For example, sensing electrode **135** can sense electrical activity of the subject’s heart signals, and controller **130** can provide these signals for display as an

electrocardiograph on monitor **125**. When an arrhythmic event or other form of cardiac distress is detected, controller **130** can instruct alarm module **120** to provide a warning that the subject wearing wearable therapeutic device **100** is in danger of, or is experiencing, for example, cardiac arrest. Where the subject does not respond to the warning, the controller **130** can direct the defibrillator **115** to apply an electric shock to the body of the subject in an effort to restore a normal rhythm. Information concerning the subject's condition, such as the subject's electrocardiogram (ECG), information relating to detected arrhythmic events, information pertaining to any defibrillation shocks applied to the subject, and other information can be stored in memory units associated with controller **130** for analysis by a doctor, rescuer, the subject, or a health care provider.

[0038] In one embodiment, the functionality of defibrillator **115** may be performed at least partially in software executed by the at least one processor of the controller **130** in a manner such as described in the '096 application. In other embodiments, the functionality of defibrillator **115** may be implemented in a Field Programmable Gate Array (FPGA), one or more Programmable Logic Devices (PLDs), a Complex PLD (CPLD), a custom Application Specific Integrated Circuit (ASIC), or a dedicated processor operating under the control of the at least one processor of the controller **130**. It should be appreciated that other implementations may be used, as the present invention is not limited to any particular implementation.

[0039] In one embodiment, alarm module **120** provides an alarm or warning that indicates that the subject will receive an electric shock from defibrillator **115** and at least one therapy electrode **140** when the subject is wearing wearable therapeutic device **100**, with therapy electrode **140** disposed proximate to the subject's body. This alarm or warning may be audio, visual, haptic (e.g., vibrating alarm module **120**) or combinations thereof. Treatment in the form of an electric shock can be applied to the subject wearing wearable therapeutic device **100** unless the subject takes some action to prevent defibrillator **115** from applying the shock. For example, alarm module **120** or monitor **125** may include an interface having at least one button or touch screen. In this example, the subject can depress a button. This indicates that the subject is conscious. In this example, the shock will not be applied while the subject depresses the button for a sufficient amount of time, or until controller **130** determines that the electrical heart activity of the subject, detected for example by sensing electrode **135**, has returned to normal. Continuing with this example, if the subject loses consciousness, the subject will release the buttons and defibrillator **115** can apply a shock via at least one therapy electrode **140**.

[0040] Alarm module **120** can be part of monitor **125** or a separate element of wearable therapeutic device **100**. In one embodiment, alarm module **120** alerts and instructs the subject to take corrective action to reposition sensing electrode **135** or therapy electrode **140**. For example, alarm module **120** can instruct the subject to tighten belt **110** to position or reposition sensing electrode **135** or therapy electrode **140**. This can reduce, for example, signal interference at sensing electrode **135** by positioning this electrode proximate to the subject's skin, or proximate to a desired portion of the subject's body where a stronger electrocardiogram signal can be sensed. This can also reduce impedance between therapy electrode **140** and the subject, or between a plurality of

therapy electrodes **140**, allowing for more efficient and effective application of therapy to the subject.

[0041] In one embodiment, at least one sensing electrode **135** and at least one therapy electrode **140** are permanent components of wearable therapeutic device **100**. Electrodes **135** and **140** can be housed anywhere in garment **105**. For example, at least one sensing electrode **135** can be integral to garment **105** and disposed proximate to the subject's chest or abdomen when the subject is wearing wearable therapeutic device **100**. At least one therapy electrode **140** can be integral to garment **105** and disposed proximate to the subject's back when the subject is wearing wearable therapeutic device **100**. Sensing electrode **135** and therapy electrode **140** may include conductive surfaces such as a metal plate or foil in a generally circular, ovoid, or quadrilateral shape.

[0042] In one embodiment, sensing electrode **135** and therapy electrode **140** include conductive thread woven, sewn, or embroidered into wearable treatment device **100**. The conductive thread can provide connections between any of electrodes **135** and **140**, and a battery powered defibrillator **115**. In one embodiment, sensing electrode **135** senses the subject's electrocardiogram signals and provides that signal to defibrillator **115**.

[0043] The conductive thread that may form at least part of sensing electrode **135** and therapy electrode **140** can have various patterns to achieve proper electrocardiogram sensing and to administer therapy. In one embodiment, sensing electrode **135** or therapy electrode **140** include only conductive stitching. Sensing electrode **135** or therapy electrode **140** may also include conductive stitching that holds a metal foil or other conductive component in place in garment **105**, so that sensing electrode **135** or therapy electrode **140** includes both conductive thread and a conductive foil.

[0044] The conductive thread can be sewn into garment **105** (e.g., belt **110**) in a zigzag pattern that can stretch as part of garment **105**. This stretchable conductive thread stitching connects sensing electrode **135** and therapy electrode **140** with controller **130** or other garment **105** components (e.g., defibrillator **115**) in the absence of additional wires. In one embodiment, the conductive thread (e.g., conductive wiring) can face toward or away from the subject's skin.

[0045] In one embodiment, garment **105** includes breathable fabric, or a material that wicks heat away from the subject's body. This can reduce heat buildup between the subject's skin and sensing electrode **135** or therapy electrode **140**. Using conductive thread for electrodes **135** or **140** reduces heat buildup in one embodiment when electrodes **135** or **140** are formed from conductive thread in the absence of any further metallic or conductive foil. In one embodiment, sensing electrode **135** or therapy electrode **140** are made of perforated materials that allow air flow proximate to the subject's skin. This air flow can dry sweat or other fluid from the skin to avoid rashes and other skin problems as a result of heat buildup and irritation.

[0046] Garment **105** can be adjusted to snugly fit the subject. For example, portions of garment **105** that include sensing electrode **135** and therapy electrode **140** can be substantially flush against the subject, e.g., electrodes **135** and **140** remain substantially in a fixed position against the subject when the subject is moving about as part of a daily routine, or undertaking moderate physical activity. Clothing may be present between garment **105** and the subject. Where clothing is present between garment **105** and the subject, the clothing preferably includes openings to permit electrodes **135** to

directly contact the subject's skin. Alarm module 120 can alert the subject when wearable therapeutic device 100 is not sufficiently tight and snug about the subject. For example, alarm module 120 can notify the subject when the portion of garment 105 that includes sensing electrode 135 or therapy electrode 140 is not flush with or fairly tightly pressed against the patient in a substantially fixed position.

[0047] Garment 105 or its components such as belt 110 or strap 145 may expand or stretch with time or repeated use, which can loosen the fit and positioning of sensing electrode 135 and therapy electrode 140 proximate to the subject. Further, the subject's respiration will typically result in periodic expansion of garment 105. Controller 130 can detect this expansion and where appropriate, instruct the subject to reposition sensing electrode 135 or therapy electrode 140, for example by tightening garment 105.

[0048] To identify garment 105 stretching, in one embodiment wearable therapeutic device 100 includes at least one inductive element 150. Inductive element 150 includes a metallic or other conductive material, such as a conductive wire or thread that is configured in a coiled pattern (e.g., spring shaped) that includes a plurality of coils (e.g., windings or turns) with a substantially similar radius. In one embodiment, inductive element 150 includes at least one coiled conductive element that acts as an inductor when alternating current is applied to it. In some embodiments, a magnetic core may be disposed within the plurality of coils.

[0049] In an alternate embodiment, inductive element 150 may be formed from a conductive wire or thread that is configured in a serpentine pattern similar in shape to that shown in FIGS. 3B and 4B that includes a plurality of serpentine turns of similar dimension.

[0050] In another embodiment, wearable therapeutic device 100 includes at least one capacitive element 155 to identify garment 105 stretching. In one embodiment, the at least one capacitive element 155 can be formed from a conductive material such as a pair of wires with a round circumference or with at least one flat side, configured in parallel with each other in a serpentine or coiled pattern in garment 105. A space may be present between two capacitive elements 155, and may be occupied by an insulator, dielectric material, or air so that the two capacitive elements 155 act as a capacitor when supplied with power.

[0051] Inductive element 150 and capacitive element 155 may be shielded, jacketed, or insulated, and can connect to a power supply of wearable therapeutic device 100. This power supply can also be associated with defibrillator 115, controller 130, alarm module 120, or monitor 125. In one embodiment, wearable therapeutic device 100 can include both inductive element 150 and capacitive element 155.

[0052] Inductive element 150 and capacitive element 155 can stretch or expand together with garment 105. For example, inductive element 150 can include wire configured in a serpentine pattern or a wire configured in a coiled pattern whose radius and the number of turns or coils over a defined length change when stretched, which changes the inductance of inductive element 150. When capacitive element 155 is stretched together with garment 105, the capacitance changes, for example reducing when stretched. In one embodiment, controller 130 detects the inductance of inductive element 150 or capacitance of capacitive elements 155 to determine if sensing electrode 135 or therapy electrode 140 is properly or improperly positioned. For example, inductance or capacitance outside of a tolerance range or above or below

a threshold value can indicate that sensing electrode 135 or therapy electrode 140 is improperly positioned or tensioned due to garment 105 stretching, and inductance or capacitance within a tolerance range or above or below a threshold value can indicate that no or minimal stretching of garment 105 has occurred and that electrodes 135 and 140 are properly positioned about the subject.

[0053] In one embodiment, sensing electrodes 135 or therapy electrodes 140 are properly positioned when they are adequately pressured by garment 105 to be firmly pressed against the subject so that they are held in a substantially fixed position to sense the subject's condition or deliver treatment. Properly positioned sensing electrodes 135 and therapy electrodes 140 are generally held by garment 105 in a fixed position with minimal movement and in contact the subject's skin. Conductive fluid or other materials may be present between sensing electrodes 135 or therapy electrodes 140 and the subject's skin.

[0054] Alarm module 120, which may include an interface and be part of monitor 125, can indicate both proper and improper positioning of electrodes 135 and 140, and can instruct the user to take corrective action, for example when the determined inductance of inductive element 150 or capacitance of capacitive element 155 indicates that stretching of garment 105 has displaced electrodes 135 or 140 so they are improperly positioned.

[0055] FIG. 2 is a schematic diagram depicting subject 200 wearing wearable therapeutic device 100 in accordance with an embodiment. In the example of FIG. 2, inductive element 150 is included in belt 110 and extends circumferentially around subject 200, and capacitive element 155 is included in strap 145 in a tightly wrapped pattern configured to stretch with strap 145. Other configurations are possible. For example, inductive element 150 can be included in strap 145 and capacitive element 155 can be included in belt 110. Further, inductive element 150 and capacitive element 155 can extend across or be disposed in any portion of garment 105, and need not be circumferential as illustrated in FIG. 2.

[0056] Wearable therapeutic device 100 can also include more than one inductive element 150 and more than one capacitive element 155, and need not include both types of elements. For example, a first inductive element 150 or capacitive element 155 can be included in a portion of belt 110 and a second inductive element 150 or capacitive element 155 can be included in a portion of strap 145 on one side of the subject, without extending around the subject. In one embodiment, a single inductive element 150 or capacitive element 155 is included in portions of both belt 110 and strap 145. Wearable therapeutic device 100 can include other elements not illustrated in FIG. 2, such as additional straps across the chest of subject 200 that can include inductive element 150 or capacitive element 155.

[0057] In one embodiment, controller 130 determines the inductance of inductive element 150, or the capacitance of capacitive element 155. Based on the determined inductance or capacitance, controller 130 can instruct alarm module 120 to provide a notification to subject 200. The notification can instruct subject 200 to loosen or tighten at least a portion of garment 105 (e.g., belt 110). The notification can also indicate that an arrhythmic cardiac event has been detected, based on information from sensing electrode 135.

[0058] FIG. 3A depicts a portion of wearable therapeutic device 100 that includes inductive element 150 in an unstretched position, and FIG. 4A depicts a portion of wear-

able therapeutic device **100** that includes inductive element **150** in a stretched position. In one embodiment, controller **130** can determine differences between the inductance of inductive element **150** in the unstretched position of FIG. **3A** and the stretched position of FIG. **4A**. For example, wearable therapeutic device **100** may have the unstretched configuration of FIG. **3A** when it is not being worn by the subject, or if it is too large for the subject; and may have the stretched configuration of FIG. **4A** if it is too small for the subject or is currently being worn by the subject.

[0059] FIG. **3B** depicts a portion of wearable therapeutic device **100** that includes capacitive elements **155** in an unstretched position, and FIG. **4B** depicts a portion of wearable therapeutic device **100** that includes capacitive elements **155** in a stretched position. An insulator, space, gap, or dielectric **160** may be present between the two capacitive elements **155**. In one embodiment, controller **130** can determine differences between the capacitance of capacitive element **155** in the unstretched position of FIG. **3B** and the stretched position of FIG. **4B**, as stretching or movement of garment **105** changes the relative capacitive surface area and/or distance between capacitive elements **155**. Electrodes **135** and **140** can be either properly or improperly positioned about the subject in the configurations of FIGS. **3A**, **3B**, **4A**, and **4B**. It should be appreciated that inductive element **150** may alternatively have a serpentine shape as shown in FIGS. **3B** and **4B** instead of the coiled shape shown in FIGS. **3A** and **4A**.

[0060] Inductive element **150** and capacitive element **155** can include a wire or thread sewn into garment **105**. In one embodiment, inductive element **150** or capacitive elements **155** can expand and contract with garment **105**, but otherwise substantially maintain their shape. Inductive element **150** and can also be wrapped around a core included in belt **110**, strap **145**, or other portion of garment **105**.

[0061] FIG. **5** depicts an example configuration of controller **130**. In one embodiment, interface **505** connects inductive element **150** or capacitive element **155** with detector **510** (e.g., a logic device or circuit) to measure the inductance of inductive element **150** or the capacitance of capacitive element **155**. Stretch detector **515** determines if at least a portion of garment **105** has stretched based upon the measured inductance or capacitance value. For example, controller **130** can determine the inductance or capacitance with garment **105** in an unstretched position at a baseline first time when wearable therapeutic device **100** is not being worn; and in a stretched position at a second time when wearable therapeutic device **100** is being worn. In one embodiment, comparator circuit **520** compares the unstretched baseline inductance or capacitance value with the stretched inductance or capacitance value to determine whether or not garment **105** has expanded or stretched, or to determine relative stretching between the baseline and stretched values. Based on this comparison, controller **130** and alarm module **120** can alert the subject to a number of conditions, such as garment **105** being too loose or too tight, that garment **105** is appropriately snug against the body of the subject, or that garment **105** is soiled and needs to be laundered to restore its elasticity, or that the garment should be replaced for example, due to its age.

[0062] FIG. **6** is a graph depicting tolerance stretch ranges of wearable therapeutic device **100** in accordance with an embodiment. In the example of FIG. **6**, when worn by subject **200**, wearable therapeutic device **100** can be classified in under stretch range **605**, tolerance range **610**, or over stretch range **615**. These classifications can change with time, and

subject **200** can adjust wearable therapeutic device **100** components such as belt **110** to change the classification between these ranges.

[0063] Wearable therapeutic device **100** can be determined by controller **130** to be in or under stretch range **605**, (e.g., Point A), tolerance range **610** (e.g., Point B), or over stretch range **615** (e.g., Point C). Under stretch range **605** can indicate that wearable therapeutic device **100** is too loose or not sufficiently expanded, so that sensing electrode **135** or therapy electrode **140** is not in a substantially fixed position, or is not tightly fitted against subject **200**. When controller **130** determines that wearable therapeutic device **100** is in under stretch range **605** based on the inductance of inductive element **150** or the capacitance of capacitive element **155**, alarm module **120** can instruct subject **200** to take some action, such as to tighten belt **110** or straps **145**, to launder garment **105** to improve its elasticity, or to replace garment **105** with a new one or one of a smaller size. For example, when the amount of stretching deteriorates from a baseline value over time, garment **105** may be losing elasticity and can be laundered to reintroduce elasticity to make garment **105** tighter fitting. When stretching deteriorates too rapidly between launderings from a baseline value, e.g., is below minimum tolerance threshold **620** and is too loose, garment **105** may be nearing end of life and be in need of replacement. When controller **130** determines that wearable therapeutic device **100** is over expanded or in over stretch range **615**, alarm module can instruct subject **200** to loosen belt **110** or straps **145**, or to replace garment **105** with a new one or one of a larger size. In one embodiment, controller **130** prevents application of treatment from therapy electrode **140** when garment **105** is determined to be in under stretch range **605** and/or over stretch range **615**. Controller **130** can also disregard or give less weight to information received from sensing electrode **135** when garment **105** is determined to be in under stretch range **605** or over stretch range **615** because these positions outside tolerance range **610** can indicate that sensing electrode **135** is not properly positioned about subject **200**.

[0064] In one embodiment, controller **130** can determine that garment **105** is within tolerance range **610** and thus properly fitted about subject **200** with sensing electrode **135** or therapy electrode **140** properly and snugly positioned with respect to subject **200**. When controller **130** determines or verifies that wearable therapeutic device **100** is within tolerance range **610**, controller **130** can evaluate information received from sensing electrode **135** to determine that subject **200** is or is not in need of therapy to treat, for example, an abnormal cardiac or respiratory event. Continuing with this example, controller **130** can direct therapy electrode **140** and defibrillator **115** to apply treatment to subject **200**.

[0065] In one embodiment, minimum tolerance threshold **620** and maximum tolerance threshold **625** are the limits of tolerance range **610**. Thresholds **620** and **625** need not be linear as depicted in FIG. **6**. In one embodiment, thresholds **620**, **625** can change with time. For example, as wearable therapeutic device **100** degrades or becomes worn with time, minimum tolerance threshold **620** can increase, indicating an increase in tightening may be necessary to position sensing electrode **135** or therapy electrode **140**. Alternatively, where a significant amount of noise on sensing electrode **135** is detected at a particular stretch level, or where a number of fall-off flags have been detected, or both; controller **130** may adjust the minimum tolerance threshold to this level of

stretch. In this example, controller 130 includes auto-learn or adaptive features where controller 130 adjusts tolerance thresholds 620 or 625, or tolerance range 610, based on sensed electrode positioning, electrode fall off events, the force applied by garment 105 onto the subject, or feedback from the subject regarding observed conditions or the subject's comfort level. Maximum tolerance threshold 625 can also increase over time, as for example subject 200 becomes accustomed to wearable therapeutic device 100 and is able to comfortably withstand a tighter fit. In one embodiment, garment 105 exerts 0.050 lb of force on the subject's body at minimum tolerance threshold 620 and 1.70 lb of force on the subject's body at maximum tolerance threshold 625.

[0066] The auto-learn features of controller 130 can associate a particular fitting or level of snugness of garment 105 about subject 200 with a substantially noise or artifact free ECG signal measured by sensing electrode 135. For example, controller 130 can identify an amount of force exerted by garment 105 on subject 200 during sensing of a usable ECG signal by sensing electrode 135. In this example, the amount of force identified by controller 130 is based on the detected inductance of inductive element 150 or the detected capacitance of capacitive element 155. Controller 130 in this example identifies a tolerance range 610 that includes this detected amount of force. If controller 130 detects that garment 105 is in under stretch range 605 (e.g., too loose) or over stretch range 615 (e.g., too tight), controller 130 can instruct subject 200 to tighten or loosen garment 105, for example via alarm module 120 or monitor 125, to bring the force level within that of tolerance range 610. In this example, controller 130 identifies and continuously adjusts a custom tolerance range 610 for an individual subject 200 and a particular garment 105 based on the fit of that garment 105 that provides sufficient force for a substantially artifact free ECG signal.

[0067] Thus, with the auto-learn feature, controller 130 can determine or adjust the range of tolerance range 610 based on the quality of ECG signals sensed by sensing electrode 135. For example, the force exerted by garment 105 on subject 200 during sensing of a substantially noise or artifact free ECG can be evaluated by controller 130 to determine the scope of tolerance range 610, with the force associated with a quality ECG signal being within tolerance range 610. Controller 130 can adjust this range with time, for example as subject 200 gains or loses weight, or as garment 105 wears and its elasticity characteristics change. It should be appreciated that the level of snugness associated with a quality ECG signal, and thus tolerance range 610, may vary from subject to subject.

[0068] In one embodiment, when wearable therapeutic device is in tolerance range 610, garment 105 has an acceptable range of stretching. In this illustrative embodiment, controller 130 can determine that sensing electrode 135 and therapy electrode 140 are in proper position about subject 200. Based on changes in the inductance or capacitance caused by garment 105 expansion, controller 130 can determine respiration information (e.g., rates and volumes) of subject 200. Sensing electrode 135, which may include an accelerometer, can also sense this information. Respiratory information can also be determined based on the inductance or capacitance, which may change as garment 105 expands or contracts with respiration. In one embodiment, controller 130 evaluates respiration information and electrocardiogram information to detect an arrhythmia.

[0069] Ranges 605, 610, and 615, and thresholds 620 and 625 can be indicated as stretching distances of garment 105,

belt 110, strap 145 or other components, as well as changes in circumference, diameter, or radius of these components. These ranges and thresholds can be determined based on inductance values of inductive element 150 or on the capacitance values of capacitive element 155. They can be indicated with inductance values, capacitance values, or units of distance.

[0070] In one embodiment, controller 130 evaluates the inductance or capacitance and determines that garment 105 stretching is within tolerance range 610. In this example, sensing electrodes 135 sense cardiac (e.g., electrocardiogram) information about subject 200. Respiratory information can also be sensed or deduced from changes in inductance or capacitance. In this example, the cardiac information can indicate that subject 200 is suffering an arrhythmia at the same time the respiratory information indicates that subject 200 has stopped breathing. Because, in this example, garment 105 is within tolerance range 610, controller 130 can determine with a high level of confidence that sensing electrodes 135 are properly positioned. Based on this confidence level and the sensed information, controller 130 can determine that the sensed information is accurate and that subject 200 is experiencing an arrhythmia and in need of treatment. With garment 105 within tolerance range 610, controller 130 can also determine with a high level of confidence that therapy electrode 140 is properly positioned to apply an electric shock to subject 200 to treat the arrhythmia. In one embodiment, where an arrhythmia has been detected but controller 130 determines garment 105 is within tolerance range 610 and respiratory information indicates normal breathing, controller 130 may reduce the confidence level that the arrhythmia has been detected and/or that the subject is in need of treatment.

[0071] Controller 130 can also determine that garment 105 is stretched outside of tolerance range 610, (e.g., over or under stretched). In this example, respiration and cardiac information may be inconsistent with each other due to movement or improper positioning with respect to subject 200. Noise artifacts can further interfere with the sensed information. Continuing with this example, controller 130 can have a low level of confidence that sensing electrodes 135 are properly positioned, (or a high level of confidence that they are improperly positioned). Based on this confidence level and the sensed information, controller 130 can determine that the sensed information is inaccurate because the sensor is improperly positioned, and that subject 200 is not experiencing an arrhythmia and does not need treatment. In this example, controller 130 can withhold, prevent, or block treatment from therapy electrode 140 to subject 200 until controller 130 determines with sufficient confidence that information from sensing electrodes 135 is reliable and that sensing electrodes 135 and therapy electrode 140 are properly positioned. Further, controller 130 can adjust the behavior of wearable therapeutic device 100 based on the confidence level. For example, where the confidence level is low or decreasing with respect to a previous confidence level, controller 130 (and sensing electrodes 135) can sense ECG signals more frequently, or controller 130 can lengthen a response time during which the subject can respond to an alarm indicating a detected arrhythmia, or both.

[0072] Wearable therapeutic device 100 can identify arrhythmic cardiac events and apply treatment when garment 105 is in any range, including under stretch range 605, tolerance range 610, and over stretch range 615. For example,

while in tolerance range **610**, controller **130** can identify an arrhythmia with less sensed information due to a high confidence level that the sensed information is accurate, and can direct therapy electrodes **140** to apply treatment due to a high confidence level that they are properly positioned. While in ranges **605** or **615**, controller **130** may have a lower confidence level that the sensed information is accurate and that electrodes **135**, **140** are properly positioned. In this example, controller **130** may compensate for possible artifacts or flaws in the sensed information by evaluating sensed information over a longer period of time, or by evaluating information provided by additional sensors **135** to identify an arrhythmia. Via alarm module, controller **130** may prompt subject **200** for a response or ask the subject to indicate distress, where an affirmative response or lack of any response indicates that the subject is in need of treatment. In one embodiment, controller **130** may direct therapy electrode **140** to apply treatment even when therapy electrode **140** is improperly positioned. The applied treatment may still be effective even though there may be a higher impedance between therapy electrodes **140** and the subject's skin in this example.

[0073] In one embodiment, controller **130** determines different degrees of confidence that the sensed information is accurate and that electrodes **135** and **140** are properly positioned. There can be two possible confidence levels (e.g., high/low, zero/one, yes/no) or confidence levels can be provided as percentages (e.g., a 60% chance that the sensed information is accurate). Based on the confidence level, controller **130** can evaluate more or less sensed information, from sensing electrode **135**, inductive element **150**, or capacitive element **155** to provide a notification to the subject regarding positioning of wearable therapeutic device **100**, detection of an arrhythmia, or application of treatment. In one embodiment, suggestions or requirements are provided to subject **200** to increase the confidence level, such as suggesting that subject **200** tighten garment **105** if subject **200** can tolerate the tightening, or indicate that sensors **135** and **140** are nonfunctional due to improper positioning and require their tightening or replacement.

[0074] FIG. 7 is a flow chart depicting a method **700** of facilitating care of a subject. In one embodiment, method **700** includes an act of providing a wearable therapeutic device (ACT **705**). In one embodiment, providing the wearable therapeutic device (ACT **705**) includes providing a device that includes a sensing electrode. The sensing electrode may be housed in a garment of the wearable therapeutic device, and providing the wearable therapeutic device (ACT **705**) may include providing a device with an inductive element or capacitive element included in at least part of the garment. Providing the wearable therapeutic device (ACT **705**) may also include providing a device having a controller configured to determine inductance of the inductive element or capacitance of the capacitive element, and to determine, based on the determined inductance or capacitance, a confidence level of information received from the sensing electrode. This information may include electrocardiograph or other information about the subject's body functions. Providing the wearable therapeutic device (ACT **705**) may also include providing a device with an alarm module coupled with a controller to notify the subject of events, conditions, or information about the subject's condition or about the condition of the wearable therapeutic device, based on the confidence level of the information received from the sensor and the determined inductance of the inductive element.

[0075] In one embodiment, method **700** includes an act of providing instructions (ACT **710**). For example, providing instructions (ACT **710**) can include providing instructions to operate the wearable therapeutic device, or providing instructions on how to wear the wearable therapeutic device. In one embodiment, the instructions include instructions to the subject regarding positioning of wearable therapeutic device components, such as sensing or therapy electrodes. For example, instructions can be provided (ACT **710**) to the subject, based on an expansion of the wearable therapeutic device or its components, to position an electrode proximate to an area of the subject's body, such as the center of the back, or proximate to the chest and heart of the subject, so that the electrodes are positioned to provide therapy to the subject or sense cardiac or respiratory function of the subject.

[0076] In one embodiment, method **700** includes an act of receiving information about the subject (ACT **715**). In one embodiment, this information is received (ACT **715**) from at least one sensing electrode. For example, receiving information (ACT **715**) may include receiving sensed electrocardiograph information of the subject. In this example, the received information includes information from a sensing electrode that is part of the wearable therapeutic device and that can detect electrocardiograph signals from a subject wearing the device. The received (ACT **715**) information can include cardiac, pulse, circulatory, respiratory, or pulmonary information of the subject. In one embodiment, receiving information (ACT **715**) includes receiving information about the inductance of an inductive element or capacitance of a capacitive element disposed in part of the wearable therapeutic device. The inductance value, capacitance value or changes in these values with time can indicate that the wearable therapeutic device is in a stretched, expanded, or unexpanded position.

[0077] Method **700** also includes an act of determining inductance of an inductive element included in the wearable therapeutic device (ACT **720**). In one embodiment, inductance is determined (ACT **720**) with a sensor that is part of the wearable therapeutic device that measures the inductance, or a logic device associated with the controller calculates inductance based, for example, on the radius, number of turns, or length of the coils of the inductive element disposed in the wearable therapeutic device.

[0078] Method **700** alternatively or additionally includes an act of determining capacitance of a capacitive element included in the wearable therapeutic device (ACT **723**). In one embodiment, capacitance is determined (ACT **723**) with a sensor that is part of the wearable therapeutic device that measures the capacitance, or a logic device associated with the controller calculates capacitance of the capacitive element.

[0079] In one embodiment, method **700** includes an act of determining a confidence level (ACT **725**) of the received (ACT **715**) information about the subject. The confidence level may be determined (ACT **725**) based on changes in the inductance or capacitance with respect to a baseline or threshold value. In one embodiment, the confidence level is determined based on identified expansion or stretching of a portion of the wearable therapeutic device or any of its components. For example, the confidence level can be determined based on the expansion of the inductive element or capacitive element, a belt or other portion of the wearable therapeutic device that includes either of these elements, or a circumference of the wearable therapeutic device, its belt, strap, or garment. In one

embodiment, the confidence level is determined based on an expansion of a portion of the wearable therapeutic device that includes the inductive element or capacitive element and received information (ACT 715) about the subject that includes electrocardiograph information.

[0080] Determining the confidence level (ACT 725) may include determining that the received information about the subject is accurate. For example, the determined inductance (ACT 720) or capacitance (ACT 723) can indicate that the wearable therapeutic device has not stretched, or has stretched less than a threshold amount, or within a defined acceptable parameter or range. In this example, the confidence level of the accuracy of the sensed information about the subject can be determined (ACT 725) to be high, e.g., the sensed electrocardiograph or other information about the subject can be accepted as valid information about the subject's health and used as a factor in diagnosing the subject, e.g., by identifying an arrhythmic cardiac event, or applying treatment to the subject.

[0081] Determining the confidence level (ACT 725) may include determining that the received information about the subject is not accurate. In this example, the determined inductance (ACT 720) or capacitance (ACT 723) can indicate that the wearable therapeutic device has stretched to a degree that the sensing electrode that senses the received (ACT 715) information about the subject may have shifted about the subject to a degree where it is no longer properly positioned to sense, for example, a quality electrocardiogram signal. In this example, the confidence level in the accuracy of the sensed information can be low, and the sensed information may be disregarded or require further verification.

[0082] In one embodiment, method 700 includes an act of providing a notification to the subject (ACT 730) based on the confidence level. The notification may be audibly, visually, or haptically (e.g., a vibrating alarm) provided (ACT 730) to the subject. The notification may also be provided (ACT 730) to another person such as the subject's doctor, family member, friend, or health care provider, who may be proximate to the subject or at a remote location, e.g., via a transmission over a network. In one embodiment, the notification is provided to the subject (ACT 730) by an alarm module, monitor, or interface that is part of the wearable therapeutic device.

[0083] Providing the notification (ACT 730) may include providing a diagnosis of an arrhythmic cardiac event, fibrillation, cardiac arrest, abnormal respiratory activity, or other condition that may require medical attention. The provided notification (ACT 730) can indicate that the subject has no immediate health issue requiring treatment, e.g., a normal cardiac rhythm or normal pulmonary activity. Providing the notification (ACT 730) can also include providing information unrelated to the subject's health, such as information about the use or positioning of the wearable therapeutic device. For example, information can be provided (ACT 730) indicating that the sensing or therapy electrodes of the wearable therapeutic device are not properly positioned with respect to the subject wearing the device. This may be due to stretching of the wearable therapeutic device with time and use. This stretching can cause the electrodes to shift position to a location where they are less effective or ineffective to sense information about the subject or apply treatment to the subject.

[0084] In one embodiment, method 700 includes an act of verifying positioning of wearable therapeutic device components (ACT 735), such as sensing or therapy electrodes. For

example, the position of wearable therapeutic device components can be verified (ACT 735) when the identified inductance (ACT 720) or capacitance (ACT 723) is analyzed to determine that the amount of stretching of the wearable therapeutic device is less than a threshold amount, or within a tolerance range. This minimal stretching can indicate a tolerable level of displacement of wearable therapeutic device components. Method 700 may also include an act of applying treatment to the subject (ACT 740). In one embodiment, applying treatment to the subject (ACT 740) includes delivering an electric shock to the subject from therapy electrodes that are included in the wearable therapeutic device and an associated defibrillator.

[0085] Method 700 can also include an act of identifying improper positioning of wearable therapeutic device components (ACT 745). For example, improper positioning of wearable therapeutic device components can be identified (ACT 745) when the identified inductance (ACT 720) or capacitance (ACT 723) is analyzed to determine that the amount of stretching of the wearable therapeutic device is more than a threshold amount, or outside a tolerance range. This stretching can indicate an unacceptable level of displacement of wearable therapeutic device components during use of the wearable therapeutic device. Method 700 may also include an act of withholding treatment from the subject (ACT 750). In one embodiment, withholding treatment from the subject (ACT 740) includes delaying delivery an electric shock to the subject from therapy electrodes that are included in the wearable therapeutic device and an associated defibrillator until the therapy electrodes are moved to an appropriate location proximate to the subject, and until their positioning is verified (ACT 735). Withholding treatment from the subject (ACT 750) can also include delaying delivery of an electric shock to the subject until sensing electrodes are moved to an appropriate location proximate the subject so that they can sense information at a confidence level sufficient to rely on for diagnosing the subject's condition.

[0086] Having now described some illustrative embodiments, it is apparent that the foregoing is illustrative and not limiting, having been presented by way of example.

[0087] In particular, although many of the examples presented herein involve specific combinations of method acts or system elements, it is understood that those acts and those elements may be combined in other ways. Acts, elements and features discussed only in connection with one embodiment are not intended to be excluded from a similar role in other embodiments.

[0088] Note that in FIGS. 1 through 7, the enumerated items are shown as individual elements. In actual implementations of the systems and methods described herein, however, they may be inseparable components of other electronic devices such as a digital computer. Thus, actions described above may be implemented at least in part in software that may be embodied in an article of manufacture that includes a program storage medium. The software may be executed by a processor of controller 130. In one embodiment, the program storage medium is non-transient. The program storage medium includes data signals embodied in one or more of a carrier wave, a computer disk (magnetic, or optical (e.g., CD or DVD, or both)), non-volatile memory, tape, a system memory, and a computer hard drive.

[0089] Any references to embodiments or elements or acts of the systems and methods herein referred to in the singular may also embrace embodiments including a plurality of these

elements, and any references in plural to any embodiment or element or act herein may also embrace embodiments including only a single element. References in the singular or plural form are not intended to limit the presently disclosed systems or methods, their components, acts, or elements to single or plural configurations. References to any act or element being based on any information, act or element may include embodiments where the act or element is based at least in part on any information, act, or element.

[0090] Any embodiment disclosed herein may be combined with any other embodiment, and references to “an embodiment,” “some embodiments,” “an alternate embodiment,” “various embodiments,” “one embodiment” or the like are not necessarily mutually exclusive and are intended to indicate that a particular feature, structure, or characteristic described in connection with the embodiment may be included in at least one embodiment. Such terms as used herein are not necessarily all referring to the same embodiment. Any embodiment may be combined with any other embodiment in any manner consistent with the aspects and embodiments disclosed herein.

[0091] References to “or” should be construed as inclusive so that any terms described using “or” may indicate any of a single, more than one, and all of the described terms. Intervening embodiments, acts, or elements are not essential unless recited as such.

[0092] Where technical features in the drawings, detailed description or any claim are followed by reference signs, the reference signs have been included for the sole purpose of increasing the intelligibility of the drawings, detailed description, and claims. Accordingly, neither the reference signs nor their absence have any limiting effect on the scope of any claim elements.

[0093] One skilled in the art will realize the systems and methods described herein may be embodied in other specific forms without departing from the characteristics thereof. For example, the subject may be a patient and the wearable therapeutic device can store and transmit data concerning the patient’s medical condition to a physician. Because the wearable therapeutic device can operate essentially at all times, this data can be used to generate a comprehensive real time record of the subject’s health over an extended period of time. The foregoing embodiments are illustrative rather than limiting of the described systems and methods. Scope of the systems and methods described herein is thus indicated by the appended claims, rather than the foregoing description, and changes that come within the meaning and range of equivalency of the claims are embraced therein.

What is claimed is:

1-32. (canceled)

33. A wearable therapeutic device, comprising:

- a garment including a sensing electrode;
- at least one of an inductive element having an inductance and a capacitive element having a capacitance included in at least part of the garment; and
- a controller coupled to the sensing electrode and the at least one of the inductive element and the capacitive element, the controller comprising:
 - an expansion determiner to determine an amount of garment expansion based on at least one of the inductance of the inductive element and the capacitance of the capacitive element,
 - a sensing electrode position verifier to verify positioning of the sensing electrode on a subject at least in part by

- determining whether the amount of garment expansion is within a tolerance range, and

- a tolerance range adjuster to adjust the tolerance range based on a quality level of information received from the sensing electrode.

34. The wearable therapeutic device of claim **33**, wherein the tolerance range adjuster comprises a range increaser to adjust the tolerance range at least in part by decreasing at least one of an upper threshold and a lower threshold of the tolerance range in response to receiving substantially artifact free information from the sensing electrode.

35. The wearable therapeutic device of claim **33**, wherein the tolerance range adjuster comprises a range decreaser to adjust the tolerance range at least in part by increasing at least one of an upper threshold and a lower threshold of the tolerance range in response to receiving distorted information from the sensing electrode.

36. The wearable therapeutic device of claim **33**, wherein the controller further comprises a respiratory function determiner to determine respiratory function of the subject based on the amount of garment expansion.

37. The wearable therapeutic device of claim **36**, wherein the sensing electrode comprises an electrocardiogram sensor to sense electrocardiogram information of the subject; and wherein the controller further comprises an arrhythmia detector to detect an arrhythmia of the subject based at least in part on the determined respiratory function and the electrocardiogram information.

38. The wearable therapeutic device of claim **33**, wherein the sensing electrode comprises an electrocardiogram sensor to sense electrocardiogram information of the subject; and wherein the controller further comprises an arrhythmia detector to detect an arrhythmic cardiac event based on at least one of the amount of garment expansion and the electrocardiogram information of the subject.

39. The wearable device of claim **33**, further comprising a therapy electrode coupled to the controller.

40. The wearable therapeutic device of claim **39**, wherein the controller further comprises a therapy electrode position verifier to verify positioning of the therapy electrode on the subject based at least in part on the amount of garment expansion.

41. The wearable therapeutic device of claim **39**, wherein the controller further comprises a treatment applier to apply treatment to the subject via the therapy electrode in response to detecting an arrhythmic cardiac event and verifying positioning of the therapy electrode.

42. The wearable therapeutic device of claim **33**, wherein the garment includes at least one of a belt and a strap.

43. The wearable therapeutic device of claim **33**, wherein the wearable therapeutic device includes the inductive element in at least part of the garment and the inductive element is coiled around a core.

44. A method of facilitating care of a subject, comprising: providing a wearable therapeutic device that includes a sensing electrode;

- receiving, from the sensing electrode, information about the subject;

- determining at least one of an inductance of an inductive element and a capacitance of a capacitive element included in at least part of the wearable therapeutic device;

determining an amount of garment expansion based on at least one of the inductance of the inductive element and the capacitance of the capacitive element;

verifying positioning of the sensing electrode on the subject at least in part by determining whether the amount of garment expansion is within a tolerance range; and adjusting the tolerance range based on a quality level of information received from the sensing electrode.

45. The method of claim **44**, wherein adjusting the tolerance range includes decreasing at least one of an upper threshold and a lower threshold of the tolerance range responsive to receiving substantially artifact free information from the sensing electrode.

46. The method of claim **44**, wherein adjusting the tolerance range includes increasing at least one of an upper threshold and a lower threshold of the tolerance range responsive to receiving distorted information from the sensing electrode.

46. The method of claim **44**, further comprising determining respiratory function of the subject based on the amount of garment expansion.

47. The wearable therapeutic device of claim **44**, wherein receiving information from the subject includes receiving electrocardiogram information from the subject, and the method further comprises detecting an arrhythmia of the subject based at least in part on the electrocardiogram information and a determination of respiratory function based on the amount of garment expansion.

48. The method of claim **44**, further comprising verifying positioning of a therapy electrode included in the wearable therapeutic device at least in part on the amount of garment expansion.

49. The method of claim **48**, further comprising: detecting an arrhythmic cardiac event based on the received information about the subject; and

applying treatment to the subject via the therapy electrode responsive to detecting an arrhythmic cardiac event and verifying the positioning of the therapy electrode.

50. A non-transitory computer readable medium having stored thereon sequences of instructions including instructions that cause a processor to:

receive, from a sensing electrode of a wearable therapeutic device, information about the subject;

determine at least one of an inductance of an inductive element and a capacitance of a capacitive element included in at least part of the wearable therapeutic device;

determine an amount of garment expansion based on at least one of the inductance of the inductive element and the capacitance of the capacitive element;

verify positioning of the sensing electrode on the subject at least in part by determining whether the amount of garment expansion is within a tolerance range; and

adjust the tolerance range based on a quality level of information received from the sensing electrode.

51. The computer readable medium of claim **50**, wherein the instructions that cause the processor to adjust the tolerance range include instructions that cause the processor to decrease at least one of an upper threshold and a lower threshold of the tolerance range in response to receiving substantially artifact free information from the sensing electrode.

52. The computer readable medium of claim **50**, wherein the instructions that cause the processor to adjust the tolerance range include instructions that cause the processor to increase at least one of an upper threshold and a lower threshold of the tolerance range in response to receiving distorted information from the sensing electrode.

* * * * *

专利名称(译)	可穿戴式监控和治疗设备		
公开(公告)号	US20140206974A1	公开(公告)日	2014-07-24
申请号	US14/161017	申请日	2014-01-22
[标]申请(专利权)人(译)	卓尔医学产品公司		
申请(专利权)人(译)	ZOLL医疗公司		
当前申请(专利权)人(译)	ZOLL医疗公司		
[标]发明人	VOLPE SHANE S KAIB THOMAS E		
发明人	VOLPE, SHANE S. KAIB, THOMAS E.		
IPC分类号	A61B5/00 A61N1/39 A61B5/0205		
CPC分类号	A61B5/6804 A61N1/3968 A61B5/0205 A41D13/1281 A61B5/02438 A61B5/0452 A61B5/053 A61B5/1135 A61B5/6805 A61B5/6844 A61B5/7221 A61N1/046 A61N1/0484 A61N1/3925 A61N1/3931 A61B5/7455 A61B5/742 A61N1/3975 A61N1/3987 G01R27/2611		
优先权	61/679143 2012-08-03 US 61/530261 2011-09-01 US		
其他公开文献	US9131901		
外部链接	Espacenet USPTO		

摘要(译)

提供了一种便于护理受试者的可穿戴治疗设备。可穿戴治疗设备可包括具有感测电极的衣服。该服装包括电感元件和电容元件中的至少一个，并且控制器识别电感元件的电感或电容元件的电容，并基于电感确定从感测电极接收的信息的置信水平或电容。可穿戴治疗设备还包括警报模块，该警报模块与控制器耦合并且被配置为基于置信水平向对象提供通知。

