



(19) **United States**

(12) **Patent Application Publication**  
**LeBoeuf et al.**

(10) **Pub. No.: US 2019/0380655 A1**  
(43) **Pub. Date: Dec. 19, 2019**

(54) **PHYSIOLOGICAL MONITORING DEVICES AND METHODS USING OPTICAL SENSORS**

**G05B 19/048** (2006.01)  
**A61B 5/021** (2006.01)

(71) Applicant: **Valencell, Inc.**, Raleigh, NC (US)

(52) **U.S. Cl.**  
CPC ..... **A61B 5/7203** (2013.01); **A61B 5/0816** (2013.01); **A61B 5/6815** (2013.01); **A61B 5/4266** (2013.01); **A61B 5/7207** (2013.01); **A61B 5/14552** (2013.01); **A61B 5/01** (2013.01); **A61B 5/6826** (2013.01); **A61B 5/4809** (2013.01); **A61B 5/7271** (2013.01); **A61B 5/72** (2013.01); **A61B 5/02427** (2013.01); **A61B 5/0059** (2013.01); **A61B 5/1123** (2013.01); **A61B 5/68** (2013.01); **A61B 5/443** (2013.01); **A61B 5/02055** (2013.01); **A61B 5/0205** (2013.01); **A61B 5/165** (2013.01); **A61B 5/742** (2013.01); **A61B 5/14551** (2013.01); **G05B 19/048** (2013.01); **A61B 5/02416** (2013.01); **A61B 5/021** (2013.01); **A61B 5/6816** (2013.01); **A61B 5/1118** (2013.01); **A61B 2560/0242** (2013.01); **A61B 5/02405** (2013.01); **A61B 2560/0266** (2013.01); **A61B 5/6803** (2013.01)

(72) Inventors: **Steven Francis LeBoeuf**, Raleigh, NC (US); **Jesse Berkley Tucker**, Youngsville, NC (US); **Michael Edward Aumer**, Raleigh, NC (US); **Steven Matthew Just**, Cary, NC (US); **Mark Andrew Felice**, Cary, NC (US)

(21) Appl. No.: **16/545,637**

(22) Filed: **Aug. 20, 2019**

**Related U.S. Application Data**

(63) Continuation of application No. 16/503,191, filed on Jul. 3, 2019, which is a continuation of application No. 14/807,149, filed on Jul. 23, 2015, now abandoned, which is a continuation of application No. 62/109,196, filed on Jan. 29, 2015.  
(60) Provisional application No. 62/030,951, filed on Jul. 30, 2014.

**Publication Classification**

(51) **Int. Cl.**  
**A61B 5/00** (2006.01)  
**A61B 5/1455** (2006.01)  
**A61B 5/01** (2006.01)  
**A61B 5/024** (2006.01)  
**A61B 5/11** (2006.01)  
**A61B 5/0205** (2006.01)  
**A61B 5/16** (2006.01)

(57) **ABSTRACT**

A monitoring device configured to be attached to a subject includes a photoplethysmography (PPG) sensor configured to measure a plurality of physiological parameters from the subject, a motion sensor configured to detect an activity state of the subject, and a processor coupled to the PPG sensor and the motion sensor. The PPG sensor is configured to measure each physiological parameter in a respective one of a plurality of time intervals. The processor instructs the PPG sensor to measure a first one of the plurality of physiological parameters if the activity state is at or above a threshold, and to measure a second one of the plurality of physiological parameters if the activity state is below the threshold.

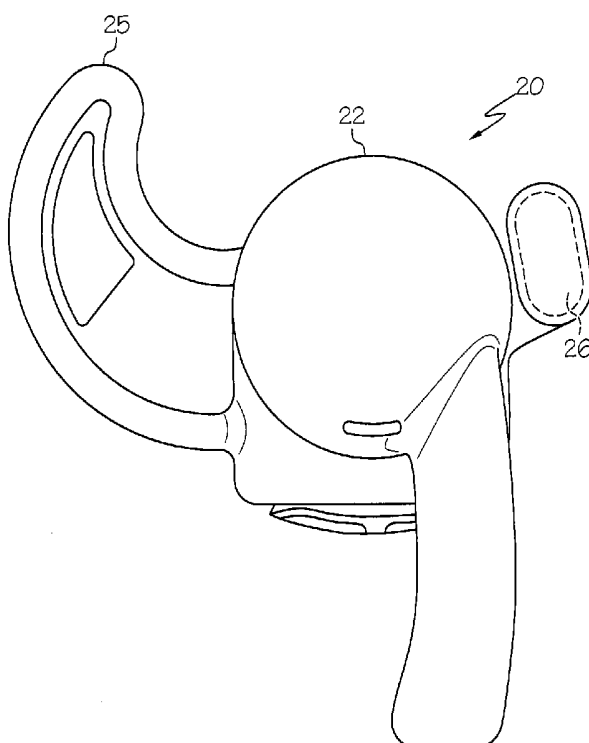



FIG. 1A  
(PRIOR ART)

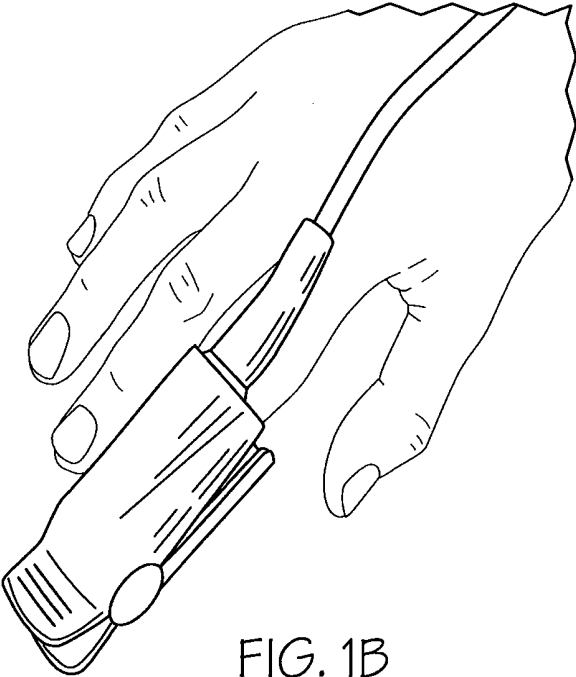

FIG. 1B  
(PRIOR ART)

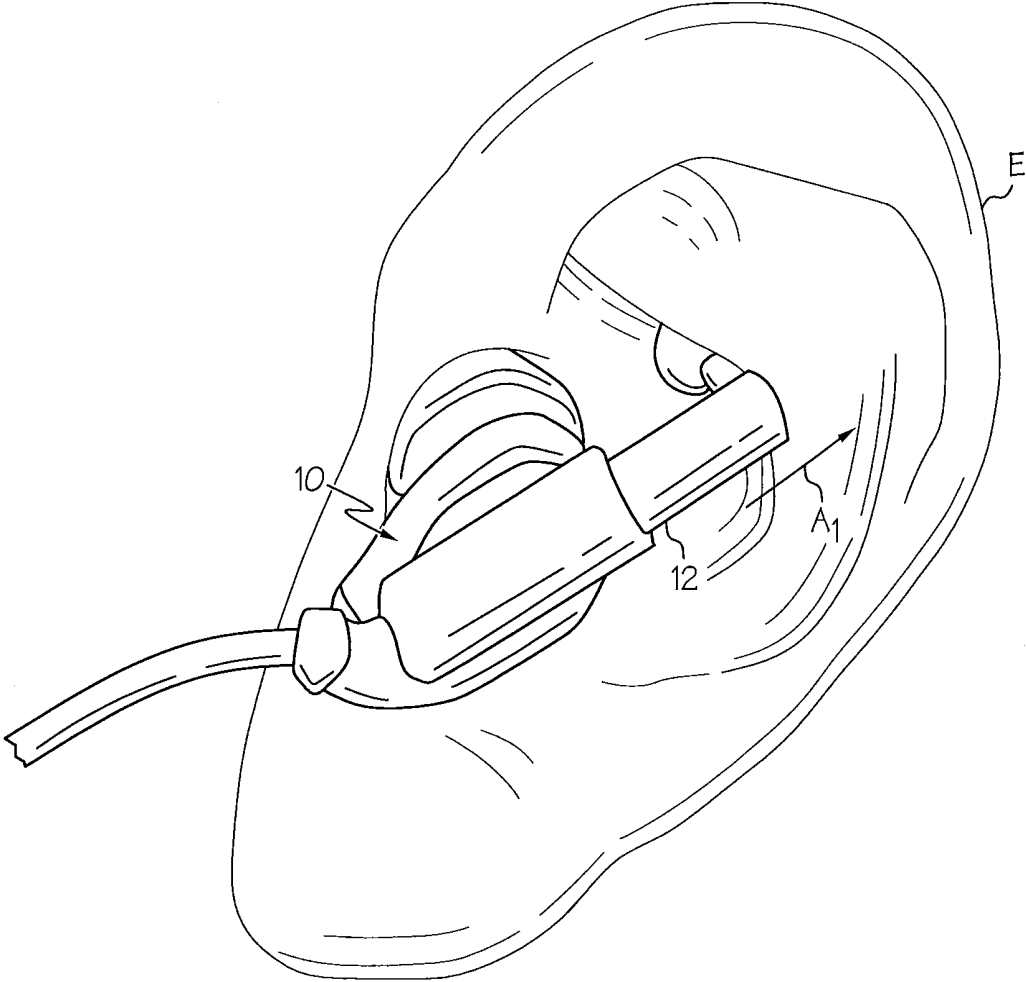

FIG. 1C  
(PRIOR ART)

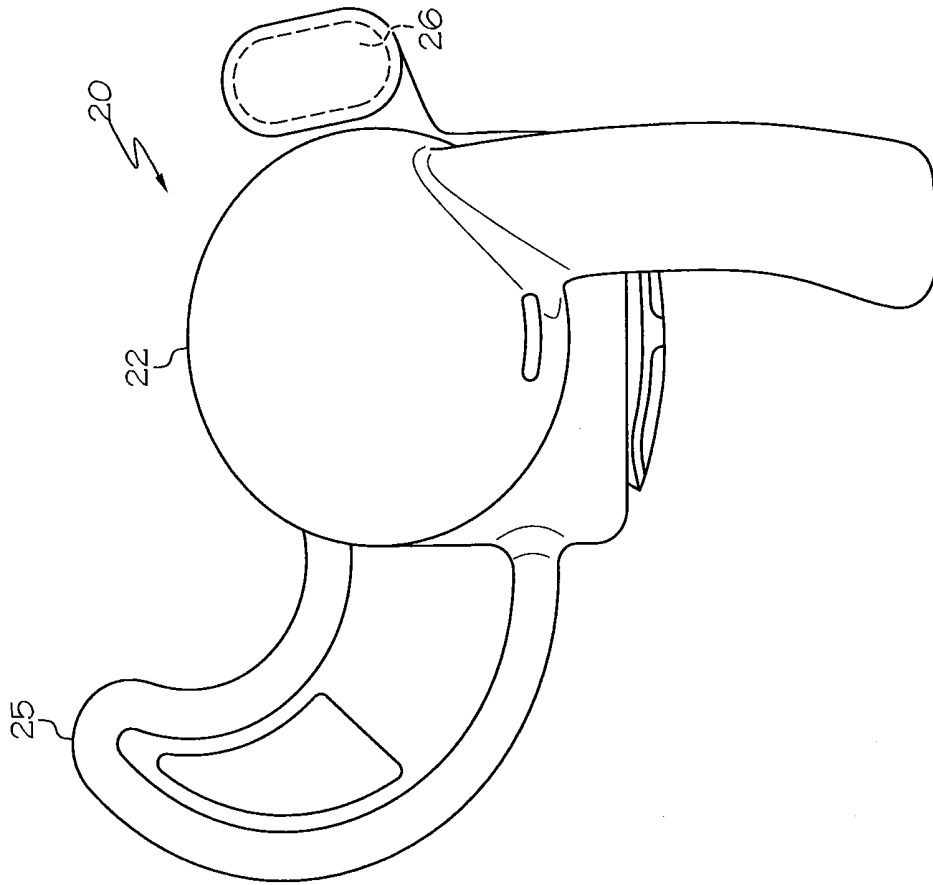

FIG. 2B

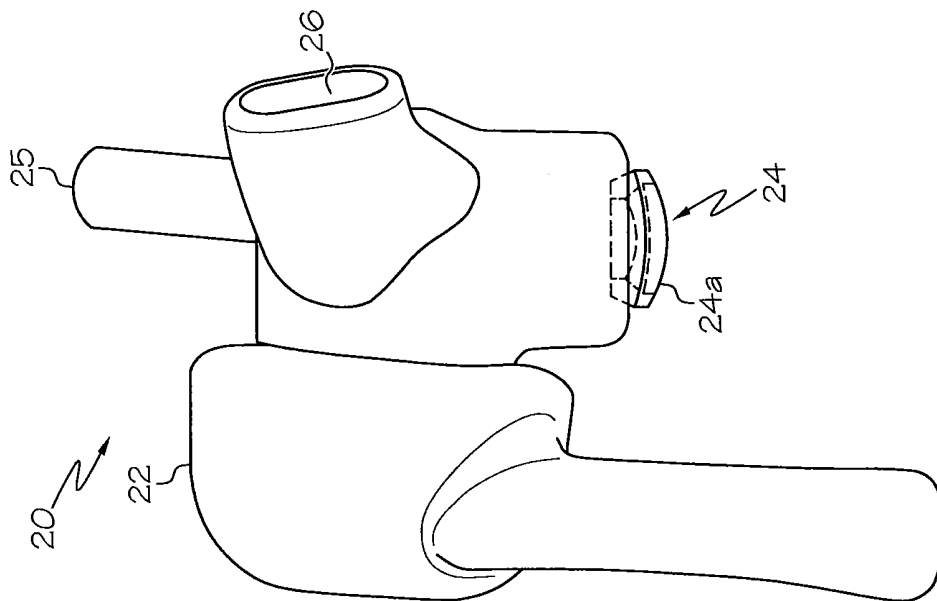

FIG. 2A

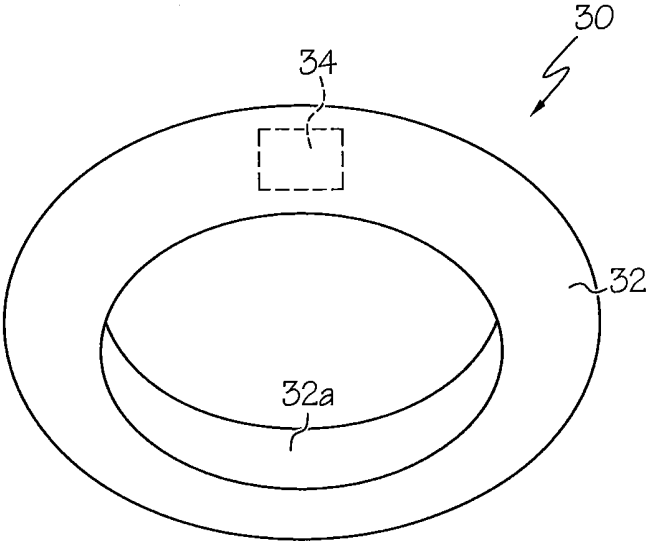

FIG. 3A

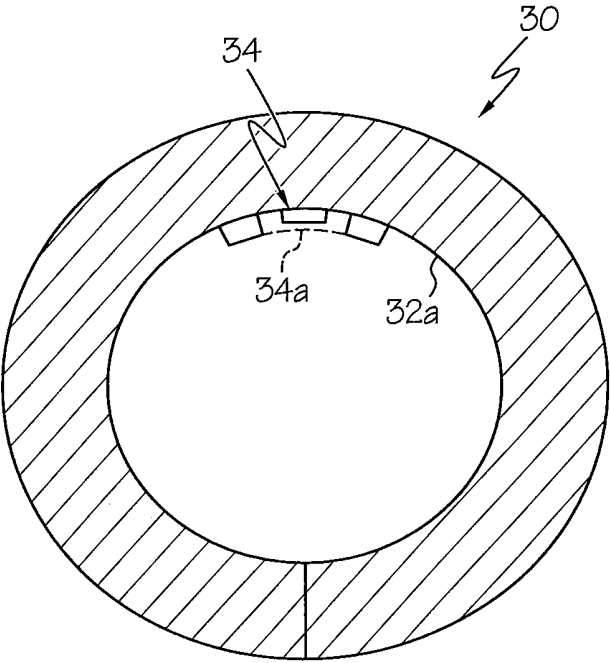

FIG. 3B

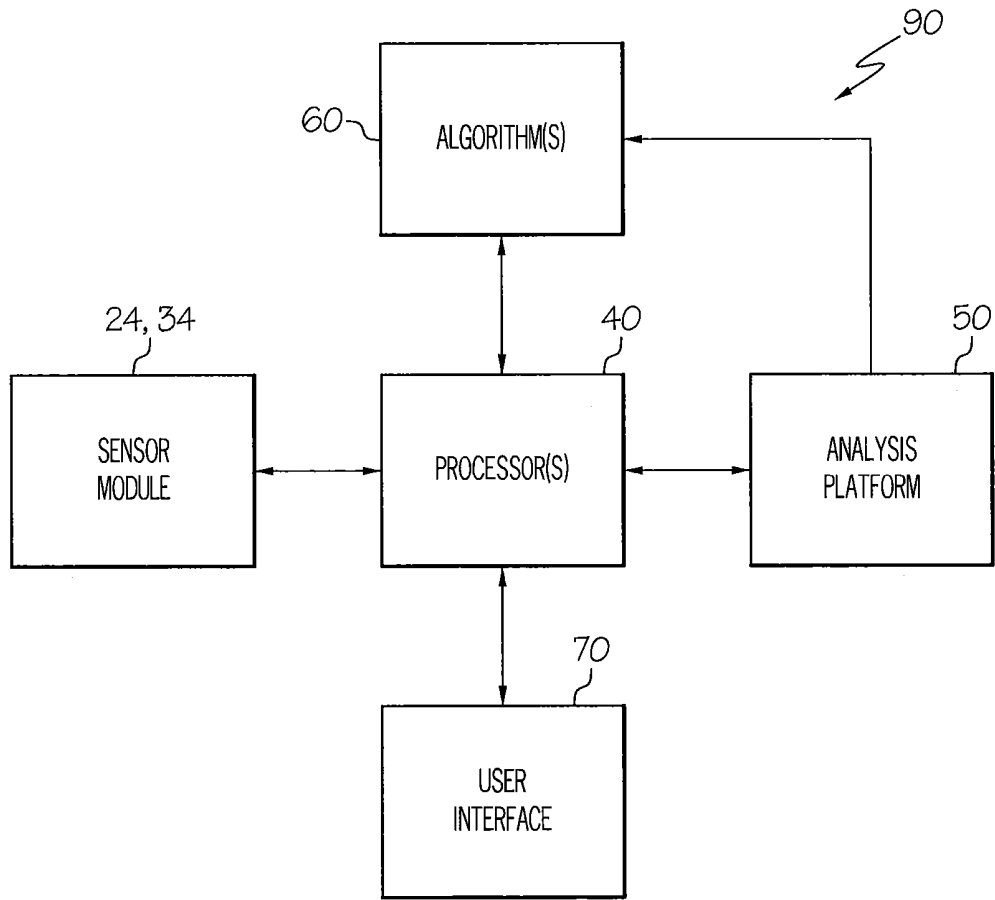

FIG. 4

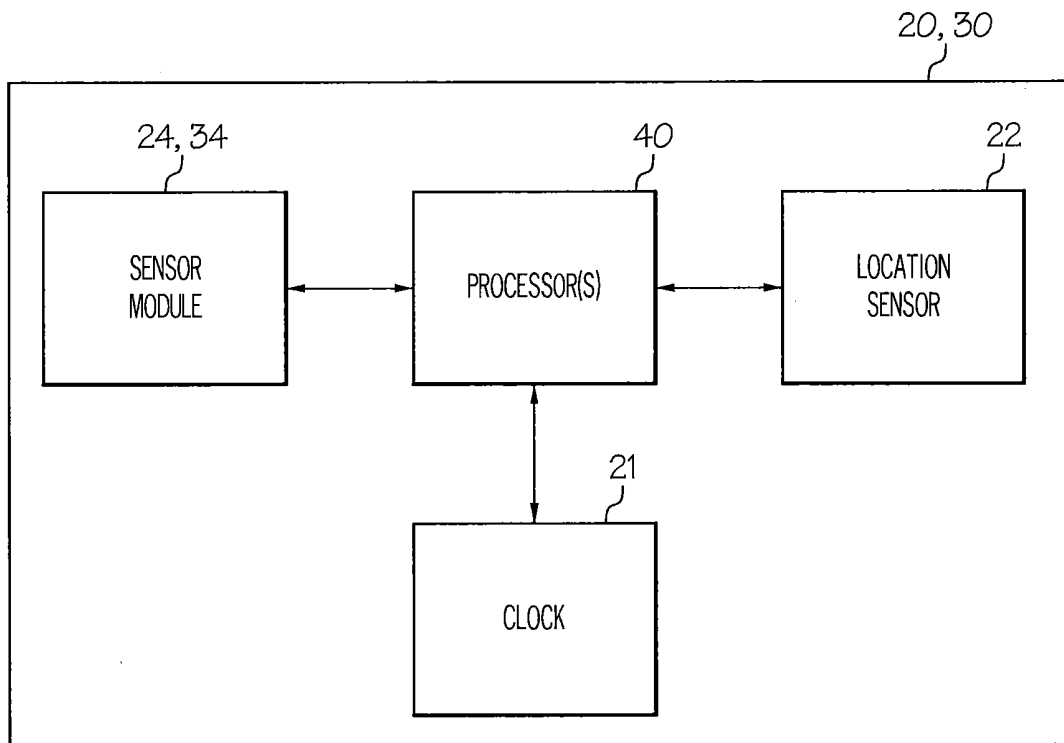

FIG. 5

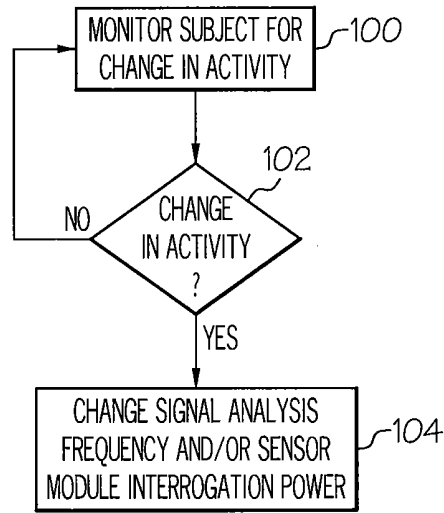

FIG. 6

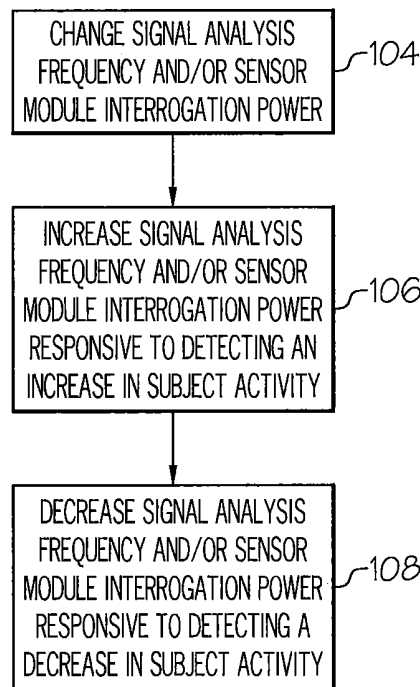

FIG. 7A

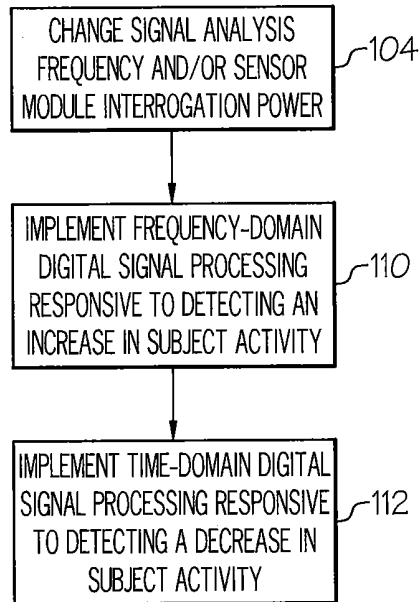

FIG. 7B

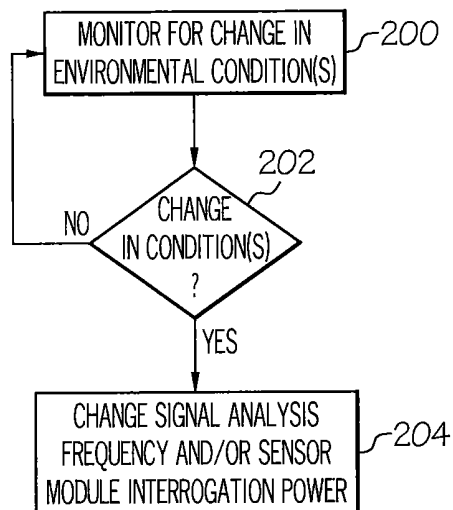

FIG. 8

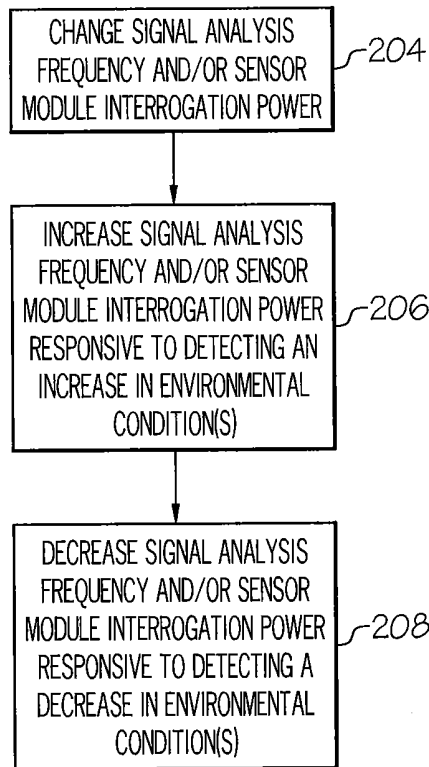

FIG. 9

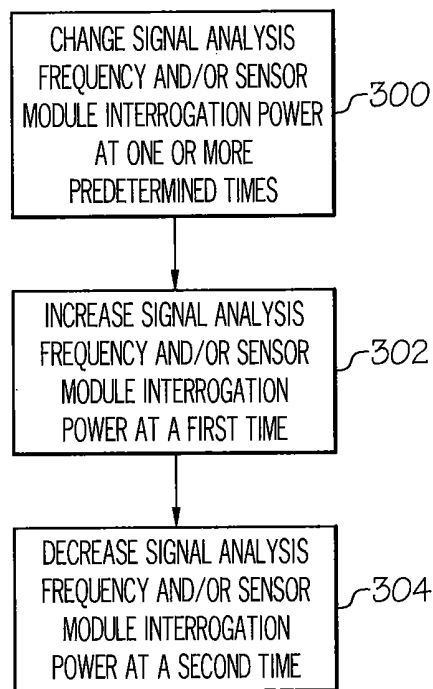

FIG. 10

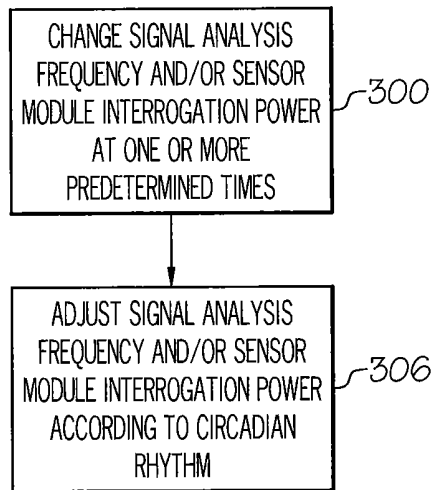

FIG. 11

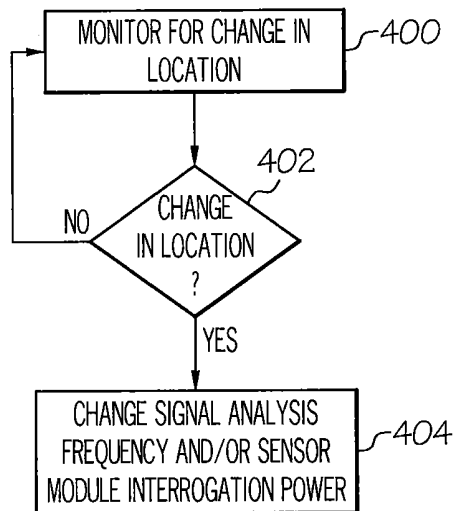

FIG. 12

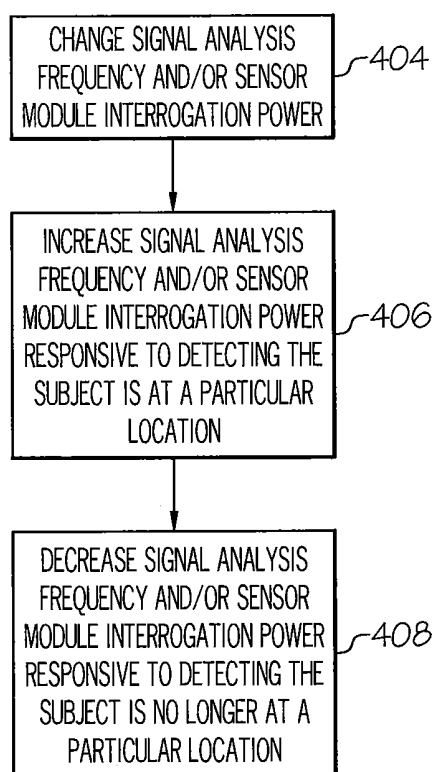

FIG. 13

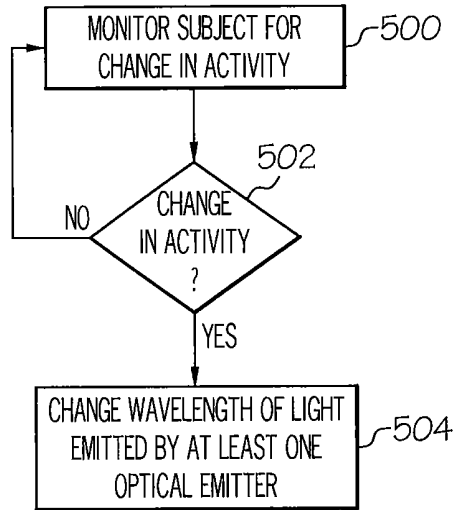

FIG. 14

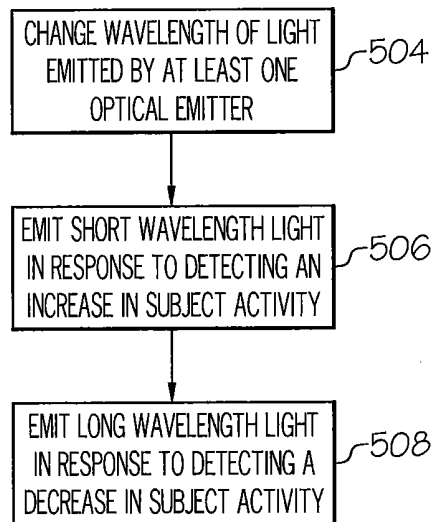

FIG. 15

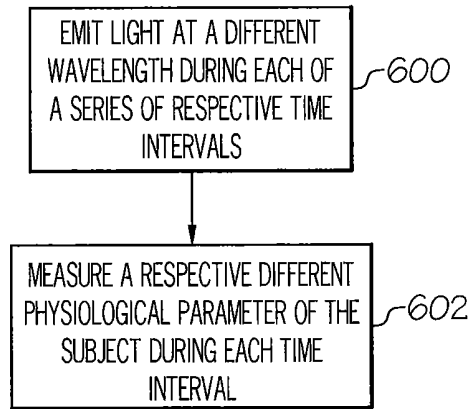

FIG. 16

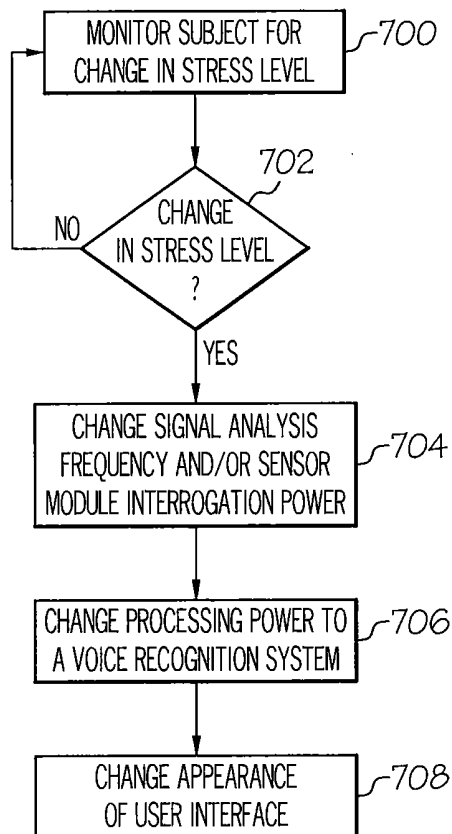

FIG. 17

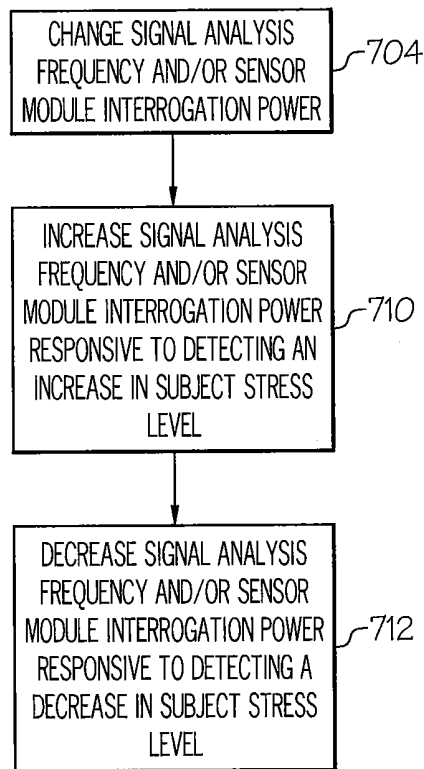

FIG. 18

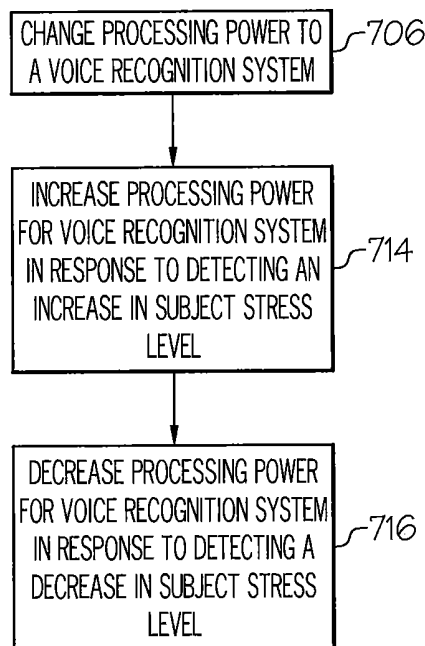

FIG. 19

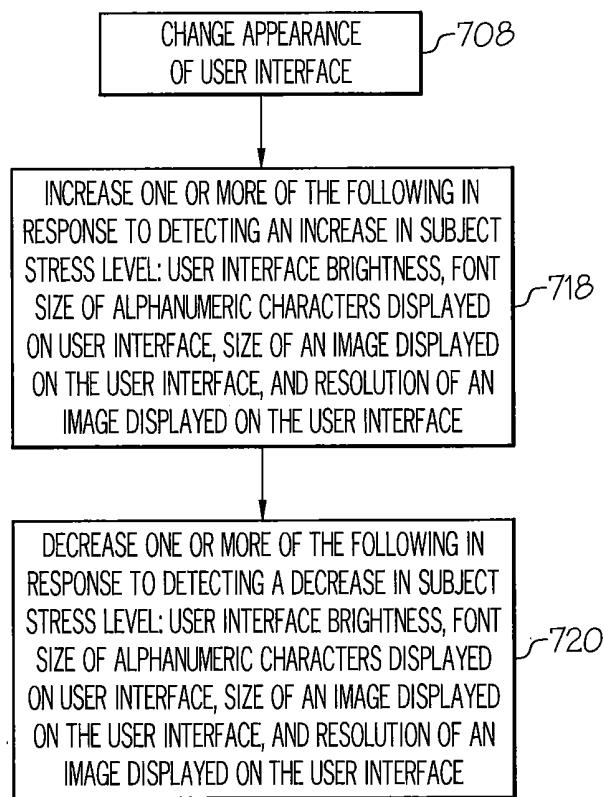

FIG. 20

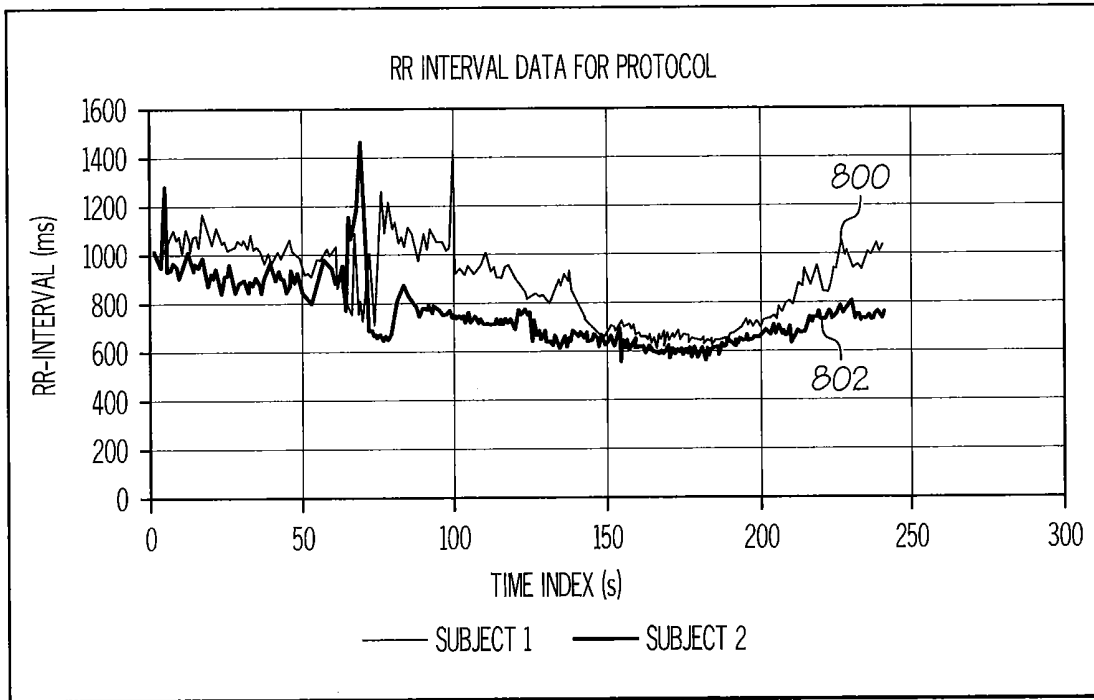

FIG. 21A

810

Parameter	Subject 1 250 Hz	Subject 1 125 Hz	Subject 1 25 Hz	Subject 2 250 Hz	Subject 2 125 Hz	Subject 2 25 Hz
Median (ms)	868	870	880	714	716	720
Mean (ms)	862	862	865	740	740	734
SD (ms)	161	165	167	130	132	121
NN50	43	42	31	31	35	45

FIG. 21B

## PHYSIOLOGICAL MONITORING DEVICES AND METHODS USING OPTICAL SENSORS

### RELATED APPLICATIONS

[0001] This application is a continuation application of U.S. patent application Ser. No. 16/503,191, filed Jul. 3, 2019, which is a continuation application of pending U.S. patent application Ser. No. 14/807,149, filed Jul. 23, 2015, and which claims the benefit of and priority to U.S. Provisional Patent Application No. 62/030,951 filed Jul. 30, 2014, and U.S. Provisional Patent Application No. 62/109,196 filed Jan. 29, 2015, the disclosures of which are incorporated herein by reference as if set forth in their entireties.

### FIELD OF THE INVENTION

[0002] The present invention relates generally to monitoring devices and, more particularly, to monitoring devices for measuring physiological information.

### BACKGROUND OF THE INVENTION

[0003] Photoplethysmography (PPG) is based upon shining light into the human body and measuring how the scattered light intensity changes with each pulse of blood flow. The scattered light intensity will change in time with respect to changes in blood flow or blood opacity associated with heart beats, breaths, blood oxygen level (SpO<sub>2</sub>), and the like. Such a sensing methodology may require the magnitude of light energy reaching the volume of flesh being interrogated to be steady and consistent so that small changes in the quantity of scattered photons can be attributed to varying blood flow. If the incidental and scattered photon count magnitude changes due to light coupling variation between the source or detector and the skin or other body tissue, then the signal of interest can be difficult to ascertain due to large photon count variability caused by motion artifacts. Changes in the surface area (and volume) of skin or other body tissue being impacted with photons, or varying skin surface curvature reflecting significant portions of the photons may also significantly impact optical coupling efficiency. Physical activity, such as walking, cycling, running, etc., may cause motion artifacts in the optical scatter signal from the body, and time-varying changes in photon intensity due to motion artifacts may swamp-out time-varying changes in photon intensity due to blood flow changes. Each of these changes in optical coupling can dramatically reduce the signal-to-noise ratio (S/N) of biometric PPG information to total time-varying photonic interrogation count. This can result in a much lower accuracy in metrics derived from PPG data, such as heart rate and breathing rate.

[0004] An earphone, such as a headset, earbud, etc., may be a good choice for incorporation of a photoplethysmograph device because it is a form factor that individuals are familiar with, it is a device that is commonly worn for long periods of time, and it frequently is used during exercise which is a time when individuals may benefit most from having accurate heart rate data (or other physiological data). Unfortunately, incorporation of a photoplethysmograph device into an earphone poses several challenges. For example, earphones may be uncomfortable to wear for long periods of time, particularly if they deform the ear surface. Moreover, human ear anatomy may vary significantly from person to person, so finding an earbud form that will fit comfortably in many ears may pose significant challenges.

In addition, earbuds made for vigorous physical activity typically incorporate an elastomeric surface and/or elastomeric features to function as springs that dampen earbud acceleration within the ear. Although, these features may facilitate retention of an earbud within an ear during high acceleration and impact modalities, they may not adequately address optical skin coupling requirements needed to achieve quality photoplethysmography.

[0005] Conventional photoplethysmography devices, as illustrated for example in FIGS. 1A-1C, typically suffer from reduced skin coupling as a result of subject motion. For example, most conventional photoplethysmography devices use a spring to clip the sensor onto either an earlobe (FIG. 1A) or a fingertip (FIG. 1B). Unfortunately, these conventional devices tend to have a large mass and may not maintain consistent skin contact when subjected to large accelerations, such as when a subject is exercising.

[0006] A conventional earbud device that performs photoplethysmography in the ear is the MX-D100 player from Perception Digital of Wanchai, Hong Kong ([www.perceptiondigital.com](http://www.perceptiondigital.com)). This earbud device, illustrated in FIG. 1C and indicated as 10, incorporates a spring biased member 12 to improve PPG signal quality. The member 12 is urged by a spring or other biasing element (not shown) in the direction of arrow A<sub>1</sub>, as indicated in FIG. 1C. The spring biased member 12 forcibly presses the entire earbud 10 within the ear E of a subject to minimize motion of the entire earbud 10. However, there are several drawbacks to the device 10 of FIG. 1C. For example, the source/sensor module is coupled to the entire earbud mass and, as such, may experience larger translation distances resulting in greater signal variability when the ear undergoes accelerations. In addition, because the earbud 10 is held in place with one primary spring force direction, significant discomfort can be experienced by the end user. Moreover, the earbud motion is only constrained in one direction (i.e., the direction indicated by A<sub>1</sub>) due to the single spring force direction.

[0007] Because PPG used in wearable devices employs an optical technology, requiring the powering of optical emitters and microprocessors via a wearable battery, managing power consumption can be challenging. For example, high-power algorithms may be required to accurately measure heart rate during exercise. Thus, employing a high-power algorithm during exercise may have the benefit of accurately monitoring heart rate during exercise but may also have the unwanted effect of draining the battery of the wearable device such that the device will not have enough power to measure a subject over the course of a day or week during non-exercising periods.

### SUMMARY

[0008] It should be appreciated that this Summary is provided to introduce a selection of concepts in a simplified form, the concepts being further described below in the Detailed Description. This Summary is not intended to identify key features or essential features of this disclosure, nor is it intended to limit the scope of the invention.

[0009] According to some embodiments of the present invention, a monitoring device configured to be attached to a body of a subject includes a sensor that is configured to detect and/or measure physiological information from the subject and a processor coupled to the sensor that is configured to receive and analyze signals produced by the sensor. The sensor may be an optical sensor that includes at

least one optical emitter and at least one optical detector, although various other types of sensors may be utilized. The processor is configured to change the signal analysis frequency (i.e., the signal sampling rate), sensor algorithm, and/or sensor interrogation power in response to detecting a change in subject activity. For example, in some embodiments, the processor increases signal analysis frequency and/or sensor interrogation power in response to detecting an increase in subject activity, and decreases signal analysis frequency and/or sensor interrogation power in response to detecting a decrease in subject activity. In other embodiments, the processor may change the sensor algorithm in response to a change in subject activity. For example, the processor may implement frequency-domain digital signal processing in response to detecting high subject activity, and implement time-domain digital signal processing in response to detecting low subject activity. The frequency- and time-domain algorithms represent two different signal extraction methods for extracting accurate biometrics from optical sensor signals, where the frequency-domain algorithm may require substantially greater processing power than that of the time-domain algorithm.

**[0010]** In some embodiments, detecting a change in subject activity comprises detecting a change in at least one subject vital sign, such as subject heart rate, subject blood pressure, subject temperature, subject respiration rate, subject perspiration rate, etc. In other embodiments, the sensor includes a motion sensor, such as an accelerometer, gyroscope, etc., and detecting a change in subject activity includes detecting a change in subject motion via the motion sensor. In some embodiments, detecting a change in subject activity may include predicting a type of activity the subject is engaged in.

**[0011]** According to some embodiments of the present invention, a method of monitoring a subject via a monitoring device having a sensor includes changing signal analysis frequency and/or sensor interrogation power in response to detecting a change in subject activity. In some embodiments, detecting a change in subject activity comprises detecting a change in at least one subject vital sign, such as subject heart rate, subject blood pressure, subject temperature, subject respiration rate, and/or subject perspiration rate, etc. In other embodiments, detecting a change in subject activity comprises detecting a change in subject motion via a motion sensor associated with the sensor.

**[0012]** In some embodiments, changing signal analysis frequency and/or sensor interrogation power in response to detecting a change in subject activity includes increasing signal analysis frequency and/or sensor interrogation power in response to detecting an increase in subject activity, and decreasing signal analysis frequency and/or sensor interrogation power in response to detecting a decrease in subject activity. In other embodiments, the processor is configured to implement frequency-domain digital signal processing in response to detecting high subject activity, and to implement time-domain digital signal processing in response to detecting low subject activity.

**[0013]** According to other embodiments of the present invention, a monitoring device configured to be attached to a subject includes a sensor configured to detect and/or measure physiological information from the subject. The monitoring device also includes a processor coupled to the sensor that is configured to receive and analyze signals produced by the sensor. The sensor may be an optical sensor

that includes at least one optical emitter and at least one optical detector, although various other types of sensors may be utilized. The processor is configured to change signal analysis frequency and/or sensor interrogation power in response to detecting, via the sensor or another sensor, a change in the at least one environmental condition, such as temperature, humidity, air quality, barometric pressure, radiation, light intensity, and sound. For example, in some embodiments, the processor increases signal analysis frequency and/or sensor interrogation power in response to detecting an increase in the at least one environmental condition, and decreases signal analysis frequency and/or sensor interrogation power in response to detecting a decrease in the at least one environmental condition.

**[0014]** In some embodiments, a method of monitoring a subject via a monitoring device includes changing signal analysis frequency and/or sensor interrogation power in response to detecting a change in at least one environmental condition. For example, in some embodiments, changing signal analysis frequency and/or sensor interrogation power in response to detecting a change in at least one environmental condition includes increasing signal analysis frequency and/or sensor interrogation power in response to detecting an increase in at least one environmental condition, and decreasing signal analysis frequency and/or sensor interrogation power in response to detecting a decrease in at least one environmental condition.

**[0015]** According to other embodiments of the present invention, a monitoring device configured to be attached to a subject includes a clock (e.g., a digital clock, an internal software clock, etc.) or is in communication with a clock, a sensor configured to detect and/or measure physiological information from the subject, and a processor coupled to the clock and the sensor. The sensor may be an optical sensor that includes at least one optical emitter and at least one optical detector, although various other types of sensors may be utilized. The processor is configured to receive and analyze signals produced by the sensor, and is configured to change signal analysis frequency and/or sensor interrogation power at one or more predetermined times. For example, in some embodiments, the processor increases signal analysis frequency and/or sensor interrogation power at a first time, and decreases signal analysis frequency and/or sensor interrogation power at a second time. In other embodiments, the processor adjusts signal analysis frequency and/or sensor interrogation power according to a circadian rhythm of the subject.

**[0016]** According to some embodiments, a method of monitoring a subject via a monitoring device includes changing signal analysis frequency and/or sensor interrogation power at one or more predetermined times. In some embodiments, changing signal analysis frequency and/or sensor interrogation power at one or more predetermined times includes increasing signal analysis frequency and/or sensor interrogation power at a first time, and decreasing signal analysis frequency and/or sensor interrogation power at a second time. In other embodiments, changing signal analysis frequency and/or sensor interrogation power at one or more predetermined times comprises adjusting signal analysis frequency and/or sensor interrogation power according to a circadian rhythm of the subject.

**[0017]** According to other embodiments of the present invention, a monitoring device configured to be attached to a subject includes a location sensor or is in communication

with a location sensor, a sensor configured to detect and/or measure physiological information from the subject, and a processor coupled to the location sensor and the sensor. The sensor may be an optical sensor that includes at least one optical emitter and at least one optical detector, although various other types of sensors may be utilized. The processor is configured to receive and analyze signals produced by the sensor and to change signal analysis frequency and/or sensor interrogation power when the subject has changed locations. For example, in some embodiments, the processor increases signal analysis frequency and/or sensor interrogation power when the subject is at a particular location, and decreases signal analysis frequency and/or sensor interrogation power when the subject is no longer at the particular location.

**[0018]** According to some embodiments, a method of monitoring a subject via a monitoring device includes changing signal analysis frequency and/or sensor interrogation power when a location sensor associated with the monitoring device indicates the subject has changed locations. For example, in some embodiments, signal analysis frequency and/or sensor interrogation power is increased when the subject is at a particular location, and signal analysis frequency and/or sensor interrogation power is decreased when the subject is no longer at the particular location.

**[0019]** According to other embodiments of the present invention, a monitoring device configured to be attached to a subject includes a sensor configured to detect and/or measure physiological information from the subject, and a processor coupled to the sensor. The sensor includes at least one optical emitter and at least one optical detector. The processor is configured to receive and analyze signals produced by the sensor, and is configured to change the wavelength of light emitted by the at least one optical emitter in response to detecting a change in subject activity. In some embodiments, the processor instructs the at least one optical emitter to emit shorter wavelength light (e.g., a decrease in wavelength by 100 nm or more) in response to detecting an increase in subject activity, and instructs the at least one optical emitter to emit longer wavelength light (e.g., an increase in wavelength by 100 nm or more) in response to detecting an decrease in subject activity.

**[0020]** In some embodiments, detecting a change in subject activity comprises detecting a change in at least one subject vital sign, such as subject heart rate, subject blood pressure, subject temperature, subject respiration rate, subject perspiration rate, etc. In other embodiments, the sensor includes a motion sensor, such as an accelerometer, gyroscope, etc., and detecting a change in subject activity includes detecting a change in subject motion via the motion sensor.

**[0021]** In some embodiments, detecting a change in subject activity may include predicting a type of activity the subject is engaged in.

**[0022]** According to some embodiments of the present invention, a method of monitoring a subject via a monitoring device having a sensor includes changing wavelength of light emitted by at least one optical emitter associated with the sensor in response to detecting a change in subject activity. For example, in some embodiments, changing wavelength of light emitted by the at least one optical emitter may include instructing the at least one optical emitter to emit shorter wavelength light in response to detecting an increase in subject activity, and instructing the

at least one optical emitter to emit longer wavelength light in response to detecting an decrease in subject activity.

**[0023]** According to other embodiments of the present invention, a monitoring device configured to be attached to a subject includes a sensor configured to detect and/or measure physiological information from the subject, and a processor coupled to the sensor and configured to receive and analyze signals produced by the sensor. The sensor comprises at least one optical emitter and at least one optical detector, and the processor instructs the at least one optical emitter to emit a different wavelength of light during each of a series of respective time intervals such that a respective different physiological parameter can be measured from the subject during each time interval via the at least one optical detector.

**[0024]** According to some embodiments of the present invention, a method of monitoring a subject via a monitoring device having a sensor with at least one optical emitter and at least one optical detector comprises emitting a different wavelength of light during each of a series of respective time intervals, and measuring a respective different physiological parameter of the subject during each time interval via the at least one optical detector.

**[0025]** According to other embodiments of the present invention, a monitoring device configured to be attached to a subject includes a sensor configured to detect and/or measure physiological information from the subject, and a processor coupled to the sensor. The processor is configured to receive and analyze signals produced by the sensor, and is configured to change signal analysis frequency and/or change sensor interrogation power in response to detecting a change in subject stress level (e.g., by detecting a change in at least one subject vital sign, such as heart rate, blood pressure, temperature, respiration rate, and/or perspiration rate). For example, in some embodiments, the processor increases signal analysis frequency and/or increases sensor interrogation power in response to detecting an increase in subject stress level, and decreases signal analysis frequency and/or decreases sensor interrogation power in response to detecting a decrease in subject stress level.

**[0026]** In some embodiments, the sensor comprises a voice recognition system. The processor is configured to increase processing power for the voice recognition system in response to detecting an increase in subject stress level, and to decrease processing power for the voice recognition system in response to detecting an decrease in subject stress level.

**[0027]** In some embodiments, the sensor is in communication with a user interface. In some embodiments, the processor may be configured to increase user interface brightness and/or font size of alphanumeric characters displayed on the user interface in response to detecting an increase in subject stress level, and is configured to decrease user interface brightness and/or font size of alphanumeric characters displayed on the user interface in response to detecting a decrease in subject stress level. In some embodiments, the processor may be configured to enlarge an image displayed within the user interface and/or make an image displayed within the user interface easier to view/comprehend (e.g., increase the resolution of the image, etc.) in response to detecting an increase in subject stress level. The processor may be configured to decrease an image displayed within the user interface and/or reduce the resolution of an

image displayed within the user interface in response to detecting an increase in subject stress level.

[0028] According to some embodiments of the present invention, a method of monitoring a subject via a monitoring device having a sensor includes changing signal analysis frequency and/or changing sensor interrogation power via the processor in response to detecting a change in subject stress level. For example, in some embodiments signal analysis frequency and/or sensor interrogation power is increased in response to detecting an increase in subject stress level, and signal analysis frequency and/or sensor interrogation power is decreased in response to detecting a decrease in subject stress level.

[0029] In some embodiments, the sensor comprises a voice recognition system, and the method includes increasing processing power for the voice recognition system in response to detecting an increase in subject stress level, and decreasing processing power for the voice recognition system in response to detecting a decrease in subject stress level.

[0030] In some embodiments, the sensor is in communication with a user interface, and the method includes increasing user interface brightness and/or font size of alphanumeric characters displayed on the user interface in response to detecting an increase in subject stress level, and decreasing user interface brightness and/or font size of alphanumeric characters displayed on the user interface in response to detecting a decrease in subject stress level.

[0031] According to other embodiments of the present invention, a method of monitoring a subject wearing a PPG sensor device having at least one processor includes processing PPG sensor readings via the at least one processor to determine if the subject is located indoors or outdoors, and selecting a PPG sensor polling routine associated with indoor or outdoor conditions depending on whether the subject is located indoors or outdoors, respectively. In some embodiments, if the subject is located indoors, the PPG sensor polling routine is configured to direct the PPG sensor to utilize light with at least one visible wavelength and at least one infrared (IR) wavelength, and if the subject is located outdoors, the PPG sensor polling routine is configured to direct the PPG sensor to utilize light with at least two distinct IR wavelengths or two different IR wavelength bands. The method may further include determining blood and/or tissue oxygenation of the subject via the PPG sensor.

[0032] Monitoring devices in accordance with some embodiments of the present invention may be configured to be positioned at or within an ear of a subject or secured to an appendage or other body location of the subject

[0033] Monitoring devices, according to embodiments of the present invention, are advantageous over conventional monitoring devices because, by changing signal analysis frequency and/or sensor interrogation power, power savings may be incurred. Moreover, increasing sensing power or sampling frequency may allow for finer, more accurate sensor data to be collected during periods of rapid body activity, e.g., during exercising, running, walking, etc. Conversely sensor data changes during periods of inactivity may be infrequent and require significantly lower power to achieve sufficient data resolution to accurately describe physiological changes.

[0034] It is noted that aspects of the invention described with respect to one embodiment may be incorporated in a different embodiment although not specifically described

relative thereto. That is, all embodiments and/or features of any embodiment can be combined in any way and/or combination. Applicant reserves the right to change any originally filed claim or file any new claim accordingly, including the right to be able to amend any originally filed claim to depend from and/or incorporate any feature of any other claim although not originally claimed in that manner. These and other objects and/or aspects of the present invention are explained in detail below.

#### BRIEF DESCRIPTION OF THE DRAWINGS

[0035] The accompanying drawings, which form a part of the specification, illustrate various embodiments of the present invention. The drawings and description together serve to fully explain embodiments of the present invention.

[0036] FIG. 1A is a perspective view of a conventional PPG device attached to the ear of a person.

[0037] FIG. 1B is a perspective view of a conventional PPG device attached to a finger of a person.

[0038] FIG. 1C illustrates a conventional PPG device attached to the ear of a person, and wherein a biasing element is utilized to retain the photoplethysmography device in the person's ear.

[0039] FIGS. 2A-2B illustrate a monitoring device that can be positioned within an ear of a subject, according to some embodiments of the present invention.

[0040] FIG. 3A illustrates a monitoring device that can be positioned around an appendage of the body of a subject, according to some embodiments of the present invention.

[0041] FIG. 3B is a cross sectional view of the monitoring device of FIG. 3A.

[0042] FIG. 4 is a block diagram of a monitoring device according to some embodiments of the present invention.

[0043] FIG. 5 is a block diagram of a monitoring device according to some embodiments of the present invention.

[0044] FIGS. 6, 7A-7B, and 8-20 are flowcharts of operations for monitoring a subject according to embodiments of the present invention.

[0045] FIG. 21A is a graph illustrating two plots of real-time RRi (R-R interval) measurements taken from two different subjects wearing a PPG sensor during a period of 240 seconds: 60 seconds sitting in a chair, 60 seconds standing in place, 60 seconds fast walking, and 60 seconds of easy walking.

[0046] FIG. 21B is a table which illustrates various calculated statistical metrics for the plots of the two subjects of FIG. 21A at three different polling and sampling frequencies (250 Hz, 125 Hz, and 25 Hz).

#### DETAILED DESCRIPTION

[0047] The present invention will now be described more fully hereinafter with reference to the accompanying figures, in which embodiments of the invention are shown. This invention may, however, be embodied in many different forms and should not be construed as limited to the embodiments set forth herein. Like numbers refer to like elements throughout. In the figures, certain layers, components or features may be exaggerated for clarity, and broken lines illustrate optional features or operations unless specified otherwise. In addition, the sequence of operations (or steps) is not limited to the order presented in the figures and/or claims unless specifically indicated otherwise. Features described with respect to one figure or embodiment can be

associated with another embodiment or figure although not specifically described or shown as such.

**[0048]** It will be understood that when a feature or element is referred to as being “on” another feature or element, it can be directly on the other feature or element or intervening features and/or elements may also be present. In contrast, when a feature or element is referred to as being “directly on” another feature or element, there are no intervening features or elements present. It will also be understood that, when a feature or element is referred to as being “secured”, “connected”, “attached” or “coupled” to another feature or element, it can be directly secured, directly connected, attached or coupled to the other feature or element or intervening features or elements may be present. In contrast, when a feature or element is referred to as being “directly secured”, “directly connected”, “directly attached” or “directly coupled” to another feature or element, there are no intervening features or elements present. Although described or shown with respect to one embodiment, the features and elements so described or shown can apply to other embodiments.

**[0049]** The terminology used herein is for the purpose of describing particular embodiments only and is not intended to be limiting of the invention. As used herein, the singular forms “a”, “an” and “the” are intended to include the plural forms as well, unless the context clearly indicates otherwise. As used herein, the terms “comprise”, “comprising”, “comprises”, “include”, “including”, “includes”, “have”, “has”, “having”, or variants thereof are open-ended, and include one or more stated features, integers, elements, steps, components or functions but does not preclude the presence or addition of one or more other features, integers, elements, steps, components, functions or groups thereof. Furthermore, as used herein, the common abbreviation “e.g.,” which derives from the Latin phrase “*exempli gratia*,” may be used to introduce or specify a general example or examples of a previously mentioned item, and is not intended to be limiting of such item. The common abbreviation “i.e.,” which derives from the Latin phrase “*id est*,” may be used to specify a particular item from a more general recitation.

**[0050]** As used herein, the term “and/or” includes any and all combinations of one or more of the associated listed items and may be abbreviated as “/”.

**[0051]** As used herein, phrases such as “between X and Y” and “between about X and Y” should be interpreted to include X and Y. As used herein, phrases such as “between about X and Y” mean “between about X and about Y.” As used herein, phrases such as “from about X to Y” mean “from about X to about Y.”

**[0052]** Spatially relative terms, such as “under”, “below”, “lower”, “over”, “upper” and the like, may be used herein for ease of description to describe one element or feature’s relationship to another element(s) or feature(s) as illustrated in the figures. It will be understood that the spatially relative terms are intended to encompass different orientations of the device in use or operation in addition to the orientation depicted in the figures. For example, if a device in the figures is inverted, elements described as “under” or “beneath” other elements or features would then be oriented “over” the other elements or features. Thus, the exemplary term “under” can encompass both an orientation of over and under. The device may be otherwise oriented (rotated 90 degrees or at other orientations) and the spatially relative

descriptors used herein interpreted accordingly. Similarly, the terms “upwardly”, “downwardly”, “vertical”, “horizontal” and the like are used herein for the purpose of explanation only unless specifically indicated otherwise.

**[0053]** It will be understood that although the terms first and second are used herein to describe various features or elements, these features or elements should not be limited by these terms. These terms are only used to distinguish one feature or element from another feature or element. Thus, a first feature or element discussed below could be termed a second feature or element, and similarly, a second feature or element discussed below could be termed a first feature or element without departing from the teachings of the present invention.

**[0054]** Unless otherwise defined, all terms (including technical and scientific terms) used herein have the same meaning as commonly understood by one of ordinary skill in the art to which this invention belongs. It will be further understood that terms, such as those defined in commonly used dictionaries, should be interpreted as having a meaning that is consistent with their meaning in the context of the specification and relevant art and should not be interpreted in an idealized or overly formal sense unless expressly so defined herein. Well-known functions or constructions may not be described in detail for brevity and/or clarity.

**[0055]** The term “about”, as used herein with respect to a value or number, means that the value or number can vary more or less, for example by  $\pm 20\%$ ,  $\pm 10\%$ ,  $\pm 5\%$ ,  $\pm 1\%$ ,  $\pm 0.5\%$ ,  $\pm 0.1\%$ , etc.

**[0056]** The terms “sensor”, “sensing element”, and “sensor module”, as used herein, are interchangeable and refer to a sensor element or group of sensor elements that may be utilized to sense information, such as information (e.g., physiological information, body motion, etc.) from the body of a subject and/or environmental information in a vicinity of the subject. A sensor/sensing element/sensor module may comprise one or more of the following: a detector element, an emitter element, a processing element, optics, mechanical support, supporting circuitry, and the like. Both a single sensor element and a collection of sensor elements may be considered a sensor, a sensing element, or a sensor module.

**[0057]** The term “optical emitter”, as used herein, may include a single optical emitter and/or a plurality of separate optical emitters that are associated with each other.

**[0058]** The term “optical detector”, as used herein, may include a single optical detector and/or a plurality of separate optical detectors that are associated with each other.

**[0059]** The term “wearable sensor module”, as used herein, refers to a sensor module configured to be worn on or near the body of a subject.

**[0060]** The terms “monitoring device” and “biometric monitoring device”, as used herein, are interchangeable and include any type of device, article, or clothing that may be worn by and/or attached to a subject and that includes at least one sensor/sensing element/sensor module. Exemplary monitoring devices may be embodied in an earpiece, a headpiece, a finger clip, a digit (finger or toe) piece, a limb band (such as an arm band or leg band), an ankle band, a wrist band, a nose piece, a sensor patch, eyewear (such as glasses or shades), apparel (such as a shirt, hat, underwear, etc.), a mouthpiece or tooth piece, contact lenses, or the like.

**[0061]** The term “monitoring” refers to the act of measuring, quantifying, qualifying, estimating, sensing, calculating, interpolating, extrapolating, inferring, deducing, or any

combination of these actions. More generally, “monitoring” refers to a way of getting information via one or more sensing elements. For example, “blood health monitoring” includes monitoring blood gas levels, blood hydration, and metabolite/electrolyte levels.

**[0062]** The term “headset”, as used herein, is intended to include any type of device or earpiece that may be attached to or near the ear (or ears) of a user and may have various configurations, without limitation. Headsets incorporating optical sensor modules, as described herein, may include mono headsets (a device having only one earbud, one earpiece, etc.) and stereo headsets (a device having two earbuds, two earpieces, etc.), earbuds, hearing aids, ear jewelry, face masks, headbands, and the like. In some embodiments, the term “headset” may include broadly headset elements that are not located on the head but are associated with the headset. For example, in a “medallion” style wireless headset, where the medallion comprises the wireless electronics and the headphones are plugged into or hard-wired into the medallion, the wearable medallion would be considered part of the headset as a whole. Similarly, in some cases, if a mobile phone or other mobile device is intimately associated with a plugged-in headphone, then the term “headset” may refer to the headphone-mobile device combination. The terms “headset” and “earphone”, as used herein, are interchangeable.

**[0063]** The term “physiological” refers to matter or energy of or from the body of a creature (e.g., humans, animals, etc.). In embodiments of the present invention, the term “physiological” is intended to be used broadly, covering both physical and psychological matter and energy of or from the body of a creature.

**[0064]** The term “body” refers to the body of a subject (human or animal) that may wear a monitoring device, according to embodiments of the present invention.

**[0065]** The term “processor” is used broadly to refer to a signal processor or computing system or processing or computing method which may be localized or distributed. For example, a localized signal processor may comprise one or more signal processors or processing methods localized to a general location, such as to a wearable device. Examples of such wearable devices may comprise an earpiece, a headpiece, a finger clip, a digit (finger or toe) piece, a limb band (such as an arm band or leg band), an ankle band, a wrist band, a nose piece, a sensor patch, eyewear (such as glasses or shades), apparel (such as a shirt, hat, underwear, etc.), a mouthpiece or tooth piece, contact lenses, or the like. Examples of a distributed processor comprise “the cloud”, the internet, a remote database, a remote processor computer, a plurality of remote processors or computers in communication with each other, or the like, or processing methods distributed amongst one or more of these elements. The key difference is that a distributed processor may include delocalized elements, whereas a localized processor may work independently of a distributed processing system. As a specific example, microprocessors, microcontrollers, ASICs (application specific integrated circuits), analog processing circuitry, or digital signal processors are a few non-limiting examples of physical signal processors that may be found in wearable devices.

**[0066]** The term “remote” does not necessarily mean that a remote device is a wireless device or that it is a long distance away from a device in communication therewith. Rather, the term “remote” is intended to reference a device

or system that is distinct from another device or system or that is not substantially reliant on another device or system for core functionality. For example, a computer wired to a wearable device may be considered a remote device, as the two devices are distinct and/or not substantially reliant on each other for core functionality. However, any wireless device (such as a portable device, for example) or system (such as a remote database for example) is considered remote to any other wireless device or system.

**[0067]** The terms “signal analysis frequency” and “signal sampling rate”, as used herein, are interchangeable and refer to the number of samples per second (or per other unit) taken from a continuous sensor (i.e., physiological sensor and environmental sensor) signal to ultimately make a discrete signal.

**[0068]** The term “sensor module interrogation power”, as used herein, refers to the amount of electrical power required to operate one or more sensors (i.e., physiological sensors and environmental sensors) of a sensor module and/or any processing electronics or circuitry (such as microprocessors and/or analog processing circuitry) associated therewith. Examples of decreasing the sensor interrogation power may include lowering the voltage or current through a sensor element (such as lowering the voltage or current applied to a pair of electrodes), lowering the polling (or polling rate) of a sensor element (such as lowering the frequency at which an optical emitter is flashed on/off in a PPG sensor), lowering the sampling frequency of a stream of data (such as lowering the sampling frequency of the output of an optical detector in a PPG sensor), selecting a lower-power algorithm (such as selecting a power-efficient time-domain processing method for measuring heart rate vs. a more power-hungry frequency-domain processing method), or the like. Lowering the interrogation power may also include powering only one electrode, or powering less electrodes, in a sensor module or sensor element such that less total interrogation power is exposed to the body of a subject. For example, lowering the interrogation power of a PPG sensor may comprise illuminating only one light-emitting diode rather than a plurality of light-emitting diodes that may be present in the sensor module, and lowering the interrogation power of a bioimpedance sensor may comprise powering only one electrode pair rather than a plurality of electrodes that may be present in the bioimpedance sensor module.

**[0069]** The term “polling” typically refers to controlling the intensity of an energy emitter of a sensor or to the “polling rate” and/or duty cycle of an energy emitter element in a sensor, such as an optical emitter in a PPG sensor or an ultrasonic driver in an ultrasonic sensor. Polling may also refer to the process of collecting and not collecting sensor data at certain periods of time. For example, a PPG sensor may be “polled” by controlling the intensity of one or more optical emitters, i.e. by pulsing the optical emitter over time. Similarly, the detector of a PPG sensor may be polled by reading data from that sensor only at a certain point in time or at certain intervals, i.e., as in collecting data from the detector of a PPG sensor for a brief period during each optical emitter pulse. A sensor may also be polled by turning on or off one or more elements of that sensor in time, such as when a PPG sensor is polled to alternate between multiple LED wavelengths over time or when an ultrasonic sensor is polled to alternate between mechanical vibration frequencies over time.

[0070] The terms “sampling frequency”, “signal analysis frequency”, and “signal sampling rate”, as used herein, are interchangeable and refer to the number of samples per second (or per other unit) taken from a continuous sensor or sensing element (for example, the sampling rate of the thermopile output in a tympanic temperature sensor).

[0071] It should be noted that processes for managing hysteresis are implied herein. Namely, several embodiments herein for controlling sensors (and other wearable hardware) may involve a processor sending commands to a sensor element depending on the sensor readings. Thus, in some embodiments, a sensor reading (such as a reading from an optical detector or a sensing electrode) above X may result in a processor sending a command to electrically bias another sensor element (such as an optical emitter or a biasing electrode) above Y. Similarly, as soon as the sensor reading drops below X, a processor may send a command to bias another sensor element below Y. However, in borderline situations this may cause unwanted hysteresis in the biasing command, as sensor readings may rapidly toggle above/below X resulting in the toggling of the biasing of another sensor element above/below Y. As such, hysteresis management may be integrated within the algorithm(s) for controlling the execution of a processor. For example, the processor may be configured by the algorithm to delay a biasing command by a period of time Z following the timing of a prior biasing command, thereby preventing or reducing the aforementioned toggling.

[0072] In the following figures, various monitoring devices will be illustrated and described for attachment to the ear or an appendage of the human body. However, it is to be understood that embodiments of the present invention are not limited to those worn by humans.

[0073] The ear is an ideal location for wearable health and environmental monitors. The ear is a relatively immobile platform that does not obstruct a person’s movement or vision. Monitoring devices located at an ear have, for example, access to the inner-ear canal and tympanic membrane (for measuring core body temperature), muscle tissue (for monitoring muscle tension), the pinna, earlobe, and elsewhere (for monitoring blood gas levels), the region behind the ear (for measuring skin temperature and galvanic skin response), and the internal carotid artery (for measuring cardiopulmonary functioning), etc. The ear is also at or near the point of exposure to: environmental breathable toxicants of interest (volatile organic compounds, pollution, etc.); noise pollution experienced by the ear; and lighting conditions for the eye. Furthermore, as the ear canal is naturally designed for transmitting acoustical energy, the ear provides a good location for monitoring internal sounds, such as heartbeat, breathing rate, and mouth motion.

[0074] Optical coupling into the blood vessels of the ear may vary between individuals. As used herein, the term “coupling” refers to the interaction or communication between excitation energy (such as light) entering a region and the region itself. For example, one form of optical coupling may be the interaction between excitation light generated from within an optical sensor of an earbud (or other device positioned at or within an ear) and the blood vessels of the ear. In one embodiment, this interaction may involve excitation light entering the ear region and scattering from a blood vessel in the ear such that the temporal change in intensity of scattered light is proportional to a temporal change in blood flow within the blood vessel. Another form

of optical coupling may be the interaction between excitation light generated by an optical emitter within an earbud and a light-guiding region of the earbud. Thus, an earbud with integrated light-guiding capabilities, wherein light can be guided to multiple and/or select regions along the earbud, can assure that each individual wearing the earbud will generate an optical signal related to blood flow through the blood vessels. Optical coupling of light to a particular ear region of one person may not yield photoplethysmographic signals for each person. Therefore, coupling light to multiple regions may assure that at least one blood-vessel-rich region will be interrogated for each person wearing an earbud. Coupling multiple regions of the ear to light may also be accomplished by diffusing light from a light source within an earbud.

[0075] According to some embodiments of the present invention, “smart” monitoring devices including, but not limited to, armbands and earbuds, are provided that change signal analysis frequency and/or sensor module interrogation power in response to detecting a change in subject activity, a change in environmental conditions, a change in time, a change in location of the subject and/or a change in stress level of the subject.

[0076] FIGS. 2A-2B illustrate a monitoring apparatus 20 configured to be positioned within an ear of a subject, according to some embodiments of the present invention. The illustrated apparatus 20 includes an earpiece body or housing 22, a sensor module 24, a stabilizer 25, and a sound port 26. When positioned within the ear of a subject, the sensor module 24 has a region 24a configured to contact a selected area of the ear. The illustrated sensor region 24a is contoured (i.e., is “form-fitted”) to matingly engage a portion of the ear between the anti tragus and acoustic meatus, and the stabilizer is configured to engage the anti-helix. However, monitoring devices in accordance with embodiments of the present invention can have sensor modules with one or more regions configured to engage various portions of the ear. Various types of device configured to be worn at or near the ear may be utilized in conjunction with embodiments of the present invention.

[0077] FIGS. 3A-3B illustrate a monitoring apparatus 30 in the form of a sensor band 32 configured to be secured to an appendage (e.g., an arm, wrist, hand, finger, toe, leg, foot, neck, etc.) of a subject. The band 32 includes a sensor module 34 on or extending from the inside surface 32a of the band 32. The sensor module 34 is configured to detect and/or measure physiological information from the subject and includes a sensor region 34a that is contoured to contact the skin of a subject wearing the apparatus 30.

[0078] Embodiments of the present invention may be utilized in various devices and articles including, but not limited to, patches, clothing, etc. Embodiments of the present invention can be utilized wherever PPG and blood flow signals can be obtained and at any location on the body of a subject. Embodiments of the present invention are not limited to the illustrated monitoring devices 20, 30 of FIGS. 2A-2B and 3A-3B.

[0079] The sensor modules 24, 34 for the illustrated monitoring devices 20, 30 of FIGS. 2A-2B and 3A-3B are configured to detect and/or measure physiological information from a subject wearing the monitoring devices 20, 30. In some embodiments, the sensor modules 24, 34 may be

configured to detect and/or measure one or more environmental conditions in a vicinity of the subject wearing the monitoring devices 20, 30.

**[0080]** A sensor module utilized in accordance with embodiments of the present invention may be an optical sensor module that includes at least one optical emitter and at least one optical detector. Exemplary optical emitters include, but are not limited to light-emitting diodes (LEDs), laser diodes (LDs), compact incandescent bulbs, micro-plasma emitters, IR blackbody sources, or the like. In addition, a sensor module may include various types of sensors including and/or in addition to optical sensors. For example, a sensor module may include one or more inertial sensors (e.g., an accelerometer, piezoelectric sensor, vibration sensor, photorelector sensor, etc.) for detecting changes in motion, one or more thermal sensors (e.g., a thermopile, thermistor, resistor, etc.) for measuring temperature of a part of the body, one or more electrical sensors for measuring changes in electrical conduction, one or more skin humidity sensors, and/or one or more acoustical sensors.

**[0081]** Referring to FIG. 4, a monitoring device (e.g., monitoring devices 20, 30), according to embodiments of the present invention, includes at least one processor 40 that is coupled to the sensor(s) of a sensor module 24, 34 and that is configured to receive and analyze signals produced by the sensor(s). Collectively, the elements of FIG. 4 present a system for intelligently controlling power consumption in a wearable monitor, such as monitoring devices 20, 30.

**[0082]** The processor 40 is configured to change signal analysis frequency and/or sensor module interrogation power in response to detecting a change in activity of a subject wearing the monitoring device. For example, in some embodiments, the processor 40 increases signal analysis frequency and/or sensor module interrogation power in response to detecting an increase in subject activity, and decreases signal analysis frequency and/or sensor module interrogation power in response to detecting a decrease in subject activity. In other embodiments, the processor 40 implements frequency-domain digital signal processing in response to detecting high subject activity (e.g., the subject starts running, exercising, etc.), and implements time-domain digital signal processing in response to detecting low subject activity. The frequency- and time-domain algorithms represent two different signal extraction methods for extracting accurate biometrics from optical sensor signals, where the frequency-domain algorithm may require substantially greater processing power than that of the time-domain algorithm. The reason that frequency-domain algorithms may require more power is because spectral transforms may be employed, whereas time-domain algorithms may employ lower-power filters and pulse picking.

**[0083]** An analysis platform 50 may be in communication with the processor 40 and a memory storage location 60 for the algorithms. The analysis platform 50 may be within a wearable device (e.g., monitoring devices 20, 30) or may be part of a remote system in wireless or wired communication with the wearable device. The analysis platform 50 may analyze data generated by the processor 40 to generate assessments based on the data. For example, the analysis platform 50 may analyze vital sign data (such as heart rate, respiration rate, RRi, blood pressure, etc.) in context of the user's activity data to assess a health or fitness status of the person, such as a health or fitness score. In a specific example of such an assessment, the analysis platform 50

may assess a subject's  $VO_2$  max (maximum volume of oxygen consumption) by: 1) identifying data where the subject walked at a speed (as measured by a motion sensor) less than a threshold value (for example, 2.5 mph), 2) selectively analyzing the breathing rate (as measured by a physiological sensor) for this selected data (for example, by taking an average value of the selected breathing rate data and inverting it to get  $1/\text{breathing rate}$ ), and 3) generating a fitness assessment (such as a  $VO_2$  max assessment) by multiplying the inverted value by a scalar value. A number of assessments can be made by analyzing physiological and motion (activity) data, and this is only a specific example.

**[0084]** It should be noted that, herein, the steps described wherein the processor 40 is used to make a determination or decision may be interchanged with the analysis platform 50 instead, as the analysis platform may be configured to have the same features as the processor 40 itself. For example, if the processor 40 determines that a subject's  $VO_2$  max is too high, via an algorithm, the analysis platform 50 may also be configured to assess this determination. Thus, in some embodiments, the analysis platform 50 may be configured such that a processor 40 is not needed, such as the case where a sensor of a sensor module (e.g., sensor module 24, 34) is in wireless communication directly with a remote analysis platform 50.

**[0085]** The analysis platform 50 may be configured to analyze data processed by the processor 40 to assess the efficacy (or confidence value) of the algorithms used by the processor 40 and to autonomously modify the algorithms to improve the acuity of the wearable monitoring device. For example, the processor 40 may be configured to generate a confidence score for a given metric. The confidence score may be an indication of how strongly a processed metric may be trusted. For example, signal-to-noise (S/N) ratio may be processed from a PPG signal by assessing the AC amplitude of the blood flow waveform to a noise value, and a low S/N may represent a low confidence. If the analysis platform 50 determines that confidence value for a given algorithm is low, it may adjust the algorithm for future processing events implemented by the processor 40. For example, the algorithm may be changed such that a threshold may be lowered; as a specific example, the activity threshold for raising the signal analysis frequency and/or sensor module interrogation power may be lowered such that the acuity of the wearable sensor increases during activity. In some embodiments, the analysis platform 50 may determine that an entirely different algorithm must be used for processing, and a replacement algorithm may be selected via command from the analysis platform 50. In some embodiments, this replacement algorithm may be associated with a given confidence value range, and the analysis platform 50 may select the replacement algorithm based on the determined confidence value. For example, if the analysis platform 50 determines that the confidence value of one algorithm is too low for a user, the analysis platform may automatically replace the algorithm with another algorithm that provides higher confidence. However, other methods may be used to select an algorithm for implementation by the processor 40 based on a confidence determination, in accordance with some embodiments of the present invention.

**[0086]** In the case where the sensor module (or modules) comprises PPG sensor functionality, readings from the sensor module (for example, readings from optical sensors or

motion sensors) can be used to trigger changes to the optomechanical engine (the optical emitter, detector, and associated optics). For example, the detection of low activity may change the polling of the optomechanical engine. In a specific example, a detection of low activity may change the optical wavelength used for PPG. In this example, if the activity level processed by the processor 40 is deemed to be “low”, the primary wavelength of detection may shift from visible (such as green or yellow) wavelengths to infrared wavelengths. This can be useful for automatically turning off visible emitters when the person is rested, helping to prevent visible light pollution so that the person can sleep better.

**[0087]** For example, in one embodiment, the processor 40 and/or analysis platform may determine that the person is sleeping, and then the action of changing wavelengths may be initiated by the processor 40 (i.e., via a command to the PPG sensor). This may be achieved by the processor and/or analytics engine processing activity and/or physiological data against a threshold criteria (i.e., processing accelerometer data to determine a state of low enough physical activity and that the person is laying flat/parallel to the ground) and/or physiological model (i.e., processing PPG sensor information to determine that the person’s breathing, heart rate, and/or HRV is of a pattern associated with sleeping) to determine that the person is sleeping. Alternatively, the processor and/or analytics platform may automatically determine that the person is in a dark environment (i.e., by processing optical sensor data to determine that the person is in a dark enough environment) and then send a command to switch change the wavelengths of the PPG sensor. In another embodiment, the user may manually initiate a command (i.e., by pressing a button) that the person is going to sleep, which may then be used by the processor and/or analysis platform to change the wavelengths. Also, although the PPG S/N ratio for infrared (IR) wavelengths may be less than that for visible wavelengths, the total electrical power levels (i.e., the bias voltage) required to bias the IR emitter may be lower, thereby saving battery life in conditions of low activity.

**[0088]** This approach may also be used for pulse oximetry via a PPG sensor. For example, the processor 40 may process sensor readings from a sensor module 24, 34 to determine that the subject wearing the wearable device is indoors or outdoors, and the processor 40 may select a different optomechanical polling routine for indoors vs. outdoors. For example, when indoors, a visible and IR emitter may be engaged to facilitate SpO<sub>2</sub> determination. But once the user is outdoors, where visible outdoor light may pollute PPG sensor readings with noise signals too intense to remove with physical or digital optical filters, the processor may engage (poll) multiple IR emitters instead of the visible and IR emitter, and SpO<sub>2</sub> determination may be executed via two IR wavelength bands rather than a visible+IR wavelength band. For example, the processor 40 may turn off visible emitters when the user is outdoors and may turn on multiple IR emitters, such as a ~700 nm and ~940 nm emitter, instead. Because pulse oximetry requires two distinct wavelengths or two different wavelength bands in order to generate an estimate of SpO<sub>2</sub>, these two IR wavelengths/wavelength bands may be used with efficacy outdoors. The example of these two wavelengths/wavelength bands should not be construed to be limiting, as various wavelength configurations more resilient to outdoor light contamination may be used, such as spectral bands in solar

blind regions (wavelengths that are naturally attenuated by the earth’s atmosphere, such as ~763 nm and others). Additionally, it should be noted that monitoring blood oxygen (SpO<sub>2</sub>) and tissue oxygen may each be achieved via this method, depending on the sensor positioning used. For example, locating a PPG sensor at a leg or arm may facilitate a more accurate determination of muscle oxygenation, whereas locating a PPG sensor at a finger, ear, or forehead may be facilitate a more accurate determination of blood oxygenation. Moreover, the muscle oxygenation signals collected may be used as a proxy for estimating lactic acid and/or lactate threshold (or anaerobic threshold) in the muscle of the subject, as oxygen depletion may be correlated with higher lactic acid build-up in the muscles.

**[0089]** Besides the example just described, autonomously triggering changes in the optomechanical engine of a PPG sensor, in response to activity data sensed by an activity (motion) sensor, can be applied towards a number of useful functions. For example, the detection of low activity may change the type of PPG-based measurement to be executed. This can be useful for cases where the accuracy of a physiological measurement or assessment demands a certain level of physical activity or inactivity. As a specific example, a measurement of blood pressure or RRi (R-R interval, which is the interval from the peak of one QRS complex to the peak of the next as shown on an electrocardiogram) may provide best results during periods of inactivity. The processor 40 may deem that activity is “low enough” to execute one or more of such measurements, and then execute an algorithm to start measuring. This way, blood pressure and/or RRi measurements are only executed at time periods where a reliable measurement can be made, thereby saving system power. Similarly, in some embodiments, a measurement of HRR (heart rate recovery) may be executed only when the processor 40 deems that activity “high enough” to make such a measurement meaningful. For example, the processor 40 may determine that a user’s activity level (perhaps as sensed by an activity sensor) or exertion level (perhaps as sensed by a heart rate sensor) has been high enough for a long enough period of time, followed by a resting phase, such that HRR may be accurately assessed. In this case, several data points of activity level and/or heart rate may be stored in memory or buffered, such that the processor 40 may run through the dataset to determine if the user has been in a state of high activity or exertion for a long enough period of time to justify an HRR measurement. This way, HRR measurements are only executed at time periods where a reliable measurement can be made, saving power consumption.

**[0090]** In another example, if the processor 40 determines that subject activity level has been very low, the processor 40 may engage a longer wavelength light, such as IR light, as the wavelength for PPG. But if subject activity is heightened, the processor 40 may switch the wavelength to a shorter wavelength, such as green, blue, or violet light. Such a process may address the problem of low perfusion, which often prevents PPG readings during periods of subject inactivity, especially for wrist-based PPG sensors. Shorter wavelength light for PPG generally yields a higher signal-to-noise ratio (S/N) over longer wavelength, but low perfusion can reduce blood flow at the surface of the skin, pushing blood flow so far below the surface that shorter wavelength light is absorbed by the skin before reaching blood flow. However, during exercise, perfusion may return and shorter

wavelength light may be used once again, providing a higher S/N for PPG and thereby reducing system power requirements.

[0091] In another example, if the processor 40 determines that subject perfusion is low, for example by processing PPG information to determine that the signal-to-noise level is quite low, the processor 40 may send a command to the sensor module 24, 34 to raise the localized temperature of the neighboring skin, thereby increasing perfusion. This may be achieved by the processor 40 sending a command to turn on a heater element on the sensor module 24, 34 or to increase the electrical bias across an LED such that the LED heats up the skin to encourage blood flow. Once the signal-to-noise level is determined to be high enough for accurate and reliable physiological monitoring by the processor 40, the processor 40 may send a command to terminate heating of the skin.

[0092] For the case of PPG sensor modules 24, 34 in the system of FIG. 4, there are certain wavelengths of light that may be better for sensing specific biometric parameters. For example, whereas IR or green light may be best for sensing heart rate-related modulations in blood flow, blue or violet light may be best for sensing respiration-related modulations in blood flow. Thus, in some embodiments of the present invention, the processor 40 may be configured to select a given PPG wavelength routinely in time, according to an algorithm 60, such that various parameters are measured sequentially in time order rather than being measured simultaneously in a continuous fashion. In this way, various wavelengths of light can be turned on and off at different periods in time in order to measure various biometric parameters in sequence.

[0093] Readings from sensor module(s) can also be used to trigger a change in the algorithm sequence executed by a processor 40. For example if a normal heart rate level and/or heart rate variability (HRV) level is detected by the processor (such as a heart rate and/or HRV within a specified range), then the processor 40 may select an algorithm that has less sequential steps in time, thus saving power on the processor 40. More specifically, once an abnormal heart rate and/or HRV is detected outside the specified range, the processor 40 may select an algorithm that also implements continuous cardiac monitoring, such as monitoring of arrhythmia, atrial fibrillation, blood pressure, cardiac output, irregular heart beats, etc. And when heart rate and/or HRV fall back within the specified range, the processor 40 may return to a lower-power algorithm with less sequential steps in time.

[0094] Readings from the sensor(s) of a monitoring device can be used to trigger events. In addition, sensor signals may be processed and algorithms may be selected to control a biometric signal extraction method. For example, elevated subject physical activity sensed by an accelerometer may trigger a change in the signal extraction algorithm for PPG towards one of higher acuity (but higher power usage); then, when subject activity winds down, the algorithm may change to one that is lower acuity (but lower power usage). In this way, battery power may be preserved for use cases where high acuity is not needed (such as sedentary behavior where motion artifacts need not be removed.)

[0095] In some embodiments, detecting a change in subject activity comprises detecting a change in at least one subject vital sign, such as subject heart rate, subject blood pressure, subject temperature, subject respiration rate, sub-

ject perspiration rate, etc. In other embodiments, the sensor module includes a motion sensor, such as an accelerometer, gyroscope, etc., and detecting a change in subject activity includes detecting a change in subject motion via the motion sensor.

[0096] According to some embodiments, the type of activity may be identified or predicted via the processor 40. Changing signal analysis frequency and/or sensor module interrogation power may be based on stored profiles (such as a look-up table) or learned profiles (such as machine learning with human input) of activity identification information, such as: 1) a known accelerometry profile for a given sport or exercising activity and/or 2) a known accelerometry profile for a particular person, for example.

[0097] According to other embodiments of the present invention, a monitoring device configured to be attached to a subject, such as monitoring devices 20, 30, includes a sensor module configured to detect and/or measure physiological information from the subject and to detect and/or measure at least one environmental condition in a vicinity of the subject. The sensor module may be an optical sensor module that includes at least one optical emitter and at least one optical detector, although various other types of sensors may be utilized. A processor 40 is coupled to the sensor module and is configured to receive and analyze signals produced by the sensor module. In addition, the processor 40 is configured to change signal analysis frequency and/or sensor module interrogation power in response to detecting a change in the at least one environmental condition. Exemplary changes in environmental conditions include changes in one or more of the following ambient conditions: temperature, humidity, air quality, barometric pressure, radiation, light intensity, and sound. In some embodiments, the processor 40 increases signal analysis frequency and/or sensor module interrogation power in response to detecting an increase in the at least one environmental condition, and decreases signal analysis frequency and/or sensor module interrogation power in response to detecting a decrease in the at least one environmental condition. For example, the signal analysis frequency and/or sensor module interrogation power may be increased when air quality worsens or becomes detrimental to the wearer, and signal analysis frequency and/or sensor module interrogation power may be decreased when air quality improves. The principle behind this process is that extreme or harsh ambient changes in environment (such as extreme hot or cold, extreme humidity or dryness, etc.) may lower the S/N ratio of the processed signals. Thus, higher processing power may be required to actively remove noise.

[0098] Referring to FIG. 5, according to other embodiments of the present invention, a monitoring device configured to be attached to a subject, such as monitoring devices 20, 30, includes a clock 82 (or is in communication with a clock 82), a sensor module 24, 34 configured to detect and/or measure physiological information from the subject (and/or environmental condition information in a vicinity of the subject), and a processor 40 coupled to the clock 82 and the sensor module. The sensor module 24, 34 may be an optical sensor module that includes at least one optical emitter and at least one optical detector, although various other types of sensors may be utilized. The processor 40 is configured to receive and analyze signals produced by the sensor module

**24, 34**, and is configured to change signal analysis frequency and/or changes sensor module interrogation power at one or more predetermined times.

[0099] In some embodiments, the processor **40** increases signal analysis frequency and/or sensor module interrogation power at a first time, and decreases signal analysis frequency and/or sensor module interrogation power at a second time. For example, signal analysis frequency and/or sensor module interrogation power may be increased at a particular time of day (e.g., the time of day when the wearer is typically exercising), and may be decreased at another time of day, for example, at a time of day when the wearer is less active (e.g., nighttime, etc.).

[0100] In other embodiments, the processor **40** adjusts signal analysis frequency and/or sensor module interrogation power according to a circadian rhythm of the subject. For example, signal analysis frequency and/or sensor module interrogation power may be increased at a particular time of day (e.g., the time of day when the wearer is at peak metabolism), and may be decreased at another time of day (for example, during sleep).

[0101] In other embodiments, the processor **40** adjusts signal analysis frequency and/or interrogation power of a sensor module **24, 34** or analysis platform **50** based on the determined stress state of the user. For example, the processor **40** may determine that a user is psychologically stressed based on, for example, an elevated heart rate over a period of time during low (not high) physical activity. The processor **40** may then send a signal to another sensor and/or analysis platform, such as a voice analysis/recognition system **84** that is in communication with the system **90** of FIG. **4**, to control the processing power of voice recognition. In this manner, a more stressed psychological state may result in a higher processing power for the voice recognition system **84**; in contrast, a low stress state may trigger lower power processing because it may be easier for the voice recognition system **84** to understand someone when they are calm rather than excited. As another example, the processor **40** may identify a pattern of low heart rate by processing information from a heart rate sensor over a **25**, period of time; in response, the processor may lower the signal analysis frequency and/or interrogation power performed in another simultaneous measurement, such as RRi (R-R interval). Though the sampling frequency may be reduced for the RRi calculation in this example, RRi acuity may not be sacrificed because lower heart rate implies generally longer R-R intervals. Longer intervals do not require high sampling rates for detection/measurement.

[0102] As yet another example, the processor **40** may adjust signal analysis frequency and/or interrogation power of a user interface **70** that is in communication with the system **90** of FIG. **4** (e.g., a user interface of a telecommunication device, such as a smartphone, computer, etc., or a user interface associated with a monitoring device **20, 30**), based on the determined stress state of a subject wearing a monitoring device **20, 30**. In this example, the processor **40** may determine that a user is psychologically stressed and then send a signal (i.e., a command) to the user interface **70**, such as a view screen, such that the font size of displayed text is increased and/or the screen brightness is increased and/or an image displayed within the user interface **70** is easier to view/comprehend (e.g., increase the resolution of the image, etc.). Then, once the processor **40** determines that the subject's stress level is sufficiently low, the processor **40**

may signal a low-power mode of operation for the user interface **70**, by lowering the screen brightness and/font size of displayed text and/or reducing the resolution of a displayed image(s), for example.

[0103] According to other embodiments of the present invention, a monitoring device configured to be attached to a subject, such as monitoring devices **20, 30**, includes a location sensor **80** (FIG. **5**), a sensor module **24, 34** configured to detect and/or measure physiological information from the subject, and a processor **40** coupled to the location sensor **80** and the sensor module **24, 34**. The sensor module **24, 34** may be an optical sensor module that includes at least one optical emitter and at least one optical detector, although various other types of sensors may be utilized. The processor **40** is configured to receive and analyze signals produced by the sensor module **24, 34** and to change signal analysis frequency and/or sensor module interrogation power when the location sensor **80** indicates the subject has changed locations.

[0104] In some embodiments, the processor **40** increases signal analysis frequency and/or sensor module interrogation power when the location sensor **80** indicates the subject is at a particular location, and decreases signal analysis frequency and/or sensor module interrogation power when the location sensor **80** indicates the subject is no longer at the particular location. For example, signal analysis frequency and/or sensor module interrogation power may be increased when the location sensor **80** indicates the subject is at a particular location (e.g., at the gym, outdoors, at the mall, etc.), and may be decreased when the location sensor **80** indicates the subject is no longer at the particular location (e.g., when the wearer is at work, home, etc.). The locations selected for the increase or decrease in processing power may be personalized for the user and stored in memory. For example, people who are more active at outdoors than at work may see the decision tree described above, but for those who are more active at work, the decision tree may be swapped such that higher power processing is selected for work locations over home locations.

[0105] Other factors may be utilized to trigger an increase or decrease in signal analysis frequency and/or sensor module interrogation power. For example, higher body temperature readings detected by a thermal sensor associated with the sensor module **24, 34** may trigger changes in signal analysis frequency and/or sensor module interrogation power. The principle behind this may be that higher body temperatures are associated with higher motion, for example. The detection of higher light levels, the detection of higher changes in light intensity, and/or the detection of particular wavelengths via an optical sensor associated with the sensor module **24, 34** may trigger changes in signal analysis frequency and/or sensor module interrogation power. Lower potential drops detected by an electrical sensor associated with the sensor module **24, 34** may trigger changes in signal analysis frequency and/or sensor module interrogation power. Lower skin humidity readings detected via a humidity sensor associated with the sensor module may trigger changes in signal analysis frequency and/or sensor module interrogation power. Higher acoustic noise levels detected via an acoustical sensor associated with the sensor module **24, 34** may trigger changes in signal analysis frequency and/or sensor module interrogation power.

[0106] Referring now to FIG. **6**, a method of monitoring a subject via a monitoring device, such as monitoring devices

20, 30, according to some embodiments of the present invention, will be described. The monitoring device includes a sensor module 24, 34 configured to detect and/or measure physiological information from the subject and a processor 40 configured to receive and analyze signals produced by the sensor module. The subject is monitored for change in physical activity level (Block 100). If a change is detected (Block 102), the processor 40 changes signal analysis frequency and/or sensor module interrogation power (Block 104).

[0107] As illustrated in FIG. 7A, changing signal analysis frequency and/or sensor module interrogation power (Block 104) may include increasing signal analysis frequency and/or sensor module interrogation power in response to detecting an increase in subject activity (Block 106), and decreasing signal analysis frequency and/or sensor module interrogation power in response to detecting a decrease in subject activity (Block 108). As described above, one method of lowering the interrogation power is powering only one electrode, or powering less electrodes, in a sensor module 24, 34 or sensor element such that less total interrogation power is exposed to the body of a subject. For example, in response to detecting an increase in subject activity (Block 106), the system of FIG. 4 may power only one optical emitter (or illuminate less optical emitters) in the sensor module 24, 34, rather than a plurality of optical emitters that may be present in a wearable PPG module. Then, once high activity is detected, for example high activity detected during exercise, the system may return power to all of the optical emitters (or more of the optical emitters) in the PPG module. Because low activity may require less light for accurate PPG monitoring when compared with high physical activity, in the described manner, both high and low activity levels can result in accurate PPG measurements while balancing power requirements.

[0108] In other embodiments as illustrated in FIG. 7B, changing signal analysis frequency and/or sensor module interrogation power (Block 104) may include implementing frequency-domain digital signal processing in response to detecting an increase in subject activity (Block 110), and implementing time-domain digital signal processing in response to detecting a decrease in subject activity (Block 112).

[0109] Referring now to FIG. 8, a method of monitoring a subject via a monitoring device, such as monitoring devices 20, 30, according to some embodiments of the present invention, will be described. The monitoring device includes a sensor module 24, 34 configured to detect and/or measure physiological information from the subject and/or measure at least one environmental condition in a vicinity of the subject, and a processor 40 coupled to the sensor module 24, 34 that is configured to receive and analyze signals produced by the sensor module 24, 34. The vicinity of the subject is monitored for changes in one or more environmental conditions (Block 200). If a change is detected (Block 202), the processor 40 changes signal analysis frequency and/or sensor module interrogation power (Block 204). As illustrated in FIG. 9, changing signal analysis frequency and/or sensor module interrogation power (Block 204) may include increasing signal analysis frequency and/or sensor module interrogation power in response to detecting an increase in an environmental condition (e.g., an increase in temperature, humidity, air pollution, light intensity, sound, etc.) (Block 206), and decreasing signal analysis frequency and/or sensor

module interrogation power in response to detecting a decrease in an environmental condition (e.g., a decrease in temperature, humidity, air pollution, light intensity, sound, etc.) (Block 208).

[0110] Referring now to FIG. 10, a method of monitoring a subject via a monitoring device, such as monitoring devices 20, 30, according to some embodiments of the present invention, will be described. The monitoring device includes or is in communication with a clock 82, a sensor module 24, 34 configured to detect and/or measure physiological information from the subject, and a processor 40 coupled to the clock 82 and the sensor module 24, 34 that is configured to receive and analyze signals produced by the sensor module 24, 34. The processor 40 changes signal analysis frequency and/or sensor module interrogation power at one or more predetermined times (Block 300). For example, signal analysis frequency and/or sensor module interrogation power is increased at a first time (e.g., at a particular time of the day, week, etc.) (Block 302) and signal analysis frequency and/or sensor module interrogation power is decreased at a second time (e.g., another time of the day, week, etc.) (Block 304). In other embodiments, as illustrated in FIG. 11, changing signal analysis frequency and/or sensor module interrogation power at one or more predetermined times (Block 300) includes adjusting signal analysis frequency and/or sensor module interrogation power according to a circadian rhythm of the subject (Block 306).

[0111] Referring now to FIG. 12, a method of monitoring a subject via a monitoring device, such as monitoring devices 20, 30, according to some embodiments of the present invention, will be described. The monitoring device includes a location sensor 80 (or is in communication with a location sensor 80), a sensor module 24, 34 configured to detect and/or measure physiological information from the subject, and a processor 40 coupled to the location sensor 80 and the sensor module 24, 34 that is configured to receive and analyze signals produced by the sensor module 24, 34. The subject is monitored for a change in location (Block 400). If a change is detected (Block 402), the processor 40 changes signal analysis frequency and/or sensor module interrogation power (Block 204). As illustrated in FIG. 13, changing signal analysis frequency and/or sensor module interrogation power (Block 404) may include increasing signal analysis frequency and/or sensor module interrogation power in response to detecting that the subject is at a particular location (Block 406), and decreasing signal analysis frequency and/or sensor module interrogation power in response to detecting that the subject is no longer at the particular location (Block 408). For example, signal analysis frequency and/or sensor module interrogation power may be increased when it is detected that the subject is at the gym and signal analysis frequency and/or sensor module interrogation power may be decreased when it is detected that the subject has returned home.

[0112] Referring now to FIG. 14, a method of monitoring a subject via a monitoring device, such as monitoring devices 20, 30, according to some embodiments of the present invention, will be described. The monitoring device includes a sensor module 24, 34 configured to detect and/or measure physiological information from the subject and a processor configured to receive and analyze signals produced by the sensor module 24, 34. The sensor module 24, 34 includes at least one optical emitter and at least one

optical detector. The subject is monitored for change in physical activity level (Block 500). If a change is detected (Block 502), the processor 40 changes wavelength of light emitted by the at least one optical emitter (Block 504).

[0113] As illustrated in FIG. 15, changing wavelength of light emitted by the at least one optical emitter (Block 504) may include emitting shorter wavelength light in response to detecting an increase in subject activity (Block 506), and emitting longer wavelength light in response to detecting an decrease in subject activity (Block 508). Shorter wavelength light may be less susceptible to motion artifacts. Longer wavelength light may require less battery power and also may be invisible to the eye and thus more appealing for long-term wear of a wearable monitor.

[0114] Referring now to FIG. 16, a method of monitoring a subject via a monitoring device, such as monitoring devices 20, 30, according to some embodiments of the present invention, will be described. The monitoring device includes a sensor module 24, 34 configured to detect and/or measure physiological information from the subject and a processor 40 configured to receive and analyze signals produced by the sensor module 24, 34. The sensor module 24, 34 includes at least one optical emitter and at least one optical detector. The sensor module 24, 34 emits light, via the at least one optical emitter, at one or more wavelengths during each of a series of respective time intervals (Block 600) to facilitate the measurement of a variety of different physiological parameters of the subject in the respective time intervals via data collected by the at least one optical detector (Block 602).

[0115] For example, an algorithm may comprise a list of successive intervals, wherein each interval may comprise: 1) a different polling of the optical emitter and/or detector and/or 2) a different interrogation wavelength or set of interrogation wavelengths. As a specific example, an algorithm may focus on collecting and/or processing information for the measurement of heart rate, RRi, and blood pressure in order. In such case, the following intervals may be executed in series (in no particular order): 1) calculate heart rate, 2) calculate RRi, 3) calculate blood pressure, and 4) calculate breathing rate. Heart rate may be calculated with a processor-intensive calculation to actively remove motion artifacts via a motion (noise) reference, such as footstep and body motion artifacts, as disclosed in U.S. Patent Application Publication No. 2015/0018636, U.S. Patent Application Publication No. 2015/0011898, U.S. Pat. No. 8,700,11, and U.S. Pat. No. 8,157,730, which are incorporated herein by reference in their entireties.

[0116] RRi may be calculated via a time-domain approach, such as applying a processor-efficient peak-finder or by leveraging a heart rate feedback filter to improve RRi tracking, for example as disclosed in U.S. Patent Application Publication No. 2014/0114147, which is incorporated herein by reference in its entirety. Blood pressure may be calculated by processing the photoplethysmogram itself (e.g., via intensity, shape, 1st derivative, 2nd derivative, integral, etc.) via a processor-efficient time-domain algorithm. Breathing rate (respiration rate) may be calculated by running the optical detector signal through a low-pass filter, in some cases by applying a variable feedback loop to align the corner frequency with the heart rate, for example as disclosed in U.S. Patent Application Publication No. 2014/0114147.

[0117] In all four cases of this specific example, a different optical wavelength (or a different set of wavelengths) may

be used. For example, calculating heart rate may employ a variety of different wavelengths, but calculating breathing rate may employ shorter-wavelength light (such as wavelengths shorter than 600 nm, or preferably shorter than 480 nm) such that heart rate PPG signals do not overpower breathing rate PPG signals during processing of breathing rate. In the example just given, with 4-intervals of optical signal sampling, further power reductions can be realized by an algorithm which selects which intervals to execute depending on the activity state of the user. For example, if the activity state reaches a certain threshold, the algorithm may select that only the first and fourth intervals (the heart rate and breathing rate data collection intervals) are activated. Similarly, if the activity state is below a certain threshold, the algorithm may select that only the second and third intervals (the RRi and blood pressure intervals) are activated. In this manner, only the physiological parameters that are relevant to a particular activity state may be calculated, thereby saving system power and increasing the battery life of the wearable monitoring device.

[0118] In some embodiments, the wavelength of the optical emitter and optical detector may stay the same for each interval, but in contrast the sampling and/or polling of the sensor element (i.e., the sampling of the detector(s) and the polling of the emitter(s)) may be changed depending on the measurement goal of each interval. For example, an algorithm may focus on processing at least one photoplethysmogram to measure or estimate 1) blood pressure (highest sampling and/or polling), 2) heart rate variability (2nd-highest sampling and/or polling), and 3) low-motion (“lifestyle”) heart rate monitoring (lowest sampling and/or polling) in sequence. This may be because accurately assessing blood pressure from a photoplethysmogram may require a higher data acuity, whereas accurate heart rate variability may require less acuity, and heart rate under lifestyle (low motion) conditions may require the least acuity. In another embodiment, the polling and/or sampling for blood pressure may be greater than 125 Hz, the polling and/or sampling of HRV may be between 250 Hz and 100 Hz, and the polling and/or sampling of lifestyle heart rate may be less than 75 [0119] Hz.

[0120] In another embodiment, an algorithm may focus on processing at least one photoplethysmogram to generate a single real-time biometric parameter at different intervals, with each interval having a different polling and/or sampling rate. As an example, an algorithm may process a photoplethysmogram to generate RRi at various different intervals where, for each interval, the polling rate of the optical emitter and the sampling rate of the optical detector may be different. As a specific example, there may be three intervals, each having an increasingly lower polling and/or sampling rate. The optimum sampling rate to maintain measurement accuracy while limiting power consumption has been found by experiment, as shown in FIGS. 21A and 21B.

[0121] FIG. 21A presents two plots 800, 802 of real-time RRi measurements taken from two different subjects wearing a PPG sensor (e.g., monitoring devices 20, 30) during a period of 240 seconds: 60 seconds sitting in a chair, 60 seconds standing in place, 60 seconds fast walking, and 60 seconds of easy walking. Plot 800 is of subject one and plot 802 is of subject two. Post analysis of these two datasets yields the table 810 shown in FIG. 21B, which illustrates various calculated statistical metrics for the plots of subject one and subject two at three different polling and sampling

frequencies (250 Hz, 125 Hz, and 25 Hz). It can be seen that the calculated median and mean values of RRI is nearly identical for all of the frequencies for each respective subject. However, the calculated values for SD (standard deviation) and NN50 (the number of pairs of successive R-R intervals, "NNs", that differ by greater than 50 milliseconds) are shown to be dependent on sampling frequency. Thus, from FIG. 21B, in order to maintain measurement accuracy while keeping power consumption low, it can be shown that an ideal polling/sampling for the proposed three intervals may be ~125 Hz for the NN50 calculation, between 125 and 25 Hz for the SD calculation, and 25 Hz for a heart rate calculation during low physical activity (lifestyle conditions).

[0122] Referring now to FIG. 17, a method of monitoring a subject via a monitoring device, such as monitoring devices 20, 30, according to some embodiments of the present invention, will be described. The monitoring device includes a sensor module 24, 34 configured to detect and/or measure physiological information from the subject and a processor 40 configured to receive and analyze signals produced by the sensor module 24, 34. The subject is monitored for change in stress level (Block 700). If a change is detected (Block 702), the processor 40 changes signal analysis frequency and/or sensor module interrogation power (Block 704). In some embodiments, if a change is detected, the measurement intervals (as described previously) may change. In some embodiments, if a change is detected (Block 702), processing power to a voice recognition system 84 associated with the monitoring device is changed (Block 706). In some embodiments, if a change is detected (Block 702), changes in appearance are made to a user interface 70 associated with the monitoring device (Block 708).

[0123] If the system 90 of FIG. 4 determines that the subject is experiencing a certain level of stress, such as the subject having an elevated heart rate in context of low physical activity, the system 90 may increase the number of intervals and/or biometrics that are measured. For example, the system 90 may increase the number of measurement intervals or periods of the intervals in order to assess multiple biometrics, such as respiration rate, blood pressure, and RRI, for example. In this way, in response to an elevated state of subject stress, processing resources may be increased in order to initiate a more thorough biometric analysis of the subject. In contrast, when the stress level is determined to be sufficiently low, the system 90 may reduce the number of measurement intervals and/or reduce the number of biometrics being measured, such as limiting the measurement to heart rate only, for example.

[0124] As illustrated in FIG. 18, changing signal analysis frequency and/or sensor module interrogation power (Block 704) may include increasing signal analysis frequency and/or sensor module interrogation power in response to detecting an increase in subject stress level (Block 710), and decreasing signal analysis frequency and/or sensor module interrogation power in response to detecting a decrease in subject stress level (Block 712). As a specific example, of this embodiment, the algorithm(s) 60 being executed by the processor 40 in the system 90 may be configured to operate in a "screening mode" to analyze the overall stress (well-being or health) of a subject wearing a sensor module 24, 34. When the processor determines that the stress reading is outside of an acceptable range for the subject, the processor

may then focus or increase processing resource towards determining the origin of the stress condition. For example, the processor 40 may process PPG data from a sensor module 24, 34 to determine that a person is likely to have atrial fibrillation, and upon this determination the processor may increase the frequency of the pulsing of the optical emitter(s) of a PPG sensor, and/or increase the sampling rate of the PPG sensor, to collect higher acuity data for definitively diagnosing that atrial fibrillation is truly occurring.

[0125] As illustrated in FIG. 19, changing processing power to a voice recognition system 84 may include increasing processing power for the voice recognition system 84 in response to detecting an increase in subject stress level (Block 714), and decreasing processing power for the voice recognition system 84 in response to detecting a decrease in subject stress level (Block 716). For example, if the system 90 of FIG. 4 determines that the subject is experiencing a certain level of stress, such as the subject having a low heart rate variability, the system 90 may increase the frequency resolution of a voice recognition system 84 such that more types of audio features can be identified, albeit at perhaps a higher power consumption expense. In contrast, when the stress level is determined to be sufficiently low, the system 90 may decrease the frequency resolution of a voice recognition system 84, such that processing power may be saved.

[0126] As illustrated in FIG. 20, changing the appearance of a user interface (Block 708) may include increasing user interface brightness and/or font size of alphanumeric characters displayed on the user interface in response to detecting an increase in subject stress level (Block 718), and decreasing user interface brightness and/or font size of alphanumeric characters displayed on the user interface in response to detecting a decrease in subject stress level (Block 720). For example, if the system 90 of FIG. 4 determines that the subject is experiencing a certain level of stress, such as the subject having an elevated breathing rate in context of low physical activity, the system 90 may increase the brightness of a screen and/or increase the font size of text on a mobile device, such that it is easier for the subject to interpret the screen, albeit at perhaps a higher power consumption expense. In contrast, when the stress level is determined to be sufficiently low, the system 90 may decrease the screen brightness and/or decrease the font size of text.

[0127] Example embodiments are described herein with reference to block diagrams and flowchart illustrations. It is understood that a block of the block diagrams and flowchart illustrations, and combinations of blocks in the block diagrams and flowchart illustrations, can be implemented by computer program instructions that are performed by one or more computer circuits. These computer program instructions may be provided to a processor circuit of a general purpose computer circuit, special purpose computer circuit, and/or other programmable data processing circuit to produce a machine, such that the instructions, which execute via the processor of the computer and/or other programmable data processing apparatus, transform and control transistors, values stored in memory locations, and other hardware components within such circuitry to implement the functions/acts specified in the block diagrams and flowchart block or blocks, and thereby create means (functionality) and/or structure for implementing the functions/acts specified in the block diagrams and flowchart blocks.

**[0128]** These computer program instructions may also be stored in a tangible computer-readable medium that can direct a computer or other programmable data processing apparatus to function in a particular manner, such that the instructions stored in the computer-readable medium produce an article of manufacture including instructions which implement the functions/acts specified in the block diagrams and flowchart blocks.

**[0129]** A tangible, non-transitory computer-readable medium may include an electronic, magnetic, optical, electromagnetic, or semiconductor data storage system, apparatus, or device. More specific examples of the computer-readable medium would include the following: a portable computer diskette, a random access memory (RAM) circuit, a read-only memory (ROM) circuit, an erasable programmable read-only memory (EPROM or Flash memory) circuit, a portable compact disc read-only memory (CD-ROM), and a portable digital video disc read-only memory (DVD/BlueRay).

**[0130]** The computer program instructions may also be loaded onto a computer and/or other programmable data processing apparatus to cause a series of operational steps to be performed on the computer and/or other programmable apparatus to produce a computer-implemented process such that the instructions which execute on the computer or other programmable apparatus provide steps for implementing the functions/acts specified in the block diagrams and flowchart blocks. Accordingly, embodiments of the present invention may be embodied in hardware and/or in software (including firmware, resident software, micro-code, etc.) that runs on a processor such as a digital signal processor, which may collectively be referred to as “circuitry,” “a module” or variants thereof.

**[0131]** It should also be noted that in some alternate implementations, the functions/acts noted in the blocks may occur out of the order noted in the flowcharts. For example, two blocks shown in succession may in fact be executed substantially concurrently or the blocks may sometimes be executed in the reverse order, depending upon the functionality/acts involved. Moreover, the functionality of a given block of the flowcharts and block diagrams may be separated into multiple blocks and/or the functionality of two or more blocks of the flowcharts and block diagrams may be at least partially integrated. Finally, other blocks may be added/inserted between the blocks that are illustrated. Moreover, although some of the diagrams include arrows on communication paths to show a primary direction of communication, it is to be understood that communication may occur in the opposite direction to the depicted arrows.

**[0132]** The foregoing is illustrative of the present invention and is not to be construed as limiting thereof. Although a few exemplary embodiments of this invention have been described, those skilled in the art will readily appreciate that many modifications are possible in the exemplary embodiments without materially departing from the teachings and advantages of this invention. Accordingly, all such modifications are intended to be included within the scope of this invention as defined in the claims. The invention is defined by the following claims, with equivalents of the claims to be included therein.

That which is claimed is:

1. A monitoring device configured to be attached to a subject,

the monitoring device comprising:

a photoplethysmography (PPG) sensor configured to measure a plurality of physiological parameters from the subject, wherein each physiological parameter is measured in a respective one of a plurality of time intervals; at least one motion sensor configured to detect an activity state of the subject; and

at least one processor coupled to the PPG sensor and the at least one motion sensor, wherein the at least one processor instructs the PPG sensor to measure a first one of the plurality of physiological parameters if the activity state is at or above a threshold, and to measure a second one of the plurality of physiological parameters if the activity state is below the threshold.

2. The monitoring device of claim 1, wherein the at least one processor is further configured to cause an optical emitter of the PPG sensor to have a different polling rate in each of the respective time intervals.

3. The monitoring device of claim 1, wherein the at least one processor is further configured to cause an optical detector of the PPG sensor to have a different sampling rate in each of the respective time intervals.

4. The monitoring device of claim 1, wherein the at least one processor is further configured to cause an optical detector of the PPG sensor to emit a different wavelength of light or a different set of wavelengths of light during each of the respective time intervals.

5. The monitoring device of claim 1, wherein the PPG sensor is configured to measure subject heart rate in a first one of the time intervals, subject RRi in a second one of the time intervals, subject blood pressure in a third one of the time intervals, and subject breathing rate in a fourth one of the time intervals.

6. The monitoring device of claim 1, wherein the monitoring device is configured to be positioned at or within an ear of the subject.

7. The monitoring device of claim 1, wherein the monitoring device is configured to be secured to an appendage of the subject.

8. A method of monitoring a subject via a monitoring device attached to the subject, wherein the monitoring device comprises a photoplethysmography (PPG) sensor configured to measure a plurality of physiological parameters from the subject, at least one motion sensor, and at least one processor, the method comprising:

detecting an activity state of the subject via the at least one motion sensor; and

instructing the PPG sensor to measure a first one of the plurality of physiological parameters if the activity state is at or above a threshold, and to measure a second one of the plurality of physiological parameters if the activity state is below the threshold.

9. The method of claim 8, wherein the monitoring device is configured to be positioned at or within an ear of the subject.

10. The method of claim 8, wherein the monitoring device is configured to be secured to an appendage of the subject.

11. A monitoring device configured to be attached to a subject, the monitoring device comprising:

a photoplethysmography (PPG) sensor configured to measure subject heart rate, subject RRi, subject blood pressure, and subject breathing rate;

at least one motion sensor configured to detect an activity state of the subject; and

at least one processor coupled to the PPG sensor and the at least one motion sensor, wherein the at least one processor is configured to instruct the PPG sensor to measure heart rate and/or breathing rate if the activity state of the subject is at or above a threshold, and to measure RRi and/or blood pressure if the activity state of the subject is below the threshold.

**12.** The monitoring device of claim **11**, wherein the PPG sensor is configured to measure the subject heart rate in a first one of a plurality of time intervals, the subject RRi in a second one of the plurality of time intervals, the subject blood pressure in a third one of the plurality of time intervals, and the subject breathing rate in a fourth one of the plurality of time intervals.

**13.** The monitoring device of claim **12**, wherein the at least one processor is configured to cause an optical emitter of the PPG sensor to have a different polling rate in at least two of the respective time intervals.

**14.** The monitoring device of claim **12**, wherein the at least one processor is configured to cause an optical detector of the PPG sensor to have a different sampling rate in at least two of the respective time intervals.

**15.** The monitoring device of claim **12**, wherein the at least one processor is configured to cause an optical detector of the PPG sensor to emit a different wavelength of light or a different set of wavelengths of light during at least two of the respective time intervals.

**16.** The monitoring device of claim **11**, wherein the monitoring device is configured to be positioned at or within an ear of the subject.

**17.** The monitoring device of claim **11**, wherein the monitoring device is configured to be secured to an appendage of the subject.

**18.** A method of monitoring a subject via a monitoring device attached to the subject, wherein the monitoring device comprises a photoplethysmography (PPG) sensor configured to measure subject heart rate, subject RRi, subject blood pressure, and subject breathing rate, at least one motion sensor, and at least one processor, the method comprising:

detecting an activity state of the subject via the at least one motion sensor; and

instructing the PPG sensor to measure heart rate and/or breathing rate if the activity state of the subject is at or above a threshold, and to measure RRi and/or blood pressure if the activity state of the subject is below the threshold.

**19.** The method of claim **18**, wherein the monitoring device is configured to be positioned at or within an ear of the subject.

**20.** The method of claim **18**, wherein the monitoring device is configured to be secured to an appendage of the subject.

\* \* \* \* \*

专利名称(译)	使用光学传感器的生理监测设备和方法		
公开(公告)号	<a href="#">US20190380655A1</a>	公开(公告)日	2019-12-19
申请号	US16/545637	申请日	2019-08-20
[标]申请(专利权)人(译)	瓦倫賽爾公司		
申请(专利权)人(译)	VALENCELL INC.		
当前申请(专利权)人(译)	VALENCELL INC.		
[标]发明人	LEBOEUF STEVEN FRANCIS TUCKER JESSE BERKLEY AUMER MICHAEL EDWARD JUST STEVEN MATTHEW FELICE MARK ANDREW		
发明人	LEBOEUF, STEVEN FRANCIS TUCKER, JESSE BERKLEY AUMER, MICHAEL EDWARD JUST, STEVEN MATTHEW FELICE, MARK ANDREW		
IPC分类号	A61B5/00 A61B5/1455 A61B5/01 A61B5/024 A61B5/11 A61B5/0205 A61B5/16 G05B19/048 A61B5/021		
CPC分类号	A61B5/68 A61B5/4266 A61B5/0816 A61B5/02055 G05B2219/2652 A61B5/6816 A61B5/72 A61B2560/0242 A61B2560/0266 A61B5/7271 A61B5/14551 A61B5/02405 A61B5/02416 A61B5/1118 A61B5/0059 G05B19/048 A61B2503/10 A61B5/6803 A61B5/1123 A61B5/021 A61B5/165 A61B5/742 A61B5/443 A61B5/02427 A61B5/01 A61B5/7203 A61B5/4809 A61B5/7207 A61B5/6815 A61B5/024 A61B5/6826 A61B5/14552 A61B5/0205		
优先权	62/030951 2014-07-30 US		
外部链接	<a href="#">Espacenet</a> <a href="#">USPTO</a>		

摘要(译)

被配置为附接到对象的监视装置包括：光电容积描记术 ( PPG ) 传感器，被配置为测量来自对象的多个生理参数；运动传感器，被配置为检测对象的活动状态；以及处理器，其耦合到PPG传感器 和运动传感器。PPG传感器被配置为在多个时间间隔的相应时间间隔中测量每个生理参数。 如果活动状态处于阈值或高于阈值，则处理器指示PPG传感器测量多个生理参数中的第一个，并且如果活动状态低于阈值，则指示PPG传感器测量多个生理参数中的第二个。

