



US010016143B2

(12) **United States Patent**  
**Siejko**

(10) **Patent No.:** **US 10,016,143 B2**  
(45) **Date of Patent:** **\*Jul. 10, 2018**

(54) **PEAK SELECTION FOR SELF CORRELATION ANALYSIS OF CARDIAC RATE IN AN IMPLANTABLE MEDICAL DEVICE**

*I/3925* (2013.01); *A61N I/3956* (2013.01);  
*A61N I/3987* (2013.01); *G06F 17/11*  
(2013.01);

(Continued)

(71) Applicant: **CAMERON HEALTH, INC.**, St. Paul, MN (US)

(58) **Field of Classification Search**  
None  
See application file for complete search history.

(72) Inventor: **Krzysztof Z. Siejko**, Maple Grove, MN (US)

(56) **References Cited**

(73) Assignee: **Cameron Health, Inc.**, St. Paul, MN (US)

U.S. PATENT DOCUMENTS

(\*) Notice: Subject to any disclaimer, the term of this patent is extended or adjusted under 35 U.S.C. 154(b) by 0 days.

4,239,048 A 12/1980 Steuer  
5,243,993 A 9/1993 Alexander et al.  
(Continued)

This patent is subject to a terminal disclaimer.

FOREIGN PATENT DOCUMENTS

WO 2012135062 A1 10/2012  
WO 2013160538 A1 10/2013

(21) Appl. No.: **15/482,004**

OTHER PUBLICATIONS

(22) Filed: **Apr. 7, 2017**

International Application No. PCT/2015/045158, "Invitation to Pay Additional Fees and, where Applicable, Protest Fee," dated Jan. 13, 2016.

(65) **Prior Publication Data**

US 2017/0209063 A1 Jul. 27, 2017

(Continued)

**Related U.S. Application Data**

(63) Continuation of application No. 14/819,851, filed on Aug. 6, 2015, now Pat. No. 9,629,565.

(Continued)

*Primary Examiner* — Brian T Gedeon

(74) *Attorney, Agent, or Firm* — Seager, Tuft & Wickhem LLP

(51) **Int. Cl.**

*A61B 5/04* (2006.01)

*A61B 5/0456* (2006.01)

(Continued)

(57) **ABSTRACT**

Self-correlation enhancements and implementations are described. In particular, certain examples demonstrate the use of a peak selector to identify peaks of a self-correlation function which serve as candidate cardiac rates for an implantable medical device. The approach may enable an alternative calculation of cardiac rate in an implantable medical device as a stand-alone rate detector or as a double-check of other rate calculations.

(52) **U.S. Cl.**

CPC ..... *A61B 5/04012* (2013.01); *A61B 5/0245* (2013.01); *A61B 5/0422* (2013.01); *A61B 5/0456* (2013.01); *A61B 5/0464* (2013.01); *A61B 5/04525* (2013.01); *A61B 5/4836* (2013.01); *A61B 5/686* (2013.01); *A61N*

**20 Claims, 19 Drawing Sheets**

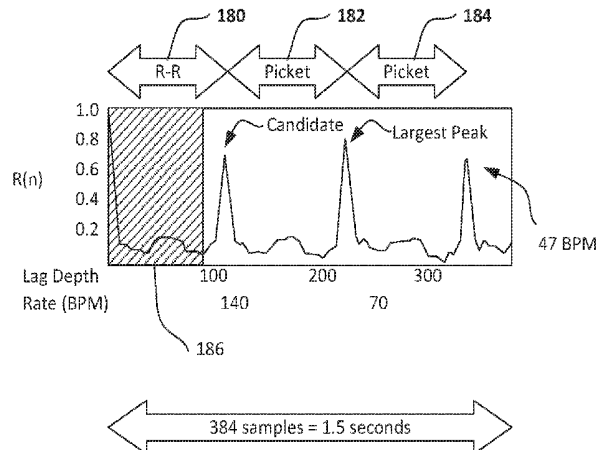

**Related U.S. Application Data**

(60) Provisional application No. 62/038,440, filed on Aug. 18, 2014, provisional application No. 62/038,438, filed on Aug. 18, 2014, provisional application No. 62/038,437, filed on Aug. 18, 2014.

(51) **Int. Cl.**

*A61B 5/042* (2006.01)  
*A61B 5/00* (2006.01)  
*A61N 1/39* (2006.01)  
*A61B 5/0245* (2006.01)  
*A61B 5/0452* (2006.01)  
*A61B 5/0464* (2006.01)  
*G06F 17/11* (2006.01)  
*G06F 19/00* (2018.01)  
*G16H 10/60* (2018.01)

(52) **U.S. Cl.**

CPC ..... *G06F 19/322* (2013.01); *G06F 19/3418* (2013.01); *G16H 10/60* (2018.01)

(56)

**References Cited**

U.S. PATENT DOCUMENTS

5,558,096 A 9/1996 Palatnik  
 5,583,505 A 12/1996 Anderson et al.

5,709,215 A 1/1998 Perttu et al.  
 6,567,691 B1 5/2003 Stadler  
 6,647,292 B1 11/2003 Bardy et al.  
 6,721,597 B1 4/2004 Bardy et al.  
 7,149,575 B2 12/2006 Ostroff et al.  
 7,194,302 B2 3/2007 Bardy et al.  
 7,248,921 B2 7/2007 Palreddy et al.  
 7,623,909 B2 11/2009 Sanghera et al.  
 8,160,686 B2 4/2012 Allavatam et al.  
 8,160,687 B2 4/2012 Warren et al.  
 8,200,341 B2 6/2012 Sanghera et al.  
 8,265,737 B2 9/2012 Warren et al.  
 8,409,107 B2 4/2013 Sweeney et al.  
 8,521,276 B2 8/2013 Sweeney et al.  
 8,565,878 B2 10/2013 Allavatam et al.  
 8,744,555 B2 6/2014 Allavatam et al.  
 8,868,148 B2 10/2014 Engelbrecht et al.  
 2013/0079657 A1 3/2013 Ochs et al.  
 2014/0073960 A1 3/2014 Rodriguez-Llorente et al.  
 2014/0180154 A1 6/2014 Sierra et al.

OTHER PUBLICATIONS

International Application No. PCT/US2015/045157, "Notification of Transmittal of the International Search Report and the Written Opinion of the International Searching Authority, or the Declaration," dated Oct. 19, 2015.

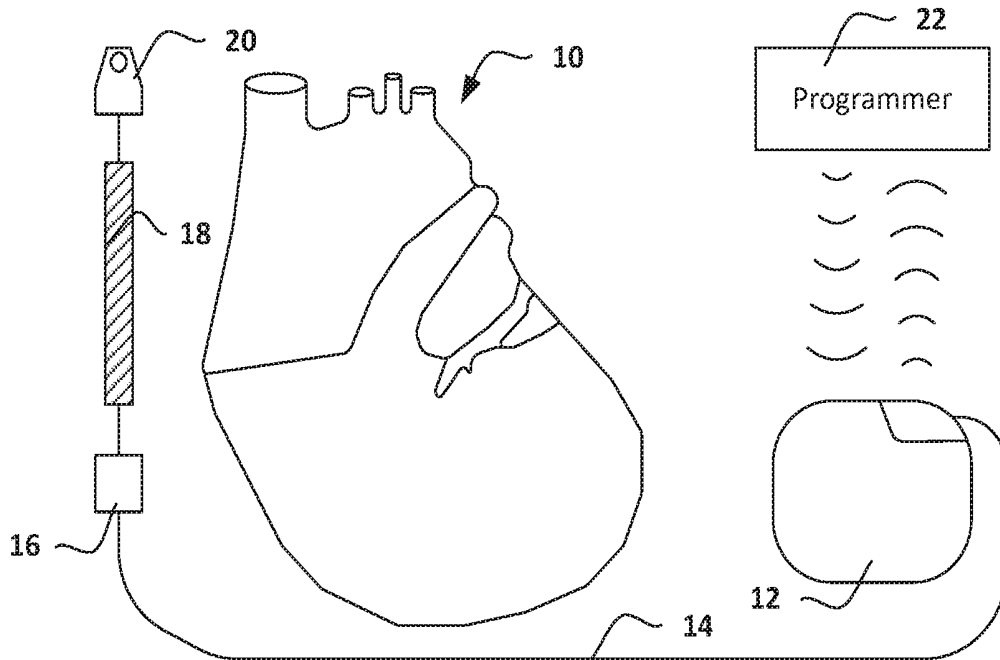

**FIG. 1**

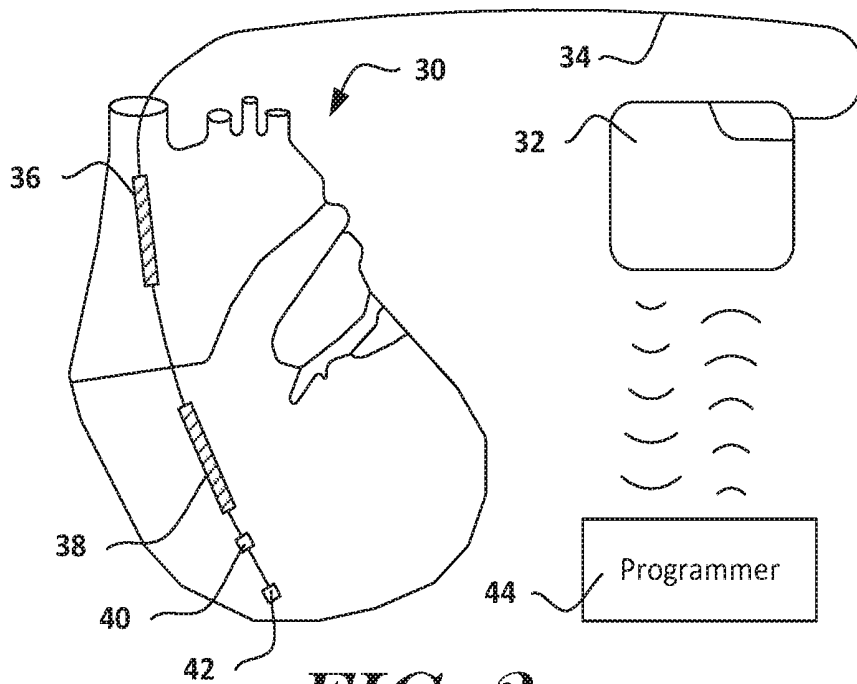

**FIG. 2**

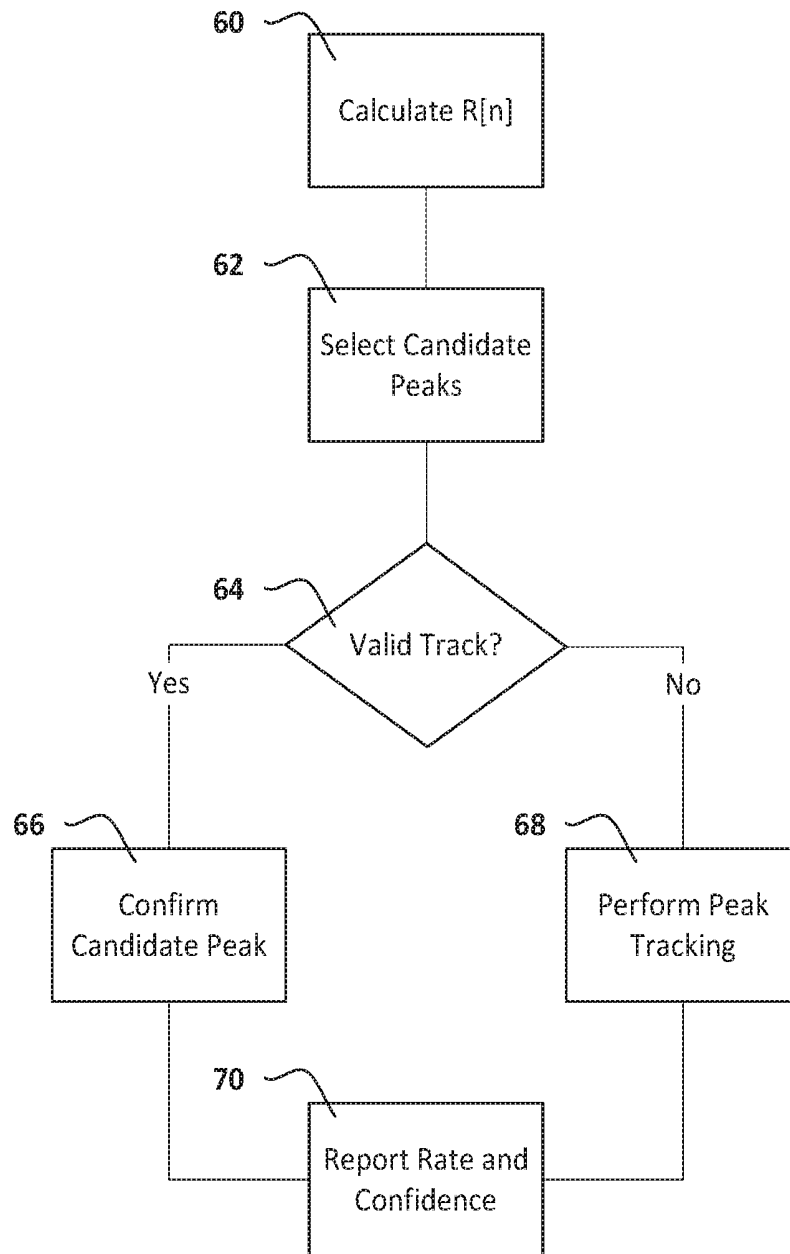

**FIG. 3**

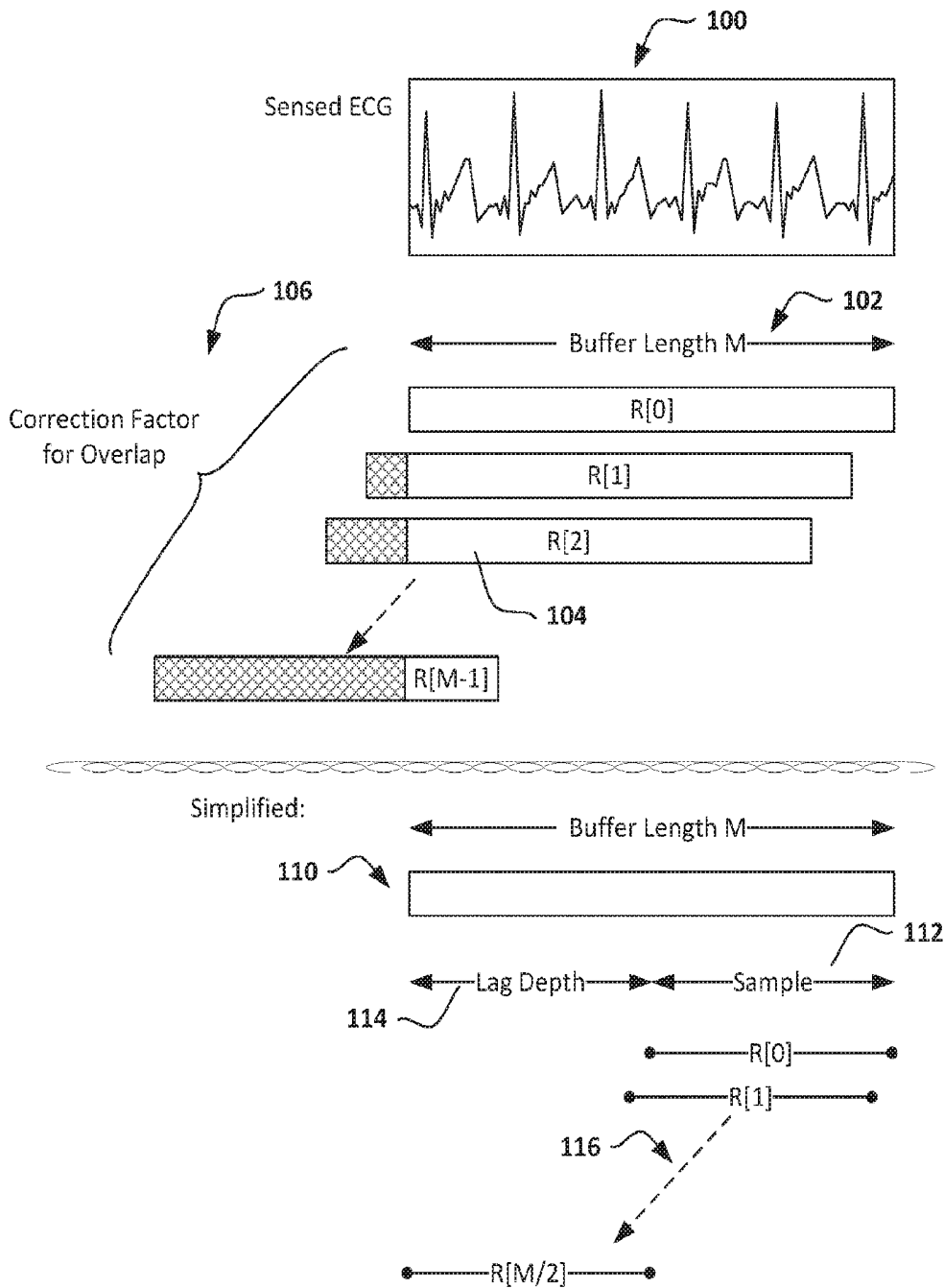
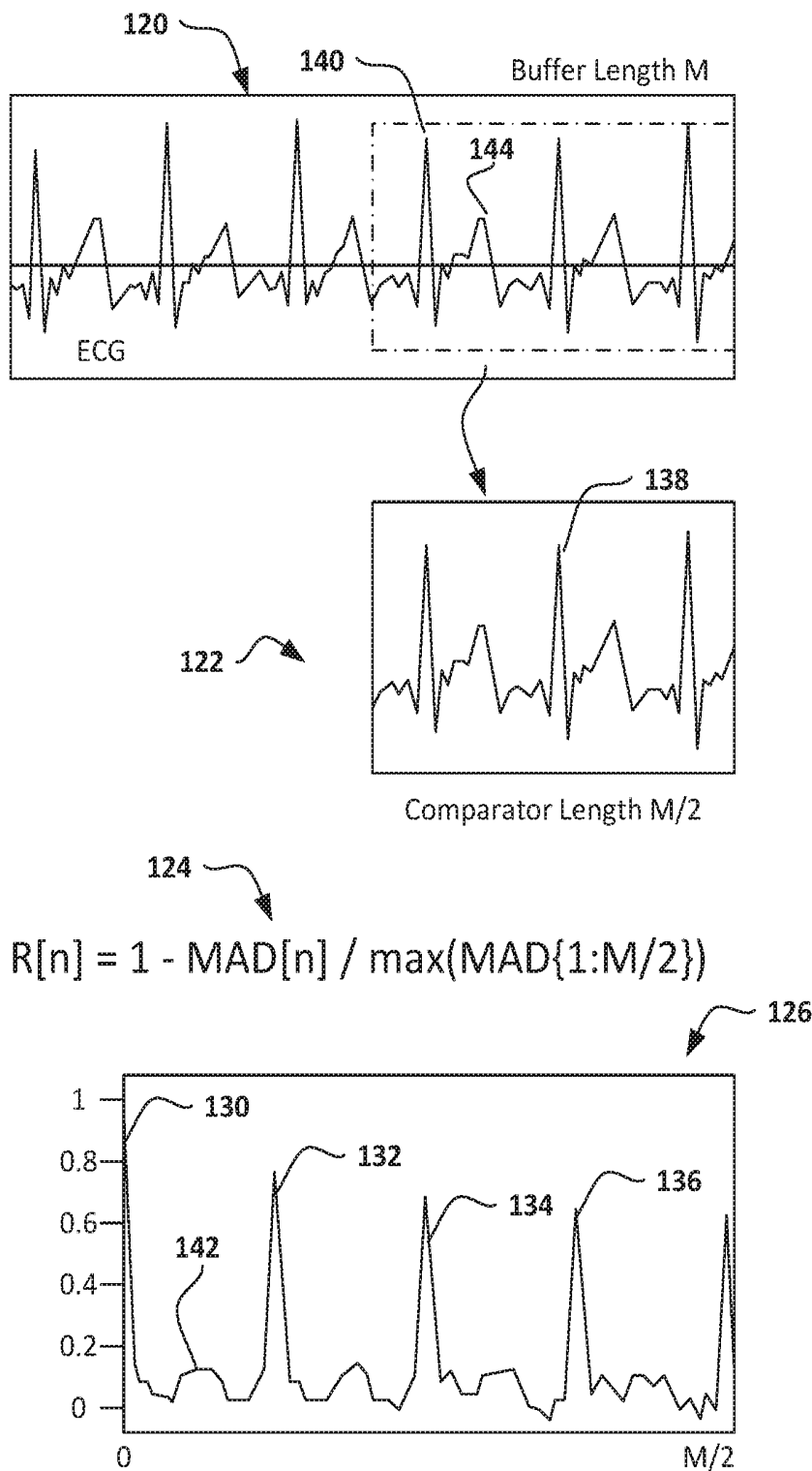

FIG. 4



**FIG. 5**

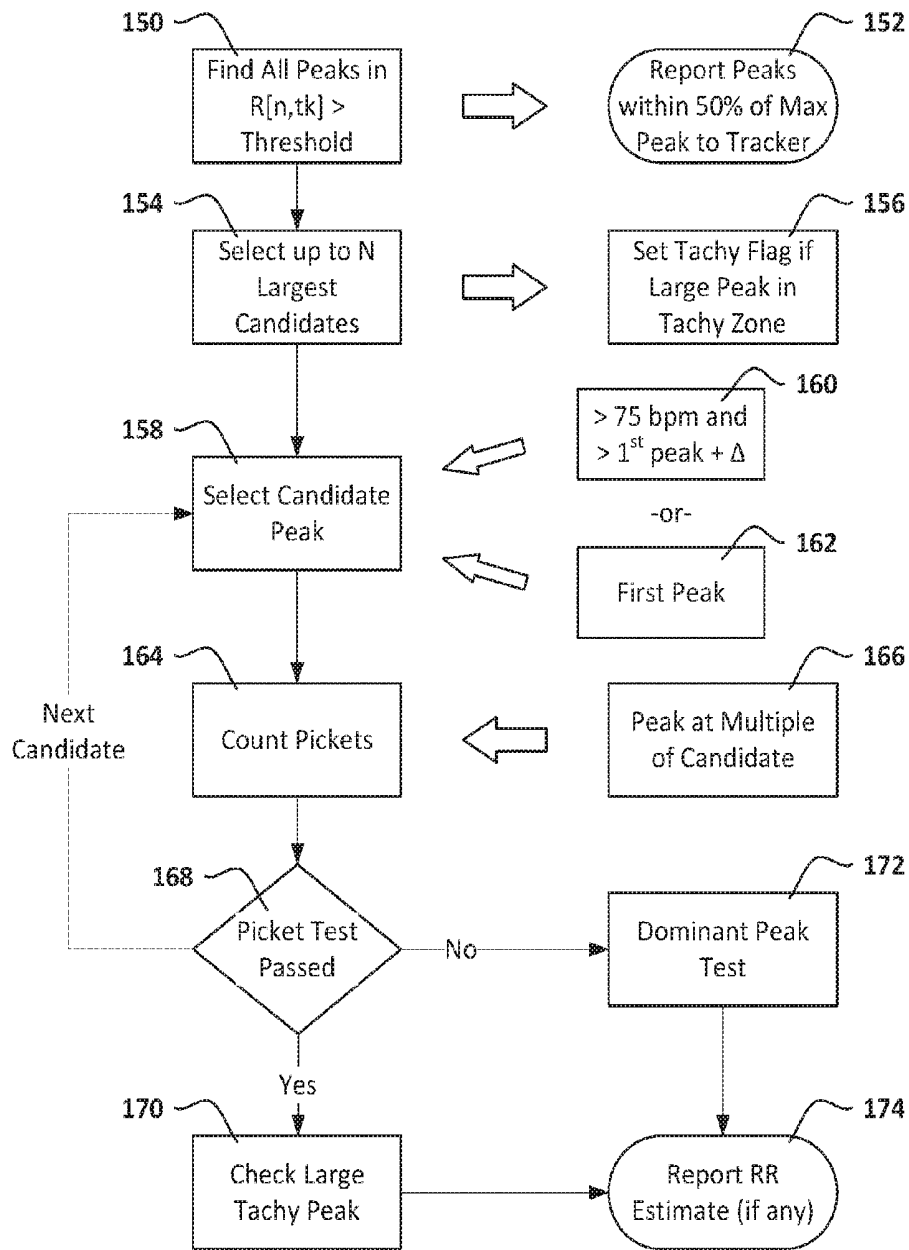
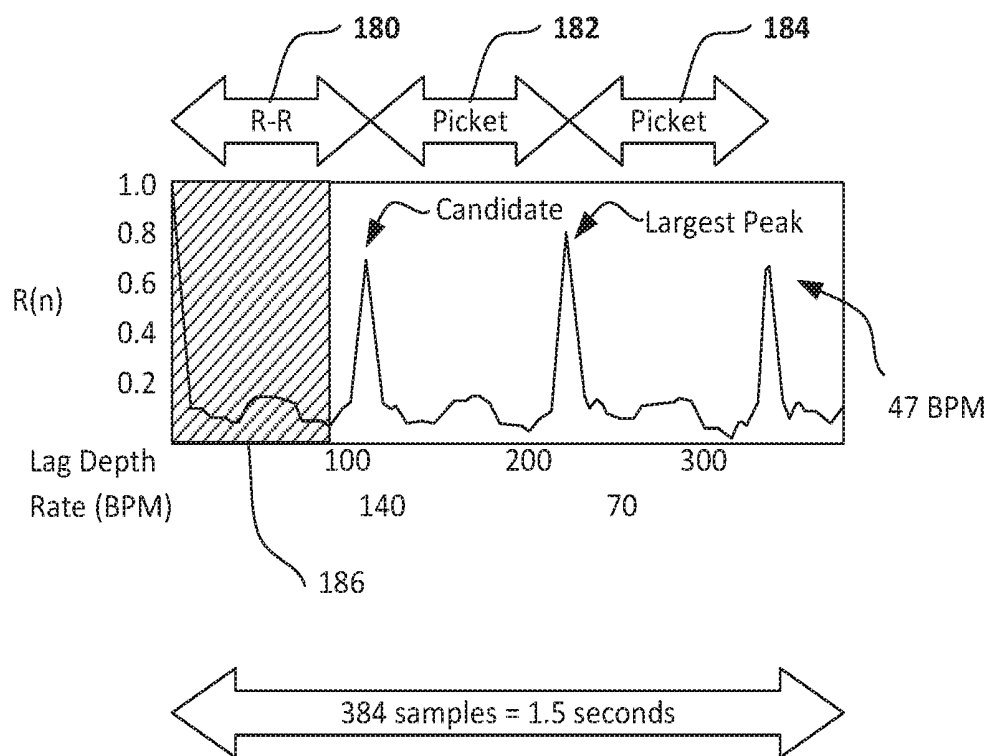
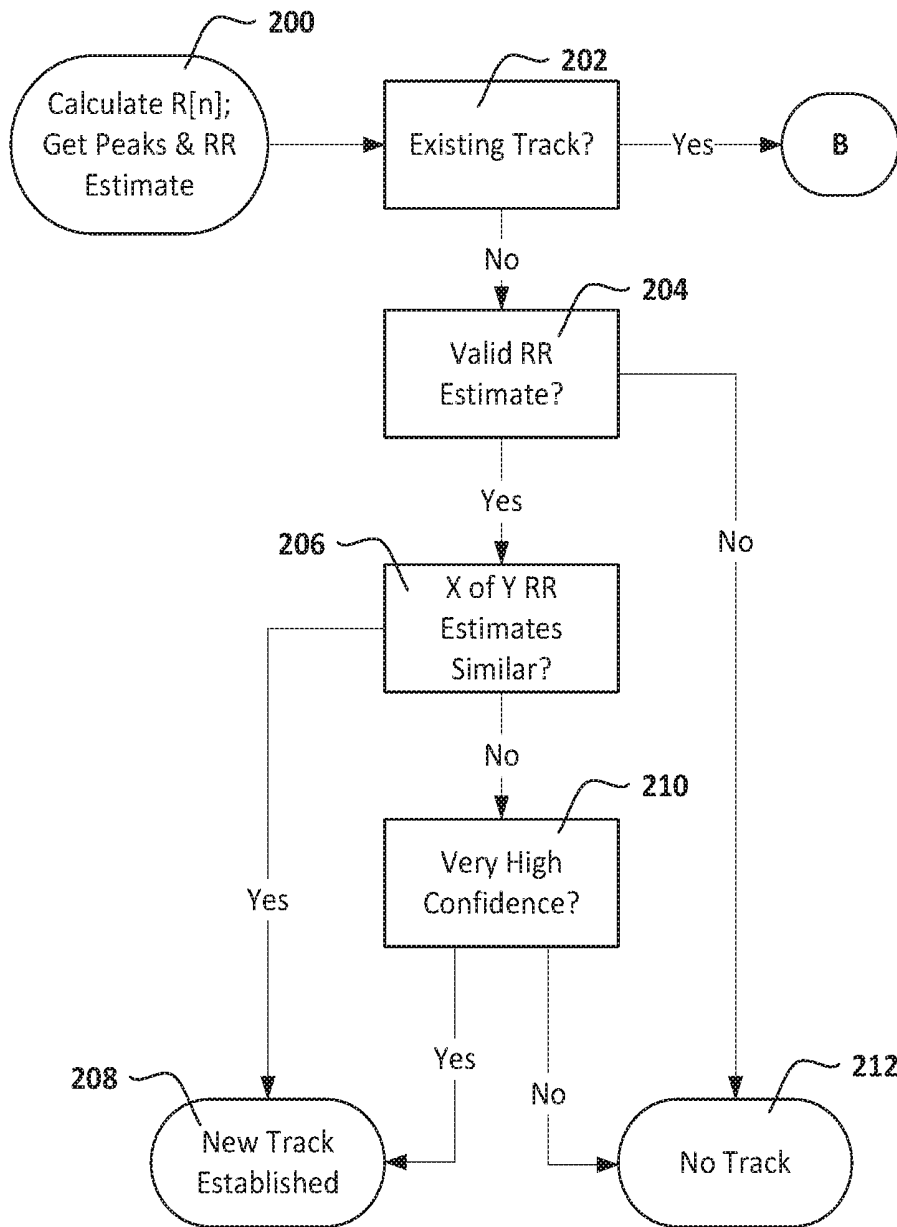

FIG. 6



**FIG. 7**



**FIG. 8A**

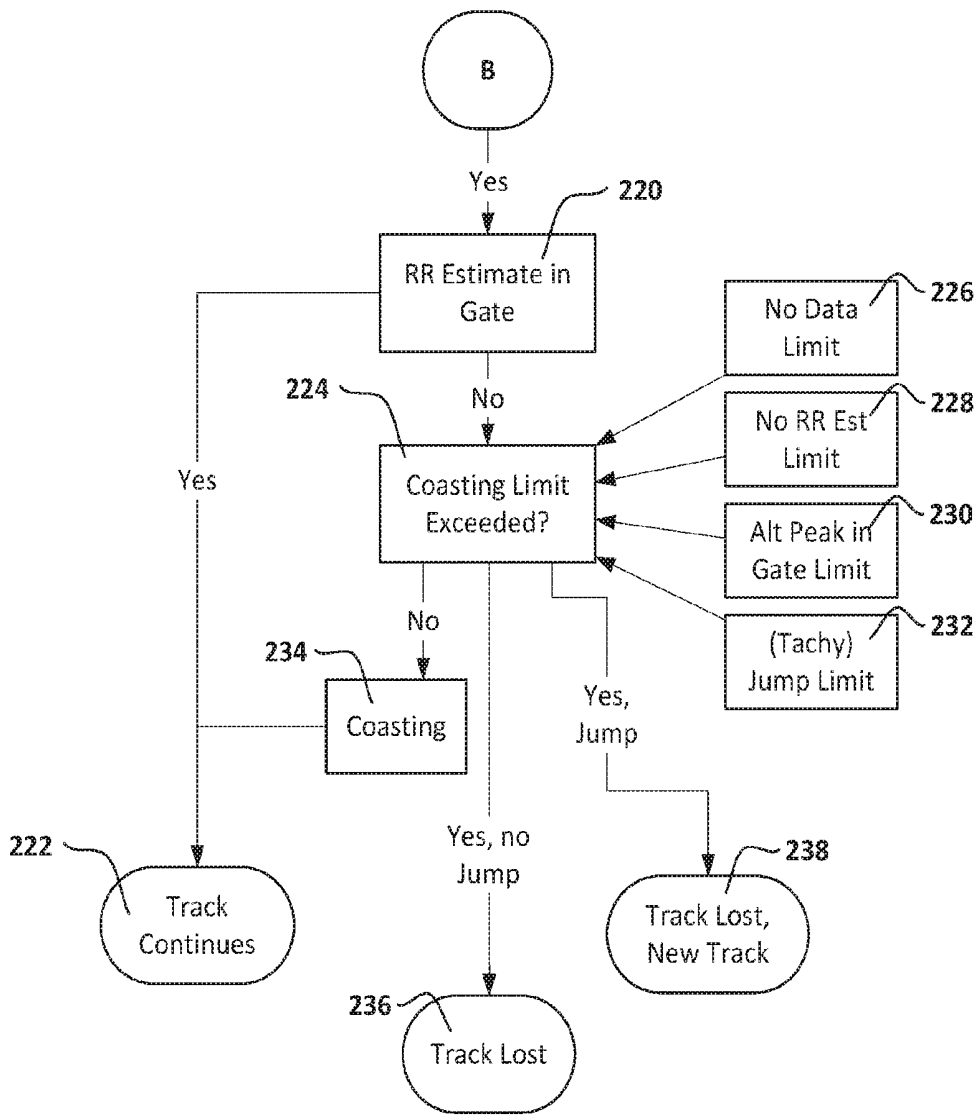

**FIG. 8B**

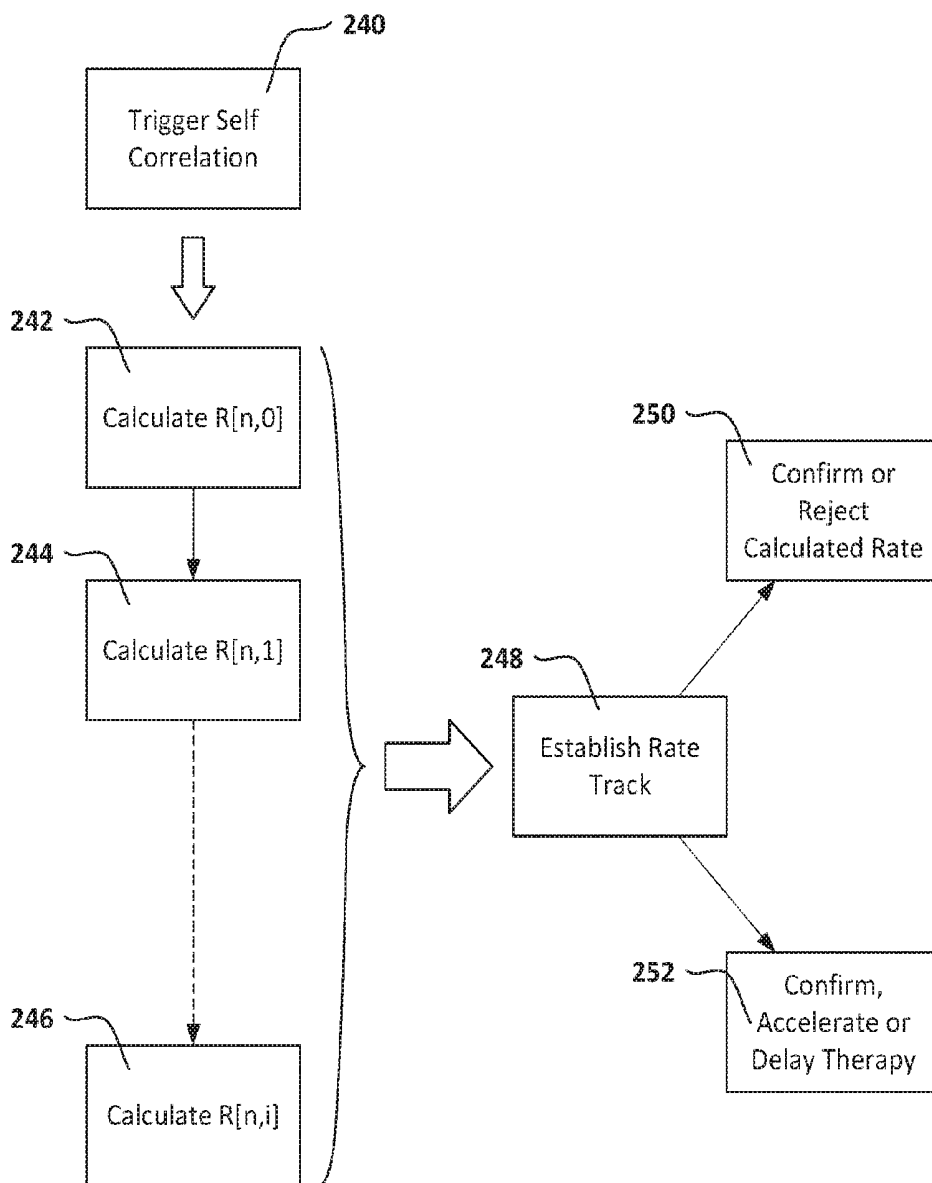

**FIG. 9**

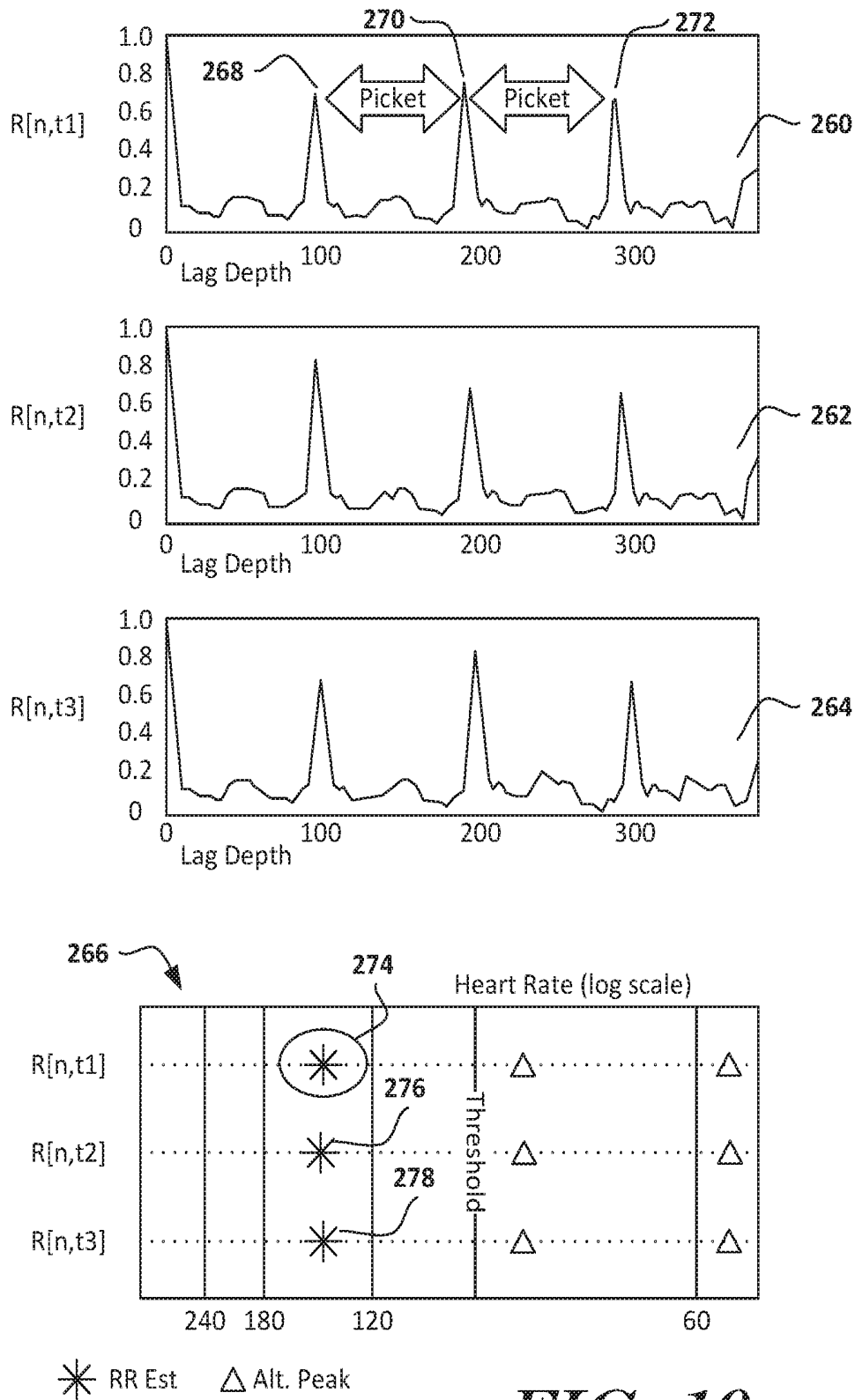

FIG. 10

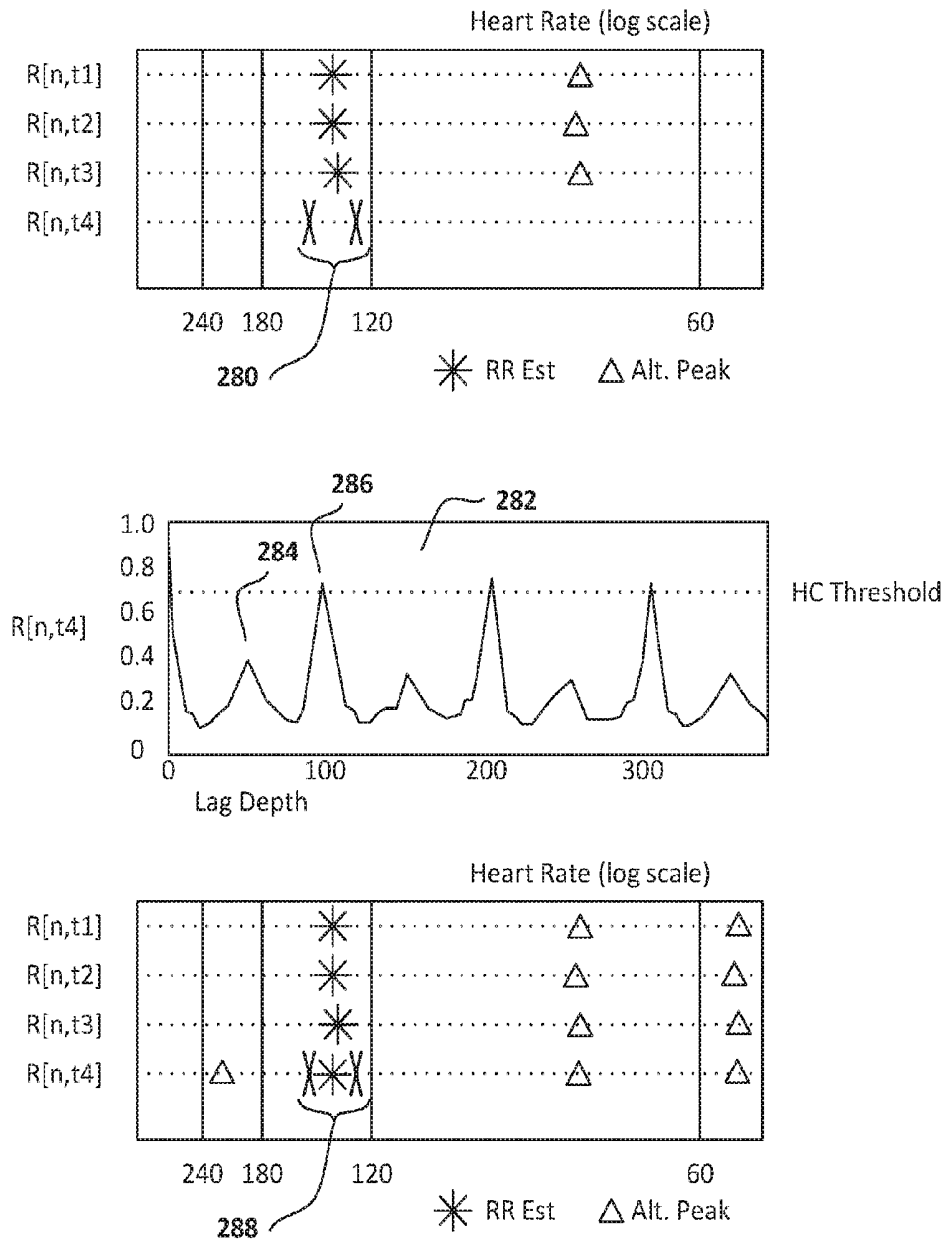
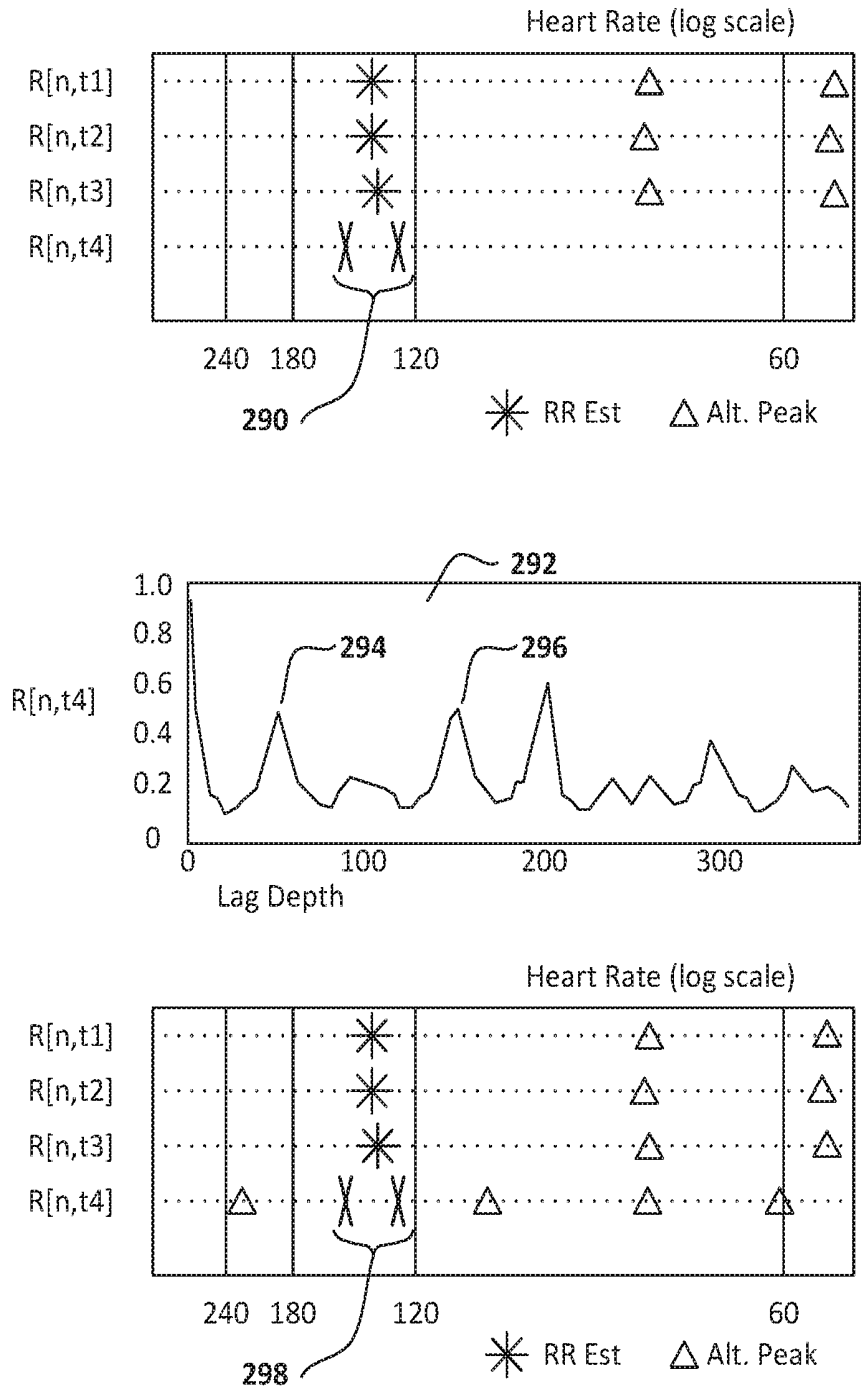
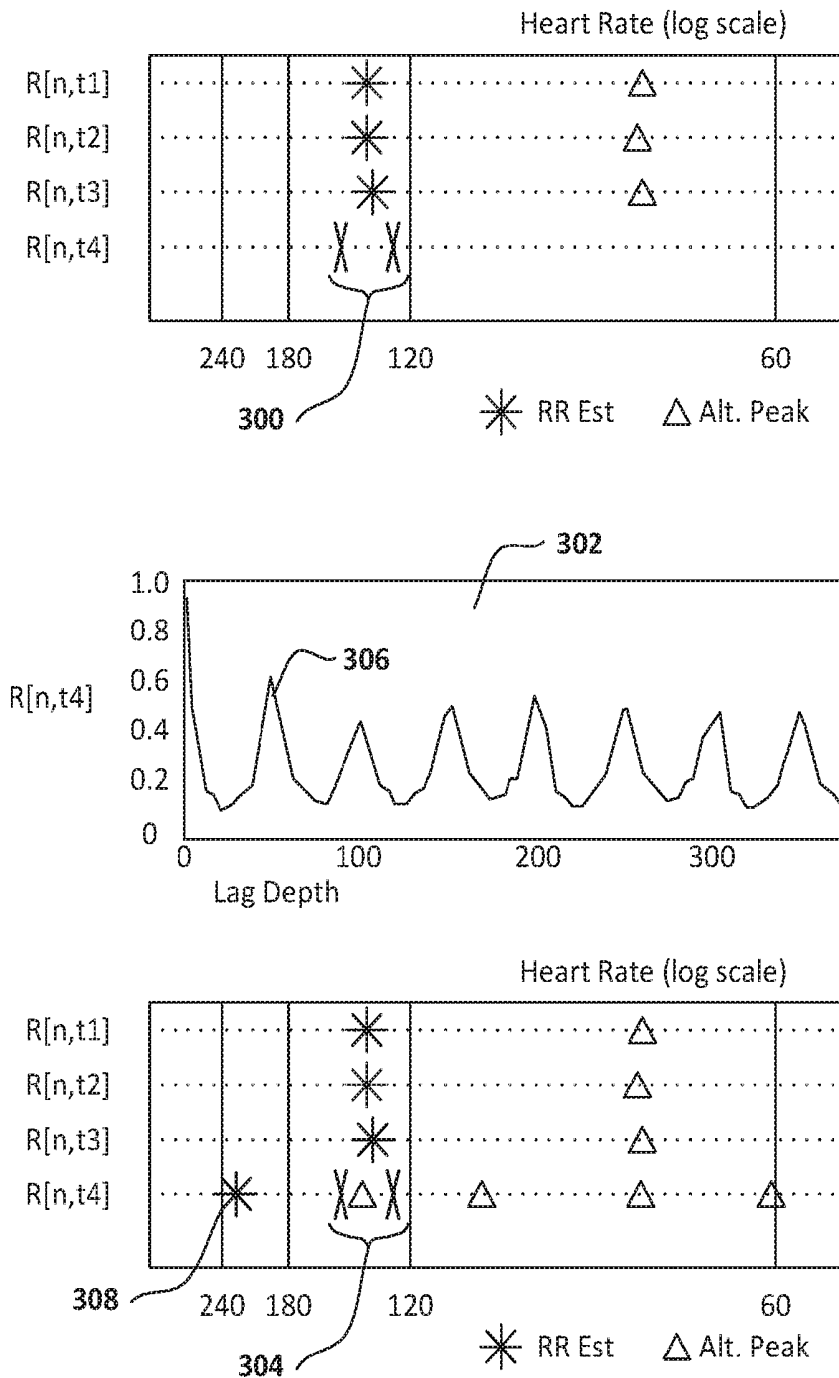

FIG. 11



**FIG. 12**



**FIG. 13**

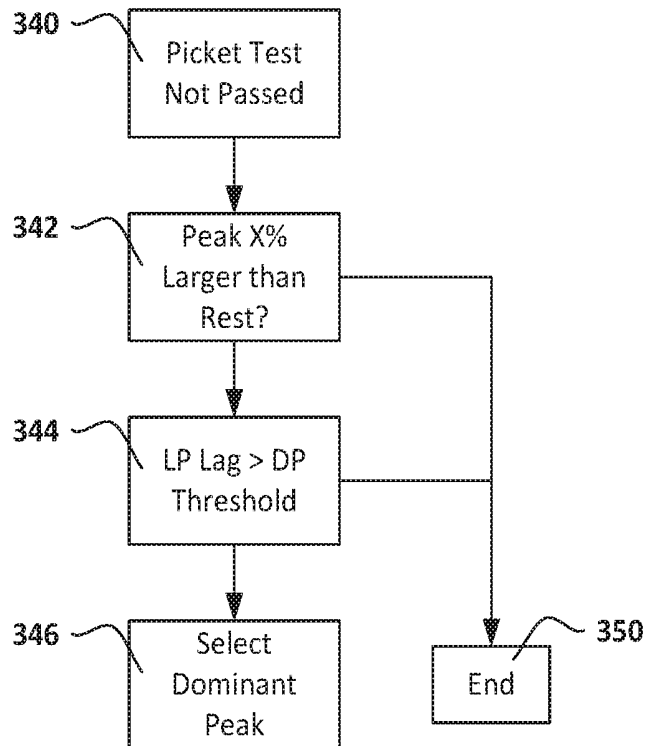
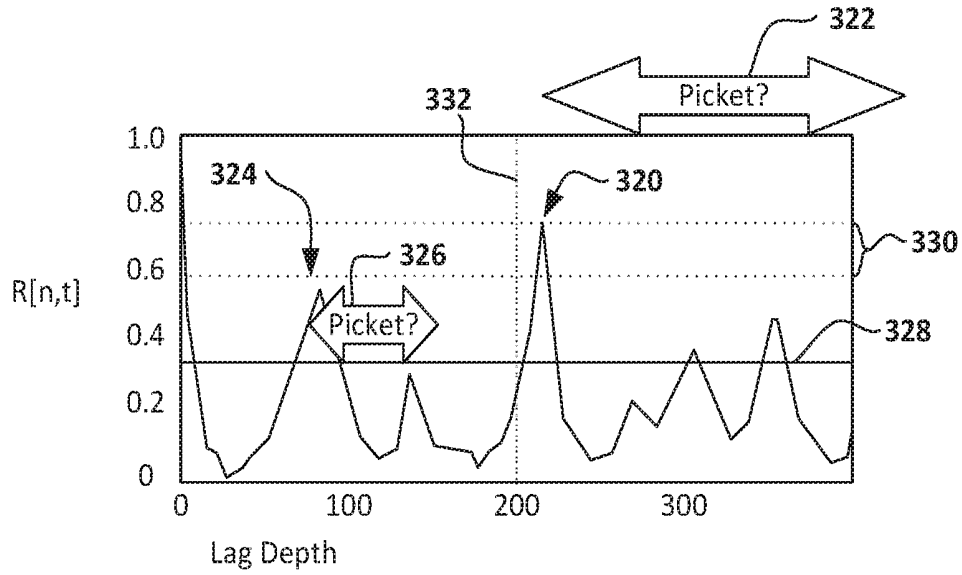
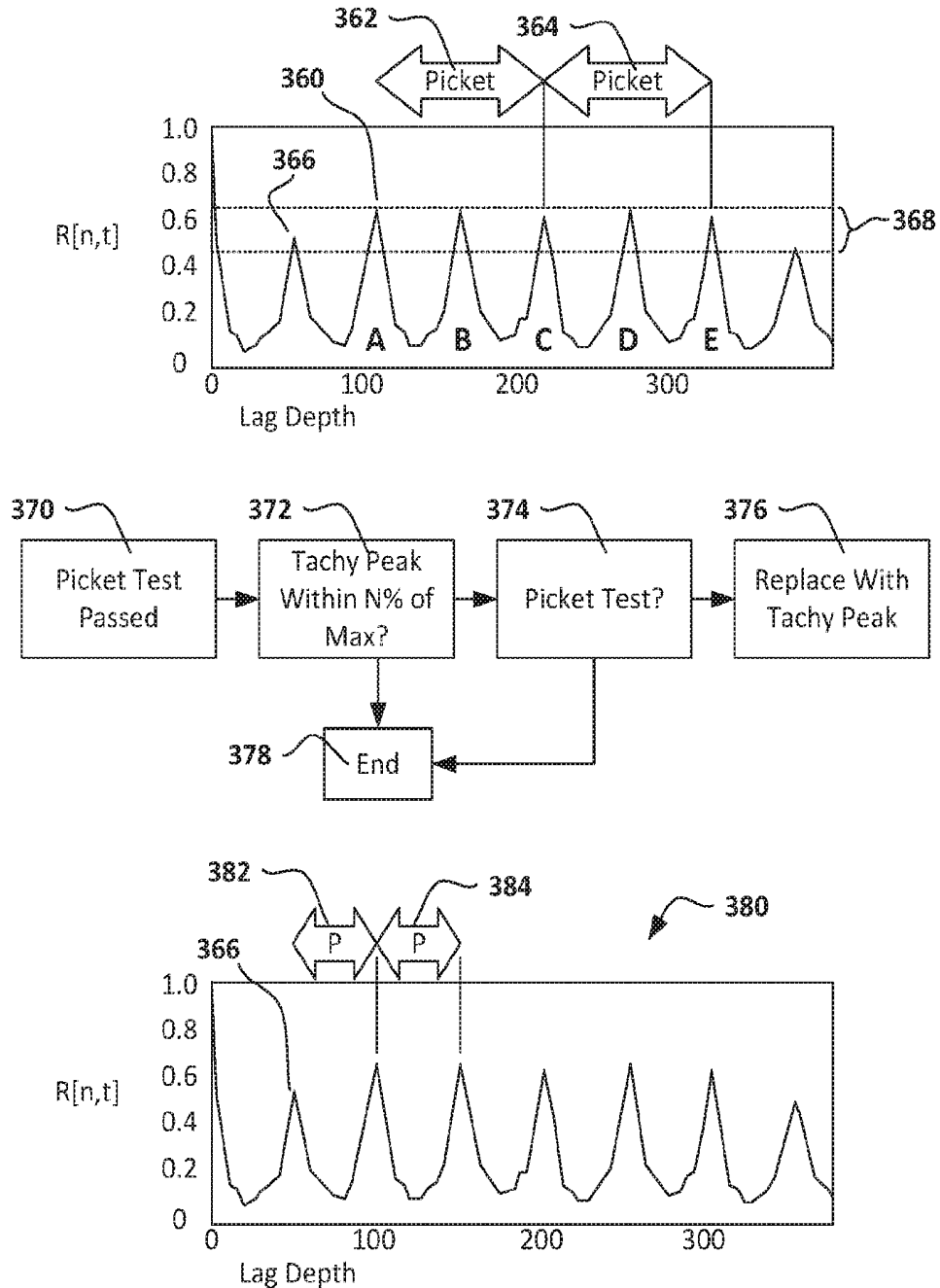

FIG. 14



**FIG. 15**

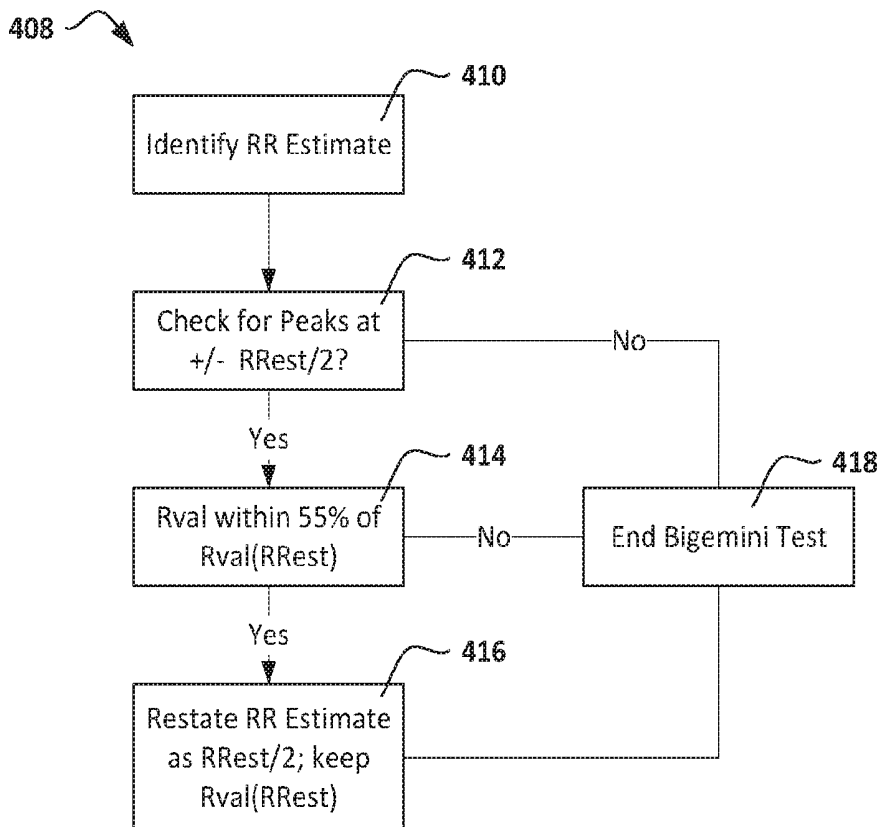
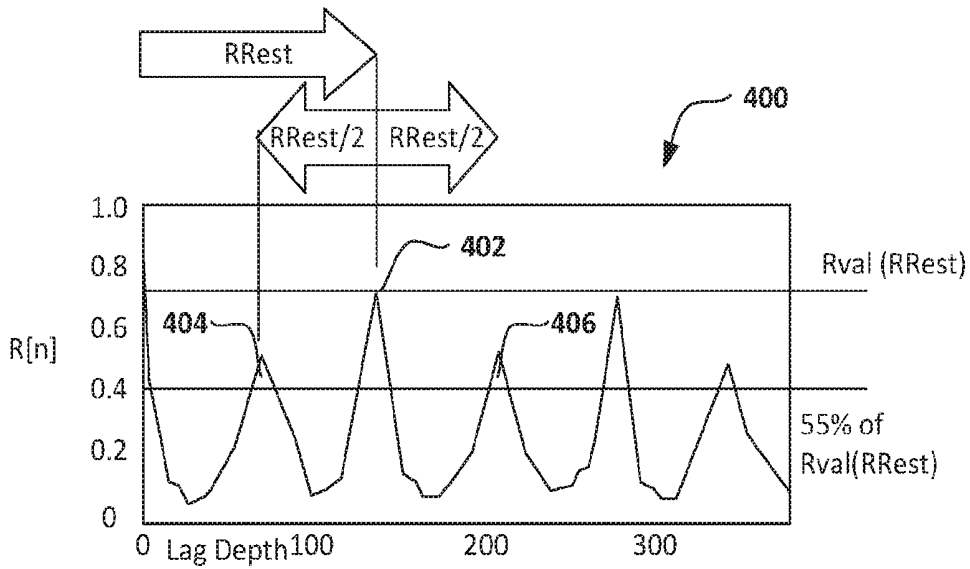

FIG. 16

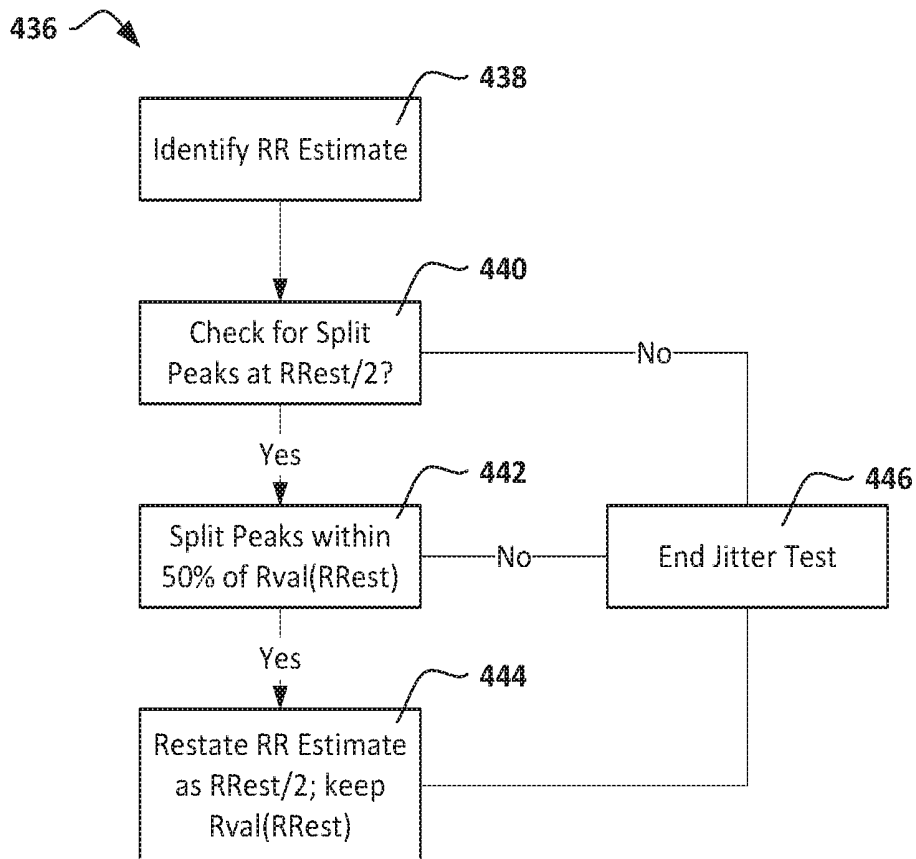
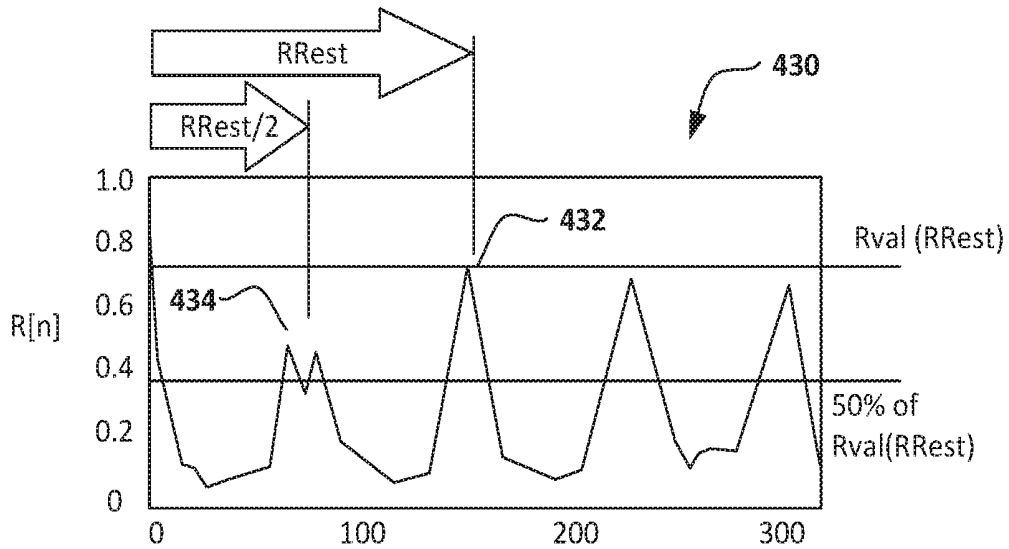

FIG. 17

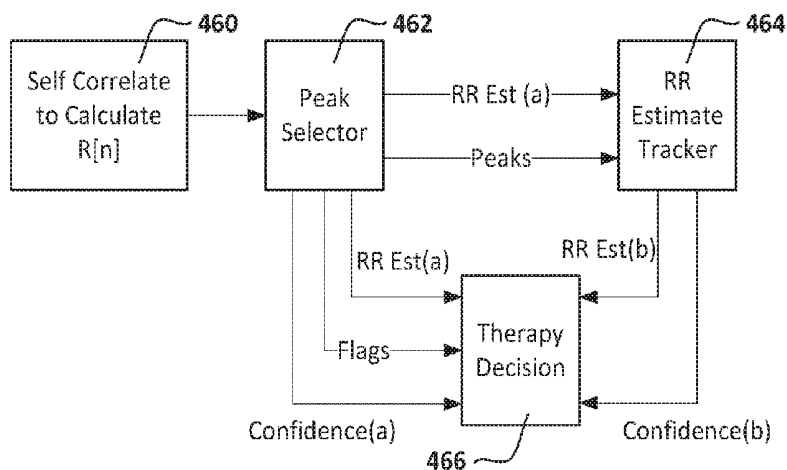

FIG. 18A

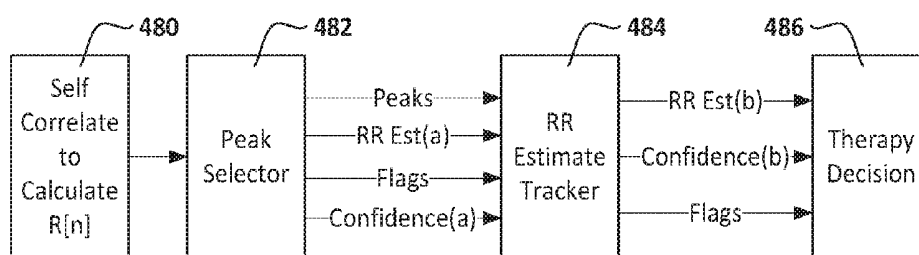
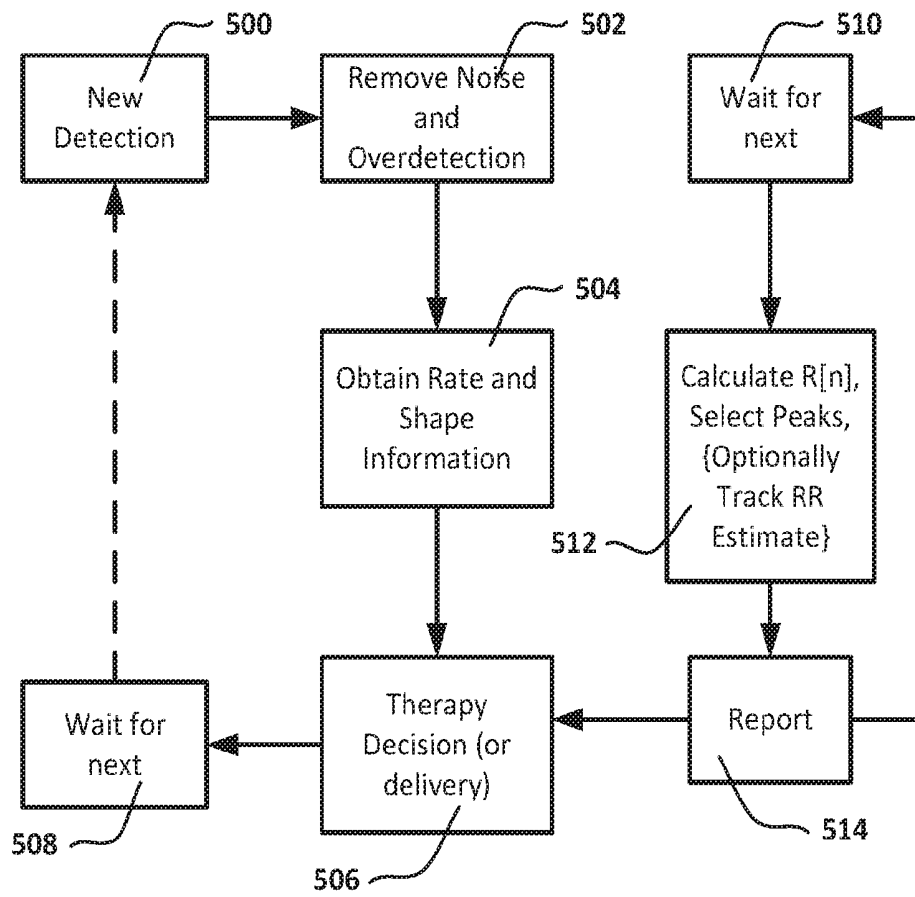

FIG. 18B



**FIG. 19**

**PEAK SELECTION FOR SELF  
CORRELATION ANALYSIS OF CARDIAC  
RATE IN AN IMPLANTABLE MEDICAL  
DEVICE**

CROSS-REFERENCE TO RELATED PATENT  
DOCUMENTS

The present application is a continuation of U.S. patent application Ser. No. 14/819,851, now U.S. Pat. No. 9,629, 565, filed on Aug. 6, 2015, which claims the benefit of and priority to each of U.S. Provisional Patent Application No. 62/038,440, filed Aug. 18, 2014, and titled CALCULATION OF SELF-CORRELATION IN AN IMPLANTABLE CARDIAC DEVICE, U.S. Provisional Patent Application No. 62/038,437, filed Aug. 18, 2014, and titled CARDIAC RATE TRACKING IN AN IMPLANTABLE MEDICAL DEVICE, and U.S. Provisional Patent Application No. 62/038,438, filed Aug. 18, 2014, and titled PEAK SELECTION FOR SELF CORRELATION ANALYSIS OF CARDIAC RATE IN AN IMPLANTABLE MEDICAL DEVICE, the disclosures of which are incorporated herein by reference. The present application is also related to U.S. patent application Ser. No. 14/819,889, titled CALCULATION OF SELF-CORRELATION IN AN IMPLANTABLE CARDIAC DEVICE, now U.S. Pat. No. 9,451,893, and U.S. patent application Ser. No. 14/819,817, titled CARDIAC RATE TRACKING IN AN IMPLANTABLE MEDICAL DEVICE, now U.S. Pat. No. 9,451,892, the disclosures of which are incorporated herein by reference.

BACKGROUND

Implantable defibrillators are designed to deliver an electrical stimulus to terminate certain deleterious arrhythmias. Such devices must correctly identify dangerous arrhythmias (sensitivity). They must also avoid delivering electrical stimulus when not desired (specificity). Attaining high sensitivity and specificity in the discrimination of such deleterious arrhythmias is a challenge.

Typically treatable arrhythmias include ventricular fibrillation (VF) and/or polymorphic ventricular tachycardia (PVT). Other arrhythmias can include monomorphic ventricular tachycardia (MVT), atrial fibrillation (AF), and atrial flutter (Flutter), with the atrial arrhythmias of AF and Flutter deemed supraventricular tachycardia (SVT). For some patients, MVT is treated by the implantable defibrillator using anti-tachycardia pacing (ATP), while AF and Flutter are typically addressed by other therapies entirely. In addition, patients can experience exercise induced ventricular tachycardia (VT), which is typically not treated at all. Some patients experience bundle branch blocks and other conditions that can arise at elevated rates, causing the signal shape (morphology) of the cardiac signal with each cardiac beat to change relative to morphology at slower rates. Implantable devices are expected to appropriately distinguish these various conditions and apply the correct therapy for only certain conditions.

Chen et al., in *Ventricular Fibrillation Detection By A Regression Test On The Autocorrelation Function*, *Med Biol Eng Comput.*; 25 (3): 241-9 (May, 1987), discuss the use of an autocorrelation function (ACF) to identify ventricular fibrillation in which the ACF is performed. Chen et al. hypothesize that the peaks in the ACF output are expected to be periodic and/or regular and should pass a linear regression test when a ventricular tachycardia (VT) is occurring. Therefore, the results of the ACF are subjected to a linear

regression analysis and VF is declared if the linear regression fails to find a linear fit. Chen et al. limit their analysis to VF and VT and do not address the fact that the linear regression they discuss would also likely fail for supraventricular arrhythmias such as atrial flutter or atrial fibrillation for which defibrillation therapy is typically not desired. Moreover, adding a linear regression test with ACF would create a very large computational burden for an implantable system.

Sweeney et al., in U.S. Pat. Nos. 8,409,107 and/or 8,521, 276 discuss the use of an ACF applied to a transformation of detected cardiac signal using curve matching. The ACF would be applied to identify recurring curves. Such recurring curves could be used to find heart beats from the transformed signal, which could be used to calculate rate. ACF is not directly applied to the time varying cardiac signal, however.

ACF in each of these examples involves a large number of computational steps to be calculated. To make ACF more useful in an implantable device, simplified methods and alternative methods which address the spectrum of potential arrhythmias are desired.

OVERVIEW

The present inventor has recognized, among other things, that a problem to be solved can include the incorporation of a modified autocorrelation function into an implantable cardiac device. Modifications can be made to reduce the computational burden of the correlation function and accommodate some of the difficulties which arise in the context of an implantable device monitoring cardiac function. The present subject matter can help provide a solution to the problem of enhancing sensitivity and specificity in implantable cardiac rhythm management devices.

The present invention comprises several separately implementable elements which provide avenues for reliable use of ACF at lesser computational burden in an implantable device.

In a first aspect, the invention comprises a set of rules for the calculation of a Minimum Absolute Difference (MAD) function to construct a Self Correlation. The use of MAD facilitates a far simpler and less computationally intensive manner of analyzing the cardiac signal than ACF.

In a second aspect, the invention comprises a set of rules for the identification and selection of candidate peaks within a Self Correlation or ACF to yield an estimate of heart rate.

In a third aspect, the present invention comprises a set of rules for tracking cardiac rate over time using output peaks from either a Self Correlation or ACF.

The first, second and third aspects may each be used independent of the other aspects, or in any suitable combination such as first-second, first-third, or second-third.

In a fourth aspect, the present invention comprises an integrated system or method in which a simplified Self Correlation of the first aspect is combined with the second and third aspects.

In various embodiments, devices and methods may use any of the first through fourth aspects either on a continuing basis or following a triggering event.

The present disclosure is, in certain examples, directed to enhancements that aid in selecting peaks within the results of a self-correlation function. The self-correlation function can take the form of a simplified ACF, such as an MAD, including for example methods of U.S. Provisional Patent Application No. 62/038,440, titled CALCULATION OF SELF-CORRELATION IN AN IMPLANTABLE CAR-

DIAC DEVICE, though the results of more complex calculations can also be used. Tracking analysis, such as that in U.S. Provisional Patent Application No. 62/038,437, titled CARDIAC RATE TRACKING IN AN IMPLANTABLE MEDICAL DEVICE, may use the results of peak selection to provide a rate estimate for use in therapy and other decisions over time, with added confidence based on repeated peak selection. However, other examples omit tracking and select from available peaks of the self-correlation function to provide estimated cardiac rates

The peak selection enhancements assist in the generation of a rate output from data which can be variable in response to noise and other inputs which can complicate the extraction of cardiac rate from signals detected by an implantable system. Beyond noise and extraneous inputs, the cardiac signal itself can be variable, particularly given that implantable systems are provided to patients having a variety of cardiac diseases or abnormalities which take various forms and states.

This overview is intended to provide an overview of subject matter of the present patent application. It is not intended to provide an exclusive or exhaustive explanation of the invention. The detailed description is included to provide further information about the present patent application.

#### BRIEF DESCRIPTION OF THE DRAWINGS

In the drawings, which are not necessarily drawn to scale, like numerals may describe similar components in different views. Like numerals having different letter suffixes may represent different instances of similar components. The drawings illustrate generally, by way of example, but not by way of limitation, various embodiments discussed in the present document.

FIG. 1 shows a subcutaneously implanted cardiac treatment system;

FIG. 2 shows a transvenously implanted cardiac treatment system;

FIG. 3 shows an overall method for generating a cardiac rate estimate;

FIGS. 4-5 illustrate the analysis of data using a self-correlation function and differentiate such analysis from ACF;

FIGS. 6-7 illustrate the analysis of R[n] peaks to identify candidate cardiac rates and a cardiac rate estimate;

FIGS. 8A-8B illustrate one method of tracking cardiac rate;

FIG. 9 illustrates tracking of cardiac rate over time;

FIGS. 10-13 demonstrate several cardiac rate tracking steps using hypothetical examples;

FIG. 14 illustrates a dominant peak test for peak selection in FIG. 6;

FIG. 15 illustrates a high rate peak test for the peak selection in FIG. 6;

FIG. 16 illustrates an analysis to identify a bigemini pattern and correct rate analysis;

FIG. 17 illustrates an analysis to identify jitter and correct rate analysis;

FIGS. 18A-18B illustrate different scenarios linking together the calculation of R[n], Peak Selector, Tracker, and Therapy Decision blocks; and

FIG. 19 is a block flow diagram for an overall method of cardiac signal analysis.

#### DETAILED DESCRIPTION

FIGS. 1-2 show implant locations for illustrative cardiac systems. The present invention may find application in a

subcutaneous-only system as illustrated in FIG. 1, or in a transvenous system as shown in FIG. 2. Alternatives may include systems having multiple subcutaneous, transvenous and/or intracardiac elements, epicardial systems, or fully intravenous or intracardiac systems.

The illustrative system shown in FIG. 1 is shown relative to a heart 10 and is intended to convey a subcutaneous implant that would take place over the ribs of the patient and beneath the patient's skin. A canister 12 is implanted near the left axilla, with lateral, anterior, or posterior positions being possible. A lead 14 couples the canister 12 to electrodes 16, 18 and 20, which are illustrated as implanted along the sternum of the patient, typically to the left or right thereof. The system in FIG. 1 may include an external programmer 22 configured for communication with the implant 12.

The system in FIG. 2 is a transvenous system, illustratively shown relative to the heart 30 again with the patient's ribs omitted for clarity. The canister 32 is in a high pectoral position, with the lead 34 accessing the vasculature and entering the heart. The lead 34 may include a superior vena cava coil electrode 36, a right ventricular coil electrode 38, and one or two ventricular sense/pace electrodes 40, 42. Again a programmer is shown at 44 and configured for communication with the implanted system. The system may further include a left ventricular lead (not shown).

Communication for either of the systems in FIG. 1 or 2 may be inductive, RF, direct (that is, using the patient's own tissue as a communication medium), or via any other suitable medium of communication. Such communication can be useful to configure the implanted system for sensing, therapy or other feature, to load new software or firmware for the implanted system, and to retrieve information about system operation such as device status, therapy history, diagnostic data (both device and patient related), or other suitable data. The programmers may contain such circuitry as is needed to provide processing, memory, display, telemetry/RF communications and the like for these noted purposes.

The canisters in FIGS. 1 and 2 will typically contain operational circuitry for the implantable system. The operational circuitry may include a controller and any suitable analog and/or digital circuits needed for signal processing, memory storage and generation of high-power electrical, low-power electrical and/or non-electrical outputs. For example, an analog to digital converter (ADC) can be a direct conversion ADC, a successive approximation ADC, a ramp comparing ADC, a Wilkinson ADC, an integrating, dual slope or multi-slope ADC, a pipeline ADC, or a sigma-delta ADC. Other ADC types, a modifications and/or hybrids of any of these types, may instead be used as those skilled in the art will appreciate.

The operational circuitry may be coupled to suitable battery technology for an implantable device, with any of numerous examples well known in the art, and may use various capacitor technologies to assist in the short term build-up and/or storage of energy for defibrillation or other high output purposes. The leads and external shell for the canisters can be manufactured with various materials suitable for implantation, such as those widely known, along with coatings for such materials, throughout the art. For example, the canisters can be made using titanium, with a titanium nitride or iridium oxide (or other material) coating if desired, and the lead can be formed with a polymeric material such as a polyether, polyester, polyamide, polyurethane or polycarbonate, or other material such as silicon rubber. The electrodes can be formed of suitable materials as

well, such as silver, gold, titanium or stainless steel such as MP35N stainless steel alloy, or other materials.

The location of system implant may vary. For example, the system shown in FIG. 1 is a subcutaneous-only system located on the anterior and lateral chest between the skin and ribcage of the patient. Other subcutaneous only systems (including systems without a lead 14, with multiple leads 14, or an array in place of lead 14) may be used with other anterior only placements and/or anterior-posterior, posterior only, left-right, etc. locations, including, for example, locations noted in U.S. Pat. Nos. 6,647,292, 6,721,597, 7,149,575, 7,194,302, each of which is incorporated herein by reference, and other locations as well. Subcutaneous placement can include any location between the skin and ribcage, including sub-muscular.

Illustrative transvenous systems, in addition to that of FIG. 2, include single chamber, dual chamber and biventricular systems. A fully intravenous system has also been proposed. Additional or other coatings or materials than those noted above may be used, particularly for epicardial, transvenous or intravenous systems, leads and canisters. Systems may further include an implantable "seed" that can attach directly to the myocardium without a lead at all. Some systems may combine an implantable, intracardiac seed with a subcutaneous-only defibrillator, with the seed and defibrillator enabled for two-way communication such as commanded therapy delivery and/or conveyance of sensed data.

Various alternatives and details for these designs, materials and implantation approaches are known to those skilled in the art. Commercially available systems in which the above methods can be performed or which may be configured to perform such methods are known including the Boston Scientific Teligen™ ICD and S-ICD™ System, Medtronic Concerto™ and Virtuoso™ systems, and St. Jude Medical Promote™ RF and Current™ RF systems. Such platforms include numerous examples and alternatives for the various system elements.

As shown and described there are various ways in which an implantable cardiac rhythm management device or system may be implemented with respect to the current invention. In several examples, the methods and devices that are focused upon in the present invention include the ability to capture and analyze a far-field cardiac signal. Some examples of far-field signals include a signal captured between two subcutaneously placed electrodes, or between a canister electrode and an intracardiac electrode. Near field signals and/or signals generated as a combination of near and far field signals may be assessed in other alternatives.

FIG. 3 shows an overall method for generating a cardiac rate estimate. A function "R[n]" is calculated. The function, R, may be, for example, a self-correlation function as illustrated in FIGS. 4-5, below. The function R represents a series of comparisons performed by calculating a relatively large number (50 or more) comparisons between a comparator that is a portion of a signal, and the overall signal itself, where the comparisons are performed by repeatedly shifting the comparator relative to the overall signal.

R is discussed herein as a discrete function, rather than as a continuous function; in other examples, R may be a continuous function. In an example, R[n] may be a function that can be called periodically or it may be generated on a continuing basis. Briefly referring to FIG. 5, an illustrative R[n] as calculated at a selected point in time is shown at 140, based on a scrolling comparison of a comparator 122 to a buffer 120, the buffer 120 having length M and comparator a length M/2, providing R[n] a length of M/2. One could think of R[n,t], where n has values representing an indi-

vidual calculation of R at a time t. For example, FIG. 10 shows three "R" functions—at each of t1, t2 and t3, R was calculated for n=0 to 400.

Using R[n] as calculated from step 60, a number of candidate peaks are identified at 62. FIGS. 6-7 provide examples of the identification of candidate peaks. Candidate peaks can be understood as representing a potential "rate" of cardiac events. A high match, as represented by a peak in R[n], suggests alignment of the cyclic electrical waveforms associated with a heartbeat. For example, if a peak of R[n] occurs at n=90, and the sampling rate is 256 Hz, then the time between R[0] and the peak would be 90/256=352 ms. For this example, shifting the comparator back in time by 352 ms generates a relatively higher match between the comparator and the original signal. The 352 ms can be referred to as the lag depth, and if it truly is the interval between successive R-waves, it would correspond to 171 beats per minute (bpm).

Next the method determines whether a valid track exists, at 64. Tracking is the process of monitoring the outputs of the R[n] calculation and peaks therefrom to determine whether a high-confidence cardiac rate can be reported. FIGS. 8A-8B show an illustrative method of rate tracking. FIG. 9 shows another approach to rate tracking.

If a track already exists, the method includes determining whether to confirm one of the candidate peaks, as shown at 66. If no track exists, then peak tracking is performed as shown at 68 to determine whether a new valid track can be declared. Next, following either 66 or 68, the method concludes the iteration shown by reporting a rate and confidence.

In some instances, no high confidence rate will be reported. For example, an atrial arrhythmia that is conducted to the ventricles may be characterized by unstable periods between ventricular depolarizations. As a result, the measured ventricular rate can be highly variable. When the ventricular rate is highly variable, R[n] may produce only relatively low peaks, or may not produce consistently similar peaks during iterative calculations. As a result, the output rate from the entire procedure may either be missing or may be reported with only low confidence at block 70. FIGS. 10-13 illustrate an example showing several iterations of the method of FIG. 3.

In an example, the output rate and confidence can be used to confirm or call into question the cardiac rate as calculated using a more conventional process. For example, a device may use a default beat detection scheme in which the received cardiac signal, following amplification and filtering, is compared to a detection threshold. Some illustrative beat detection approaches are shown in, for example, U.S. Pat. Nos. 8,565,878 and 5,709,215, the disclosures of which are incorporated herein by reference. Crossings of the detection threshold can then be presumed to represent beats or R-waves, and various known methods can be used to identify and eliminate detection threshold crossings that are caused by noise or overdetections. See, for example, U.S. Pat. Nos. 7,248,921, 8,160,686, 8,160,687, 8,265,737, and 8,744,555, the disclosures of which are incorporated herein by reference.

The remaining detected beats or R-waves, and intervals therebetween, can be used to calculate rate. The present invention, in some embodiments, is used to double-check the rate calculated using such methods. Such double checking can be called as needed or provided on a continuing basis. For example, a double check may be performed to confirm rate prior to therapy delivery, or prior to preparations for therapy delivery. In some embodiments, the present

invention may provide a rate estimate which can override the rate as calculated using other methods such as beat detection.

In another example, a double check may be performed to confirm accurate event detection as a way of verifying a sensing configuration where, if the sensing configuration is not verified, a sensing vector may be changed. In other embodiments, elements of the present invention can be used to provide rate calculation by default, or may be the sole source of rate calculations.

FIGS. 4-5 illustrate analysis of data using a self-correlation function and differentiate such analysis from ACF. Certain additional options and examples can be found in U.S. Provisional Patent Application No. 62/038,440, titled CALCULATION OF SELF-CORRELATION IN AN IMPLANTABLE CARDIAC DEVICE.

FIG. 4 shows a sensed ECG signal at 100. The signal can be treated as a buffer of length M, as shown at 102. The calculation of  $R[1], R[2] \dots R[M-1]$  is illustrated at 104. Each calculation of  $R[n]$  is performed, in ordinary ACF, by multiplying (via dot product) a portion of the buffer and a portion of the comparator, with the comparator shifted in time relative to the buffer. The comparator itself is simply a copy of the original buffer. Because of the shifting in time, a correction factor is needed as shown at 106, since the dot product is calculated using fewer and fewer data points as the overlap is reduced in size with each successive calculation of  $R[n]$ . The shifting of the comparator may be referred to as a lag depth.

A first simplification is to replace the multiplication to calculate a dot product with subtraction. The absolute value of the subtraction result yields a Minimum Absolute Difference (MAD). Swapping the dot product out and instead using MAD will reduce the number of required calculations by an order of magnitude or more, with minimal reduction in accuracy.

Next, to eliminate the correction factor for overlap 106, the buffer 110, having length M, is divided in half, to provide a sample portion  $M/2$  and an available lag depth 114. Then the iterative comparisons identify the area of difference between the sample 112 and the buffer 110. As shown at 116, the result is  $M/2$  total comparisons from a lag depth of zero to a lag depth of  $M/2$ .

An additional simplification may be performed in some embodiments by compressing the input data. For example, a system may perform analog-to-digital conversion of the cardiac signal at a rate of 256 Hz. The calculation of  $R[n]$  maybe performed on a limited or compressed version of the original signal, reducing the number of calculations again (though at the cost of calculations needed for downsampling, which may already be performed to facilitate data storage).

Turning to FIG. 5, an example calculation of  $R[n]$  at a particular point in time is shown. The ECG is shown at 120, as stored by a buffer having a length M. The comparator for the self-correlation is shown at 122, and comprises the half of the buffer 120 having the most recently detected samples. Preferably, the length of M is enough such that at least 2 beats will fit within the comparator during benign rate (such as 60 bpm). Thus in an illustrative example, the buffer 120 has a length of about 4 seconds and the comparator 122 has a length of about 2 seconds. Another example has a buffer 120 length of about 2 seconds and a comparator 122 with a length of about 1 second. Other sizes may be used. In some examples, the invention is characterized by having a buffer large enough to ensure at least two cardiac cycles occurring at a defined lowest needed rate would be captured, where the

lowest needed rate may be in the range of 60-120 bpm. In further illustrations, the buffer length could be from 1.5 to 6 seconds and the comparator length is between 750 milliseconds and 3 seconds. In the examples shown herein, the comparator is half the length of the buffer; in other examples, the comparator may be between one-tenth to one-half of the overall buffer length.

As shown at 124, an MAD function is applied in this example, and is then normalized using the maximum of the MAD across all of the comparisons made for a particular iteration of  $R[n]$ . This yields a result that is graphed at 126. The resulting graph includes a peak at 130, which corresponds to the zero lag depth calculation, during which the MAD would be zero, giving an output of 1. The next peaks 132, 134 and 136 each correspond to points in time where the MAD is calculated while the R-wave peaks in the comparator are aligned with a set of R-wave peaks from the buffer. For example, if peak 138 of the comparator is aligned with peak 140 of the buffer, this would also align the adjacent peaks if the R-wave intervals are similar, giving a small absolute difference at that particular alignment. In the analysis, the zero lag depth calculation is typically ignored.

Other peak alignments between the comparator 122 and the buffer 120 may generate lesser peaks in  $R[n]$ . For example, peak 142 occurs when peak 138 of the comparator is aligned with the T-wave at 144. This positioning creates a smaller MAD output which, once normalized using formula 124, would generate a noticeable but small peak in  $R[n]$ .

The  $R[n]$  function may be calculated periodically. In one example, because the buffer and comparator take up fairly large blocks of time, such as more than one second or even two seconds, there is no need to continuously recalculate  $R[n]$ . For example, the period between recalculations of  $R[n]$  may be approximately the duration of the comparator, or, in another example, approximately half the duration of the comparator. For example, if the comparator length is 2 seconds, the buffer may be 4 seconds long and the calculation of  $R[n]$  could be performed at one second intervals. Thus, every second, the buffer would be updated and the comparator reformed, and the sequence of comparison and time shifting would be repeated. FIG. 10, for example, shows repeated calculation of  $R[n]$  at  $t1, t2,$  and  $t3$ , hence,  $R[n,t1], R[n,t2],$  and  $R[n,t3]$  are shown at 200 of that figure.

The illustrative examples in the various Figures herein suggest the use of an asynchronous calculation of  $R[n]$ . These are asynchronous insofar as the calculation is not linked or synchronized to a beat detection performed by some other method. Other embodiments may instead use a beat-synchronous update or recalculation of  $R[n]$ . A hybrid embodiment may update synchronously to take advantage of microprocessor/microcontroller wakeup caused by beat detection, but may limit calculation of  $R[n]$  to occur no more frequently than some desired metric. For example, calculation of  $R[n]$  may be beat synchronized at intervals of no less than one second.

The optional simplifications in FIGS. 4-5 are provided for explanation and illustrative purposes. However, these simplifications can be omitted in some embodiments, as the peak selection and/or tracking examples shown below are not contingent on any particular type of calculation for  $R[n]$  unless otherwise stated.

FIGS. 6-7 illustrate the analysis of  $R[n]$  peaks to identify candidate cardiac rates and a cardiac rate estimate. FIG. 6 shows the operation in a flow diagram, while FIG. 7 provides a graphic example.

In FIG. 6, beginning at block **150**, the method starts with the identification of any peaks within  $R[n,tk]$ . In this example, peaks that are within 50% of the largest peak and that meet some minimum size criteria are reported forward to a peak tracker, as indicated at **152**. Tracking may be performed as shown below in FIGS. **8A-8B** and **9**, for example.

A set of largest candidates are then selected, as indicated at **154**. In an illustrative example, a threshold may be set within the scaled calculation of  $R$ . For example, using the formula **124** in FIG. **5**, the threshold for candidate peaks may be set at  $R=0.3$ , such that in order to be considered a candidate, a peak must be larger than 0.3 times the largest peak. The largest peak will always occur at  $R[0]$ , as that is when the comparator and buffer are perfectly aligned and thus  $R[0]=1$ . Any subsequent peak greater than 0.3 may be a candidate peak. In an example, up to five of the largest peaks greater than 0.3 (excluding the peak at  $R[0]$ ) are treated as candidates.

As shown at **156**, if any of the largest candidates have a lag depth which would place the candidate in the “tachy zone”, a tachy flag is set. A candidate peak is in the “tachy zone” if the lag depth of the peak is relatively small. This may be identified by asking whether there is a peak at  $R[nt]$  where  $nt$  is less than a tachy threshold. For example, if the tachy zone flag is to be set for candidate peaks suggesting a rate above 160 bpm, and the sampling rate is 256 Hz, then a peak at  $n<96$  is in the tachy zone, since the peak occurs with a lag depth of less than 375 ms equating to a rate above 160 bpm. The tachy flag, if set, indicates that the analysis suggests possible tachycardia, regardless the rate it ultimately concludes is most likely correct.

Next, a first candidate peak is selected as shown at **158**. Either of two rules for finding the candidate peak can apply: a peak having a lag depth that allows a rate to be found that is greater than 75 bpm and which is larger than the first-in-time peak by a chosen limit,  $\delta$ , can be chosen, as shown at **160** or, otherwise, the first-in-time peak of the candidate peaks is chosen, as shown at **162**. The first-in-time peak is the candidate peak having the least lag depth. The first rule, at **160**, allows a peak which is significantly larger than the first-in-time candidate peak to be selected, as long as it is above a rate threshold. In the example, the rate threshold is at 75 bpm; other thresholds may be used.

In the illustrative example, the combination of **160** and **162** ensure that peaks associated with higher rates will be analyzed first and, to this extent, biases the method to seek out higher rate candidates. A bias toward higher rates may be desirable to minimize the risk of heart rate underestimation in the presence of a tachyarrhythmia.

Next, the candidate peak is analyzed by looking for and counting “pickets”, as shown at **164**. The pickets are peaks at multiples of the lag depth of the candidate peak. FIG. **7** shows an example of pickets. A first peak is found at a lag depth of 110 samples (corresponding to 140 bpm sampled at 256 Hz). This lag depth gives an R-R interval as shown at **180**. Two pickets can be identified by observing additional peaks at lag depths of 220 samples and 330 samples, which are multiples of the lag depth of the candidate. The pickets at **182** and **184** provide confirmation that the 140 bpm rate is likely the correct cardiac rate.

The counting of pickets can include an allowance for some variation in peak spacing. For example, the picket peaks should be equally spaced, within a maximum tolerance. The tolerance can be defined as a function of the calculated heart rate, or may be set in terms of milliseconds or samples ( $n$ ). For example, if a first peak is at a lag of 80

samples (313 milliseconds at 256 Hz), a picket would be expected to appear between 75 and 85 samples away (293 milliseconds to 332 milliseconds). A narrower or wider tolerance may be defined in other examples.

It should be noted in this example that the largest peak is not the first selected candidate peak. There are two reasons why this is so: first, the largest peak is not sufficiently large relative to the candidate peak to meet rule **160**. In an example, to select a peak other than the first peak as a candidate, the later peak needed to be at least 30% larger than the candidate (making  $\delta$  relative), which is not the case here. In another example,  $\delta$  may be a fixed value, such as 0.2 using the MAD formula **124** from FIG. **5**.

Second, the largest peak is at a lag depth corresponding to a rate of 70 bpm, again not meeting rule **160**. In the example, to select a peak other than the first peak as a candidate, the later peak needed to be at a lag depth corresponding to a rate greater than 75 bpm. Other thresholds may be chosen. The picket determination may require that the peaks used to establish subsequent pickets be among the largest  $N$  peaks or that each peak be larger than a predetermined threshold, such as a peak above 0.35 or 0.50 using the formula at **124** in FIG. **5**.

Both of rules **160**, **162** can be modified in other examples.

For illustrative purposes, FIG. **7** also illustrates a tachy zone **186**. The tachy zone, in this example, covers a lag depth from zero to about ninety. This corresponds to an offset of up to ninety samples. In the illustration shown, 384 samples equate to 1.5 seconds, meaning a 4 ms sampling period. Ninety samples would correspond an RR Estimated Interval of 360 ms, equating to 167 bpm. As noted above, other settings for the tachy zone may be used.

Returning now to FIG. **6**, the method proceeds by determining whether the picket test passed, as shown at **168**. In an example, the picket test passes if there are at least two pickets identified relative to the candidate peak. In another example, multiple picket thresholds may apply depending on the lag depth of the peak under analysis. For example, in analysis with maximum lag depth  $N$ , a rule set may call for least two pickets for a candidate peak having a lag depth of less than  $N/3$ , and at least one picket for a candidate peak having a lag depth greater than  $N/3$  and less than  $N/2$ . This relative approach accommodates the fact that, for a candidate peak having a lag depth between  $N/3$  and  $N/2$ , only one picket is possible, as the second picket would be at a lag depth greater than “ $N$ ” itself. Such relativity is optional, and may be managed, at least in part, using the dominant peak test discussed below.

If the picket test is passed, the method does a final check for any large peak in the tachy zone, as shown at **170**. In some, limited instances, a large number of peaks may be reported during a chaotic tachy event. In such a case, the decision to select only “ $N$ ” largest candidate peaks at block **154** could fail to choose as a candidate a peak in the tachy zone. Therefore the test at **170** looks for any peak in the tachy zone which is within 30% of the size of the largest peak, but which did not get identified as a candidate. If a large tachy zone peak is identified at **170**, this peak is subjected to a picket test as well. If the peak chosen at **170** has pickets such that it passes the picket test, then the large tachy zone peak from block **170** is reported as the RR estimate at **174**. Otherwise, as noted at **156**, the tachy zone flag is set and the candidate peak that did pass the picket test at **168** will be reported as the RR estimate at **174**.

In some examples, all candidates may be checked until one is found which passes the picket test and, if no picket test passes can be found for any of the candidate peaks, the

method proceeds to block 172. Alternatively, only the first selected candidate peaks is subject to the picket test at 168, and, upon failing the picket test once, the method goes to block 172.

Upon reaching block 172, a dominant peak test is applied. The dominant peak test determines whether there is a peak that is 30% larger than all other peaks in R[n] (excluding the peak at n=0). If so, then that dominant peak is identified as the RR estimate.

The dominant peak test 172 may also be limited to passing when the identified dominant peak is at a lag depth corresponding to a rate below a preset threshold, such as 60, 75 or 90 bpm. The rate limit may be included in block 172 as an acknowledgement that there may be no pickets in the analyzed data for a low rate peak. This is so because the time span of the R[n] calculation may not be sufficient to produce a picket pattern for all heart rates, particularly lower heart rates with longer beat intervals.

For example, using a buffer of 3 seconds and comparator of 1.5 seconds length, the first picket for a peak at a lag depth of 800 milliseconds (75 bpm) would be at 1.6 seconds. Such a picket could not be identified given the buffer/comparator sizes, as the greatest lag depth is only 1.5 seconds given the 3 second/1.5 seconds buffer/comparator sizes. On the other hand, a dominant peak at a smaller lag depth, such as 500 milliseconds (120 bpm) would be expected to have two pickets in this scenario, and, absent any pickets, would not be treated as a highly likely RR estimate as there would appear to be less periodicity than would ordinarily be associated with a confident RR estimate.

If an RR estimate is calculated via one of the three possible avenues—candidate peak passing the picket test (158-164-168), a large tachy peak (170) or the dominant peak test (172), the RR estimate can be reported out. A confidence grade can also be applied. In an example, three grades are available:

HIGH confidence if either  
 Rate>TachyThreshold with 3 pickets and  
 R>HCThreshold, or  
 Rate<TachyThreshold with 2 pickets and  
 R>HCThreshold;  
 MID confidence by default if no High or Low Confidence condition is met; and  
 LOW confidence if  
 R<LCThreshold or  
 1 or fewer pickets and Dominant Peak Test 172 not passed

In this example, TachyThreshold can be set in a range calling for high rates, for example, over 150, 180 or 200 bpm. In some examples, TachyThreshold may be selected in light of the buffer and comparator size, in order to link to the quantity of pickets that could appear. The HCThreshold definition will be reliant on just how R is computed. In an example, given computation of R using the formula at 124 in FIG. 5, HCThreshold is set at 0.65. Likewise, LCThreshold will be defined in a manner closely tied to the computation of R. In an example also using formula 124 from FIG. 5, LCThreshold is set to 0.35.

The confidence information may also be incorporated into the tracking steps shown in FIGS. 8A-8B. For example, switching from one track to another, or declaring a new track, may be accelerated in response to a high confidence rate, while such steps may be delayed for a low confidence rate.

In a Bigemini pattern, there are two alternating morphologies for ventricular depolarization or “R” waves. When a Bigemini pattern is analyzed using self correlation, it can be

difficult to determine whether the output reflects R-wave and T-wave peaks, which alternate and have different morphologies, or two R-waves having a Bigemini pattern. Particular approaches to identifying Bigemini and/or jitter are shown in FIG. 16 (Bigemini) and FIG. 17 (jitter), below.

FIGS. 8A-8B illustrate one method of tracking cardiac rate. Starting at block 200 in FIG. 8A, any suitable manner of finding R[n], selecting a set of peaks and generating an RR Estimate are performed. The methods illustrated in FIGS. 4-7 provide various options for block 200. The tracking method begins by determining whether there is an existing or “active” track, as 202. If so, the method proceeds to B in FIG. 8B.

If there is no existing track, the method determines whether a valid RR Estimate has been generated, as shown at 204. If no valid RR Estimate can be had from the prior analysis, no new track will be declared, and the method terminates with no track at 212 and awaits a next iteration. If a valid RR Estimate was found, the method next determines whether X out of the last Y RR Estimates (or attempts) are similar, as shown at 206. For example, if 3 of the last 4 RR estimates are similar, the test at 206 would be met for an X/Y of 3/4. In one example, a 3 of 6 rule is applied at 206. If the test at block 206 is met, then a new track is established at 208.

If the test at 206 is not met, a new track may still be established on the basis of a single very high confidence rate calculation. The definition of very high confidence may vary. In one example, the HIGH/MID/LOW confidence rules applied above may be used, and any RR estimate that is calculated with HIGH confidence would be sufficient to meet the rule at 210. In another example, a separate threshold for the very high confidence rule at 210 may be set. In one embodiment, block 210 is met when  $R > 0.85$  in a system calculating R using the formula shown at 124 in FIG. 5. If the rule at 210 is met, a new track is established as shown at 208. Otherwise, no new track is set, as noted at 212.

Turning to FIG. 8B, a valid track exists, and it is determined whether the latest RR Estimate is within the Gate, as shown at 220. The Gate has a width, which can be defined in various ways. For example, the gate may be 40 milliseconds wide, or it may be 20 bpm wide. The Gate may be centered on a prior RR Estimate or average of 2-4 previous RR Estimates. In one illustration, the Gate is calculated by converting the most recent RR Estimate to bpm, and setting the upper and lower bound 10 bpm away. Thus, for example, if the most recent RR estimate is 400 ms, that converts to 150 bpm, and the Gate would be from 140 bpm to 160 bpm and an RR estimate between 429 ms and 375 milliseconds would be considered “in” the gate.

Gate width may also factor in rate variability. For example, the variability of a set of recent RR Estimates can be calculated by simply tracking how much change there is one from one estimate to the next. The Gate width may be increased if the rate appears to be highly variable in this example.

If the RR Estimate is within the Gate, the method declares the track continued at 222. The RR Estimate is also reported out.

If the RR Estimate is not within the Gate, then the Coasting rules are applied. Coasting takes place when a valid track has been identified/defined, but an iteration of the RR Estimate calculation fails to yield a result that meets the track definition. The use of Coasting allows the track to continue and passes over temporary disturbances such as noise or PVC, for example. Coasting avoids gaps in the output RR Estimate by holding the last known RR Estimate.

Coasting can be particularly useful when a peak exists in  $R[n]$  but fails, for whatever reason, to otherwise pass the rigorous tests in the peak selector for identifying the a candidate peak as an RR estimate. Coasting is available to salvage the RR Estimate for such peaks, but only for a limited time.

In the illustrative example, Coasting is not allowed to continue indefinitely and a limit is applied, as shown at **224**. If coasting is within its limits, the method continues via block **232** and continues on the track at **222**. To limit coasting, various rules can be applied and each may have a different limit.

For example, as shown at **226**, if no RR estimate or peaks are reported up from the calculation of R, there may be a first, "No Data" limit to the duration of coasting. In an example, the system will only allow a single iteration of "No Data" before declaring the track lost at **236**. Such a "No Data" condition can occur, for example, if noise has interrupted sensing and none of the peaks in  $R[n]$  exceed a base threshold. A "No Data" condition can also take place if a very polymorphic arrhythmia onsets, such that  $R[n]$  simply fails to have any significant peaks.

Next, there is a coasting state in which no RR Estimate is produced, as shown at **228**, with this state also requiring that there not be any of the reported peaks in the gate, as shown at **230**. Thus, block **228** covers one set of circumstances in which rate estimate is lacking and the track is not being confirmed, while block **230** covers a state in which there is a lower confidence confirmation of the track, whether or not an out-of-track RR estimate has been identified.

A fourth form of coasting can take place as part of a transition or "jump" to an alternate track, as noted at **232**. In this instance the existing track continues until either an alternate track condition is met by having a "new" track declared using a similar determination as in **206** or **210** of FIG. 8A.

As can be seen from blocks **226**, **228**, **230**, **232**, there are different inputs to the coasting state, each of which comes with somewhat varying confidence levels. For example, confidence in the underlying track or sensing reliability is low when no data is received **226**, and not much better when there is no RR Estimate reported and none of the reported peaks fall within the gate **228**. These two blocks **226**, **228** may be combined for a single limit in the range of 1-3 iterations before the coasting limit is exceeded. Alternatively, block **226** may have a lower costing limit (1-2 iterations) while block **228** has an equal or higher limit (1-4 iterations), with a combined limit matching the higher limit (1-4).

The alternate peak in gate condition, at **230**, is a much higher confidence condition, by suggesting that the track may still be valid, even if sensing a anomaly, such as noise, is present. This condition **230** may have a still higher coasting limit, in the range of 2-10 iterations or may be subject simply to an overall limit (in the range of 2-10 iterations) which would combine any coasting within any of **226**, **228**, **230** or **232**.

Block **232**, the Jump limit, is present to enable quick transition to a new track, without having to first wait for a declaration that the track is lost at **236** before assessing whether a new track exists. The Jump limit also prevents a shift to a new rate based on peaks that appear within an old, but no longer valid, track. When a coasting limit is met at **224** via the jump limit, the outcome follows a different path to **238**. As a result, if the Jump limit is met, the method simply continues with a new track definition. To meet the Jump limit **232**, in an illustrative example, the same rule as

was applied at **206** may be applied to the new track. As noted at **232**, the Jump limit may be applied just for high rate conditions, which are of greater concern generally than low rate conditions, using, for example, a limit in the range of 100-180 bpm, with 150 bpm being one example rate in particular.

The use of the Jump allows a quick transition to a higher rate RR Estimate, with a less stringent rule set when there is an existing track and a jump takes place. In the example, to declare a new track when no track has been identified would require a higher confidence in the new data than is required for the jump.

If the coasting limit is exceeded at **224**, the track will be declared lost, as noted at **236**. If the coasting limit is not exceeded, the coasting "state" can be recorded **234**, with different coast states identified for each of the different coasting conditions **226**, **228**, **230**, **232**. While coasting, the track continues as shown at **222** until the next iteration is called.

FIG. 9 illustrates tracking of cardiac rate over time. There may be various triggers for performing self-correlation, as noted at **240**. For example, self-correlation may be a default, continuing analysis called by an implantable system throughout the life of the system. Alternatively, self-correlation may be called in response to an identified potential condition necessitating treatment, such as an elevated rate condition. In one example, the cardiac rate may be calculated using conventional R-wave detection schemes (often by comparing the detected cardiac signal to a time varying threshold). If the identified rate crosses a threshold, the self-correlation methods may be initiated to confirm elevated rate. Thresholds may be set, for example, in the range of 100-180 bpm, or higher or lower, as desired.

In one example, a cardiac therapy system may use a number of intervals to detect (NID) approach or an X/Y filter to transition from unconcerned state into a therapy preparation and delivery state. For example, an X/Y filter may call for 18 out of 24 prior detected heart beats to be analyzed and considered treatable before therapy is delivered. For such a system, if X reaches a lower threshold, for example, 8/24, the self-correlation may be called to begin analyzing and confirming (or rejecting) calculated rates before the 18/24 boundary is reached. Similarly, if an NID approach is used, an NID threshold that is below a therapy boundary may be used to trigger the self-correlation analysis.

In another example, self-correlation may be called to periodically confirm sensing integrity by calculating a cardiac rate for comparison to other rate calculation methods/circuits. In some examples, the self-correlation shown in the present application may serve as the sole estimator of cardiac rate in an implantable device.

Once the analysis is triggered at **240**, the self-correlation is performed at intervals, such that  $R[n,t]$  is calculated for each of  $t=\{0, 1, \dots, i\}$ , as shown at **242**, **244**, **246**. From this series of calculations, a rate track is sought and, if possible, established as shown at **248**. The analysis may confirm or reject a calculated rate, as shown at **250**.

In addition, the analysis may be used to confirm, accelerate or delay therapy delivery, as noted at **252**. Returning to an above example, if the self-correlation is called once the cardiac rate identified by conventional R-wave detection crosses a threshold, if self-correlation confirms an elevated heart rate requiring therapy, a therapy threshold may be lowered. For example, if a system uses an X/Y counter set to 18/24, the counter may be reduced to 12/16 if self-correlation confirms a very high rate prior to the X/Y counter condition being met. In another implementation, the self-

correlation RR estimate can replace a conventionally calculated heart rate for a specified period of time, quantity of detected events, or until a next calculation of  $R[n]$  and analysis thereof is performed.

FIGS. 10-13 demonstrate several cardiac rate tracking steps using hypothetical examples. FIG. 10 illustrates the initiation of a rate tracking activity. The self-correlation function is calculated at each of times  $t_1$ ,  $t_2$  and  $t_3$ , as shown at 260, 262 and 264. For purposes of understanding operation of this embodiment, a graph at 266 illustrates how the peaks of each  $R[n]$  calculation align with one another. Looking at  $R[n,t_1]$ , the graph at 260 illustrates that three peaks above the  $R=0.3$  threshold were found, at lag depths of approximately 95, 190, and 285 samples. Using the method of FIG. 6, these three peaks 268, 270, 272 would be reported out of the peak analysis.

Next, again using the rules shown in FIG. 6, the first peak 268 from  $R[n,t_1]$  is chosen as a candidate peak. Pickets would then be sought. As illustrated, there are two pickets identified for candidate peak 268, to the additional peaks at 270 and 272. Thus the method of FIG. 6 would confirm that peak 268 provides the RR estimate, while each of peaks 268, 270 and 272 would be reported to the tracking engine.

The RR Estimate from  $R[n,t_1]$  is shown in graph 266 at 274; the other peaks from  $R[n,t_1]$  are also shown as alternate peaks. Likewise, RR Estimates result from the analysis of the other two calculations at  $R[n,t_2]$  and  $R[n,t_3]$ , as shown at 276 and 278. Here, no track has yet been declared. As a result, each of the RR Estimates may be deemed to yield a medium-confidence rate estimate, until a track can be declared.

Turning to FIG. 11, the matching of the results for each of  $R[n,t_1]$ ,  $R[n,t_2]$  and  $R[n,t_3]$  is sufficient to meet the track definition in FIG. 8B using a 3/6 rule. Therefore a track gate is shown at 280 for use in assessing the next iteration of the self-correlation, at  $R[n,t_4]$ . The newly calculated  $R[n,t_4]$  is shown graphically at 282. In  $R[n,t_4]$ , the peak associated with a T-wave comparison appears at 284 in addition to the much higher peak for the R-wave at 286. Again applying the rule set in FIG. 6, the first peak is at 284, and could be chosen if the rule at 162 in FIG. 6 controlled. However, the second peak at 286 is significantly larger than the first peak and appears at a lag depth that supports a rate greater than 75 bpm, meeting the rule at 160 in FIG. 6. Therefore peak 286 is selected for analysis, and is found as before to have two pickets (not shown) and is used to report out an RR Estimate. As shown at 288, the RR Estimate for  $R[n,t_4]$  is within the gate.

It should also be noted that the peak 286 that is used for the RR Estimate exceeds an HC Threshold for high confidence. Therefore, the RR Estimate at 288 would then be used for rate reporting by the tracker, with high confidence.

FIG. 12 presents a different scenario for the calculation of  $R[n,t_4]$  after the track is established and gate is set at 290. Here, the output has changed dramatically from  $R[n,t_3]$  to  $R[n,t_4]$ , as shown at 292. Using the rules of FIG. 6, the first peak 294 is chosen as a candidate peak, however, no pickets are found because the next significant peak, at 296, is too far away. There is also no dominant peak. As a result, no RR Estimate is calculated.

Looking at the updated overall graph, it can be seen that gate 298 is empty, without an RR Estimate or an alternate peak therein. As a result, for  $R[n,t_4]$ , the analysis is in a coasting state in FIG. 12. Because no RR Estimate could be calculated based on  $R[n,t_4]$ , a rate would not be reported to the Peak tracker. Because the track continues in a coasting state, an output rate estimate would be provided and, in an

example, would be a value within the gate or could be the same as a previous output. Based on the empty gate at 298, the output rate estimate would be given a low confidence level.

FIG. 13 presents another different scenario for the calculation of  $R[n,t_4]$  after a track has been established. Gate 300 is set for the analysis, however,  $R[n,t_4]$ , as shown at 302, does not identify a peak that sits within the gate, as shown at 304, as the RR Estimate. Instead, a peak 306 at a lesser lag depth is identified as the RR Estimate. Thus the RR Estimate 308 sits away from the gate 304, though one of the alternate peaks in  $R[n,t_4]$  is within the gate.

Referring back to FIG. 8B, the event shown in FIG. 13 would trigger a coasting analysis using the tachy jump limit 232. Specifically, RR Estimate 308 is at a relatively short lag depth shown, in the example, as corresponding to a rate between 180 and 240 bpm. Given this is the first such RR Estimate, not enough information is available yet to declare a new track. This could be a momentary jump, or it could be the onset of a new rhythm. Until more data is received, the illustrative method will wait and coast with the track continuing. The output rate estimate would continue to be within the existing track. However, because the RR Estimate is outside of the gate, any rate estimate would be reported with low confidence. A Tachy flag would be set based on the large peak in the tachy zone.

FIG. 14 illustrates a dominant peak test for peak selection in FIG. 6. In the illustrative example, a result for an  $R[n,t]$  calculation is shown with a large peak at 320 with a lag depth of about 200 samples. Here the signal is giving off difficulties. In the first instance, the peak at 320 lacks any pickets as indicated at 322, largely because any peak would appear beyond the end of the  $R[n,t]$  calculation due to the large lag depth of peak 320. In an illustrative analysis, the picket test would therefore fail.

Using the analysis of FIG. 6, a next candidate peak could be reviewed, here, candidate peak 324 could be checked. However, as indicated at 326, again no picket would be identified. There is no picket peak within the set of identified peaks above threshold 328 at the location where a picket would have to appear for peak 324 to pass the picket test. In an alternative approach, a single pass system would only look at a single candidate to identify pickets; once peak 320 fails in this analysis, no other peak would be analyzed.

As shown in the lower portion of FIG. 14, a method for identifying a dominant peak can begin by determining that no peak passes the picket test, as shown at 340. Next, it is determined whether there is a peak that is larger than all other peaks (except the null peak at zero lag depth) by some margin, as shown at 342. In the illustrative example, the margin is a percentage, X, which may be in the range of 30%, with illustrative ranges from 15% to 50%, or larger or smaller. Those skilled in the art will recognize that other "margins" can be defined depending, for example, on the manner in which  $R[n,t]$  is normalized, without modifying the principle of the dominant peak test shown in FIG. 14.

Here, peak 320 passes block 342 because the next largest peak in the  $R[n,t]$  graph, at 324, is lower than peak 320 by margin 330. The dominant peak test then looks at whether the lag depth of the large peak is beyond a dominant peak lag threshold, as shown at 344. The threshold is shown at 332. In an example, the threshold 332 may be selected pass any peak that necessarily fails the picket test due to its lag depth being such that no pickets can appear in  $R[n,t]$ . Thus, in the example, the threshold 332 is set at a lag depth of 200, within a window of total depth 400. Any peak, such as peak 320,

having a greater lag depth than the threshold 332 would have no pickets within the analysis window.

Since peak 320 passes both tests 342 and 344, peak 320 is identified as the dominant peak, and the method will report a rate corresponding to the lag depth of peak 320. Had either of tests 342 or 344 failed, the method would have ended at 350 without identification of a dominant peak. Given that no picket test was passed, as indicated at 340, ending at block 350 may, in some examples, lead to a result of no rate being estimated based on the particular  $R[n,t]$  calculation. In other examples, a low confidence rate estimate may still be made, using, for example, the largest peak (here 320). In another example, two possible rates may be reported if neither a dominant peak nor a picket-test-passing peak is found: a rate corresponding to the largest peak 320, and a rate corresponding to the next largest peak 324, each with low confidence.

FIG. 15 illustrates a high rate peak test for the peak selection in FIG. 6. Here, numerous peaks appear in the  $R[t,n]$ , and the largest five peaks are labeled A, B, C, D, E. Using the picket test rules peak A, at 360, has pickets 362 (corresponding to peak C) and 364 (corresponding to peak E), and passes the picket test. However, there is another peak, 366, which was not selected as one of the candidate peaks, due to its being somewhat smaller.

The high rate peak test begins, as shown at 370, by determining whether the picket test was passed. Here, the picket test is passed as shown by pickets 362 and 364 for peak 360.

Next, the high-rate peak test checks whether there is a tachy peak within some percentage of the maximum, as shown at 372. By “tachy peak”, the method is indicating a peak not among the candidate peaks A, B, C, D, and E, which falls within a tachy zone. In the illustrative example, using a sampling rate of 256 Hz, a tachy zone may be defined as any peak at a lag depth of less than 100, which would correlate to a period of 396 milliseconds or less and a rate above 150 bpm. In an alternative example, block 372 may identify any peak that is within the tachy zone, without having reference to the height of the maximum peak.

In this example, such a peak does appear at 366. Next, the picket test is re-performed, using the peak identified in block 372. The retest is shown illustratively at 380. Peak 366 has pickets 382 and 384, as shown.

If the picket test is passed at 374, then the originally selected peak is replaced by the tachy peak identified at 372 and which passed the picket test at 374. In the illustrative example, rather than selecting peak A, at 360, the method instead selects peak 366. In this illustration, the lag depth calculated goes from 120 to 60, causing an increase in the identified heart rate from 130 bpm to 260 bpm. In some examples, because the peak that yields the heart rate estimate is a lower peak and was not identified in a first pass, the outcome may be treated as having a lower confidence or an ambiguity flag may be set to indicate there is some ambiguity present.

As noted above, in a Bigemini pattern, there are two alternating morphologies for ventricular depolarization or “R” waves. A Bigemini pattern of ABAB will yield alternating peaks within the self-correlation result  $R[n]$ . High peaks will appear when “AB” is compared to “AB”, with each of the A peaks aligned and each of the B peaks aligned, and relatively lower peaks when “AB” is compared to “BA”, that is, A is compared to B and B to A. Within Bigemini patterns, however, the AB and BA intervals will often be consistent.

A cardiac signal with relatively large T-waves, when compared to R-waves, may appear somewhat similar to some Bigemini signals. This requires two elements: first, the R and T waves must be generally fairly similar, and second, the R-T and T-R intervals must also be fairly similar. The R-wave would usually be narrower than the T-wave, but if both are monophasic the two can be fairly similar. The R-T and T-R intervals are generally similar in only a narrow range of rates for any given patient. Moreover, as noted, for example, in U.S. Pat. Nos. 7,623,909 and 8,200,341, a sensing vector in which the R and T wave amplitudes are similar would often be disfavored from the outset, and vector selection can be used to choose a vector with a larger R:T amplitude ratio.

When a Bigemini pattern is analyzed using self-correlation, it can be difficult to determine whether the output reflects R-wave and T-wave peaks, which alternate and have different morphologies, or two R-waves having a Bigemini pattern. Vector selection can be used to avoid confusion, along with a set of rules shown and demonstrated in FIG. 16.

As shown at 400, a Bigemini rhythm, when subjected to the self-correlation analysis of FIGS. 4-5, above, yields a pattern of high and low peaks. Using the methods of FIGS. 6-7, above, would ordinarily select peak 402 as the RR Estimate peak. However, because the actual rhythm is a Bigemini signal, the true RR is at half the lag depth of the originally chosen RR Estimate, that is, at peak 404.

To address this potential issue, an optional Bigemini test is shown below at 408. The optional Bigemini test can be turned “on” by a physician, as not all patients are prone to this rhythm pattern.

The test begins after an RR Estimate has been calculated at 410. Next, the test looks for peaks spaced by one half of the lag depth of the RR Estimate, as shown at 412. As shown in the graphic at 400, peaks 404 and 406 meet the check at 412.

After passing the check at 412, the method determines whether the values of the  $R[n]$  peaks identified in block 412 are within a predetermined ratio of the value of the  $R[n]$  peak original selected as the RR estimate. “RVal” is used as the shorthand for the value of  $R[n]$  of each peak in the drawing. Here, a threshold is shown in the graphic 400, and peak 404 exceed the threshold, passing step 414. The illustrative threshold is 55% of the RVal peak for the original RR Estimate; other thresholds may be used in the range of, for example, 40-80%.

With both 412 and 414 passed, the Bigemini test will restate the RR Estimate, using the peak at RR Est/2 as shown at 416—here, peak 404 becomes RR Estimate. However, in light of the identification of a likely Bigemini pattern, for purposes of determining confidence in the outcome, the RVal for the original RR Estimate is retained, as indicated at 416. Thus, although peak 404 has an  $R[n]$  of about 0.5, the reported RVal figure would be about 0.75,  $R[n]$  value for peak 402.

If either of 412 or 414 fails, the Bigemini test fails as well, and the method ends at 418. Likewise, after any correction is made at block 416, the Bigemini test ends.

FIG. 17 addresses a test to check for jitter. Jitter may occur where the R-R interval is occasionally inconsistent, leading to a split peak in the output such as shown in the graphic at 430. Using the methods of FIGS. 6-7, an RR estimate is identified at 432. However, a split peak appears at 434, with the split peaks occurring at about  $RR_{est}/2$ , with an  $R[n]$  value for each of the split peaks exceeding a relative threshold, suggesting that there may be jitter (or alternans, as the varying R-R intervals can be called) occurring.

To text for such jitter, a method is shown at **436**. First, an RR Estimate is calculated, as shown at **438**. Next the method checks for split peaks at  $RRest/2$ , as shown at **440**. If such split peaks are found at **440**, the method determines whether each of the split peaks meet an Rval threshold, as shown at **442**. In the illustrative method, the Rval threshold is 50%; other thresholds may be used in the range of, for example, 40% to 80%.

If each of checks **440** and **442** are passed, then the method will restate the RR Estimate as  $RRest/2$ , as shown at **444**. As with the bigemini test, the Rval from the original RRest can be retained in this example. If either of checks **440** and **442** fail, then the jitter test ends as shown at **446**.

For each of the Bigemini test (FIG. **16**) and Jitter test (FIG. **17**), when the tests cause a modification of the RR Estimate, a flag may be set, a counter may be incremented, or the event may otherwise be counted/identified. In some examples, passing either of these tests can cause the system to store data in memory for later physician retrieval to review any such events.

FIGS. **18A-18B** show several ways in which the R[n] Calculator, a Peak Selector, an RR Estimate Tracker, and a Therapy Decision can be linked together. In the example of FIG. **18A**, the R[n] Calculator **460** reports the output of an R[n] calculation to a Peak Selector **462**. The Peak Selector **462** provides an RR Estimate(a) and a set of Peaks to the Peak Tracker **464**. The Peak Selector **462** also provides, in this example, the RR Estimate(a) to a Therapy Decision Block **466**, along with any Flags arising out of the Peak Selector **462** analysis as well as a Confidence(a) indicator. The Therapy Decision Block **466** can use the RR Estimate(a) from the Peak Selector **462** as well as any Flags and the Reported Confidence(a) to determine whether a conventional rate estimate is likely correct or incorrect. The RR Estimate Tracker **464** reports an RR Estimate(b) and Confidence to the Therapy Decision **466**.

For example, the Peak Selector **462** may identify an RR Estimate(a), but with low Confidence(a), while the RR Estimate Tracker **464** identifies a different RR Estimate(b) with higher Confidence(b), based on a secondary peak that meets an existing Track and which either has one or more pickets or is in a tachy zone, even if the reported RR Estimate(a) is not in the track. In that case, the Therapy Decision block **466** may ignore the RR Estimate(a) and instead adopt RR Estimate(b).

In another example, if the RR Estimate(a) is reported with High Confidence(a), but the RR Estimate Tracker does not find a peak in an existing track and reports it is coasting, using a preserved, prior RR Estimate and reporting a low Confidence(b), the Therapy Decision block **406** may adopt RR Estimate(a) over RR Estimate (b).

Thus, in the example of FIG. **18A**, Therapy Decision block **466** is allowed to select from between RR Estimate(a) and RR Estimate(b), using the reported Confidences from each of the Peak Selector **462** and RR Estimate Tracker **464**.

In the example of FIG. **18B**, the R[n] Calculator **480** again provides its results to the Peak Selector **482**. The Peak Selector **482** performs its function and provides Peaks, an RR Estimate(a), any set Flags, and a Confidence(a) to the RR Estimate Tracker **484**. The RR Estimate Tracker **484** performs its function and provides an RR Estimate(b), Confidence(b) and any set Flags to the Therapy Decision block **486**. Thus, in FIG. **18B**, the RR Estimate Tracker determines a single output RR Estimate(a) with associated Confidence(b) to the Therapy Decision block **486**.

One or more of the individual blocks in FIGS. **18A-18B** may be separate pieces of hardware in a single system,

though two or more blocks may be integrated in a single dedicated circuit. Alternatively, the separate blocks in FIG. **18A-18B**, may be separate functional blocks in a larger software structure. For example, given a stream (or stored stack) of data, a function call to Calculate R[n] **460/480** could be performed, followed by a function call to perform Peak Selection **462/482** given the output R[n], followed by a function call to Track RR Estimate **464/484** using the RR Estimate(a) and Peaks from Peak Selection, which may all be used as inputs (along with other data) for calling the Therapy Decision **466/486**. In one example, blocks **480**, **482** and **484** are provided on a dedicated circuit and the outputs of these blocks are provided to a processor or controller where the Therapy Decision process is performed.

In the embodiments shown in FIGS. **18A-18B** (and other examples shown above and below), an RR Estimate can be considered an estimate of cardiac rate. Where a confidence measure is provided in association with an RR estimate and one or more peaks, such can be treated as one or more possible estimates of cardiac rate.

FIG. **19** illustrates an integration of two methods for identifying rate. A conventional rate method is illustrated using block **500**, where R-waves are detected individually by comparing a detected signal to a threshold. Conventional R-wave detection may be used in block **500**. Some illustrative examples appear in U.S. Pat. Nos. 8,565,878 and 5,709,215.

Detected R-waves are reported to a noise/overdetection removal block **502** which confirms the R-waves are likely cardiac events. Once the individually detected R-waves have been confirmed at **502**, rate and shape (morphology) information are obtained **504** and provided to a therapy decision and/or delivery block **506**. This conventional method then returns to a wait state **508** until the next R-wave detection.

The method also integrates a rate calculation using self-correlation, which can be called asynchronously (at fixed intervals, for example), or synchronously to the new detection **500**, as desired. This wait state is depicted at **510**. Upon activation, the self-correlation rate estimate is made using the combination one or more of calculating R[n], Selecting Peaks, and Tracking an RR Estimate **512**. A resulting RR Estimate is then reported at **514** to the Therapy Decision block **506**, and the wait state **510** is again entered. The RR Estimate from block **512** may be generated using the tracking tools described above or, in some examples a cardiac rate estimate may be generated directly from a peak selector that assesses a self-correlation function. Thus, tracking is expressly optional in the above examples.

The therapy decision **506** may use each of these different calculations in various approaches to identifying whether therapy is needed. For example, one of the rates may be used to double check the other, or the rates may be compared to identify a match. If the rates do not match, additional analysis may be performed using, for example, additional sensing inputs, such as a motion sensor or blood pressure or oxygenation sensor. If the rates both suggest therapy is needed (whether matching or not), therapy functions may then be called. Other approaches are noted above.

In one example, if the dominant peak test is applied and met by a dominant peak, then therapy decision **506** may be configured to treat the estimated cardiac rate associated with the dominant peak as more reliable than a rate generated using an R-wave detection from block **500**. In another example, a peak which passes the picket test may be treated in the therapy decision **506** as more reliable than a rate generated using an R-wave detection from block **500**. In yet another example, the outputs of the peak selection may be

treated as less reliable than the R-wave detection outputs until a track is declared via the methods of FIGS. 8A-8B, and then only if the peak selection output falls within a defined track.

Still other examples may have multiple analytical courses depending on the status of the R-wave detection rate, tracking and peak selection outputs. For example, the following rules may apply in various examples:

If both R-wave detection rate and Self-Correlation Rate match and are high rates, the high rate is confirmed, suggesting tachyarrhythmia

If R-wave detection suggests high rate but Self-Correlation Rate is lower, additional analysis is required (waiting time, detected event width or morphology analysis) before the high rate is treated as valid if either:

the Self-Correlation Rate is based on a rate estimate falling within a valid track (the rate estimate being either a candidate or selected peak from peak analysis); or

the Self-Correlation Rate is based on a selected peak that passes one of the picket test or the dominant peak test

If R-wave detection rate is low, but Self-Correlation Rate is high, additional analysis (waiting time, detected event width or morphology analysis) is required before the high rate is treated as valid unless the Self-Correlation Rate is within a declared track and is based on a peak that passes the picket test (whether directly or via the large tachy peak test)

In another example, tracking is omitted and the following rules may apply:

The rate calculated using R-wave detection is treated as valid if it is high and the Self-Correlation rate exceeds a tachy threshold (whether the rates match or not);

The rate calculated using R-wave detection is treated as valid if it is high and the Self-Correlation test fails to meet either the picket test or dominant peak test;

The rate calculated using the Self-Correlation test is treated as valid if it is lower than the R-wave detection rate and below the tachy threshold and either passes the picket test or passes the dominant peak test

Other combinations are also possible within the scope of the present invention.

In one example, if the Self-Correlation analysis is called periodically, and if the Self-Correlation rate is calculated with high confidence, then the Self-Correlation rate takes the place of the rate calculated using R-wave detection until the next iteration of the Self-Correlation analysis. In a system using an NID or X-out-of-Y filter, then the Self-Correlation analysis rate can be treated as occurring repeatedly during the time period where the R-wave detection is replaced. For example, if Self-Correlation determines a rate of 180 beats-per-minute, and the Self-Correlation function is called at one second intervals, the NID or X-out-of-Y filter analysis would add three events at 180 beats-per-minute during the one second interval between iterations of the Self-Correlation analysis.

The therapy decision 506 may determine whether the cardiac rate as estimated by one or both of blocks 502/512 exceeds a therapy threshold using, for example, a direct calculation of one rate, or a calculation across several iterations using one or more of an NID or X-out-of-Y filter as discussed above. The therapy decision may combine rate with morphology (shape) information gathered from the cardiac signal. In some examples, the therapy decision 506 can set two or more rate boundaries, including one or more of a shock-only boundary, in which rates above a threshold

are deemed necessitating high energy cardioversion or defibrillation shock, a VT zone in which a lower energy therapy such as anti-tachycardia pacing is applied, and a conditional zone in which additional analysis of a combination of shape elements (template matching, width, interval stability, amplitude, etc.) as well as rate is performed. The therapy decision 506 may integrate additional sensor inputs or inputs from separate devices, such as blood oxygenation, pressure, color, etc. measurements, measurements from a separate device such as a pressure monitor, leadless pacer, etc., or measurements from a position or movement sensor which can be separately provided in the patient's or integrated in a single device with the rest of the system that performs the self-correlation and other functions described above.

## VARIOUS NOTES & EXAMPLES

A first non-limiting example takes the form of an implantable medical device system configured for iterative analysis of cardiac signals comprising a plurality of electrodes (16, 18, 20, 36, 38, 40, 42) for sensing cardiac signals; self-correlation means for generating a self-correlation function from the sensed cardiac signals, the self-correlation function having amplitudes as a function of lag depth; and peak selector means for identifying amplitude peaks in the self-correlation function and finding a first estimate of cardiac rate and first affiliated confidence having ratings of at least low or high confidence. Further in the first non-limiting example, the peak selector means comprises picket test means for determining whether, for a selected peak having a first lag depth in the self-correlation function of a given iteration, at least one additional peak appears at a second lag depth that is a multiple of the first lag depth; and the peak selector means further comprises candidate selection means for selecting candidate peaks to determine suitability of the candidate peaks for calculating an estimated cardiac rate operable to: identify a quantity of candidate peaks using peaks of the self-correlation function; select as a first candidate peak one of the following: a candidate peak having the least lag depth of the identified candidate peaks, or a candidate peak having an amplitude that is larger than that of the candidate peak with the least lag depth by at least a first margin and which corresponds to a cardiac rate exceeding a rate threshold; wherein the peak selector means is configured to use the candidate selection means to identify one or more candidate peaks, and the picket test means to determine whether any candidate peaks are suitable to estimate cardiac rate and, if so, to report an estimated cardiac rate. FIG. 3 and associated text illustrate the first non-limiting example by including a self-correlation means to generate the self-correlation function, R[n], at 60, a peak selector means at 62, and tracking means with blocks 64, 66 and 68 to generate an estimated rate and confidence at 70. Another example is in FIG. 6, which illustrates the peak selector means generally including identification or finding peaks, at 150 and associated text, and performing analysis to lead to an estimate of rate in the form of an RR interval estimate at 174. The peak selector means as shown in FIG. 6 includes a candidate selection at 154, 156, 158, 160, 162 and associated text, as well as picket testing determination at 164, 166, 168 and associated text.

A second non-limiting example takes the form of an implantable medical device system as in the first non-limiting example, wherein the peak selector means further comprises dominant peak testing means for determining whether any of the candidate peaks exceeds all other peaks by at least a second margin, wherein the peak selector means

is operable to use the dominant peak testing means to attempt to identify a peak suitable to estimate cardiac rate if no candidate peak is found suitable by the picket test means. Dominant peak testing means is illustrated in FIG. 6 at 172 and associated text.

A third non-limiting example takes the form of an implantable medical device system as in the second non-limiting example, wherein, if the dominant peak testing means identifies a dominant peak that exceeds all other peaks by at least the second margin and the dominant peak corresponds to a cardiac rate that is below a dominant peak rate threshold, the peak selector means reports the cardiac rate corresponding to the dominant peak as an estimated cardiac rate.

A fourth non-limiting example takes the form of an implantable medical device system as in the third non-limiting example, further comprising: R-wave detection means for detecting cardiac events by comparison of an electrical signal from the electrodes to a threshold and thereby to generate a plurality of R-wave detections and resultant rate estimate; and decision means for taking results from each of the R-wave detection means and the tracking means and determining whether a therapy is needed; wherein the decision means is configured to accept an estimated cardiac rate reported by the peak selector means based on a dominant peak as more reliable than a rate generated by the R-wave detection means. The inclusion of R-wave detection means and decision means is illustrated in at least FIG. 19, including for example the R-wave detection 500 and decision means at 506 and associated text.

A fifth non-limiting example takes the form of an implantable medical device system as in either the first or second non-limiting examples, wherein the candidate selection means is configured to select a predetermined quantity of the largest peaks in the self-correlation function; and the peak selector means further comprises large tachycardia peak check means for determining whether a peak in the self-correlation function at a depth corresponding to a tachycardia rate is within a third margin of the largest peak in the self-correlation function and, if so, the peak selector means is configured to submit the peak identified by the large tachycardia peak check means to the picket test means to determine whether it is suitable to estimate cardiac rate.

A sixth non-limiting example takes the form of an implantable medical device system as in any of the first to third non-limiting examples, further comprising tracking means for tracking outputs of the peak selector means to generate a cardiac rate estimate therefrom.

A seventh non-limiting example takes the form of an implantable medical device system as in the sixth non-limiting example, further comprising reporting means for identifying and reporting any peak in the self-correlation function that is greater than a reporting threshold to the tracking means.

An eighth non-limiting example takes the form of an implantable medical device system as in the sixth non-limiting example, further comprising reporting means for identifying a maximum peak in the self-correlation function and reporting any peak in the self-correlation function that is greater than a threshold percentage of the maximum peak to the tracking means.

A ninth non-limiting example takes the form of an implantable medical device system as in any of the sixth to eighth non-limiting examples, further comprising: R-wave detection means for detecting cardiac events by comparison of an electrical signal from the electrodes to a threshold and thereby to generate a plurality of R-wave detections and

resultant rate estimate; and decision means for taking results from each of the R-wave detection means and the tracking means and determining whether a therapy is needed.

A tenth non-limiting example takes the form of an implantable medical device system as in any of the first to third non-limiting examples, further comprising: R-wave detection means for detecting cardiac events by comparison of an electrical signal from the electrodes to a threshold and thereby to generate a plurality of R-wave detections and resultant rate estimate; and decision means for taking results from each of the R-wave detection means and the peak selector means and determining whether a therapy is needed.

An eleventh non-limiting example takes the form of an implantable medical device system as in the tenth non-limiting example, wherein the decision means is configured to treat a result from the peak selector means as more reliable than a result from the R-wave detection means if a rate estimate reported by the peak selector means is based on a candidate peak identified by the picket test means as suitable to estimate cardiac rate.

A twelfth non-limiting example takes the form of an implantable medical device system as in any of the first to eleventh non-limiting examples, wherein the rate threshold is set at 75 beats per minute.

A thirteenth non-limiting example takes the form of an implantable medical device system as in any of the first to twelfth non-limiting examples, wherein the self-correlation means generates the self-correlation function having a series of output samples  $\{1 \dots N\}$ , wherein the picket test means is configured to identify whether there are at least two pickets for a candidate peak having a lag depth of less than  $N/3$ , and at least one picket for a candidate peak having a lag depth greater than  $N/3$  and less than  $N/2$ .

A fourteenth non-limiting example takes the form of an implantable medical device system as in any of the first to thirteenth non-limiting examples wherein the peak selector means is configured to determine whether there are any peaks in the self-correlation function greater than a tachy threshold located within a lag depth of less than a tachy lag threshold and, if so, to set a flag for possible tachyarrhythmia.

A fifteenth non-limiting example takes the form of an implantable medical device system as in any of the first to fourteenth non-limiting examples, wherein the implantable medical device system comprises a canister housing operational circuitry including at least the self-correlation means and peak selector means, and a lead system including at least some of the plurality of electrodes.

A sixteenth non-limiting example takes the form of a method of analyzing cardiac signals in an implantable medical device having a plurality of electrodes for sensing cardiac signals coupled to operational circuitry for at least performing analysis of sensed cardiac signals, the method comprising: generating a self-correlation function from the sensed cardiac signals, the self-correlation function having amplitudes as a function of lag depth; and identifying amplitude peaks in the self-correlation function and finding a first estimate of cardiac rate: identifying one or more candidate amplitude peaks each having lag depths; selecting a first candidate peak having a first lag depth by choosing either: a candidate peak having the least lag depth of the identified candidate peaks, or a candidate peak having an amplitude that is larger than that of the candidate peak with the least lag depth by at least a first margin and which corresponds to a cardiac rate exceeding a rate threshold; applying a picket test to the first candidate peak by determining whether at least one additional peak appears at a

second lag depth that is a multiple of the lag depth of the first candidate peak and, if so, finding that the picket test is passed for the first candidate peak.

A seventeenth non-limiting example takes the form of a method of analyzing cardiac signals as in the sixteenth non-limiting example, wherein the first estimate of cardiac rate is generated by converting the first lag depth to a time interval and converting the time interval into a rate in response to finding that the picket test was passed by the first candidate peak.

An eighteenth non-limiting example takes the form of a method of analyzing cardiac signals as in the sixteenth non-limiting example, further comprising: finding that the picket test was not passed for the first candidate peak; selecting a second candidate peak; and applying the picket test to the second candidate peak.

A nineteenth non-limiting example takes the form of a method of analyzing cardiac signals as in the sixteenth non-limiting example, further comprising: finding that the picket test was not passed for at least the first candidate peak; identifying a largest peak in the self-correlation function; assessing whether the largest peak is larger than any other peak in the self-correlation function by at least a threshold amount; finding that the largest peak is larger than any other peak by at least the threshold amount; and using the lag depth of the largest peak to calculate a first estimate of cardiac rate.

A twentieth non-limiting example takes the form of a method of analyzing cardiac signals as in the sixteenth non-limiting example, further comprising: finding that the picket test was passed for the first candidate peak; checking whether the self-correlation function includes a non-candidate peak having a lag depth less than that of the first candidate peak and an amplitude within a threshold of the first candidate peak; and if so, determining whether the non-candidate peak passes the picket test.

A twenty-first non-limiting example takes the form of a method of analyzing cardiac signals as in any of the sixteenth to twentieth non-limiting examples, further comprising: performing R-wave detection on the sensed cardiac signals to generate a plurality of R-wave detections; calculating a second estimate of cardiac rate using the R-wave detections; and analyzing the first and second estimates of cardiac rate to determine whether a therapy is needed.

A twenty-second non-limiting example takes the form of a method of analyzing cardiac signals as in any of the sixteenth to twenty-first non-limiting examples further comprising tracking the first estimate of cardiac rate over time to establish confidence measures if the first estimate of cardiac rate is consistent over either a period of time or a series of calculations.

A twenty-third non-limiting example takes the form of a method of analyzing cardiac signals as in any of the sixteenth to twenty-second non-limiting examples, further comprising generating a confidence in affiliation with the first estimate of cardiac rate as follows: analyzing a largest peak in the self-correlation function to determine whether it is a dominant peak, if the picket test is not passed by at least the first candidate peak; analyzing whether a non-candidate peak having an amplitude within similarity bounds of the first candidate peak and a lag depth less than that of the first candidate peak and associated with a heart rate above a tachy threshold appears in the self-correlation function and, if so, determining whether the non-candidate peak passes the picket test; and generating the confidence affiliated with the first estimate of cardiac rate as follows: if a candidate peak or non-candidate peak passes the picket test with at least two

pickets, placing high confidence with the first estimate of cardiac rate; if a dominant peak is found or if a candidate peak or non-candidate peak passes the picket test with only one picket, placing medium confidence with the first estimate of cardiac rate; or if neither a dominant peak nor a peak passing the picket test is found, reporting an estimated cardiac rate based on the largest peak in the self-correlation function and placing low confidence in the first estimate of cardiac rate; wherein a peak passing the picket test with two peaks means that there are at least first and second additional peaks at multiples of the lag depth of the peak under analysis in the picket test.

A twenty-fourth non-limiting example takes the form of a method of analyzing cardiac signals as in the twenty-third non-limiting example, further comprising: performing R-wave detection on the sensed cardiac signals to generate a plurality of R-wave detections; calculating a second estimate of cardiac rate using the R-wave detections; and analyzing the first and second estimates of cardiac rate to determine whether a therapy is needed by: treating the first estimate of cardiac rate as more reliable than the second estimate of cardiac rate if the first estimate comes with high confidence; and treating the second estimate of cardiac rate as more reliable than the first estimate of cardiac rate if the first estimate comes with low confidence.

A twenty-fifth non-limiting example takes the form of an implantable cardiac device comprising: an implantable canister housing operational circuitry for performing cardiac signal analysis; and a plurality of electrodes coupled to the operational circuitry to provide cardiac signals thereto; wherein the operational circuitry is configured to perform a method of cardiac signal analysis as in any of the sixteenth to twenty-fourth non-limiting examples.

Any of the first to twenty-fifth non-limiting examples may further include a Bigemini identification means or step and/or a jitter identification means or step. Examples of Bigemini identification are shown in FIG. 16 and associated text. Additionally, examples of jitter identification are shown in FIG. 17 and associated text.

Each of these non-limiting examples can stand on its own, or can be combined in various permutations or combinations with one or more of the other examples.

The above detailed description includes references to the accompanying drawings, which form a part of the detailed description. The drawings show, by way of illustration, specific embodiments in which the invention can be practiced. These embodiments are also referred to herein as "examples." Such examples can include elements in addition to those shown or described. However, the present inventors also contemplate examples in which only those elements shown or described are provided. Moreover, the present inventors also contemplate examples using any combination or permutation of those elements shown or described (or one or more aspects thereof), either with respect to a particular example (or one or more aspects thereof), or with respect to other examples (or one or more aspects thereof) shown or described herein.

In the event of inconsistent usages between this document and any documents so incorporated by reference, the usage in this document controls.

In this document, the terms "a" or "an" are used, as is common in patent documents, to include one or more than one, independent of any other instances or usages of "at least one" or "one or more." In this document, the term "or" is used to refer to a nonexclusive or, such that "A or B" includes "A but not B," "B but not A," and "A and B," unless otherwise indicated. In this document, the terms "including"

and “in which” are used as the plain-English equivalents of the respective terms “comprising” and “wherein.” Also, in the following claims, the terms “including” and “comprising” are open-ended, that is, a system, device, article, composition, formulation, or process that includes elements in addition to those listed after such a term in a claim are still deemed to fall within the scope of that claim. Moreover, in the following claims, the terms “first,” “second,” and “third,” etc. are used merely as labels, and are not intended to impose numerical requirements on their objects.

Method examples described herein can be machine or computer-implemented at least in part. Some examples can include a computer-readable medium or machine-readable medium encoded with instructions operable to configure an electronic device to perform methods as described in the above examples. An implementation of such methods can include code, such as microcode, assembly language code, a higher-level language code, or the like. Such code can include computer readable instructions for performing various methods. The code may form portions of computer program products. Further, in an example, the code can be tangibly stored on one or more volatile, non-transitory, or non-volatile tangible computer-readable media, such as during execution or at other times. Examples of these tangible computer-readable media can include, but are not limited to, hard disks, removable magnetic disks, removable optical disks (e.g., compact disks and digital video disks), magnetic cassettes, memory cards or sticks, random access memories (RAMs), read only memories (ROMs), and the like.

The above description is intended to be illustrative, and not restrictive. For example, the above-described examples (or one or more aspects thereof) may be used in combination with each other. Other embodiments can be used, such as by one of ordinary skill in the art upon reviewing the above description. The Abstract is provided to comply with 37 C.F.R. § 1.72(b), to allow the reader to quickly ascertain the nature of the technical disclosure. It is submitted with the understanding that it will not be used to interpret or limit the scope or meaning of the claims.

Also, in the above Detailed Description, various features may be grouped together to streamline the disclosure. This should not be interpreted as intending that an unclaimed disclosed feature is essential to any claim. Rather, inventive subject matter may lie in less than all features of a particular disclosed embodiment. Thus, the following claims are hereby incorporated into the Detailed Description as examples or embodiments, with each claim standing on its own as a separate embodiment, and it is contemplated that such embodiments can be combined with each other in various combinations or permutations. The scope of the invention should be determined with reference to the appended claims, along with the full scope of equivalents to which such claims are entitled.

The claimed invention is:

1. A method of analyzing cardiac signals in a medical device having a plurality of electrodes for sensing cardiac signals coupled to operational circuitry for at least performing analysis of sensed cardiac signals, the method comprising:

- generating a self-correlation function from the sensed cardiac signals, the self-correlation function having amplitudes as a function of lag depth; and
- identifying amplitude peaks in the self-correlation function and finding a first estimate of cardiac rate by:
  - identifying one or more candidate amplitude peaks each having lag depths;

selecting a candidate peak having the least lag depth of the identified candidate amplitude peaks as a first candidate peak; and

applying a picket test to the first candidate peak by determining whether at least one additional peak appears at a second lag depth that is a multiple of the lag depth of the first candidate peak and, if so, finding that the picket test is passed for the first candidate peak;

wherein the first estimate of cardiac rate is generated by converting the first lag depth to a time interval and converting the time interval into a rate in response to finding that the picket test was passed by the first candidate peak.

2. The method of claim 1 further comprising: finding that the picket test was not passed for the first candidate peak;

selecting a second candidate peak; and applying the picket test to the second candidate peak.

3. The method of claim 1 further comprising: finding that the picket test was not passed for at least the first candidate peak;

identifying a largest peak in the self-correlation function; assessing whether the largest peak is larger than any other peak in the self-correlation function by at least a threshold amount;

finding that the largest peak is larger than any other peak by at least the threshold amount; and using the lag depth of the largest peak to calculate a the first estimate of cardiac rate.

4. The method of claim 1 further comprising: finding that the picket test was passed for the first candidate peak;

determining that self-correlation function includes a non-candidate peak having a lag depth less than that of the first candidate peak and an amplitude within a threshold of the first candidate peak;

determining that the non-candidate peak passes the picket test; and

calculating a cardiac rate using a lag depth of the non-candidate peak.

5. The method of claim 1 further comprising: performing R-wave detection on the sensed cardiac signals to generate a plurality of R-wave detections;

calculating a second estimate of cardiac rate using the R-wave detections; and

analyzing the first and second estimates of cardiac rate to determine whether a therapy is needed.

6. The method of claim 1 further comprising tracking the first estimate of cardiac rate over time to establish confidence measures if the first estimate of cardiac rate is consistent over either a period of time or a series of calculations.

7. The method of claim 1 further comprising generating a confidence in affiliation with the first estimate of cardiac rate as follows:

- analyzing a largest peak in the self-correlation function to determine whether it is a dominant peak, if the picket test is not passed by at least the first candidate peak and, if the largest peak is a dominant peak, calculating the first estimate of cardiac rate using a lag depth of the dominant peak;

- analyzing whether a non-candidate peak having an amplitude within similarity bounds of the first candidate peak and a lag depth less than that of the first candidate peak and associated with a heart rate above a tachy threshold appears in the self-correlation function and, if so,

determining whether the non-candidate peak passes the picket test and, if the non-candidate peak passes the picket test, calculating the first estimate of cardiac rate using a lag depth of the non-candidate peak; and generating the confidence affiliated with the first estimate of cardiac rate as follows:

if a candidate peak or non-candidate peak passes the picket test with at least two pickets, placing high confidence with the first estimate of cardiac rate;

if a dominant peak is found or if a candidate peak or non-candidate peak passes the picket test with only one picket, placing medium confidence with the first estimate of cardiac rate; or

if neither a dominant peak nor a peak passing the picket test is found, reporting an estimated cardiac rate based on the largest peak in the self-correlation function and placing low confidence in the first estimate of cardiac rate;

wherein a peak passing the picket test with two peaks means that there are at least first and second additional peaks at integer multiples of the lag depth of the peak under analysis in the picket test.

8. The method of claim 7 further comprising:

performing R-wave detection on the sensed cardiac signals to generate a plurality of R-wave detections; calculating a second estimate of cardiac rate using the R-wave detections; and

analyzing the first and second estimates of cardiac rate to determine whether a therapy is needed by:

treating the first estimate of cardiac rate as more reliable than the second estimate of cardiac rate if the first estimate comes with high confidence; and treating the second estimate of cardiac rate as more reliable than the first estimate of cardiac rate if the first estimate comes with low confidence.

9. The method of claim 1 further comprising checking for a pattern of peaks in the self-correlation function consistent with Bigemini and, if so, replacing the first candidate peak with a peak consistent with Bigemini.

10. The method of claim 1 further comprising checking for a pattern of peaks in the self-correlation function consistent with jitter and, if so, replacing the first candidate peak with a peak consistent with jitter.

11. A cardiac monitoring or therapy device comprising:

a canister housing operational circuitry for performing cardiac signal analysis; and

a plurality of electrodes coupled to the operational circuitry to provide cardiac signals thereto;

wherein the operational circuitry is configured to perform a method of cardiac signal analysis comprising:

generating a self-correlation function from the sensed cardiac signals, the self-correlation function having amplitudes as a function of lag depth; and

identifying amplitude peaks in the self-correlation function and finding a first estimate of cardiac rate by:

identifying one or more candidate amplitude peaks each having lag depths;

selecting a first candidate peak having a first lag depth by choosing a candidate amplitude peak having the least lag depth of the identified candidate amplitude peaks; and

applying a picket test to the first candidate peak by determining whether at least one additional peak appears at a second lag depth that is a multiple of the lag depth of the first candidate peak and, if so, finding that the picket test is passed for the first candidate peak;

wherein the operational circuitry is further configured such that the first estimate of cardiac rate is generated by converting the first lag depth to a time interval and converting the time interval into a rate in response to finding that the picket test was passed by the first candidate peak.

12. The cardiac monitoring or therapy device of claim 11 wherein the operational circuitry is further configured for: finding that the picket test was not passed for at least the first candidate peak;

identifying a largest peak in the self-correlation function; assessing whether the largest peak is larger than any other peak in the self-correlation function by at least a threshold amount;

finding that the largest peak is larger than any other peak by at least the threshold amount; and using the lag depth of the largest peak to calculate a the first estimate of cardiac rate.

13. The cardiac monitoring or therapy device of claim 11 wherein the operational circuitry is further configured for: performing R-wave detection on the sensed cardiac signals to generate a plurality of R-wave detections; calculating a second estimate of cardiac rate using the R-wave detections; and analyzing the first and second estimates of cardiac rate to determine whether a therapy is needed.

14. The cardiac monitoring or therapy device of claim 11 wherein the operational circuitry is further configured for tracking the first estimate of cardiac rate over time to establish confidence measures if the first estimate of cardiac rate is consistent over either a period of time or a series of calculations.

15. The cardiac monitoring or therapy device of claim 11 wherein the operational circuitry is further configured for checking for a pattern of peaks in the self-correlation function consistent with Bigemini and, if so, replacing the first candidate peak with a peak consistent with Bigemini.

16. The cardiac monitoring or therapy device of claim 11 wherein the operational circuitry is further configured for checking for a pattern of peaks in the self-correlation function consistent with jitter and, if so, replacing the first candidate peak with a peak consistent with jitter.

17. A medical device comprising sensing electrodes for obtaining cardiac signals, sensing circuitry for analyzing obtained cardiac signals, and a processor and a non-transitory medium with instructions contained therein for implementation by the processor, the processor configured to operate on the instructions to use the sensing circuitry as follows:

generating a self-correlation function from the sensed cardiac signals, the self-correlation function having amplitudes as a function of lag depth; and

identifying amplitude peaks in the self-correlation function and finding a first estimate of cardiac rate by:

identifying one or more candidate amplitude peaks each having lag depths;

selecting a first candidate peak having a first lag depth by choosing a candidate amplitude peak having the least lag depth of the identified candidate amplitude peaks;

applying a picket test to the first candidate peak by determining whether at least one additional peak appears at a second lag depth that is a multiple of the lag depth of the first candidate peak and, if so, finding that the picket test is passed for the first candidate peak; and

converting the first lag depth to a time interval and  
 converting the time interval into a rate that serves as  
 the first estimate of cardiac rate in response to  
 finding that the picket test was passed by the first  
 candidate peak. 5

**18.** The medical device of claim **17** wherein the processor  
 is configured to operate on the instructions to further use the  
 sensing circuitry as follows:

performing R-wave detection on the sensed cardiac sig-  
 nals to generate a plurality of R-wave detections; 10  
 calculating a second estimate of cardiac rate using the  
 R-wave detections; and  
 analyzing the first and second estimates of cardiac rate to  
 determine whether an arrhythmia is occurring.

**19.** The medical device of claim **17** wherein the processor 15  
 is configured to operate on the instructions to find the first  
 estimate of cardiac rate by:

finding that the picket test was not passed for the first  
 candidate peak;  
 selecting a second candidate peak; and 20  
 applying the picket test to the second candidate peak.

**20.** The medical device of claim **17** wherein the processor  
 is configured to operate on the instructions to track the first  
 estimate of cardiac rate over time to establish confidence  
 measures if the first estimate of cardiac rate is consistent 25  
 over either a period of time or a series of calculations.

\* \* \* \* \*

专利名称(译)	用于植入式医疗设备中心率的自相关分析的峰值选择		
公开(公告)号	<a href="#">US10016143</a>	公开(公告)日	2018-07-10
申请号	US15/482004	申请日	2017-04-07
[标]申请(专利权)人(译)	卡梅伦保健公司		
申请(专利权)人(译)	CAMERON HEALTH, INC.		
当前申请(专利权)人(译)	CAMERON HEALTH, INC.		
[标]发明人	SIEJKO KRZYSZTOF Z		
发明人	SIEJKO, KRZYSZTOF Z.		
IPC分类号	A61B5/04 A61B5/042 A61B5/0456 A61B5/0464 A61N1/39 A61B5/0245 A61B5/0452 A61B5/00 G06F17/11 G16H10/60 G06F19/00		
CPC分类号	A61B5/04012 A61B5/0245 A61B5/0422 A61B5/0456 A61B5/0464 A61B5/4836 A61B5/686 A61N1/3925 A61N1/3956 A61N1/3987 G06F17/11 A61B5/04525 G16H40/67 G16H10/60 A61B5/04011 A61B5/04014 A61B5/046 A61B5/7246 A61N1/3704 G06F17/16 G06F19/3418 G16H20/30		
优先权	62/038440 2014-08-18 US 62/038438 2014-08-18 US 62/038437 2014-08-18 US		
其他公开文献	US20170209063A1		
外部链接	<a href="#">Espacenet</a>		

摘要(译)

描述了自相关增强和实现。特别地，某些示例示出了使用峰值选择器来识别自相关函数的峰值，其用作可植入医疗设备的候选心率。该方法可以使可植入医疗设备中的心率的替代计算成为独立的速率检测器或者作为其他速率计算的双重检查。

