



US 20170055847A1

(19) **United States**

(12) **Patent Application Publication**
Kiani et al.

(10) **Pub. No.: US 2017/0055847 A1**
(43) **Pub. Date: Mar. 2, 2017**

(54) **OPTICAL-BASED PHYSIOLOGICAL MONITORING SYSTEM**

A61B 5/1455 (2006.01)

A61B 5/0402 (2006.01)

A61B 5/0476 (2006.01)

(71) Applicant: **Masimo Corporation**, Irvine, CA (US)

(72) Inventors: **Massi Joe E. Kiani**, Laguna Niguel, CA (US); **Michael O'Reilly**, Dana Point, CA (US)

(52) **U.S. Cl.**

CPC *A61B 5/0205* (2013.01); *A61B 5/0402* (2013.01); *A61B 5/0476* (2013.01); *A61B 5/1455* (2013.01); *A61B 5/4821* (2013.01); *A61B 5/4839* (2013.01); *A61B 5/7278* (2013.01); *A61B 5/7282* (2013.01); *A61B 5/743* (2013.01); *A61B 5/021* (2013.01)

(21) Appl. No.: **15/347,190**

(22) Filed: **Nov. 9, 2016**

Related U.S. Application Data

(63) Continuation of application No. 14/479,083, filed on Sep. 5, 2014, now Pat. No. 9,517,024, which is a continuation of application No. 12/885,430, filed on Sep. 17, 2010, now abandoned.

(60) Provisional application No. 61/243,161, filed on Sep. 17, 2009.

(57)

ABSTRACT

A non-invasive, optical-based physiological monitoring system is disclosed. In an embodiment, the non-invasive, optical-based physiological monitoring system comprises an emitter configured to emit light into a tissue site of a living patient; a detector configured to detect the emitted light after attenuation by the tissue site and output a sensor signal responsive to the detected light; and a processor configured determine, based on the sensor signal, a first physiological parameter indicative of a level of pain of the patient.

Publication Classification

(51) **Int. Cl.**

A61B 5/0205 (2006.01)

A61B 5/00 (2006.01)

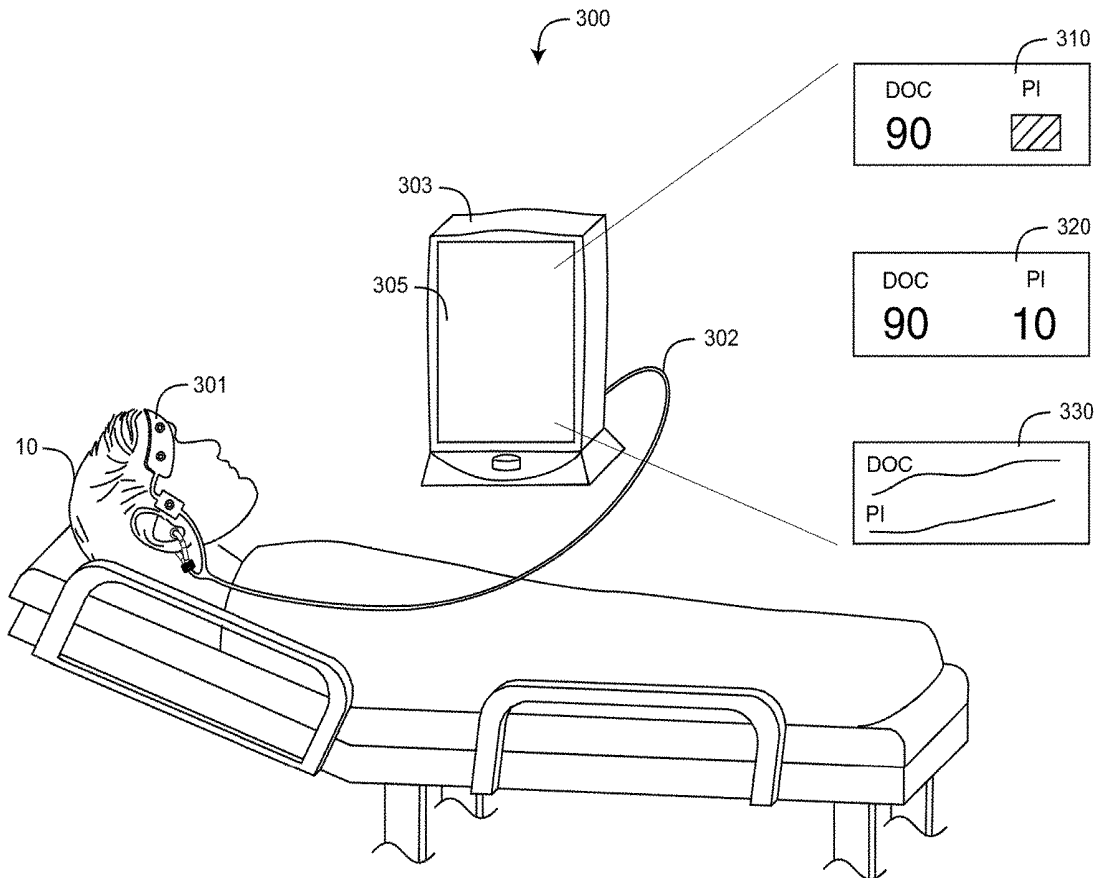

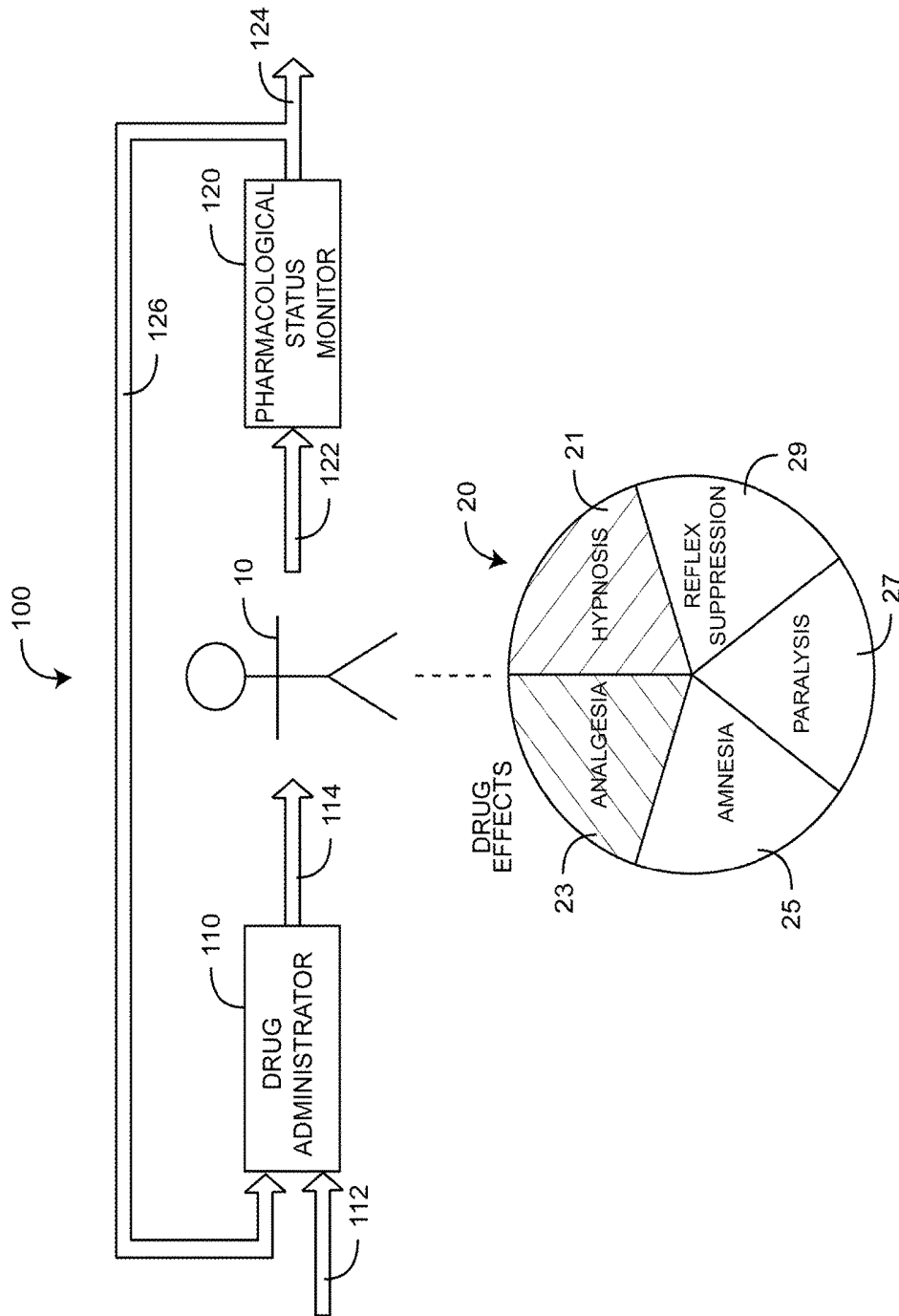

FIG. 1

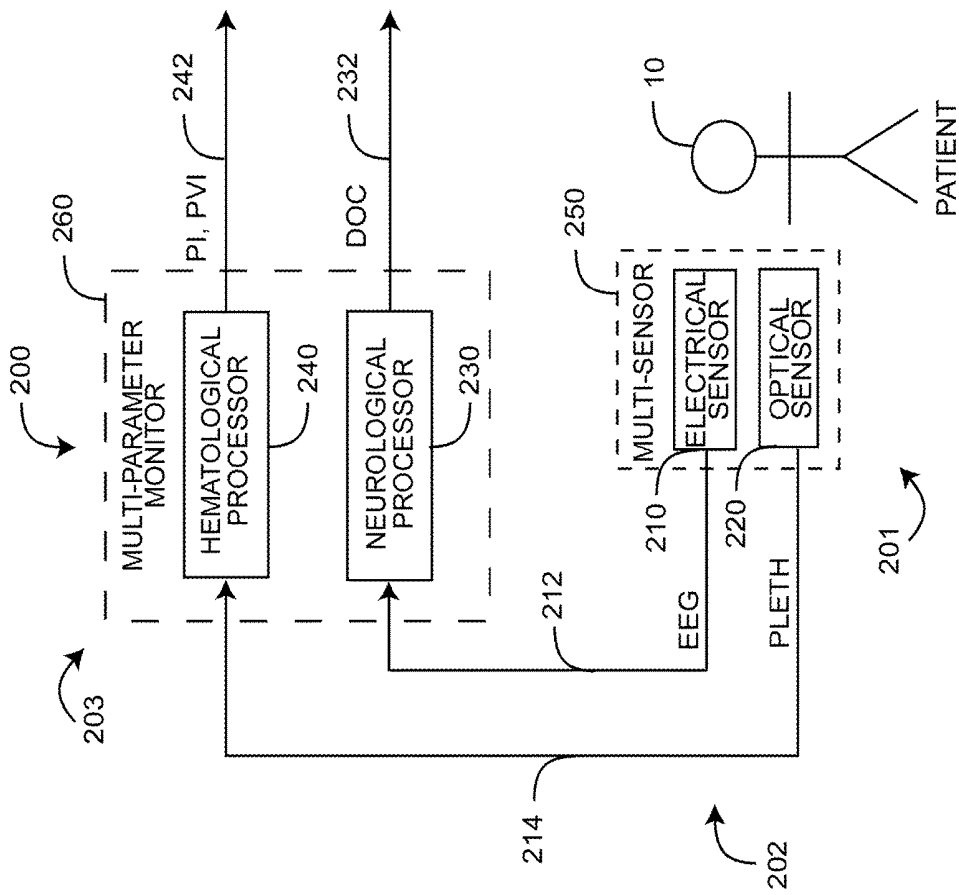

FIG. 2

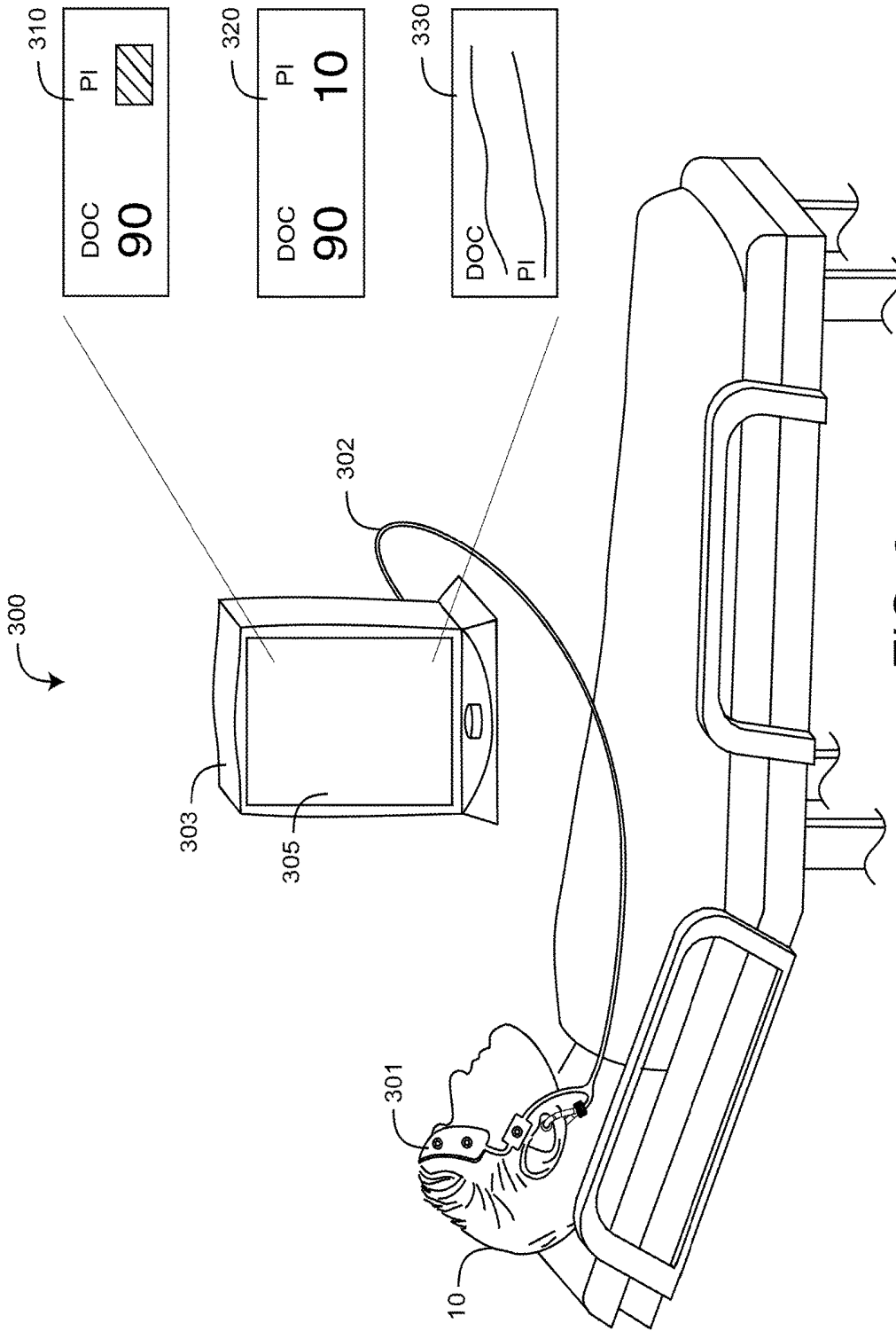

FIG. 3

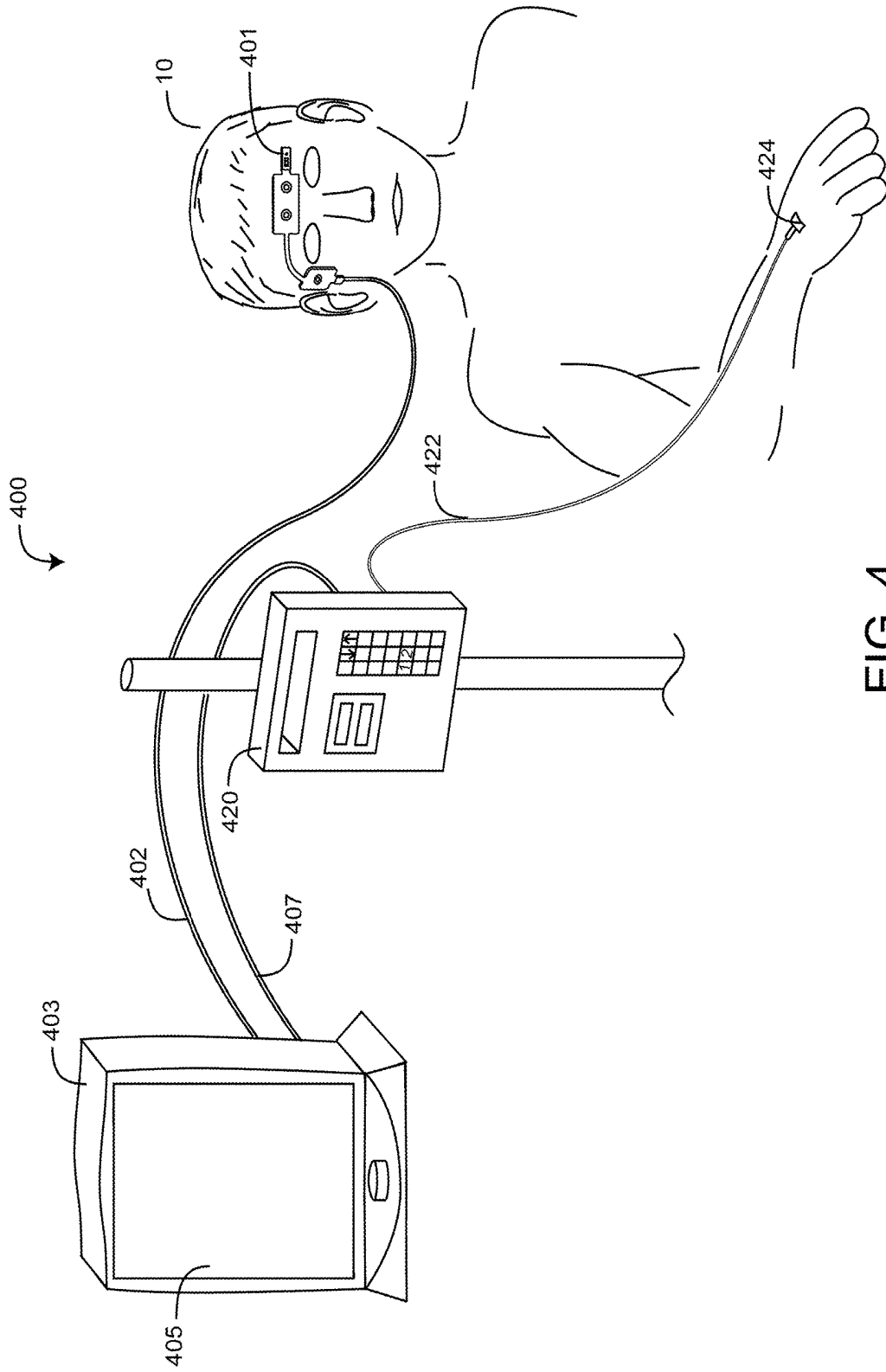

FIG. 4

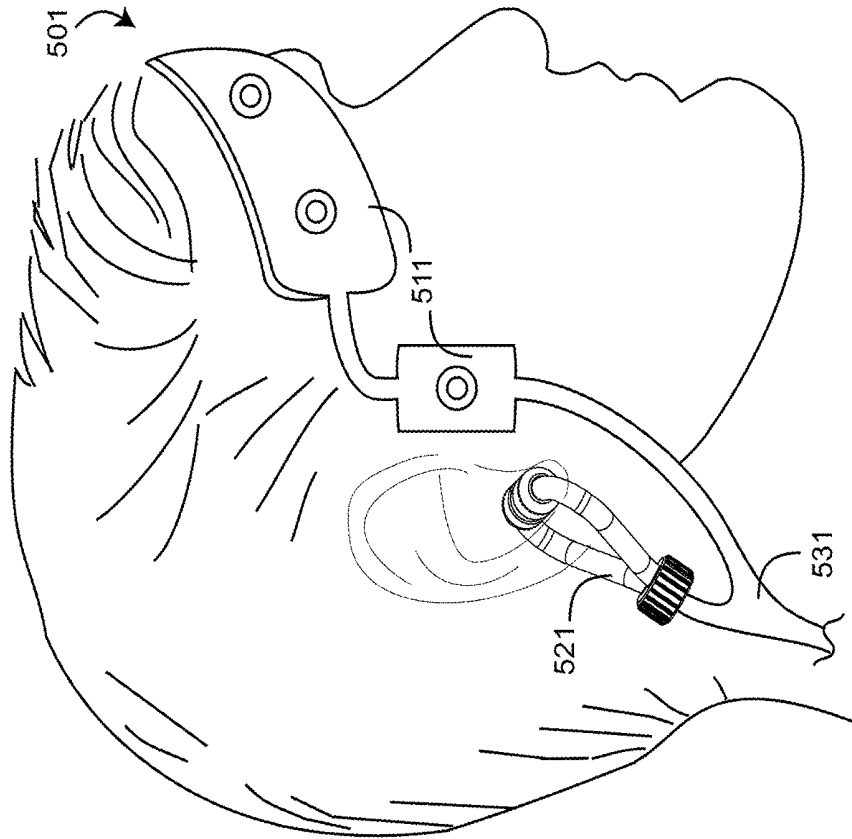

FIG. 5A

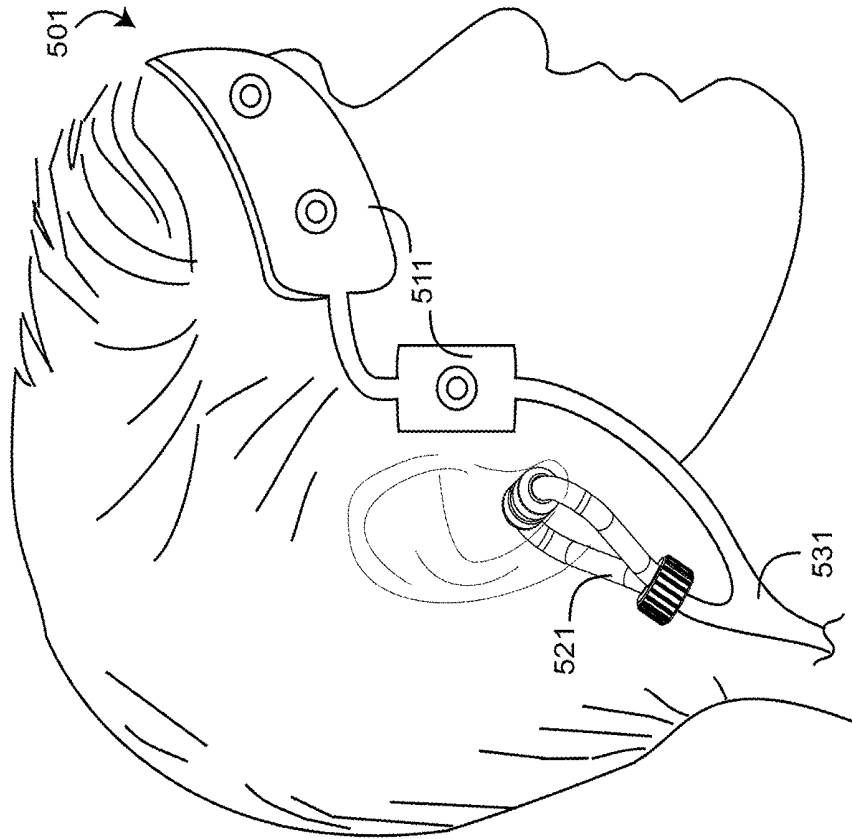

FIG. 5B

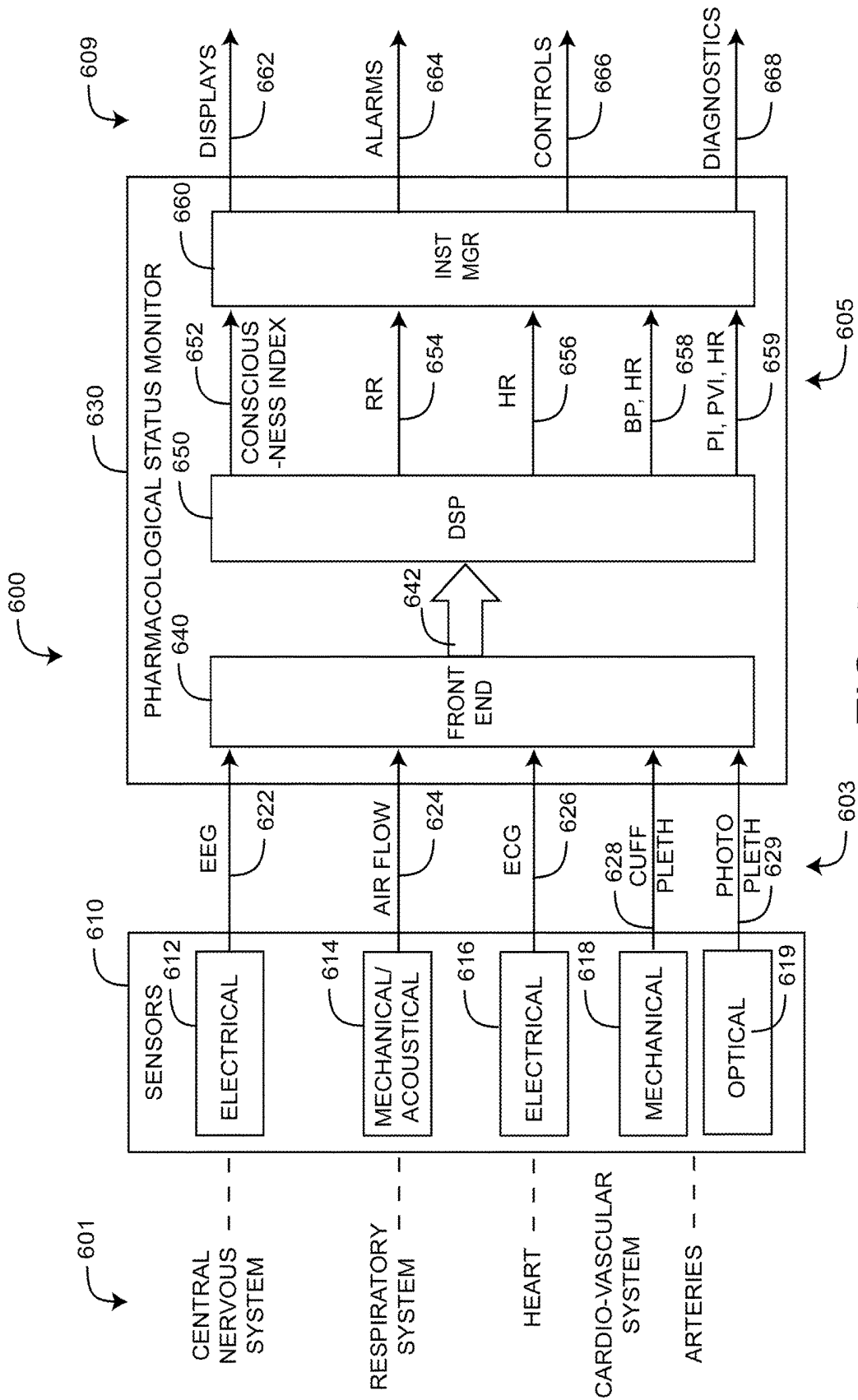

FIG. 6

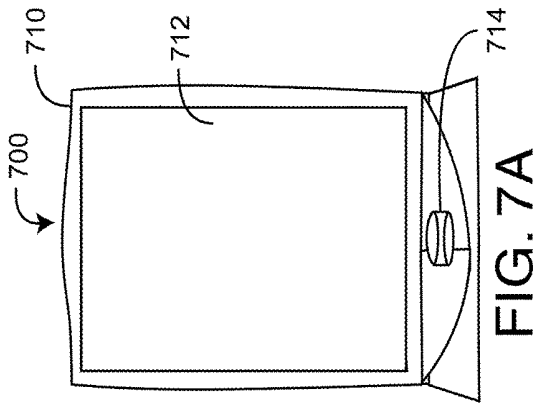

FIG. 7B

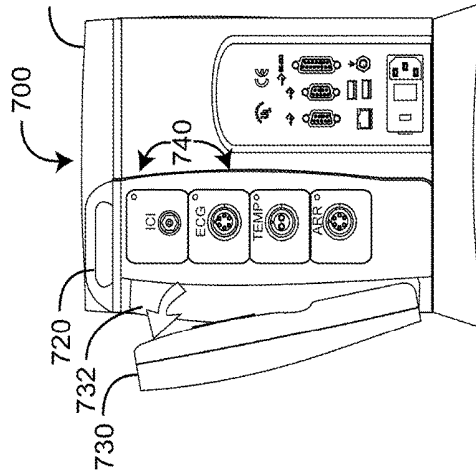
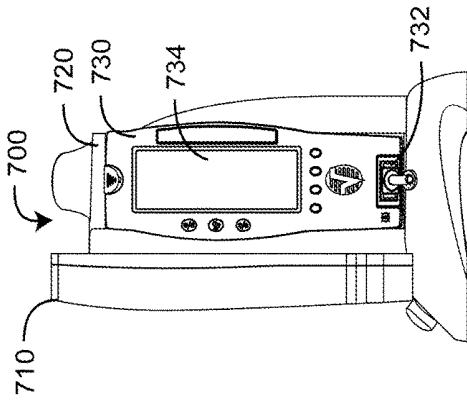

FIG. 7D

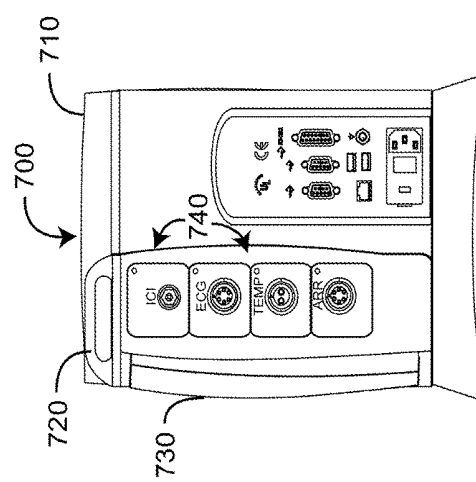

FIG. 7C

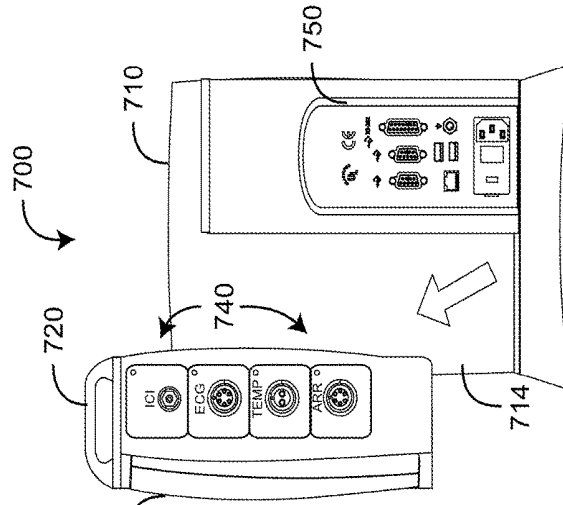

FIG. 7E

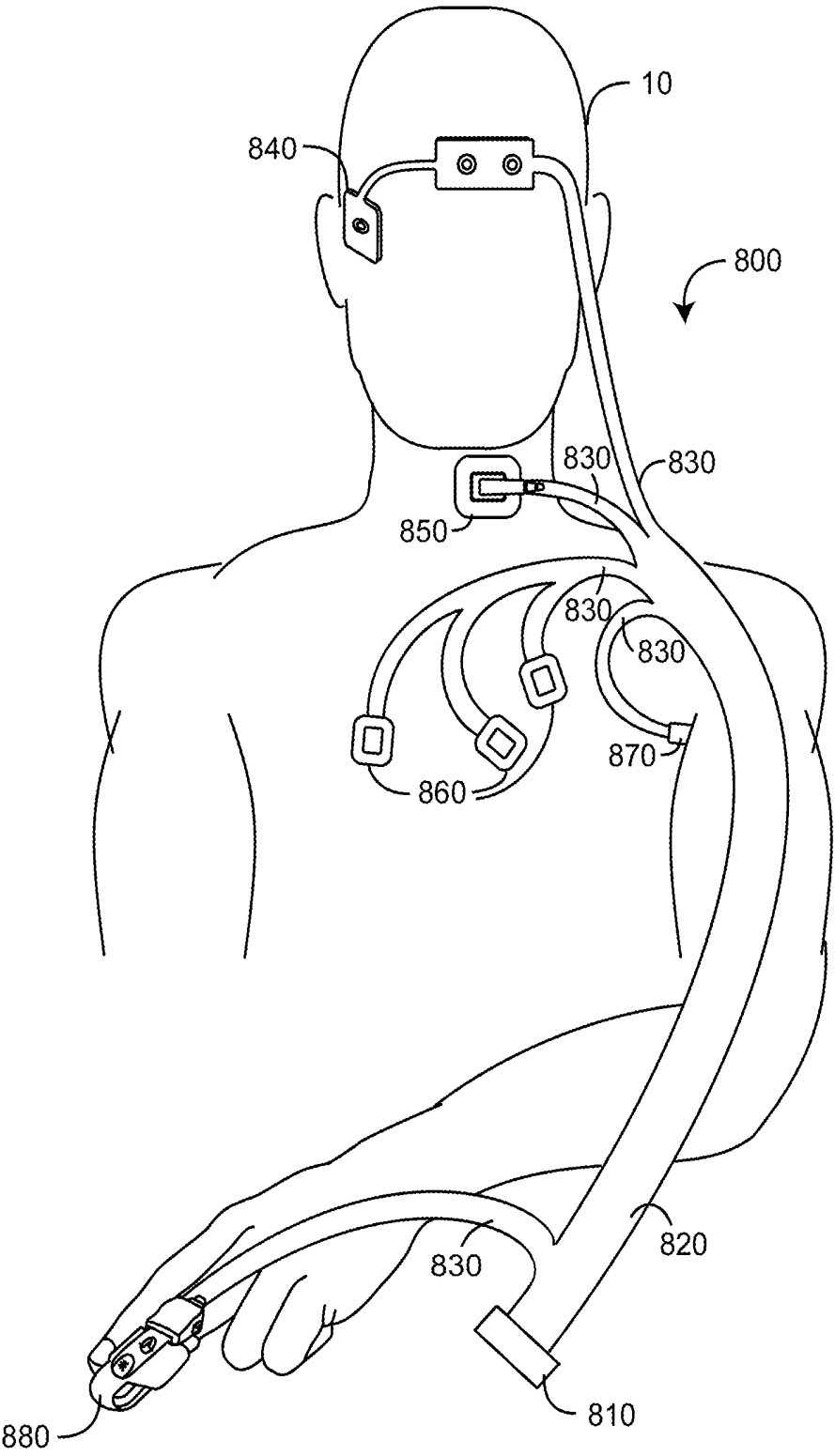

FIG. 8

OPTICAL-BASED PHYSIOLOGICAL MONITORING SYSTEM

CROSS-REFERENCE TO RELATED APPLICATIONS

[0001] Any and all applications for which a foreign or domestic priority claim is identified in the Application Data Sheet as filed with the present application are hereby incorporated by reference under 37 CFR 1.57.

[0002] This application is a continuation of U.S. patent application Ser. No. 14/479,083, filed Sep. 5, 2014, and titled "Optical-Based Physiological Monitoring System," which is a continuation of U.S. patent application Ser. No. 12/885,430, filed Sep. 17, 2010, and titled "Pharmacological Management System," which claims priority benefit under 35 U.S.C. §119(e) to U.S. Provisional Patent Application No. 61/243,161, filed Sep. 17, 2009, and titled "Pharmacological Management System." The entire disclosure of each of the above items is hereby made part of this specification as if set forth fully herein and incorporated by reference for all purposes, for all that it contains.

BACKGROUND

[0003] Generation and analysis of an electroencephalogram (EEG) is a widely accepted noninvasive procedure for diagnosing a person's neurological system. For example, an EEG can reflect changes in a brain's cellular function due to insufficient oxygen or drugs, to name a few. An EEG system consists of a bio-potential sensor and corresponding monitor to process, analyze and display an EEG signal and corresponding neurological parameters. A bio-potential sensor responds to the electrical potential difference between at least two well-spaced electrodes, using a separate ground electrode. The biopotential monitor typically displays the EEG waveform and a numerical index that reflects changes in the EEG bandwidth and power.

[0004] Generation and analysis of a photoplethysmograph is a widely accepted noninvasive procedure for diagnosing a person's cardiovascular system. For example, a photoplethysmograph can yield the oxygen saturation level of arterial blood, an indicator of a person's oxygen supply. A pulse oximetry system consists of an optical sensor applied to a fleshy tissue site, such as a fingertip, and a corresponding pulse oximetry monitor (pulse oximeter). Using multiple wavelength light emitting diodes and a corresponding detector, the optical sensor measures the light absorption of the pulsatile blood at the tissue site. In particular, the optical sensor is responsive to the instantaneous blood volume as well as the blood constituency. Accordingly, the pulse oximeter typically displays a numerical readout of a person's oxygen saturation and pulse rate along with an audible indication of the person's pulse. The photoplethysmograph waveform may also be displayed.

[0005] Conventional pulse oximetry assumes that arterial blood is the only pulsatile blood flow in the measurement site. During patient motion, venous blood also moves, which causes errors in conventional pulse oximetry. Advanced pulse oximetry processes the venous blood signal so as to report true arterial oxygen saturation and pulse rate under conditions of patient movement. Advanced pulse oximetry also functions under conditions of low perfusion (small signal amplitude), intense ambient light (artificial or sun-

light) and electrosurgical instrument interference, which are scenarios where conventional pulse oximetry tends to fail.

[0006] Advanced pulse oximetry is described in at least U.S. Pat. Nos. 6,770,028; 6,658,276; 6,157,850; 6,002,952; 5,769,785 and 5,758,644, which are assigned to Masimo Corporation ("Masimo") of Irvine, Calif. and are incorporated by reference herein. Corresponding low noise optical sensors are disclosed in at least U.S. Pat. Nos. 6,985,764; 6,813,511; 6,792,300; 6,256,523; 6,088,607; 5,782,757 and 5,638,818, which are also assigned to Masimo and are also incorporated by reference herein. Advanced pulse oximetry systems including Masimo SET® low noise optical sensors and read through motion pulse oximetry monitors for measuring SpO₂, pulse rate (PR) and perfusion index (PI) are available from Masimo. Optical sensors include any of Masimo LNOP®, LNCS®, SofTouch™ and Blue™ adhesive or reusable sensors. Pulse oximetry monitors include any of Masimo Rad-8®, Rad-5®, Rad®-5v or SatShare® monitors.

[0007] Advanced blood parameter measurement systems are described in at least U.S. Pat. No. 7,647,083, filed Mar. 1, 2006, titled Multiple Wavelength Sensor Equalization; U.S. Pat. No. 7,729,733, filed Mar. 1, 2006, titled Configurable Physiological Measurement System; U.S. Pat. Pub. No. 2006/0211925, filed Mar. 1, 2006, titled Physiological Parameter Confidence Measure and U.S. Pat. Pub. No. 2006/0238358, filed Mar. 1, 2006, titled Noninvasive Multi-Parameter Patient Monitor, all assigned to Masimo Laboratories, Irvine, Calif. (Masimo Labs) and all incorporated by reference herein. Advanced blood parameter measurement systems include Masimo Rainbow® SET, which provides measurements in addition to SpO₂, such as total hemoglobin (SpHb™), oxygen content (SpOC™) methemoglobin (SpMet®), carboxyhemoglobin (SpCO®) and PVI®. Advanced blood parameter sensors include Masimo Rainbow® adhesive, ReSposable™ and reusable sensors. Advanced blood parameter monitors include Masimo Radical-7™, Rad87™ and Rad57™ monitors, all available from Masimo. Such advanced pulse oximeters, low noise sensors and advanced blood parameter systems have gained rapid acceptance in a wide variety of medical applications, including surgical wards, intensive care and neonatal units, general wards, home care, physical training, and virtually all types of monitoring scenarios.

SUMMARY

[0008] Depth of consciousness (DOC) is an important physiological assessment during the administration of anesthesia and analgesia drugs. For example, an overdose of anesthesia risks physical impairment or death. An underdose of anesthesia risks "surgical awareness." A DOC index is typically derived by an EEG sensor measurement of electrical activity in the cerebral cortex. Advantageously, the measurement of various cardio-vascular system and respiratory system responses can substitute for or supplement typical central nervous system measures of consciousness, providing improved resolution and accuracy. For example, cardiovascular system and respiratory system parameters responsive to consciousness may include perfusion index (PI), plethysmograph variability index (PVI), heart rate (HR), blood pressure (BP) and respiration rate (RR), to name a few.

[0009] Level of pain (LOP) is also an important physiological assessment during anesthesia and analgesia. A LOP

index is an advantageous quantization of pain that allows proper dosing of administered drugs. Advantageously, a LOP index may also be derived from various cardiovascular system and respiratory system parameters, such as those cited above.

[0010] Although dissimilar physiological phenomena, there is an important relationship between consciousness and pain for anesthesia and analgesia applications. During anesthesia, it is desirable to ensure that pain is eliminated during apparent unconsciousness. During analgesia, it is desirable for pain to be diminished or eliminated without impinging on consciousness. Accordingly, parameters useful in conjunction with consciousness assessment may be useful in conjunction with pain assessment and vice-a-versa.

[0011] A pharmacological management system advantageously provides sensors and processors to measure and analyze both DOC and LOP. Accordingly, a pharmacological management system advantageously senses and analyzes both consciousness and pain related physiological signals so as to generate multidimensional parameters or indexes indicative of both physiological processes.

[0012] One aspect of a pharmacological management system comprises sensors, a pharmacological status monitor and a drug administrator. The sensors attach to the patient so as to generate corresponding sensor signals. The pharmacological status monitor is responsive to the sensor signals so as to generate an output indicative of the drug-induced effects of the pharmacological agent on the patient. Further, the monitor output is fed-back to the drug administrator so as to regulate administration of the agent for a desired effect.

[0013] In various embodiments, the monitor comprises a hematological processor responsive to an optical sensor signal and a neurological processor responsive to a bio-potential sensor. The hematological processor has a photoplethysmograph input and provides a level of pain output to the pharmacological status monitor. The neurological processor has an EEG input and provides a depth of consciousness output to the pharmacological status monitor. The pharmacological status monitor generates a control output to a drug-infusion pump. The level of pain output is a perfusion index. The pharmacological status monitor generates a combined index related to both depth of consciousness and level of pain.

[0014] Another aspect of a pharmacological management system is inputting sensor signals derived from a patient and calculating physiological parameters accordingly. The sensor signals provide measurements of physiological systems. Physiological parameters are calculated from the sensor signals. The parameters are operated on to generate monitor outputs, which are indicative of levels of both consciousness and pain.

[0015] In various embodiments, a first sensor signal is utilized to generate a consciousness index and a second sensor signal is utilized to generate a perfusion index. Cues are displayed to indicate a patient with a stable or unstable physiological condition. Outputs control drug-infusion equipment or medical gas ventilation equipment. Patient wellness is diagnosed.

[0016] A further aspect of a pharmacological management system measures physiological parameters derived from at least some of a patient's central nervous system, respiratory system and cardio-vascular system so as to assess level of pain and depth of consciousness during the administration of anesthetic and analgesic agents. The pharmacological man-

agement system comprises sensors in communications with a patient so as to generate sensor signals and a monitor front-end in communications with the sensor signals so as to generate digitized sensor signals. A signal processor is in communications with the front-end so as to generate physiological parameters. The signal processor derives an electrical-based depth of consciousness (DOC) indicator from an electrical one of the sensors in communications with the patient's central nervous system and a pleth-based level of pain (LOP) indicator from an optical one of the sensors in communications with the patient's cardio-vascular system. An instrument manager generates a monitor output in response to a combination of the DOC indicator and the LOP indicator.

[0017] In various embodiments, a drug administrator administers a pharmacological agent to the patient and is responsive to the monitor output. The LOP indicator is responsive to a perfusion index (PI) parameter or a plethysmograph variability index (PVI) parameter. The monitor output comprises an electronic signal to the drug administrator that affects the dose of pharmacological agent. The monitor output also comprises a combined display of LOP and DOC.

BRIEF DESCRIPTION OF THE DRAWINGS

[0018] FIG. 1 is a general block diagram of pharmacological management system;

[0019] FIG. 2 is a block diagram of a pharmacological management system embodiment responsive to electrical and optical sensors so as to measure consciousness and pain;

[0020] FIG. 3 illustrates a pharmacological management system configured for anesthesia applications;

[0021] FIG. 4 illustrates a pharmacological management system configured for analgesia applications;

[0022] FIGS. 5A-B are illustrations of combination sensor embodiments for measuring both consciousness and pain;

[0023] FIG. 6 is a detailed block diagram of a pharmacological management system embodiment;

[0024] FIGS. 7A-E are illustrations of a pharmacological status monitor embodiment responsive to various sensors; and

[0025] FIG. 8 is an illustration of a multi-sensor embodiment for measuring level of pain and depth of consciousness.

DETAILED DESCRIPTION

[0026] FIG. 1 generally illustrates a pharmacological management system 100 having a drug administrator 110 that provides a pharmacological agent 114 to a patient 10 and a pharmacological status monitor 120 responsive to corresponding drug-induced effects 20. Pharmacological agents 114 may be, as examples, anesthesia or analgesia drugs. For anesthesia applications, the desired effect 20 may be general anesthesia or various levels of sedation. The drug administrator 110 may vary from a healthcare provider manually administering drugs to an automatic or semi-automatic machine such as a drug infusion device or medical gas inhalation device. The drug administrator may be responsive to external controls 112, such as manual inputs or electronic signals.

[0027] As shown in FIG. 1, drug-induced effects 20 in the patient 10 may include hypnosis 21, analgesia 23, amnesia 25, paralysis 27 and reflex suppression 29. Hypnosis 21

produces unconsciousness; analgesia **23** blocks the conscious sensation of pain; amnesia **25** prevents memory formation; paralysis **27** prevents unwanted movement or muscle tone; and reflex suppression **29** prevents exaggerated autonomic reflexes. For general anesthesia, some or all of these drug-induced effects **20** may be the goal. For low-level sedation, the goal may be to achieve some effects **20** while suppressing others. For pain reduction, analgesia **23** is the goal along with minimization of other drug-induced effects **20**.

[0028] Also shown in FIG. 1, the pharmacological management system **100** advantageously assists healthcare providers to achieve the above-stated goals, among others. Sensors (not shown) attached to the patient **10** provide biological signals **122** to the pharmacological status monitor **120**. The monitor **120** processes these signals **122** and generates outputs **124** indicative of the effects **20** of administered pharmacological agents **114**. The outputs **124** may be displays, alarms, controls or indicators, for example. The outputs **124** may also provide manual or automatic feedback **126** to the drug administrator **110** so as to regulate administration of the agent **114** for the desired effects **20**.

[0029] FIG. 2 illustrates a pharmacological management system **200** having sensors **201** in communications with a patient **10**. The sensors **201** generate sensor waveforms **202** to corresponding monitors **203**. The monitors **203** process the waveforms **202** so as to calculate parameters that alone or in combination are indicative of the pharmacological status of the patient **10**. In one embodiment, sensors **201** include an electrical (biopotential) sensor **210** placed proximate the head so as to generate an EEG waveform **212** and an optical sensor **220** placed on a fleshy tissue site so as to generate a photoplethysmograph **214**.

[0030] A neurological monitor **230** processes the EEG waveform **212** to generate a first parameter **232** related to depth of consciousness (DOC). In an embodiment, the first parameter **232** is a dimensionless index that reflects the level of activity of the cerebral cortex. In a particular embodiment, the first parameter **232** is a Bispectral Index™ (BIS) proprietary to Aspect Medical Systems, Inc., Norwood, Mass. (“Aspect”), and the neurological processor **230** is a BIS module also proprietary to Aspect. In another particular embodiment, the first parameter **232** is a Patient State Index™ (PSI) proprietary to Hospira, Inc., Lake Forest, Ill. (“Hospira”), and the neurological processor **230** is a SED-Line monitor or module, also proprietary to Hospira.

[0031] A hematological monitor **240** processes the photoplethysmograph (pleth) waveform **214** to generate at least one second parameter **242**. In an embodiment, the second parameter is a level of pain (LOP) index. In an embodiment, the second parameter is a pleth-based DOC index providing improved resolution and accuracy in determining DOC compared to only an EEG-based DOC index. In an embodiment, the second parameter **242** is a Perfusion Index (PI) or a Plethysmograph Variability Index (PVI) proprietary to Masimo Corporation, Irvine, Calif. (“Masimo”) or both, and the hematological processor **240** is any of various monitors or modules available from Masimo, such as described above. PI may change dramatically in response to sympathetic changes in vasoconstriction or vasodilation of peripheral vessels reflective of consciousness or pain. PI comprises a relative indication of pulse strength at a monitoring site. For example, PI may be defined as the ratio of a pleth AC value to its DC value, or the percentage of pulsatile signal

to non-pulsatile signal. PVI is described in U.S. patent application Ser. No. 11/952,940 filed Dec. 7, 2007 titled Plethysmograph Variability Index, assigned to Masimo and incorporated by reference herein.

[0032] As shown in FIG. 2, in an embodiment the electrical sensor **210** is any of various EEG sensors having multiple biopotential electrodes for placement across various head sites for detection of electrical signals originating in the brain. In an embodiment, the optical sensor **220** is any of various blood parameter sensors having LED emitters and at least one photodiode detector for placement at various fleshy tissue sites for detection of pulsatile blood flow and in particular the measurement of optical properties thereof, such as absorption, reflection, transmission and transmittance to name a few. In an embodiment, the optical sensor **220** is any of various optical sensors available from Masimo, such as described above.

[0033] Further shown in FIG. 2, in an embodiment, and optical sensor may comprise a combination or multi-sensor **250** that provides both EEG and photoplethysmograph waveforms, such as described with respect to FIGS. 5 and 8, below. In an embodiment, the hematological and neurological monitors may comprise a combination or multi-parameter monitor **260** having hematological and neurological processing plug-ins, modules or similar technology, such as described with respect to FIGS. 6 and 7, below.

[0034] FIG. 3 illustrates a pharmacological management system **300** configured for anesthesia applications having a sensor **301** attached to a patient **10**, a pharmacological status monitor **303** and a sensor cable **302** providing sensor signal communications between the sensor **301** and the monitor **303**. In an embodiment, the sensor **301** provides multiple physiological signals to the monitor **303**, which derives at least two different measures of consciousness or at least a measurement of consciousness and a measurement of pain. In an embodiment, these physiological signals are EEG and photoplethysmograph signals. In an embodiment, the monitor **303** calculates both a DOC index and PI from the EEG and plethysmograph signals and displays these parameters on the monitor display **305** accordingly.

[0035] As shown in FIG. 3, in a mixed display embodiment **310** a DOC parameter is displayed numerically adjacent a LOP parameter displayed as a color. For example, the DOC parameter may be an index, such as BIS, displayed as a dimensionless number. The LOP parameter may be, for example, PI, displayed as a green, yellow or red indicator depending on a preset range of high, medium and low PI values. The low PI value range being set so as to indicate the occurrence of significant vasoconstriction in response to pain or measurable vasodilation in response to increasing depth of consciousness. In a numerical display embodiment **320**, DOC and LOP are displayed as proximately located numerical readouts, such as a DOC index and a perfusion index (PI). In a graphical display embodiment **330**, DOC and LOP are separately indicated as trends, such as a DOC index trend and a PI trend. The monitor may also calculate a combined index related to consciousness or pain or both. Other individual or combined parameter displays include any of various readouts, graphs, charts or indicators in any of various single or multiple colors. The above monitoring and display embodiments advantageously assist an anesthesiologist or other administrator of drugs to titrate anesthesia based upon either multiple indicators of DOC or on indicators of DOC and LOP. This dual monitoring of pain and

consciousness during administration of anesthesia drugs advantageously increases monitor responsiveness to under or over dosing of anesthesia.

[0036] FIG. 4 illustrates a pharmacological management system 400 configured for analgesia applications, such as patient controlled analgesia (PCA). In particular, the pharmacological management system 400 has a sensor 401 attached to a patient 10, a pharmacological status monitor 403 and a sensor cable 402 providing sensor signal communications between the sensor 401 and the monitor 403. Further, the monitor 403 generates control signals via a control cable 407 to the drug-infusion pump 420. The drug-infusion pump 420 administers drugs to the patient 10 via a tube 422 and an IV 424. A patient-actuated controller (not shown) generates drug administration requests to the drug-infusion pump 420 via cable or wireless communications. In this manner, the pump 420 responds to patient perceived pain levels. In particular, the patient 10 actuates the controller, such as via a button press, so as to signal the drug-infusion pump 420 to administer a measured analgesia dose. The pump 420 enables or pauses patient-controlled dosing according to monitor 403 signals transmitted via the control cable 407. These control signals are responsive to monitor calculated DOC and LOP related parameters. Further, these parameters are displayed on a monitor screen 405, such as described with respect to FIG. 3, above.

[0037] The sensor 401 provides physiological signals to the monitor 403 related to depth of consciousness (DOC) or level of pain (LOP). In an embodiment, these physiological signals are EEG and photoplethysmograph signals. The monitor 403 calculates DOC, LOP or a combination consciousness and pain parameters from the EEG and plethysmograph signals and processes those parameters to generate control outputs 407 to the drug-infusion pump 420. In this manner, the administration of analgesia is controlled not only according to the patient's perceived pain level, but also according to a physiologically indicated pain level and to avoid consciousness impairment. In a particular embodiment, LOP is indicated by a perfusion index (PI), as described above, and PCA is paused or enabled according to a rising or falling PI, respectively, or according to a DOC index, or both.

[0038] FIGS. 5A-B illustrate combination sensors, which provide inputs to a pharmacological status monitor having both hematological and neurological signal processors, such as described with respect to FIG. 2, above. FIG. 5A illustrates a combination sensor 500 applied to the forehead and temple areas of a person. The sensor 500 includes an electrical or more specifically a biopotential sensor 510 and an optical sensor 520. A patient cable 530 connects the sensor to one or more monitoring devices (not shown), such as described with respect to FIGS. 7A-E, below. The biopotential sensor 510 may be an EEG sensor for depth of consciousness monitoring, as described above. The optical sensor 520 may be a pulse oximetry reflectance sensor for consciousness or pain monitoring via perfusion index (PI) or other blood parameter, also as described above. The patient cable 530 may connect near the person's temple, as shown, or as an alternative near the person's forehead. The biopotential sensor 510 and optical sensor 520 may share a common connector 540 or each sensor may have a dedicated patient cable connector. Combination EEG and pulse oximetry sensors are described in U.S. Pat. No. 6,934,570,

issued Aug. 23, 2005, titled Physiological Sensor Combination and incorporated by reference herein.

[0039] FIG. 5B illustrates a combination sensor 501 applied to the forehead, temple and ear concha areas of a person. In one embodiment, the sensor 501 includes a biopotential sensor 511, an optical sensor 521 and a cable 531 that connects the sensor 501 to one or more monitoring devices (not shown). The biopotential sensor 511 may be an EEG sensor for depth of consciousness monitoring, as described above. The optical sensor 521 may be a pulse oximetry transmissive sensor for level of pain monitoring via perfusion index (PI) or other blood parameter, also as described above. In a particular embodiment, the optical sensor 521 is a "Y"-clip ear sensor that flexes so as to slide over the ear periphery and onto either side of the concha. An emitter and detector located at opposite clip ends can then transmit multiple wavelength light into the concha tissue and detect that light after attenuation by pulsatile blood flow within the concha tissue. Optical ear sensors are described in U.S. Provisional Patent App. No. 61/152,964, filed Feb. 16, 2009, titled Ear Sensor and incorporated by reference herein.

[0040] FIG. 6 illustrates a pharmacological management system 600 embodiment having multiple sensors 610 in communication with a pharmacological status monitor 630. The sensors 610 are responsive to various physiological systems 601 so as to generate various sensor signals 603. A pharmacological status monitor 630 derives physiological parameters 605 from the sensor signals 603 and operates on the parameters 605 to generate monitor outputs 609. The measured physiological systems 601 include one or more of the central nervous system, including the brain; the respiratory system, including the lungs; and the cardio-vascular system, including the heart and arteries. The sensors 610 may include electrical sensors 612, 616, such as bio-potential sensors that generate EEG 622 and ECG 626 signals in response to brain or heart activity, respectively. The sensors 610 may also include mechanical, acoustical, temperature or humidity sensors 614, to name a few, that directly or indirectly measure the inspired or expired air flow 624 from the lungs. Sensors 610 include mechanical sensors 618 that measure arterial blood pressure 628. Sensors 610 further include optical sensors 619 that measure arterial blood flow or volume 629, according to instantaneous light absorption.

[0041] Also shown in FIG. 6, parameters 605 are any derived measurements indicative of consciousness or pain or both. Parameters 605 may include a consciousness index 652 derived from an EEG signal 622, such as described with respect to FIG. 2, above. Parameters 605 may also include a perfusion index (PI) 659 indicative of pain and derived from a photoplethysmograph signal 629, also described with respect to FIG. 2, above. Other pain indicative parameters may include respiration rate (RR) 654 derived from a respiratory air flow signal 624; heart rate (HR) 656, 658, 659 derived from an ECG 626, cuff plethysmograph 628 or photoplethysmograph 629; and blood pressure (BP) 658 derived from a pressure plethysmograph 628.

[0042] In addition, FIG. 6 shows outputs 609 including displays 662, alarms 664, controls 666 and diagnostics 668. Alarms 664 may be, for example, audible or visual alerts warning of critical conditions that need immediate attention. Controls 666 may be any of various electrical or electronic, wired or wireless or mechanical outputs, to name a few, capable of interfacing with and affecting another device. As examples, controls 666 may interface with drug-infusion

equipment or medical gas ventilation equipment, as described above. Diagnostics, including wellness indices, may be audible or visual cues indicating a patient with a stable or unstable physiological condition. Visual cues may be any of various digital readouts, bar graphs, trend graphs, color indicators and the like. Audible cues may be any of various sounds or tones, whether intermittent or continuous or constant or varying in volume.

[0043] As shown in FIG. 6, the monitor 630 has a sensor front end 640, one or more digital signal processors (DSP) 650 and one or more instrument managers 660. In an embodiment, the sensor front end 640 may have one or more of various preamps, signal conditioning and analog-to-digital conversion (ADC) that amplify, filter and digitize the sensor signals 603 so as to output digital data channels 642 to a DSP 650. In an embodiment, the DSP 650 comprises a processing device, such as one based on the Super Harvard ARchitecture ("SHARC") commercially available from Analog Devices or any other of a wide variety of data and/or signal processors capable of executing programs for determining physiological parameters from input data. In particular, the DSP 650 includes program instructions capable of receiving multiple channels of data 642 from the sensor front end 640, each channel of which relates to one or more sensor signals 603.

[0044] Also shown in FIG. 6, the instrument manager 660 may comprise one or more microcontrollers controlling system management, including, for example, translation and communications of calculated parameter data 605 to various outputs 609. The instrument manager 660 may also act as a watchdog circuit by, for example, monitoring and controlling the activity of the DSP 650.

[0045] FIG. 7A-E illustrate a pharmacological status monitor 700 embodiment capable of inputting signals from a wide range of sensors and of deriving a wide range of physiological parameters therefrom including DOC and LOP parameters, such as BIS and PI described with respect to FIG. 2, above, and others described with respect to FIG. 6, above. The pharmacological status monitor 700 has a docking station 710 including a display 712, a removable shuttle 720, a removable handheld 730 and a combination of plug-in modules 740. The docking station 710 has a shuttle port 714 that allows the shuttle station 720 to dock. The shuttle station 720 has a handheld port 732 that allows the handheld monitor 730 to dock. Accordingly, the modular patient monitor 700 has three-in-one functionality including a handheld 730, a handheld 730 docked into a shuttle station 720 as a handheld/shuttle combination and a handheld/shuttle docked into a docking station 710. When docked, the three modules of handheld 730, shuttle 720 and docking station 710 function as one unit. The handheld 730 docked into the shuttle module 720 functions independently of the docking station 710 and expands the handheld parameter capability to the ability to measure all parameters available to the shuttle 720. The docking station 710, in turn, provides the shuttle 720 or handheld/shuttle combination with a large color display 712 and trim knob control 714 in addition to a power supply/communications module 750 having ports for wireless and hardwired communications, Internet access and printers. In an embodiment, the handheld monitor 730 incorporates blood parameter measurement technologies including SpO₂, PI, HbCO, HbMet, and Hbt, and the shuttle station 720 incorporates non-blood parameters, such as intelligent cuff inflation (101) for blood pressure measure-

ments, acoustic respiration rate (ARR), ECG and EEG to name a few. A multi-parameter monitor is described in U.S. patent Ser. No. 11/903,746, filed Sep. 24, 2007, titled Modular Patient Monitor and incorporated by reference herein.

[0046] FIG. 8 illustrates an integrated multi-sensor 800 advantageously configured to provide multiple physiological parameter measurements to a pharmacological status monitor 700 (FIGS. 7A-E) via a single connector and interconnected patient cable (not shown). This eliminates the difficulties of a large number of cables and cumbersome connectors when multiple sensors are placed on various areas of a person. In particular, the multi-sensor 800 has a connector 810 in communications with a trunk 820, which fans out to multiple branches 830, each of which terminates in a sensor 840, 850, 860, 870, 880. In an embodiment, the multi-sensor allows measurement of perfusion index (PI) via a pulse oximetry sensor 880 placed on a finger; skin temperature via a thermistor 870 located under an arm; heart rate (HR) via an ECG sensor 860 placed on the chest area; respiration rate (RR) via an acoustic sensor 850 located on the neck to detect airway sounds; and a consciousness index via an EEG sensor 840 placed on the head area.

[0047] In other embodiments, other multiple parameter sensors provide sensor inputs to a pharmacological status monitor. A sensor providing both optical and acoustic inputs for blood parameters and acoustic parameters, such as discussed above, in addition to cerebral oximetry, oxygen supply and metabolism among other parameters is described in U.S. Provisional Patent App. No. 61/350,673 titled Opticooustic Sensor filed Jun. 2, 2010, assigned to Masimo and incorporated by reference herein. In particular, the cerebral parameters measured by the opticooustic sensor disclosed therein may provide further indications of LOP and DOC.

[0048] A pharmacological management system has been disclosed in detail in connection with various embodiments. These embodiments are disclosed by way of examples only and are not to limit the scope of the claims that follow. One of ordinary skill in the art will appreciate many variations and modifications.

1. (canceled)
2. A physiological monitoring method comprising:
 - receiving, from a non-invasive optical sensor comprising an emitter configured to emit light into a tissue site of a living patient and a detector configured to detect the emitted light after attenuation by the tissue site, a first sensor signal responsive to the light detected by the detector;
 - receiving, from one or more bio-potential sensors configured to be attached to the patient, at least a second sensor signal and a third sensor signal;
 - receiving, from an additional sensor configured to be attached to the patient, at least a fourth sensor signal;
 - determining, by a processor and based on the first sensor signal, a first physiological parameter indicative of a level of pain of the patient, wherein the first physiological sensor comprises a perfusion index;
 - determining, by the processor and based on the second sensor signal, a second physiological parameter indicative of the level of pain of the patient, wherein the second physiological parameter comprises an ECG;
 - determining, by the processor and based on the third sensor signal, a third physiological parameter indica-

tive of a depth of consciousness of the patient, wherein the third physiological parameter comprises an EEG; determining, by the processor and based on at least one of the first sensor signal, the second sensor signal, the third sensor signal, or the fourth sensor signal, a plurality of additional physiological parameters indicative of at least one of the level of pain of the patient or the depth of consciousness of the patient, wherein the plurality of additional physiological parameters include at least one of a respiration rate, a respiratory air flow, a heart rate, or a blood pressure; and

determining, by the processor and based on the first physiological parameter, the second physiological parameter, the third physiological parameter, and the plurality of additional physiological parameters, a combined index indicative of both the level of pain and the depth of consciousness of the patient.

3. The physiological monitoring method of claim 2 further comprising:

determining, by the processor and based on the first physiological parameter and the second physiological parameter, a combined indication of the level of pain of the patient.

4. The physiological monitoring method of claim 2 further comprising:

determining, by the processor and based on the first physiological parameter, the second physiological parameter, and the third physiological parameter, a combined indication of both the level of pain and the depth of consciousness of the patient.

5. The physiological monitoring method of claim 2, wherein the non-invasive optical sensor, the one or more bio-potential sensors, and the additional sensor are in communication with a monitor via a single cable.

6. The physiological monitoring method of claim 2 further comprising:

outputting feedback to a drug administrator configured to provide a pharmacological agent to the patient, wherein the feedback is outputted to the drug administrator so as to regulate administration of the pharmacological agent for a desired effect, wherein the feedback includes the combined index indicative of both the level of pain and the depth of consciousness of the patient.

7. The physiological monitoring method of claim 2 further comprising:

providing, by the processor, a control output to at least one of drug-infusion equipment or medical gas ventilation equipment based at least in part on the combined index indicative of both the level of pain and the depth of consciousness of the patient.

8. The physiological monitoring method of claim 2 further comprising:

generating, by the processor, a displayable output including a visual indication of the combined index indicative of both the level of pain and the depth of consciousness of the patient.

9. The physiological monitoring method of claim 8, wherein the visual indication comprises at least one of a number, a color, or a graph.

* * * * *

专利名称(译)	基于光学的生理监测系统		
公开(公告)号	US20170055847A1	公开(公告)日	2017-03-02
申请号	US15/347190	申请日	2016-11-09
[标]申请(专利权)人(译)	梅西莫股份有限公司		
申请(专利权)人(译)	Masimo公司		
当前申请(专利权)人(译)	Masimo公司		
[标]发明人	KIANI MASSI JOE E OREILLY MICHAEL		
发明人	KIANI, MASSI JOE E. O'REILLY, MICHAEL		
IPC分类号	A61B5/0205 A61B5/00 A61B5/1455 A61B5/0402 A61B5/0476		
CPC分类号	A61B5/0205 A61B5/0402 A61B5/0476 A61B5/1455 A61B5/4821 A61B5/4839 A61B5/087 A61B5/7282 A61B5/743 A61B5/021 A61B5/024 A61B5/0816 A61B5/7278		
优先权	61/243161 2009-09-17 US		
其他公开文献	US9833152		
外部链接	Espacenet USPTO		

摘要(译)

公开了一种非侵入性的基于光学的生理监测系统。在一个实施例中，所述非侵入性，基于光学的生理监测系统包括发射器，所述发射器被配置为将光发射到活体患者的组织部位中；检测器，被配置为在组织部位衰减之后检测发射的光并响应于检测到的光输出传感器信号；处理器，配置为基于传感器信号确定指示患者疼痛程度的第一生理参数。

