



US010398320B2

(12) **United States Patent**  
**Kiani et al.**

(10) **Patent No.:** **US 10,398,320 B2**  
(45) **Date of Patent:** **\*Sep. 3, 2019**

(54) **OPTICAL-BASED PHYSIOLOGICAL MONITORING SYSTEM**

*A61B 5/4839* (2013.01); *A61B 5/7278* (2013.01); *A61B 5/7282* (2013.01); *A61B 5/743* (2013.01); *A61B 5/021* (2013.01);

(71) Applicant: **MASIMO CORPORATION**, Irvine, CA (US)

(Continued)

(72) Inventors: **Massi Joe E. Kiani**, Laguna Niguel, CA (US); **Michael O'Reilly**, Dana Point, CA (US)

(58) **Field of Classification Search**  
CPC ..... *A61M 5/2066*; *A61B 5/0285*  
See application file for complete search history.

(73) Assignee: **Masimo Corporation**, Irvine, CA (US)

(56) **References Cited**

(\* ) Notice: Subject to any disclaimer, the term of this patent is extended or adjusted under 35 U.S.C. 154(b) by 0 days.

U.S. PATENT DOCUMENTS  
  
4,421,122 A \* 12/1983 Duffy ..... *A61B 5/0484*  
600/544  
4,960,128 A 10/1990 Gordon et al.  
(Continued)

This patent is subject to a terminal disclaimer.

OTHER PUBLICATIONS

(21) Appl. No.: **15/802,172**

Binnie, C. et al., *Clinical Neurophysiology*, vol. 2, 2003. Elsevier Science. p. 707-790.

(22) Filed: **Nov. 2, 2017**

(Continued)

(65) **Prior Publication Data**  
US 2018/0214031 A1 Aug. 2, 2018

*Primary Examiner* — Bhisma Mehta  
*Assistant Examiner* — Matthew A Engel  
(74) *Attorney, Agent, or Firm* — Knobbe Martens Olson & Bear LLP

**Related U.S. Application Data**

(63) Continuation of application No. 15/347,190, filed on Nov. 9, 2016, now Pat. No. 9,833,152, which is a (Continued)

(57) **ABSTRACT**

(51) **Int. Cl.**  
*A61B 5/00* (2006.01)  
*A61B 5/08* (2006.01)  
(Continued)

A non-invasive, optical-based physiological monitoring system is disclosed. In an embodiment, the non-invasive, optical-based physiological monitoring system comprises an emitter configured to emit light into a tissue site of a living patient; a detector configured to detect the emitted light after attenuation by the tissue site and output a sensor signal responsive to the detected light; and a processor configured determine, based on the sensor signal, a first physiological parameter indicative of a level of pain of the patient.

(52) **U.S. Cl.**  
CPC ..... *A61B 5/0205* (2013.01); *A61B 5/0402* (2013.01); *A61B 5/0476* (2013.01); *A61B 5/1455* (2013.01); *A61B 5/4821* (2013.01);

**11 Claims, 8 Drawing Sheets**

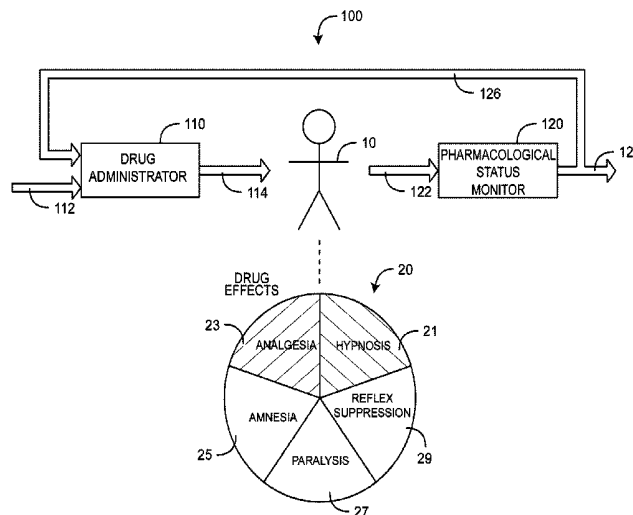

**Related U.S. Application Data**

	continuation of application No. 14/497,083, filed on Sep. 5, 2014, now Pat. No. 9,517,024, which is a continuation of application No. 12/885,430, filed on Sep. 17, 2010, now abandoned.	5,810,734 A	9/1998	Caro et al.	
		5,823,950 A	10/1998	Diab et al.	
		5,830,131 A	11/1998	Caro et al.	
		5,833,618 A	11/1998	Caro et al.	
		5,860,919 A	1/1999	Kiani-Azarbayjany et al.	
		5,890,929 A	4/1999	Mills et al.	
		5,904,654 A	5/1999	Wohlmann et al.	
		5,919,134 A	7/1999	Diab	
		5,934,925 A	8/1999	Tobler et al.	
		5,940,182 A	8/1999	Lepper, Jr. et al.	
		5,987,343 A	11/1999	Kinast	
(60)	Provisional application No. 61/243,161, filed on Sep. 17, 2009.	5,995,855 A *	11/1999	Kiani .....	A61B 5/14551 600/310
(51)	<b>Int. Cl.</b>				
	<i>A61B 5/021</i> (2006.01)	5,997,343 A	12/1999	Mills et al.	
	<i>A61B 5/024</i> (2006.01)	6,002,952 A	12/1999	Diab et al.	
	<i>A61B 5/087</i> (2006.01)	6,011,986 A	1/2000	Diab et al.	
	<i>A61B 5/0205</i> (2006.01)	6,018,682 A *	1/2000	Rise .....	A61B 5/4094 607/45
	<i>A61B 5/0402</i> (2006.01)	6,027,452 A	2/2000	Flaherty et al.	
	<i>A61B 5/0476</i> (2006.01)	6,036,642 A	3/2000	Diab et al.	
	<i>A61B 5/1455</i> (2006.01)	6,045,509 A	4/2000	Caro et al.	
(52)	<b>U.S. Cl.</b>	6,047,203 A *	4/2000	Sackner .....	A41D 13/1281 600/301
	CPC .....	6,067,462 A	5/2000	Diab et al.	
	<i>A61B 5/024</i> (2013.01); <i>A61B 5/087</i> (2013.01); <i>A61B 5/0816</i> (2013.01)	6,081,735 A *	6/2000	Diab .....	G06K 9/0051 600/336

(56) **References Cited**

U.S. PATENT DOCUMENTS

4,964,408 A	10/1990	Hink et al.	6,088,607 A	7/2000	Diab et al.
5,041,187 A	8/1991	Hink et al.	6,110,522 A	8/2000	Lepper, Jr. et al.
5,069,213 A	12/1991	Polczynski	6,124,597 A	9/2000	Shehada
5,163,438 A	11/1992	Gordon et al.	6,128,521 A	10/2000	Marro et al.
5,286,252 A *	2/1994	Tuttle .....	6,129,675 A	10/2000	Jay
		A61K 31/135 604/20	6,144,868 A	11/2000	Parker
5,319,355 A	6/1994	Russek	6,151,516 A	11/2000	Kiani-Azarbayjany et al.
5,337,744 A	8/1994	Branigan	6,152,754 A	11/2000	Gerhardt et al.
5,341,805 A	8/1994	Stavridi et al.	6,157,850 A *	12/2000	Diab .....
D353,195 S	12/1994	Savage et al.			G06K 9/0051 600/323
D353,196 S	12/1994	Savage et al.	6,165,005 A	12/2000	Mills et al.
5,377,676 A	1/1995	Vari et al.	6,184,521 B1	2/2001	Coffin, IV et al.
D359,546 S	6/1995	Savage et al.	6,206,830 B1	3/2001	Diab et al.
5,431,170 A	7/1995	Mathews	6,229,856 B1	5/2001	Diab et al.
D361,840 S	8/1995	Savage et al.	6,232,609 B1	5/2001	Snyder et al.
5,441,528 A *	8/1995	Chang .....	6,236,872 B1	5/2001	Diab et al.
		A61N 1/40 600/26	6,241,683 B1	6/2001	Macklem et al.
D362,063 S	9/1995	Savage et al.	6,253,097 B1	6/2001	Aronow et al.
5,452,717 A	9/1995	Branigan et al.	6,256,523 B1	7/2001	Diab et al.
D363,120 S	10/1995	Savage et al.	6,263,222 B1	7/2001	Diab et al.
5,456,252 A	10/1995	Vari et al.	6,278,522 B1	8/2001	Lepper, Jr. et al.
5,479,934 A	1/1996	Imran	6,280,213 B1	8/2001	Tobler et al.
5,482,036 A	1/1996	Diab et al.	6,285,896 B1	9/2001	Tobler et al.
5,490,505 A *	2/1996	Diab .....	6,301,493 B1	10/2001	Marro et al.
		A61B 5/14551 356/41	6,308,089 B1	10/2001	von der Ruhr et al.
5,494,043 A	2/1996	O'Sullivan et al.	6,317,627 B1	11/2001	Ennen et al.
5,533,511 A	7/1996	Kaspari et al.	6,321,100 B1	11/2001	Parker
5,534,851 A	7/1996	Russek	6,325,761 B1	12/2001	Jay
5,544,661 A *	8/1996	Davis .....	6,334,065 B1	12/2001	Al-Ali et al.
		A61B 5/0002 600/513	6,343,224 B1	1/2002	Parker
5,561,275 A	10/1996	Savage et al.	6,349,228 B1 *	2/2002	Kiani .....
5,562,002 A	10/1996	Lalin			A61B 5/14551 439/909
5,590,649 A	1/1997	Caro et al.	6,360,114 B1	3/2002	Diab et al.
5,602,924 A	2/1997	Durand et al.	6,368,283 B1	4/2002	Xu et al.
5,632,272 A	5/1997	Diab et al.	6,371,921 B1	4/2002	Caro et al.
5,638,816 A	6/1997	Kiani-Azarbayjany et al.	6,377,829 B1	4/2002	Al-Ali
5,638,818 A	6/1997	Diab et al.	6,388,240 B2	5/2002	Schulz et al.
5,645,440 A	7/1997	Tobler et al.	6,397,091 B2	5/2002	Diab et al.
5,685,299 A	11/1997	Diab et al.	6,430,437 B1	8/2002	Marro
5,694,939 A *	12/1997	Cowings .....	6,430,525 B1	8/2002	Weber et al.
		A61B 5/0205 128/905	6,463,311 B1	10/2002	Diab
D393,830 S	4/1998	Tobler et al.	6,470,199 B1	10/2002	Kopotic et al.
5,743,262 A	4/1998	Lepper, Jr. et al.	6,501,975 B2	12/2002	Diab et al.
5,758,644 A	6/1998	Diab et al.	6,505,059 B1	1/2003	Kollias et al.
5,760,910 A	6/1998	Lepper, Jr. et al.	6,515,273 B2	2/2003	Al-Ali
5,769,785 A	6/1998	Diab et al.	6,519,487 B1	2/2003	Parker
5,782,757 A	7/1998	Diab et al.	6,525,386 B1	2/2003	Mills et al.
5,785,659 A	7/1998	Caro et al.	6,526,300 B1	2/2003	Kiani et al.
5,791,347 A	8/1998	Flaherty et al.	6,541,756 B2	4/2003	Schulz et al.
			6,542,764 B1	4/2003	Al-Ali et al.
			6,580,086 B1	6/2003	Schulz et al.
			6,584,336 B1 *	6/2003	Ali .....
					A61B 5/14551 600/323

(56)		References Cited			
		U.S. PATENT DOCUMENTS			
6,595,316	B2	7/2003	Cybulski et al.	7,096,054	B2 8/2006 Abdul-Hafiz et al.
6,597,932	B2	7/2003	Tian et al.	7,132,641	B2 11/2006 Schulz et al.
6,597,933	B2	7/2003	Kiani et al.	7,142,901	B2 11/2006 Kiani et al.
6,606,511	B1	8/2003	Ali et al.	7,146,211	B2* 12/2006 Frei ..... A61B 5/04012
6,631,291	B2	10/2003	Viertio-Oja et al.		607/2
6,632,181	B2	10/2003	Flaherty et al.	7,149,561	B2 12/2006 Diab
6,639,668	B1	10/2003	Trepagnier	7,186,966	B2 3/2007 Al-Ali
6,640,116	B2	10/2003	Diab	7,190,261	B2 3/2007 Al-Ali
6,643,530	B2	11/2003	Diab et al.	7,215,984	B2 5/2007 Diab
6,650,917	B2	11/2003	Diab et al.	7,215,986	B2 5/2007 Diab
6,654,624	B2	11/2003	Diab et al.	7,221,971	B2 5/2007 Diab
6,658,276	B2	12/2003	Kiani et al.	7,225,006	B2 5/2007 Al-Ali et al.
6,661,161	B1	12/2003	Lanzo et al.	7,225,007	B2 5/2007 Al-Ali
6,671,531	B2	12/2003	Al-Ali et al.	RE39,672	E 6/2007 Shehada et al.
6,678,543	B2	1/2004	Diab et al.	7,239,905	B2 7/2007 Kiani-Azarbayjany et al.
6,684,090	B2	1/2004	Ali et al.	7,245,953	B1 7/2007 Parker
6,684,091	B2	1/2004	Parker	7,254,429	B2 8/2007 Schurman et al.
6,697,656	B1	2/2004	Al-Ali	7,254,431	B2 8/2007 Al-Ali
6,697,657	B1	2/2004	Shehada et al.	7,254,433	B2 8/2007 Diab et al.
6,697,658	B2	2/2004	Al-Ali	7,254,434	B2 8/2007 Schulz et al.
RE38,476	E	3/2004	Diab et al.	7,272,425	B2 9/2007 Al-Ali
6,699,194	B1	3/2004	Diab et al.	7,274,955	B2 9/2007 Kiani et al.
6,714,804	B2	3/2004	Al-Ali et al.	D554,263	S 10/2007 Al-Ali
RE38,492	E	4/2004	Diab et al.	7,277,758	B2* 10/2007 DiLorenzo ..... A61N 1/36082
6,721,582	B2	4/2004	Trepagnier et al.		607/45
6,721,585	B1	4/2004	Parker	7,280,858	B2 10/2007 Al-Ali et al.
6,725,075	B2	4/2004	Al-Ali	7,289,835	B2 10/2007 Mansfield et al.
6,728,560	B2	4/2004	Kollias et al.	7,292,883	B2 11/2007 De Felice et al.
6,735,459	B2	5/2004	Parker	7,295,866	B2 11/2007 Al-Ali
6,745,060	B2	6/2004	Diab et al.	7,299,088	B1* 11/2007 Thakor ..... A61B 5/048
6,760,607	B2	7/2004	Al-Ali		600/544
6,768,920	B2*	7/2004	Lange ..... A61B 5/0478	7,328,053	B1 2/2008 Diab et al.
			600/300	7,332,784	B2 2/2008 Mills et al.
6,770,028	B1*	8/2004	Ali ..... A61B 5/0002	7,340,287	B2 3/2008 Mason et al.
			600/300	7,341,559	B2 3/2008 Schulz et al.
6,771,994	B2	8/2004	Kiani et al.	7,343,186	B2 3/2008 Lamego et al.
6,792,300	B1	9/2004	Diab et al.	D566,282	S 4/2008 Al-Ali et al.
6,813,511	B2	11/2004	Diab et al.	7,355,512	B1 4/2008 Al-Ali
6,816,741	B2	11/2004	Diab	7,356,365	B2 4/2008 Schurman
6,822,564	B2	11/2004	Al-Ali	7,371,981	B2 5/2008 Abdul-Hafiz
6,826,419	B2	11/2004	Diab et al.	7,373,193	B2 5/2008 Al-Ali et al.
6,830,711	B2	12/2004	Mills et al.	7,373,194	B2 5/2008 Weber et al.
6,850,787	B2	2/2005	Weber et al.	7,373,198	B2* 5/2008 Bibian ..... A61B 5/048
6,850,788	B2	2/2005	Al-Ali		600/544
6,852,083	B2	2/2005	Caro et al.	7,376,453	B1 5/2008 Diab et al.
6,861,639	B2	3/2005	Al-Ali	7,377,794	B2 5/2008 Al Ali et al.
6,898,452	B2	5/2005	Al-Ali et al.	7,377,899	B2 5/2008 Weber et al.
6,920,345	B2	7/2005	Al-Ali et al.	7,383,070	B2 6/2008 Diab et al.
6,931,268	B1	8/2005	Kiani-Azarbayjany et al.	7,415,297	B2* 8/2008 Al-Ali ..... A61B 5/14551
6,934,570	B2*	8/2005	Kiani ..... A61B 5/0478		340/511
			600/324	7,428,432	B2* 9/2008 Ali ..... A61B 5/0002
					600/323
6,939,305	B2	9/2005	Flaherty et al.	7,438,683	B2 10/2008 Al-Ali et al.
6,943,348	B1	9/2005	Coffin, IV	7,440,787	B2 10/2008 Diab
6,950,687	B2	9/2005	Al-Ali	7,454,240	B2 11/2008 Diab et al.
6,961,598	B2	11/2005	Diab	7,467,002	B2 12/2008 Weber et al.
6,970,792	B1	11/2005	Diab	7,469,157	B2 12/2008 Diab et al.
6,979,812	B2	12/2005	Al-Ali	7,471,969	B2 12/2008 Diab et al.
6,985,764	B2	1/2006	Mason et al.	7,471,971	B2 12/2008 Diab et al.
6,993,371	B2	1/2006	Kiani et al.	7,483,729	B2 1/2009 Al-Ali et al.
6,996,427	B2	2/2006	Ali et al.	7,483,730	B2 1/2009 Diab et al.
6,999,904	B2	2/2006	Weber et al.	7,489,958	B2 2/2009 Diab et al.
7,003,338	B2	2/2006	Weber et al.	7,496,391	B2 2/2009 Diab et al.
7,003,339	B2	2/2006	Diab et al.	7,496,393	B2 2/2009 Diab et al.
7,015,451	B2	3/2006	Dalke et al.	D587,657	S 3/2009 Al-Ali et al.
7,024,233	B2	4/2006	Ali et al.	7,499,741	B2 3/2009 Diab et al.
7,027,849	B2	4/2006	Al-Ali	7,499,835	B2 3/2009 Weber et al.
7,030,749	B2	4/2006	Al-Ali	7,500,950	B2 3/2009 Al-Ali et al.
7,039,449	B2	5/2006	Al-Ali	7,509,154	B2 3/2009 Diab et al.
7,041,060	B2	5/2006	Flaherty et al.	7,509,494	B2 3/2009 Al-Ali
7,044,918	B2	5/2006	Diab	7,510,849	B2 3/2009 Schurman et al.
7,048,687	B1	5/2006	Reuss et al.	7,510,849	B2 3/2009 Diab et al.
7,067,893	B2	6/2006	Mills et al.	7,526,328	B2 4/2009 Diab et al.
7,089,927	B2*	8/2006	John ..... A61B 5/048	7,530,942	B1 5/2009 Diab
			128/200.24	7,530,949	B2* 5/2009 Al Ali ..... A61B 5/0002
					600/300
7,096,052	B2	8/2006	Mason et al.	7,530,955	B2 5/2009 Diab et al.
				7,563,110	B2 7/2009 Al-Ali et al.
				7,596,398	B2 9/2009 Al-Ali et al.
				7,618,375	B2 11/2009 Flaherty

(56)	<b>References Cited</b>		8,187,181 B2 *	5/2012	Osorio .....	A61B 5/048 128/920
	U.S. PATENT DOCUMENTS		8,190,223 B2	5/2012	Al-Ali et al.	
			8,190,227 B2	5/2012	Diab et al.	
D606,659 S	12/2009	Kiani et al.	8,203,438 B2	6/2012	Kiani et al.	
7,647,083 B2	1/2010	Al-Ali et al.	8,203,704 B2	6/2012	Merritt et al.	
D609,193 S	2/2010	Al-Ali et al.	8,204,566 B2	6/2012	Schurman et al.	
D614,305 S	4/2010	Al-Ali et al.	8,219,172 B2	7/2012	Schurman et al.	
RE41,317 E	5/2010	Parker	8,224,411 B2	7/2012	Al-Ali et al.	
7,715,919 B2 *	5/2010	Osorio .....	8,228,181 B2	7/2012	Al-Ali	
		A61N 1/36014 607/45	8,229,533 B2	7/2012	Diab et al.	
7,729,733 B2	6/2010	Al-Ali et al.	8,233,955 B2	7/2012	Al-Ali et al.	
7,734,320 B2	6/2010	Al-Ali	8,244,325 B2	8/2012	Al-Ali et al.	
7,761,127 B2	7/2010	Al-Ali et al.	8,255,026 B1	8/2012	Al-Ali	
7,761,128 B2	7/2010	Al-Ali et al.	8,255,027 B2	8/2012	Al-Ali et al.	
7,764,982 B2	7/2010	Dalke et al.	8,255,028 B2	8/2012	Al-Ali et al.	
D621,516 S	8/2010	Kiani et al.	8,260,577 B2	9/2012	Weber et al.	
7,783,343 B2 *	8/2010	Sarkela .....	8,265,723 B1	9/2012	McHale et al.	
		A61B 5/048 600/544	8,274,360 B2	9/2012	Sampath et al.	
7,791,155 B2	9/2010	Diab	8,280,473 B2	10/2012	Al-Ali	
7,801,581 B2	9/2010	Diab	8,301,217 B2	10/2012	Al-Ali et al.	
7,811,279 B2 *	10/2010	John .....	8,306,596 B2	11/2012	Schurman et al.	
		A61M 25/0026 604/890.1	8,310,336 B2	11/2012	Muhsin et al.	
7,822,452 B2	10/2010	Schurman et al.	8,315,683 B2	11/2012	Al-Ali et al.	
RE41,912 E	11/2010	Parker	RE43,860 E	12/2012	Parker	
7,844,313 B2	11/2010	Kiani et al.	8,337,403 B2	12/2012	Al-Ali et al.	
7,844,314 B2	11/2010	Al-Ali	8,346,330 B2	1/2013	Lamego	
7,844,315 B2	11/2010	Al-Ali	8,353,842 B2	1/2013	Al-Ali et al.	
7,865,222 B2	1/2011	Weber et al.	8,355,766 B2	1/2013	MacNeish, III et al.	
7,873,497 B2	1/2011	Weber et al.	8,359,080 B2	1/2013	Diab et al.	
7,880,606 B2	2/2011	Al-Ali	8,364,223 B2	1/2013	Al-Ali et al.	
7,880,626 B2	2/2011	Al-Ali et al.	8,364,226 B2	1/2013	Diab et al.	
7,891,355 B2	2/2011	Al-Ali et al.	8,374,665 B2	2/2013	Lamego	
7,894,868 B2	2/2011	Al-Ali et al.	8,385,995 B2	2/2013	Al-Ali et al.	
7,899,507 B2	3/2011	Al-Ali et al.	8,385,996 B2	2/2013	Smith et al.	
7,899,518 B2	3/2011	Trepagnier et al.	8,388,353 B2	3/2013	Kiani et al.	
7,904,132 B2	3/2011	Weber et al.	8,399,822 B2	3/2013	Al-Ali	
7,909,772 B2	3/2011	Popov et al.	8,401,602 B2	3/2013	Kiani	
7,910,875 B2	3/2011	Al-Ali	8,405,608 B2	3/2013	Al-Ali et al.	
7,919,713 B2	4/2011	Al-Ali et al.	8,414,499 B2	4/2013	Al-Ali et al.	
7,937,128 B2	5/2011	Al-Ali	8,418,524 B2	4/2013	Al-Ali	
7,937,129 B2	5/2011	Mason et al.	8,423,106 B2	4/2013	Lamego et al.	
7,937,130 B2	5/2011	Diab et al.	8,428,967 B2	4/2013	Olsen et al.	
7,941,199 B2	5/2011	Kiani	8,430,817 B1	4/2013	Al-Ali et al.	
7,951,086 B2	5/2011	Flaherty et al.	8,437,825 B2	5/2013	Dalvi et al.	
7,957,780 B2	6/2011	Lamego et al.	8,455,290 B2	6/2013	Siskavich	
7,962,188 B2	6/2011	Kiani et al.	8,457,703 B2	6/2013	Al-Ali	
7,962,190 B1	6/2011	Diab et al.	8,457,707 B2	6/2013	Kiani	
7,976,472 B2	7/2011	Kiani	8,463,349 B2	6/2013	Diab et al.	
7,988,637 B2	8/2011	Diab	8,466,286 B2	6/2013	Bellot et al.	
7,990,382 B2	8/2011	Kiani	8,471,713 B2	6/2013	Poeze et al.	
7,991,446 B2 *	8/2011	Ali .....	8,473,020 B2	6/2013	Kiani et al.	
		A61B 5/0002 600/322	8,483,787 B2	7/2013	Al-Ali et al.	
8,000,761 B2	8/2011	Al-Ali	8,489,364 B2	7/2013	Weber et al.	
8,008,088 B2	8/2011	Bellott et al.	8,498,684 B2	7/2013	Weber et al.	
RE42,753 E	9/2011	Kiani-Azarbayjany et al.	8,504,128 B2	8/2013	Blank et al.	
8,019,400 B2	9/2011	Diab et al.	8,509,867 B2	8/2013	Workman et al.	
8,028,701 B2	10/2011	Al-Ali et al.	8,515,509 B2	8/2013	Bruinsma et al.	
8,029,765 B2	10/2011	Bellott et al.	8,523,781 B2	9/2013	Al-Ali	
8,036,727 B2	10/2011	Schurman et al.	8,529,301 B2	9/2013	Al-Ali et al.	
8,036,728 B2	10/2011	Diab et al.	8,532,727 B2	9/2013	Ali et al.	
8,046,040 B2	10/2011	Ali et al.	8,532,728 B2	9/2013	Diab et al.	
8,046,041 B2	10/2011	Diab et al.	D692,145 S	10/2013	Al-Ali et al.	
8,046,042 B2	10/2011	Diab et al.	8,547,209 B2	10/2013	Kiani et al.	
8,048,040 B2	11/2011	Kiani	8,548,548 B2	10/2013	Al-Ali	
8,050,728 B2	11/2011	Al-Ali et al.	8,548,549 B2	10/2013	Schurman et al.	
RE43,169 E	2/2012	Parker	8,548,550 B2	10/2013	Al-Ali et al.	
8,118,620 B2	2/2012	Al-Ali et al.	8,560,032 B2	10/2013	Al-Ali et al.	
8,126,528 B2	2/2012	Diab et al.	8,560,034 B1	10/2013	Diab et al.	
8,128,572 B2	3/2012	Diab et al.	8,570,167 B2	10/2013	Al-Ali	
8,130,105 B2	3/2012	Al-Ali et al.	8,570,503 B2	10/2013	Vo et al.	
8,145,287 B2	3/2012	Diab et al.	8,571,617 B2	10/2013	Reichgott et al.	
8,150,487 B2	4/2012	Diab et al.	8,571,618 B1	10/2013	Lamego et al.	
8,175,672 B2	5/2012	Parker	8,571,619 B2	10/2013	Al-Ali et al.	
8,180,420 B2	5/2012	Diab et al.	8,577,431 B2	11/2013	Lamego et al.	
8,182,443 B1 *	5/2012	Kiani .....	8,581,732 B2	11/2013	Al-Ali et al.	
		A61M 16/12 604/131	8,584,345 B2	11/2013	Al-Ali et al.	
8,185,180 B2	5/2012	Diab et al.	8,588,880 B2	11/2013	Abdul-Hafiz et al.	
			8,600,467 B2	12/2013	Al-Ali et al.	

(56)

## References Cited

## U.S. PATENT DOCUMENTS

8,606,342	B2	12/2013	Diab	8,998,809	B2	4/2015	Kiani
8,626,255	B2	1/2014	Al-Ali et al.	9,028,429	B2	5/2015	Telfort et al.
8,630,691	B2	1/2014	Lamego et al.	9,037,207	B2	5/2015	Al-Ali et al.
8,634,889	B2	1/2014	Al-Ali et al.	9,060,721	B2	6/2015	Reichgott et al.
8,641,631	B2	2/2014	Sierra et al.	9,066,666	B2	6/2015	Kiani
8,652,060	B2	2/2014	Al-Ali	9,066,680	B1	6/2015	Al-Ali et al.
8,663,107	B2	3/2014	Kiani	9,072,474	B2	7/2015	Al-Ali et al.
8,666,468	B1	3/2014	Al-Ali	9,078,560	B2	7/2015	Schurman et al.
8,667,967	B2	3/2014	Al-Ali et al.	9,084,569	B2	7/2015	Weber et al.
8,670,811	B2	3/2014	O'Reilly	9,095,316	B2	8/2015	Welch et al.
8,670,814	B2	3/2014	Diab et al.	9,106,038	B2	8/2015	Telfort et al.
8,676,286	B2	3/2014	Weber et al.	9,107,625	B2	8/2015	Telfort et al.
8,682,407	B2	3/2014	Al-Ali	9,107,626	B2	8/2015	Al-Ali et al.
RE44,823	E	4/2014	Parker	9,113,831	B2	8/2015	Al-Ali
RE44,875	E	4/2014	Kiani et al.	9,113,832	B2	8/2015	Al-Ali
8,690,799	B2	4/2014	Telfort et al.	9,119,595	B2	9/2015	Lamego
8,700,112	B2	4/2014	Kiani	9,131,881	B2	9/2015	Diab et al.
8,702,627	B2	4/2014	Telfort et al.	9,131,882	B2	9/2015	Al-Ali et al.
8,706,179	B2	4/2014	Parker	9,131,883	B2	9/2015	Al-Ali
8,712,494	B1	4/2014	MacNeish, III et al.	9,131,917	B2	9/2015	Telfort et al.
8,715,206	B2	5/2014	Telfort et al.	9,138,180	B1	9/2015	Coverston et al.
8,718,735	B2	5/2014	Lamego et al.	9,138,182	B2	9/2015	Al-Ali et al.
8,718,737	B2	5/2014	Diab et al.	9,138,192	B2	9/2015	Weber et al.
8,718,738	B2	5/2014	Blank et al.	9,142,117	B2	9/2015	Muhsin et al.
8,720,249	B2	5/2014	Al-Ali	9,153,112	B1	10/2015	Kiani et al.
8,721,541	B2	5/2014	Al-Ali et al.	9,153,121	B2	10/2015	Kiani et al.
8,721,542	B2	5/2014	Al-Ali et al.	9,161,696	B2	10/2015	Al-Ali et al.
8,723,677	B1	5/2014	Kiani	9,161,713	B2	10/2015	Al-Ali et al.
8,740,792	B1	6/2014	Kiani et al.	9,167,995	B2	10/2015	Lamego et al.
8,754,776	B2	6/2014	Poeze et al.	9,176,141	B2	11/2015	Al-Ali et al.
8,755,535	B2	6/2014	Telfort et al.	9,186,102	B2	11/2015	Bruinsma et al.
8,755,856	B2	6/2014	Diab et al.	9,192,312	B2	11/2015	Al-Ali
8,755,872	B1	6/2014	Marinow	9,192,329	B2	11/2015	Al-Ali
8,761,850	B2	6/2014	Lamego	9,192,351	B1	11/2015	Telfort et al.
8,764,671	B2	7/2014	Kiani	9,195,385	B2	11/2015	Al-Ali et al.
8,768,423	B2	7/2014	Shakespeare et al.	9,211,072	B2	12/2015	Kiani
8,771,204	B2	7/2014	Telfort et al.	9,211,095	B1	12/2015	Al-Ali
8,777,634	B2	7/2014	Kiani et al.	9,218,454	B2	12/2015	Kiani et al.
8,781,543	B2	7/2014	Diab et al.	9,226,696	B2	1/2016	Kiani
8,781,544	B2	7/2014	Al-Ali et al.	9,241,662	B2	1/2016	Al-Ali et al.
8,781,549	B2	7/2014	Al-Ali et al.	9,245,668	B1	1/2016	Vo et al.
8,788,003	B2	7/2014	Schurman et al.	9,259,185	B2	2/2016	Abdul-Hafiz et al.
8,790,268	B2	7/2014	Al-Ali	9,267,572	B2	2/2016	Barker et al.
8,801,613	B2	8/2014	Al-Ali et al.	9,277,880	B2	3/2016	Poeze et al.
8,821,397	B2	9/2014	Al-Ali et al.	9,289,167	B2	3/2016	Diab et al.
8,821,415	B2	9/2014	Al-Ali et al.	9,295,421	B2	3/2016	Kiani et al.
8,830,449	B1	9/2014	Lamego et al.	9,307,928	B1	4/2016	Al-Ali et al.
8,831,700	B2	9/2014	Schurman et al.	9,323,894	B2	4/2016	Kiani
8,840,549	B2	9/2014	Al-Ali et al.	D755,392	S	5/2016	Hwang et al.
8,847,740	B2	9/2014	Kiani et al.	9,326,712	B1	5/2016	Kiani
8,849,365	B2	9/2014	Smith et al.	9,333,316	B2	5/2016	Kiani
8,852,094	B2	10/2014	Al-Ali et al.	9,339,220	B2	5/2016	Lamego et al.
8,852,994	B2	10/2014	Wojtczuk et al.	9,341,565	B2	5/2016	Lamego et al.
8,868,147	B2	10/2014	Stippick et al.	9,351,673	B2	5/2016	Diab et al.
8,868,150	B2	10/2014	Al-Ali et al.	9,351,675	B2	5/2016	Al-Ali et al.
8,870,792	B2	10/2014	Al-Ali et al.	9,364,181	B2	6/2016	Kiani et al.
8,886,271	B2	11/2014	Kiani et al.	9,368,671	B2	6/2016	Wojtczuk et al.
8,888,539	B2	11/2014	Al-Ali et al.	9,370,325	B2	6/2016	Al-Ali et al.
8,888,708	B2	11/2014	Diab et al.	9,370,326	B2	6/2016	McHale et al.
8,892,180	B2	11/2014	Weber et al.	9,370,335	B2	6/2016	Al-Ali et al.
8,897,847	B2	11/2014	Al-Ali	9,375,185	B2	6/2016	Ali et al.
8,909,310	B2	12/2014	Lamego et al.	9,386,953	B2	7/2016	Al-Ali
8,911,377	B2	12/2014	Al-Ali	9,386,961	B2	7/2016	Al-Ali et al.
8,912,909	B2	12/2014	Al-Ali et al.	9,392,945	B2	7/2016	Al-Ali et al.
8,920,317	B2	12/2014	Al-Ali et al.	9,397,448	B2	7/2016	Al-Ali et al.
8,921,699	B2	12/2014	Al-Ali et al.	9,408,542	B1	8/2016	Kinast et al.
8,922,382	B2	12/2014	Al-Ali et al.	9,436,645	B2	9/2016	Al-Ali et al.
8,929,964	B2	1/2015	Al-Ali et al.	9,445,759	B1	9/2016	Lamego et al.
8,942,777	B2	1/2015	Diab et al.	9,466,919	B2	10/2016	Kiani et al.
8,948,834	B2	2/2015	Diab et al.	9,474,474	B2	10/2016	Lamego et al.
8,948,835	B2	2/2015	Diab	9,480,422	B2	11/2016	Al-Ali
8,965,471	B2	2/2015	Lamego	9,480,435	B2	11/2016	Olsen
8,983,564	B2	3/2015	Al-Ali	9,492,110	B2	11/2016	Al-Ali et al.
8,989,831	B2	3/2015	Al-Ali et al.	9,510,779	B2	12/2016	Poeze et al.
8,996,085	B2	3/2015	Kiani et al.	9,517,024	B2*	12/2016	Kiani ..... A61B 5/0205
				9,532,722	B2	1/2017	Lamego et al.
				9,538,949	B2	1/2017	Al-Ali et al.
				9,538,980	B2	1/2017	Telfort et al.
				9,549,696	B2	1/2017	Lamego et al.





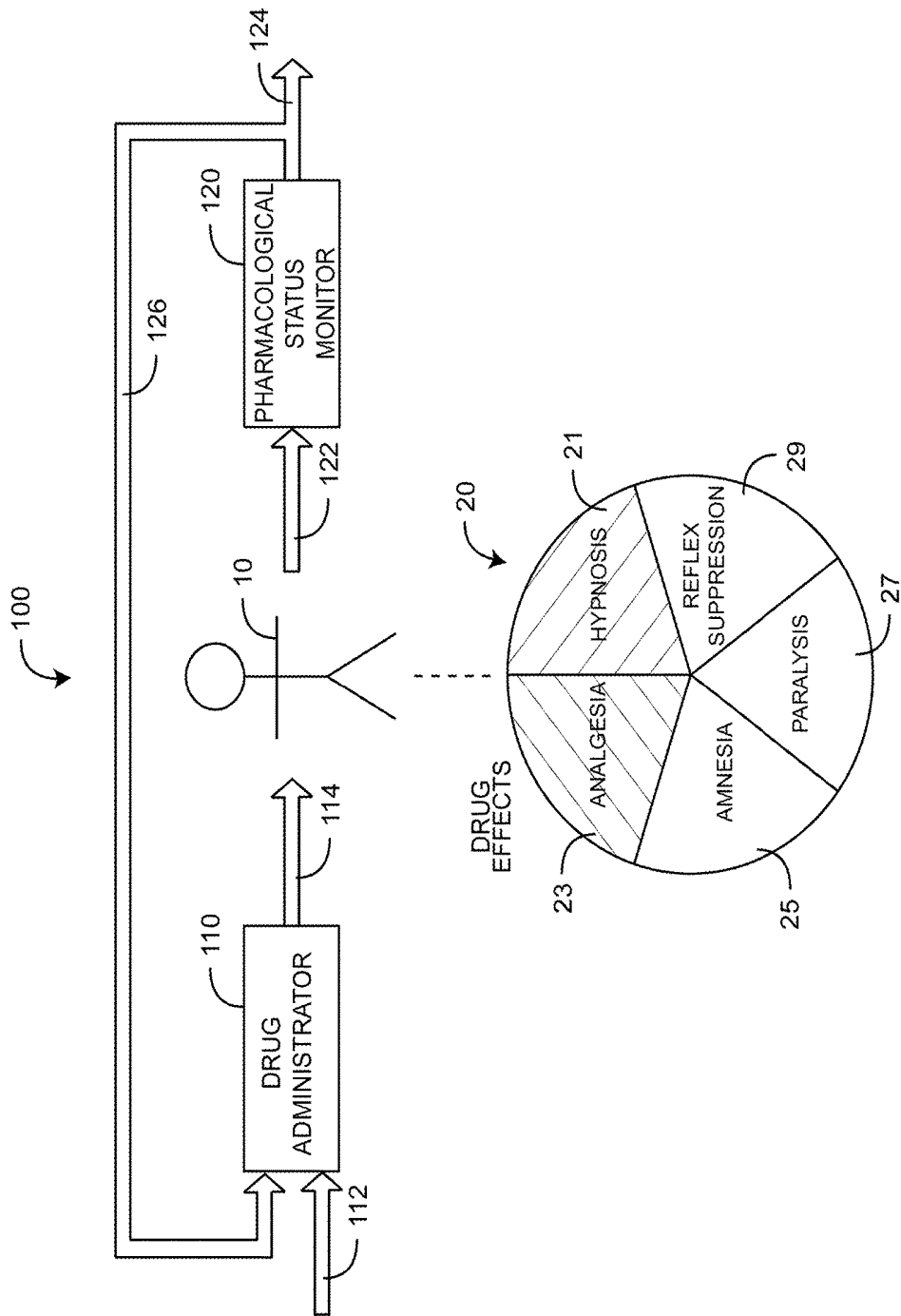

FIG. 1

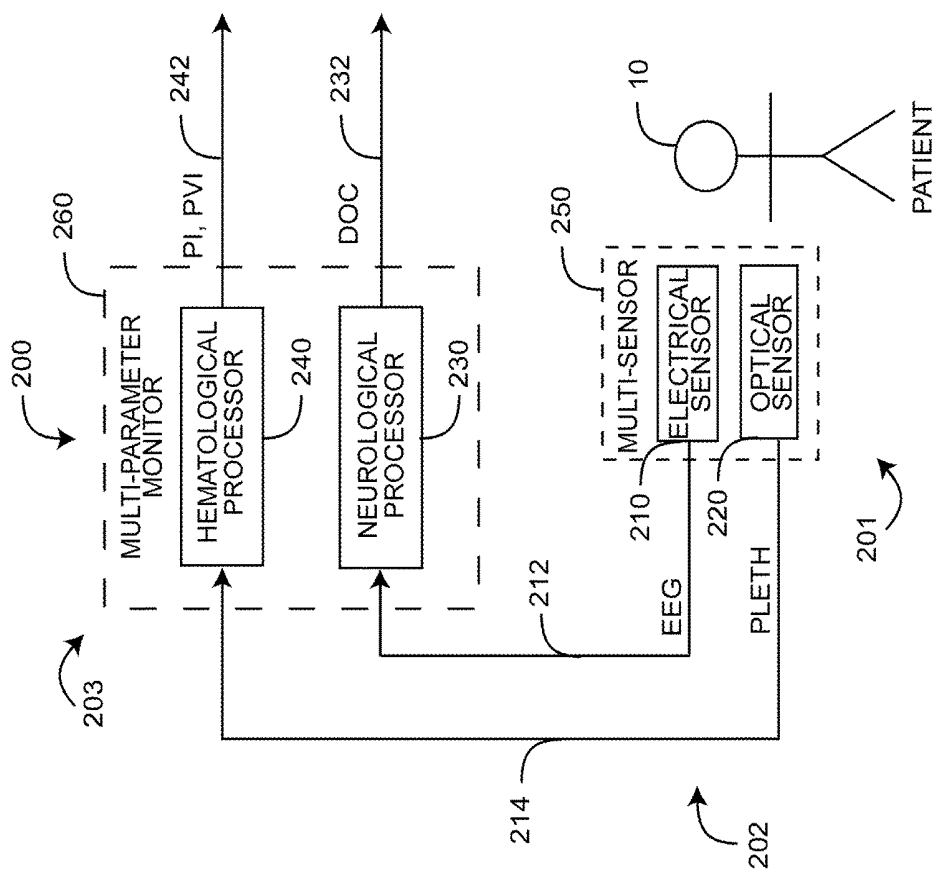

FIG. 2

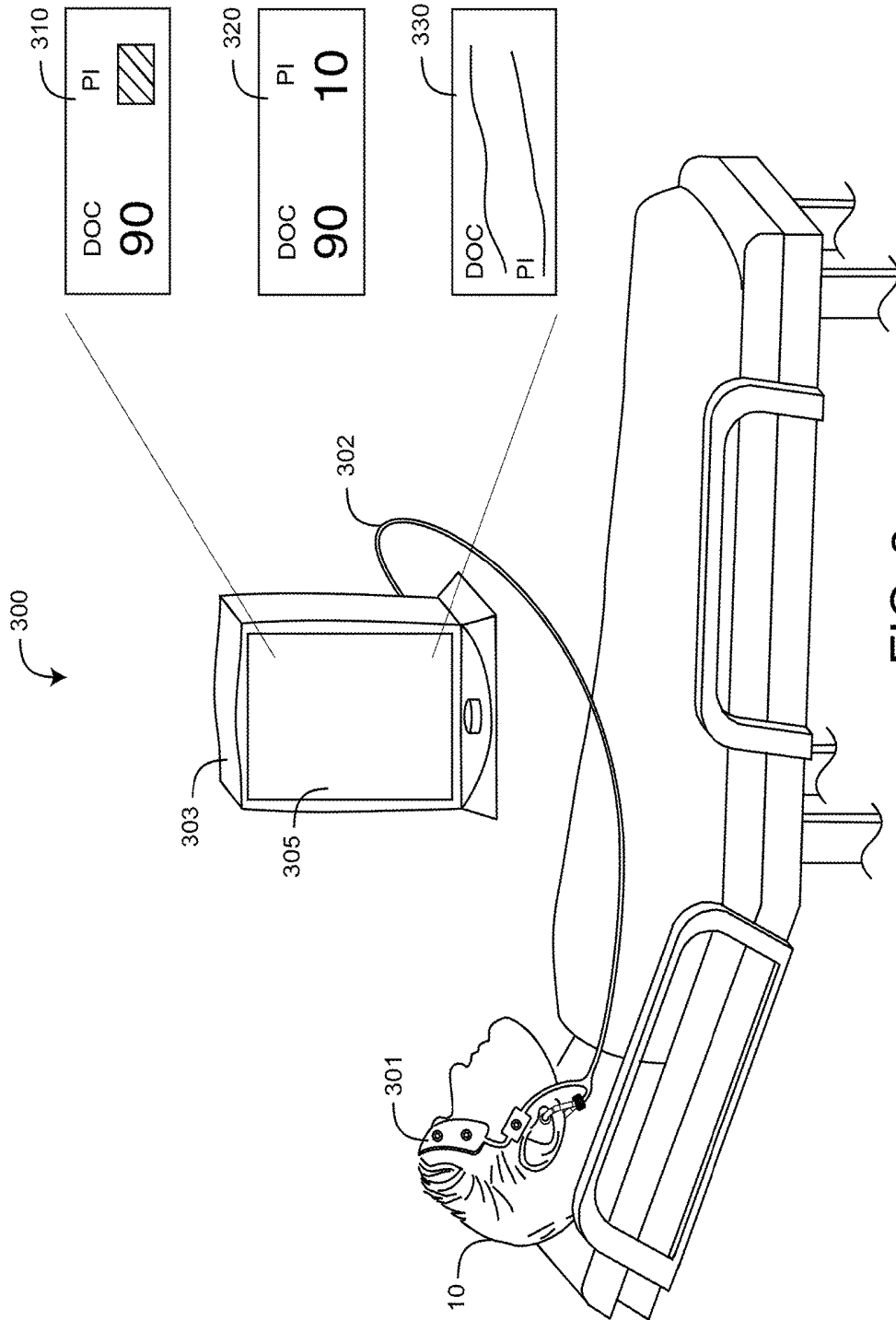

FIG. 3

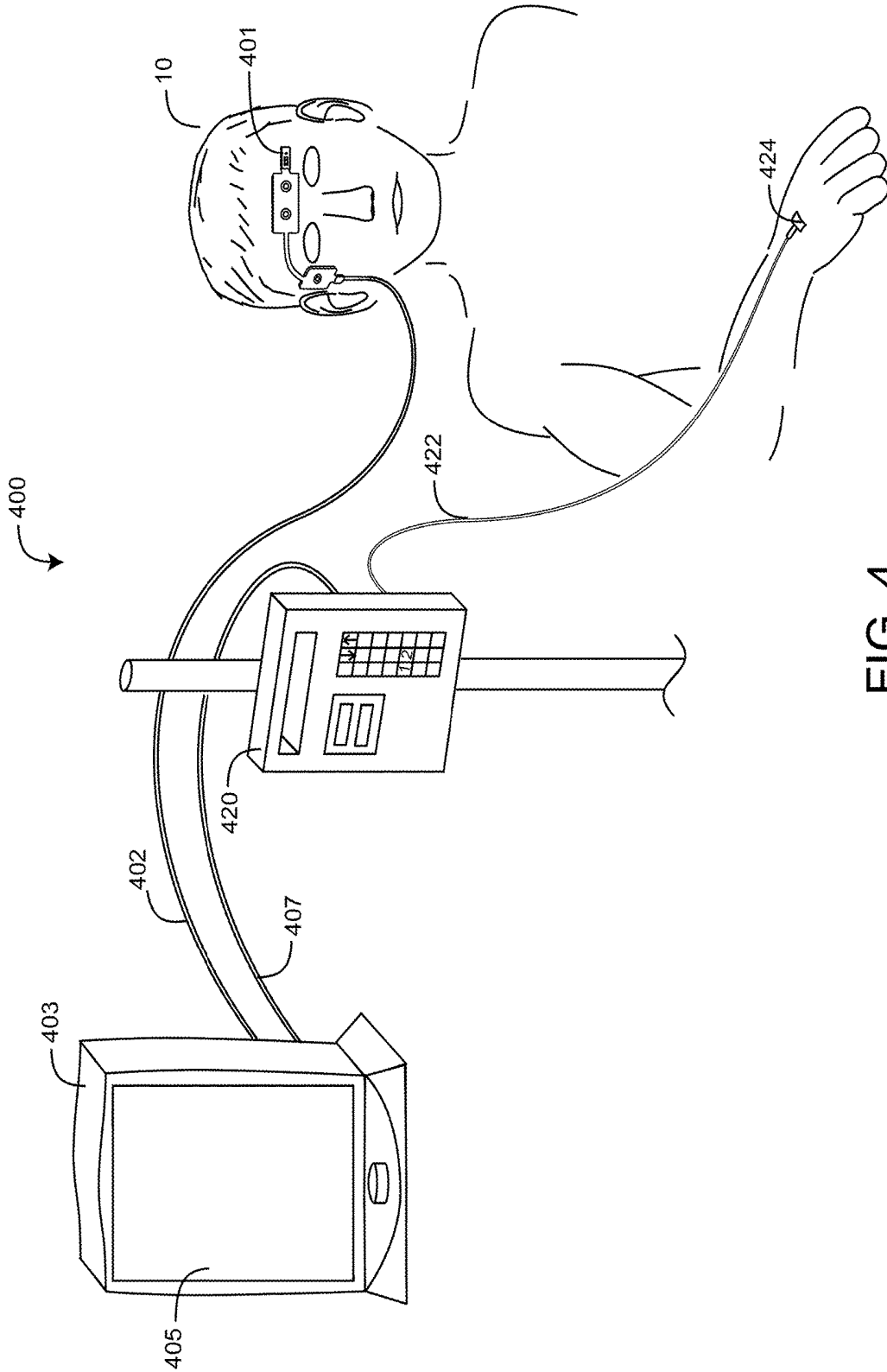

FIG. 4

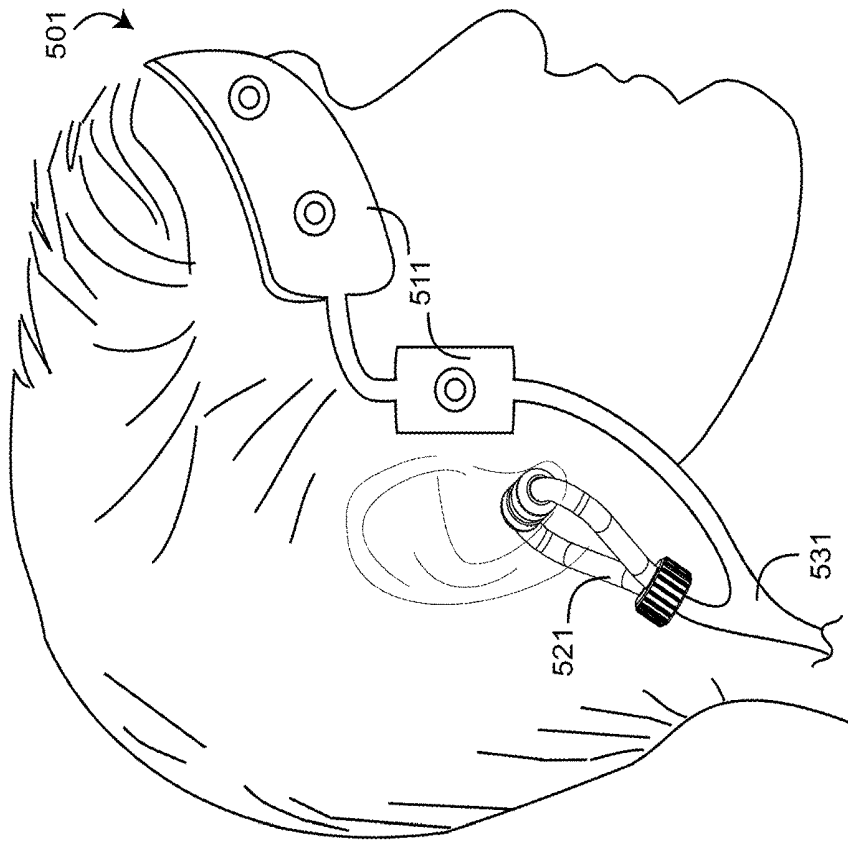

FIG. 5A

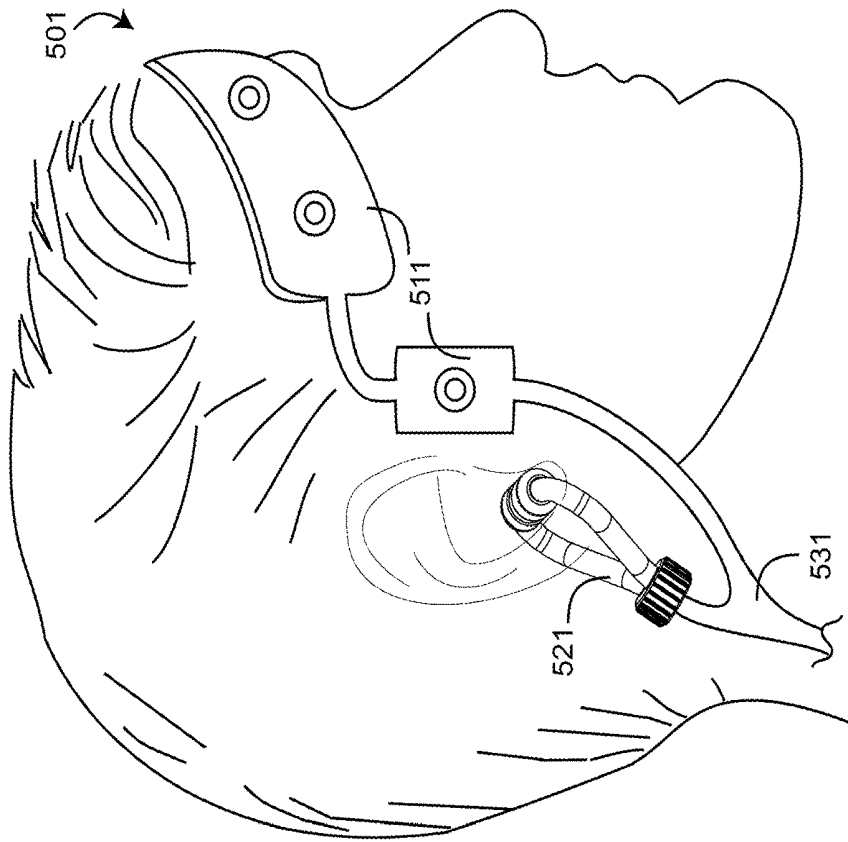

FIG. 5B

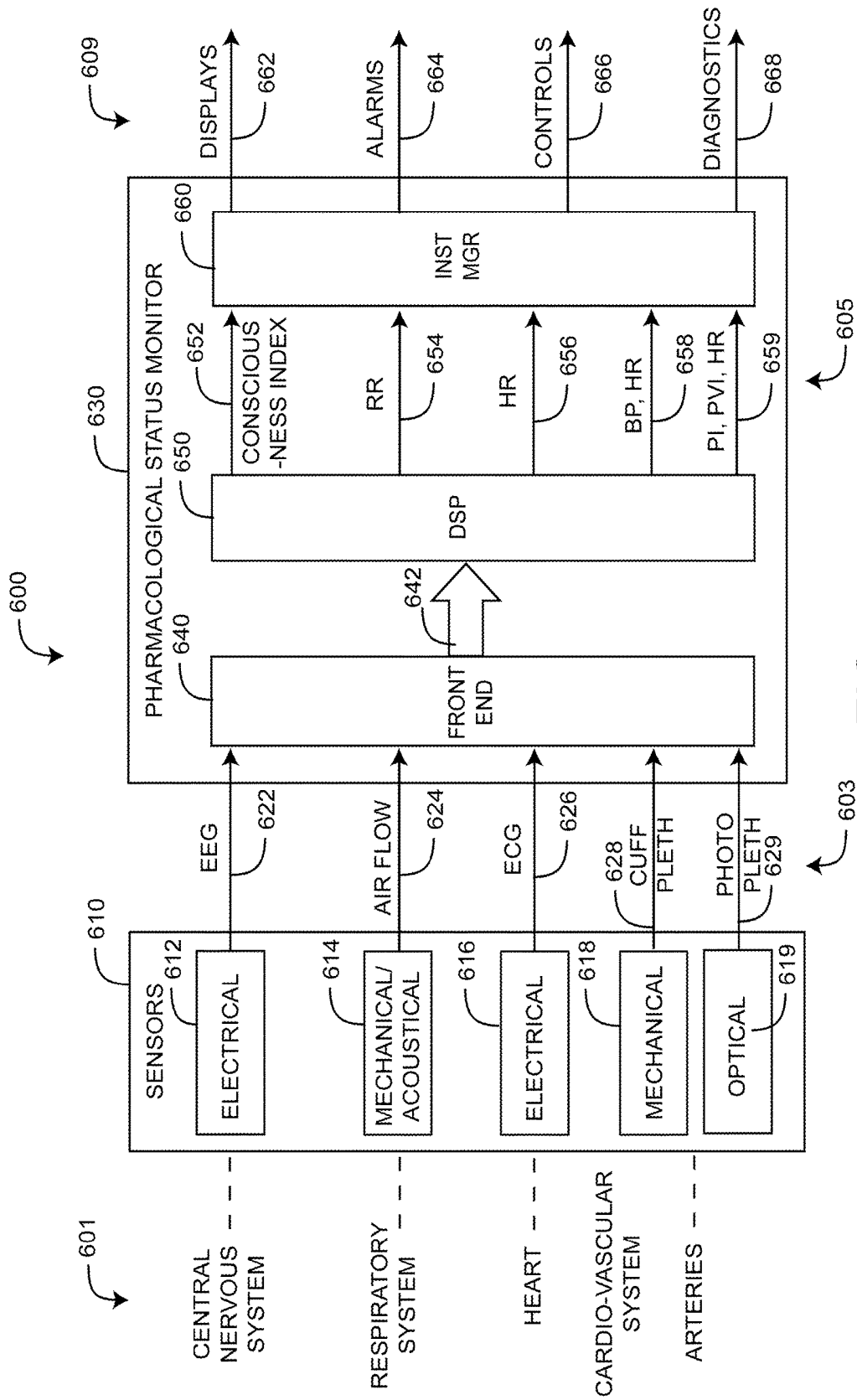

FIG. 6

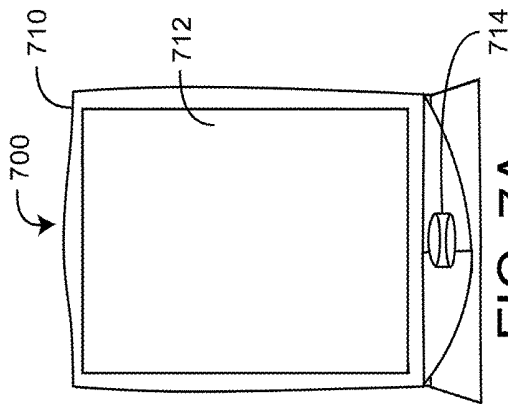

FIG. 7A

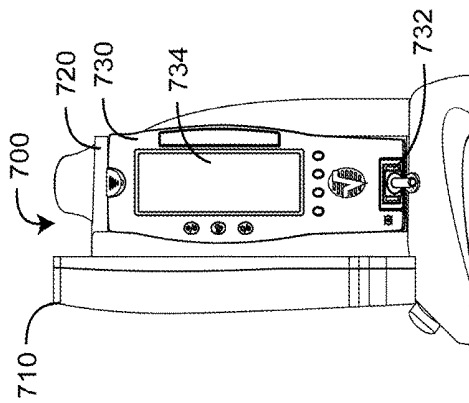

FIG. 7B

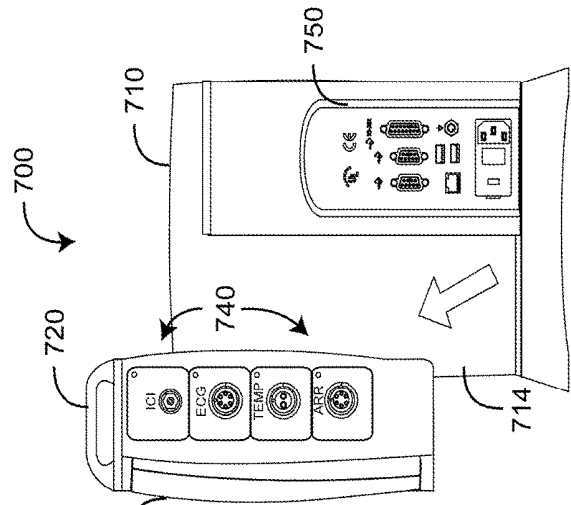

FIG. 7E

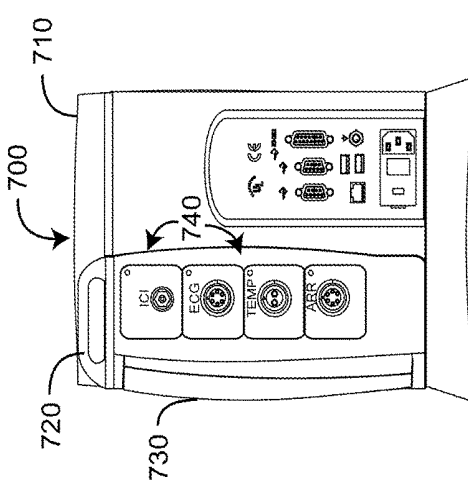

FIG. 7C

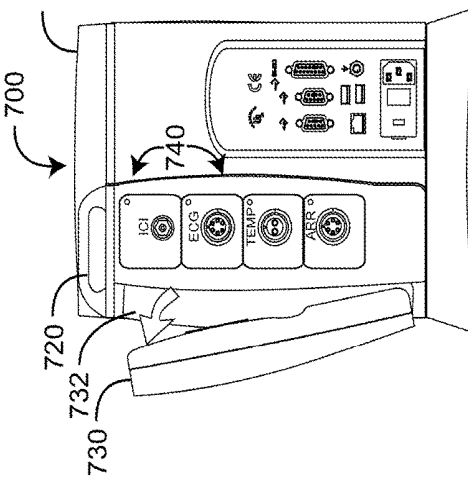

FIG. 7D

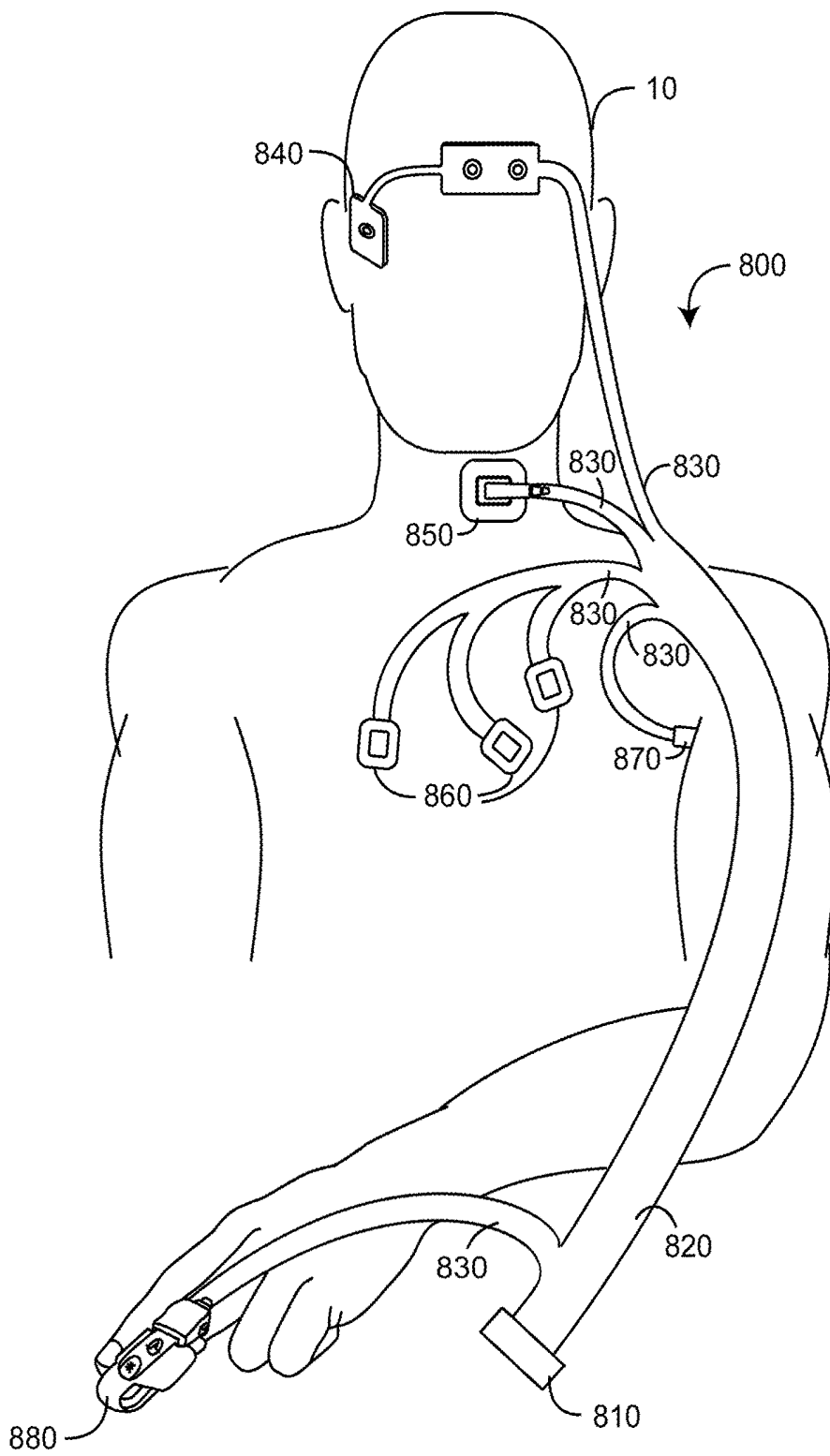

FIG. 8

## OPTICAL-BASED PHYSIOLOGICAL MONITORING SYSTEM

### CROSS-REFERENCE TO RELATED APPLICATIONS

This application is a continuation of U.S. patent application Ser. No. 15/347,190, filed Nov. 9, 2016, and titled "Optical-Based Physiological Monitoring System," which is a continuation of U.S. patent application Ser. No. 14/479,083, filed Sep. 5, 2014, and titled "Optical-Based Physiological Monitoring System," which is a continuation of U.S. patent application Ser. No. 12/885,430, filed Sep. 17, 2010, and titled "Pharmacological Management System," which claims priority benefit under 35 U.S.C. § 119(e) to U.S. Provisional Patent Application No. 61/243,161, filed Sep. 17, 2009, and titled "Pharmacological Management System." The entire disclosure of each of the above items is hereby made part of this specification as if set forth fully herein and incorporated by reference for all purposes, for all that it contains.

Any and all applications for which a foreign or domestic priority claim is identified in the Application Data Sheet as filed with the present application are hereby incorporated by reference under 37 CFR 1.57.

### BACKGROUND

Generation and analysis of an electroencephalogram (EEG) is a widely accepted noninvasive procedure for diagnosing a person's neurological system. For example, an EEG can reflect changes in a brain's cellular function due to insufficient oxygen or drugs, to name a few. An EEG system consists of a bio-potential sensor and corresponding monitor to process, analyze and display an EEG signal and corresponding neurological parameters. A bio-potential sensor responds to the electrical potential difference between at least two well-spaced electrodes, using a separate ground electrode. The biopotential monitor typically displays the EEG waveform and a numerical index that reflects changes in the EEG bandwidth and power.

Generation and analysis of a photoplethysmograph is a widely accepted noninvasive procedure for diagnosing a person's cardiovascular system. For example, a photoplethysmograph can yield the oxygen saturation level of arterial blood, an indicator of a person's oxygen supply. A pulse oximetry system consists of an optical sensor applied to a fleshy tissue site, such as a fingertip, and a corresponding pulse oximetry monitor (pulse oximeter). Using multiple wavelength light emitting diodes and a corresponding detector, the optical sensor measures the light absorption of the pulsatile blood at the tissue site. In particular, the optical sensor is responsive to the instantaneous blood volume as well as the blood constituency. Accordingly, the pulse oximeter typically displays a numerical readout of a person's oxygen saturation and pulse rate along with an audible indication of the person's pulse. The photoplethysmograph waveform may also be displayed.

Conventional pulse oximetry assumes that arterial blood is the only pulsatile blood flow in the measurement site. During patient motion, venous blood also moves, which causes errors in conventional pulse oximetry. Advanced pulse oximetry processes the venous blood signal so as to report true arterial oxygen saturation and pulse rate under conditions of patient movement. Advanced pulse oximetry also functions under conditions of low perfusion (small signal amplitude), intense ambient light (artificial or sun-

light) and electrosurgical instrument interference, which are scenarios where conventional pulse oximetry tends to fail.

Advanced pulse oximetry is described in at least U.S. Pat. Nos. 6,770,028; 6,658,276; 6,157,850; 6,002,952; 5,769,785 and 5,758,644, which are assigned to Masimo Corporation ("Masimo") of Irvine, Calif. and are incorporated by reference herein. Corresponding low noise optical sensors are disclosed in at least U.S. Pat. Nos. 6,985,764; 6,813,511; 6,792,300; 6,256,523; 6,088,607; 5,782,757 and 5,638,818, which are also assigned to Masimo and are also incorporated by reference herein. Advanced pulse oximetry systems including Masimo SET® low noise optical sensors and read through motion pulse oximetry monitors for measuring SpO<sub>2</sub>, pulse rate (PR) and perfusion index (PI) are available from Masimo. Optical sensors include any of Masimo LNOP®, LNCS®, SofTouch™ and Blue™ adhesive or reusable sensors. Pulse oximetry monitors include any of Masimo Rad-8®, Rad-5®, Rad®-5v or SatShare® monitors.

Advanced blood parameter measurement systems are described in at least U.S. Pat. No. 7,647,083, filed Mar. 1, 2006, titled Multiple Wavelength Sensor Equalization; U.S. Pat. No. 7,729,733, filed Mar. 1, 2006, titled Configurable Physiological Measurement System; U.S. Pat. Pub. No. 2006/0211925, filed Mar. 1, 2006, titled Physiological Parameter Confidence Measure and U.S. Pat. Pub. No. 2006/0238358, filed Mar. 1, 2006, titled Noninvasive Multi-Parameter Patient Monitor, all assigned to Masimo Laboratories, Irvine, Calif. (Masimo Labs) and all incorporated by reference herein. Advanced blood parameter measurement systems include Masimo Rainbow® SET, which provides measurements in addition to SpO<sub>2</sub>, such as total hemoglobin (SpHb™), oxygen content (SpOC™) methemoglobin (Sp-Met®), carboxyhemoglobin (SpCO®) and PVI®. Advanced blood parameter sensors include Masimo Rainbow® adhesive, ReSposable™ and reusable sensors. Advanced blood parameter monitors include Masimo Radical-7™, Rad-87™ and Rad-57™ monitors, all available from Masimo. Such advanced pulse oximeters, low noise sensors and advanced blood parameter systems have gained rapid acceptance in a wide variety of medical applications, including surgical wards, intensive care and neonatal units, general wards, home care, physical training, and virtually all types of monitoring scenarios.

### SUMMARY

Depth of consciousness (DOC) is an important physiological assessment during the administration of anesthesia and analgesia drugs. For example, an overdose of anesthesia risks physical impairment or death. An underdose of anesthesia risks "surgical awareness." A DOC index is typically derived by an EEG sensor measurement of electrical activity in the cerebral cortex. Advantageously, the measurement of various cardio-vascular system and respiratory system responses can substitute for or supplement typical central nervous system measures of consciousness, providing improved resolution and accuracy. For example, cardiovascular system and respiratory system parameters responsive to consciousness may include perfusion index (PI), plethysmograph variability index (PVI), heart rate (HR), blood pressure (BP) and respiration rate (RR), to name a few.

Level of pain (LOP) is also an important physiological assessment during anesthesia and analgesia. A LOP index is an advantageous quantization of pain that allows proper dosing of administered drugs. Advantageously, a LOP index

may also be derived from various cardiovascular system and respiratory system parameters, such as those cited above.

Although dissimilar physiological phenomena, there is an important relationship between consciousness and pain for anesthesia and analgesia applications. During anesthesia, it is desirable to ensure that pain is eliminated during apparent unconsciousness. During analgesia, it is desirable for pain to be diminished or eliminated without impinging on consciousness. Accordingly, parameters useful in conjunction with consciousness assessment may be useful in conjunction with pain assessment and vice-a-versa.

A pharmacological management system advantageously provides sensors and processors to measure and analyze both DOC and LOP. Accordingly, a pharmacological management system advantageously senses and analyzes both consciousness and pain related physiological signals so as to generate multidimensional parameters or indexes indicative of both physiological processes.

One aspect of a pharmacological management system comprises sensors, a pharmacological status monitor and a drug administrator. The sensors attach to the patient so as to generate corresponding sensor signals. The pharmacological status monitor is responsive to the sensor signals so as to generate an output indicative of the drug-induced effects of the pharmacological agent on the patient. Further, the monitor output is fed-back to the drug administrator so as to regulate administration of the agent for a desired effect.

In various embodiments, the monitor comprises a hematological processor responsive to an optical sensor signal and a neurological processor responsive to a bio-potential sensor. The hematological processor has a photoplethysmograph input and provides a level of pain output to the pharmacological status monitor. The neurological processor has an EEG input and provides a depth of consciousness output to the pharmacological status monitor. The pharmacological status monitor generates a control output to a drug-infusion pump. The level of pain output is a perfusion index. The pharmacological status monitor generates a combined index related to both depth of consciousness and level of pain.

Another aspect of a pharmacological management system is inputting sensor signals derived from a patient and calculating physiological parameters accordingly. The sensor signals provide measurements of physiological systems. Physiological parameters are calculated from the sensor signals. The parameters are operated on to generate monitor outputs, which are indicative of levels of both consciousness and pain.

In various embodiments, a first sensor signal is utilized to generate a consciousness index and a second sensor signal is utilized to generate a perfusion index. Cues are displayed to indicate a patient with a stable or unstable physiological condition. Outputs control drug-infusion equipment or medical gas ventilation equipment. Patient wellness is diagnosed.

A further aspect of a pharmacological management system measures physiological parameters derived from at least some of a patient's central nervous system, respiratory system and cardio-vascular system so as to assess level of pain and depth of consciousness during the administration of anesthetic and analgesic agents. The pharmacological management system comprises sensors in communications with a patient so as to generate sensor signals and a monitor front-end in communications with the sensor signals so as to generate digitized sensor signals. A signal processor is in communications with the front-end so as to generate physiological parameters. The signal processor derives an elec-

trical-based depth of consciousness (DOC) indicator from an electrical one of the sensors in communications with the patient's central nervous system and a pleth-based level of pain (LOP) indicator from an optical one of the sensors in communications with the patient's cardio-vascular system. An instrument manager generates a monitor output in response to a combination of the DOC indicator and the LOP indicator.

In various embodiments, a drug administrator administers a pharmacological agent to the patient and is responsive to the monitor output. The LOP indicator is responsive to a perfusion index (PI) parameter or a plethysmograph variability index (PVI) parameter. The monitor output comprises an electronic signal to the drug administrator that affects the dose of pharmacological agent. The monitor output also comprises a combined display of LOP and DOC.

#### BRIEF DESCRIPTION OF THE DRAWINGS

FIG. 1 is a general block diagram of pharmacological management system;

FIG. 2 is a block diagram of a pharmacological management system embodiment responsive to electrical and optical sensors so as to measure consciousness and pain;

FIG. 3 illustrates a pharmacological management system configured for anesthesia applications;

FIG. 4 illustrates a pharmacological management system configured for analgesia applications;

FIGS. 5A-B are illustrations of combination sensor embodiments for measuring both consciousness and pain;

FIG. 6 is a detailed block diagram of a pharmacological management system embodiment;

FIGS. 7A-E are illustrations of a pharmacological status monitor embodiment responsive to various sensors; and

FIG. 8 is an illustration of a multi-sensor embodiment for measuring level of pain and depth of consciousness.

#### DETAILED DESCRIPTION

FIG. 1 generally illustrates a pharmacological management system **100** having a drug administrator **110** that provides a pharmacological agent **114** to a patient **10** and a pharmacological status monitor **120** responsive to corresponding drug-induced effects **20**. Pharmacological agents **114** may be, as examples, anesthesia or analgesia drugs. For anesthesia applications, the desired effect **20** may be general anesthesia or various levels of sedation. The drug administrator **110** may vary from a healthcare provider manually administering drugs to an automatic or semi-automatic machine such as a drug infusion device or medical gas inhalation device. The drug administrator may be responsive to external controls **112**, such as manual inputs or electronic signals.

As shown in FIG. 1, drug-induced effects **20** in the patient **10** may include hypnosis **21**, analgesia **23**, amnesia **25**, paralysis **27** and reflex suppression **29**. Hypnosis **21** produces unconsciousness; analgesia **23** blocks the conscious sensation of pain; amnesia **25** prevents memory formation; paralysis **27** prevents unwanted movement or muscle tone; and reflex suppression **29** prevents exaggerated autonomic reflexes. For general anesthesia, some or all of these drug-induced effects **20** may be the goal. For low-level sedation, the goal may be to achieve some effects **20** while suppressing others. For pain reduction, analgesia **23** is the goal along with minimization of other drug-induced effects **20**.

Also shown in FIG. 1, the pharmacological management system **100** advantageously assists healthcare providers to

achieve the above-stated goals, among others. Sensors (not shown) attached to the patient 10 provide biological signals 122 to the pharmacological status monitor 120. The monitor 120 processes these signals 122 and generates outputs 124 indicative of the effects 20 of administered pharmacological agents 114. The outputs 124 may be displays, alarms, controls or indicators, for example. The outputs 124 may also provide manual or automatic feedback 126 to the drug administrator 110 so as to regulate administration of the agent 114 for the desired effects 20.

FIG. 2 illustrates a pharmacological management system 200 having sensors 201 in communications with a patient 10. The sensors 201 generate sensor waveforms 202 to corresponding monitors 203. The monitors 203 process the waveforms 202 so as to calculate parameters that alone or in combination are indicative of the pharmacological status of the patient 10. In one embodiment, sensors 201 include an electrical (biopotential) sensor 210 placed proximate the head so as to generate an EEG waveform 212 and an optical sensor 220 placed on a fleshy tissue site so as to generate a photoplethysmograph 214.

A neurological monitor 230 processes the EEG waveform 212 to generate a first parameter 232 related to depth of consciousness (DOC). In an embodiment, the first parameter 232 is a dimensionless index that reflects the level of activity of the cerebral cortex. In a particular embodiment, the first parameter 232 is a Bispectral Index™ (BIS) proprietary to Aspect Medical Systems, Inc., Norwood, Mass. (“Aspect”), and the neurological processor 230 is a BIS module also proprietary to Aspect. In another particular embodiment, the first parameter 232 is a Patient State Index™ (PSI) proprietary to Hospira, Inc., Lake Forest, Ill. (“Hospira”), and the neurological processor 230 is a SEDLine monitor or module, also proprietary to Hospira.

A hematological monitor 240 processes the photoplethysmograph (pleth) waveform 214 to generate at least one second parameter 242. In an embodiment, the second parameter is a level of pain (LOP) index. In an embodiment, the second parameter is a pleth-based DOC index providing improved resolution and accuracy in determining DOC compared to only an EEG-based DOC index. In an embodiment, the second parameter 242 is a Perfusion Index (PI) or a Plethysmograph Variability Index (PVI) proprietary to Masimo Corporation, Irvine, Calif. (“Masimo”) or both, and the hematological processor 240 is any of various monitors or modules available from Masimo, such as described above. PI may change dramatically in response to sympathetic changes in vasoconstriction or vasodilation of peripheral vessels reflective of consciousness or pain. PI comprises a relative indication of pulse strength at a monitoring site. For example, PI may be defined as the ratio of a pleth AC value to its DC value, or the percentage of pulsatile signal to non-pulsatile signal. PVI is described in U.S. patent application Ser. No. 11/952,940 filed Dec. 7, 2007 titled Plethysmograph Variability Index, assigned to Masimo and incorporated by reference herein.

As shown in FIG. 2, in an embodiment the electrical sensor 210 is any of various EEG sensors having multiple biopotential electrodes for placement across various head sites for detection of electrical signals originating in the brain. In an embodiment, the optical sensor 220 is any of various blood parameter sensors having LED emitters and at least one photodiode detector for placement at various fleshy tissue sites for detection of pulsatile blood flow and in particular the measurement of optical properties thereof, such as absorption, reflection, transmission and transflex-

tance to name a few. In an embodiment, the optical sensor 220 is any of various optical sensors available from Masimo, such as described above.

Further shown in FIG. 2, in an embodiment, and optical sensor may comprise a combination or multi-sensor 250 that provides both EEG and photoplethysmograph waveforms, such as described with respect to FIGS. 5 and 8, below. In an embodiment, the hematological and neurological monitors may comprise a combination or multi-parameter monitor 260 having hematological and neurological processing plug-ins, modules or similar technology, such as described with respect to FIGS. 6 and 7, below.

FIG. 3 illustrates a pharmacological management system 300 configured for anesthesia applications having a sensor 301 attached to a patient 10, a pharmacological status monitor 303 and a sensor cable 302 providing sensor signal communications between the sensor 301 and the monitor 303. In an embodiment, the sensor 301 provides multiple physiological signals to the monitor 303, which derives at least two different measures of consciousness or at least a measurement of consciousness and a measurement of pain. In an embodiment, these physiological signals are EEG and photoplethysmograph signals. In an embodiment, the monitor 303 calculates both a DOC index and PI from the EEG and plethysmograph signals and displays these parameters on the monitor display 305 accordingly.

As shown in FIG. 3, in a mixed display embodiment 310 a DOC parameter is displayed numerically adjacent a LOP parameter displayed as a color. For example, the DOC parameter may be an index, such as BIS, displayed as a dimensionless number. The LOP parameter may be, for example, PI, displayed as a green, yellow or red indicator depending on a preset range of high, medium and low PI values. The low PI value range being set so as to indicate the occurrence of significant vasoconstriction in response to pain or measurable vasodilation in response to increasing depth of consciousness. In a numerical display embodiment 320, DOC and LOP are displayed as proximately located numerical readouts, such as a DOC index and a perfusion index (PI). In a graphical display embodiment 330, DOC and LOP are separately indicated as trends, such as a DOC index trend and a PI trend. The monitor may also calculate a combined index related to consciousness or pain or both. Other individual or combined parameter displays include any of various readouts, graphs, charts or indicators in any of various single or multiple colors. The above monitoring and display embodiments advantageously assist an anesthesiologist or other administrator of drugs to titrate anesthesia based upon either multiple indicators of DOC or on indicators of DOC and LOP. This dual monitoring of pain and consciousness during administration of anesthesia drugs advantageously increases monitor responsiveness to under or over dosing of anesthesia.

FIG. 4 illustrates a pharmacological management system 400 configured for analgesia applications, such as patient controlled analgesia (PCA). In particular, the pharmacological management system 400 has a sensor 401 attached to a patient 10, a pharmacological status monitor 403 and a sensor cable 402 providing sensor signal communications between the sensor 401 and the monitor 403. Further, the monitor 403 generates control signals via a control cable 407 to the drug-infusion pump 420. The drug-infusion pump 420 administers drugs to the patient 10 via a tube 422 and an IV 424. A patient-actuated controller (not shown) generates drug administration requests to the drug-infusion pump 420 via cable or wireless communications. In this manner, the pump 420 responds to patient perceived pain levels. In

particular, the patient 10 actuates the controller, such as via a button press, so as to signal the drug-infusion pump 420 to administer a measured analgesia dose. The pump 420 enables or pauses patient-controlled dosing according to monitor 403 signals transmitted via the control cable 407. These control signals are responsive to monitor calculated DOC and LOP related parameters. Further, these parameters are displayed on a monitor screen 405, such as described with respect to FIG. 3, above.

The sensor 401 provides physiological signals to the monitor 403 related to depth of consciousness (DOC) or level of pain (LOP). In an embodiment, these physiological signals are EEG and photoplethysmograph signals. The monitor 403 calculates DOC, LOP or a combination consciousness and pain parameters from the EEG and plethysmograph signals and processes those parameters to generate control outputs 407 to the drug-infusion pump 420. In this manner, the administration of analgesia is controlled not only according to the patient's perceived pain level, but also according to a physiologically indicated pain level and to avoid consciousness impairment. In a particular embodiment, LOP is indicated by a perfusion index (PI), as described above, and PCA is paused or enabled according to a rising or falling PI, respectively, or according to a DOC index, or both.

FIGS. 5A-B illustrate combination sensors, which provide inputs to a pharmacological status monitor having both hematological and neurological signal processors, such as described with respect to FIG. 2, above. FIG. 5A illustrates a combination sensor 500 applied to the forehead and temple areas of a person. The sensor 500 includes an electrical or more specifically a biopotential sensor 510 and an optical sensor 520. A patient cable 530 connects the sensor to one or more monitoring devices (not shown), such as described with respect to FIGS. 7A-E, below. The biopotential sensor 510 may be an EEG sensor for depth of consciousness monitoring, as described above. The optical sensor 520 may be a pulse oximetry reflectance sensor for consciousness or pain monitoring via perfusion index (PI) or other blood parameter, also as described above. The patient cable 530 may connect near the person's temple, as shown, or as an alternative near the person's forehead. The biopotential sensor 510 and optical sensor 520 may share a common connector 540 or each sensor may have a dedicated patient cable connector. Combination EEG and pulse oximetry sensors are described in U.S. Pat. No. 6,934,570, issued Aug. 23, 2005, titled Physiological Sensor Combination and incorporated by reference herein.

FIG. 5B illustrates a combination sensor 501 applied to the forehead, temple and ear concha areas of a person. In one embodiment, the sensor 501 includes a biopotential sensor 511, an optical sensor 521 and a cable 531 that connects the sensor 501 to one or more monitoring devices (not shown). The biopotential sensor 511 may be an EEG sensor for depth of consciousness monitoring, as described above. The optical sensor 521 may be a pulse oximetry transmissive sensor for level of pain monitoring via perfusion index (PI) or other blood parameter, also as described above. In a particular embodiment, the optical sensor 521 is a "Y"-clip ear sensor that flexes so as to slide over the ear periphery and onto either side of the concha. An emitter and detector located at opposite clip ends can then transmit multiple wavelength light into the concha tissue and detect that light after attenuation by pulsatile blood flow within the concha tissue. Optical ear sensors are described in U.S. Provisional Patent App. No. 61/152,964, filed Feb. 16, 2009, titled Ear Sensor and incorporated by reference herein.

FIG. 6 illustrates a pharmacological management system 600 embodiment having multiple sensors 610 in communication with a pharmacological status monitor 630. The sensors 610 are responsive to various physiological systems 601 so as to generate various sensor signals 603. A pharmacological status monitor 630 derives physiological parameters 605 from the sensor signals 603 and operates on the parameters 605 to generate monitor outputs 609. The measured physiological systems 601 include one or more of the central nervous system, including the brain; the respiratory system, including the lungs; and the cardio-vascular system, including the heart and arteries. The sensors 610 may include electrical sensors 612, 616, such as bio-potential sensors that generate EEG 622 and ECG 626 signals in response to brain or heart activity, respectively. The sensors 610 may also include mechanical, acoustical, temperature or humidity sensors 614, to name a few, that directly or indirectly measure the inspired or expired air flow 624 from the lungs. Sensors 610 include mechanical sensors 618 that measure arterial blood pressure 628. Sensors 610 further include optical sensors 619 that measure arterial blood flow or volume 629, according to instantaneous light absorption.

Also shown in FIG. 6, parameters 605 are any derived measurements indicative of consciousness or pain or both. Parameters 605 may include a consciousness index 652 derived from an EEG signal 622, such as described with respect to FIG. 2, above. Parameters 605 may also include a perfusion index (PI) 659 indicative of pain and derived from a photoplethysmograph signal 629, also described with respect to FIG. 2, above. Other pain indicative parameters may include respiration rate (RR) 654 derived from a respiratory air flow signal 624; heart rate (HR) 656, 658, 659 derived from an ECG 626, cuff plethysmograph 628 or photoplethysmograph 629; and blood pressure (BP) 658 derived from a pressure plethysmograph 628.

In addition, FIG. 6 shows outputs 609 including displays 662, alarms 664, controls 666 and diagnostics 668. Alarms 664 may be, for example, audible or visual alerts warning of critical conditions that need immediate attention. Controls 666 may be any of various electrical or electronic, wired or wireless or mechanical outputs, to name a few, capable of interfacing with and affecting another device. As examples, controls 666 may interface with drug-infusion equipment or medical gas ventilation equipment, as described above. Diagnostics, including wellness indices, may be audible or visual cues indicating a patient with a stable or unstable physiological condition. Visual cues may be any of various digital readouts, bar graphs, trend graphs, color indicators and the like. Audible cues may be any of various sounds or tones, whether intermittent or continuous or constant or varying in volume.

As shown in FIG. 6, the monitor 630 has a sensor front end 640, one or more digital signal processors (DSP) 650 and one or more instrument managers 660. In an embodiment, the sensor front end 640 may have one or more of various preamps, signal conditioning and analog-to-digital conversion (ADC) that amplify, filter and digitize the sensor signals 603 so as to output digital data channels 642 to a DSP 650. In an embodiment, the DSP 650 comprises a processing device, such as one based on the Super Harvard ARCHitecture ("SHARC") commercially available from Analog Devices or any other of a wide variety of data and/or signal processors capable of executing programs for determining physiological parameters from input data. In particular, the DSP 650 includes program instructions capable of receiving

multiple channels of data **642** from the sensor front end **640**, each channel of which relates to one or more sensor signals **603**.

Also shown in FIG. 6, the instrument manager **660** may comprise one or more microcontrollers controlling system management, including, for example, translation and communications of calculated parameter data **605** to various outputs **609**. The instrument manager **660** may also act as a watchdog circuit by, for example, monitoring and controlling the activity of the DSP **650**.

FIG. 7A-E illustrate a pharmacological status monitor **700** embodiment capable of inputting signals from a wide range of sensors and of deriving a wide range of physiological parameters therefrom including DOC and LOP parameters, such as BIS and PI described with respect to FIG. 2, above, and others described with respect to FIG. 6, above. The pharmacological status monitor **700** has a docking station **710** including a display **712**, a removable shuttle **720**, a removable handheld **730** and a combination of plug-in modules **740**. The docking station **710** has a shuttle port **714** that allows the shuttle station **720** to dock. The shuttle station **720** has a handheld port **732** that allows the handheld monitor **730** to dock. Accordingly, the modular patient monitor **700** has three-in-one functionality including a handheld **730**, a handheld **730** docked into a shuttle station **720** as a handheld/shuttle combination and a handheld/shuttle docked into a docking station **710**. When docked, the three modules of handheld **730**, shuttle **720** and docking station **710** function as one unit. The handheld **730** docked into the shuttle module **720** functions independently of the docking station **710** and expands the handheld parameter capability to the ability to measure all parameters available to the shuttle **720**. The docking station **710**, in turn, provides the shuttle **720** or handheld/shuttle combination with a large color display **712** and trim knob control **714** in addition to a power supply/communications module **750** having ports for wireless and hardwired communications, Internet access and printers. In an embodiment, the handheld monitor **730** incorporates blood parameter measurement technologies including SpO<sub>2</sub>, PI, HbCO, HbMet, and Hbt, and the shuttle station **720** incorporates non-blood parameters, such as intelligent cuff inflation (**101**) for blood pressure measurements, acoustic respiration rate (ARR), ECG and EEG to name a few. A multi-parameter monitor is described in U.S. patent Ser. No. 11/903,746, filed Sep. 24, 2007, titled Modular Patient Monitor and incorporated by reference herein.

FIG. 8 illustrates an integrated multi-sensor **800** advantageously configured to provide multiple physiological parameter measurements to a pharmacological status monitor **700** (FIGS. 7A-E) via a single connector and interconnected patient cable (not shown). This eliminates the difficulties of a large number of cables and cumbersome connectors when multiple sensors are placed on various areas of a person. In particular, the multi-sensor **800** has a connector **810** in communications with a trunk **820**, which fans out to multiple branches **830**, each of which terminates in a sensor **840**, **850**, **860**, **870**, **880**. In an embodiment, the multi-sensor allows measurement of perfusion index (PI) via a pulse oximetry sensor **880** placed on a finger; skin temperature via a thermistor **870** located under an arm; heart rate (HR) via an ECG sensor **860** placed on the chest area; respiration rate (RR) via an acoustic sensor **850** located on the neck to detect airway sounds; and a consciousness index via an EEG sensor **840** placed on the head area.

In other embodiments, other multiple parameter sensors provide sensor inputs to a pharmacological status monitor. A

sensor providing both optical and acoustic inputs for blood parameters and acoustic parameters, such as discussed above, in addition to cerebral oximetry, oxygen supply and metabolism among other parameters is described in U.S. Provisional Patent App. No. 61/350,673 titled Opticoustic Sensor filed Jun. 2, 2010, assigned to Masimo and incorporated by reference herein. In particular, the cerebral parameters measured by the opticoustic sensor disclosed therein may provide further indications of LOP and DOC.

A pharmacological management system has been disclosed in detail in connection with various embodiments. These embodiments are disclosed by way of examples only and are not to limit the scope of the claims that follow. One of ordinary skill in the art will appreciate many variations and modifications.

What is claimed is:

1. A physiological monitoring method comprising:

receiving, from a non-invasive optical sensor, a first sensor signal responsive to physiological characteristics of a patient;

receiving, from a bio-potential sensor, a second sensor signal responsive to physiological characteristics of the patient;

receiving, from an additional sensor, at least a third sensor signal;

determining, by a processor and based on the first sensor signal, a first physiological parameter indicative of a level of pain of the patient;

determining, by the processor and based on the second sensor signal, a second physiological parameter indicative of a depth of consciousness of the patient;

determining, by the processor and based on at least one of the first sensor signal, the second sensor signal, or the third sensor signal, one or more additional physiological parameters indicative of at least one of the level of pain of the patient or the depth of consciousness of the patient, wherein the one or more additional physiological parameters include at least one of: an ECG, a respiration rate, a respiratory air flow, a heart rate, or a blood pressure; and

determining, by the processor and based on the first physiological parameter, the second physiological parameter, and the one or more additional physiological parameters, a combined index indicative of both the level of pain and the depth of consciousness of the patient.

2. The physiological monitoring method of claim 1, wherein the first physiological parameter comprises a perfusion index.

3. The physiological monitoring method of claim 2, wherein the second physiological parameter comprises an EEG.

4. The physiological monitoring method of claim 3, wherein the combined index is further determined based on an ECG of the patient.

5. The physiological monitoring method of claim 4, wherein the ECG is further indicative of the level of pain of the patient.

6. The physiological monitoring method of claim 5 further comprising:

determining, by the processor and based on the first physiological parameter and the ECG of the patient, a combined indication of the level of pain of the patient.

7. The physiological monitoring method of claim 1, wherein the non-invasive optical sensor, the bio-potential sensor, and the additional sensor are in communication with a monitor via a single cable.

- 8.** The physiological monitoring method of claim **1** further comprising:  
outputting feedback to a drug administrator configured to provide a pharmacological agent to the patient, wherein the feedback is outputted to the drug administrator so as to regulate administration of the pharmacological agent for a desired effect, wherein the feedback includes the combined index indicative of both the level of pain and the depth of consciousness of the patient. 5
- 9.** The physiological monitoring method of claim **1** further comprising:  
providing, by the processor, a control output to at least one of drug-infusion equipment or medical gas ventilation equipment based at least in part on the combined index indicative of both the level of pain and the depth of consciousness of the patient. 10 15
- 10.** The physiological monitoring method of claim **1** further comprising:  
generating, by the processor, a displayable output including a visual indication of the combined index indicative of both the level of pain and the depth of consciousness of the patient. 20
- 11.** The physiological monitoring method of claim **10**, wherein the visual indication comprises at least one of a number, a color, or a graph. 25

\* \* \* \* \*

专利名称(译)	基于光学的生理监测系统		
公开(公告)号	<a href="#">US10398320</a>	公开(公告)日	2019-09-03
申请号	US15/802172	申请日	2017-11-02
[标]申请(专利权)人(译)	梅西莫股份有限公司		
申请(专利权)人(译)	Masimo公司		
当前申请(专利权)人(译)	Masimo公司		
[标]发明人	KIANI MASSI JOE E OREILLY MICHAEL		
发明人	KIANI, MASSI JOE E. O'REILLY, MICHAEL		
IPC分类号	A61B5/00 A61B5/0205 A61B5/021 A61B5/08 A61B5/087 A61B5/024 A61B5/0476 A61B5/0402 A61B5/1455		
CPC分类号	A61B5/7278 A61B5/1455 A61B5/4821 A61B5/0476 A61B5/7282 A61B5/743 A61B5/0402 A61B5/0205 A61B5/4839 A61B5/024 A61B5/0816 A61B5/087 A61B5/021		
优先权	14/497083 2016-12-13 US 61/243161 2009-09-17 US		
其他公开文献	US20180214031A1		
外部链接	<a href="#">Espacenet</a>		

摘要(译)

公开了一种非侵入性的基于光学的生理监测系统。在一个实施例中，所述非侵入性，基于光学的生理监测系统包括发射器，所述发射器被配置为将光发射到活体患者的组织部位中；检测器，被配置为在组织部位衰减之后检测发射的光并响应于检测到的光输出传感器信号；处理器，配置为基于传感器信号确定指示患者疼痛程度的第一生理参数。

