



US009055870B2

(12) United States Patent
Meador et al.**(10) Patent No.: US 9,055,870 B2**
(45) Date of Patent: Jun. 16, 2015**(54) PHYSIOLOGICAL PARAMETER
MEASURING PLATFORM DEVICE
SUPPORTING MULTIPLE WORKFLOWS****(75) Inventors: Daniel Thomas Meador**, Portland, OR (US); **Janalee Esler**, Portland, OR (US); **Michele Marie Donovan**, Auburn, NY (US)**(73) Assignee: Welch Allyn, Inc.**, Skaneateles Falls, NY (US)**(*) Notice:** Subject to any disclaimer, the term of this patent is extended or adjusted under 35 U.S.C. 154(b) by 31 days.**(21) Appl. No.: 13/440,840****(22) Filed: Apr. 5, 2012****(65) Prior Publication Data**

US 2013/0267793 A1 Oct. 10, 2013

(51) Int. Cl.**G01N 33/48** (2006.01)
A61B 5/0205 (2006.01)
A61B 5/00 (2006.01)
G06F 19/00 (2011.01)
A61B 5/01 (2006.01)
A61B 5/021 (2006.01)
A61B 5/024 (2006.01)
A61B 5/08 (2006.01)
A61B 5/1455 (2006.01)**(52) U.S. Cl.**CPC **A61B 5/0205** (2013.01); **A61B 5/746** (2013.01); **A61B 5/0015** (2013.01); **A61B 5/01** (2013.01); **A61B 5/021** (2013.01); **A61B 5/02438** (2013.01); **A61B 5/0816** (2013.01); **A61B 5/14551** (2013.01); **A61B 2560/0431** (2013.01); **G06F 19/327** (2013.01)**(58) Field of Classification Search**CPC G06F 19/327
USPC 702/19
See application file for complete search history.**(56) References Cited**

U.S. PATENT DOCUMENTS

5,140,519 A 8/1992 Friesdorf et al.
D366,460 S 1/1996 Jorensen
5,701,894 A 12/1997 Cherry et al.
D427,574 S 7/2000 Sawada et al.
6,219,046 B1 4/2001 Thomas et al.
D454,139 S 3/2002 Feldcamp
6,364,834 B1 4/2002 Reuss et al.
6,398,727 B1 6/2002 Bui et al.
6,416,471 B1 7/2002 Kumar et al.
6,469,717 B1 10/2002 Wineke et al.
D465,226 S 11/2002 Friedman
D468,322 S 1/2003 Walker et al.
6,535,714 B2 3/2003 Melker et al.
6,658,276 B2 12/2003 Kianl et al.
6,675,031 B1 1/2004 Porges et al.
6,707,476 B1 3/2004 Hochstedler
6,783,573 B2 8/2004 Richardson
6,828,910 B2 12/2004 VanRyzin et al.D510,582 S 10/2005 Hoang
D523,440 S 6/2006 Hernandez et al.
D525,982 S 8/2006 Suzuki
D527,011 S 8/2006 Bixler
7,124,366 B2 10/2006 Foreman et al.
7,134,994 B2 11/2006 Alpert et al.
D545,829 S 7/2007 Fletcher
7,336,187 B2 2/2008 Hubbard, Jr. et al.
D575,296 S 8/2008 Fairfield
7,409,399 B2 8/2008 Miyamoto
D576,634 S 9/2008 Clark et al.
D579,456 S 10/2008 Chen et al.
7,433,827 B2 10/2008 Rosenfeld et al.
D586,818 S 2/2009 Luck
D590,413 S 4/2009 Bhat et al.
D590,414 S 4/2009 Bhat et al.
D592,156 S 5/2009 Drews et al.
D592,675 S 5/2009 Bhat et al.
7,565,616 B2 7/2009 Buchmann
D598,923 S 8/2009 Chen et al.
D598,929 S 8/2009 Bhat et al.
D599,358 S 9/2009 Hoefnagels et al.
D599,398 S 9/2009 Laidlaw et al.
D603,416 S 11/2009 Poling et al.
D607,463 S 1/2010 Krieter et al.
D608,366 S 1/2010 Matas
7,662,106 B2 2/2010 Daniels et al.

(Continued)

FOREIGN PATENT DOCUMENTS

CN 1356783 A 7/2002
CN 1649538 A 8/2005

(Continued)

OTHER PUBLICATIONS

International Search Report and Written Opinion in PCT/US2013/031582 mailed Jun. 28, 2013, 11 pages.

Adams, A.P., Breathing System Disconnections, Br. J. Anaesth, 1994, vol. 73, No. 1, pp. 46-54.

Capnography: An Objective Tool for Assessing Respiratory Status, Physio-Control, Inc., 2008, pp. 1-8.

Colin Prodigy Press-Mate Prodigy II® Portable Vital Signs Monitors, DRE, Copyright 2009, accessed at: http://www.dremed.com/catalog/product_info.php/products_id/1181; 5 pages.Fingertip Pulse Oximeter SPO2 Monitor Oxygen Oximeter; Copyright 1995-2010, accessed at: http://74.125.45.132/search?q=cache:ANfHne9je7gJ:cgi.ebay.com.sg/ws/eBayISAPI.dll%3FViewItem%26item%3D260412542031+*Fingertip+Pulse+Oximeter+SPO2+Monitor+Oxygen+Oximeter*&cd=2&hl=en&ct=clnk&gl=us; 6 pages.

(Continued)

Primary Examiner — Jerry Lin

(74) Attorney, Agent, or Firm — Merchant & Gould P.C.

(57) ABSTRACT

A device obtains a series of measurements of a physiological parameter of one or more patients. The device displays a monitoring workflow home screen when the device is operating within a monitoring workflow. The device displays a non-monitoring workflow home screen when the device is operating within a non-monitoring workflow. The device displays a continuous workflow home screen when the device is operating within a continuous workflow. The monitoring workflow home screen, the non-monitoring workflow home screen, and the continuous workflow home screen are each different.

17 Claims, 35 Drawing Sheets

(56)

References Cited

U.S. PATENT DOCUMENTS

D612,860	S	3/2010	Tarara et al.	2008/0058614	A1	3/2008	Banet et al.
RE41,236	E	4/2010	Seely	2008/0072896	A1	3/2008	Setzer et al.
D614,634	S	4/2010	Nilsen	2008/0077026	A1	3/2008	Banet et al.
7,765,479	B2	7/2010	Goodwin et al.	2008/0086691	A1	4/2008	Hopermann et al.
7,774,060	B2	8/2010	Westenskow et al.	2008/0103375	A1	5/2008	Kiani
7,782,302	B2	8/2010	Lee et al.	2008/0115081	A1	5/2008	Sankaravadelu et al.
7,787,946	B2	8/2010	Stahmann et al.	2008/0155406	A1	6/2008	Naka
7,810,497	B2	10/2010	Pittman et al.	2008/0208812	A1	8/2008	Quoc et al.
D632,699	S	2/2011	Judy et al.	2008/0229248	A1	9/2008	Fagans et al.
7,895,527	B2	2/2011	Zaleski et al.	2008/0249377	A1	10/2008	Molducci et al.
D635,150	S	3/2011	Sykes et al.	2008/0249801	A1	10/2008	Zaleski
D637,603	S	5/2011	Godgart	2008/0281168	A1	11/2008	Gibson et al.
7,937,134	B2	5/2011	Uber et al.	2008/0281637	A1	11/2008	Matz
D640,264	S	6/2011	Fujii	2008/0318529	A1	12/2008	Harb
7,967,759	B2*	6/2011	Couvillon, Jr. 600/529	2009/0005651	A1	1/2009	Ward et al.
D643,043	S	8/2011	Loken	2009/0054743	A1	2/2009	Stewart
8,001,967	B2	8/2011	Wallace	2009/0054798	A1	2/2009	Varney et al.
8,020,558	B2	9/2011	Christopher	2009/0131761	A1	5/2009	Moroney, III et al.
D646,689	S	10/2011	Ulliot	2009/0132588	A1	5/2009	Mahesh et al.
8,028,701	B2	10/2011	Al-Ali	2009/0143652	A1	6/2009	Warburton et al.
8,038,593	B2	10/2011	Friedman	2009/0149927	A1	6/2009	Kneuer et al.
8,046,705	B2	10/2011	Hunleth et al.	2009/0158415	A1	6/2009	Dillon
8,055,514	B2	11/2011	Elsholz	2009/0240116	A1	9/2009	Bluth
8,078,983	B2	12/2011	Davis	2009/0240193	A1	9/2009	Mensingher et al.
D652,051	S	1/2012	Judy	2009/0241958	A1	10/2009	Baker, Jr.
D656,153	S	3/2012	Imamura	2009/0275805	A1	11/2009	Lane et al.
D656,157	S	3/2012	Khan	2009/0275810	A1	11/2009	Ayers et al.
D656,946	S	4/2012	Judy	2009/0282340	A1	11/2009	Akaike et al.
D657,368	S	4/2012	Magee	2009/0306482	A1	12/2009	Davis et al.
D658,196	S	4/2012	Wood et al.	2009/0306488	A1	12/2009	Al-Ali et al.
D658,667	S	5/2012	Cho	2009/0312648	A1	12/2009	Zhang et al.
D664,971	S	8/2012	Lee et al.	2010/0050075	A1	2/2010	Thorson et al.
D664,984	S	8/2012	Lee et al.	2010/0069004	A1	3/2010	Bioebaum
D666,625	S	9/2012	Gilmore et al.	2010/0094096	A1	4/2010	Petruzzelli et al.
D667,837	S	9/2012	Magee	2010/0097380	A1	4/2010	Daniels et al.
D667,838	S	9/2012	Magee et al.	2010/0218766	A1	9/2010	Milne
D674,401	S	1/2013	Trumble et al.	2010/0274098	A1	10/2010	Belford et al.
D675,218	S	1/2013	Arnold et al.	2010/0324380	A1	12/2010	Perkins et al.
D676,863	S	2/2013	Ho Kushner et al.	2011/0010621	A1	1/2011	Wallaert et al.
D676,864	S	2/2013	Velasco et al.	2011/0015502	A1	1/2011	Peyser
D688,685	S	8/2013	Rhee et al.	2011/0071420	A1	3/2011	St. Pierre et al.
D689,899	S	9/2013	Lee et al.	2011/0169644	A1	7/2011	Muhsin et al.
D695,781	S	12/2013	Edwards et al.	2011/0205577	A1	8/2011	Mori et al.
8,732,604	B2	5/2014	Okamoto et al.	2011/0209707	A1	9/2011	Terhark
2002/0054141	A1	5/2002	Yen et al.	2011/0227739	A1	9/2011	Gilham et al.
2002/0078097	A1	6/2002	Chen et al.	2011/0245630	A1	10/2011	St. Pierre et al.
2002/0126137	A1	9/2002	Kaestner, Jr.	2011/0246565	A1	10/2011	Irwin et al.
2002/0177758	A1	11/2002	Schoenberg et al.	2011/0276338	A1	11/2011	Warner et al.
2003/0060727	A1	3/2003	Kline	2011/0290250	A1	12/2011	Olson et al.
2003/0135087	A1	7/2003	Hickle et al.	2011/0313301	A1	12/2011	Lane et al.
2004/0002874	A1	1/2004	Shaffer et al.	2012/0000470	A1	1/2012	Milne et al.
2004/0088199	A1	5/2004	Childress et al.	2012/0016251	A1	1/2012	Zhang et al.
2004/0111045	A1	6/2004	Sullivan et al.	2012/0048090	A1	3/2012	Etter et al.
2005/0114374	A1	5/2005	Juszkiewicz et al.	2012/0095778	A1	4/2012	Gross et al.
2005/0229110	A1	10/2005	Gegner et al.	2012/0096367	A1	4/2012	DelloStritto et al.
2005/0288571	A1	12/2005	Perkins et al.	2012/0110444	A1	5/2012	Li et al.
2006/0149597	A1	7/2006	Powell et al.	2012/0117099	A1	5/2012	Gross
2006/0200009	A1	9/2006	Wekell et al.	2012/0215075	A1	8/2012	Surace et al.
2006/0228096	A1	10/2006	Hoshino et al.	2012/0296183	A1	11/2012	Kinsley et al.
2006/0229557	A1	10/2006	Fathallah et al.	2013/0151285	A1	6/2013	McLaren et al.
2006/0247948	A1	11/2006	Ellis et al.	2013/0265327	A1	10/2013	Vann et al.
2007/0000494	A1	1/2007	Banner et al.	2013/0267792	A1	10/2013	Petersen et al.
2007/0067005	A1*	3/2007	Schatz et al. 607/59	2013/0267861	A1	10/2013	Vassallo et al.
2007/0150810	A1	6/2007	Katz et al.	2013/0268283	A1	10/2013	Vann et al.
2007/0156456	A1	7/2007	McGillin et al.	2013/0311926	A1	11/2013	Keegan et al.
2007/0167173	A1	7/2007	Halcrow et al.	2014/0040429	A1	2/2014	Irwin et al.
2007/0167694	A1	7/2007	Causevic et al.	2014/0098209	A1	4/2014	Neff
2007/0174079	A1	7/2007	Kraus	2014/0108041	A1	4/2014	Bechtel et al.
2007/0185390	A1	8/2007	Perkins et al.	2014/0135588	A1	5/2014	Al-Ali et al.
2007/0203744	A1	8/2007	Scholl				
2007/0215157	A1	9/2007	Straw				
2007/0276261	A1	11/2007	Banet et al.				
2008/0021379	A1	1/2008	Hickle				
2008/0055074	A1	3/2008	Gao et al.				
2008/0058609	A1	3/2008	Garibaldi et al.				

FOREIGN PATENT DOCUMENTS

CN	101069638	A	11/2007
EP	0707824	A2	4/1996
EP	2093683	A2	8/2009
GB	2409951	A	7/2005
JP	10091687	A	4/1998
JP	03682617	B2	8/2005
JP	2010015193	A	1/2010

(56)

References Cited

FOREIGN PATENT DOCUMENTS

WO	0126021	4/2001
WO	0189362	5/2001
WO	2006-076498 A2	7/2006
WO	2010102069 A2	9/2010
WO	2011001302 A1	1/2011

OTHER PUBLICATIONS

Handheld Pulse Oximeter PM-60A, Contec Medical System Co. Ltd., Jul. 31, 2009; accessed at: <http://www.tradeindia.com/selloffer/1858593/Handheld-Pulse-Oximeter-PM-60A.html>; 5 pages.

International Search Report and Written Opinion in PCT/US2010/048450 dated Apr. 12, 2011, 9 pages.

mCare 300 Vital Signs Monitor, Spacelabs Medical, Inc., Copyright 2006, 4 pages.

Multiple Vital Signs from One Non-invasive Sensor, Starr™ Life Sciences Corp., Copyright 2009, accessed at: <http://www.star-rlifesciences.com/mouseox.html>; 1 page.

Nag et al., Wireless E-jacket ofr Multiparameter Biophysical Monitoring and Telemedicine Applications, Medial Devices and Biosensors, 2006, 3rd IEEE/EMBS International Summer School, Sep. 4-6, 2006, pp. 40-44.

NTIA Handheld Pulse Oximeter, Frontline Systems; Dec. 31, 2009, accessed at: <http://www.tradeindia.com/fp385774/NTIA-Handheld-Pulse-Oximeter.html>; 3 pages.

O'Donoghue et al., Design and Implementation of a Framework for Monitoring Patients in Hospitals Using Wireless Sensors in Ad Hoc configuration, Engineering in Medicine and Biology Society, EMBS '06, 28th Annual International Confernece of the IEEE, vol., No., Aug. 30, 2006-Sep. 3, 2006, pp. 6449-6452.

Ultraview DM3—Dual Mode Vital Signs Monitor, Spacelabs Healthcare, Copyright 2010, 4 pages.

U.S. Appl. No. 12/751,579, filed Mar. 31, 2010.

U.S. Appl. No. 12/751,602, filed Mar. 31, 2010.

U.S. Appl. No. 61/243,872, filed Sep. 18, 2009.

U.S. Appl. No. 29/353,090, filed Dec. 31, 2009.

Al-Qutayri et al.; Framework for Secure Wireless Health monitoring and remote Access System, Inderscience Enterprises Ltd. copyright 2010, 19 pages.

International Search Report and Written Opinion in PCT/US2013/031486 mailed Jun. 28, 2013, 10 pages.

International Search Report and Written Opinion in PCT/US2013/031458 mailed Jun. 28, 2013, 10 pages.

Kozlovsky et al.; Network and Service Management and Diagnostics Solution of a Remote Patient Monitoring System, IEEE copyright 2011, 4 pages.

Lamberti et al.; Ubiquitous Real-Time Monitoring of Critical-Care Patients in Intensive Care Units, IEEE copyright 2003, 4 pages.

Panorama™ Central Station, Surgical Product Guide copyright 2011, 2 pages.

Zhao et al.; A Portable, Low-Cost, Batter-Powered Wireless Monitoring System for Obtaining Varying Physiologic Parameters from Multiple Subjects, IEEE copyright 2006, 4 pages.

International Search Report and Written Opinion in PCT/US2013/031342 mailed Jun. 24, 2013, 12 pages.

Portable Patient Monitors, Welch Allyn, Copyright 2005-2006 Med-Direct, Copyright 2005-2006, accessed at: <http://www.meddirect.co.nz/Product.aspx?ProductId=3476>; 1 page.

Station—Dictionary.com, [online], retrieved on Sep. 2, 2014, Retrived from, <URL:<http://dictionary.reference.com/browse/station>>, 4 pages.

U.S. Appl. No. 29/417,592, filed Apr. 5, 2012.

U.S. Appl. No. 29/417,611, filed Apr. 5, 2012.

* cited by examiner

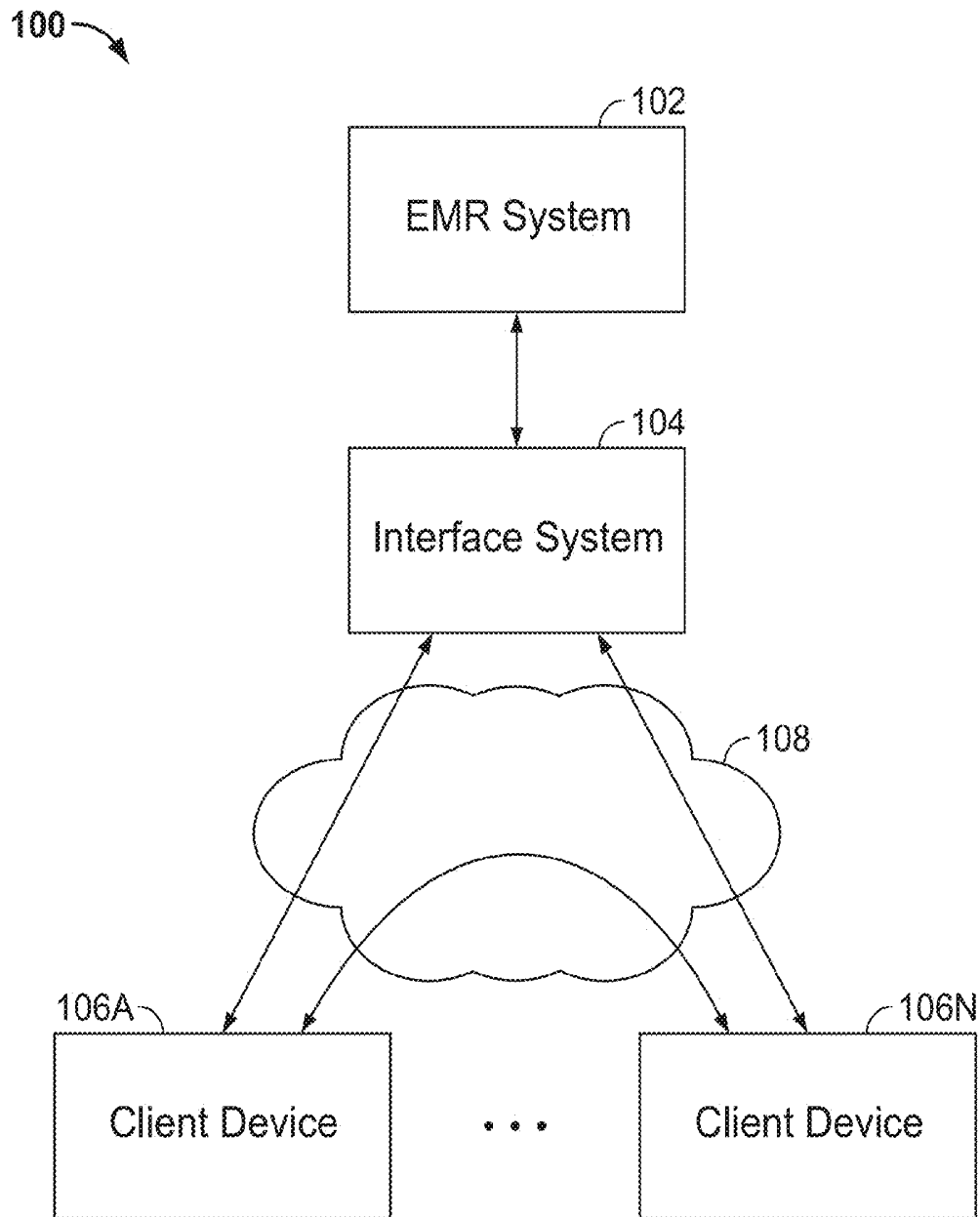

FIG. 1

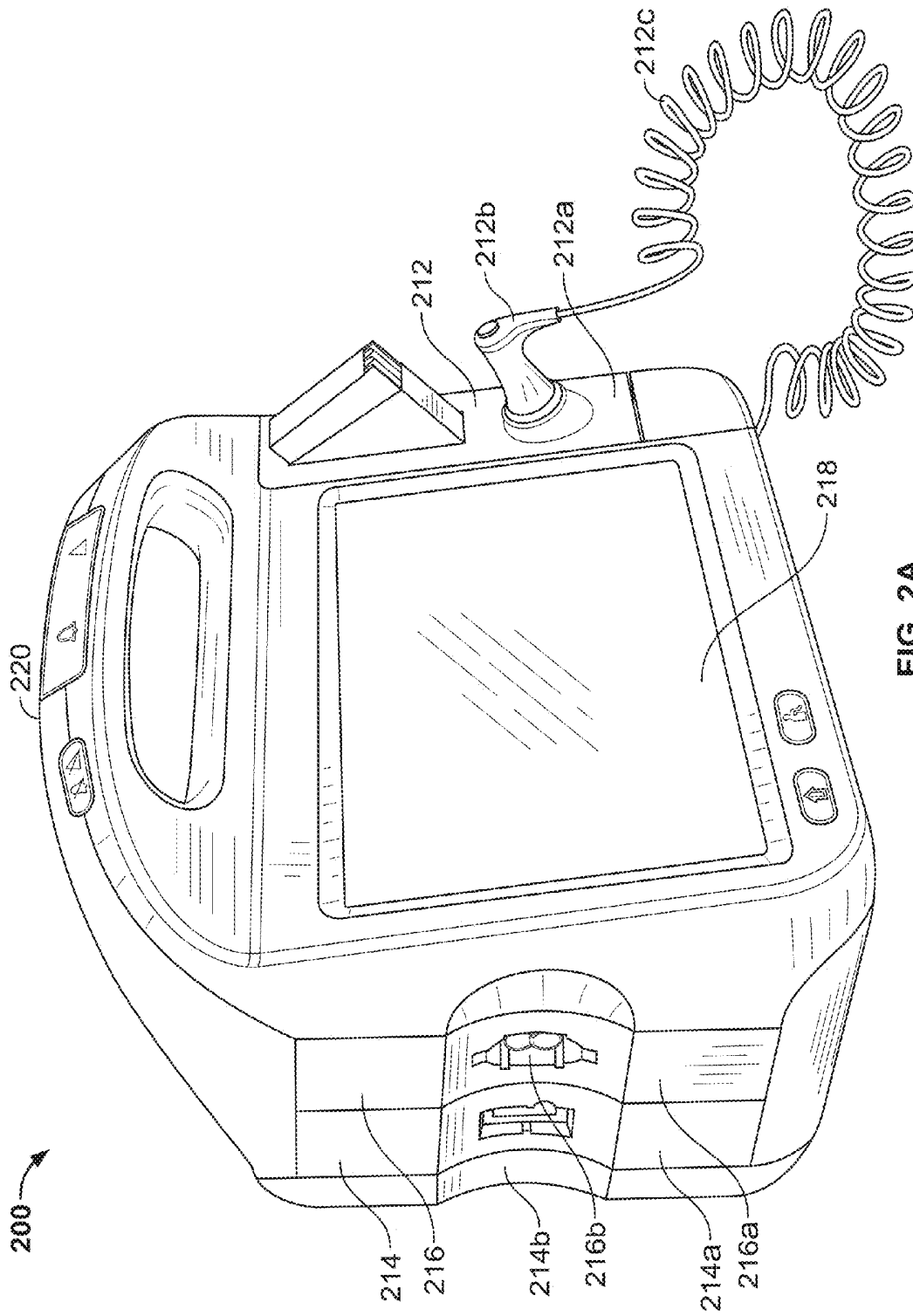

FIG. 2A

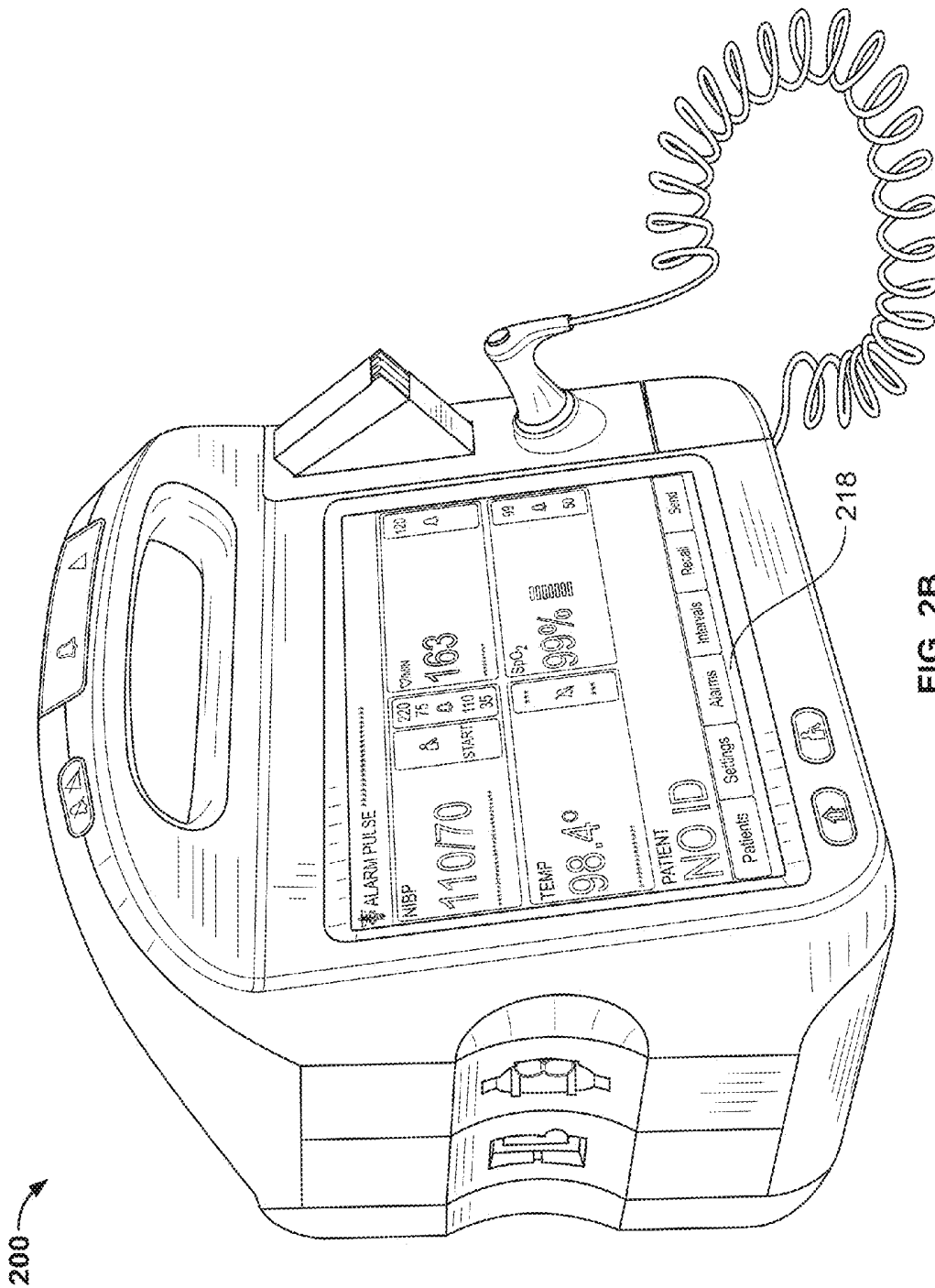

FIG. 2B

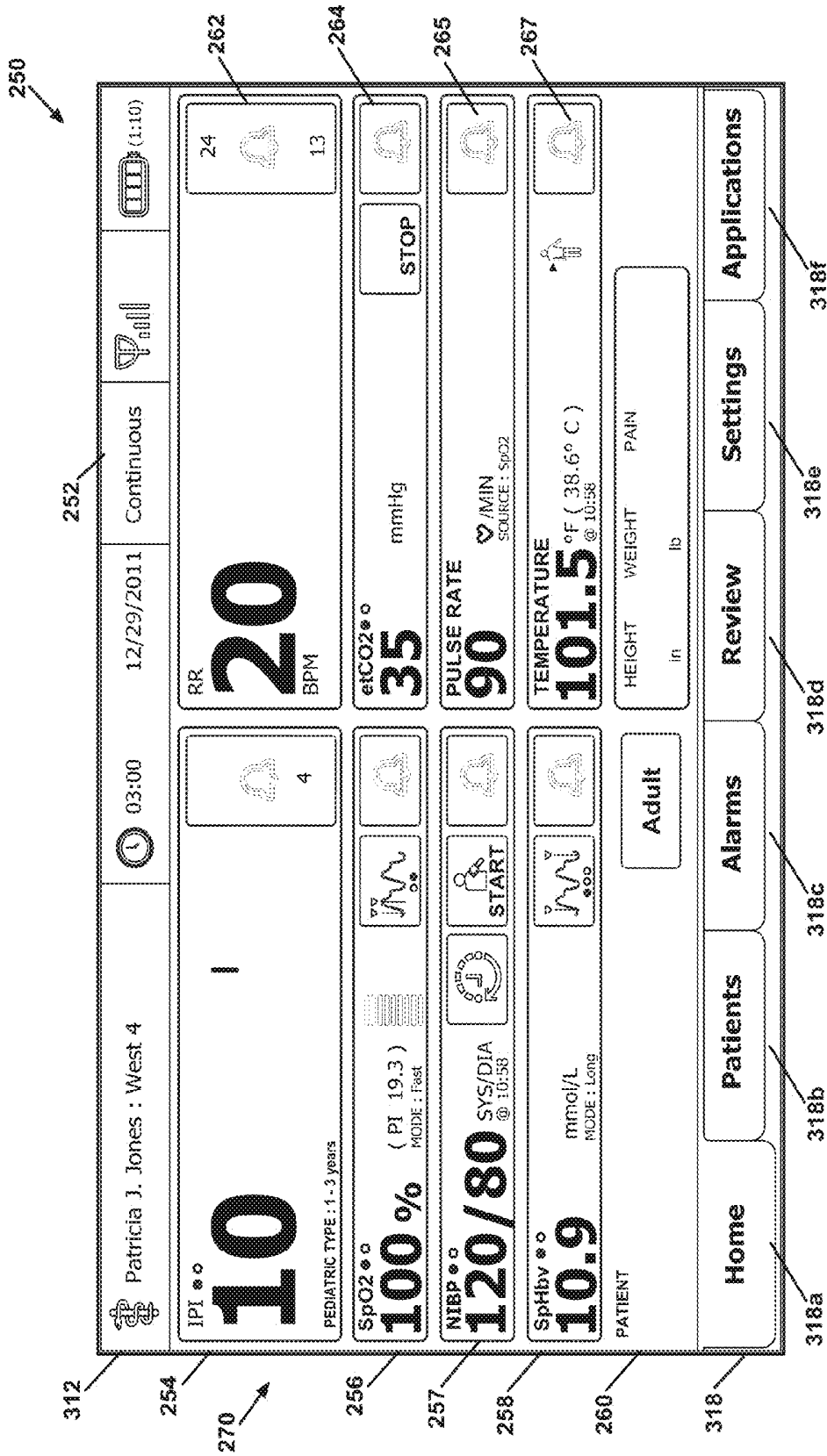

FIG. 3A

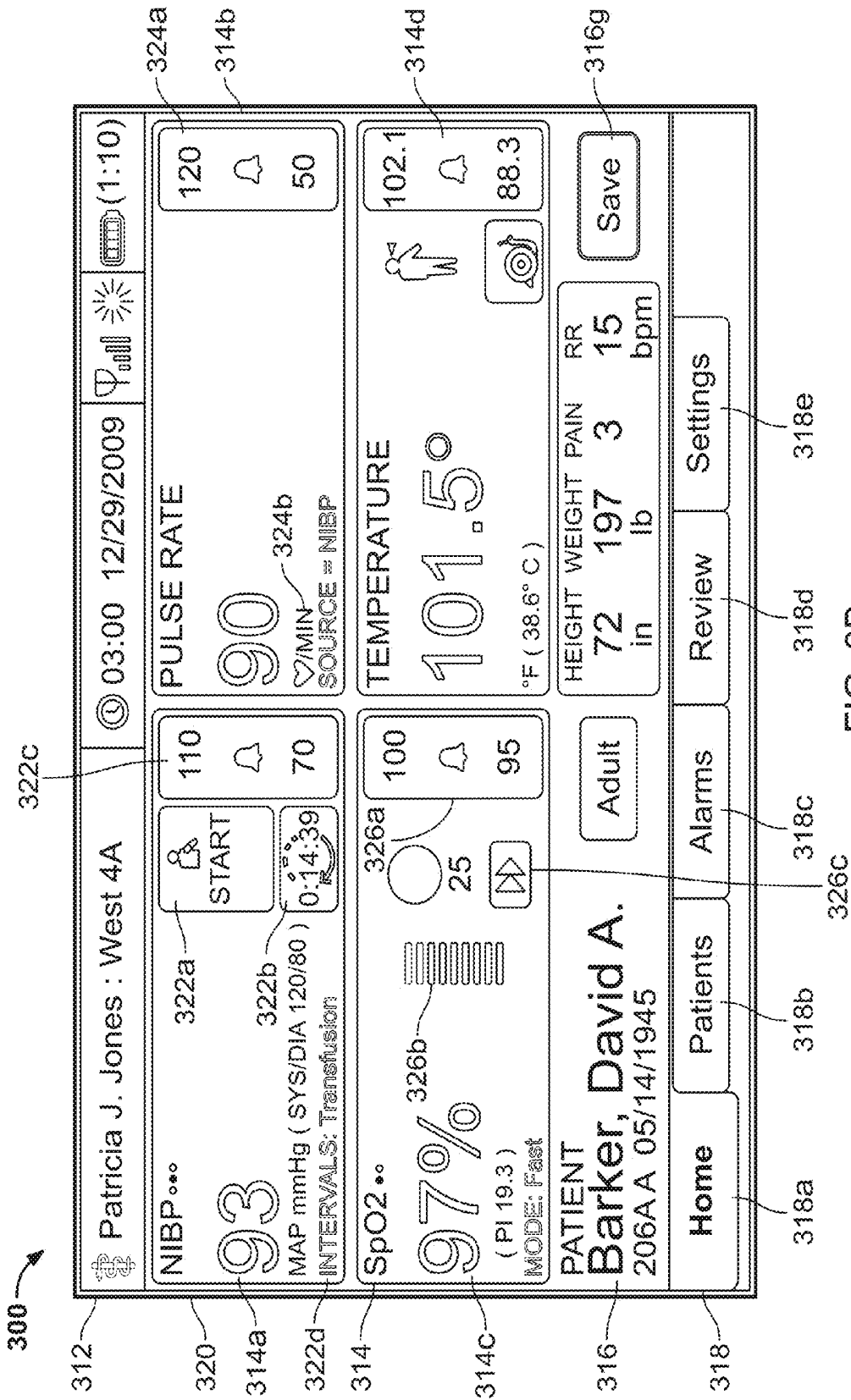

FIG. 3B

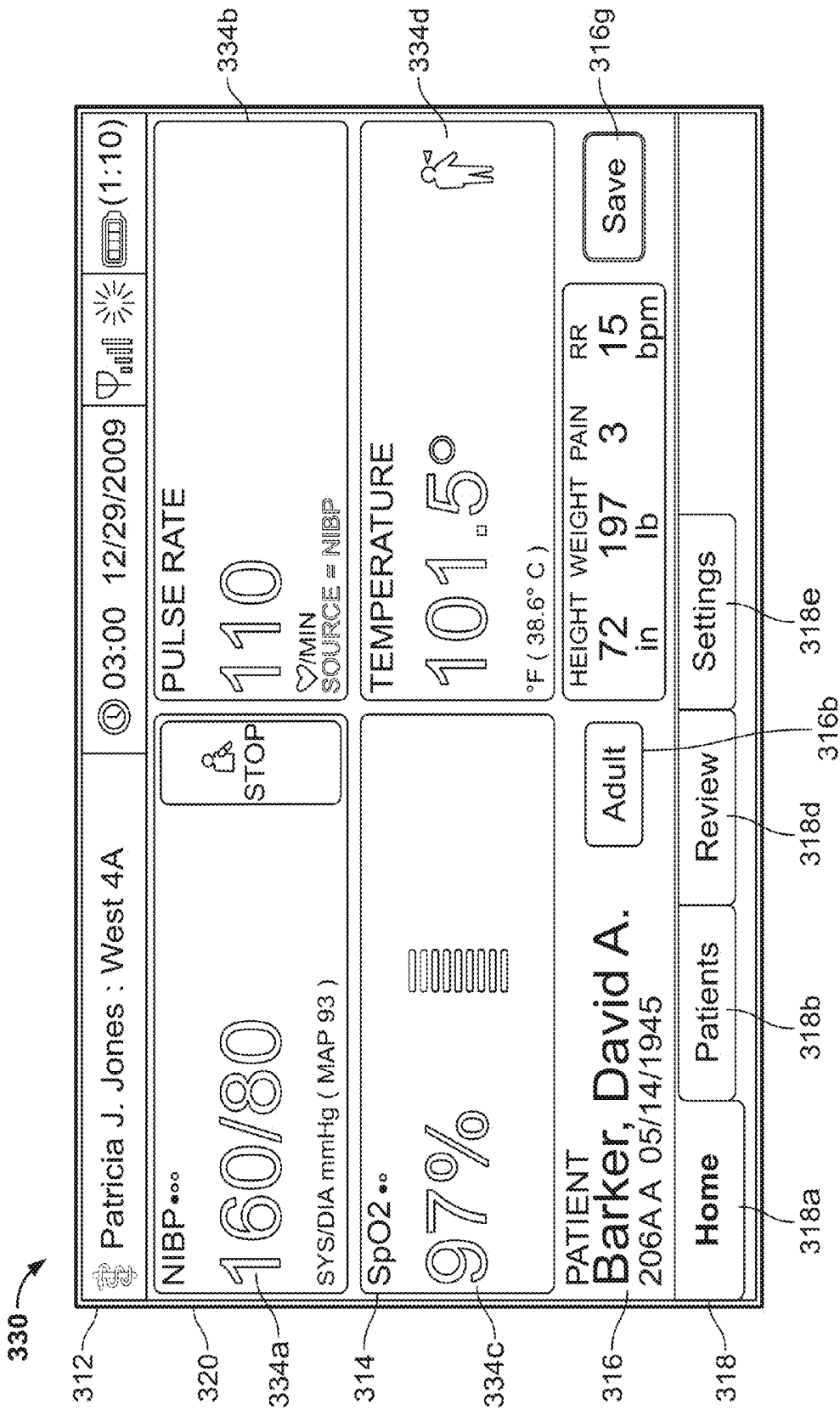

FIG. 3C

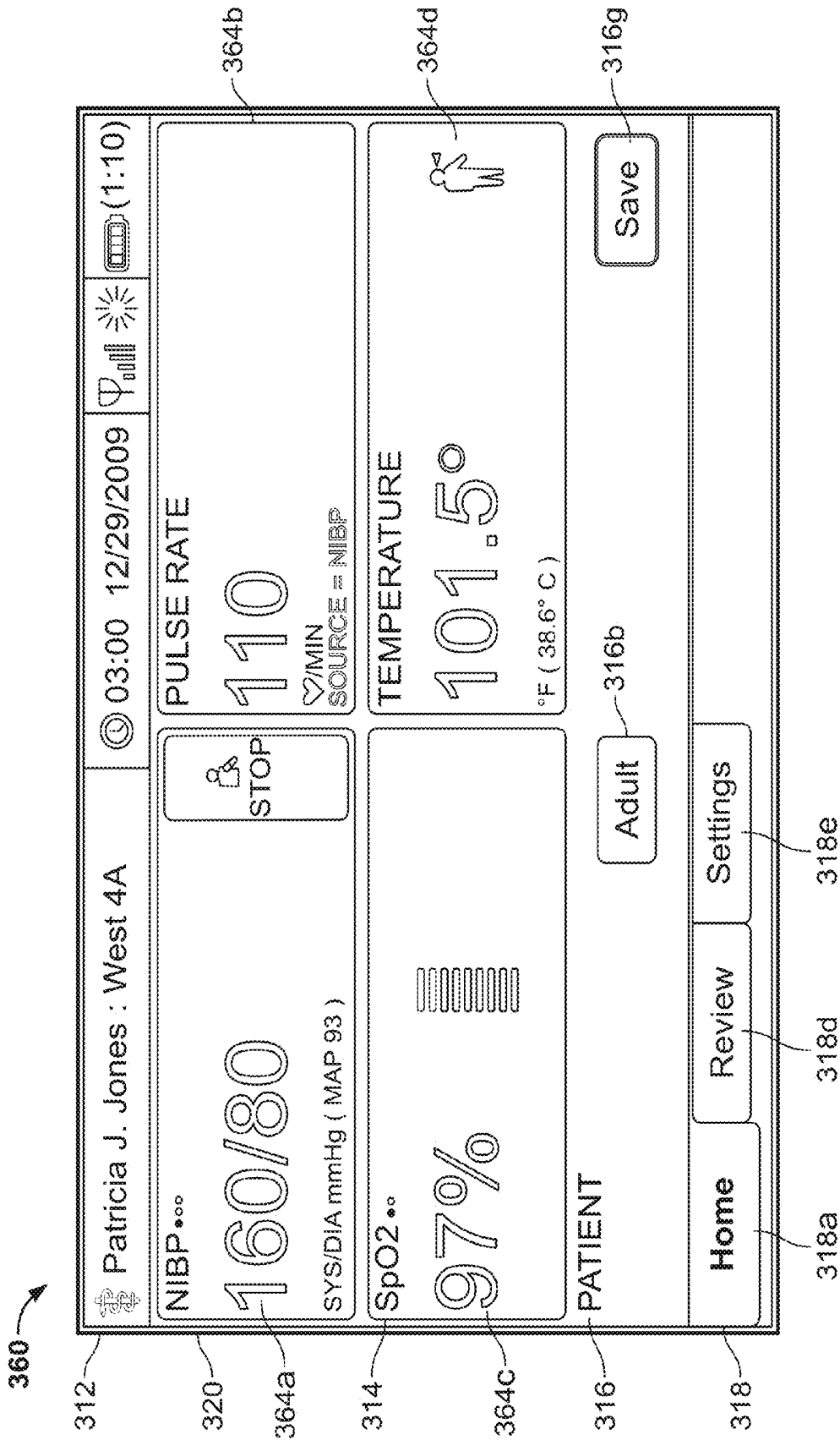

FIG. 3D

314C →

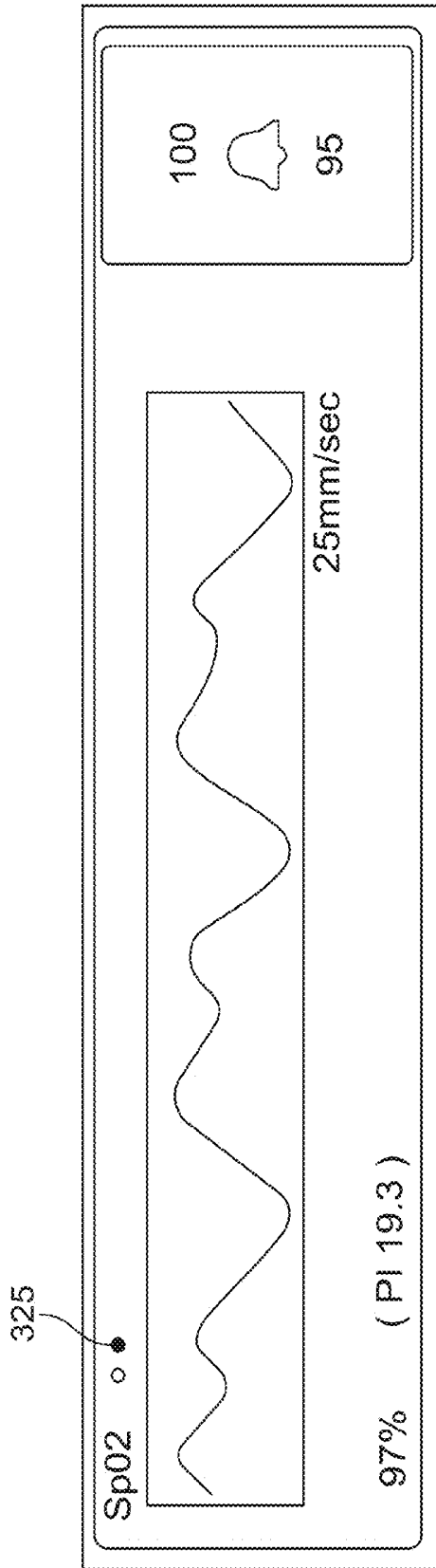



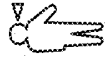



FIG. 3E

380

 Alarm limit exceeded. Pulse rate HIGH.

NIBP *** 120/80 SYS/DIA mmHg (MAP 93) INTERVALS: Transfusion	 START 0:14:39	SYS 160 90 DIA 90 50	PULSE RATE 122 ♥/MIN SOURCE = NIBP
SpO2 ** 97% (PI 19.3) MODE: Fast	 25 	100 95	TEMPERATURE 101.5° °F (38.6° C)  
PATIENT Barker, David A. 206A A 05/14/1945	HEIGHT 72 in WEIGHT 197 lb PAIN 3 RR 15 bpm	Save	Save

Home **Patients** **Alarms** **Review** **Settings**

FIG. 3F

380

(:89) Alarm limit exceeded. Pulse rate high.

NIBP *** 120/80 SYS/DIA mmHg (MAP 93) INTERVALS: Transfusion	START 0:14:39	sys 160 90 DIA 90 50	PULSE RATE 122 ♥/MIN SOURCE = NIBP	120 50
SpO2 ** 97% (PI 19.3) MODE: Fast	 25	100 95	TEMPERATURE 101.5° °F (38.6° C)	102.1 88.3
PATIENT Barker, David A. 206AA 05/14/1945	Adult	HEIGHT WEIGHT PAIN RR 72 197 3 15 in lb bpm	Save	Save
Home	Patients	Alarms	Review	Settings

FIG. 3G

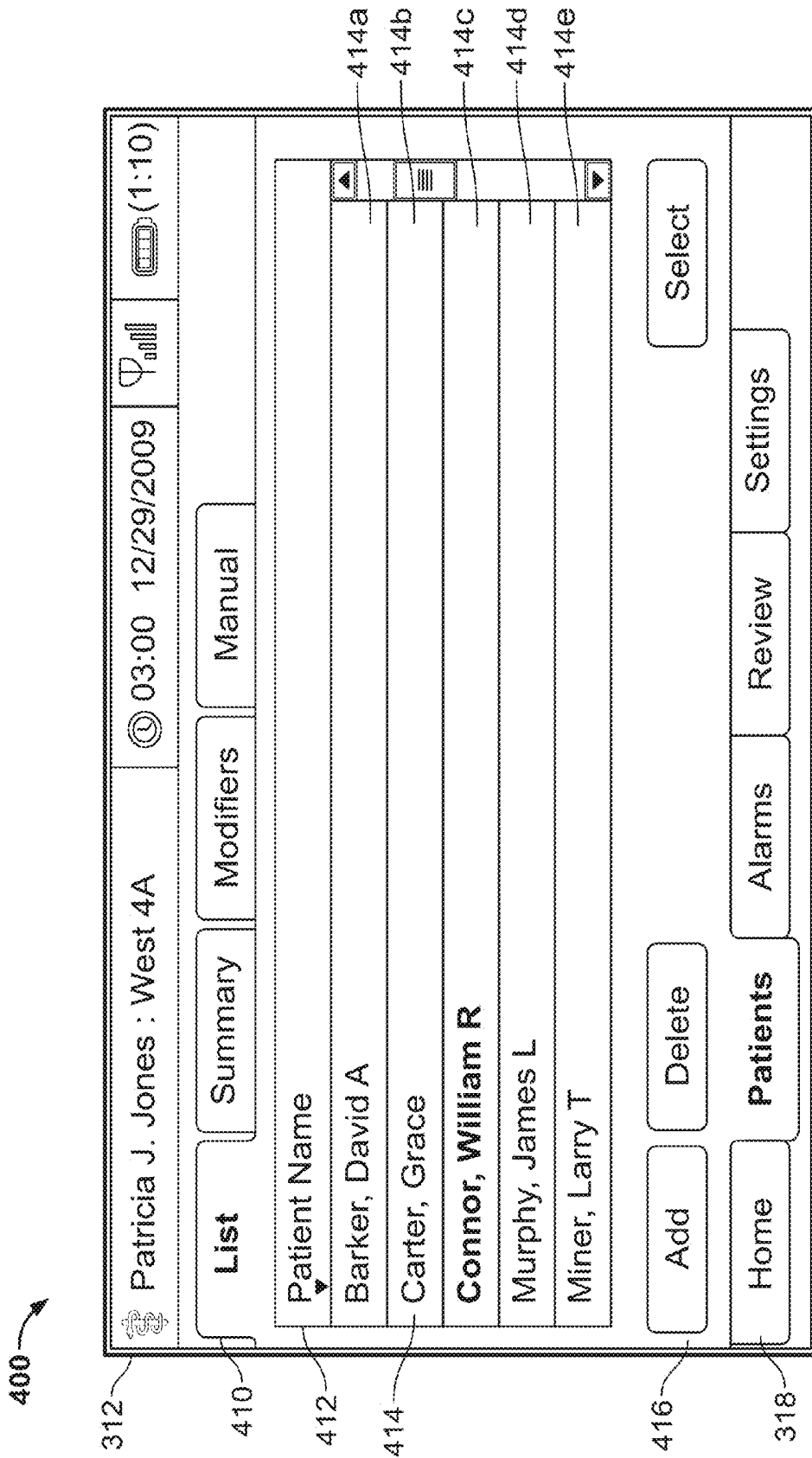

FIG. 4

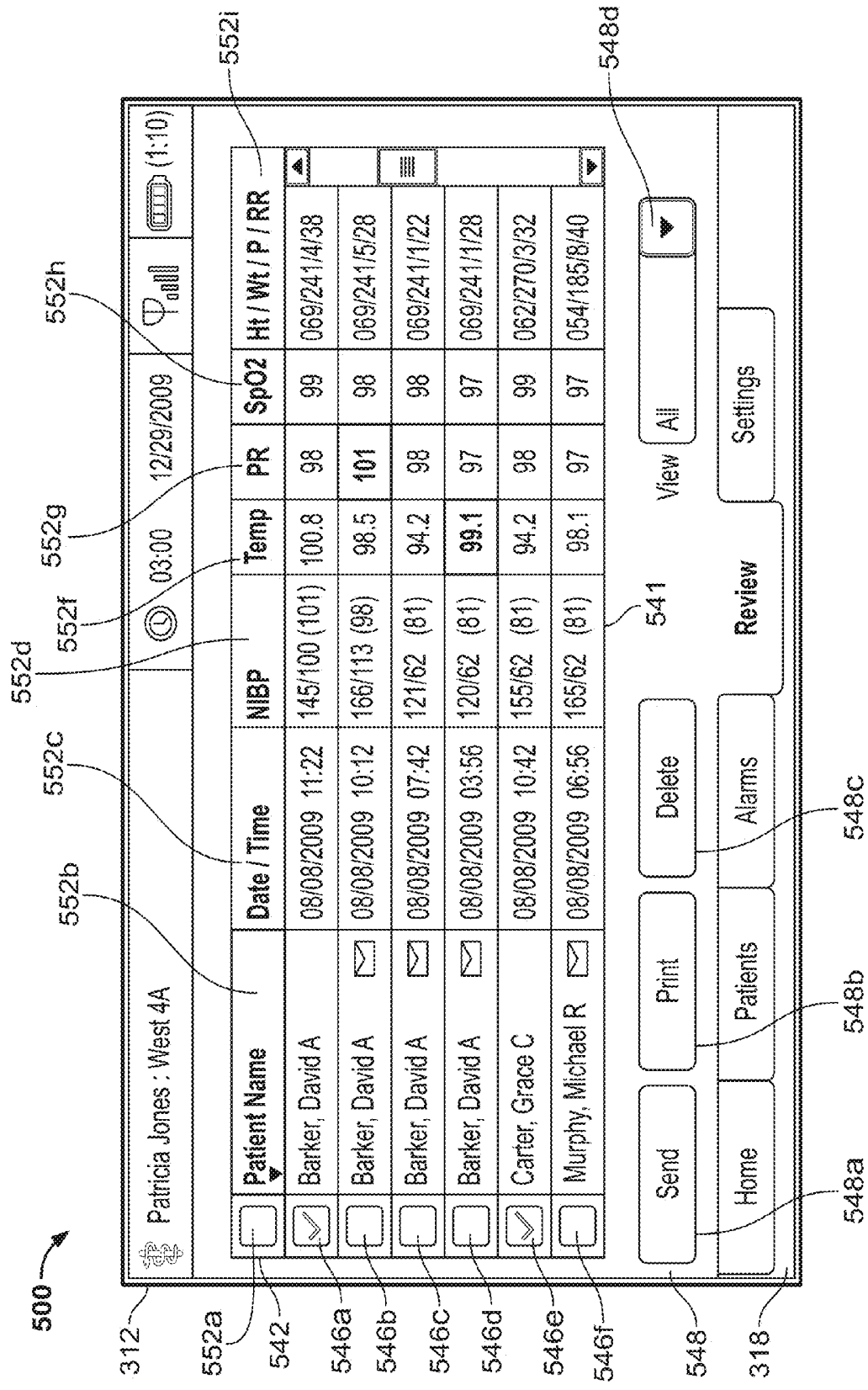

FIG. 5

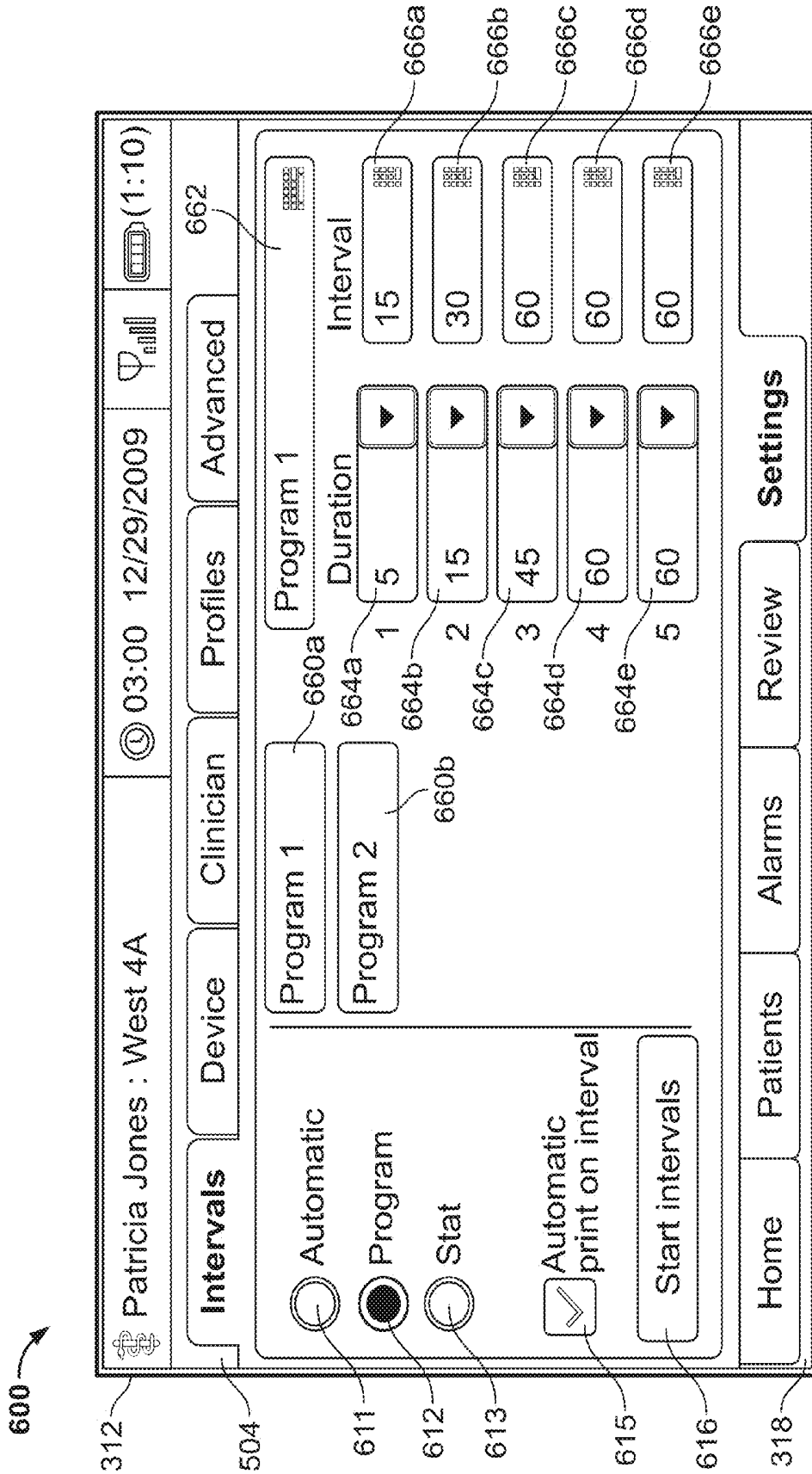

FIG. 6A

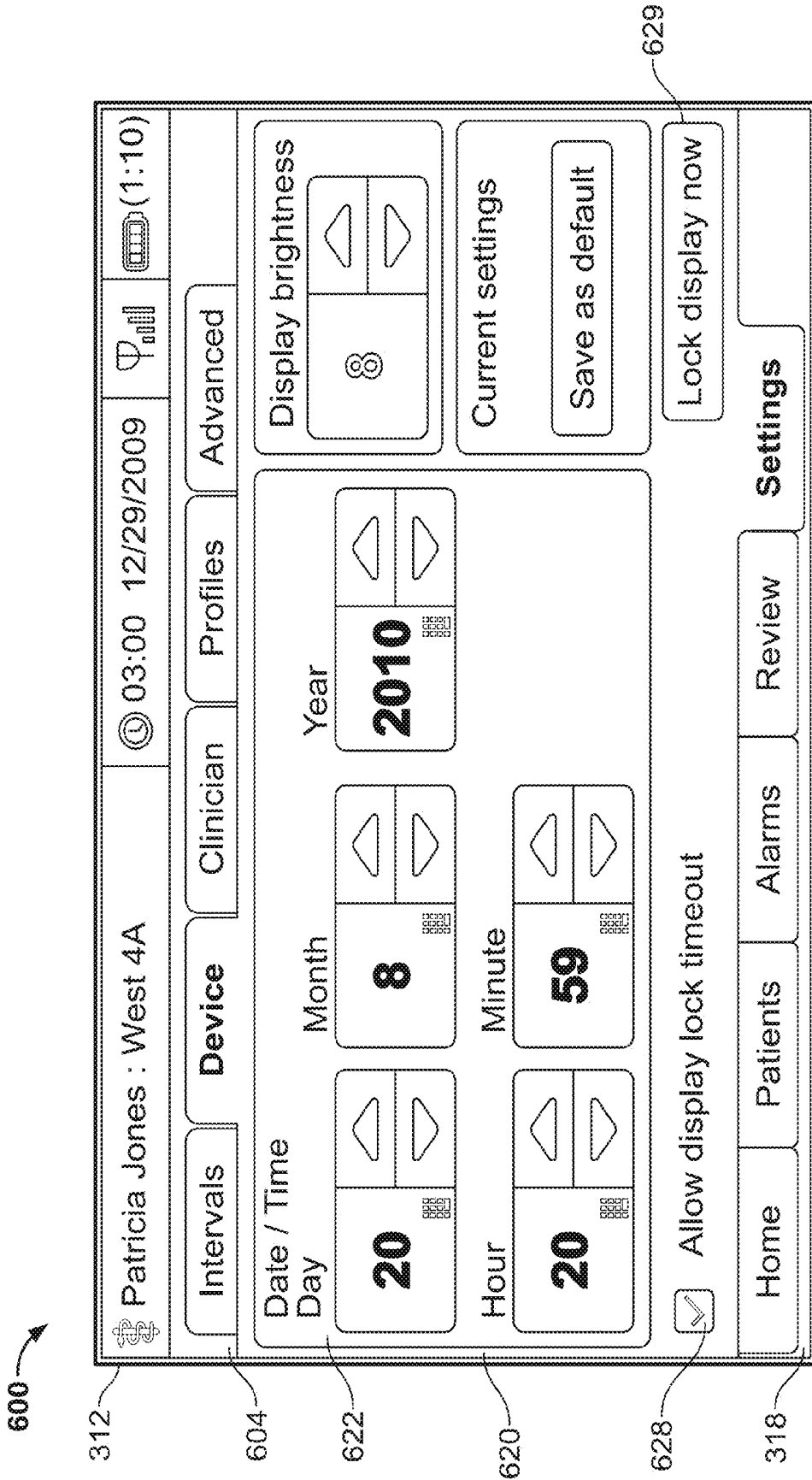

FIG. 6B

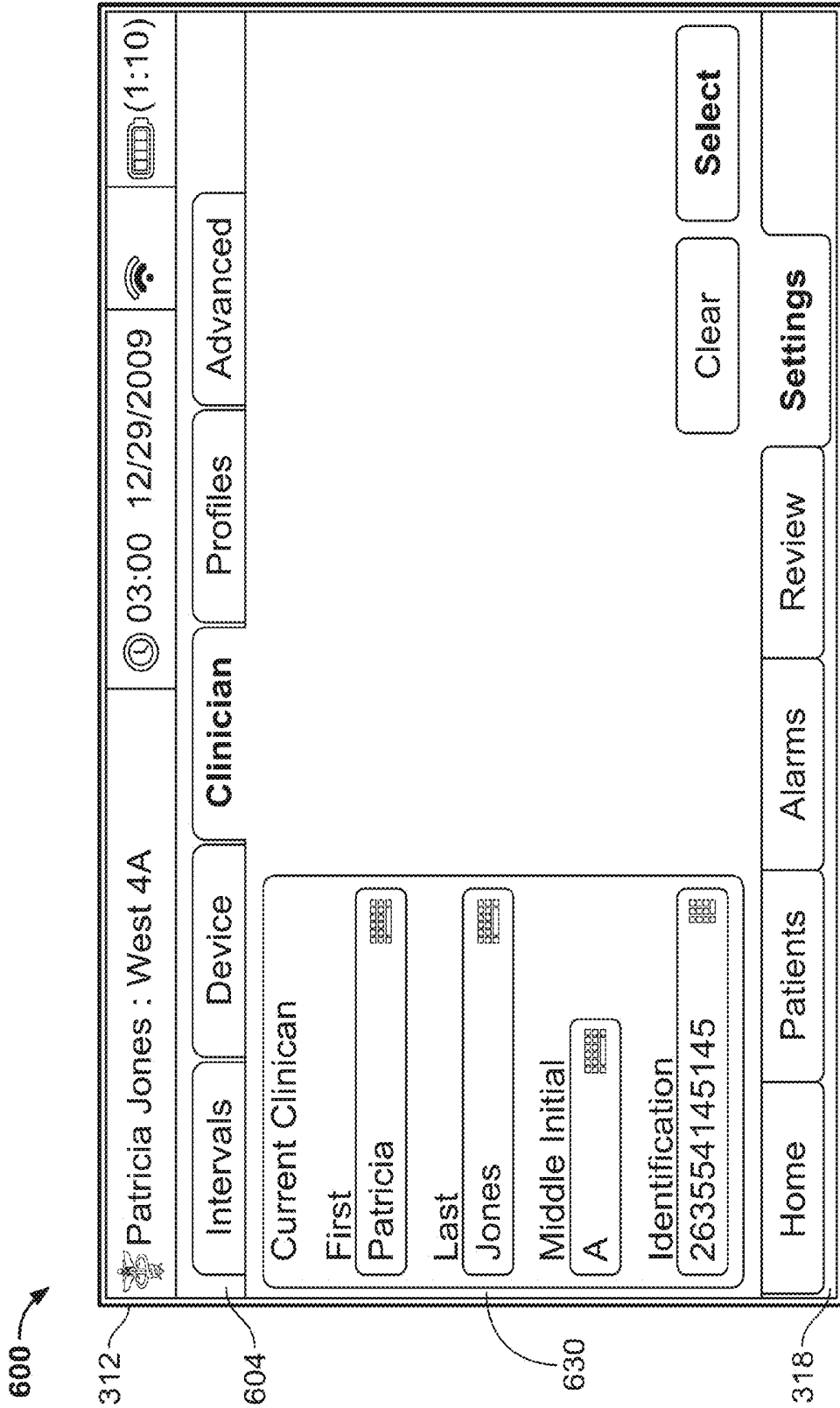

FIG. 6C

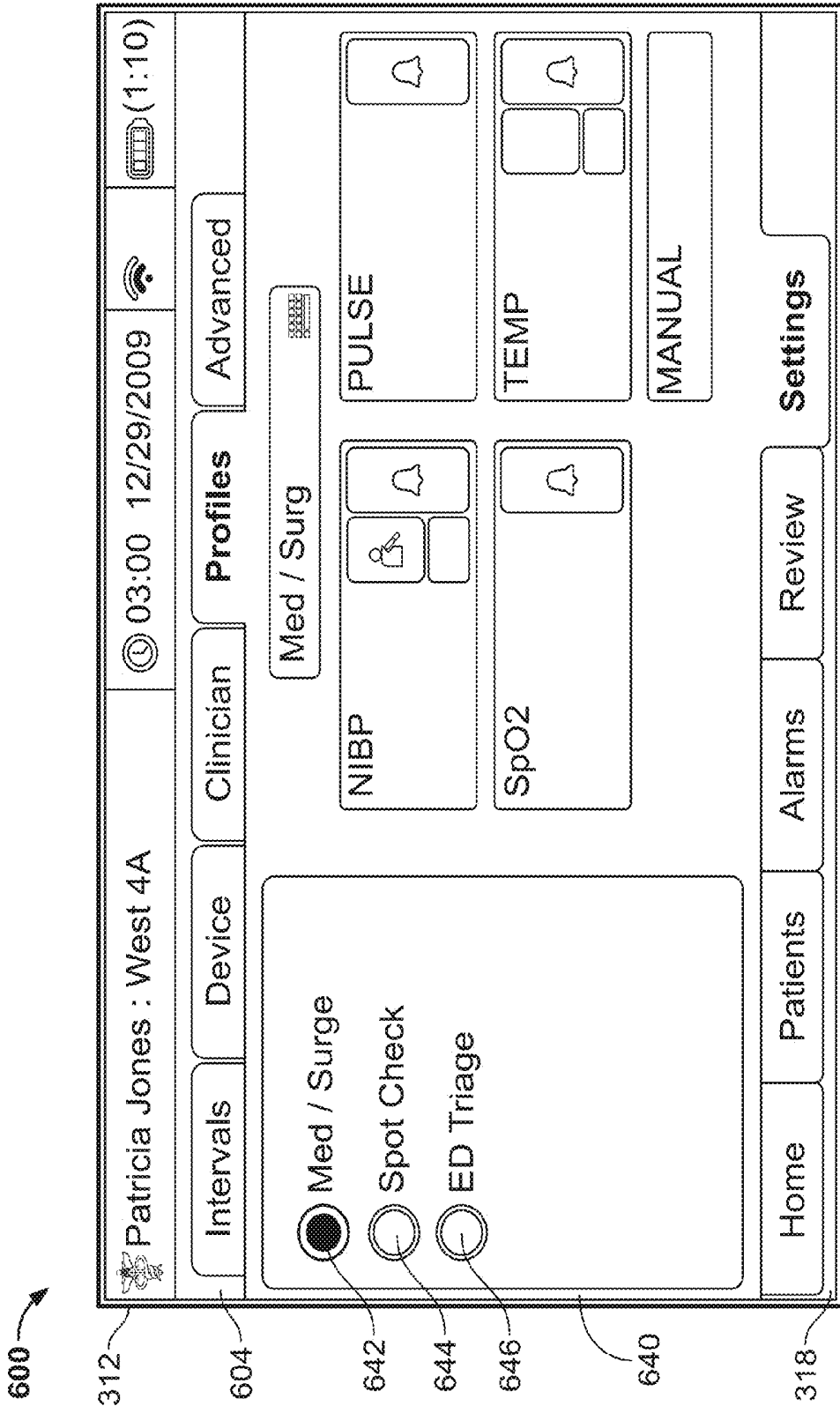

FIG. 6D

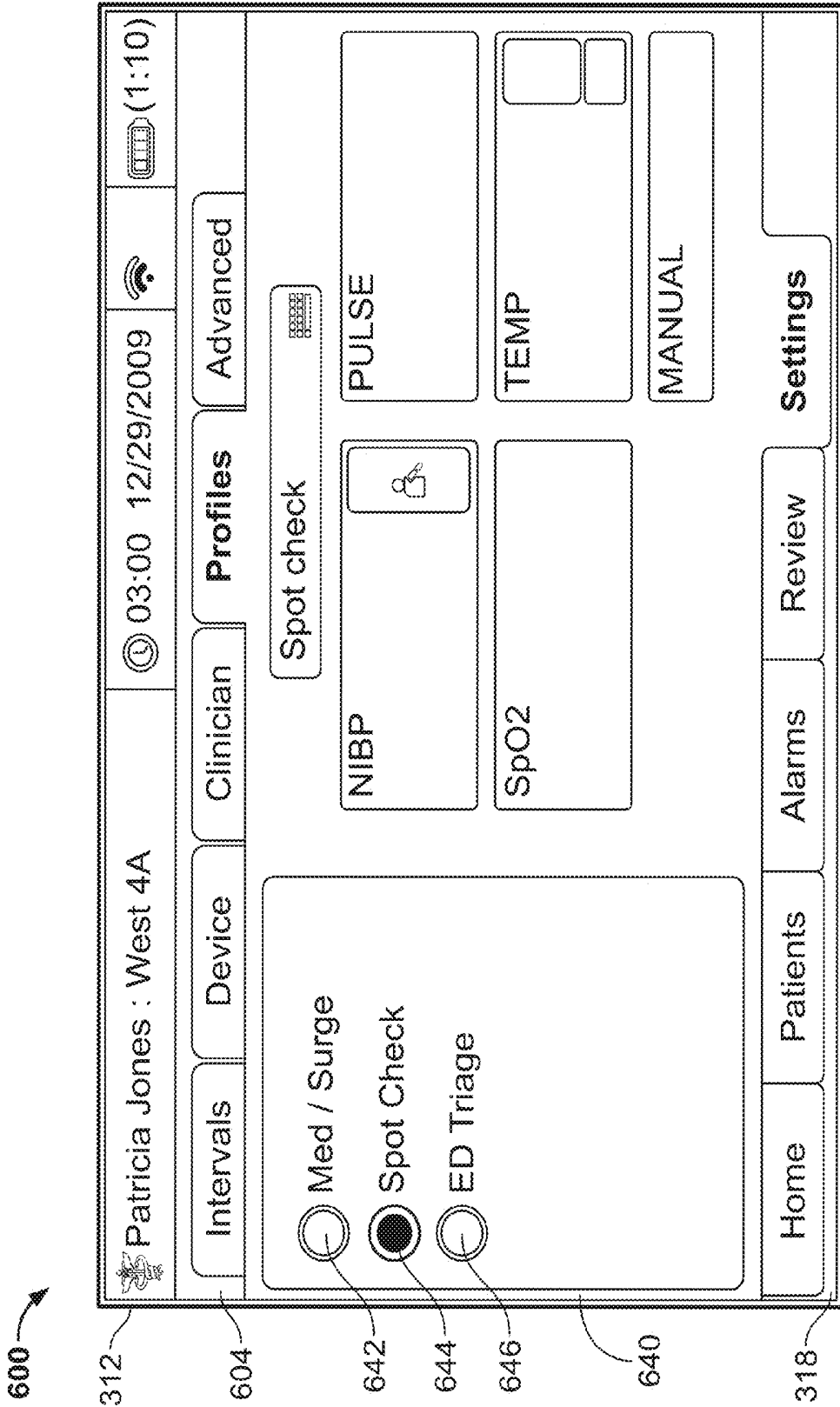

FIG. 6E

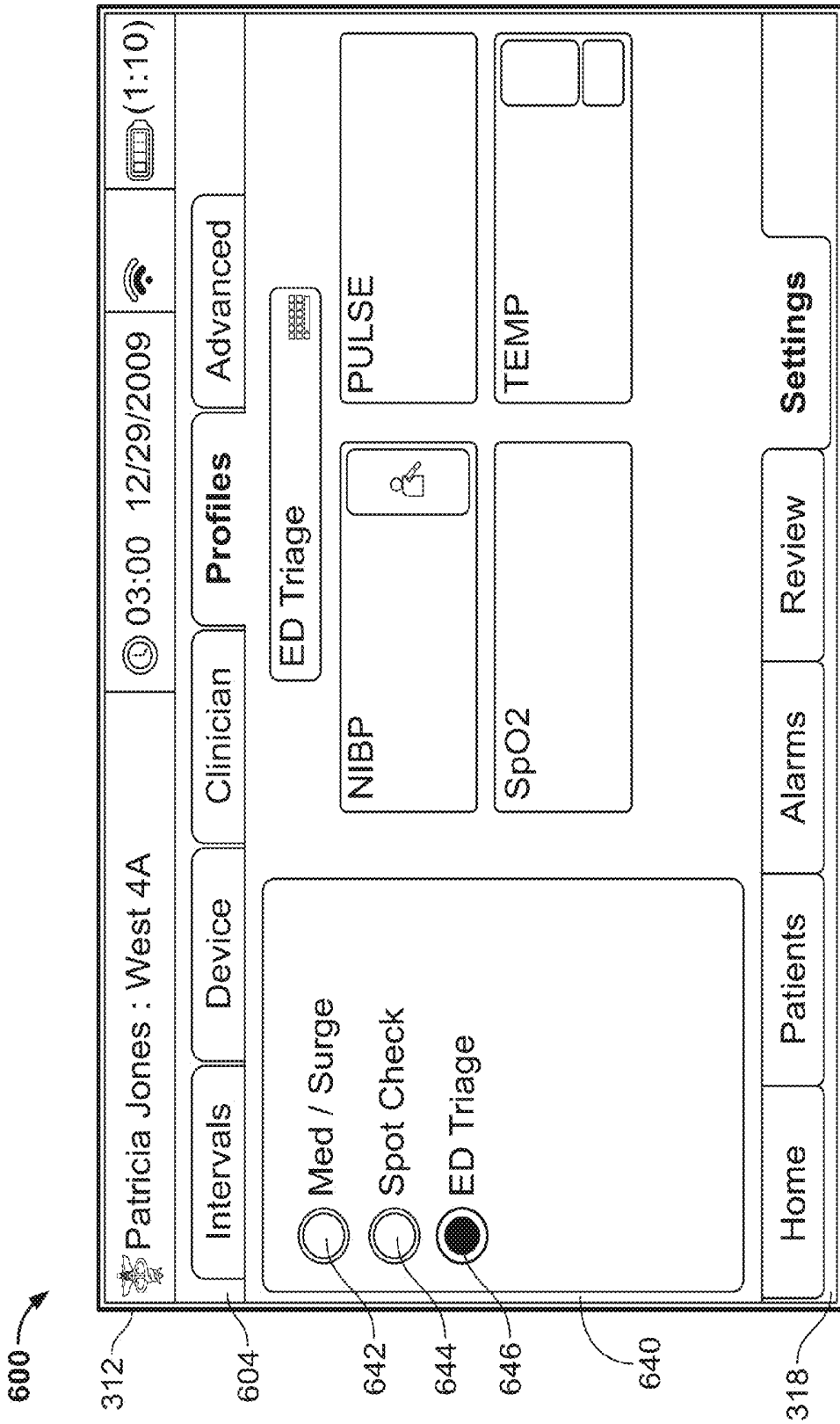

FIG. 6F

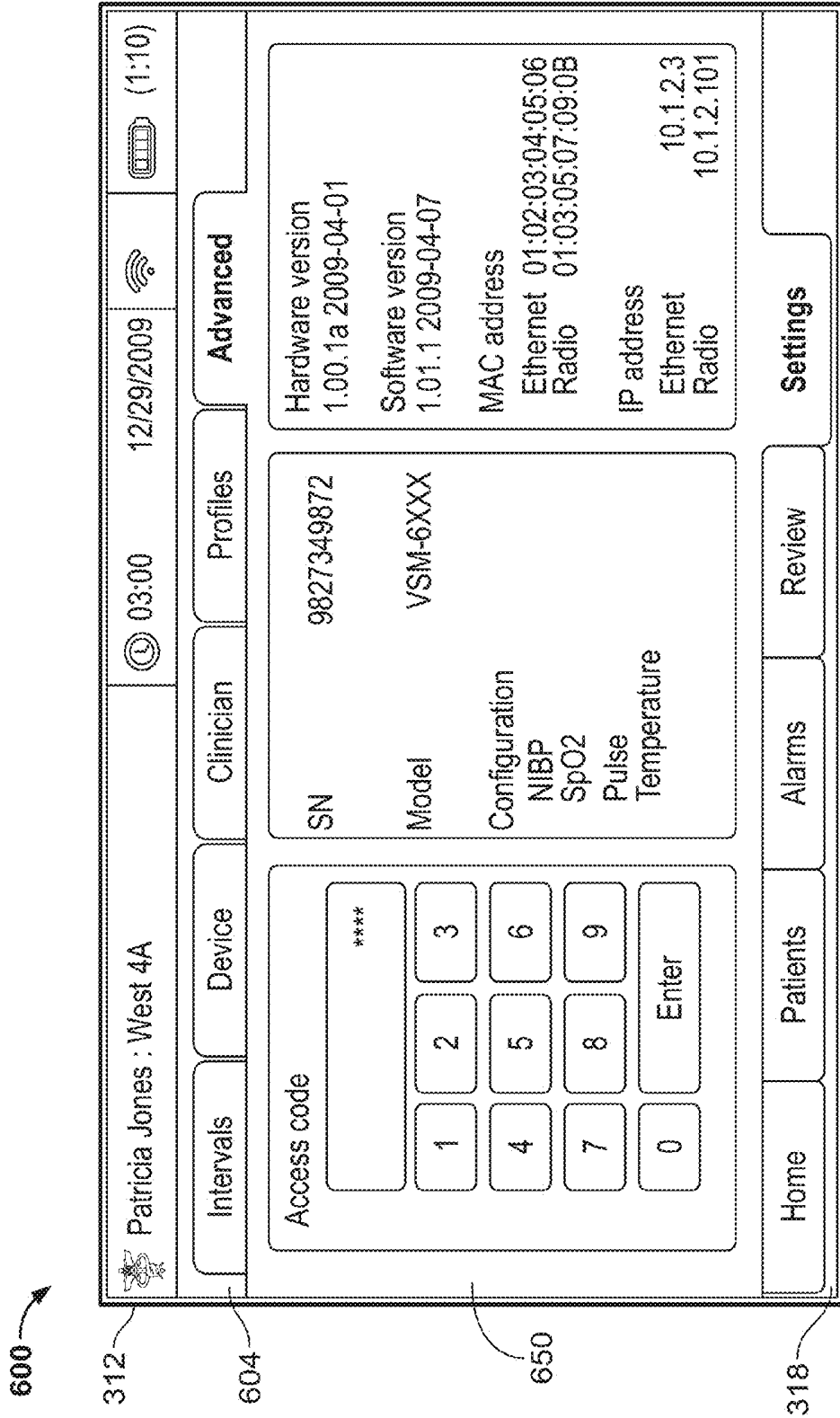

FIG. 6G

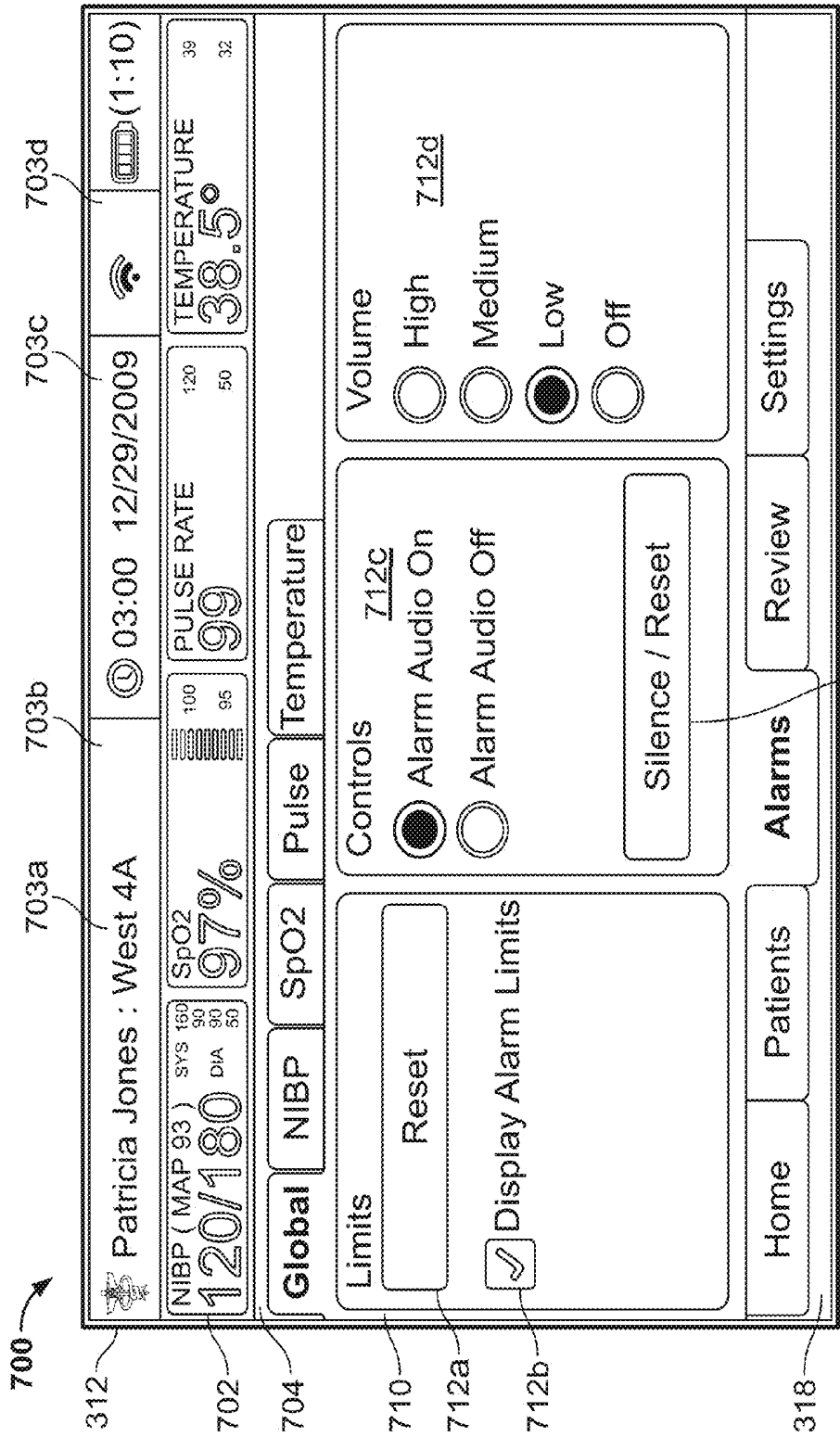

FIG. 7A

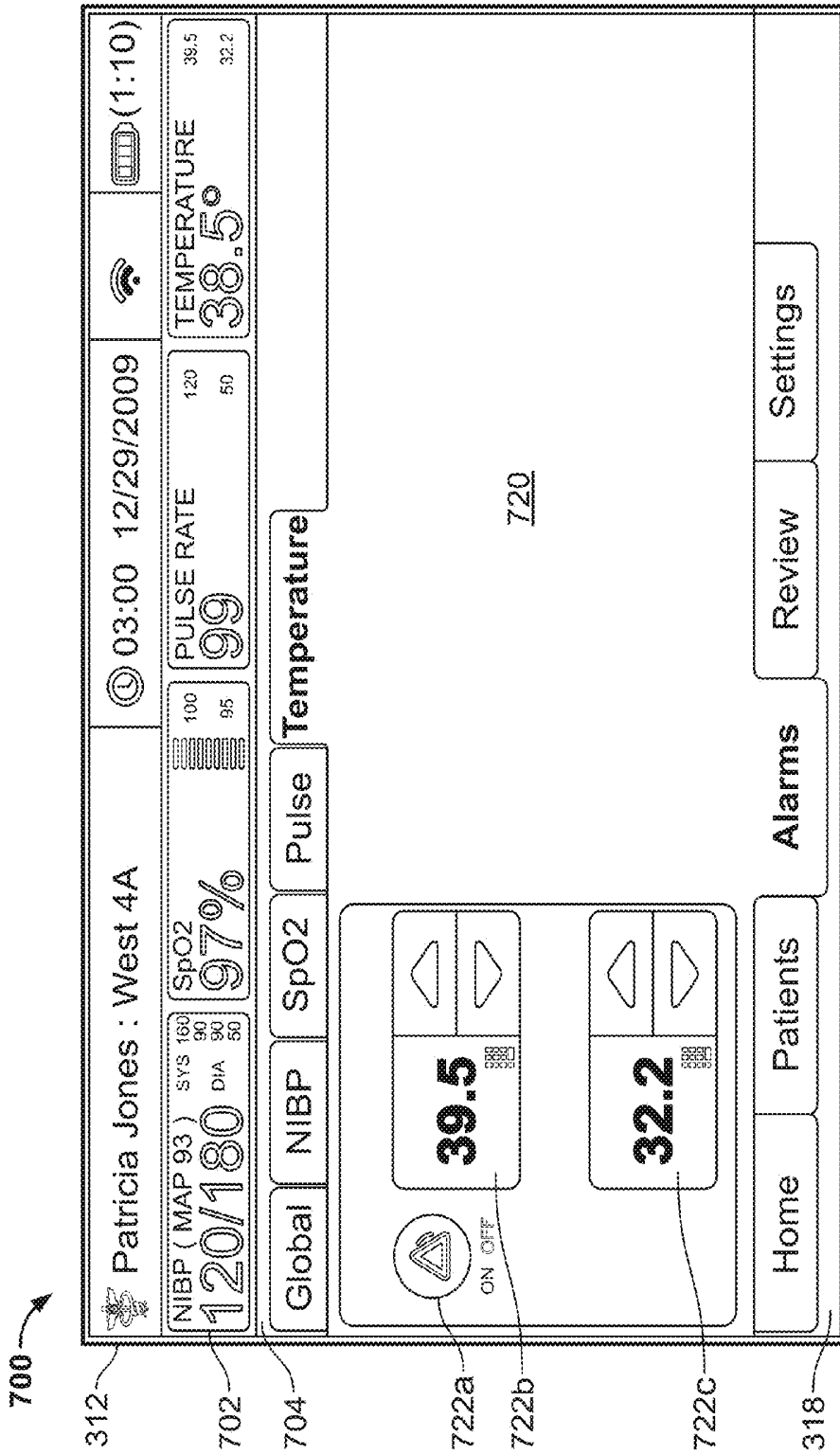

FIG. 7B

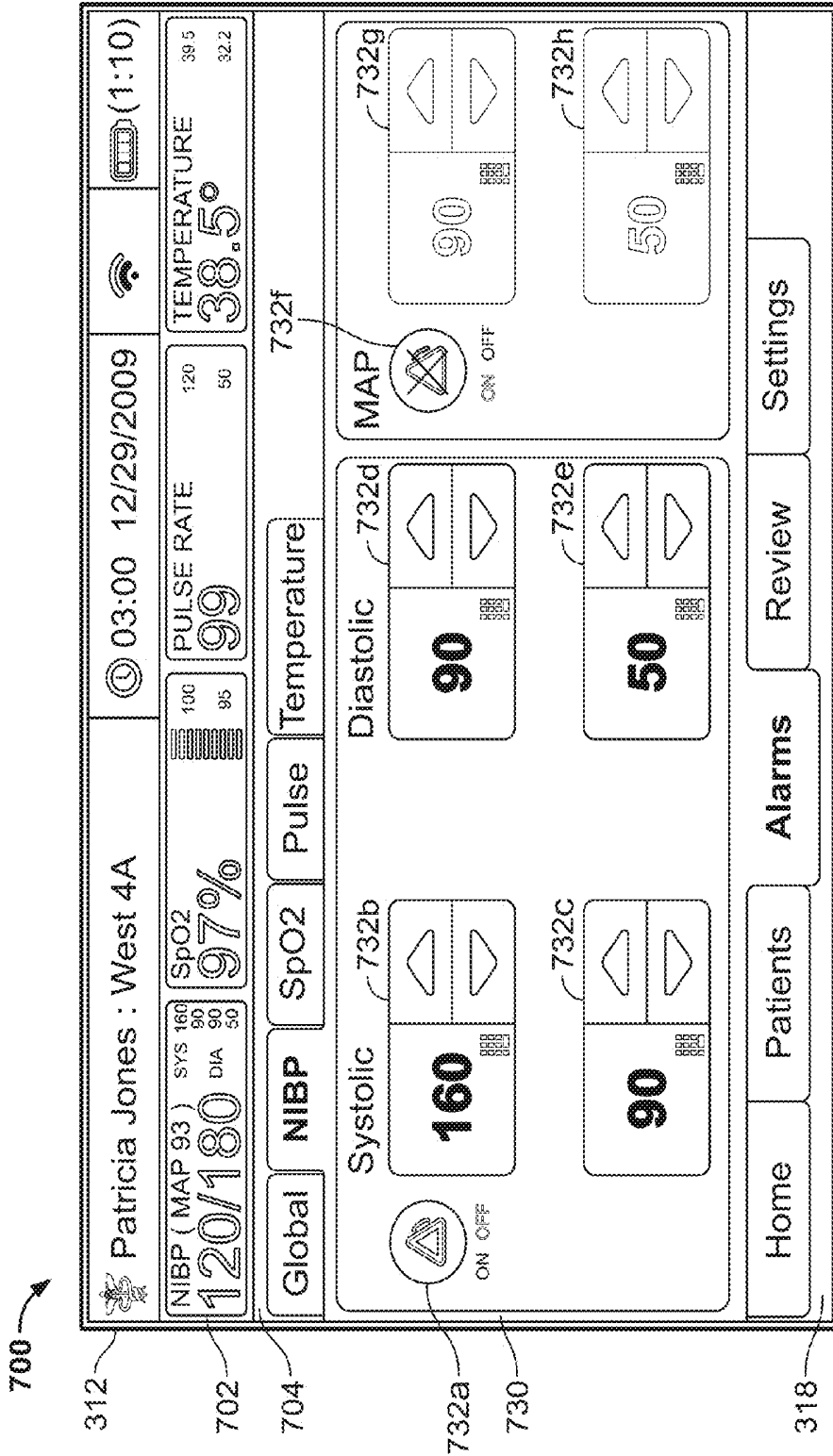

FIG. 7C

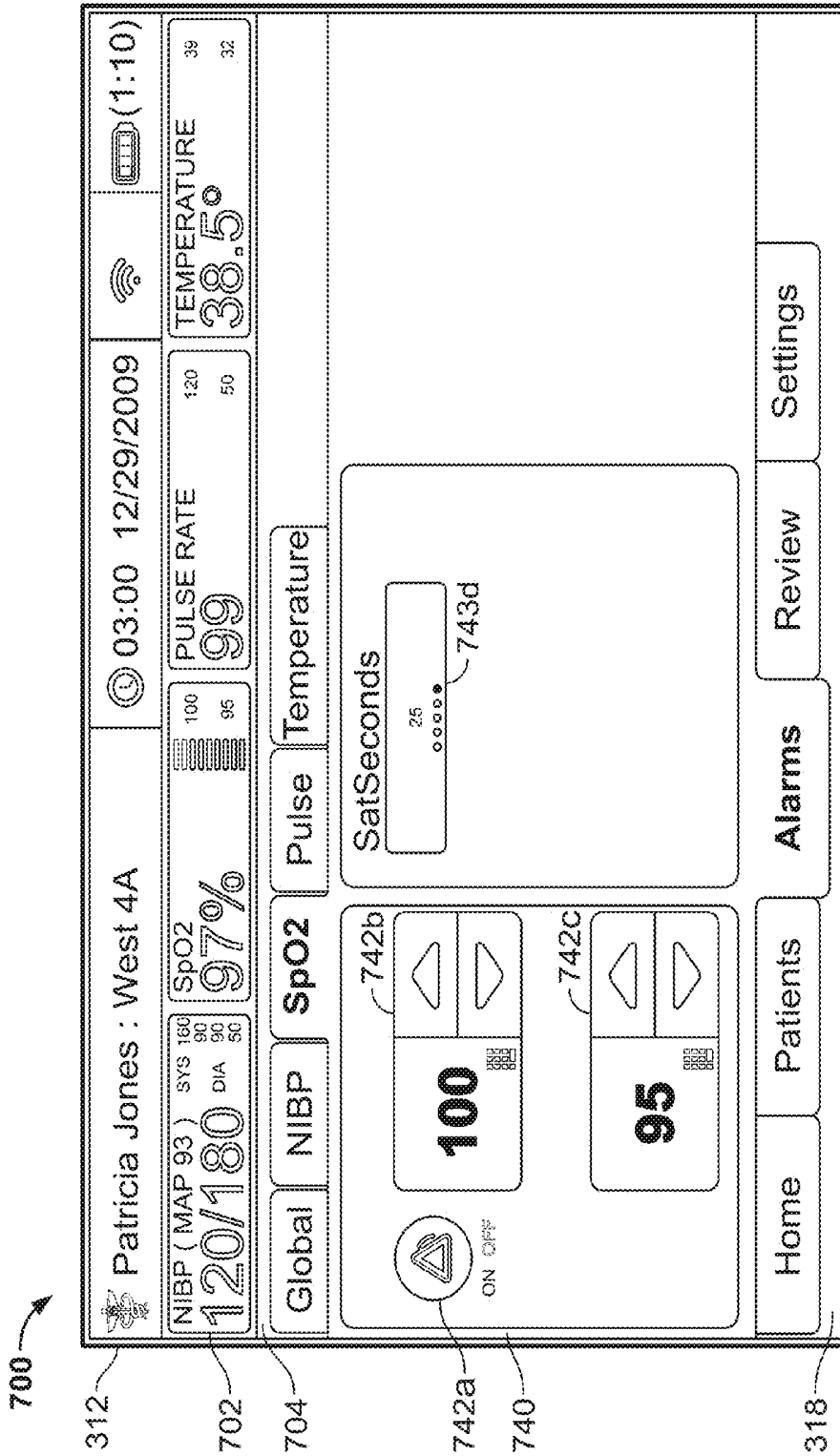

FIG. 7D

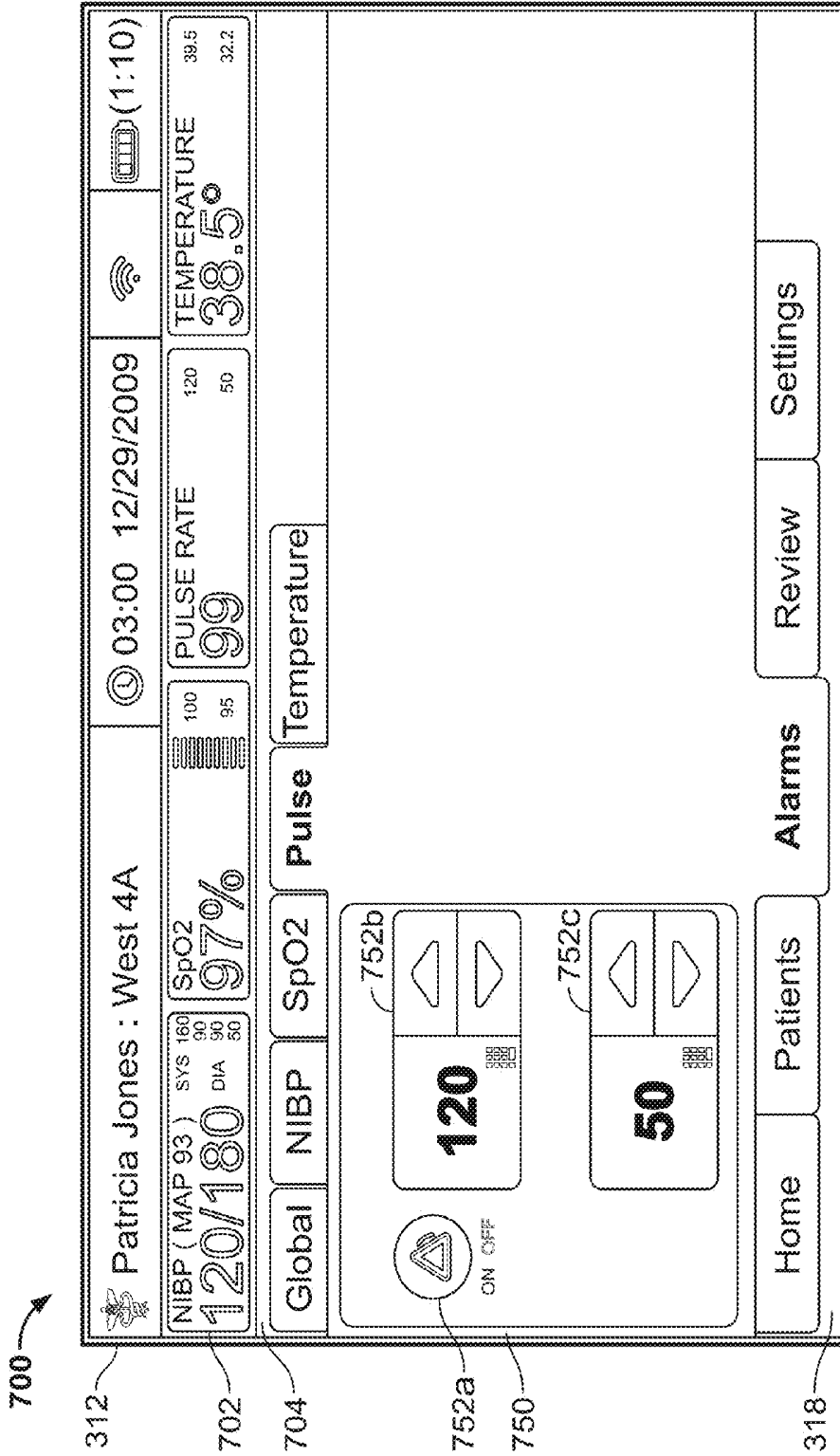

FIG. 7E

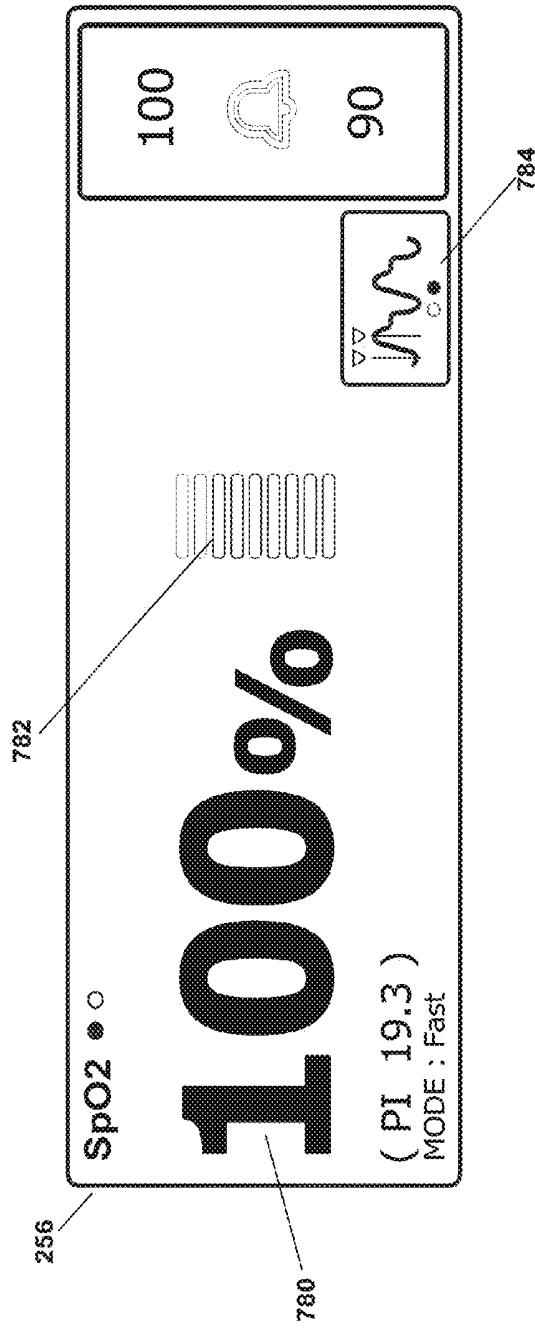

FIG. 8

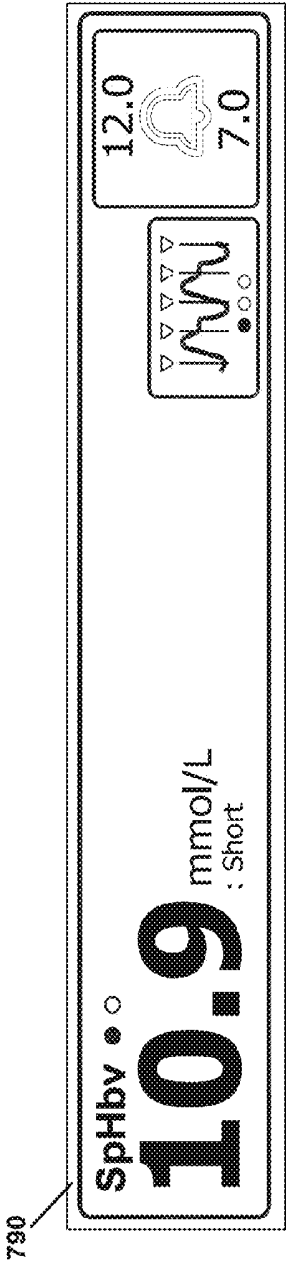

FIG. 9

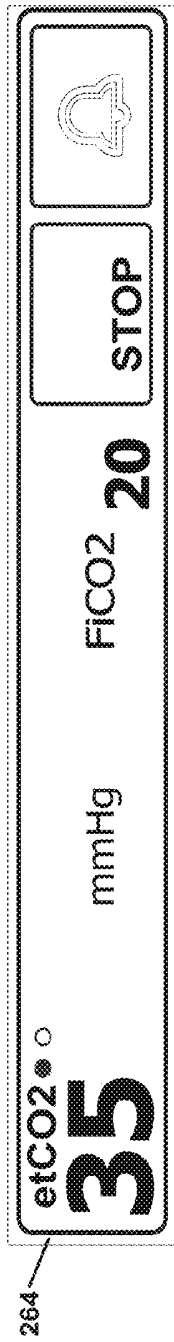

FIG. 10A

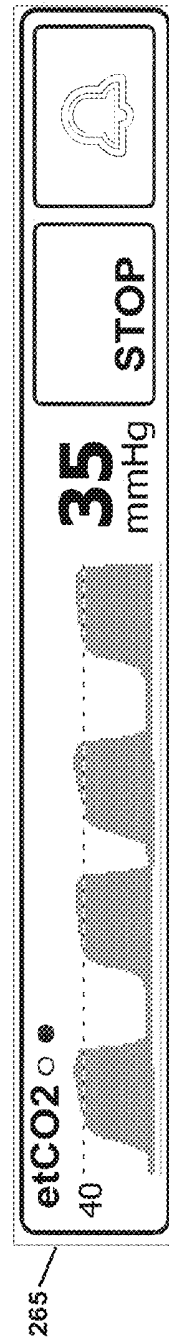

FIG. 10B

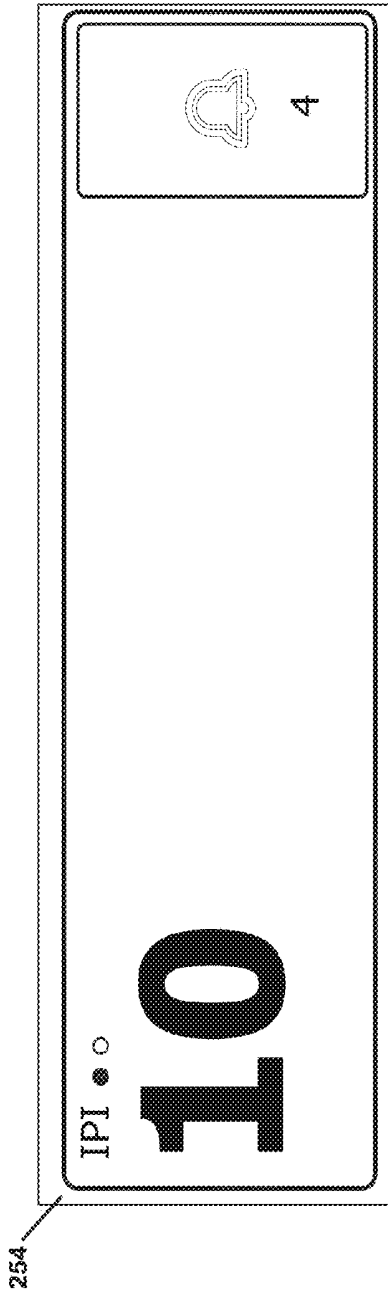

FIG. 11A

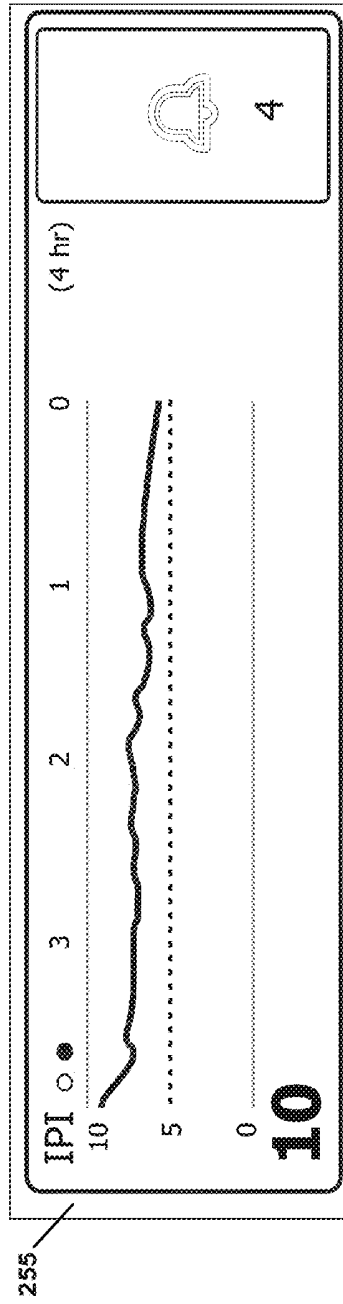

FIG. 11B

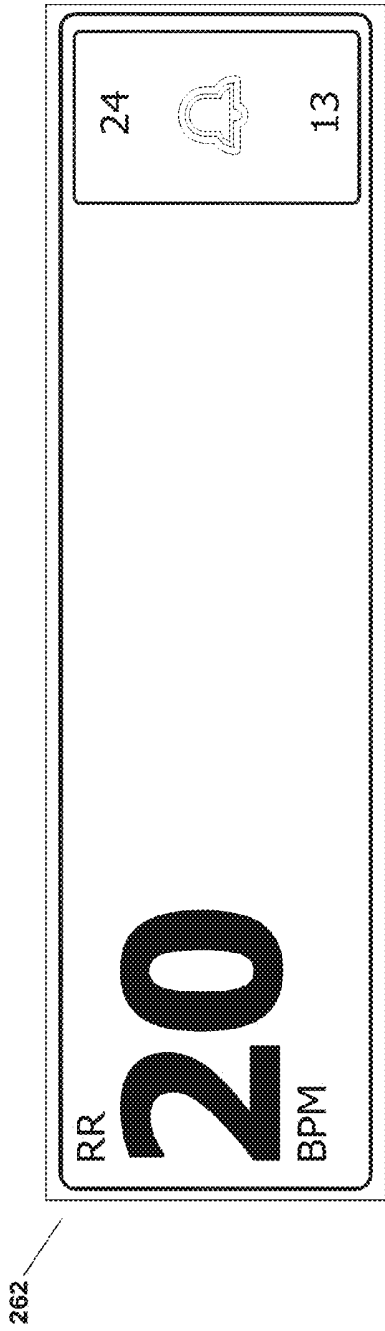

FIG. 12A

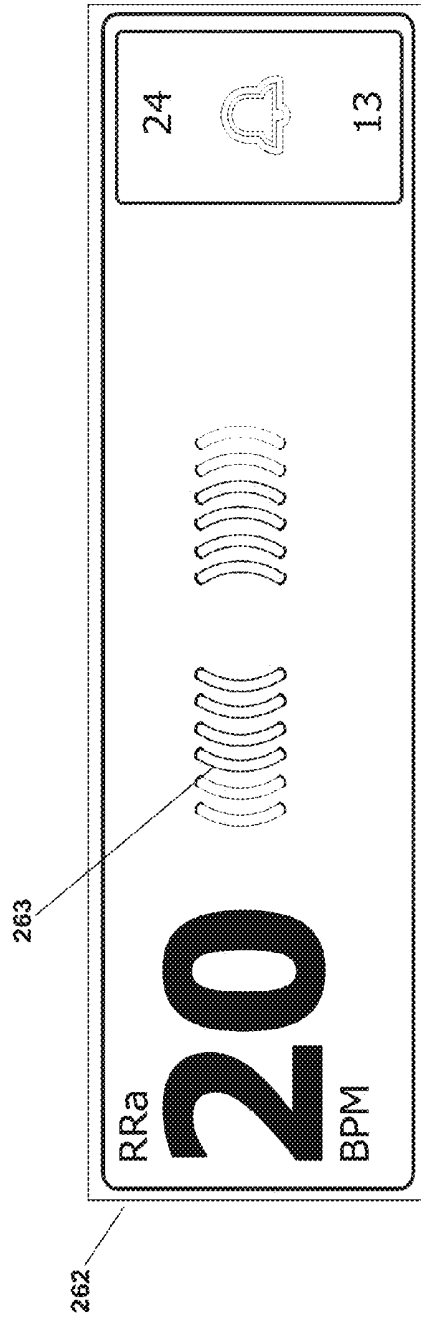

FIG. 12B

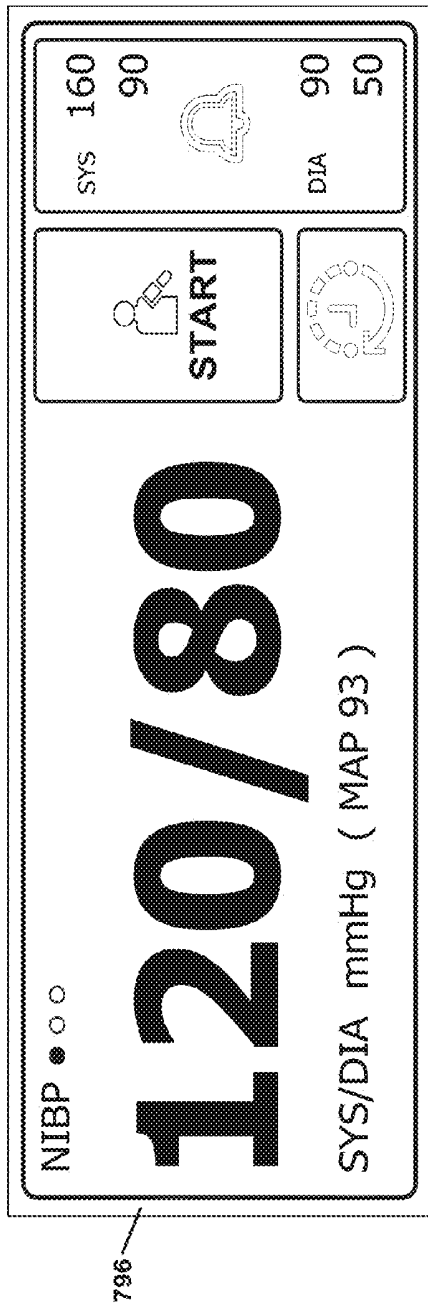

FIG. 13A

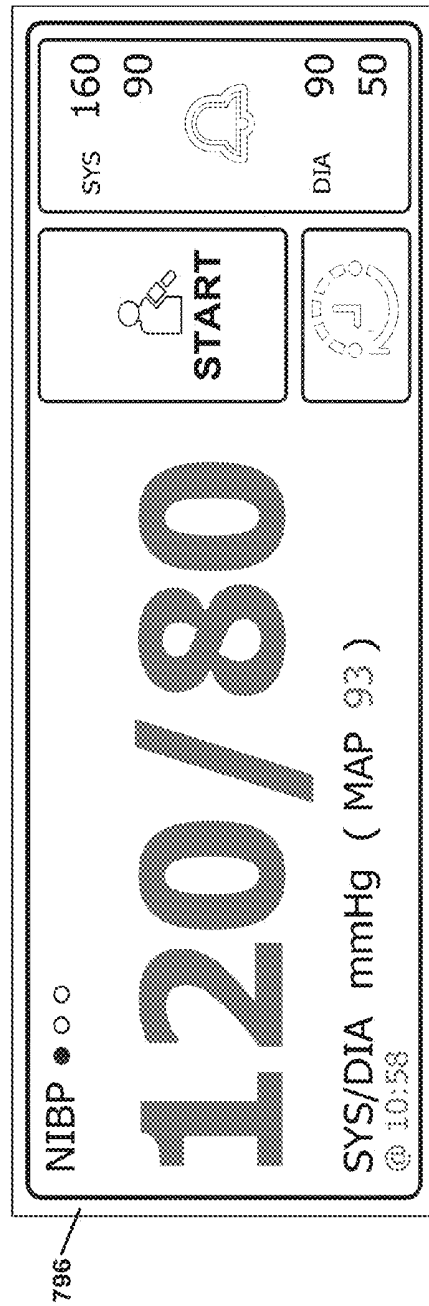

FIG. 13B

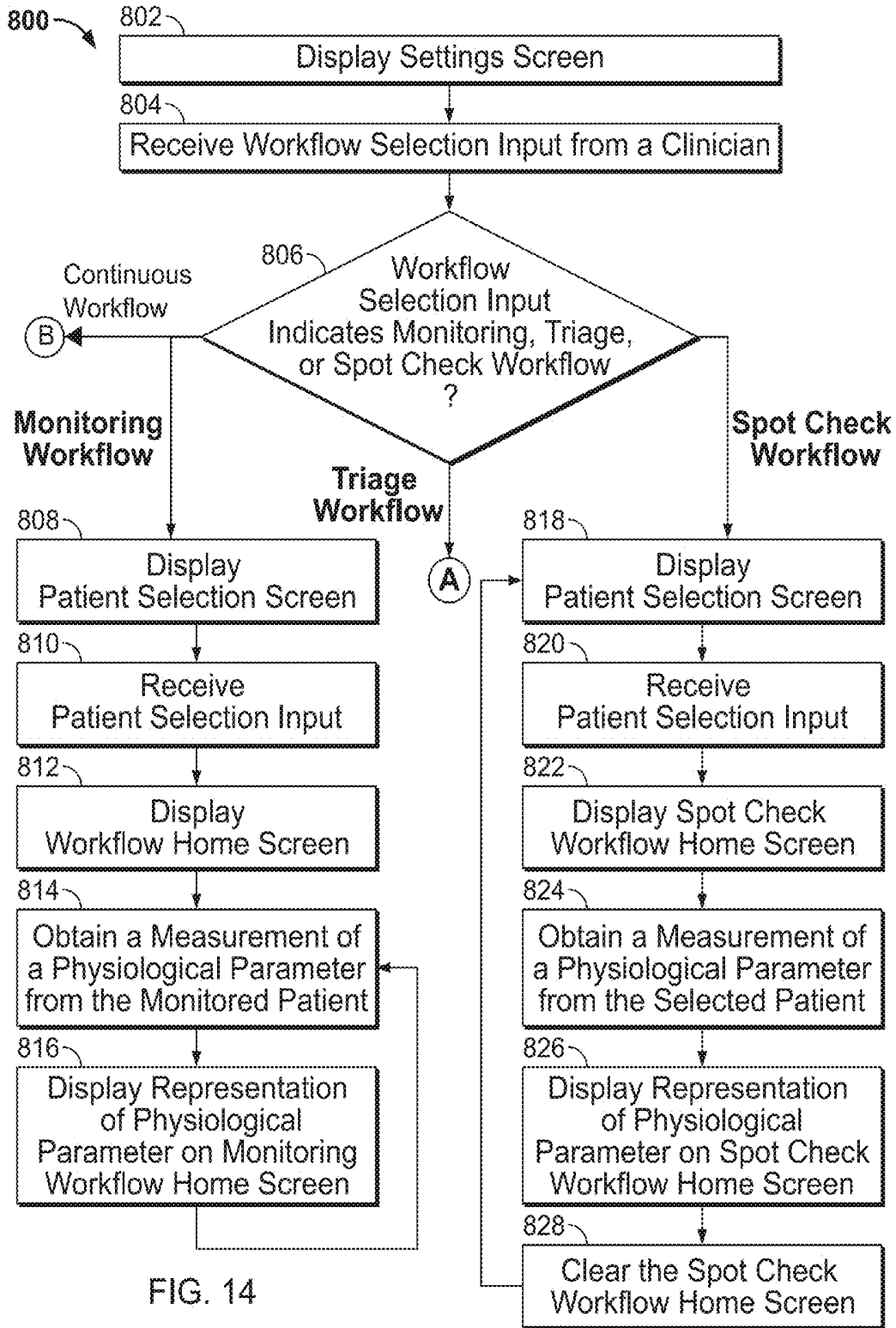

FIG. 14

800

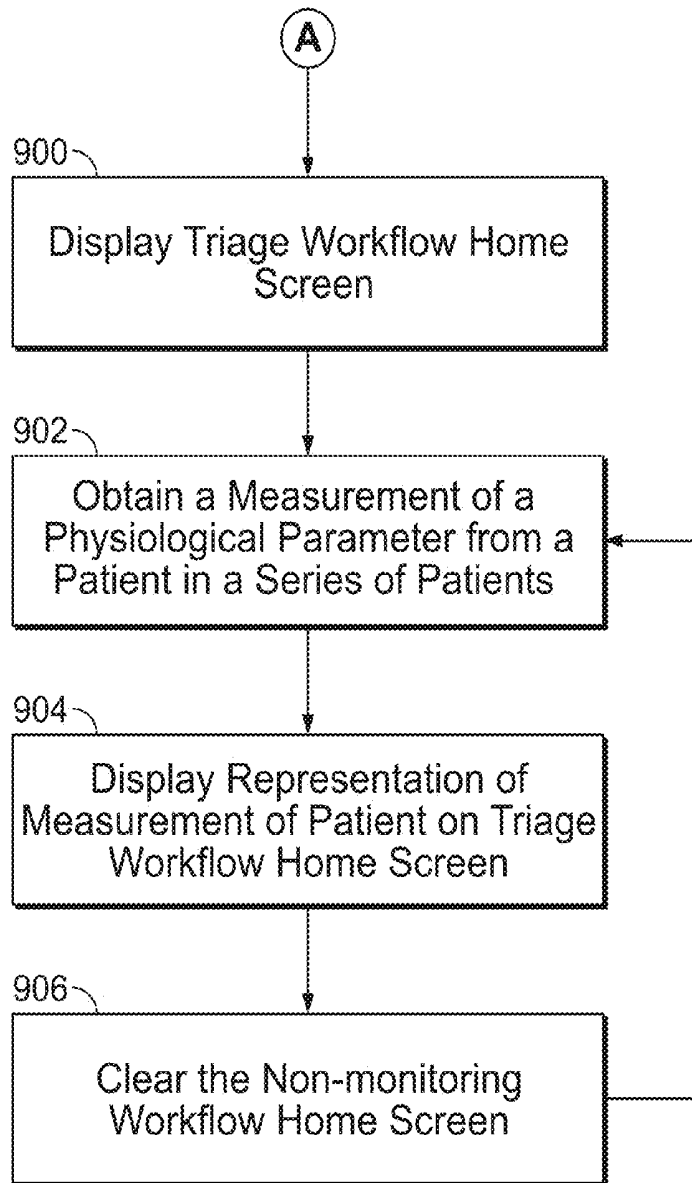

FIG. 15

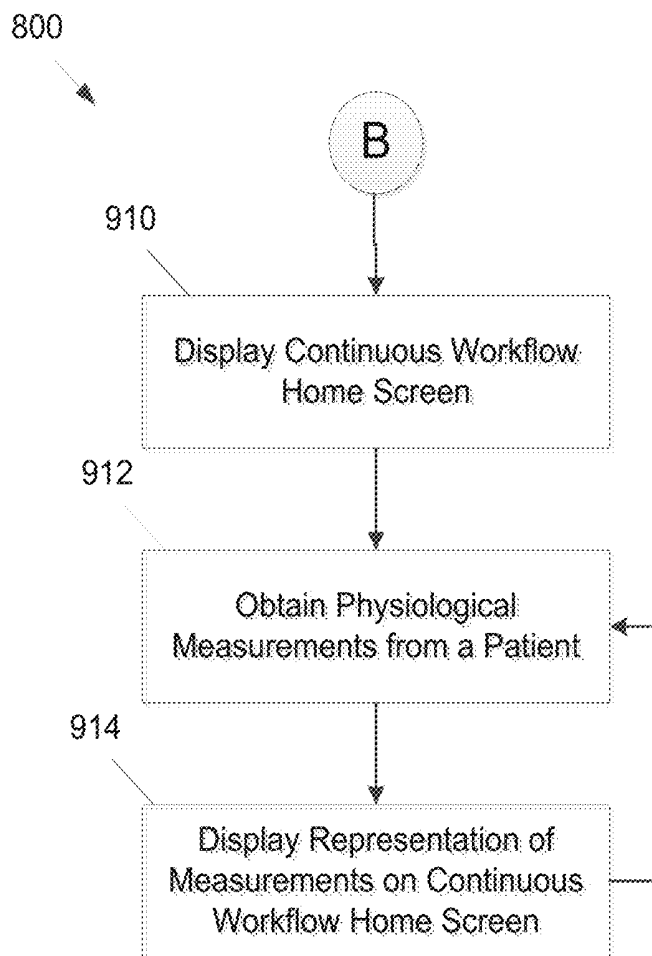

FIG. 16

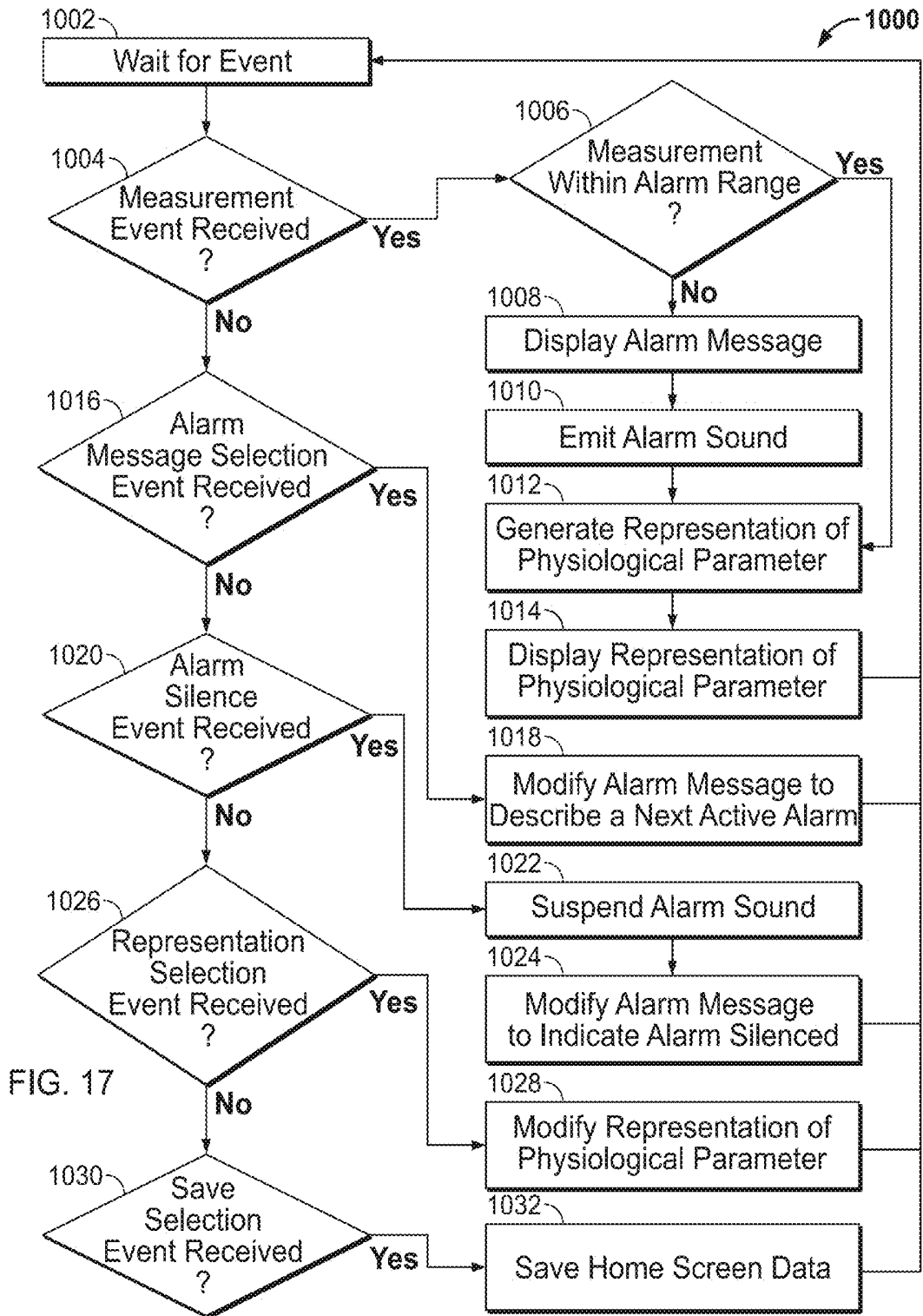

FIG. 17

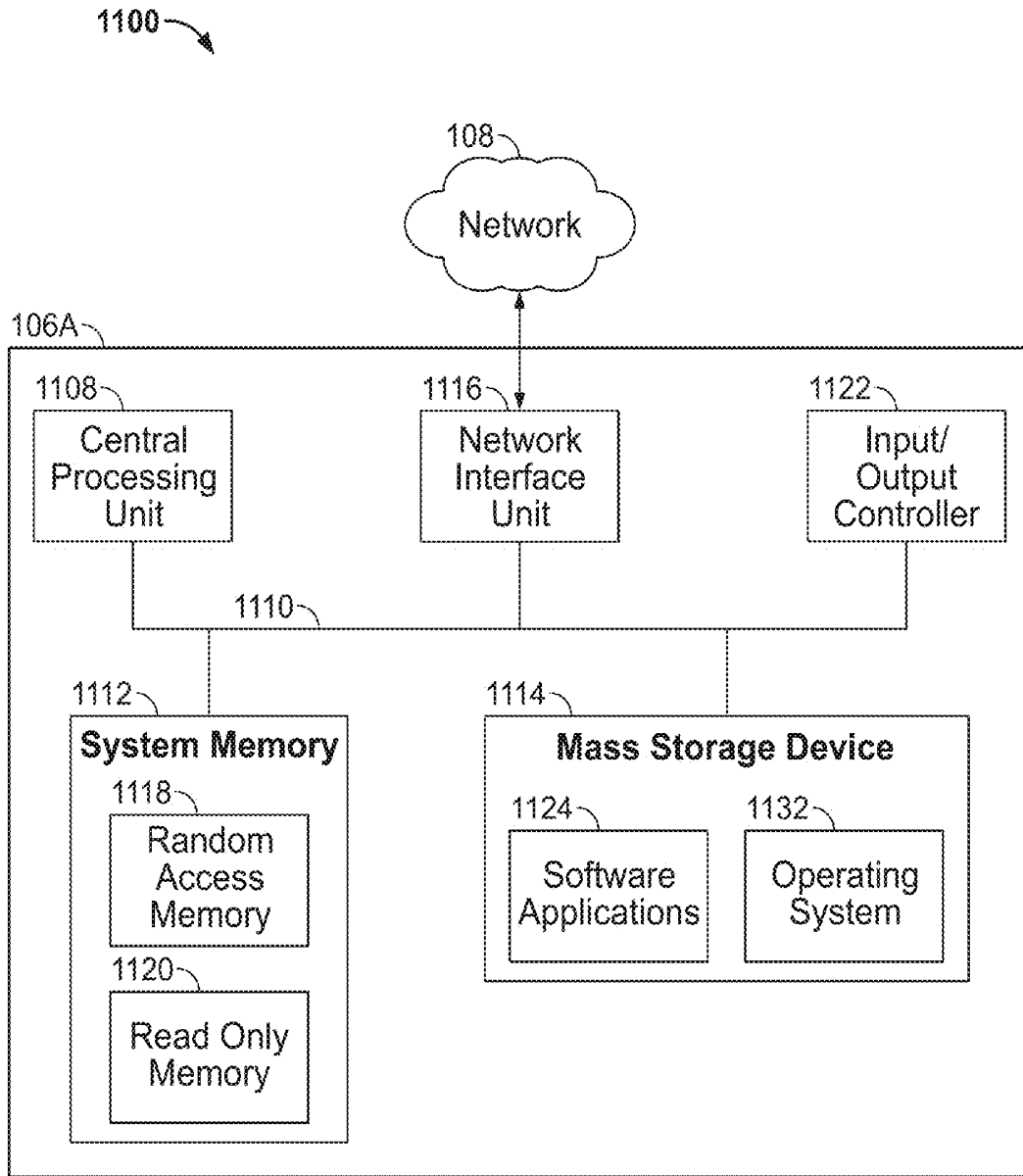

FIG. 18

**PHYSIOLOGICAL PARAMETER
MEASURING PLATFORM DEVICE
SUPPORTING MULTIPLE WORKFLOWS**

RELATED APPLICATION

The present application is related to U.S. patent application Ser. No. 12/751,579 filed on Mar. 31, 2010, the entirety of which is hereby incorporated by reference.

BACKGROUND

Health care practitioners, such as nurses and physicians, use various types of health-care equipment to assist with the task of providing health care to a patient, also referred to herein as a health-care recipient. Some health-care equipment, referred to as single function equipment, is designed to perform a particular function, such as temperature measurement. Some health-care equipment, referred to as multi-function equipment, is designed to implement the performance of more than one function, such as temperature measurement and blood pressure measurement. Such multi-function equipment may impose excess bulk and/or weight upon a user if such multi-function equipment is used for only one function or a subset of the functions implemented by the multi-function equipment.

SUMMARY

In one aspect, a physiological measuring platform (PMP) device comprising: a central processing unit (CPU) that is configured to control operation of the PMP device; a display screen; and a set of one or more computer readable data storage media storing software instructions that, when executed by the CPU, cause the PMP device to: obtain a series of measurements of a physiological parameter of a monitored patient when the PMP device is operating within a monitoring workflow; display, on the display screen, a monitoring workflow home screen when the PMP device is operating within the monitoring workflow, the monitoring workflow home screen containing a first representation of the physiological parameter of the monitored patient, the first representation based on a measurement in the series of measurements; obtain a measurement of the physiological parameter of each patient in a series of patients when the PMP device is operating within a non-monitoring workflow; and display, on the display screen, a non-monitoring workflow home screen when the PMP device is operating within the non-monitoring workflow, the non-monitoring workflow home screen containing a second representation of the physiological parameter of a given patient in the series of patients, the second representation based on the measurement of the physiological parameter of the given patient in the series of patients; obtain a continuous measurement of the physiological parameter of the monitored patient when the PMP device is operating within a continuous workflow; and display, on the display screen, a continuous workflow home screen when the PMP device is operating within the continuous workflow, the continuous workflow home screen containing a third representation of the physiological parameter of the monitored patient, the third representation based on the measurement of the physiological parameter of the monitored patient; wherein the monitoring workflow home screen, the non-monitoring workflow home screen, and the continuous workflow home screen are each different.

Another aspect includes a method for performing physiological parameter measurements for a plurality of patients,

the method including: displaying, by a physiological measurement platform (PMP) device, a settings screen on a display screen, the settings screen enabling a user to select a workflow within which the PMP device is to operate; when the PMP device is operating within a monitoring workflow: obtaining, by the PMP device, a series of measurements of a physiological parameter of a monitored patient; and displaying, by the PMP device, a monitoring workflow home screen on the display screen, the monitoring workflow home screen containing a first representation of the physiological parameter of the monitored patient, the first representation based on a measurement in the series of measurements; when the PMP device is operating within a non-monitoring workflow: obtaining, by the PMP device, a measurement of the physiological parameter of each patient in a series of patients; and displaying, by the PMP device, a non-monitoring workflow home screen on the display screen, the non-monitoring workflow home screen containing a second representation of the physiological parameter of a given patient in the series of patients, the second representation based on the measurement of the physiological parameter of the given patient in the series of patients; and when the PMP device is operating within a continuous workflow: obtaining, by the PMP device, continuous measurements of a continuous physiological parameter of the monitored patient; and displaying, by the PMP device, a continuous workflow home screen on the display screen, the continuous workflow home screen containing a third representation of the continuous physiological parameter of the monitored patient, the third representation based on a continuous measurement in the continuous measurements.

Yet another aspect includes a computer-readable storage medium comprising software instructions that, when executed, cause a physiological measurement platform (PMP) device to: obtain a series of measurements of a physiological parameter of a monitored patient when the PMP device is operating within a monitoring workflow; display, on the display screen, one of a plurality of workflow home screens, each of the workflow home screens being configured to address a different type of workflow; when a continuous workflow home screen is selected: obtain a continuous measurement of the physiological parameter of the monitored patient when the PMP device is operating within a continuous workflow; and display, on the display screen, the continuous workflow home screen when the PMP device is operating within the continuous workflow, the continuous workflow home screen containing a representation of the physiological parameter of the monitored patient, the representation based on the measurement of the physiological parameter of the monitored patient, the continuous workflow home screen including: an SpO2 frame displaying an oxygen saturation percentage and a pulse amplitude blip bar indicating a pulse beat relative pulse amplitude; an etCO2 frame displaying a numeric value representing etCO2 and a Capnogram waveform; an RR frame displaying a numeric value representing respirations per minute, wherein the aging is shown by changing a display color of the episodic data when an age of the data reaches a threshold.

DESCRIPTION OF THE DRAWINGS

FIG. 1 is a block diagram illustrating an example system for collecting measurements of physiological parameters of patients.

FIG. 2A illustrates a view of an example physiological parameter measuring platform (PMP) device.

FIG. 2B illustrates an example user interface displayed on a user interface display of the PMP device of FIG. 2A.

FIG. 3A illustrates an example continuous workflow home screen.

FIG. 3B illustrates an example monitoring workflow home screen.

FIG. 3C illustrates an example spot check workflow home screen.

FIG. 3D illustrates an example triage workflow home screen.

FIG. 3E illustrates an example alternative view of a patient's SpO2 level.

FIG. 3F illustrates the example monitoring workflow home screen when an alarm is active.

FIG. 3G illustrates the example monitoring workflow home screen when an alarm is active and when an alarm sound for the alarm has been temporarily silenced.

FIG. 4 illustrates an example patient selection screen.

FIG. 5 illustrates an example review screen.

FIG. 6A illustrates an example intervals pane of a settings screen.

FIG. 6B illustrates an example device pane of the settings screen.

FIG. 6C illustrates an example clinician pane of the settings screen.

FIGS. 6D-6F illustrate example profile panes of the settings screen.

FIG. 6G illustrates an example advanced pane of the settings screen.

FIG. 7A illustrates an example global pane of an alarms screen.

FIG. 7B illustrates an example temperature pane of the alarms screen.

FIG. 7C illustrates an example NIBP pane of the alarms screen.

FIG. 7D illustrates an example SpO2 pane of the alarms screen.

FIG. 7E illustrates an example pulse rate pane of the alarms screen.

FIG. 8 illustrates an example SpO2 frame of the continuous workflow home screen.

FIG. 9 illustrates an example SpHb frame of the continuous workflow home screen.

FIGS. 10A-10B illustrate an example etCO2 frame of the continuous workflow home screen.

FIGS. 11A-11B illustrate an example IPI frame of the continuous workflow home screen.

FIGS. 12A-12B illustrate an example RR frame of the continuous workflow home screen.

FIGS. 13A-13B illustrate an example NIPB frame of the continuous workflow home screen.

FIG. 14 is a flowchart illustrating an example operation performed by the PMP device.

FIG. 15 is a flowchart representing a continuation of the operation in which the workflow selection input indicates the triage workflow.

FIG. 16 is a flowchart representing a continuation of the operation in which the workflow selection input indicates the continuous workflow.

FIG. 17 is a flowchart illustrating an operation performed by the PMP device when the PMP device displays a workflow home screen.

FIG. 18 illustrates example physical components of the PMP device.

DETAILED DESCRIPTION

Embodiments of the present invention are directed to a physiological parameter measuring platform (PMP) device

having a user interface configured to operate within and transition between a plurality of workflows. These workflows can include a continuous workflow, a monitoring workflow, and a non-monitoring workflow.

In the following detailed description, references are made to the accompanying drawings that form a part hereof, and in which are shown by way of illustrations specific embodiments or examples. These embodiments may be combined, other embodiments may be utilized, and structural changes may be made without departing from the spirit or scope of the present disclosure. The following detailed description is therefore not to be taken in a limiting sense and the scope of the present disclosure is defined by the appended claims and their equivalents.

Referring now to the drawings, in which like numerals refer to like elements through the several figures, aspects of the present disclosure and an example computing operating environment will be described.

FIG. 1 is a block diagram illustrating an example system **100** for collecting measurements of physiological parameters of patients. As illustrated in the example of FIG. 1, the system **100** comprises an Electronic Medical Records (EMR) system **102**, an interface system **104**, a set of client devices **106A-106N** (collectively, "client devices **106**"), and a network **108**.

The network **108** is an electronic communication network that facilitates communication between the client devices **106** and the interface system **104**. An electronic communication network is a set of computing devices and links between the computing devices.

The computing devices in the network use the links to enable communication among the computing devices in the network. The network **108** can include routers, switches, mobile access points, bridges, hubs, intrusion detection devices, storage devices, standalone server devices, blade server devices, sensors, desktop computers, firewall devices, laptop computers, handheld computers, mobile telephones, and other types of computing devices. In various embodiments, the network **108** includes various types of links. For example, the network **108** can include wired and/or wireless links.

Furthermore, in various embodiments, the network **108** is implemented at various scales. For example, the network **108** can be implemented as one or more local area networks (LANs), metropolitan area networks, subnets, wide area networks (such as the Internet), or can be implemented at another scale.

The EMR system **102** is a computing system that allows storage, retrieval, and manipulation of electronic medical records. As used herein, a computing system is a system of one or more computing devices. A computing device is a physical, tangible device that processes data. Example types of computing devices include personal computers, standalone server computers, blade server computers, mainframe computers, handheld computers, smart phones, special purpose computing devices, and other types of devices that process data.

Each client device in the set of client devices **106** is a computing device. The client devices **106** can provide various types of functionality. For example, the set of client devices **106** can include one or more PMP devices (such as the PMP device **200**). In addition, the set of client devices **106** can include one or more wall-mounted devices. Such wall-mounted devices can have similar functionality to the PMP device **200** but are stationary instead of portable.

In addition, the set of client devices **106** can include one or more monitor devices. Such monitor devices can display representations of physiological parameters, but do not

directly obtain measurements of the physiological parameters from patients. A monitor device could, for example, be used by a clinician to monitor the physiological parameters of multiple patients.

The client devices **106** can communicate with each other through the network **108**. In various embodiments, the client devices **106** can communicate various types of data with each other through the network **108**. For example, in embodiments where the set of client devices **106** includes a set of PMP devices and a monitor device, each of the PMP devices can send data representing measurements of physiological parameters of patients to the monitor device. In this way, the monitor device can display representations of physiological parameters to a clinician.

The interface system **104** is a computing system that acts as an interface between the EMR system **102** and the client devices **106**. In some embodiments, the interface system **104** is a Connex system. Different EMR systems have different software interfaces. For example, the EMR system used by two different hospitals can have two different software interfaces. The interface system **104** provides a single software interface to each of the client devices **106**.

The client devices **106** send requests to software interface provided by the interface system **104**. When the interface system **104** receives a request from one of the client devices **106**, the interface system **104** translates the request into a request that works with the software interface provided by the EMR system **102**. The interface system **104** then provides the translated request to the software interface provided by the EMR system **102**.

When the interface system **104** receives a response from the EMR system **102**, the interface system **104** translates the response from a format of the EMR system **102** to a system understood by the client devices **106**. The interface system **104** then forwards the translated response to an appropriate one of the client devices **106**.

The client devices **106** can send various types of data to the interface system **104** for storage in the EMR system **102** and can receive various types of data from the EMR system **102** through the interface system **104**. For example, in some embodiments, the client devices **106** can send measurements of physiological parameters to the interface system **104** for storage in the EMR system **102**. In another example, a monitor device can retrieve past measurements of physiological parameters of patients from the EMR system **102** through the interface system **104**.

FIG. 2A illustrates a view of a PMP device **200**. The PMP device **200** is classified and referred to as a portable monitor platform device. The PMP device **200** includes multiple health care equipment (HCE) modules. Each of the HCE modules is configured to measure one or more physiological parameters of a health-care recipient, also referred to herein as a patient.

A temperature measurement module **212** is accessible from the front side of the PMP device **200**. An oxygen saturation (SpO2) module **214** and a non-invasive blood pressure (NIBP) module **216** are accessible from a left hand side of the PMP device **200**. An upper handle portion **220** enables the PMP device **200** to be carried by hand. Other modules, such as those described below, can also be used.

A front side of the PMP device **200** includes a display screen **218** and an outer surface of the temperature measurement module **212**. The temperature measurement module **212** is designed to measure the body temperature of a patient. As used in this document, a “module” is a combination of a physical module structure which typically resides within the

PMP device **200** and optional peripheral components (not shown) that typically attach to and reside outside of the PMP device **200**.

The temperature measurement module **212** includes a front panel **212a**. The front panel **212a** has an outer surface that is accessible from the front side of the PMP device **200**. The front panel **212a** provides access to a wall (not shown) storing a removable probe (not shown), also referred to as a temperature probe, that is attached to a probe handle **212b**. The probe and its attached probe handle **212b** are tethered to the temperature measurement module **212** via an insulated conductor **212c**. The probe is designed to make physical contact with a patient in order to sense a body temperature of the patient.

A left hand side of the PMP device **200** includes an outer surface of the SpO2 module **214** and an outer surface of the NIBP module **216**. The SpO2 module **214** is a HCE module designed to measure oxygen content within the blood of a patient. The NIBP module **216** is a HCE module designed to measure blood pressure of a patient.

As shown, the SpO2 module **214** includes a front panel **214a**. The front panel **214a** includes an outer surface that is accessible from the left side of the PMP device **200**. The front panel **214a** includes a connector **214b** that enables a connection between one or more peripheral SpO2 components (not shown) and a portion of the SpO2 module **214** residing inside the PMP device **200**. The peripheral SpO2 components reside external to the PMP device **200**. The peripheral SpO2 components are configured to interoperate with the SpO2 module **214** when connected to the SpO2 module **214** via the connector **214b**. In some embodiments, the peripheral SpO2 components include a clip that attaches to an appendage of a patient, such as a finger. The clip is designed to detect and measure a pulse and an oxygen content of blood flowing within the patient.

As shown, the NIBP module **216** includes a front panel **216a** having an outer surface that is accessible from the left side of the PMP device **200**. The front panel **216a** includes a connector **216b** that enables a connection between one or more peripheral NIBP components (not shown) and a portion of the NIBP module **216** residing inside the PMP device **200**. The peripheral NIBP components reside external to the PMP device **200**. The peripheral NIBP components are configured to interoperate with the NIBP module **216** when connected to the NIBP module **216** via the connector **216b**. In some embodiments, the peripheral NIBP components include an inflatable cuff that attaches to an appendage of a patient, such as an upper arm of the patient. The inflatable cuff is designed to measure the systolic and diastolic blood pressure of the patient, the mean arterial pressure (MAP) of the patient, and the pulse rate of blood flowing within the patient.

The PMP device **200** is able to operate within one or more workflows. A workflow is a series of one or more tasks that a user of the PMP device **200** performs. When the PMP device **200** operates within a workflow, the PMP device **200** provides functionality suitable for assisting the user in performing the workflow. When the PMP device **200** operates within different workflows, the PMP device **200** provides different functionality.

When the PMP device **200** is manufactured, the PMP device **200** is configured to be able to operate within one or more workflows. After the PMP device **200** is manufactured, the PMP device **200** can be reconfigured to operate within one or more additional workflows. In this way, a user can adapt the PMP device **200** for use in different workflows as needed.

In various embodiments, the PMP device **200** operates within various workflows. For example, in some embodiments, the PMP device **200** can operate within one or more of

a continuous workflow, a monitoring workflow, and/or a non-monitoring workflow. Example types of non-monitoring workflows include, but are not limited to, a spot check workflow and a triage workflow.

In example embodiments, the names for the workflows can be defined by the user. For example, the user can rename a “triage workflow” as “ED 3 North” or any other nomenclature as desired to provide more context to the user.

When the PMP device 200 is operating with the continuous workflow, the PMP device 200 obtains a series of measurements of one or more physiological parameters of a single monitored patient continuously over a period of time. The continuous measurements can be taken over short intervals, such as 1 millisecond, 0.5 second, 1 second, 2 seconds, etc. In addition, the PMP device 200 displays, on the display screen 218, a continuous workflow home screen. The continuous workflow home screen contains a representation of a physiological parameter of the monitored patient. The representation is based on the continuous measurements taken by the PMP device 200.

When the PMP device 200 is operating within the monitoring workflow (sometimes referred to as “intervals monitoring”) the PMP device 200 obtains a series of measurements of one or more physiological parameters of a single monitored patient periodically over a period of time. These periodic measurements can be taken at intervals such as 1 minute, 2 minutes, 5 minutes, 10 minutes, 15 minutes, 1 hour, 2 hours, 4 hours, 12 hours, etc. In addition, the PMP device 200 displays, on the display screen 218, a monitoring workflow home screen. The monitoring workflow home screen contains a representation of a physiological parameter of the monitored patient. The representation is based on at least one measurement in the series of measurements.

A representation of a physiological parameter is a visible image conveying information about the physiological parameter. For example, when the PMP device 200 is operating within the monitoring workflow, the PMP device 200 can obtain a temperature measurement of a single patient once every ten minutes for six hours. In this example, the PMP device 200 displays a monitoring workflow home screen that contains a representation of the patient’s body temperature based on a most recent one of the temperature measurements. In this way, a user of the PMP device 200 can monitor the status of the patient.

When the PMP device 200 is operating within a non-monitoring workflow, the PMP device 200 obtains a measurement of one or more physiological parameters from each patient in a series of patients. In addition, the PMP device 200 displays a non-monitoring workflow home screen on the display screen 218. The non-monitoring workflow home screen contains a representation of the physiological parameter of a given patient in the series of patients. The representation is based on the measurement of the physiological parameter of the given patient.

In one example, when the PMP device 200 is operating within a spot check workflow, the PMP device 200 obtains blood pressure measurements from a series of previously-identified patients. In this other example, the PMP device 200 displays a spot check workflow home screen containing a blood pressure measurement of a given patient in the series of previously-identified patients. In this way, a user of the PMP device 200 can perform spot checks on the blood pressures of patients who have already been admitted to a hospital.

As used in this document, a patient is a previously identified patient when the PMP device 200 stores information regarding the identity of the patient. In another example, when the PMP device 200 is operating within a triage work-

flow, the PMP device 200 can obtain a single blood pressure measurement from each patient in a series of unidentified patients as the patients arrive at a hospital.

In this example, the PMP device 200 displays a triage workflow home screen containing a representation of the patients’ blood pressure based on the single blood pressure measurements of the patients. In this way, a user of the PMP device 200 can perform triage on the series of unidentified patients as they arrive. As used in this document, a patient is an unidentified patient when the PMP device 200 does not store information regarding the identity of the patient.

The home screen for each type of workflow can be different to optimize the information shown. In some examples, the continuous monitoring workflow home screen displays measurements not shown in other workflows, such as SpO₂, PR, etCO₂, Fraction of inspired CO₂(FiCO₂), IPI, RR and/or SpHb. In addition, the continuous monitoring workflow can display both continuous and episodic measurements. See FIGS. 13A-13B described below.

In some embodiments, the monitoring workflow home screen includes at least one user-selectable control that is not included in the non-monitoring workflow home screen. In other embodiments, a representation of a physiological parameter in the monitoring workflow home screen has a different size than a representation of the same physiological parameter in the non-monitoring workflow home screen.

FIG. 2B illustrates an example user interface displayed on the display screen 218 of FIG. 2A. The PMP device 200 outputs and displays user interfaces discussed in this document on the display screen 218.

FIG. 3A illustrates an example continuous workflow home screen 250. The PMP device 200 displays the continuous workflow home screen 250 while the PMP device 200 is operating within a continuous workflow.

As described herein, the continuous workflow is designed for obtaining a continuous series of physiological measurements associated with an identified patient over a period of time.

As shown in the example of FIG. 3A, the continuous workflow home screen 250 includes a device status area 312, a navigation area 318, and a content area 270.

The device status area 312 contains data regarding a status of the PMP device 200. In the example of FIG. 3A, the device status area 312 includes text that identifies a clinician (“Patricia Jones”) and a health care facility location (“West 4A”). A current time of day value (“19:31”) is located towards the center of the device status area 312. A date value (“Jul. 3, 2012”) is located to the right side of the time of day value. A remaining time of a battery (“1:10”) value is located at the right side of the device status area 312.

In one example, the device status area 312 also includes a workflow indicator 252 that provides the user with an indication of the current workflow configuration for the PMP device 200. In this example, the workflow indicator 252 indicates that the PMP device 200 is in the “Continuous” workflow configuration. Other examples can include “Monitoring” and “Spot Check.”

The PMP device 200 is functionally connected to one or more sensors that enable monitoring of at least one physiological parameter that is associated with a patient. Typically, each sensor is physically attached to the patient while the PMP device 200 is operating within the continuous workflow. Examples of these sensors include a respiration rate (RR) probe, an SpO₂ probe, and an end tidal CO₂(etCO₂) probe that are each attachable to the PMP device 200 as described above.

The content area **270** illustrates the various measurements taken by the PMP device **200** while in the continuous workflow configuration. The examples include an IPI frame **254**, a SpO₂ frame **256**, an NIBP frame **257**, a SpHbv frame **258**, an RR frame **262**, an etCO₂ frame **264**, a pulse rate frame **265**, and a temperature frame **267**.

The continuous workflow home screen **250** also includes a patient information section **260** that provides information about the patient. As described herein, such information can include patient name, room number, age (e.g., adult or child), etc.

The navigation area **318** of the continuous workflow home screen **250** includes a home tab **318a**, a patients tab **318b**, an alarms tab **318c**, a review tab **318d**, a settings tab **318e**, and an applications tab **318f**. The home tab **318a**, the patients tab **318b**, the alarms tab **318c**, the review tab **318d**, the settings tab **318e**, and the applications tab **318f** are referred to herein collectively as the screen tabs **318**. Selection of screen tabs **318b-318f** causes substitution of the monitoring workflow home screen **300** with another screen associated with the screen tabs **318b-318e**. For example, the PMP device **200** displays a patient screen when a user selects the patients tab **318b**.

FIG. 4, discussed elsewhere in this document, illustrates an example patient selection screen. Furthermore, the PMP device **200** displays an alarms screen when a user selects the alarms tab **318c**. FIGS. 7A-7E, discussed elsewhere in this document, illustrate an example alarms screen. Furthermore, the PMP device **200** displays a review screen when a user selects the review tab **318d**. FIG. 5, discussed elsewhere in this document, illustrates an example review screen.

Furthermore, the PMP device **200** displays a settings screen when a user selects the settings tab **318e**. FIGS. 6A-6G, discussed elsewhere in this document, illustrate an example settings screen. When the PMP device **200** displays a screen other than the monitoring workflow home screen **300** and a user selects the home tab **318a**, the PMP device **200** displays the monitoring workflow home screen **300**.

The PMP device **200** displays applications that have been installed on the PMP device **200** when the applications tab **318f** is selected. Applications can be installed on the PMP device **200** to enhance the functionality of the PMP device **200**. One example of such an application is a body mass index (BMI) calculator that allows the caregiver to calculate a BMI on the PMP device **200**. When the applications tab **318f** is selected, a list of the installed application is provided, and one or more of the applications can be launched by selecting the application. Additional details regarding a PMP device including such applications is provided in Patent Cooperation Treaty Application No. PCT/US2010/045814 filed on Aug. 17, 2010, the entirety of which is hereby incorporated by reference.

FIG. 3B illustrates an example monitoring workflow home screen **300**. The PMP device **200** displays the monitoring workflow home screen **300** while the PMP device **200** is operating within a monitoring workflow. The monitoring workflow is designed for obtaining a series of physiological measurements associated with an identified patient over a period of time.

The PMP device **200** is functionally connected to one or more sensors that enable monitoring of at least one physiological parameter that is associated with a patient. Typically, each sensor is physically attached to the patient while the PMP device **200** is operating within the monitoring workflow. These sensors include a temperature probe, a SpO₂ clip, and a NIBP blood pressure cuff that are each attachable to the PMP device **200** as described above.

As shown in the example of FIG. 3B, the monitoring workflow home screen **300** includes the device status area **312**, the navigation area **318**, and a content area **320**. The content area **320** is divided into a parameter reporting area **314** and a patient attribute area **316**.

The parameter reporting area **314** includes one or more parameter reporting frames. Each of the parameter reporting frames contains a representation of a different physiological parameter for a patient. The representations are based on one or more measurements of the physiological parameters of a monitored patient. In addition, each of the parameter reporting frames contains an alarm reporting area. The alarm reporting areas specify upper alarm limits and lower alarm limits for the physiological parameters. The upper alarm limits and the lower alarm limits define the alarm ranges for the physiological parameters. Alarms associated with the physiological parameters are active when measurements of the physiological parameters are outside the alarm range for the physiological parameters.

In the example of FIG. 3B, the parameter reporting area **314** contains a NIBP frame **314a**, a pulse rate frame **314b**, a SpO₂ frame **314c**, and a temperature frame **314d**. The NIBP frame **314a** is located within an upper left portion of the parameter reporting area **314**. The pulse rate frame **314b** is located within an upper right portion of the parameter reporting area **314**. The SpO₂ frame **314c** is located within a lower left portion of the parameter reporting area **314**. The temperature frame **314d** is located within a lower right portion of the parameter reporting area **314**.

The NIBP frame **314a** contains a representation of the blood pressure of the patient. The representation of the blood pressure of the patient is based on one or more measurements of the blood pressure of the patient. In various embodiments, the NIBP frame **314a** contains various representations of the blood pressure of the patient. In the example of FIG. 3B, the NIBP frame **314a** includes enlarged numerical text that represents a systolic blood pressure value (“120”) and a diastolic blood pressure value (“80”), separated from each other via a slash ‘/’ text character. The systolic blood pressure value is located at the left side of the NIBP frame **314a** and the diastolic blood pressure is located to the right side of the systolic blood pressure value.

An NIBP alarm status area **322c** is located at the right side of the NIBP frame **314a**. The NIBP alarm status area **322c** specifies an upper alarm limit and a lower alarm limit for the patient’s systolic blood pressure and an upper alarm limit and a lower alarm limit for the patient’s diastolic blood pressure. The upper alarm limit and the lower alarm limit for the patient’s systolic blood pressure define a systolic blood pressure alarm range. The upper alarm limit and the lower alarm limit for the patient’s diastolic blood pressure define a diastolic blood pressure alarm range. An alarm associated with the patient’s blood pressure is active when the patient’s systolic blood pressure is outside the systolic blood pressure alarm range or when the patient’s diastolic blood pressure is outside the diastolic blood pressure alarm range.

The NIBP frame **314a** also contains a NIBP cuff inflation stop button **322a**. The NIBP cuff inflation stop button **322a** is labeled with the text “Stop.” The NIBP frame **314a** also contains a NIBP automatic interval timer **322b**. The NIBP automatic interval timer **322b** is located between the diastolic blood pressure value and the NIBP alarm status area **322c**. Selection of the NIBP cuff inflation stop button **322a** ceases inflation of the NIBP cuff and toggles the label of the NIBP cuff inflation stop button **322a** to display the (“Start”) text. As used herein, a user selects a button or control when the user provides input to the PMP device **200** that specifies the con-

trol. For example, a user can select a control by pressing the control, by pressing another button while the control is highlighted, or by another means. Selection of the NIBP cuff inflation stop button **322a** (now labeled the “Start” button) restarts inflation of the NIBP cuff and toggles the label of the NIBP cuff inflation stop button **322a** to display the (“Stop”) text. The NIBP automatic interval timer **322b** indicates an amount of time remaining before the next scheduled inflation of the NIBP cuff. Additionally, a user can determine the age of the current NIBP reading on the NIBP frame **314a** by subtracting the remaining time on the NIBP automatic interval timer **322b** from the original interval duration. In the example of FIG. 3B, the NIBP frame **314a** also displays a MAP value in an extended label field **322d**.

The pulse rate frame **314b** contains a representation of the patient’s pulse rate. The representation of the patient’s pulse rate is based on one or more measurements of the patient’s pulse rate. In different embodiments, the pulse rate frame **314b** contains different representations of the patient’s pulse rate. In the example of FIG. 3B, the pulse rate frame **314b** includes enlarged numerical text that represents a pulse rate value (“122”). The pulse rate value (“122”) is located at the left side of the pulse rate frame **314b**. A pulse rate alarm status area **324a** is located at the right side of the pulse rate frame **314b**. The pulse rate frame **314b** also indicates a source of the pulse rate in an extended label field **324b**.

The pulse rate alarm status area **324a** specifies an upper alarm limit and a lower alarm limit. The upper alarm limit and the lower alarm limit define a pulse rate alarm range. An alarm associated with the patient’s pulse rate is active when the patient’s pulse rate is outside the pulse rate alarm range.

The SpO₂ frame **314c** contains a representation of the patient’s SpO₂ level. The representation of the patient’s SpO₂ level is based on one or more measurements of the patient’s SpO₂ level. In different embodiments, the SpO₂ frame **314c** contains different representations of the patient’s SpO₂ level. In the example of FIG. 3B, the SpO₂ frame **314c** includes enlarged numerical text that represents an SpO₂ value (“97%”). The SpO₂ value (“97%”) is located at the left side of the SpO₂ frame **314c** and is accompanied by a “%” text character on the right side of the SpO₂ value. A SpO₂ alarm status area **326a** is located at the right side of the SpO₂ frame **314c**. An SpO₂ alarm parameter **326d**, appearing as a circle adjacent to the text (“25”), indicates a duration of time. The SpO₂ alarm status area **326a** specifies an upper alarm limit and a lower alarm limit. The upper alarm limit and the lower alarm limit define a SpO₂ alarm range. An alarm associated with the patient’s SpO₂ level is active when the patient’s SpO₂ level is outside the SpO₂ alarm range for the duration of time indicated by the SpO₂ alarm parameter **326d**. The SpO₂ frame **314c** also includes a pulse amplitude blip bar **326b** which indicates pulse beat and shows the relative pulse amplitude. As the detected pulse becomes stronger, more bars in the pulse amplitude blip bar **326b** light up. The SpO₂ frame **314c** also includes an SpO₂ response time control button **326c** that is configured for a user to control the SpO₂ alarm parameter **326d**.

The temperature frame **314d** contains a representation of the patient’s body temperature. The representation of the patient’s body temperature is based on one or more measurements of the patient’s body temperature. In different embodiments, the temperature frame **314d** contains different representations of the patient’s body temperature. In the example of FIG. 3B, the temperature frame **314d** includes enlarged numerical text that represents a temperature value (“101.5”). The temperature value (“101.5”) is located at the left side of the temperature frame **314d** and is accompanied by a Fahr-

enheit degree indicating symbol on the right side of the temperature value. A temperature alarm status area **328a** is located at the right side of the temperature frame **314d**. The temperature alarm status area **328a** specifies an upper alarm limit and a lower alarm limit. The upper alarm limit and the lower alarm limit define a temperature alarm range. An alarm associated with the patient’s temperature is active when the patient’s temperature level is outside the temperature alarm range.

In some embodiments, the PMP device **200** can measure the patient’s temperature in either a predictive mode or in a direct mode. When the PMP device **200** measures the patient’s temperature in the predictive mode, the PMP device **200** predicts the patient’s current temperature based on periodic readings of the patient’s temperature. When the PMP device **200** measures the patient’s temperature in the direct mode, the PMP device **200** continually measures the patient’s temperature.

The temperature value in the temperature frame **314d** is based on measurements received from a thermometer attached to a patient. When the PMP device **200** measures the patient’s temperature in the predictive mode, the thermometer can be located at various places on the patient’s body. Example locations on the patient’s body where the thermometer can be located include in the patient’s mouth, on the patient’s thigh, in the patient’s armpit, in the patient’s rectum, and other locations. The temperature frame **314d** includes a thermometry location control **328b**. The thermometry location control **328b** indicates a location on the patient’s body where the thermometer is located. In the example of FIG. 3B, the thermometry location control **328b** indicates that the thermometer is located in the patient’s mouth.

When a user selects the thermometry location control **328b**, the PMP device **200** updates the thermometry location control **328b** such that the thermometry location control **328b** indicates a different location on the patient’s body or whether the PMP device **200** is to obtain measurements of the patient’s temperature in direct mode. The user can continue selecting the thermometry location control **328b** until the thermometry location control **328b** indicates a location where the thermometer is located on the patient’s body or until the thermometry location control **328b** indicates that measurements are to be obtained in direct mode. For example, in some embodiments, the PMP device **200** accepts readings from a thermometer when the thermometer is located in the patient’s mouth, in an adult patient’s armpit, or in a pediatric patient’s armpit. In this example, the thermometry location control **328b** initially indicates that the thermometer is in a patient’s mouth. When the user selects the thermometry location control **328b** one time, the thermometry location control **328b** indicates that the thermometer is located in an adult patient’s armpit. When the user selects the thermometry location control **328b** again, the thermometry location control **328b** indicates that the thermometer is located in a pediatric patient’s armpit. When the user selects the thermometry location control **328b** yet again, the thermometry location control **328b** indicates that the measurements of the patient’s temperature are to be obtained in direct mode. When the user selects the thermometry location control **328b** yet again, the thermometry location control **328b** again indicates that the thermometer is located in a patient’s mouth.

The display screen **218** enables a user to select the parameter reporting frames **314a-314d** in order to change how the physiological parameters are represented in the parameter reporting frames **314a-314d**. In other words, each of the parameter reporting frames **314a-314d** contains an initial representation of a physiological parameter. The parameter

reporting frame displays an alternate representation of the physiological parameter instead of the initial representation of the physiological parameter when a user selects the parameter reporting frame. For example, selecting the temperature frame **314d** toggles the temperature value between being expressed in Fahrenheit or Centigrade. This feature is referred to as “tap to toggle.” In another example, when a user selects the pulse rate frame **314b**, the PMP device **200** displays a waveform in the pulse rate frame **314b** instead of a number representing the patient’s current pulse rate. The waveform represents a patient’s pulse over time. In this example, when the user selects the pulse rate frame **314b** again, the PMP device **200** displays a number in the pulse rate frame **314b** representing the patient’s current pulse rate. In yet another example, when the user selects the SpO2 frame **314c**, the PMP device **200** displays a plethysmographic waveform view in the SpO2 frame **314c**. FIG. 3E illustrates an example alternate representation of a patient’s SpO2 level. In the example of FIG. 3E, the SpO2 frame **314c** contains a plethysmographic waveform view **325**.

The patient attribute area **316** contains data that specify attributes of a patient. In various embodiments, the patient attribute area **316** contains data that specify various attributes of a patient. For example, in some embodiments, text that identifies a patient is located at the left side of the patient attribute area **316**. In the example of FIG. 3B, the patient attribute area **316** contains the value “83645211” to identify the patient.

Furthermore, in the example of FIG. 3B, the patient attribute area **316** contains a patient type button **316b** that is labeled with the text “Adult.” The patient type button **316b** is located towards the center of the patient attribute area **316**. Patient-related attribute values that are labeled with the text (“HEIGHT”), (“WEIGHT”), (“PAIN”) and (“RR”) are located to the right side of the patient type button **316b**. A save button **316g** that is labeled with the text (“Save”) is located at the right side of the patient attribute area **316**.

The patient type button **316b** indicates a value of a patient type parameter associated with the current patient. The patient type parameter can store a value of “Adult”, “Pediatric”, or “Neonatal” patient type. The patient type parameter controls the amount of air pressure applied to the NIBP cuff. Furthermore, in some embodiments, the patient type parameter controls the default alarm limits for the patient’s physiological parameters. Thus, by using the patient type button **316b** to change the patient type parameter, the user can automatically change the alarm limits for the patient’s physiological parameters. As described elsewhere in this document, the user can also manually set the alarm limits for physiological parameters. When a user selects the patient type button **316b**, the monitoring workflow home screen **300** is replaced by the patient selection screen as if the patients tab **318b** was selected.

When the save button **316g** is selected while the PMP device is operating in the monitoring workflow, the PMP device **200** saves a patient reading to local non-volatile storage within the PMP device **200**. The patient reading is a set of data that includes measurements of the physiological parameters of the patient. If applicable, the patient reading can also include data indicating attributes of the patient. A user can use the review screen to review saved patient reading. Furthermore, in some embodiments, the PMP device **200** automatically attempts to transmit the patient reading to another computing node. A user can use the settings screen to specify the other computing node. In some embodiments, the other computing node is an electronic medical records system. Optionally, the other computing node is the interface system **104**.

The PMP device **200** does not clear the monitoring workflow home screen **300** when the save button **316g** is selected.

The PMP device **200** can be configured to automatically save measurements as well. For example, when in the continuous workflow mode, the PMP device **200** can be configured to automatically store measured values at periodic intervals, such as once per second, once per minute, once every 5 minutes, etc.

The monitoring workflow is designed for obtaining a series of measurements of one or more physiological parameters of an identified patient over a period of time. A user uses the patient selection screen to select the identified patient. The PMP device **200** is programmable via an intervals pane of the settings screen to periodically record measurements of one or more physiological parameters over time from the identified patient.

A user may select the save button **316g** one or more times. Each time the user selects the save button **316g**, the PMP device **200** locally saves the patient reading and may attempt to send the patient reading to another computing node. The sending is dependent on the workflow in which the PMP device **200** is operating. In the spot check workflow (see FIG. 3C), the PMP device **200** automatically sends the patient reading because a clinician is present when the measurements are obtained. When the PMP device **200** is operating in the monitoring workflow, a clinician may not be always present. Thus, the patient reading is not sent automatically. Instead, a clinician navigates to the review screen (See FIG. 5) and manually selects the patient reading that the user wants to send.

When the PMP device **200** is operating in the monitoring workflow, the representations of the physiological parameters and patient attributes remain displayed on the monitoring workflow home screen **300**, regardless of whether or not the patient reading is saved locally and/or transmitted to another computing node in response to a selection of the save button **316g**. Unlike the spot check and triage workflows, the PMP device **200** does not clear the monitoring workflow home screen **300** when a user selects the save button **316g**.

In some embodiments, the home screens for each workflow supported by the PMP device **200** contain at least one common user interface element. The common user interface element has the same appearance in each of the home screens, but does not necessarily perform the same function in the home screens of the different workflows. In the example of FIG. 3B, the patient type button **316b** and the save button **316g** are user interface elements that are included within and common to the monitoring workflow home screen **300** and to home screens for the spot check workflow (FIG. 3C) and the triage workflow (FIG. 3D). Further, the patient type button **316b** and the save button **316g** have a same appearance but also have different functions depending upon which workflow the PMP device **200** is operating within.

When the PMP device **200** is operating in the monitoring workflow, the PMP device **200** clears the monitoring workflow home screen **300** upon discharge of the current (first) identified patient for which physiological parameters are being obtained. When the PMP device **200** clears the monitoring workflow home screen **300**, the PMP device **200** modifies the monitoring workflow home screen **300** such that the monitoring workflow home screen **300** no longer contains data representing physiological parameters of a patient and attributes of the patient. The monitored patient is discharged by the selection of another (second) identified patient for which to obtain physiological data, via the patient selection screen **400** or by power-cycling the PMP device **200**. Upon selection of the second patient, the PMP device **200** locally

stores the patient reading for the first patient and transmits the patient reading for the first patient to another computing node when a user selects a send patient reading control **448a** on the review screen (see FIG. 5). Upon attaching the sensors to the second identified patient, the PMP device **200** obtain measurements of a set of one or more physiological parameter from the second identified patient, periodically over time.

Unlike the home screens for non-monitoring workflows (e.g., the spot check workflow and the triage workflow), the monitoring workflow home screen **300** provides direct access to the alarm screen via the alarm status areas **322c**, **324a**, **326a**, **328a** located within the parameter reporting frames **314a-314d**. Each alarm status area **322c**, **324a**, **326a**, **328a** (including the bell-shaped symbols) indicates high and low alarm limits and provides a visual indication of when an alarm is active.

FIG. 3F illustrates the monitoring workflow home screen **300** when an alarm is active. When an alarm is active with respect to a particular physiological parameter, a perimeter around the parameter reporting frame for the particular physiological parameter transitions from a gray color to a red color. Changing the color of the perimeter provides a visual indication that the alarm is active. In some embodiments, the perimeter around the parameter reporting frame also flashes, thereby providing another visual indication that the alarm is active. Furthermore, the bell-shaped symbol within the alarm status area transitions from a white color to a red or yellow color, depending on a priority of the alarm. This provides another visual indication that the alarm is active. When the alarm is resolved, the bell-shaped symbol within the alarm status area transitions from the red or yellow color to the white color. In the example of FIG. 3F, an alarm associated with the patient's pulse rate is active. Accordingly, the perimeter around the pulse rate frame **314b** is red instead of gray.

Furthermore, as illustrated in the example of FIG. 3F, when an alarm associated with a particular physiological parameter is active, the PMP device **200** causes the device status area **312** to display an alarm message **380**. The alarm message **380** visually indicates that an alarm is active and indicates a brief description of the alert. In the example FIG. 3F, the alarm message **380** indicates that the reason for the alert is that the patient's heart rate is too high.

Furthermore, when an alarm associated with a particular physiological parameter is active, the PMP device **200** emits an alarm sound. The PMP device **200** continues to emit the alarm sound until the alarm is deactivated or until a user temporarily silences the alarm sound. When the user temporarily silences the alarm sound, the PMP device **200** suspends emitting the alarm sound for a given time period. In various embodiments, the user is able to temporarily silence the alarm sound in various ways. For example, in some embodiments, the user temporarily silences the alarm sound by touching the parameter reporting frame corresponding to the alarm. In other embodiments, the user temporarily silences the alarm sound by touching the alarm message **380**. In yet other embodiments, the user temporarily silences the alarm sound by selecting a physical button on the PMP device **200**.

When the user temporarily silences the alarm sound, the PMP device **200** resumes emitting the alarm sound after a given time period expires. For example, in some embodiments, the PMP device **200** resumes emitting the alarm sound after 30 seconds. When the user temporarily silences the alarm sound, the alarm message **380** indicates a time remaining before the PMP device **200** resumes emitting the alarm sound.

FIG. 3G illustrates the monitoring workflow home screen **300** when an alarm is active and when the alarm sound for the

alarm has been temporarily silenced. In the example of FIG. 3G, the alarm message **380** indicates that eighty-nine seconds remain before the PMP device **200** resumes emitting the alarm sound.

In some embodiments, the user is able to temporarily silence the alarm sound for various lengths of time by selecting a button on the PMP device **200** or a control displayed by the PMP device **200** multiple times. For example, when the user selects the alarm message **380** one time, the PMP device **200** resumes emitting the alarm sound after sixty seconds. In this example, each time the user selects the alarm message **380**, the PMP device **200** adds thirty seconds to the length of time before the PMP device **200** resumes emitting the alarm sound. In some embodiments, the PMP device **200** prevents the user from temporarily silencing the alarm sound for more than a given amount of time. For example, in some embodiments, the PMP device **200** prevents the user from temporarily silencing the alarm sound for more than five minutes.

When the user temporarily silences an alarm sound for an alarm, the monitoring workflow home screen **300** visually indicates that the alarm sound has been temporarily silenced. In various embodiments, the monitoring workflow home screen **300** visually indicates that the alarm sound has been temporarily silenced in various ways. For example, in some embodiments, the alarm message **380** contains a bell-shaped icon when the alarm sound has been temporarily silenced. In this example, the bell-shaped icon has an X-shaped mark over a bell. The lines of the X-shaped mark are dashed. In other example embodiments, the alarm message **380** or other parts of the monitoring workflow home screen **300** contain differently shaped icons or visual indicators.

The alarm status areas **322c**, **324a**, **326a**, **328a** act as navigational short cuts to appropriate panes within the alarms screen for each respective physiological parameter (See FIG. 7A). In this way, selecting an alarm status area while no alarm is active results in the PMP device **200** displaying the same user interface as if a user selects the alarms tab **318c** and then selects an appropriate pane of the alarms screen. Navigation to the appropriate pane of the alarms screen happens only when the PMP device **200** is not emitting an alarm sound. In other words, the first selection of this area (or anywhere in the parameter reporting frame) would cause the alarm to silence the audio. A subsequent selection of the alarm status area performs the navigation.

Various alarms have various priority levels. For example, an alarm associated with a patient's pulse rate has a high priority level and an alarm associated with detachment of a SpO2 clip has a medium priority level. The PMP device **200** visually and/or sonically indicates alarms having different priority levels in different ways. For example, in some embodiments, when an alarm having a high priority level is active, the PMP device **200** displays visual indications of the alarm in a given color, such as red. When an alarm having a medium or low priority level is active, the PMP device **200** displays visual indications of the alarm in another color, such as yellow. Furthermore, in some embodiments, when an alarm having a high priority level is active, the PMP device **200** emits a given alarm sound, such as a continuous tone. When an alarm having a medium or low priority level is active, the PMP device **200** emits another alarm sound, such as a periodic beep.

When the PMP device **200** is operating in different workflows, the PMP device **200** can activate different alarms and/or emit different alarm sounds. For example, the PMP device **200** activates an alarm when a SpO2 clip detachment event occurs while the PMP device **200** operating within the monitoring workflow, but does not activate the alarm while in a

non-operating in the monitoring workflow. This feature can be convenient considering that the PMP device 200 and the patient are more likely to be unattended by a user of the PMP device 200 for periods of time when the PMP device 200 is operating in the monitoring workflow, but less likely when the PMP device 200 is operating in the spot check or the triage workflows. In one embodiment, monitoring of SpO2 may be prevented by the PMP device 200 beyond ten minutes if the PMP device 200 is operating in the spot check or the triage workflows.

Under certain circumstances, multiple alarms can be active concurrently. For example, one alarm can be active because a patient's pulse rate is too high and another alarm can be active because a SpO2 clip has been detached from the patient. When multiple alarms are active concurrently, the PMP device 200 indicates that multiple alarms are active. In various embodiments, the PMP device 200 indicates that multiple alarms are active in various ways. For example, in some embodiments, the alarm message 380 includes an icon that indicates a number of alarms that are currently active. In this example, icon can be a triangle containing the number of alarms that are currently active.

In some embodiments, the PMP device 200 displays different visual indicators depending on the priority levels of concurrently active alarms. For example, when two or more high level alarms are active concurrently, the PMP device 200 displays visual indications for each of the high level alarms. In another example, when an alarm having a medium priority level ("the medium level alarm") and an alarm having a high priority level ("the high level alarm") are active concurrently, the PMP device 200 displays visual indications for the high level alarm and does not display visual indications for the medium level alarm. If the user of the PMP device 200 temporarily silences the alarm sound for the high level alarm, the PMP device 200 does not emit the alarm sound for the high level alarm or the alarm sound for the medium level alarm. When the high level alarm is resolved before the medium level alarm is resolved, the PMP device 200 displays visual indications for the medium level alarm and the PMP device 200 resumes emitting the alarm sound for the medium level alarm.

In some embodiments, the user of the PMP device 200 is able to toggle between multiple concurrently active alarms by selecting one or more controls in the user interface of the PMP device 200 or by selecting one or more buttons on the PMP device 200. In this way, the user causes the PMP device 200 to display the visual indications for each of the multiple concurrently active alarms. For example, a first alarm and a second alarm can be concurrently active. In this example, the PMP device 200 displays an alarm message describing a first alarm. In this example, the PMP device 200 modifies the alarm message to describe a second alarm when a user selects the alarm message.

In some alternative embodiments, the PMP device 200 enables a user to customize the content within the monitoring workflow home screen 300. For example, the PMP device 200 enables a user to adjust the relative sizes of the parameter reporting frames 314a-314d within the monitoring workflow home screen 300. In another example, the PMP device 200 enables the user to add or remove parameter reporting frames from the monitoring workflow home screen 300. Furthermore, in some such embodiments, the PMP device 200 includes one or more predefined templates for the monitoring workflow home screen 300. Each of the predefined templates specifies a predefined set of content within the monitoring workflow home screen 300. For example, one predefined template specifies that the monitoring workflow home screen

300 includes a large parameter reporting frame for the patient's blood pressure and three smaller parameter reporting frames for the patient's pulse rate, SpO2 level, and body temperature. In this example, another predefined template specifies that the monitoring workflow home screen 300 includes only a frame for the patient's SpO2 level and the patient's blood pressure. The user can customize the content within the monitoring workflow home screen 300 by selecting one of these predefined templates or by modifying one of these predefined templates.

FIG. 3C illustrates an example spot check workflow home screen 330. The PMP device 200 displays the spot check workflow home screen 330 when the PMP device 200 is operating in a spot check workflow. The spot check workflow home screen 330 is referred to as the "Home" screen for the spot check workflow. Like when the PMP device 200 is operating in the monitoring workflow, each sensor is physically attached to an identified patient when the PMP device 200 is operating in the spot check workflow. These sensors include a temperature probe, a SpO2 clip, and a NIBP blood pressure cuff. As described elsewhere in this document, the temperature probe, the SpO2 clip and the NIBP blood pressure cuff are peripheral to the PMP device 200.

Also, like the monitoring workflow home screen 300 illustrated in the example of FIG. 3B, the spot check workflow home screen 330 includes a device status area 312, a content area 320, and a navigation area 318. The content area 320 includes a parameter reporting area 314 and a patient attribute area 316. The parameter reporting area 314 of the spot check workflow home screen 330 includes an NIBP frame 334a, a pulse rate frame 314b, a SpO2 frame 334c and a temperature frame 334d.

The NIBP frame 334a contains a representation of a patient's blood pressure. The representation is based on one or more measurements of the blood pressure of a previously identified patient. In the example of FIG. 3C, the NIBP frame 334a includes text representing the patient's systolic and diastolic blood pressure. In the spot check workflow home screen 330, the text representing the patient's systolic and diastolic blood pressure is larger than the text in the monitoring workflow home screen 300 representing the patient's systolic and diastolic blood pressure. The NIBP frame 334a of the spot check workflow home screen 330 does not include the NIBP alarm status area 322c and does not include the NIBP automatic interval timer 322b of the monitoring workflow home screen 300.

The pulse rate frame 334b contains a representation of the patient's pulse rate. The representation is based on one or more measurements of the pulse rate of the patient. In the example of FIG. 3C, the pulse rate frame 334b includes text representing the patient's pulse rate. In the spot check workflow home screen 330, the text representing the patient's pulse rate is larger than the text in the monitoring workflow home screen 300 representing the patient's pulse rate. The pulse rate frame 334b of the spot check workflow home screen 330 does not include the pulse rate alarm status area 324a included within the pulse rate frame 314b of the monitoring workflow home screen 300.

The SpO2 frame 334c contains a representation of the patient's SpO2 level. The representation is based on one or more measurements of the SpO2 level of the patient. In the example of FIG. 3C, the SpO2 frame 334c includes text representing the SpO2 value. In the spot check workflow home screen 330, the text representing the patient's SpO2 level is larger than the text in the monitoring workflow home screen 300 representing the patient's SpO2 level. The SpO2 frame 334c does not include the alarm status area 326a, the

SpO2 response time control button **326c**, or the SpO2 alarm parameter **326d** of the SpO2 frame **314c** of the monitoring workflow home screen **300**.

The temperature frame **334d** contains a representation of the patient's body temperature. The representation is based on one or more measurements of the body temperature of the patient. In the example of FIG. 3C, the temperature frame **334d** includes text representing the patient's body temperature. In the spot check workflow home screen **330**, the text representing the patient's body temperature is larger than the text in the monitoring workflow home screen **300** representing the patient's body temperature. The temperature frame **334d** of the spot check workflow home screen **330** does not include the temperature alarm status area **328a** included within the temperature frame **314d** of the monitoring workflow home screen **300**.

The patient attribute area **316** of the spot check workflow home screen **330** includes text that identifies the patient by name, initials, numerical identifier, or location. In the example of FIG. 3C, the patient attribute area **316** includes text that identifies the patient as "Bar, D." A user is able use the settings screen to configure the PMP device **200** to identify the patient by name or by number. The user is also able to use the settings screen to configure the PMP device **200** not to save or send patient readings when the PMP device **200** does not store information regarding the identity of the patient.

The navigation area **318** of the spot check workflow home screen **330** includes the home tab **318a**, the patients tab **318b**, the review tab **318d**, and the settings tab **318e**. The navigation area **318** excludes the alarms tab **318c** included in the navigation area **318** of the monitoring workflow home screen **300**. As a result, the spot check workflow home screen **330** does not provide direct navigation to the alarms screen as provided by the monitoring workflow home screen **300**.

When the PMP device **200** is operating in the spot check workflow, the PMP device **200** locally saves a patient reading and attempts to send the patient reading to another computing node when a user selects the save button **316g**. The patient reading includes measurements of the physiological parameters of the patient and data identifying the patient. Unlike when the PMP device **200** is operating in the monitoring workflow, the PMP device **200** clears the spot check workflow home screen **330** when the user selects the save button **316g**. When the PMP device **200** clears the spot check workflow home screen **330**, the PMP device **200** modifies the spot check workflow home screen **330** such that the spot check workflow home screen **330** no longer contains representations of the physiological parameters of the patient and attributes of the patient.

Because the PMP device **200** clears the spot check workflow home screen **330** when a user selects the save button **316g** of the spot check workflow home screen **330**, a first identified patient is essentially discharged when the user selects the save button **316g**. After selecting the save button **316g**, the user selects a second identified patient via the patient selection screen. Upon attaching the sensors to the second identified patient, the PMP device **200** obtains a set of one or more physiological parameter values from the second identified patient.

The spot check workflow is designed for obtaining measurements of physiological parameters from each patient in a series of identified patients. A user selects each patient in the series of identified patients from the patient selection screen. Alternatively, a user can select each patient in the series of identified patient by scanning barcodes of the patients, thereby bypassing the patient selection screen. Further, a user can identify a patient at any step in the workflow prior to

saving the patient reading of the spot check workflow home screen **330**. Upon attaching the sensors a patient in the series of identified patients, a user uses the PMP device **200** to obtain measurements of one or more physiological parameters of that patient. Typically, the PMP device **200** is attached to a first patient for no more time than is required to obtain one measurement for each of the NIBP, the pulse rate, the SpO2, and the body temperature of the first patient. The user then detaches the sensors from the first patient and attaches the sensors to a second patient that is next in the series of patients.

In one use scenario, a user can use the spot check workflow "making rounds" within a health care facility. For example, a clinician can use the PMP device **200** to obtain one set of measurements of physiological parameters for each patient in a group of twelve patients within a health care facility. Optionally, the clinician can transport the PMP device **200** sequentially to each patient in the group of patients within one "round" of obtaining measurements of physiological parameters. Each "round" of obtaining measurements of physiological parameters can be obtained for each patient in the patients of the group every hour during a working shift.

In some embodiments, the PMP device **200** enables a user to customize the content within the spot check workflow home screen **330**. For example, the PMP device **200** enables a user to adjust the relative sizes of the parameter reporting frames **334a-334d** within the spot check workflow home screen **330**. In another example, the PMP device **200** enables the user to add or remove parameter reporting frames from the spot check workflow home screen **330**. Furthermore, in some such embodiments, the PMP device **200** includes one or more predefined templates for the spot check workflow home screen **330**. Each of the predefined templates specifies a predefined set of content within the spot check workflow home screen **330**. The user can customize the content within the spot check workflow home screen **330** by selecting one of these predefined templates or by modifying one of these predefined templates.

FIG. 3D illustrates an example triage workflow home screen **360**. The PMP device **200** displays the triage workflow home screen **360** when the PMP device **200** is in a triage workflow.

Like when the PMP device **200** is operating in the monitoring workflow or the spot check workflow, a user physically attaches each sensor to an unidentified patient when the PMP device **200** is operating in the triage workflow. These sensors include the temperature probe, the SpO2 clip, and the blood pressure cuff that are each attachable to the PMP device **200** as described elsewhere in this document.

The triage workflow home screen **360** includes a device status area **312**, a content area **320**, and a navigation area **318**. The content area **320** of the triage workflow home screen **360** includes a parameter reporting area **314** and a patient attribute area **316**. The parameter reporting area **314** of the triage workflow home screen **360** includes an NIBP frame **364a**, a pulse rate frame **364b**, a SpO2 frame **364c** and a temperature frame **364d**.

The NIBP frame **364a** contains a representation of the systolic and diastolic blood pressure of the patient. The representation is based on one or more measurements of the blood pressure of the patient. In the example of FIG. 3D, the NIBP frame **364a** includes text representing the systolic and diastolic blood pressure of the patient. The size of the text in the NIBP frame **364a** is similar to the size of the text in the NIBP frame **334a** of the spot check workflow home screen **330** and larger than the size of the text in the NIBP frame **314a** of the monitoring workflow home screen **300**. The NIBP frame **364a** does not include the NIBP alarm status area **322c**

and does not include the NIBP automatic interval timer **322b** included in the NIBP frame **314a** of the monitoring workflow home screen **300**.

The pulse rate frame **364b** contains a representation of the pulse rate of the patient. The representation is based on one or more measurements of the pulse rate of the patient. In the example of FIG. 3D, the pulse rate frame **364b** contains text representing the pulse rate value of the patient. The size of the text in the pulse rate frame **364b** is similar to the size of the text in the pulse rate frame **334b** of the spot check workflow home screen **330** and larger than the size of the text in the pulse rate frame **314b** of the monitoring workflow home screen **300**. The pulse rate frame **364b** does not include the pulse rate alarm status area **324a** that is included within the pulse rate frame **314b** of the monitoring workflow home screen **300**.

The SpO₂ frame **364c** contains a representation of the SpO₂ level of the patient. The representation is based on one or more measurements of the SpO₂ level of the patient. In the example of FIG. 3D, the SpO₂ frame **364c** includes text representing the SpO₂ value of the patient. The size of the text in the SpO₂ frame **364c** is similar to the size of the text in the SpO₂ frame **334c** of the spot check workflow home screen **330** and larger than the size of the text in the SpO₂ frame **314c** of the monitoring workflow home screen **300**. The SpO₂ frame **364c** does not include the alarm status area **326a**, the SpO₂ response time control button **326b**, or the SpO₂ alarm parameter **326b** of the SpO₂ frame **314c** of the monitoring workflow home screen **300**.

The temperature frame **364d** contains a representation of the body temperature of the patient. The representation is based on one or more measurements of the body temperature of the patient. In the example of FIG. 3D, the temperature frame **364d** includes text representing the body temperature of the patient. The size of the text in the temperature frame **364d** is similar to the size of the text in the temperature frame **334d** of the spot check workflow home screen **330** and larger than the size of the text in the temperature frame **314d** of the monitoring workflow home screen **300**. The temperature frame **364d** does not include the temperature alarm status area **328a** that is included within the temperature frame **314d** of the monitoring workflow home screen **300**.

The navigation area **318** of the triage workflow home screen **360** includes the home tab **318a**, the review tab **318d**, and the settings tab **318e**. The navigation area **318** of the triage workflow home screen **360** excludes the alarms tab **318c** of the monitoring workflow home screen **300**. As a result, the triage workflow home screen **360** does not provide direct navigation to the alarms screen as provided by the monitoring workflow home screen **300**. Furthermore, the navigation area **318** of the triage workflow home screen **360** excludes the patients tab **318b** of the monitoring workflow home screen **300** and the spot check workflow home screen **330**. As a result, the triage workflow home screen **360** does not provide direct navigation to the patient selection screen as provided by the monitoring workflow home screen **300** and the spot check workflow home screen **330**.

The patient attribute area **316** of the triage workflow home screen **360** includes a patient type button **316b** and a save button **316g**. The patient attribute area **316** does not include text that identifies the patient.

When the PMP device **200** is operating within the triage workflow, the PMP device **200** locally saves a patient reading of the triage workflow home screen **360**. The home screen data of the triage workflow home screen **360** includes measurements of the physiological parameters of the unidentified

patient. Furthermore, a user can configure the PMP device **200** to transmit the patient reading of the triage workflow home screen **360** to another computing node in response to a selection of the save button **316g**. Unlike the monitoring workflow home screen **300** and like the spot check workflow home screen **330**, the PMP device **200** clears the triage workflow home screen **360** when a user selects the save button **316g**. When the PMP device **200** clears the triage workflow home screen **360**, the PMP device **200** modifies the triage workflow home screen **360** such that the triage workflow home screen **360** no longer contains representations of the physiological parameters of the patient.

When the PMP device **200** is operating in the triage workflow, selection of the patient type button **316b** toggles the text label of the patient type button **316b** and toggles a value of a patient type parameter within the triage workflow home screen **360**. The text label and data value associated with the patient type button **316b**, toggles between the label/values of (“Adult”), (“Pediatric”) and (“Neonatal”).

When the user selects the save button **316g**, the patient reading transmitted to another computing node includes a patient type parameter value equal to (“Adult”), (“Pediatric”) and (“Neonatal”). The patient type data substitutes for patient identification data that is absent from the patient reading while operating within the triage workflow.

As a result, when the PMP device **200** is operating in the triage workflow, a first unidentified patient is essentially discharged when a user selects the save button **316g**. Upon attaching the sensors to a second unidentified patient, the user uses the PMP device **200** to obtain a set of one or more measurements of physiological parameter from the second unidentified patient.

The triage workflow is designed for obtaining measurements of physiological parameters from each of a series of unidentified patients. A user does not select each patient in the series of unidentified patients from the patient selection screen. Instead, the user attaches the sensors to each unidentified patient in sequence. Upon attaching the sensors to a patient in the series of the unidentified patients, the user uses the PMP device **200** to obtain measurements of one or more physiological parameters of that patient at that time. Typically, the user attaches the sensors to the patient for no more time that is required to obtain one measurement for each of the NIBP, the pulse rate, the SpO₂ level, and the body temperature of the patient. The user then detaches the sensors from the patient and attaches the sensors to another patient that is next in the series of patients.

In one use scenario, the triage workflow can be used for obtaining measurements of physiological parameters from unidentified health care recipients. The recipients may or may not be patients of a health care facility. The other computing node is a personal computer which receives the patient reading from the PMP device **200** with no patient names attached.

In some embodiments, the PMP device **200** enables a user to customize the content within the triage workflow home screen **360**. For example, the PMP device **200** enables a user to adjust the relative sizes of the parameter reporting frames **364** within the triage workflow home screen **360**. In another example, the PMP device **200** enables the user to add or remove parameter reporting frames from the triage workflow home screen **360**. Furthermore, in some such embodiments, the PMP device **200** includes one or more predefined templates for the triage workflow home screen **360**. Each of the predefined templates specifies a predefined set of content within the triage workflow home screen **360**. The user can customize the content within the triage workflow home

screen 360 by selecting one of these predefined templates or by modifying one of these predefined templates.

FIG. 4 illustrates an example patient selection screen 400. A user can navigate to the patient selection screen 400 by selecting the patients tab 318b. The patient selection screen 400 includes a device status area 312, a pane selection tab area 310 and a navigation area 318. The pane selection tab area 310 includes four pane selection tabs that are labeled “List”, “Summary”, “Modifiers” and “Manual.” The list pane 418 includes a column label area 412, a patient listing area 414, and a screen control area 416. The device status area 312 appears like the device status area 312 of the monitoring workflow home screen 300, the device status area 312 of the spot check workflow home screen 330, and the device status area 312 of the triage workflow home screen 360. The navigation area 318 appears like the navigation area 318 of the monitoring workflow home screen 300.

The patient listing area 414 includes lines 415a-415e (collectively, “lines 415”). Each of the lines 415 is associated with a different patient. For example, a patient having a name “Barker, D.” is listed on the line 415a, a patient having a name “Connor, W.” is listed on the line 415c, and a patient having a name “Davison, A” is listed on the line 415e.

The screen control area 416 includes three buttons. A first (left) button that is labeled “Add” is utilized to add a patient to the patient listing area 414. A second (middle) button that is labeled “Delete” is utilized to delete a patient from the patient listing area 414. A third (right) button that is labeled “Select” is utilized to highlight a patient that listed within the patient listing area 414.

FIG. 5 illustrates an example review screen 500. A user can navigate to the review screen 500 using the review tab 318d. The review screen 500 includes a device status area 312, a review table 541, a screen control area 548, and a navigation area 318. The device status area 312 appears like the device status area 312 of the monitoring workflow home screen 300, the device status area 312 of the spot check workflow home screen 330, and the device status area 312 of the triage workflow home screen 360. The navigation area 318 of the review screen 500 appears like the navigation area 318 of the monitoring workflow home screen 300.

The review table 541 includes a column label line 542. In addition, the review table 541 includes patient readings 546a-546f and columns 552a-552i. Each of the patient readings 546a-546f comprises a different set of measurements of physiological parameters of a patient. Each of the columns 552b-552h is associated with a different physiological parameter. Check marks in the column 552a indicate whether particular ones of the patient readings 546a-546f are selected. In the example of FIG. 5, the patient readings 546A and 546e are selected.

For example, the patient reading 546a includes a patient name (“Barker, D.”) in the column 552b, a date and time value in the column 552c, a systolic and diastolic measurement value in the column 552d, a mean arterial pressure (MAP) measurement value (not shown), a temperature measurement value in the column 552f, a pulse measurement value in the column 552g, an SpO2 measurement value in the column 552h, and a patient attributes set of values in the column 552i.

The screen control area 548 includes a send patient reading button 548a, a print patient reading button 548b, a delete patient reading button 548c and a view list box 548d. The print patient reading button 548b is utilized to send a selected patient reading. The print patient reading button 548b is utilized to print selected patient readings. The delete patient reading button 548c is utilized to delete selected patient readings. The view list box 548d enables filtering of the review

table 541. A user can use the view list box 548d to select to view all available patient readings or only particular patient readings based on sent, unsent or alarm status.

FIG. 6A illustrates an example intervals pane 610 of a settings screen 600. Direct navigation to the settings screen 600 is provided from the monitoring workflow home screen 300, from the spot check workflow home screen 330, and from the triage workflow home screen 360. For example, in some embodiments, a user of the PMP device 200 navigates to the settings screen 600 by selecting the settings tab 318e. As illustrated in the example of FIG. 6A, the settings screen 600 includes a device status area 312, a pane selection tab area 604, the intervals pane 610 and a navigation area 318.

The device status area 312 of the settings screen 600 appears like the device status area 312 of the monitoring workflow home screen 300, the device status area 312 of the spot check workflow home screen 330, and the device status area 312 of the triage workflow home screen 360. The pane selection tab area 604 includes five pane selection tabs that are labeled “Intervals,” “Device,” “Clinician,” “Profiles,” and “Advanced.” The navigation area 318 of the settings screen 600 appears like the navigation area 318 of the monitoring workflow home screen 300.

A user can use the intervals pane 610 to program the PMP device 200 to save NIBP measurements, pulse rate measurements, SpO2 measurements, and temperature measurements for a patient at given intervals over an given time period. Other combinations of physiological parameters can be obtained at other fixed or non-fixed intervals.

The intervals pane 610 includes an automatic control 611, a program control 612, a stat control 613, an off control (not shown), a print control 615, and a start control 616. When the automatic control 611 is selected, the settings screen 600 contains one or more controls for entering a fixed time period to right of control. When the program control 612 is selected, the settings screen 600 contains controls for defining and selecting interval programs. When the stat control 613 is selected, the settings screen 600 contains one or more controls for capturing and saving as many measurements of physiological parameters as possible within a time period, for example a five minute period. When the off control is selected, intervals are turned off. When the print control 615 is selected, a captured measurement at each interval may be printed. The start control 616 is a command button to start the selected interval workflow: Automatic, Program, or Stat. The PMP device 200 automatically initiates a NIBP reading and initiates the interval program once the start control 616 is selected.

In the example of FIG. 6A, the program control 612 is selected. Consequently, the intervals pane 610 includes controls for defining and selecting interval programs. An interval program is a set of parameters that governs the intervals at which the PMP device 200 records measurements of one or more physiological parameters of a patient and for lengths of time for which the PMP device 200 records the measurements of the one or more physiological parameters of the patient.

In the example of FIG. 6A, the intervals pane 610 contains interval program selection controls 660a, 660b (collectively, interval program selection controls 660). More or fewer controls 660 can be provided. The interval program selection controls 660 specify the names of interval programs. In some examples, the interval program selection controls 660 specify names associated with the controls, such as “Transplant,” “Transfusion,” “Cardiac,” which represent names of interval programs.

A user selects an interval program by selecting one of the interval program selection controls 660 that corresponds to

the interval program. After selecting the interval program, the user starts the interval program by selecting the start control 616. When the user starts the interval program, the PMP device 200 records measurements of physiological parameters of a patient at the intervals specified by the interval program for the duration specified by the interval program.

In some embodiments, the monitoring workflow home screen 300 contains remaining time controls. The remaining time controls indicate amounts of time remaining before the PMP device 200 records measurements of the physiological parameters. For example, the pulse rate frame 314*b* of the monitoring workflow home screen 300 can include a remaining time control that indicates that twenty seconds remain before the PMP device 200 records a measurement of the patient's pulse rate. Furthermore, in some embodiments, the PMP device 200 displays the intervals pane 610 when the user selects the remaining time controls. In this way, the user of the PMP device 200 can easily access the intervals pane 610.

Furthermore, in the example of FIG. 6A, the intervals pane 610 contains a program name control 662, duration controls 664*a*-664*e* (collectively, "duration controls 664"), and interval controls 666*a*-666*e* (collectively, "interval controls 666"). The duration controls 664 and the interval controls 666 are organized into rows. Each row corresponds to a different physiological parameter of the patient. For example, a first row corresponds to the patient's blood pressure, a second row corresponds to the patient's pulse rate, and so on.

When the user selects an interval program using one of the interval program selection controls 660, the program name control 662 contains the name of the interval program. In the example of FIG. 6A, the program name control 662 indicates that the name of the interval program is "Transfusion." The duration controls 664 specify lengths of time during which the PMP device 200 is to record measurements of the physiological parameters. The interval controls 666 specify lengths of time that the PMP device 200 waits between recording measurements of the physiological parameters. In the example of FIG. 6A, the duration control 664*a* indicates 1 hour and the interval control 666*a* indicates 15 minutes. Consequently, the PMP device 200 records measurements of a physiological parameter at 15 minute intervals for one hour after the "Transfusion" interval program starts.

When the user selects an interval program using one of the interval program selection controls 660, the user is able to change the values in the program name control 662, the duration controls 664, and the interval controls 666. For example, the user can change the value of the duration control 664*b* from one hour to two hours.

FIG. 6B illustrates an example device pane 620 of the settings screen 600. The settings screen 600 includes a device status area 312, a pane selection tab area 604, a device pane 520 and a navigation area 318. The device status area 312, the pane selection tab area 604, and the navigation area 318 appear like that of FIG. 6A.

The device pane 620 provides controls and information for a user to select or view device characteristics. The device pane 620 includes a set date and time control 622, a touch-screen lock-out control 628, and a command button 629. The set date and time control 622 is configured to set up a date and time for the PMP device 200. A user may select a date display format through the date format selection (not shown), such as MM/DD/YYYY. A user may also select a time zone offset from UTC based on where the PMP device 200 is located. The touch-screen lock-out control 628 is configured to allow a user to lock out the touch screen. When the command button 629 is selected, the touch screen is locked out immediately.

FIG. 6C illustrates an example clinician pane of the settings screen 600. The settings screen 600 includes a device status area 312, a pane selection tab area 604, a clinician pane 630 and a navigation area 318. The device status area 312, the pane selection tab area 604 and the navigation area 318 appear like that of FIG. 6A. The clinician pane 630 provides for entry of clinician identification. The clinician identified can include a first name, a last name, a middle initial, and an identification number.

FIGS. 6D-6F illustrate an example profiles pane 640 of the settings screen 600. The settings screen 600 includes the device status area 312, a pane selection tab area 604, the profiles pane 640 and a navigation area 318. The device status area 312, the pane selection tab area 604 and the navigation area 318 appear like that of FIG. 6A. The profiles pane 640 allows a user to select a desired workflow within which the PMP device 200 is to operate. In the examples of FIG. 6D-6F, the profiles pane 640 includes a "Med/Surge" control 642, a "Spot Check" control 644, and an "ED Triage" control 646. A user selects the "Med/Surge" control 642 to select a "Med/Surge" workflow as the workflow in which the PMP device 200 is to operate. The user selects the "Spot Check" control 644 to select the spot check workflow as the workflow in which the PMP device 200 is to operate. The user selects the "ED triage" control 646 to select the triage workflow as the workflow in which the PMP device 200 is to operate. As shown in the examples of FIGS. 6D-6F, the profiles pane 640 shows a preview of the home screen of the selected workflow.

FIG. 6G illustrates an example advanced pane 650 of the settings screen 600. The settings screen 600 includes a device status area 312, a pane selection tab area 604, the advanced pane 650 and a navigation area 318. The device status area 312, the pane selection tab area 504 and the navigation area 318 appear like that of FIG. 6A. The advanced pane 650 enables an administrator to access configuration settings that are likely to be set once or less frequently than those required for a normal use. When a proper access code is entered, the PMP device 200 switches to an administration workflow and the navigation tabs switch to advanced settings tabs. The advanced pane 650 also provides read-only information about the PMP device 200.

FIG. 7A illustrates an example global pane 710 of an alarms screen 700. A user of the PMP device 200 navigates to the alarms screen 700 by selecting the alarms tab 318*c*. The alarms screen 700 includes controls that enable a user to configure global alarm settings and parameter-specific alarm settings.

As illustrated in the example of FIG. 7A, the alarms screen 700 includes the device status area 312, a compressed parameter reporting area 702, a pane selection tab area 704, the global pane 710, and the navigation area 318. The device status area 312 appears like the device status areas of the monitoring workflow home screen 300, the spot check workflow home screen 330 and the triage workflow home screen 360. The navigation area 318 of the alarms screen 700 appears like the navigation area 318 of the monitoring workflow home screen 300.

The compressed parameter reporting area 702 contains one or more compressed parameter frames containing data representing live physiological parameters of a patient. In the example of FIG. 7A, the compressed parameter reporting area 702 contains a compressed NIBP frame 703*a*, a compressed SpO2 frame 703*b*, a compressed pulse rate frame 703*c*, and a compressed temperature frame 703*d*. The compressed NIBP frame 703*a*, the compressed SpO2 frame 703*b*, the compressed pulse rate frame 703*c*, and the compressed temperature frame 703*d* are referred to herein collectively as

the compressed frames 703. The compressed parameter reporting area 702 has frame dimensions that are smaller than the frame dimensions of the parameter reporting area 314 of the monitoring workflow home screen 300. Because the compressed parameter reporting area 702 is smaller than the parameter reporting area 314, the compressed parameter reporting area 702 appears “squished” relative to the parameter reporting area 314.

The compressed NIBP frame 703a contains a representation of the systolic and the diastolic blood pressure of the patient. The compressed SpO2 frame 703b contains a representation of a SpO2 percentage of the patient, a pulse amplitude blip bar, and alarm limits for the SpO2 parameter. The compressed pulse rate frame 703c contains a representation of a pulse rate of the patient. The compressed temperature frame 703d contains a representation of the body temperature of the patient. In the example of FIG. 7A, the compressed frames 703 do not contain user-selectable controls. Consequently, the user is unable to toggle views of the physiological parameters from the compressed frames 703.

When an alarm associated with one of the physiological parameters is active, the corresponding one of the compressed frames 703 provides a visual indication of the alarm. For example, when the patient’s blood pressure is too high, a perimeter of the compressed NIBP frame 703a changes from one color (e.g., gray) to a different color (e.g., red). Furthermore, when an alarm is active, the device status area 312 of the alarms screen 700 is replaced by an alarm message describing the alarm. In some embodiments, selecting the alarm message causes the PMP device 200 to temporarily stop emitting an alarm sound associated with the alarm.

The pane selection tab area 704 includes five pane selection tabs that are labeled “Global”, “NIBP”, “SpO2”, “Pulse” and “Temperature.” When the user selects one of the pane selection tabs in the pane selection tab area 704, the PMP device 200 updates the alarms screen 700 to contain a pane associated with the selected pane selection tab.

The global pane 710 is located below the compressed parameter reporting area 702. The global pane 710 provides controls for configuring global alarm settings for the PMP device 200. The global alarm settings are settings that apply to all alarms provided by the PMP device 200. In the example of FIG. 7A, the global pane 710 includes a reset button 712a, a display alarm limit parameter button 712b, a set of alarm audio buttons 712c, a set of volume buttons 712d, and a silence/reset button 712e. A user can use the reset button 712a to reset alarm limits. The user can use the display alarm limit parameter button 712b to configure the PMP device 200 to display or not to display alarm limits. The user can use the set of alarm audio buttons 712c to configure the PMP device 200 to emit alarm sounds. The user can use the set of volume buttons 712d to set a volume of the alarm sounds to high, medium or low. Also, the user can use the silence/reset button 712e to silence or reset alarms.

FIG. 7B illustrates an example temperature pane 720 of the alarms screen 700. The alarms screen 700 includes the device status area 312, the compressed parameter reporting area 702, the pane selection tab area 704, the temperature pane 720, and a navigation area 318. The device status area 312, the compressed parameter reporting area 702, the pane selection tab area 704 and the navigation area 318 appear like that of FIG. 7A.

The temperature pane 720 is located below the compressed parameter reporting area 702. The temperature pane 720 enables a user of the PMP device 200 to configure parameter-specific alarm settings for the temperature alarm. In the example of FIG. 7B, the temperature pane 720 provides con-

trols 722a, 722b and 722c. The control 722a sets the temperature alarm to ON or OFF. The control 722b sets an upper temperature limit for the temperature alarm. The control 722c sets a lower temperature limit for the temperature alarm.

FIG. 7C illustrates an example NIBP pane 730 of the alarms screen 700. The alarms screen 700 includes a device status area 312, a compressed parameter reporting area 702, a pane selection tab area 704, the NIBP pane 730, and a navigation area 318. The device status area 312, the compressed parameter reporting area 702, the pane selection tab area 704 and the navigation area 318 appear like that of FIG. 7A.

The NIBP pane 730 enables a user of the PMP device 200 to configure parameter-specific alarm settings for the NIBP alarm. In the example of FIG. 7C, the NIBP pane 730 contains a control 732a to set the systolic and diastolic alarm ON or OFF. The NIBP pane 730 also contains controls 732b-732e to set the systolic and diastolic upper and lower alarm limits for the systolic and diastolic alarm. Further, the NIBP pane 730 provides controls 732f, 732g and 732h. The control 732f sets a MAP alarm to ON or OFF. The control 732g sets set an upper MAP limit for the MAP alarm. The control 732h sets a lower MAP limit for the MAP alarm.

FIG. 7D illustrates an example SpO2 pane 740 of the alarms screen 700. The alarms screen 700 includes the device status area 312, the compressed parameter reporting area 702, the pane selection tab area 704, the SpO2 pane 740, and the navigation area 318. The device status area 312, the compressed parameter reporting area 702, the pane selection tab area 704, and the navigation area 318 appear like that of FIG. 7A.

The SpO2 pane 740 enables a user of the PMP device 200 to configure parameter-specific alarm settings for the SpO2 alarm. In the example of FIG. 7D, the SpO2 pane 740 provides controls 742a, 742b and 742c. The control 742a sets the SpO2 alarm to ON or OFF. The controls 742b and 742c set an upper SpO2 limit and a lower SpO2 limit for the SpO2 alarm. The SpO2 pane 740 also includes a SatSeconds™ control 743d. When a numeric value is selected, an SpO2 alarm is not activated until a length of time specified by the SatSeconds control 743d has expired. The length of time specified by the SatSeconds control 743d is based on a duration of a low SpO2 event multiplied by a number of percentage points that the patient’s SpO2 falls outside the lower SpO2 alarm threshold. Also, the SatSeconds control 743d appears next to the controls 742b and 742c when the control 742a is set to ON. However, when the control 742a is set to OFF, the SatSeconds control 743d is not displayed and the alarm condition is not delayed per a SatSeconds algorithm.

FIG. 7E illustrates an example pulse rate pane 750 of the alarms screen 700. The alarms screen 700 includes the device status area 312, the compressed parameter reporting area 702, the pane selection tab area 704, the pulse rate pane 750 and the navigation area 318. The device status area 312, the compressed parameter reporting area 702, the pane selection tab area 704 and the navigation area 318 appear like that of FIG. 7A.

The pulse rate pane 750 enables a user of the PMP device 200 to configure parameter-specific alarm settings for the pulse rate alarm. In the example of FIG. 7E, the pulse rate pane 750 provides an on/off control 752a, an upper limit control 752b and a lower limit control 752c. The on/off control 752a allows a user to turn the pulse rate alarm on or off. The upper limit control 752b allows a user to set an upper pulse rate limit for the pulse rate alarm. The lower limit control 752c allows a user to set a lower pulse rate limit for the pulse rate alarm.

The upper limit control **752b** includes a numerical portion, an up button and a down button. The numerical portion of the upper limit control **752b** specifies an upper pulse rate limit for the pulse rate alarm. Selecting the up button of the upper limit control **752b** incrementally increases the upper pulse rate limit. Selecting the down button of the upper limit control **752b** incrementally decreases the upper pulse rate limit. Selecting the numerical portion of the upper limit control **752b** causes the PMP device **200** to display a numerical keypad. The user is able to use the numerical keypad to manually enter a value for the upper pulse rate limit.

The lower limit control **752c** includes a numerical portion, an up button, and a down button. The numerical portion of the lower limit control **752c** specifies the lower pulse rate limit. Selecting the up button of the lower limit control **752c** incrementally increases the lower pulse rate limit. Selecting the down button of the lower limit control **752c** incrementally decreases the lower pulse rate limit. Selecting the numerical portion of the lower limit control **752c** causes the PMP device **200** to display a numerical keypad. The user is able to use the numerical keypad to manually enter a value for the lower pulse rate limit.

In the examples shown, the values that are entered by the user are validated for accuracy. For example, upper and lower thresholds for each parameter can be set. If the user selects a value outside of the upper and lower thresholds, the system can prevent such a selection and/or alert the user. For example, if the user types in 300 minutes on the keypad for a parameter, and the upper threshold set for that parameter is 240 minutes, the system will not allow the user to increase the parameter to 300 minutes.

In some embodiments, various panes of the alarms screen **700** can include other upper limit controls and other lower limit controls like the upper limit control **752b** and the lower limit control **752c**. The other upper limit controls and the other lower limit controls allow a user to set upper limits and lower limits for alarms for various physiological parameters of patients.

When the PMP device **200** is in a continuous workflow mode, the home screen **250** can display the information described above. Such information can include continuous measurements, such as SpO₂, PR, etCO₂, FiCO₂, IPI, RR and/or SpHb.

The pulse rate can be obtained from two sources, an SpO₂ or NIBP reading, with the reading from SpO₂ having higher priority for display. If SpO₂ readings are available, then pulse rate is displayed and updated once per second with SpO₂ as the source. If no SpO₂ readings are available and an NIBP reading is started, then the pulse rate is cleared when the NIBP frame is cleared and then updated with a pulse rate from NIBP when it is available, likely when systolic/diastolic is available, with NIBP as the source. Such a reading would be episodic, as described below.

Referring to FIG. 8, the SpO₂ frame **256** is shown. The SpO₂ frame **256** provides a variety of information, such as a percentage SpO₂ **780** (e.g., "100%").

In addition, a pulse amplitude blip bar **782** is shown. The pulse amplitude blip bar **782** indicates a pulse beat of the patient and shows the relative pulse amplitude. As the detected pulse becomes stronger, more bars light up with each pulse. The example pulse amplitude blip bar **782** provides 9 bars, and blip values are divided equally into the number of bars. Brighter, more visually intense bars indicate values received from the SpO₂ sensor, and their growth vertically up the bar indicates greater levels of strength. Remaining bars

are indicated as darker, less prominent, inactive bars. All the bars are displayed darker when no SpO₂ activity or signal is available.

In addition, a plethysmographic waveform **784** is shown. The plethysmographic waveform **784** can be selected by the user to provide a larger representation of the waveform. The plethysmographic waveform **784** provides the real-time sensor signal. It allows a user to observe the relative pulsatile strength and quality of the incoming signal. The waveform is displayed per configured sweep speed, which appears above and to right side of waveform display area (except when the smallest frame size for continuous profile is displayed—in this case the sweep speed may not be displayed).

Referring to FIG. 9, an example SpHb (measuring total hemoglobin concentration in blood) frame **790** is shown, which presents measures associated with total hemoglobin readings. In this example, the SpHb frame **790** shows the current SpHb reading (e.g., "10.9"), along with alarm limits (e.g., "7.0" to "12.0"). An SpHb trend graphic provides a historical view of total hemoglobin readings over the displayed view time. Selection of the graphic on the SpHb frame **790** provides a larger trend graphic illustrating the change over time with the upper and lower limits set as the configured alarm limits.

Referring to FIGS. 10A-10B, the etCO₂ frame **264** displays data, information, and controls relevant for etCO₂ and FiCO₂ readings capture, as well as a CO₂ waveform. The etCO₂ frame **264** provides views with text and graphics, including a Capnogram waveform.

When the Capnogram is selected, the waveform frame **265** is shown, including real-time sensor signal. It allows a user to observe the breathing patterns of the patient for instant determination of adequate ventilation versus hyper/hypo ventilation conditions. The waveform is displayed per the default sweep speed, which appears above and to right side of waveform display area.

Referring now to FIGS. 11A-11B, the IPI frame **254** encapsulates data, information, and controls relevant for display of IPI readings calculated using CO₂, RR, SpO₂, and PR readings. It provides views with text and graphics including numeric and trend graph, with the numeric view being primary and the trend graph view being secondary. IPI numeric readings are calculated for Adult patient types, and different classifications of pediatric patient types.

If the trend graphic is selected, an historical trend **255** is shown, as illustrated in FIG. 11B. The IPI trend graphic will provide IPI values on the y-axis and time on the x-axis. The y-axis upper (y-max) limit is 10 and the lower (y-min) limit is 0. The trend graph will continue to show no data until a patient has been connected to the CO₂ sensor, a 'valid breath' has been received, and CO₂, RR, SpO₂, and PR readings required for the IPI calculation are available. Blank areas may appear in trend if sensor is not calculating/sending IPI readings to the device. The oldest to newest readings appear from left to right, with the most recent readings appearing beginning with the rightmost portion of the display area for the trend graphic.

Referring to FIGS. 12A-12B, the RR frame **262** is shown, which encapsulates data, information, and controls relevant for respiration readings capture. It provides a view with text and graphics.

As shown in FIG. 12B, in some instances, a respiration rate indicator graph **263** is shown. The respiration rate indicator graph **263** indicates the acquired signal quality and the respiration rate. As the detected respiration becomes stronger, more bars light up with each breath.

In some examples, the home screen **250** can display both continuous data and episodic data. For example, in typical

scenarios, both continuous measurements and episodic measurements may be taken from a patient, and the information displayed on the home screen **250** can include episodic information that is not obtained in a continuous manner. One example of such an episodic parameter is NIBP. Another example is temperature (if not measured continuously).

For example, referring now to FIGS. **13A-13B**, an NIBP frame **796** of the home screen **250** is shown. The data associated with the NIBP measurements is episodic, in that it is typically measured at given intervals, such as every 5 minutes, 10 minutes, 15 minutes 30 minutes, 1 hour, etc. As the data provided in the NIBP frame **796** ages, an indication of that aging is provided.

For example, in FIG. **13A**, the measurements shown in the NIBP frame **796** are current, in that the measurements were taken within a given threshold of time, such as 10 minutes or 15 minutes. In other words, the measurements shown are less than 15 minutes old. This is indicated by displaying the data (e.g., “120/80”) in a brighter color, such as a yellow.

In contrast, as shown in FIG. **13B**, the NIBP measurements shown in the NIBP frame **796** have aged. In other words, after episodic measurements have been displayed for a given threshold (e.g., 15 minutes) without new measurement data being provided, the measurement data on the NIBP frame **796** changes from its current color to gray, and a timestamp (e.g., “@ 10:58”) is displayed in the bottom of the NIBP frame **796** to indicate when the last measurements were taken. This allows the caregiver to easily determine that the displayed data may not be current. Other configurations can also be used to indicate aging of measurements.

For example, if measurements associated with continuous data are interrupted, the home screen **250** can be configured to provide the last known measurements, as well as indicate that such measurements have aged by providing indicia, such as changing color and providing a time stamp, as described above.

In addition, other modifications can be made to the various home screens described herein. For example, in some instances, as described further above, the type and amount of measurements shown on the home screen **250** can be modified depending on the type of view shown.

For example, in compressed or squished views, such as when alarm information is shown, only certain of the information associated with the parameters measured during the continuous workflow is shown. For example, in the compressed view of the home screen **250**, SpO₂ (and the associated pulse amplitude blip bar) and pulse rate are typically displayed.

However, for the home screen **250**, when CO₂ is shown, FiCO₂ is not displayed in the compressed view, and the various other parameters are displayed in the following priority order (with up to five parameters shown at a given time): IPI/RR/SpO₂/etCO₂/PR/NIBP/Temp. When RRA (acoustic respiration rate) is shown on the home screen **250**, the parameters are displayed in the following priority order: RRA/SpO₂/PR/NIBP/Temp. Other configurations are possible.

In example embodiments, the desired workflow can be selected for the PMP device **200** based on operating conditions. For example, the continuous workflow can be selected if one or more sensors which measure continuous data are connected to the PMP device **200**. In such a scenario, the measurements are displayed on the PMP device **200** and/or sent to a central site for storage, such as the EMR system **102**.

In other embodiments, transitions between the various workflows can occur depending on the operating characteristics for the PMP device **200**. For example, once a sensor associated with measuring continuous data is connected to

the PMP device **200**, the PMP device **200** can be configured to transition from a non-continuous workflow (e.g., monitoring workflow or non-monitoring workflow) to a continuous workflow. Additional details about such transitions are provided in U.S. patent application Ser. No. 13/440,860, filed on even date herewith, the entirety of which is hereby incorporated by reference.

FIG. **14** is a flowchart illustrating an example operation **800** performed by the PMP device **200**. As illustrated in the example of FIG. **14**, the operation **800** begins when the PMP device **200** displays the settings screen **600** (**802**). The PMP device **200** then receives workflow selection input from a clinician via the settings screen **600** (**804**). In response to receiving the workflow selection input, the PMP device **200** determines whether the workflow selection input indicates the monitoring workflow, the triage workflow, the spot check workflow, or the continuous workflow (**806**). If the PMP device **200** determines that the workflow selection input indicates the triage workflow, the PMP device **200** performs the steps illustrated in FIG. **15**. If the PMP device **200** determines that the workflow selection input indicates the continuous workflow, the PMP device **200** performs the steps illustrated in FIG. **16**.

If the PMP device **200** determines that the workflow selection input indicates the monitoring workflow, the PMP device **200** displays the patient selection screen **400** (**808**). The PMP device **200** then receives patient selection input from the clinician via the patient selection screen **400** (**810**). The patient selection input indicates a patient that the clinician intends to monitor.

Next, the PMP device **200** displays the monitoring workflow home screen **300** (**812**). In some embodiments, the PMP device **200** displays the monitoring workflow home screen **300** automatically after the clinician selects the monitored patient via the patient selection screen **400**. In other embodiments, the PMP device **200** displays the monitoring workflow home screen **300** in response to the clinician selecting the home tab **318a**.

Subsequently, the PMP device **200** obtains a measurement of a physiological parameter of the monitored patient (**814**). The PMP device **200** then displays a representation of the physiological parameter on the monitoring workflow home screen **300** (**816**). The representation of the physiological parameter is based, at least in part, on the measurement of the physiological parameter. The PMP device **200** then obtains another measurement of the physiological parameter from the same monitored patient (**814**). In this way, the PMP device **200** enables the clinician to monitor the physiological parameters of the same monitored patient over a period of time.

If, however, the PMP device **200** determines that the workflow selection input indicates the spot check workflow, the PMP device **200** displays the patient selection screen **400** (**818**). In various embodiments, the PMP device **200** displays the patient selection screen **400** in response to various events. For example, in some embodiments, the PMP device **200** automatically displays the patient selection screen **400** when the PMP device **200** determines that the workflow selection input indicates the spot check workflow. In another example, the PMP device **200** displays the patient selection screen **400** in response to receiving a selection of the patients tab **318b**.

The PMP device **200** then receives patient selection input from the clinician via the patient selection screen **400** (**820**). The patient selection input indicates a selected patient. The selected patient is a patient on whom the clinician intends to perform a spot check.

Next, the PMP device **200** displays the spot check workflow home screen **330** (**822**). In various embodiments, the

PMP device 200 displays the spot check workflow home screen 330 in response to various events. For example, in some embodiments, the PMP device 200 automatically displays the spot check workflow home screen 330 when the PMP device 200 receives the patient selection input from the clinician. In other embodiments, the PMP device 200 displays the spot check workflow home screen 330 in response to receiving a selection of the home tab 318a.

The PMP device 200 then obtains a measurement of a physiological parameter of the selected patient (824). In response to obtaining the measurement of the physiological parameter of the selected patient, the PMP device 200 displays a representation of the physiological parameter of the selected patient (826). The representation of the physiological parameter is based, at least in part, on the measurement of the physiological parameter.

Subsequently, the PMP device 200 clears the home screen data from the spot check workflow home screen 330 (828). The PMP device 200 then displays the patient selection screen 400 again (818) and receives patient selection input indicating another patient (818), and so on. In this way, the PMP device 200 displays representations of physiological parameters of each patient in a series of patients.

FIG. 15 is a flowchart representing a continuation of the operation 800 in which the workflow selection input indicates the triage workflow. As illustrated in the example of FIG. 15, if the PMP device 200 determines that the workflow selection input indicates the triage workflow, the PMP device 200 displays the triage workflow home screen 360 (900). In various embodiments, the PMP device 200 displays the triage workflow home screen 360 in response to various events. For example, in some embodiments, the PMP device 200 automatically displays the triage workflow home screen 360 when the PMP device 200 determines that the workflow selection input indicates the triage workflow. In another example, the PMP device 200 displays the triage workflow home screen 360 when the PMP device 200 receives a selection of the home tab 318a.

Next, the PMP device 200 obtains a measurement of a physiological parameter of an unidentified patient in a series of patients (902). After obtaining the measurement, the PMP device 200 displays a representation of the physiological parameter on the triage workflow home screen 360 (904). The representation of the physiological parameter is based at least in part on the measurement of the physiological parameter.

Subsequently, the PMP device 200 clears the home screen data from the triage workflow home screen 360 (906). The PMP device 200 then obtains a measurement of the physiological parameter of a different patient in the series of unidentified patients (902), displays a representation of the physiological parameter (904), and so on. In this way, the PMP device 200 displays representations of physiological parameters of each patient in the series of unidentified patients.

FIG. 16 is a flowchart representing a continuation of the operation 800 in which the workflow selection input indicates the continuous workflow. As illustrated in the example of FIG. 16, if the PMP device 200 determines that the workflow selection input indicates the continuous workflow, the PMP device 200 displays the continuous workflow home screen 250 (910). In various embodiments, the PMP device 200 displays the continuous workflow home screen 250 in response to various events. For example, in some embodiments, the PMP device 200 automatically displays the continuous workflow home screen 250 when the PMP device 200 determines that the workflow selection input indicates the continuous workflow. In another example, the PMP device

200 displays the continuous workflow home screen 250 when the PMP device 200 receives a selection of the home tab 318a.

Next, the PMP device 200 obtains measurements of physiological parameters of an identified patient (912). After obtaining the measurements, the PMP device 200 displays a representation of the physiological parameters on the continuous workflow home screen 250 (914). The representation of the physiological parameters is based at least in part on the measurement of the physiological parameters. The home screen 250 continues to disclose the physiological parameters as these parameters are continuously obtained from the patient by the PMP device 200.

FIG. 17 is a flowchart illustrating an operation 1000 performed by the PMP device 200 when the PMP device 200 displays a workflow home screen. In some embodiments, the PMP device 200 can perform the operation 1000 when the PMP device 200 displays either the monitoring workflow home screen 300, the spot check workflow home screen 330, or the triage workflow home screen 360.

As illustrated in the example of FIG. 17, the PMP device 200 initially waits to receive an event (1002). An event is an occurrence or happening of significance to a task or program.

The PMP device 200 receives a measurement event when the PMP device 200 receives a measurement of a physiological parameter of a patient. If the PMP device 200 receives a measurement event ("YES" of 1004), the PMP device 200 determines whether the measurement of the physiological parameter is within an alarm range for the physiological parameter (1006). If the measurement of the physiological parameter is not within (i.e., is outside) the alarm range for the physiological parameter ("NO" of 1006), the PMP device 200 displays an alarm message on the workflow home screen (1008). In addition, the PMP device 200 emits an alarm sound (1010).

The PMP device 200 also generates a representation of the physiological parameter based on the measurement of the physiological parameter (1012). The PMP device 200 generates the representation of the physiological parameter regardless of whether the measurement is within the alarm range of the physiological parameter. The PMP device 200 then displays the representation of the physiological parameter on the workflow home screen (1014). The PMP device 200 then waits for another event (1002).

The PMP device 200 can receive an alarm message selection event when the PMP device 200 displays an alarm message, there are two or more active alarms, and a clinician selects the alarm message. If the PMP device 200 receives an alarm message selection event ("YES" of 1016), the PMP device 200 modifies the alarm message such that the alarm message describes a next one of the active alarms (1018). The PMP device 200 then waits for another event (1002).

The PMP device 200 can receive an alarm silence event when an alarm is currently active, the PMP device 200 is emitting an alarm sound, and a clinician selects a control to suspend the alarm sound. If the PMP device 200 receives an alarm silence event ("YES" of 1020), the PMP device 200 suspends the alarm sound (1022). In addition, the PMP device 200 modifies the alarm message to indicate that the alarm has been silenced (1024). The PMP device 200 then waits for another event (1002).

The PMP device 200 can receive a representation selection event when a clinician selects a representation of a physiological parameter. If the PMP device 200 receives a representation selection event ("YES" of 1026), the PMP device 200 modifies a parameter reporting area associated with the physiological parameter such that the parameter reporting

area contains a different representation of the physiological parameter (1028). The PMP device 200 then waits for another event (1002).

The PMP device 200 can receive a save selection event when a clinician selects a save button (e.g., save button 316g) on the workflow home screen. If the PMP device 200 receives a save selection event (“YES” of 1030), the PMP device 200 saves the home screen data (1032). The PMP device 200 then waits for another event (1002).

FIG. 18 illustrates example physical components of the PMP device 200. As illustrated in the example of FIG. 18, the PMP device 200 include at least one central processing unit (“CPU”) 1108, a system memory 1112, and a system bus 1110 that couples the system memory 1112 to the CPU 1108. The system memory 1112 includes a random access memory (“RAM”) 1118 and a read-only memory (“ROM”) 1120. A basic input/output system containing the basic routines that help to transfer information between elements within the PMP device 200, such as during startup, is stored in the ROM 1120. The PMP device 200 further includes a mass storage device 1114. The mass storage device 1114 is able to store software instructions and data.

The mass storage device 1114 is connected to the CPU 1108 through a mass storage controller (not shown) connected to the bus 1110. The mass storage device 1114 and its associated computer-readable data storage media provide non-volatile, non-transitory storage for the PMP device 200. Although the description of computer-readable data storage media contained herein refers to a mass storage device, such as a hard disk or CD-ROM drive, it should be appreciated by those skilled in the art that computer-readable data storage media can be any available non-transitory, physical device or article of manufacture from which the PMP device 200 can read data and/or instructions.

Computer-readable data storage media include volatile and non-volatile, removable and non-removable media implemented in any method or technology for storage of information such as computer-readable software instructions, data structures, program modules or other data. Example types of computer-readable data storage media include, but are not limited to, RAM, ROM, EPROM, EEPROM, flash memory or other solid state memory technology, CD-ROMs, digital versatile discs (“DVDs”), other optical storage media, magnetic cassettes, magnetic tape, magnetic disk storage or other magnetic storage devices, or any other medium which can be used to store the desired information and which can be accessed by the PMP device 200.

According to various embodiments of the disclosure, the PMP device 200 may operate in a networked environment using logical connections to remote network devices through the network 108, such as a local network, the Internet, or another type of network. The PMP device 200 connects to the network 108 through a network interface unit 1116 connected to the bus 1110. It should be appreciated that the network interface unit 1116 may also be utilized to connect to other types of networks and remote computing systems. The PMP device 200 also includes an input/output controller 1122 for receiving and processing input from a number of other devices, including a keyboard, a mouse, a touch user interface display screen, or another type of input device. Similarly, the input/output controller 1122 may provide output to a touch user interface display screen, a printer, or other type of output device.

As mentioned briefly above, the mass storage device 1114 and the RAM 1118 of the PMP device 200 can store software instructions and data. The software instructions include an operating system 1132 suitable for controlling the operation

of the PMP device 200. The mass storage device 1114 and/or the RAM 1118 also store software instructions, that when executed by the CPU 1108, cause the PMP device 200 to provide the functionality of the PMP device 200 discussed in this document. For example, the mass storage device 1114 and/or the RAM 1118 can store software instructions that, when executed by the CPU 1108, cause the PMP device to display the monitoring workflow home screen 300 and other screens.

It should be appreciated that various embodiments can be implemented (1) as a sequence of computer implemented acts or program modules running on a computing system and/or (2) as interconnected machine logic circuits or circuit modules within the computing system. The implementation is a matter of choice dependent on the performance requirements of the computing system implementing the disclosure. Accordingly, logical operations including related algorithms can be referred to variously as operations, structural devices, acts or modules. It will be recognized by one skilled in the art that these operations, structural devices, acts and modules may be implemented in software, firmware, special purpose digital logic, and any combination thereof without deviating from the spirit and scope of the present disclosure as recited within the claims set forth herein.

Although the disclosure has been described in connection with various embodiments, those of ordinary skill in the art will understand that many modifications may be made thereto within the scope of the claims that follow. For example, it should be appreciated that the screens illustrated in this document are merely examples and that in other embodiments equivalent screens can have different contents and appearances. Accordingly, it is not intended that the scope of the disclosure in any way be limited by the above description, but instead be determined entirely by reference to the claims that follow.

What is claimed is:

1. A physiological measuring platform (PMP) device comprising:
 - a central processing unit (CPU) that is configured to control operation of the PMP device;
 - a display screen;
 - at least one physiological sensor; and
 - a set of one or more computer readable data storage media storing software instructions that, when executed by the CPU, cause the PMP device to:
 - display, on the display screen, a settings screen enabling a user to select a workflow within which the PMP device is to operate from a plurality of workflows that operate exclusively of each other, including at least an intervals monitoring workflow, a non-monitoring workflow, and a continuous workflow, wherein the workflow selection determines a functionality provided by the PMP device;
 - obtain a series of measurements taken at intervals of a physiological parameter of a monitored patient with the at least one physiological sensor when the PMP device is operating within the intervals monitoring workflow;
 - display, on the display screen, an intervals monitoring workflow home screen when the PMP device is operating within the intervals monitoring workflow, the monitoring workflow home screen containing a first representation of the physiological parameter of the monitored patient, the first representation based on a measurement in the series of measurements;
 - obtain a measurement of the physiological parameter of each patient in a series of patients with the at least one

physiological sensor when the PMP device is operating within the non-monitoring workflow; and
 display, on the display screen, a non-monitoring workflow home screen when the PMP device is operating within the non-monitoring workflow, the non-monitoring workflow home screen containing a second representation of the physiological parameter of a given patient in the series of patients, the second representation based on the measurement of the physiological parameter of the given patient in the series of patients;
 obtain a continuous measurement of the physiological parameter of the monitored patient with the at least one physiological sensor when the PMP device is operating within the continuous workflow; and
 display, on the display screen, a continuous workflow home screen when the PMP device is operating within the continuous workflow, the continuous workflow home screen containing a third representation of the physiological parameter of the monitored patient, the third representation based on the continuous measurement of the physiological parameter of the monitored patient;
 wherein the intervals monitoring workflow home screen, the non-monitoring workflow home screen, and the continuous workflow home screen are each different.

2. The PMP device of claim 1, wherein the physiological parameter displayed on the continuous workflow home screen includes one of SpO₂, SpHb, etCO₂, IPI, and RR.

3. The PMP device of claim 1, wherein the continuous workflow home screen includes an SpO₂ frame, the SpO₂ frame displaying an oxygen saturation percentage and a pulse amplitude blip bar indicating a pulse beat relative pulse amplitude.

4. The PMP device of claim 1, wherein the continuous workflow home screen includes an etCO₂ frame, the etCO₂ frame displaying a numeric value representing etCO₂ and a Capnogram waveform.

5. The PMP device of claim 1, wherein the continuous workflow home screen includes an RR frame, the RR frame displaying a numeric value representing respirations per minute, and a respiration rate indicator graph with a plurality of bars, such that, as a detected respiration becomes stronger, more of the bars light up.

6. The PMP device of claim 1, wherein the continuous workflow home screen displays both continuous data and episodic data.

7. The PMP device of claim 6, wherein an aging of the episodic data is shown on the continuous workflow home screen.

8. The PMP device of claim 7, wherein the aging is shown by changing a display color of the episodic data when an age of the data reaches a threshold.

9. A method for performing physiological parameter measurements for a plurality of patients, the method comprising:
 displaying, by a physiological measurement platform (PMP) device, a settings screen on a display screen, the settings screen enabling a user to select a workflow within which the PMP device is to operate from a plurality of workflows that operate exclusively of each other, including at least an intervals monitoring workflow, a non-monitoring workflow, and a continuous workflow, wherein the workflow selection determines a functionality provided by the PMP device;
 when the PMP device is operating within the intervals monitoring workflow:

obtaining, by a physiological sensor of the PMP device, a series of measurements taken at intervals of a physiological parameter of a monitored patient; and
 displaying, by the PMP device, an intervals monitoring workflow home screen on the display screen, the intervals monitoring workflow home screen containing a first representation of the physiological parameter of the monitored patient, the first representation based on a measurement in the series of measurements;

when the PMP device is operating within the non-monitoring workflow:

obtaining, by the physiological sensor of the PMP device, a measurement of the physiological parameter of each patient in a series of patients; and

displaying, by the PMP device, a non-monitoring workflow home screen on the display screen, the non-monitoring workflow home screen containing a second representation of the physiological parameter of a given patient in the series of patients, the second representation based on the measurement of the physiological parameter of the given patient in the series of patients; and

when the PMP device is operating within the continuous workflow:

obtaining, by the physiological sensor of the PMP device, continuous measurements of a continuous physiological parameter of the monitored patient;

displaying, by the PMP device, a continuous workflow home screen on the display screen, the continuous workflow home screen containing a third representation of the continuous physiological parameter of the monitored patient, the third representation based on a continuous measurement in the continuous measurements, wherein the continuous workflow home screen displays both continuous and episodic data; and
 showing an aging of the episodic data on the continuous workflow home screen when an age of the episodic data reaches a threshold, wherein showing the aging of the episodic data comprises displaying a timestamp to indicate when a last measurement of the episodic data was taken.

10. The method of claim 9, wherein the intervals monitoring workflow home screen, the non-monitoring workflow home screen, and the continuous workflow home screen each comprise:

a device status area containing data regarding a status of the PMP device;

a content area, the content area including a parameter reporting area and a patient attribute area, the parameter reporting area containing a plurality of parameter reporting frames that are each directed to reporting a value of a different physiological parameter; and

a navigation area, the navigation area including screen tabs associated with different screens.

11. The method of claim 9, wherein the physiological parameter displayed on the continuous workflow home screen includes one of SpO₂, SpHb, etCO₂, IPI, and RR.

12. The method of claim 9, wherein the continuous workflow home screen includes an SpO₂ frame, the SpO₂ frame displaying an oxygen saturation percentage and a pulse amplitude blip bar indicating a pulse beat relative pulse amplitude.

13. The method of claim 12, wherein the continuous workflow home screen includes an etCO₂ frame, the etCO₂ frame displaying a numeric value representing etCO₂ and a Capnogram waveform.

39

14. The method of claim 9, wherein the continuous workflow home screen includes an etCO2 frame, the etCO2 frame displaying a numeric value representing etCO2 and a Capnogram waveform.

15. The method of claim 9, wherein the continuous workflow home screen includes an RR frame, the RR frame displaying a numeric value representing respirations per minute, and a respiration rate indicator graph with a plurality of bars, such that, as a detected respiration becomes stronger, more of the bars light up with each breath.

16. The method of claim 9, further comprising changing a display color of the episodic data when an age of the data reaches a threshold.

17. A computer-readable storage medium comprising software instructions that, when executed, cause a physiological measurement platform (PMP) device to:

display, on a display screen of the PMP device, a settings screen enabling a user to select a workflow within which the PMP device is to operate from a plurality of workflows that operate exclusively of each other, including at least an intervals monitoring workflow and a continuous workflow, wherein the workflow selection determines a functionality provided by the PMP device;

display, on the display screen of the PMP device, one of a plurality of workflow home screens based on the workflow selection, each of the workflow home screens being configured to address a different type of workflow;

40

when the intervals monitoring workflow is selected: obtain, by a physiological sensor of the PMP device, a series of measurements taken at intervals of a physiological parameter of a monitored patient; and display, on the display screen of the PMP device, an intervals monitoring workflow home screen;

when the continuous workflow is selected: obtain by the physiological sensor of the PMP device a continuous measurement of the physiological parameter of the monitored patient; and

display, on the display screen of the PMP device, a continuous workflow home screen, the continuous workflow home screen containing a representation of the physiological parameter of the monitored patient, the representation based on the measurement of the physiological parameter of the monitored patient, the continuous workflow home screen including:

an SpO2 frame displaying an oxygen saturation percentage and a pulse amplitude blip bar indicating a pulse beat relative pulse amplitude;

an etCO2 frame displaying a numeric value representing etCO2 and a Capnogram waveform;

an RR frame displaying a numeric value representing respirations per minute; and

episodic data, wherein an aging of the episodic data is shown when an age of the episodic data reaches a threshold, wherein the aging is shown by changing a display color of the episodic data and displaying a timestamp to indicate when a last measurement of the episodic data was taken.

* * * * *

UNITED STATES PATENT AND TRADEMARK OFFICE
CERTIFICATE OF CORRECTION

PATENT NO. : 9,055,870 B2
APPLICATION NO. : 13/440840
DATED : June 16, 2015
INVENTOR(S) : Daniel Thomas Meador, Janalee Esler and Michele Marie Donovan

Page 1 of 1

It is certified that error appears in the above-identified patent and that said Letters Patent is hereby corrected as shown below:

IN THE CLAIMS:

Column 40, line 20-21 should read as follows: -- an etCO₂ frame displaying a numeric value representing etCO₂ and a Capnogram waveform --

Signed and Sealed this
Seventeenth Day of November, 2015



Michelle K. Lee
Director of the United States Patent and Trademark Office

专利名称(译)	支持多种工作流程的生理参数测量平台装置		
公开(公告)号	US9055870	公开(公告)日	2015-06-16
申请号	US13/440840	申请日	2012-04-05
[标]申请(专利权)人(译)	Meador博士丹尼尔托马斯 埃斯勒Janalee 米歇尔-多诺万		
申请(专利权)人(译)	MEADOR, DANIEL THOMAS 埃斯勒, JANALEE 多诺万MICHELE MARIE		
当前申请(专利权)人(译)	伟伦, INC.		
[标]发明人	MEADOR DANIEL THOMAS ESLER JANALEE DONOVAN MICHELE MARIE		
发明人	MEADOR, DANIEL THOMAS ESLER, JANALEE DONOVAN, MICHELE MARIE		
IPC分类号	G01N33/48 A61B5/0205 A61B5/00 G06F19/00 A61B5/1455 A61B5/08 A61B5/024 A61B5/01 A61B5/021 G16H10/60		
CPC分类号	A61B5/0205 A61B5/746 G06F19/327 A61B5/0015 A61B5/01 A61B5/021 A61B5/02438 A61B5/0816 A61B5/14551 A61B2560/0431 G16H40/20 A61B5/0836 A61B5/14546 A61B5/14552 A61B5/72 A61B5/7425 A61B5/743 A61B5/7435		
代理机构(译)	商户德律P.C.		
审查员(译)	LIN, 杰里		
其他公开文献	US20130267793A1		
外部链接	Espacenet USPTO		

摘要(译)

设备获得一个或多个患者的生理参数的一系列测量。当设备在监控工作流程内运行时，设备会显示监控工作流程主屏幕。当设备在非监控工作流程中运行时，设备会显示非监控工作流程主屏幕。当设备在连续工作流程中运行时，设备显示连续工作流程主屏幕。监视工作流程主屏幕，非监视工作流程主屏幕和连续工作流程主屏幕各自不同。

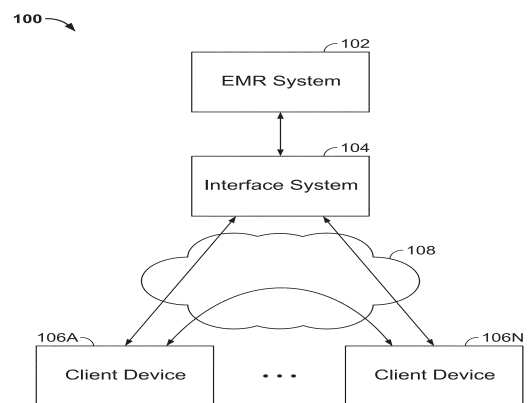

FIG. 1