



US008876738B1

(12) **United States Patent**  
**Kahn et al.**

(10) **Patent No.:** **US 8,876,738 B1**  
(45) **Date of Patent:** **Nov. 4, 2014**

(54) **HUMAN ACTIVITY MONITORING DEVICE**

(75) Inventors: **Philippe Kahn**, Aptos, CA (US);  
**Arthur Kinsolving**, Santa Cruz, CA  
(US); **Mark Andrew Christensen**, Santa  
Cruz, CA (US); **Brian Y. Lee**, Aptos, CA  
(US); **David Vogel**, Santa Cruz, CA (US)

(73) Assignee: **DP Technologies, Inc.**, Scotts Valley, CA  
(US)

(\* ) Notice: Subject to any disclaimer, the term of this  
patent is extended or adjusted under 35  
U.S.C. 154(b) by 0 days.

4,700,369 A 10/1987 Seigal et al.  
5,323,060 A 6/1994 Fogal et al.  
5,446,725 A 8/1995 Ishiwatari  
5,446,775 A 8/1995 Wright et al.  
5,485,402 A 1/1996 Smith et al.  
5,515,419 A 5/1996 Sheffer  
5,583,776 A 12/1996 Levi et al.  
5,593,431 A 1/1997 Sheldon  
5,654,619 A 8/1997 Iwashita  
5,778,882 A 7/1998 Raymond et al.  
5,955,667 A 9/1999 Fyfe  
5,976,083 A 11/1999 Richardson et al.  
6,013,007 A 1/2000 Root et al.  
6,122,595 A 9/2000 Varley et al.  
6,129,686 A \* 10/2000 Friedman ..... 600/595

(Continued)

(21) Appl. No.: **12/834,845**

(22) Filed: **Jul. 12, 2010**

**Related U.S. Application Data**

(63) Continuation of application No. 11/732,949, filed on  
Apr. 4, 2007, now Pat. No. 7,753,861.

(51) **Int. Cl.**  
**A63B 71/00** (2006.01)  
**A61B 5/00** (2006.01)  
**A61B 5/103** (2006.01)  
**A61B 5/117** (2006.01)

(52) **U.S. Cl.**  
USPC ..... **600/595**; 482/8; 482/9; 600/300;  
600/301; 600/587

(58) **Field of Classification Search**  
USPC ..... 482/8; 600/301, 508, 587, 595  
See application file for complete search history.

(56) **References Cited**

**U.S. PATENT DOCUMENTS**

4,285,041 A 8/1981 Smith  
4,578,769 A 3/1986 Frederick

**FOREIGN PATENT DOCUMENTS**

EP 1271099 A2 1/2003  
GB 2431813 A 5/2007

(Continued)

**OTHER PUBLICATIONS**

Cheng, et al, "Periodic Human Motion Description for Sports Video  
Databases," Proceedings of the Pattern Recognition, 2004, 5 pages.

(Continued)

*Primary Examiner* — Sean Dougherty

(74) *Attorney, Agent, or Firm* — HIPLegal LLP; Judith A.  
Szepesi

(57) **ABSTRACT**

A method for monitoring human activity using an inertial  
sensor includes monitoring accelerations from an inertial sensor  
integrated into a garment. The accelerations are processed  
to determine one or more acceleration statistics, and transmit  
the acceleration statistics.

**20 Claims, 14 Drawing Sheets**

701 ↘

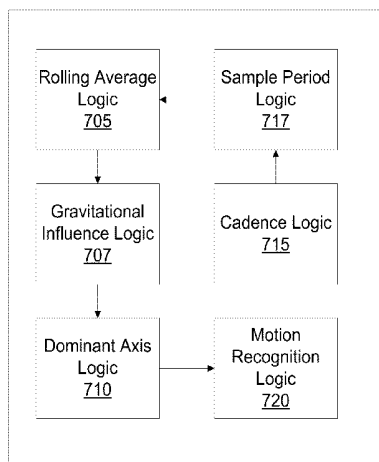

(56)

## References Cited

## U.S. PATENT DOCUMENTS

6,135,951 A	10/2000	Richardson et al.	2002/0089425 A1	7/2002	Kubo et al.
6,145,389 A	11/2000	Ebeling et al.	2002/0109600 A1	8/2002	Mault et al.
6,282,496 B1	8/2001	Chowdhary	2002/0118121 A1	8/2002	Lehrman et al.
6,353,449 B1	3/2002	Gregg et al.	2002/0151810 A1	10/2002	Wong et al.
6,369,794 B1	4/2002	Sakurai et al.	2002/0193124 A1	12/2002	Hamilton et al.
6,428,490 B1	8/2002	Kramer et al.	2003/0018430 A1	1/2003	Ladetto et al.
6,493,652 B1	12/2002	Ohlenbusch et al.	2003/0048218 A1	3/2003	Milnes et al.
6,496,695 B1	12/2002	Kouji et al.	2003/0083596 A1	5/2003	Kramer et al.
6,513,381 B2	2/2003	Fyfe et al.	2003/0109258 A1	6/2003	Mantjarvi et al.
6,522,266 B1	2/2003	Soehren et al.	2003/0139692 A1	7/2003	Barrey et al.
6,529,144 B1	3/2003	Nilsen et al.	2004/0106421 A1	6/2004	Tomiyoshi et al.
6,532,419 B1	3/2003	Begin et al.	2004/0225467 A1	11/2004	Vock et al.
6,539,336 B1	3/2003	Vock et al.	2004/0236500 A1	11/2004	Choi et al.
6,611,789 B1	8/2003	Darley	2005/0033200 A1	2/2005	Soehren et al.
6,700,499 B2	3/2004	Kubo et al.	2005/0048945 A1	3/2005	Porter
6,766,176 B1	7/2004	Gupta et al.	2005/0202934 A1	9/2005	Olrik et al.
6,771,250 B1	8/2004	Oh	2005/0210300 A1	9/2005	Song et al.
6,786,877 B2	9/2004	Foxlin	2005/0222801 A1	10/2005	Wulff et al.
6,790,178 B1	9/2004	Mault et al.	2005/0232388 A1	10/2005	Tsuji
6,813,582 B2	11/2004	Levi et al.	2005/0232404 A1	10/2005	Gaskill
6,823,036 B1	11/2004	Chen	2005/0238132 A1	10/2005	Tsuji
6,826,477 B2	11/2004	Ladetto et al.	2005/0240375 A1	10/2005	Sugai
6,836,744 B1	12/2004	Asphahani et al.	2005/0248718 A1	11/2005	Howell et al.
6,881,191 B2	4/2005	Oakley et al.	2006/0020177 A1	1/2006	Seo et al.
6,885,971 B2	4/2005	Vock et al.	2006/0063980 A1	3/2006	Hwang et al.
6,898,550 B1	5/2005	Blackadar et al.	2006/0064276 A1	3/2006	Ren et al.
6,928,382 B2	8/2005	Hong et al.	2006/0090161 A1	4/2006	Bodas et al.
6,941,239 B2	9/2005	Unuma et al.	2006/0100546 A1	5/2006	Silk
6,959,259 B2	10/2005	Vock et al.	2006/0136173 A1	6/2006	Case, Jr. et al.
6,975,959 B2	12/2005	Dietrich et al.	2006/0149516 A1	7/2006	Bond et al.
7,002,553 B2	2/2006	Shkolnikov	2006/0161377 A1	7/2006	Rakkola et al.
7,010,332 B1	3/2006	Irvin et al.	2006/0167387 A1	7/2006	Buchholz et al.
7,054,784 B2	5/2006	Flentov et al.	2006/0174685 A1	8/2006	Skvortsov et al.
7,057,551 B1	6/2006	Vogt	2006/0201964 A1	9/2006	DiPerna et al.
7,072,789 B2	7/2006	Vock et al.	2006/0205406 A1	9/2006	Pekonen et al.
7,092,846 B2	8/2006	Vock et al.	2006/0206258 A1	9/2006	Brooks
7,148,797 B2	12/2006	Albert	2006/0223547 A1	10/2006	Chin et al.
7,148,879 B2	12/2006	Amento et al.	2006/0259268 A1	11/2006	Vock et al.
7,158,912 B2	1/2007	Vock et al.	2006/0284979 A1	12/2006	Clarkson
7,169,084 B2	1/2007	Tsuji	2006/0288781 A1	12/2006	Daumer et al.
7,171,331 B2	1/2007	Vock et al.	2007/0037610 A1	2/2007	Logan
7,177,684 B1	2/2007	Kroll et al.	2007/0038364 A1	2/2007	Lee et al.
7,200,517 B2	4/2007	Darley et al.	2007/0061105 A1	3/2007	Darley et al.
7,212,943 B2	5/2007	Aoshima et al.	2007/0063850 A1	3/2007	Devaul et al.
7,220,220 B2	5/2007	Stubbs et al.	2007/0067094 A1	3/2007	Park et al.
7,245,725 B1	7/2007	Beard	2007/0073482 A1	3/2007	Churchill et al.
7,297,088 B2	11/2007	Tsuji	2007/0078324 A1	4/2007	Wijisiriwardana
7,305,323 B2	12/2007	Skvortsov et al.	2007/0082789 A1	4/2007	Nissila et al.
7,328,611 B2	2/2008	Klees et al.	2007/0102525 A1	5/2007	Orr et al.
7,334,472 B2	2/2008	Seo et al.	2007/0104479 A1	5/2007	Machida
7,353,112 B2	4/2008	Choi et al.	2007/0125852 A1	6/2007	Rosenberg
7,387,611 B2	6/2008	Inoue et al.	2007/0130582 A1	6/2007	Chang et al.
7,451,056 B2	11/2008	Flentov et al.	2007/0142715 A1	6/2007	Banet et al.
7,457,719 B1	11/2008	Kahn et al.	2007/0143068 A1	6/2007	Pasolini et al.
7,463,997 B2	12/2008	Pasolini et al.	2007/0145680 A1	6/2007	Rosenberg
7,467,060 B2	12/2008	Kulach et al.	2007/0150136 A1	6/2007	Doll et al.
7,489,937 B2	2/2009	Chung et al.	2007/0195784 A1	8/2007	Allen et al.
7,502,643 B2	3/2009	Farrington et al.	2007/0208531 A1	9/2007	Darley et al.
7,512,515 B2	3/2009	Vock et al.	2007/0208544 A1	9/2007	Kulach et al.
7,526,402 B2	4/2009	Tanenhaus et al.	2007/0213085 A1	9/2007	Fedora
7,608,050 B2	10/2009	Sugg	2007/0213126 A1	9/2007	Deutsch et al.
7,640,804 B2	1/2010	Daumer et al.	2007/0233788 A1	10/2007	Bender
7,647,196 B2	1/2010	Kahn et al.	2007/0250261 A1	10/2007	Soehren
7,653,508 B1	1/2010	Kahn et al.	2007/0259716 A1	11/2007	Mattice et al.
7,752,011 B2	7/2010	Niva et al.	2007/0259717 A1	11/2007	Mattice et al.
7,753,861 B1	7/2010	Kahn et al.	2007/0260418 A1	11/2007	Ladetto et al.
7,774,156 B2	8/2010	Niva et al.	2007/0260482 A1	11/2007	Nurmela et al.
7,788,059 B1	8/2010	Kahn et al.	2007/0296696 A1	12/2007	Nurmi
7,857,772 B2	12/2010	Bouvier et al.	2008/0102785 A1	5/2008	Childress et al.
7,881,902 B1	2/2011	Kahn et al.	2008/0161072 A1	7/2008	Lide et al.
7,892,080 B1	2/2011	Dahl	2008/0171918 A1	7/2008	Teller et al.
7,987,070 B2	7/2011	Kahn et al.	2008/0243432 A1	10/2008	Kato et al.
8,275,635 B2	9/2012	Stivoric et al.	2009/0043531 A1	2/2009	Kahn et al.
8,398,546 B2	3/2013	Pacione et al.	2009/0047645 A1	2/2009	Dibenedetto et al.
2002/0023654 A1	2/2002	Webb	2009/0098880 A1	4/2009	Lindquist
			2009/0124348 A1	5/2009	Yoseloff et al.
			2009/0213002 A1	8/2009	Rani et al.
			2009/0215502 A1	8/2009	Griffin, Jr.
			2009/0234614 A1	9/2009	Kahn et al.



(56)

**References Cited**

OTHER PUBLICATIONS

Tapia, Emmanuel Munguia, et al, "Real-Time Recognition of Physical Activities and Their Intensities Using Wireless Accelerometers and a Heart Rate Monitor," IEEE Cont. on Wearable Computers, Oct. 2007, 4 pages.

Wixted, Andrew J, et al, "Measurement of Energy Expenditure in Elite Athletes Using MEMS-Based Triaxial Accelerometers," IEEE Sensors Journal, vol. 7, No. 4, Apr. 2007, pp. 481-488.

Wu, Winston H, et al, "Context-Aware Sensing of Physiological Signals," IEEE Int. Conf. on Engineering for Medicine and Biology, Aug. 23-26, 2007, pp. 5271-5275.

"Heart Rate Monitor Sports Bra," <[www.numetrex.com/about/heart-rate-monitor-sports-bra](http://www.numetrex.com/about/heart-rate-monitor-sports-bra)>, Accessed Aug. 9, 2013, 2 pages.

Meinhold, Bridgette, "Adidas by Stella McCartney's Tennis Bra Includes Built-In Heart Sensor," <[www.ecouterre.com/adidas-by-stella-mccartneys-tennis-bra-includes-built-in-heart-sensor/](http://www.ecouterre.com/adidas-by-stella-mccartneys-tennis-bra-includes-built-in-heart-sensor/)>, Mar. 23, 2012, 2 pages.

"Smart Underwear With Biosensors Availability in the Market Kudos to Modern Inkjet Printer Technology," <[www.kokeytechnology.com/biotechnology/smart-underwear-with-biosensors-availability-in-the-market-kudos-to-modern-inkjet-printer-technology/](http://www.kokeytechnology.com/biotechnology/smart-underwear-with-biosensors-availability-in-the-market-kudos-to-modern-inkjet-printer-technology/)>, Published Jul. 21, 2010, 2 pages.

\* cited by examiner

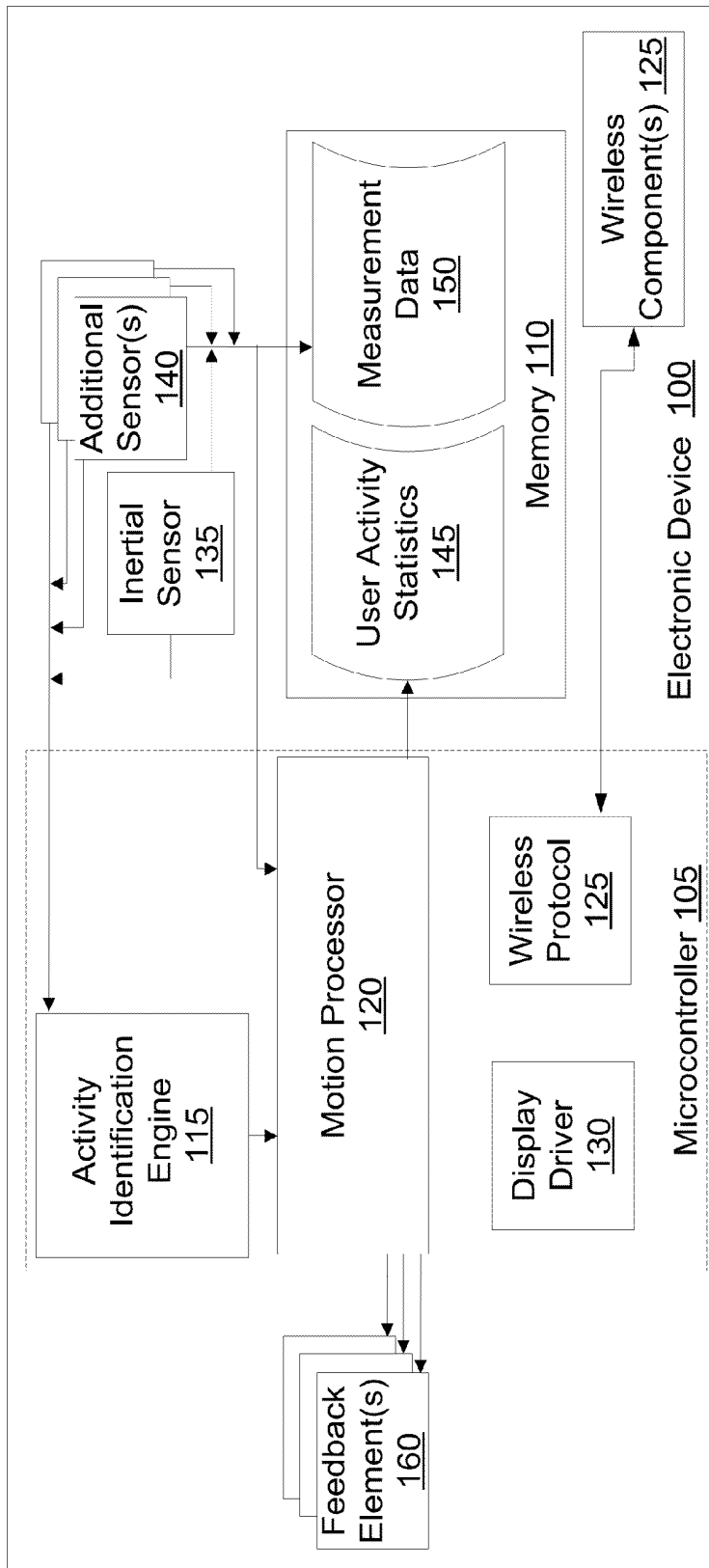

Figure 1

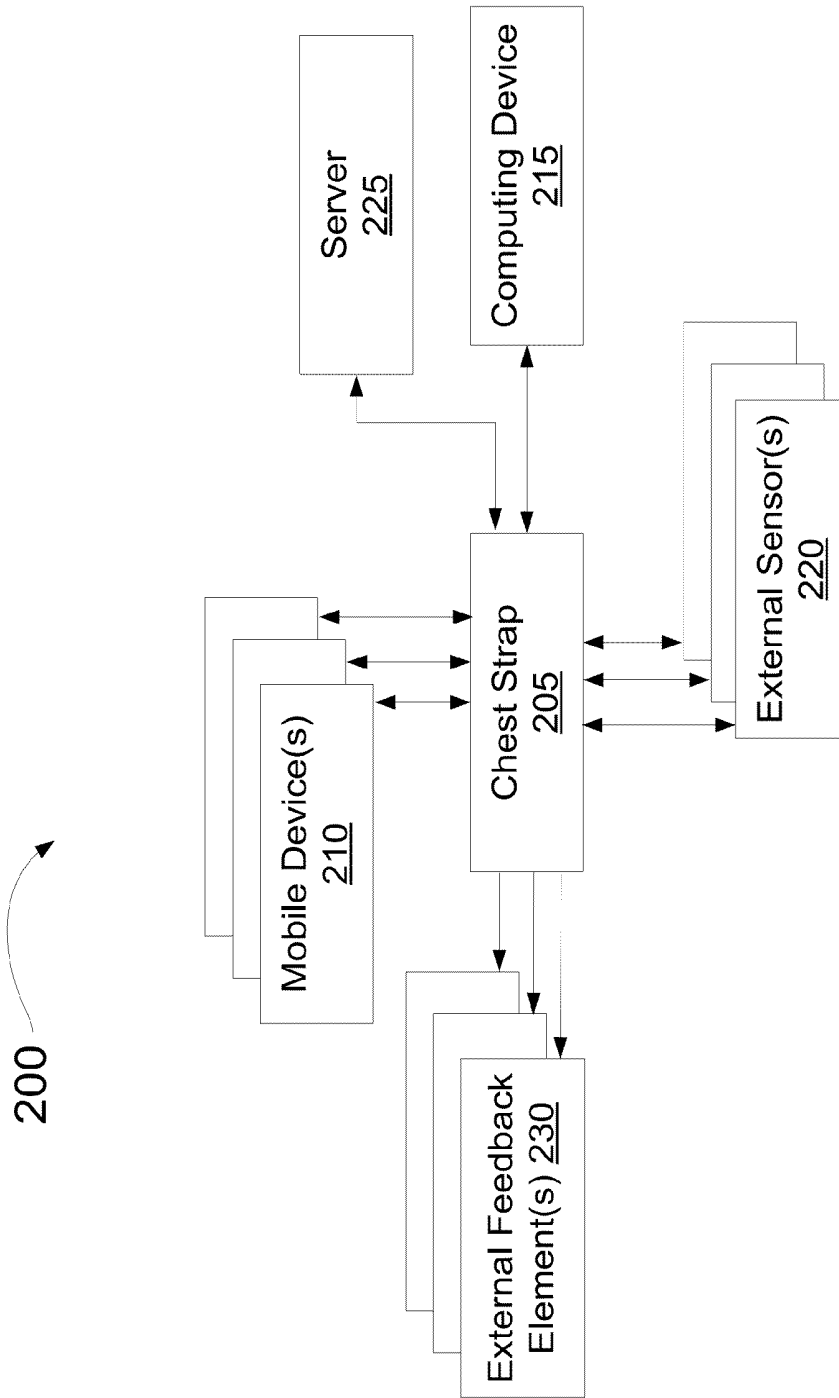

Figure 2

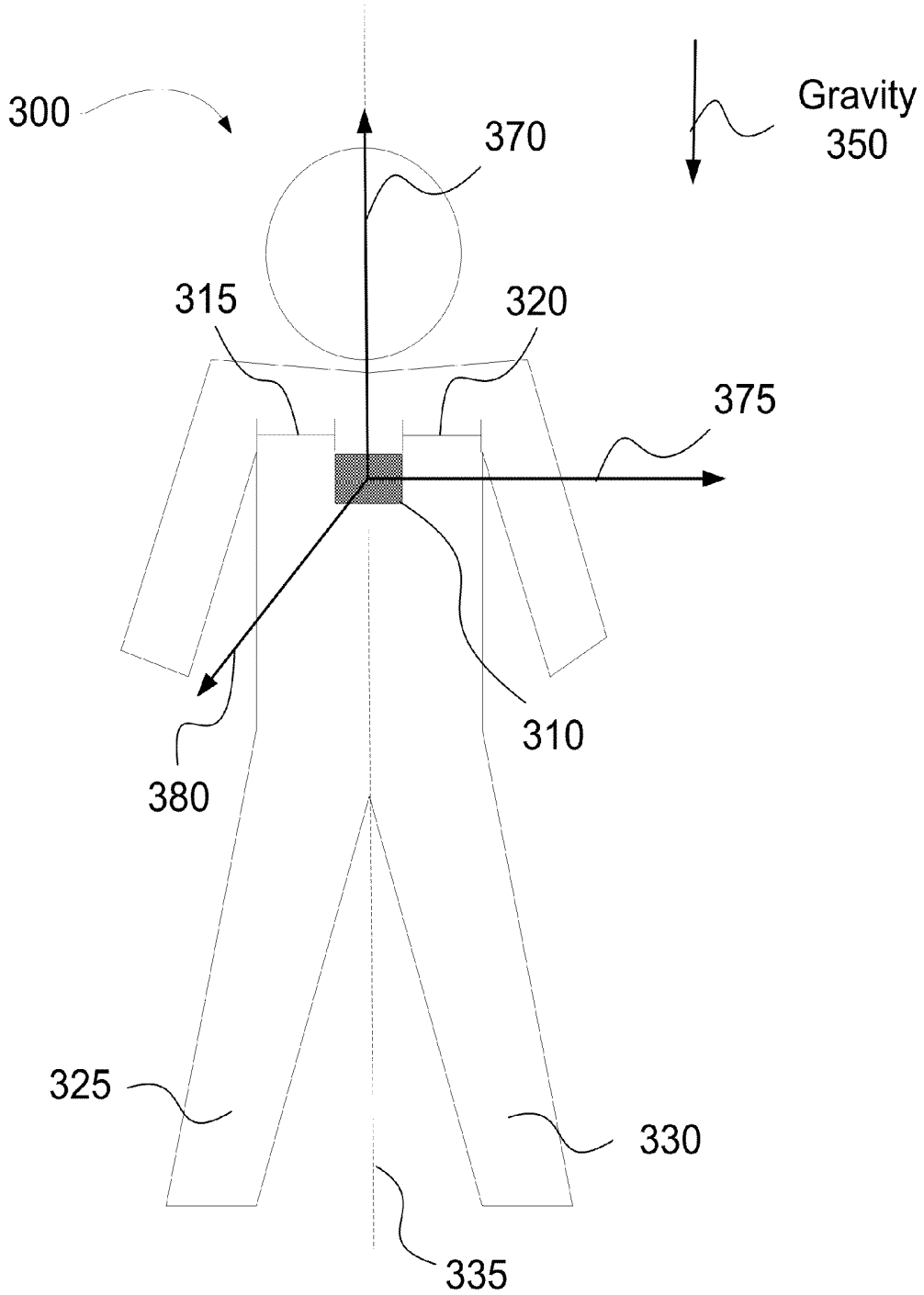

Figure 3

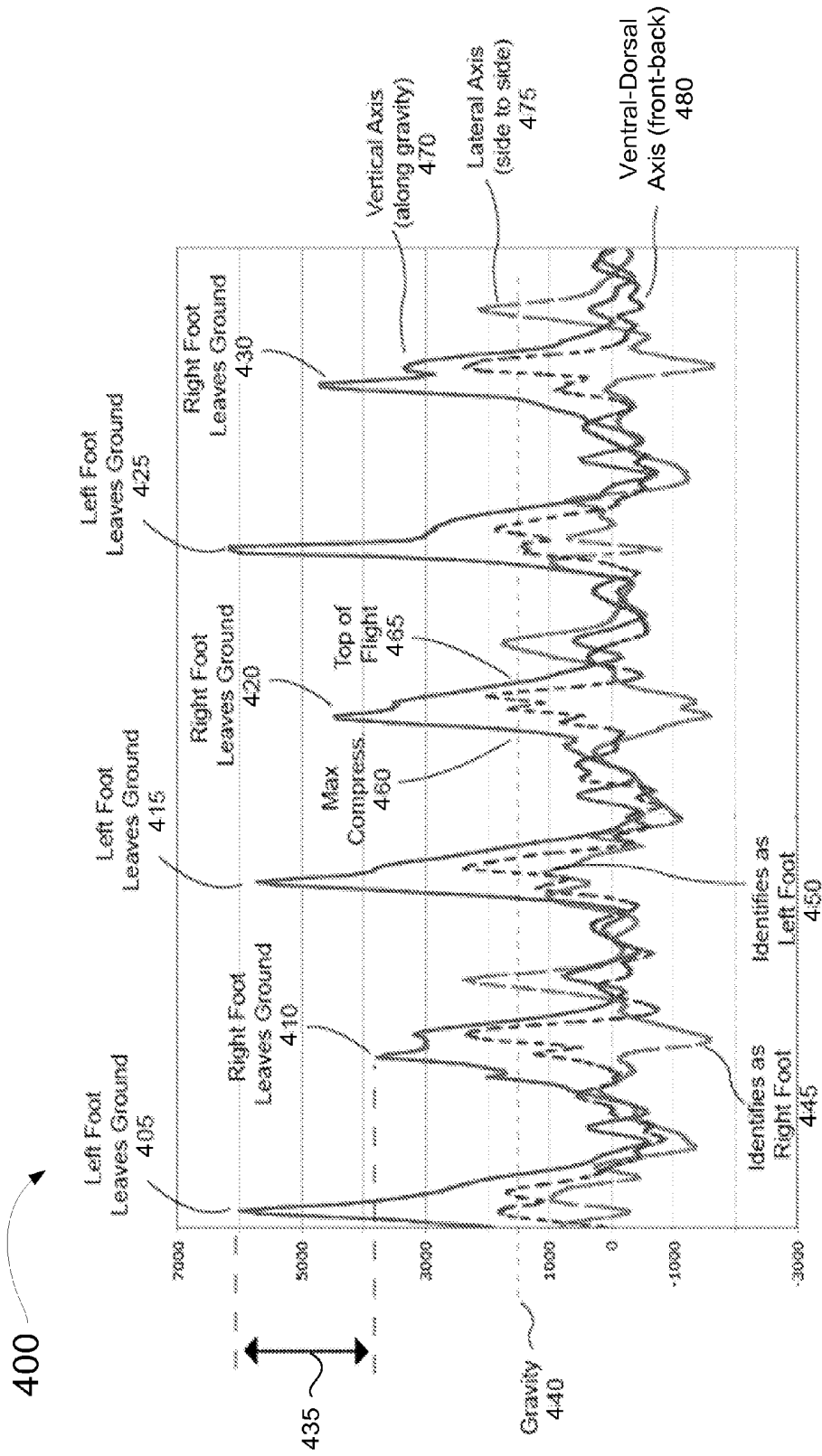

Figure 4

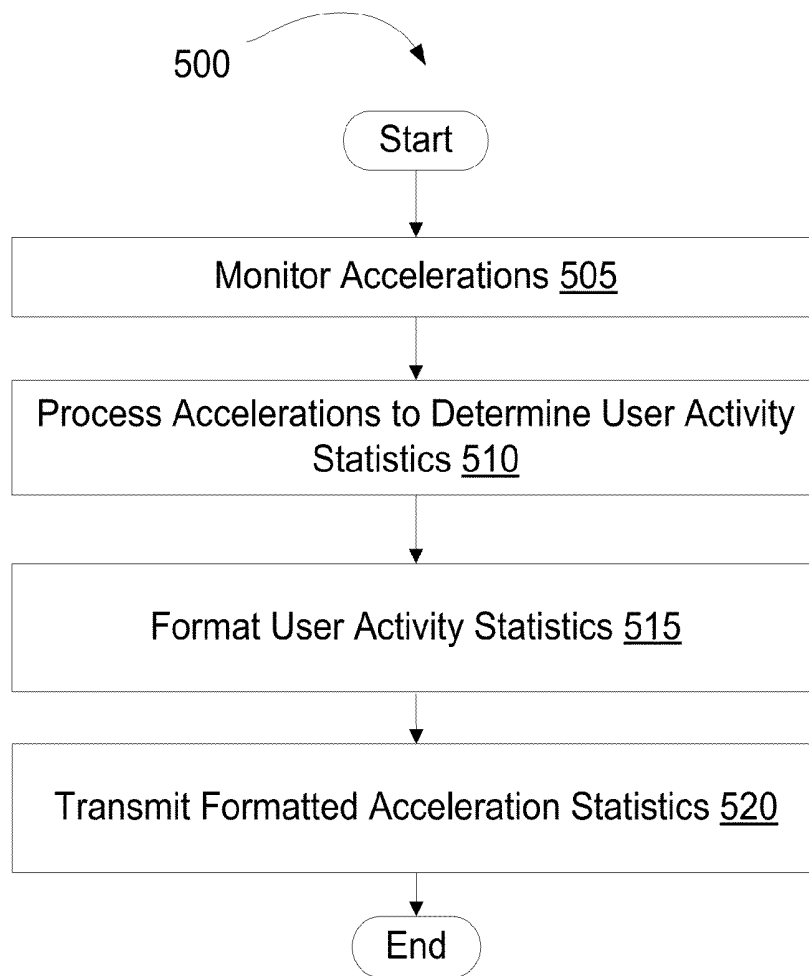

Figure 5

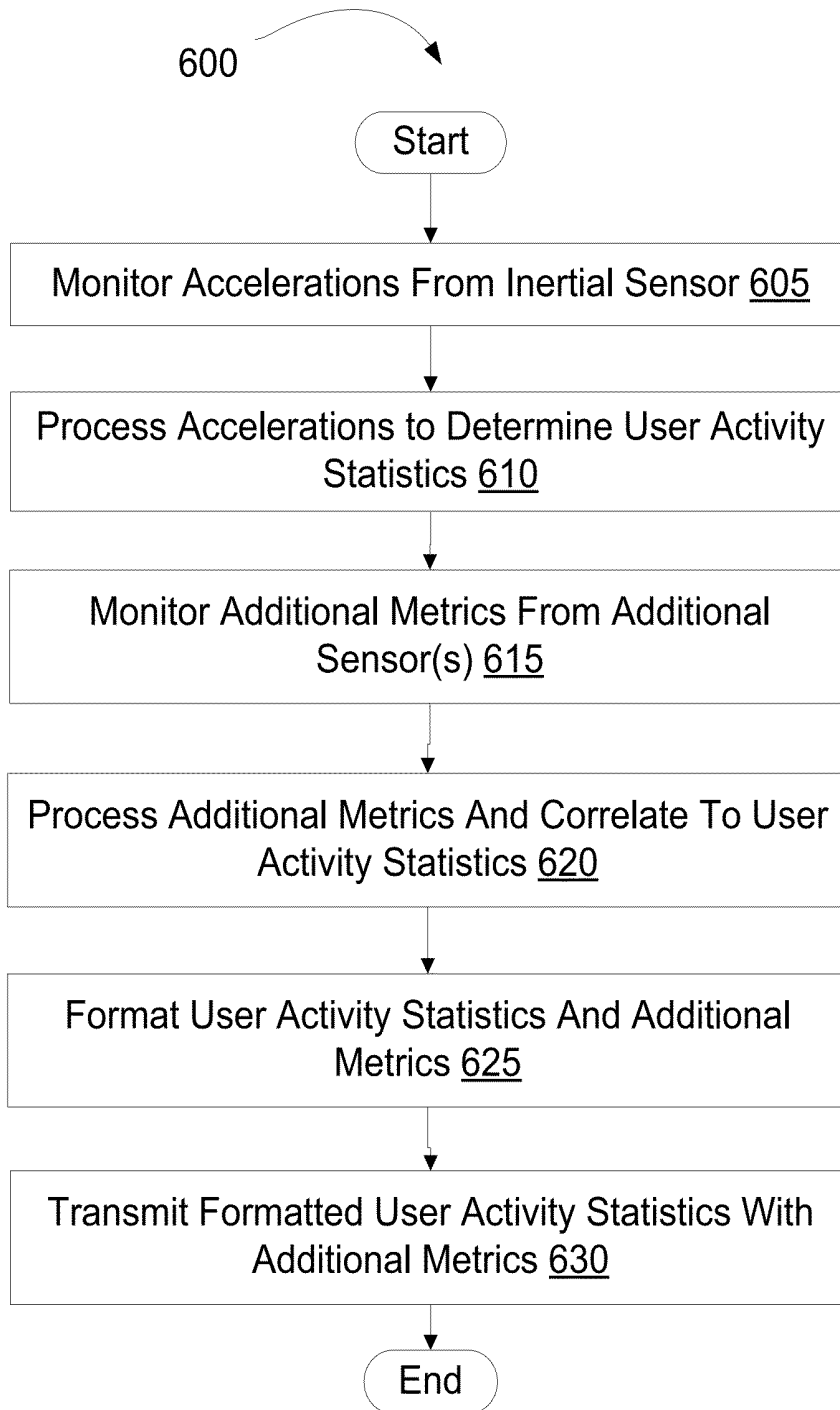



Figure 6

701 

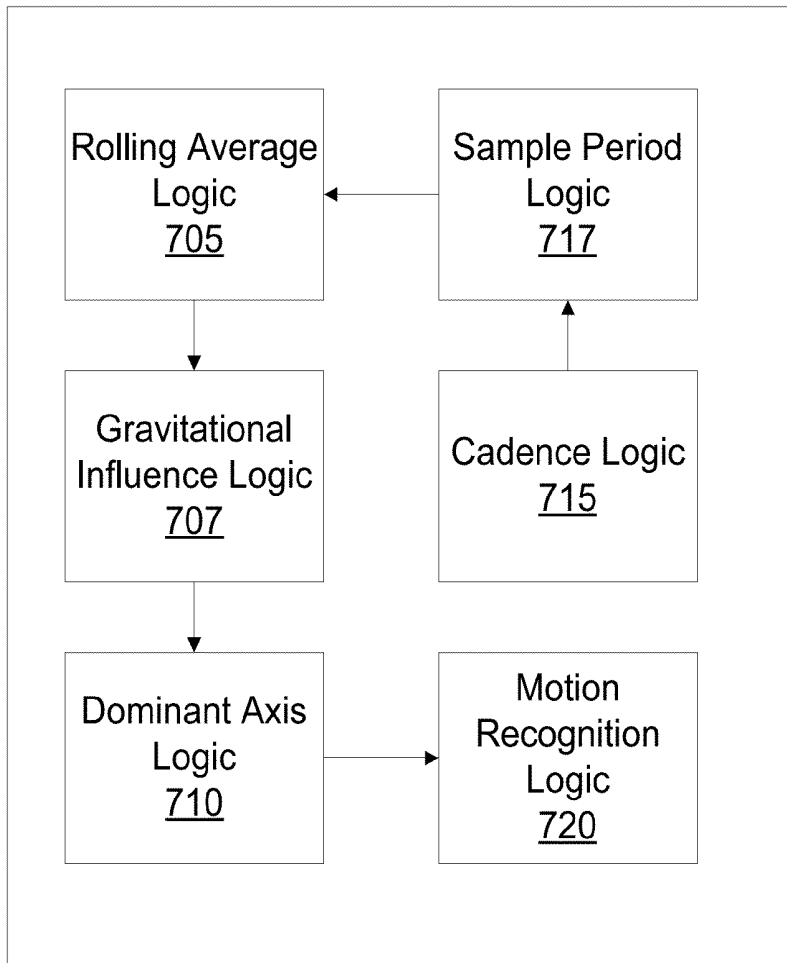

Figure 7

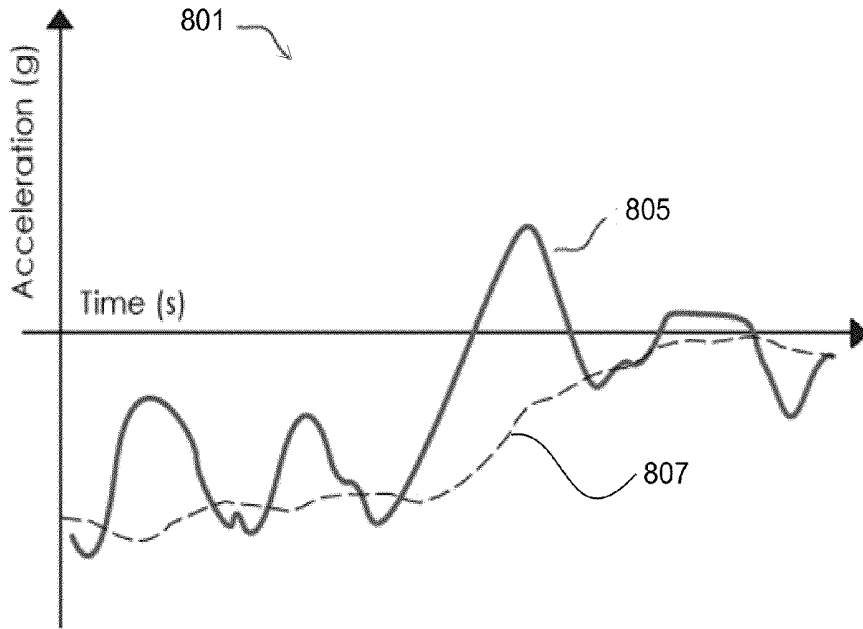

Figure 8A

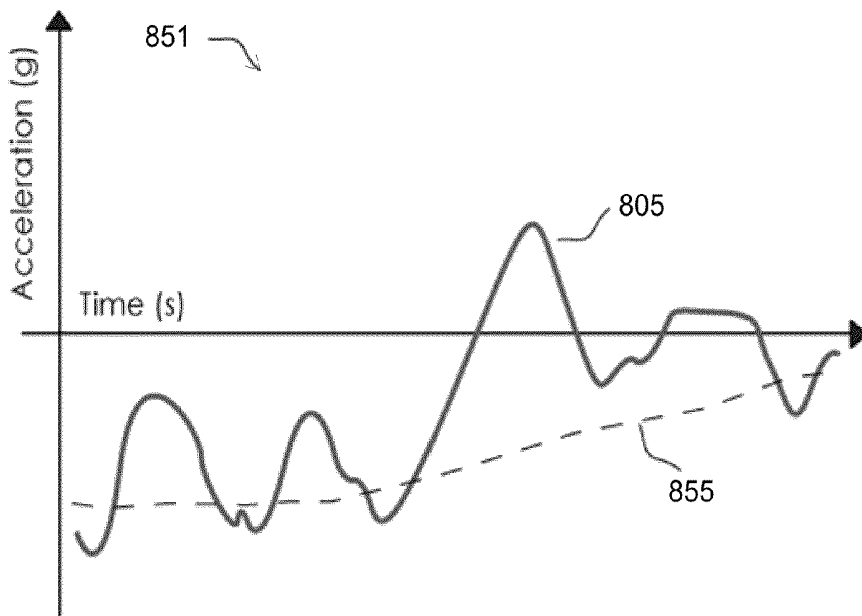

Figure 8B

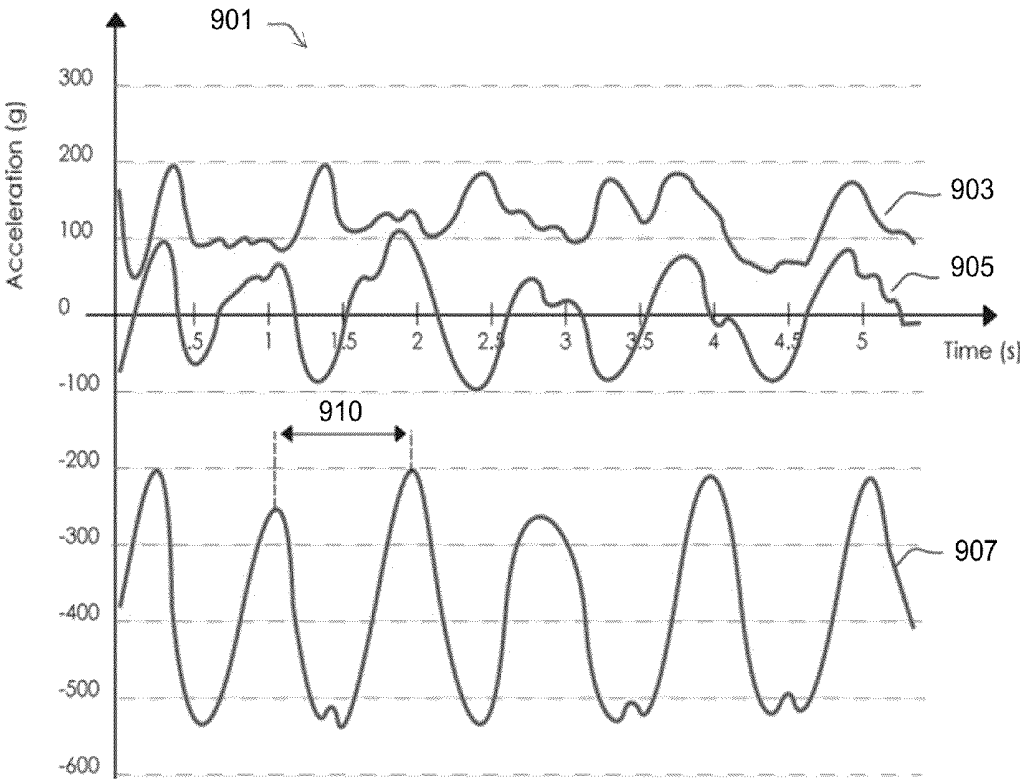

Figure 9

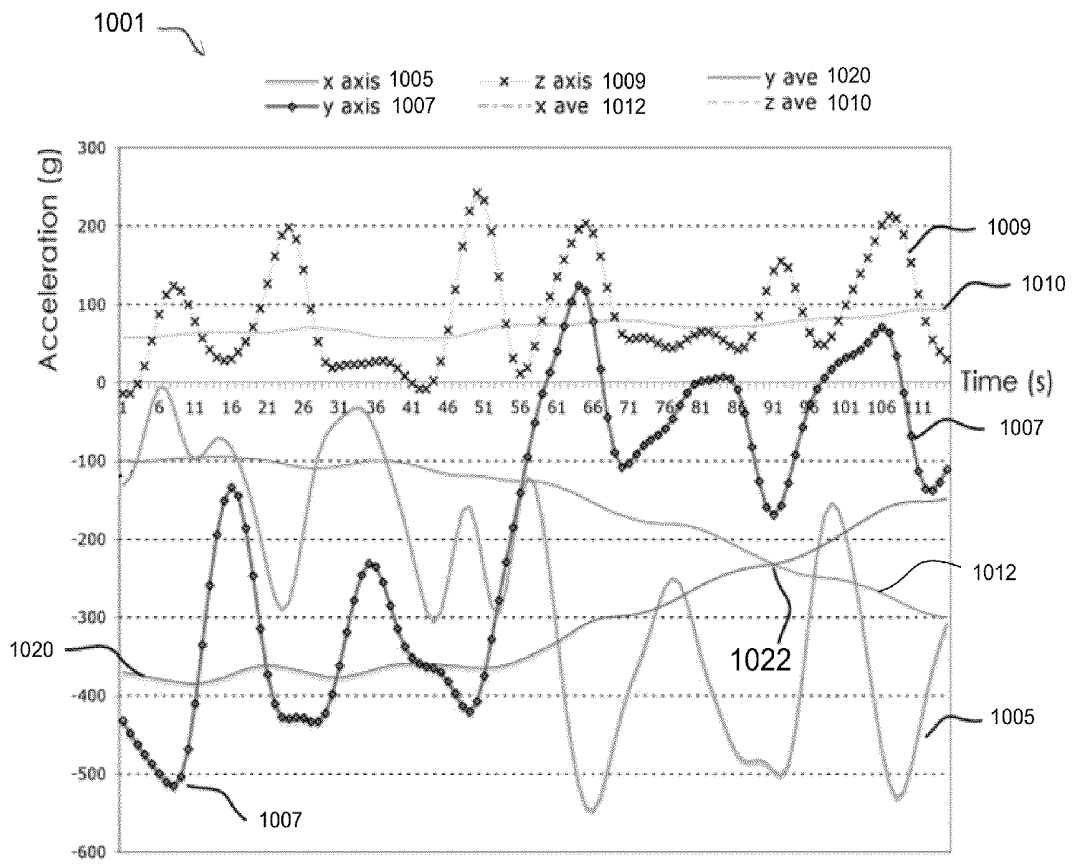

Figure 10A

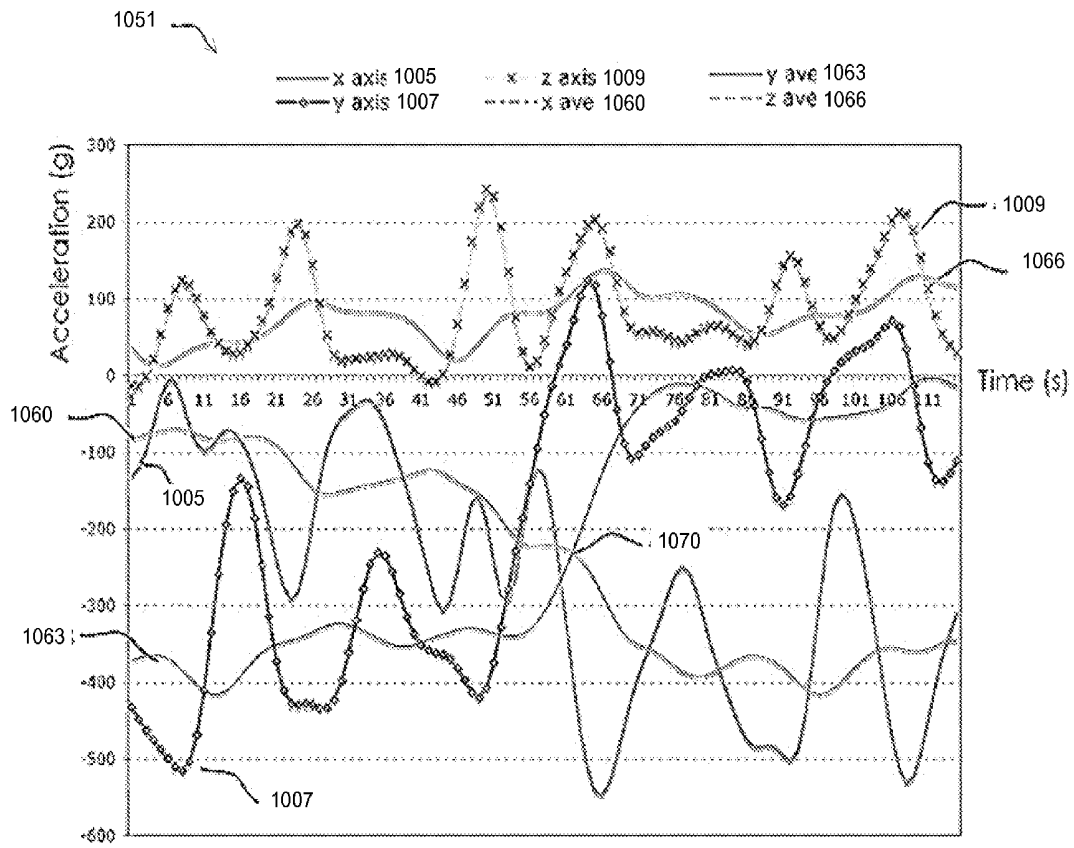

Figure 10B

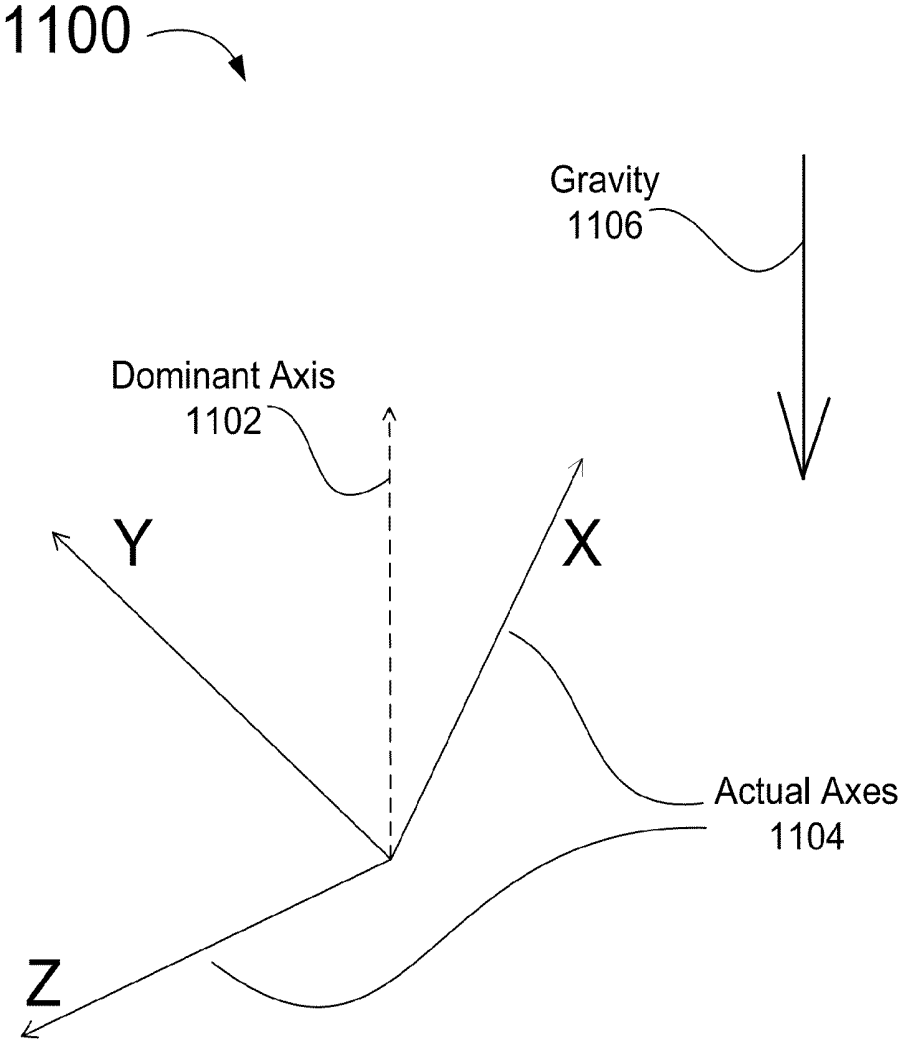

Figure 11

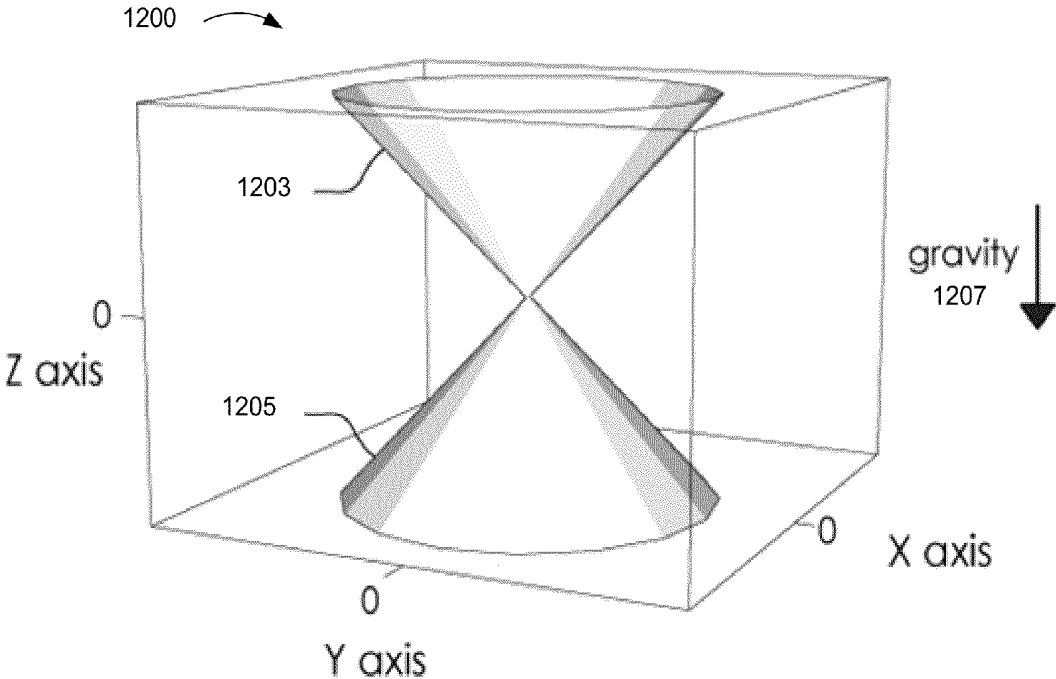

Figure 12

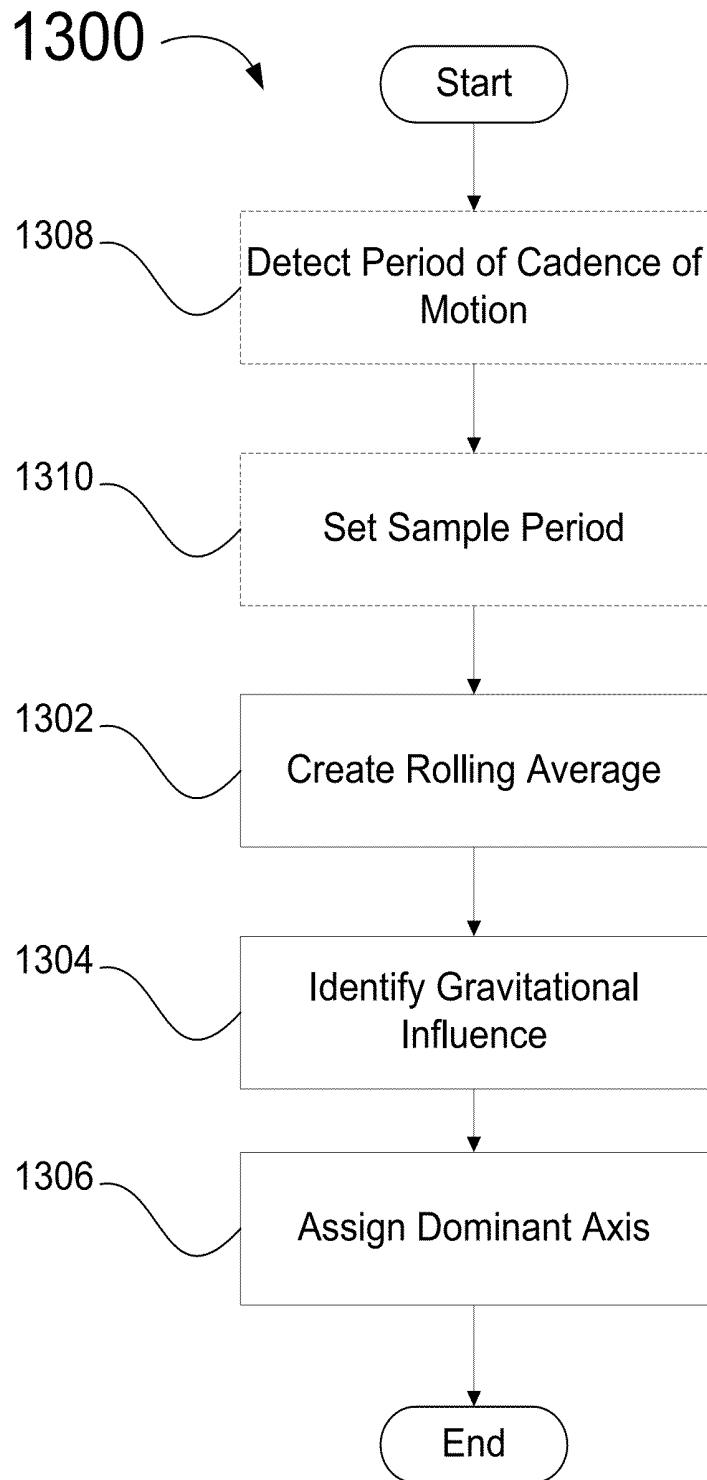

Figure 13

## HUMAN ACTIVITY MONITORING DEVICE

## RELATED APPLICATIONS

The present application is a continuation of U.S. application Ser. No. 11/732,949, filed on Apr. 4, 2007, which is U.S. Pat. No. 7,753,861 issuing on Jul. 13, 2010.

## FIELD OF THE INVENTION

This invention relates to a method of monitoring human activity, and more particularly to an inertial device integrated into a garment having a human activity monitoring device.

## BACKGROUND

The development of Micro-Electro-Mechanical Systems (MEMS) technology has enabled manufacturers to produce inertial sensors (e.g., accelerometers) of sufficiently small size, cost, and power consumption to fit into portable electronic devices. Such inertial sensors can be found in a limited number of commercial electronic devices such as cellular phones, portable music players, pedometers, game controllers, and portable computers.

Step counting devices (e.g., pedometers) are used to monitor an individual's daily activity by keeping track of the number of steps that he or she takes. In general, step counting devices are clipped to a user's hip, and do not accurately count steps when placed elsewhere on a user's body.

Some step counting devices include an inertial sensor placed at specific locations on a user's body (e.g., in a user's shoe or belt). These inertial sensors wirelessly transmit raw acceleration data to a mobile device (e.g., a wrist watch) having an acceleration processing unit. The acceleration processing unit counts steps based on the received acceleration data. These steps can then be displayed on the mobile device.

## BRIEF DESCRIPTION OF THE DRAWINGS

The present invention is illustrated by way of example, and not by way of limitation, and can be more fully understood with reference to the following detailed description when considered in connection with the following figures:

FIG. 1 is a block diagram illustrating an electronic device, in accordance with one embodiment of the present invention;

FIG. 2 is a block diagram illustrating a motion identification system, in accordance with one embodiment of the present invention;

FIG. 3 illustrates a front view of a user wearing a motion identification system on the torso, in accordance with one embodiment of the present invention;

FIG. 4 illustrates a first exemplary motion cycle graph that shows a user engaged in a user activity as measured by an accelerometer;

FIG. 5 illustrates a flow diagram for a method of monitoring human activity using an inertial sensor, in accordance with one embodiment of the present invention;

FIG. 6 illustrates a flow diagram for a method of monitoring human activity using an inertial sensor, in accordance with one embodiment of the present invention.

FIG. 7 is a block diagram illustrating one embodiment of an electronic device;

FIGS. 8A and 8B illustrate exemplary rolling average graphs that measure time versus acceleration;

FIG. 9 illustrates an exemplary cadence of motion graph that measures time versus acceleration;

FIGS. 10A and 10B illustrate exemplary gravitational influence graphs;

FIG. 11 illustrates a plan view of a dominant axis that does not correspond to an actual axis;

FIG. 12 illustrates an exemplary probability range represented by a plurality of cones; and

FIG. 13 shows a processing diagram for a method of determining an orientation of an accelerometer in accordance with one embodiment of the present invention.

## DETAILED DESCRIPTION

Embodiments of the present invention are designed to monitor human activity using an inertial sensor. In one embodiment, accelerations are monitored from an inertial sensor disposed in a garment. The accelerations are processed to determine one or more acceleration statistics, examples of which include speed, distance, and number of steps taken. The acceleration statistics are formatted to a generic format understandable by a plurality of devices. The formatted acceleration statistics are then transmitted. The transmission may be a wireless transmission to one or more of the plurality of devices.

FIG. 1 is a block diagram illustrating an electronic device **100**, in accordance with one embodiment of the present invention. In one embodiment, the electronic device **100** is a portable electronic device that includes one or more inertial sensors. The inertial sensors may measure accelerations along a single axis or multiple axes, and may measure linear as well as rotational (angular) accelerations. In one embodiment, one or more inertial sensors together provide three dimensional acceleration data.

The electronic device **100** may be used to identify user activities and count periodic human motions appropriate to the identified user activities. In one embodiment, electronic device **100** operates in conjunction with additional devices (e.g., a server or mobile computing device) and/or sensors to identify user activities and count periodic human motions. In one embodiment, periodic human motions may be accurately counted regardless of the placement and/or orientation of the device **100** on a user. Periodic human motions may be accurately counted whether the electronic device **100** maintains a fixed orientation or changes orientation during operation.

The electronic device **100** in one embodiment comprises an activity identification engine **115**, a motion processor **120**, an inertial sensor **135**, a memory **110**, a wireless protocol **125** and one or more wireless components **125**. The electronic device **100** may further comprise one or more additional sensors **140** and a display driver **130**.

The inertial sensor **135** may continuously take measurements of acceleration data. The measurements of acceleration data are taken at a sampling rate that may be fixed or variable. In one embodiment, the inertial sensor **135** receives a timing signal from a timer (not shown) in order to take measurements at the sampling rate. In one embodiment, the inertial sensor **135** is coupled to the activity identification engine **115** and to the motion processor **120**, and acceleration measurement data is sent to the activity identification engine **115** and to the motion processor **120** for processing. In one embodiment, the inertial sensor **135** is coupled to the memory **110**, and measurement data **150** from the inertial sensor **135** is stored in the memory **110**.

In one embodiment, measurements are taken of the one or more additional sensors **140**, and sent to the activity identification engine **115**, the motion processor **120**, and/or the memory **110**. In one embodiment, the one or more additional sensors **140** include a heart rate sensor such as an electrocar-

diograph (EKG or ECG). Additional sensors **140** may also include additional inertial sensors, a pressure sensor, a moisture sensor, a capacitance sensor, a sound sensor (e.g., microphone), a heat sensor (e.g., thermometer, thermistor, etc.), or any other sensor capable of placement in a portable device. In one embodiment, the one or more additional sensors **140** take measurements at one or more set sampling rates that may be fixed or variable. In one embodiment, the set sampling rates are the same as the sampling rate at which the acceleration measurements are taken. Alternatively, one or more of the set sampling rates may vary from the sampling rate of the acceleration measurements.

In one embodiment, acceleration measurement data is processed by the activity identification engine **115** to identify a user activity. The activity identification engine **115** may identify the user activity from a plurality of identifiable user activities. The activity identification engine may identify a user activity by monitoring for different events, each event indicative of a different type of activity. In one embodiment, when enough events indicative of a particular user activity are detected, the activity identification engine **115** notifies the motion processor **120** that the identified activity is being performed by the user. One embodiment of a method for identifying user activities may be found in co-pending application U.S. Ser. No. 60/900,412, which is incorporated herein by reference. Alternative means of identifying user activities may be used in other embodiments.

In one embodiment, only acceleration measurement data is used to detect events that identify user activities. Alternatively, measurements from one or more of the additional sensors **140** may be used to facilitate user activity identification. For example, heart rate measurements showing a heart rate greater than a threshold value may indicate that a user is exerting himself, which may trigger an event for a user activity of, for example, running.

The motion processor **120** may process acceleration measurement data to detect periodic human motions. In one embodiment, a series of motion criteria are applied to the acceleration measurement data. If each of the motion criteria are satisfied, a periodic human motion may be identified, and counted. In one embodiment, a different set of motion criteria may apply for each user activity. Once the activity identification engine **115** has identified a user activity, the motion processor **120** may apply a set of motion criteria specific to the identified activity to detect appropriate periodic human motions. When an appropriate periodic human motion is detected, it may be recorded as one of the user activity statistics **145** (e.g., number of steps walked) in the memory **110**. One embodiment of a method for counting periodic human motions may be found in co-pending application U.S. Ser. No. 11/644,455, which is incorporated herein by reference. Alternative means of counting periodic human motions may be used in other embodiments.

In one embodiment, the motion processor **120** generates user activity statistics based on measurements from the inertial sensor **135**. Alternatively, one or more of the additional sensors **140** may also be used to generate user activity statistics. Examples of user activity statistics include periodic human motion counts, distance, speed, etc. In one embodiment, the user activity statistics are formatted by the motion processor **120** once they are generated. The user activity statistics may be formatted into one or more formats. In one embodiment, the user activity statistics are formatted to a generic format understandable by multiple different computing devices. Examples of generic formats for the user activity statistics include extensible markup language (XML) and

standard generalized markup language (SGML). In one embodiment, the format used for the user activity statistics is user selectable.

One type of user activity statistic is a periodic human motion count. A separate periodic human motion count may be maintained for each type of periodic human motion. For example, a separate count may be maintained for walking, running, inline skating, rowing, bicycling, and so on. A total periodic human motion count that includes all periodic human motions may also be maintained.

Other user activity statistics include heart rate, body temperature, breathing rate, distance, speed, altitude change, and so on. These user activity statistics may be correlated to specific user activities. Therefore, a user may find out, for example, the distance run versus the distance walked during a training session, as well as average speed, average running heart rate, average walking heart rate, and so on. A user may also determine, for example, daily activity levels, weekly activity levels, etc., from the user activity statistics. This may provide a user with information useful for athletic training and health.

In one embodiment, electronic device **100** includes one or more feedback elements **160**. Feedback elements **160** may be part of the electronic device **100**, or may be external to the electronic device. Feedback elements **160** may provide one or more of aural feedback (e.g., a buzz, beep, tune, spoken words, etc.), visual feedback (e.g., a blinking or solid light, number display, etc.) and tactile feedback (e.g., a vibration, movement, or slight shock). Feedback may be used, for example, to notify a user to speed up or to slow down, to notify a user that a specified period of time has elapsed, etc. In one embodiment, the type of user feedback, and when to provide user feedback, is user selectable. For example, a user may select to be given a notice to slow down when the user's heart rate exceeds an upper threshold, and to speed up when the user's heart rate falls below a lower threshold. Multiple feedback conditions may be active concurrently. For example, a user may select to receive feedback if a running speed falls below a lower threshold and if a heart rate falls below a lower threshold. Thereby, a user may more accurately control workout intensity.

In one embodiment, user activity statistics **145** are stored in memory **110**. Alternatively, the user activity statistics may be transmitted to an additional electronic device (not shown) such as a server or storage unit. In one embodiment, the memory **110** stores measurement data **150**, which may later be processed by the electronic device **100**, or by an external device such as a server. Alternatively, measurement data **150** may not be stored, or it may be transmitted to an additional electronic device for storage.

In one embodiment, the electronic device **100** includes a wireless protocol **125** and one or more wireless components **125**. The wireless protocol may be Bluetooth, Zigbee, infrared, radiofrequency (RF), personal area network (PAN), or any other wireless communication protocol. Alternatively, the electronic device **100** may include a wired protocol such as firewire, universal serial bus (USB), etc. In one embodiment, the electronic device **100** includes both a wireless protocol **125** and a wired protocol. The wireless and/or wired protocol may enable the electronic device to communicate with additional devices, such as a server, mobile device, personal computer, etc.

In one embodiment, the electronic device **100** includes a display driver **130**. The display driver **130** may control a built in display (not shown) of the electronic device, or an external display (not shown) that may be connected to the electronic device **100**.

In one embodiment, the activity identification engine **115**, motion processor **120**, display driver **130** and wireless protocol **125** are logics executed by a microcontroller **105**, field programmable gate array (FPGA), application specific integrated circuit (ASIC), or other dedicated processing unit. In another embodiment, one or more of the activity identification engine **115**, motion processor **120**, display driver **130** and wireless protocol **125** may be logics executed by a central processing unit. Alternatively, one or more of the activity identification engine **115**, motion processor **120**, display driver **130** and wireless protocol **125** may include a state machine (e.g., an internal logic that knows how to perform a sequence of operations), a logic circuit (e.g., a logic that goes through a sequence of events in time, or a logic whose output changes immediately upon a changed input), or a combination of a state machine and a logic circuit.

FIG. **2** is a block diagram illustrating a motion identification system **200**, in accordance with one embodiment of the present invention. The motion identification system **200** in one embodiment includes a chest strap **205** wirelessly connected to one or more mobile devices **210**, one or more external sensors **220**, one or more external feedback elements **230**, a computing device **215**, and a server **225**. In alternative embodiments, the chest strap **205** may be connected to only some of the mobile devices **210**, external sensors **220**, server **225** and computing device **215**. In one embodiment, the chest strap **205** is not connected to any devices or sensors. In one embodiment, the chest strap **205** includes electronic device **100** of FIG. **1**. In one embodiment, chest strap **205** is a strap worn under or over clothing. Alternatively, chest strap **205** may be attached to a garment. Alternatively, the chest strap **205** may be a garment made of materials incorporating sensors, processors, and/or other components.

Returning to FIG. **2**, the distribution of the functionality between the chest strap **205** and the devices, sensors and server may vary. In one embodiment, all sensor data is processed by the chest strap **205**. The sensor data may be formatted by the chest strap **205** into a generic format understandable by one or more of the mobile devices **210**, server **225** and computing device **215**. Alternatively, the chest strap **205** may transmit unprocessed and/or unformatted data to one or more of the mobile devices **210**, server **225**, and/or computing device **215**. In one embodiment, signals are sent to external feedback elements **230** to provide user feedback, for example, to indicate that user should speed up or slow down.

FIG. **3** illustrates a front view of a user **300** wearing body-mounted system, in accordance with one embodiment of the present invention. In one embodiment, the system is chest strap **205** of FIG. **2**.

Referring to FIG. **3**, user **300** has an axis of symmetry **335** that divides user's **300** body into a right half **325** and a left half **330**. In one embodiment, the chest strap **310** is disposed on the user's **300** chest such that a center of the chest strap **310** approximately lines up with axis of symmetry **335**. Therefore, the chest strap **310** may be equidistant from a right side of the torso **315** and from a left side of the torso **320**. Alternatively, the chest strap **310** may be disposed approximately along the line of symmetry **335** at other locations of user's **300** body, such as at a user's **300** waist or back.

Placement of chest strap **310** along the line of symmetry **335** in one embodiment enables differentiation between accelerations caused by motions from the right half **325** of user's body and left half **330** of user's body. Therefore, chest strap **310** may distinguish between, for example, steps taken by a right leg and steps taken by a left leg. This may assist

users in refining their running technique, or provide an indication that something may be wrong with a user's left or right leg.

In one embodiment, the chest strap **310** is disposed on user's **300** chest at a fixed orientation such that a first axis **370** of the chest strap is approximately aligned to gravity **350** when user **300** is standing. In one embodiment, a second axis **375** of the chest strap extends laterally to user **300** (Medial-Lateral Axis), and a third axis **380** of the chest strap extends front-to-back in relation to user's **300** body (Ventral-Dorsal Axis).

In one embodiment, placement of the chest strap **310** on user's **300** chest enables measurement of the center of mass of user **300**. Such placement reduces random and/or secondary motions caused by, for example, arm movement or head movement. This may enable clean acceleration measurements to be taken along the first axis, which may improve the accuracy of user activity statistics.

In one embodiment, the fixed orientation of the chest strap **310** enables identification of vertical movement, lateral movement, and front-to-back movement. In one embodiment, the fixed orientation of the chest strap **310** further enables first axis **370** to be used for counting periodic human motions without first determining a dominant axis (e.g., an axis aligned closest to gravity). Alternatively, the dominant axis may be determined before or in conjunction with counting periodic human motions. One embodiment of a method for determining a dominant axis may be found in co-pending application U.S. Ser. No. 11/603,472, which is incorporated herein by reference. Other means of determining a dominant axis may be used in other embodiments. A more detailed discussion of determining a dominant axis is discussed below with reference to FIGS. **7-13**.

In one embodiment, the dominant axis may be used to indicate whether a user has properly donned chest strap **310**. For example, the dominant axis may be compared to the first axis **370**, second axis **375** and third axis **380** to determine whether chest strap **310** is properly oriented on user's **300** torso.

A combination of the fixed orientation of the chest strap **310** and the dominant axis may be used to determine user **300** body position. In one embodiment, the chest strap **310** may identify whether a user **300** is prone or upright. In one embodiment, the chest strap **310** can further identify a degree of inclination for the user **300** (e.g., degree to which user **300** is leaning forward or backward).

FIG. **4** illustrates a first exemplary motion-cycle graph **400** that shows a user engaged in a user activity as measured by an accelerometer located in a chest strap. In one embodiment, the chest strap is chest strap **310** of FIG. **3**, and is approximately aligned to axis of symmetry **335** of FIG. **3** in a fixed orientation.

Referring to FIG. **4**, the exemplary motion-cycle graph **400** shows acceleration data taken with a single tri-axis inertial sensor. The acceleration at a given period of time is represented for a vertical axis **470**, a lateral axis **475**, and a ventral-dorsal axis **480**.

In one embodiment, the vertical axis **470** is used to identify steps. In one embodiment, gravity **440** provides a constant acceleration along the positive direction of the vertical axis **470**. Accordingly, any positive acceleration along the vertical axis **470** is acceleration towards the earth, and any negative acceleration along the vertical axis **470** is acceleration away from the earth. Thus, a foot leaving the ground is indicated by a peak (spike) of acceleration along the vertical axis **470**. Such peaks of acceleration are shown for the left foot **405**, **415**, **425** and for the right foot **410**, **420**, **430**. In alternative

embodiments, gravity may provide a permanent acceleration along the negative direction of the vertical axis 470. In such an embodiment, valleys (spikes) along the vertical axis 470 would indicate a foot leaving the ground.

Accelerations along the vertical axis 470 may be used to determine multiple different user activity statistics. In one embodiment, the vertical axis may be used to identify a magnitude of acceleration that each leg experiences. This may be useful, for example, to determine how much strain is placed on each leg during running and/or walking. In one embodiment, points at which vertical acceleration 470 crosses 465 gravity 440 (where the accelerations equal gravity) indicate that a user is in a state of free fall. In one embodiment, a shape of the peak (spike) of acceleration measurements along the vertical axis 470 indicates an elasticity of the surface being walked or run on. For example, a sharp spike indicates a surface with relatively low elasticity (e.g., concrete), while a gradual spike indicates a surface with relatively high elasticity (e.g., a rubber track). Surfaces with a greater elasticity absorb a greater amount of user impact, and are therefore less damaging to a user's body. Other useful data may also be determined from the vertical axis 470.

In one embodiment, lateral axis 475 is used to identify whether a step is being taken by a right foot or by a left foot. In the illustrated embodiment, any negative acceleration along the lateral axis indicates acceleration towards the right, and any positive acceleration along the lateral axis indicates acceleration towards the left. Thus, the lateral axis 475 may identify accelerations caused by the right foot 445 and accelerations caused by the left foot 450. In alternative embodiments, a positive acceleration may indicate acceleration to the right, and a negative acceleration may indicate acceleration to the left.

In one embodiment, additional specifics about a user's gait may be determined based on accelerations along the lateral axis 475, the ventral-dorsal axis 480 and/or the vertical axis 470. For example, the illustrated embodiment shows a greater acceleration along the vertical axis 470 from the left foot than from the right foot. This difference between acceleration peaks 435 along the vertical axis 470 may identify a problem with the right leg (e.g., an injury or potential injury). Other useful information about a user's gait may also be determined, such as an amount of lateral motion accompanying each step, an amount of unnecessary vertical motion with each step, an amount of force exerted by each step, etc.

Though FIG. 4 has been described in the context of identifying steps for walking and running, the techniques described with reference to FIG. 4 may equally be used when counting other periodic human motions associated with other user activities. Examples of such additional user activities include inline skating, swimming, rowing, etc.

FIG. 5 illustrates a flow diagram for a method 500 of monitoring human activity using an inertial sensor, in accordance with one embodiment of the present invention. The method may be performed by processing logic that may comprise hardware (e.g., circuitry, dedicated logic, programmable logic, microcode, etc.), software (such as instructions run on a processing device), or a combination thereof. In one embodiment, method 500 is performed by the electronic device 100 of FIG. 1. In one embodiment, method 500 is performed by the motion identification system 200 of FIG. 2.

Referring to FIG. 5, method 500 begins with monitoring accelerations (block 505). Accelerations may be monitored with an inertial sensor, or other acceleration monitoring device. At block 510, the accelerations are processed to determine user activity statistics. Examples of user activity statistics include number of periodic human motions counted, user

speed, distance traveled, heart rate, and so on. For some user activity statistics such as heart rate, measurements are gathered from additional sensors (e.g., an ECG). At block 515, the user activity statistics are formatted. In one embodiment, the user activity statistics are formatted into a generic format understandable by multiple different computing devices. Examples of a generic format include XML and SGML. In one embodiment, the "generic" format may be selected by the user. In one embodiment, the generic format includes formats such as spreadsheet formats, comma-delimited formats, human readable formats, etc. At block 520, the formatted user activity statistics are transmitted. In one embodiment, the formatted user activity statistics are transmitted to a mobile device such as a mobile phone, personal digital assistant (PDA), laptop computer, wrist watch, etc. Alternatively, the formatted user activity statistics may be transmitted to a server and/or a computing device such as a personal computer.

FIG. 6 illustrates a flow diagram for a method 600 of monitoring human activity using an inertial sensor, in accordance with one embodiment of the present invention. The method may be performed by processing logic that may comprise hardware (e.g., circuitry, dedicated logic, programmable logic, microcode, etc.), software (such as instructions run on a processing device), or a combination thereof. In one embodiment, method 600 is performed by the electronic device 100 of FIG. 1. In one embodiment, method 600 is performed by the motion identification system 200 of FIG. 2.

Referring to FIG. 6, method 600 begins with monitoring accelerations (block 605). Accelerations may be monitored with an inertial sensor, or other acceleration monitoring device. At block 610, the accelerations are processed to determine user activity statistics. At block 615, additional metrics are monitored from one or more additional sensors. Examples of additional sensors include a heat sensor, a pressure sensor, a heart rate sensor, etc. Examples of additional metrics include heart rate, body temperature, altitude, etc.

At block 620, the additional metrics are processed and correlated to the user activity statistics. At block 625, the user activity statistics and the additional metrics are formatted. In one embodiment, the user activity statistics are formatted into a generic format understandable by multiple different computing devices. At block 630, the formatted user activity statistics are transmitted along with the additional metrics. In one embodiment, the formatted user activity statistics and additional metrics are transmitted to a mobile device such as a mobile phone, personal digital assistant (PDA), laptop computer, wrist watch, etc. Alternatively, the formatted user activity statistics may be transmitted to a server and/or a computing device such as a personal computer.

FIGS. 7-13 illustrate embodiments of methods and devices for determining a dominant axis. Referring to FIG. 7, a block diagram illustrating an electronic device 701 is shown in accordance with one embodiment of the present invention. The electronic device 701 comprises a rolling average logic 705, a gravitational influence logic 707, a dominant axis logic 710, a cadence logic 715, a sample period logic 717, and a motion recognition logic 720. In one embodiment, the electronic device 701 is a portable electronic device that includes an accelerometer.

The rolling average logic 705 creates one or more rolling averages of accelerations as measured by an accelerometer over a sample period. In one embodiment, the rolling average logic 705 creates a rolling average of accelerations along a single axis. In another embodiment, the rolling average logic 705 creates rolling averages of accelerations along multiple axes. The length of the sample period over which the rolling

average is taken determines the amount of past acceleration data that is averaged with present acceleration data. In a longer sample period, more past acceleration data is stored.

The rolling average logic **705** can create a simple rolling average and/or an exponential rolling average. In a simple rolling average, all data is treated equally. In an exponential rolling average, the most recent data is given more weight. In one embodiment, the rolling average logic **705** creates a rolling average for each of the axes along which acceleration data is taken.

In one embodiment, the cadence logic **715** detects a period of a cadence of motion based upon user activity, and the sample period logic **717** sets the sample period of the rolling averages based on the period of the cadence of motion. In one embodiment the gravitational influence logic **707** identifies a gravitational influence based upon the rolling averages of accelerations. The dominant axis logic **710** assigns the dominant axis based upon the gravitational influence. The motion recognition logic **720** can use the dominant axis to facilitate motion recognition.

FIGS. **8A** and **8B** illustrate an exemplary first rolling average graph **801** and second rolling average graph **851**, respectively. Both graphs represent time versus acceleration, shown by line **805**. The first rolling average graph **801** shows a first rolling average **807** based on a relatively short sample period. The second rolling average graph **851** shows a second rolling average **855** based on a longer sample period. The length of the sample period determines how sensitive the rolling average is to fluctuations in acceleration. A short sample period as shown in FIG. **8B** will measure brief fluctuations. In a longer sample period, as shown in FIG. **8A**, brief fluctuations are averaged out. Additionally, a rolling average always lags behind the present acceleration, and a longer sample period causes greater lag. Comparing FIGS. **8A** and **8B**, it can be seen that the second rolling average **855** requires more time than the first rolling average **807** to reflect a change in acceleration.

In one embodiment, the sample period is preconfigured. In one embodiment, the size of the sample period is adjusted based on the application(s) using the accelerometer data. In one embodiment, the sample period can be user selected from a list of options. In one embodiment, the sample period can be determined by the cadence logic **705** and the sample period logic **717**.

In one embodiment, two or more rolling averages of accelerations are tracked concurrently. The two or more rolling averages can be rolling averages along the same or different axes. In one embodiment, two or more rolling averages are tracked concurrently for each of the axes. Concurrent tracking of rolling averages can be beneficial where a user is performing two actions at the same time, each of which requires a different level of sensitivity for acceleration measurements. For example, the use of different sample periods for two rolling averages can be useful where the electronic device **701** is simultaneously counting steps and tracking motions of a user as called for by a motion sensitive game. In such an example, the motion sensitive game might require a very short sample period to measure quick motions, while the step counter might require a longer sample period so as to register only the user's steps.

Returning to FIG. **7**, in one embodiment the cadence logic **715** detects a period of a cadence of motion based upon user activity (e.g. rollerblading, biking, running, walking, etc). Many types of motions that are useful to keep track of have a periodic set of movements. Specific periodic human motions may be characteristic of different types of user activity. For example, to walk, an individual must lift a first leg, move it

forward, plant it, then repeat the same series of motions with a second leg. In contrast, a person rollerblading performs a repeated sequence of pushing, coasting, and lift-off for each leg. For a particular individual, the series of walking motions will usually occur in the same amount of time, and the series of rollerblading motions will usually occur in about the same amount of time. The repeated set of motions defines the cadence of the motion, while the amount of time over which the series of motions occurs defines the period of the cadence of the motion. For simplicity, the term "step" is used in the following description to describe the user activity being evaluated. However, in the context of this application, the term "step" should be taken to mean any user activity having a periodic set of movements.

FIG. **9** illustrates a cadence of motion graph **901** that measures time versus acceleration. The acceleration at a given period of time is represented for a first axis **903**, a second axis **905**, and a third axis **907**. In one embodiment, a cadence logic analyzes the acceleration along the first axis **903**, second axis **905** and third axis **907** to detect a pattern. Once a pattern is detected, a period of the pattern is determined. This period corresponds to the period of the cadence of motion. FIG. **9** shows a period of a cadence of motion **910** for the third axis **907**. The same period can also be seen to a lesser degree in the second axis **905** and the first axis **903**.

In one embodiment, periods can be determined for multiple cadences of motion. For example, if a user simultaneously walks and tosses a ball in the air, in one embodiment the system can detect a period of the cadence of tossing the ball, and a period of the cadence of walking.

Returning back to FIG. **7**, once the period of a cadence of motion is detected, the sample period logic **717** can set the sample period of the rolling average based upon the period of the cadence of motion. In one embodiment, the sample period is set such that it is approximately the length of the period of the cadence of motion. Alternatively, the sample period can be set so that it exceeds the length of the period of the cadence of motion. In one embodiment, the sample period is set such that it is a multiple of the period of the cadence of motion.

In one embodiment, the gravitational influence logic **707** identifies a gravitational influence based upon the rolling average or averages of accelerations. An accelerometer measures both dynamic accelerations, caused by user movement, and static acceleration, caused by gravity. This static acceleration is measured by an accelerometer as a constant acceleration that is equal and opposite to the force of gravity. Over a period of a cadence of motion, the dynamic acceleration caused by user activity tends to average towards zero, which leaves primarily the static acceleration. The axis with the largest absolute rolling average is the axis most influenced by gravity.

The axis that is most influenced by gravity can change over time. For example, as an electronic device **701** is rotated, the influence of gravity will change for at least two axes in a three axis accelerometer. At some point in the rotation, the axis that experiences the most gravitational influence will change. This change is shown in FIGS. **10A** and **10B**.

FIG. **10A** illustrates a first gravitational influence graph **1001** for a data set over a rolling average sample period of 2.5 seconds. Accelerations are shown along an x-axis **1005**, a y-axis **1007**, and a z-axis **1009**. In FIG. **10A**, a device being measured is rotated about the z-axis over time. At time T=0, the y-axis **1007** has the largest absolute acceleration value at over -400, while at time T=111 the x-axis has the largest absolute acceleration value at -300.

In FIG. **10A**, a first x-axis rolling average **1012**, a first y-axis rolling average **1020** and a first z-axis rolling average

1010 are shown. The axis with the largest absolute rolling average is the axis that is most influenced by gravity at a given time. As rotation occurs, the rolling averages change to reflect a change in the gravitational influence on the device. Initially, the x-axis 1005 is most influenced by gravity. At the first point of intersection 1022 of the first x-axis rolling average 1012 and the first y-axis rolling average 1020, the y-axis 1007 becomes the axis most influenced by gravity. However, the axis that experiences the greatest gravitational influence changes at a time after the rotation has actually occurred. This is due to a lag caused by the 2.5 second sample period. To reduce this lag, the sample period can be reduced.

FIG. 10B illustrates a second gravitational influence graph 1051 for the same data set as shown in FIG. 10A over a rolling average sample period of 1 second. FIG. 10B shows a second x-axis rolling average 1060, a second y-axis rolling average 1063 and a second z-axis rolling average 1066. As shown, a second point of intersection 1070 occurs between the second x-axis rolling average 1060 and second y-axis rolling average 1063 much earlier in time than the first point of intersection 1022. The earlier point of intersection more accurately reflects the time when rotation actually occurs. As shown by FIGS. 10A and 10B, a change in the length of the sample period for the rolling average can greatly affect the sensitivity of the device to changes in orientation.

In one embodiment, the gravitational influence logic 707 calculates the total gravity caused acceleration based upon the acceleration on each axis. The gravitational influence logic 707 in one embodiment then assigns a percentage of the total acceleration to each axis. From the percentage of total acceleration on the axes the gravitational influence logic 707 then calculates the approximate device orientation.

Referring back to FIG. 7, the dominant axis logic 710 assigns a dominant axis based upon the gravitational influence. In one embodiment, the actual axis with the largest absolute rolling average over the sample period is assigned as the dominant axis. In this embodiment, the dominant axis therefore corresponds to the axis having the largest absolute rolling average at a given time. In an alternative embodiment, the dominant axis does not correspond to one of the actual axes of the accelerometer in its current orientation, but rather to an axis that is defined as aligned to gravity.

FIG. 11 illustrates a plan view 1100 of an exemplary dominant axis 1102 that does not correspond to one of the actual axes 1104 of an accelerometer. The dominant axis 1102, as shown in FIG. 11, can be a component of the x axis, y axis, and/or z axis, and is approximately aligned with gravity 1106. In one embodiment, the dominant axis 1102 corresponds to a virtual axis that is a component of a virtual coordinate system. The relationship between the virtual coordinate system and the actual coordinate system can be determined by performing a coordinate transformation. In one embodiment, the virtual coordinate system is a virtual Cartesian coordinate system, in which the dominant axis is one of a virtual x-axis, y-axis or z-axis. In alternative embodiments, the dominant axis 1102 is a virtual axis of, for example, a polar coordinate system.

In one embodiment, the dominant axis logic 710 assigns the dominant axis by performing a true gravity assessment. A true gravity assessment may be performed by doing trigonometric calculations on the actual axes based on the gravitational influence. For example, the arcsine function can determine the exact angle between the actual axes and the gravitational influence. True gravity assessments can exactly align the dominant axis with the gravitational influence, but can be resource expensive.

In one embodiment, the dominant axis logic 710 assigns the dominant axis by comparing the gravitational influence to a lookup table. A lookup table provides greater accuracy than assigning the dominant axis to the axis that has the largest acceleration, and is less resource expensive than calculating the exact gravitational influence on each axis. A lookup table divides accelerations into known limits that define a probability range in which gravity is acting.

FIG. 12 illustrates an exemplary probability range 1200 represented by a plurality of projections, each of the projections corresponding to an entry on a lookup table. In the illustrated embodiment, the area of space swept by the projections defines a cone. In alternative embodiments, the area of space swept by the projections defines other shapes. The lookup table that corresponds to the exemplary probability range 1200 has six entries, each of which corresponds to a projection having an included angle between opposite sides of ninety degrees. For example, if the gravitational influence acts within the first projection 1203, then the table entry that corresponds to that projection is assigned as the dominant axis. The same applies to the second projection 1205, and the other projections (not illustrated). As shown, the dominant axis is assigned to the table entry corresponding to the second projection 1205 because it is aligned with and in the direction of the force of gravity 1207. In alternative embodiments, the dominant axis is assigned to the table entry corresponding to the projection that is aligned with and in the opposite direction of the force of gravity 1207.

Returning to FIG. 7, in one embodiment, the motion recognition logic 120 detects gestures and/or steps by utilizing data regarding the dominant axis. In one embodiment, certain gestures and/or steps are detected by utilizing the acceleration along only the dominant axis. In other embodiments, acceleration along other axes may also be used and/or acceleration along only the non-dominant axes may be used. In one embodiment, the dominant axis assignment is used to determine whether a step and/or gesture recognition cycle should be started. In one embodiment, certain gestures may only be detected when the dominant axis corresponds to a particular axis when the gesture is started. After the certain gestures have begun, assignment of the dominant axis may be unimportant to continue the gesture recognition.

FIG. 13 shows a processing diagram 1300 for a method of determining an orientation of an accelerometer, in accordance with one embodiment of the present invention. In one embodiment, determining an orientation of the accelerometer determines an orientation of a device that includes the accelerometer.

At processing block 1302, one or more rolling averages of accelerations are created over a sample period. The rolling averages can be simple rolling averages or weighted rolling averages such as exponential rolling averages. In an exponential rolling average, recent data is weighed more heavily relative to old data. The weighting applied to the most recent price depends on the specified period of the rolling average. The shorter the period, the more weight that will be applied to the most recent measurement. This can cause the rolling average to react more quickly to changing conditions.

The sample period over which the rolling averages are created can be pre-configured, adjusted based upon applications being used, user selected, or determined dynamically. In one embodiment, two or more rolling averages of accelerations are created concurrently along the same axes. The concurrent rolling averages can have different sample periods.

In one embodiment, if the sample period over which creation of the rolling averages of accelerations is determined dynamically, a period of a cadence of motion is detected at

processing block **1308**. Subsequently, a sample period is set at processing block **1310** based upon the period of the cadence of motion. In one embodiment, the sample period is set such that it has at least the period of the cadence of motion. In one embodiment, the sample period is set to a multiple of the period of the cadence of motion. In one embodiment, periods can be determined for multiple cadences of motions at processing block **1308**, and sample periods can be set for each determined cadence of motion. This embodiment facilitates the concurrent creation of two or more rolling averages of accelerations over different sample periods.

In one embodiment, the orientation of the accelerometer is determined based upon the rolling average or averages of accelerations. In one embodiment, determining the orientation of the accelerometer further includes identifying a gravitational influence based on the rolling averages of accelerations and determining the orientation, compared to the X-Y-Z axes of the accelerometer.

At processing block **1304**, a gravitational influence is identified based upon the rolling average of accelerations. In one embodiment, the gravitational influence is identified by calculating the total acceleration based upon the acceleration on each axis. In such an embodiment, a percentage of the total acceleration can then be assigned to each axis and an approximate device orientation can be determined. At processing block **1306**, a dominant axis is assigned based upon the gravitational influence.

The present invention may be performed by hardware components or may be embodied in machine-executable instructions, which may be used to cause a general-purpose or special-purpose processor programmed with the instructions to perform the method described above. Alternatively, the method may be performed by a combination of hardware and software.

The present invention may be provided as a computer program product, or software, that may include a machine-readable medium having stored thereon instructions, which may be used to program a computer system (or other electronic devices) to perform a process according to the present invention. The machine-readable medium may include, but is not limited to, floppy diskettes, optical disks, CD-ROMs, and magneto-optical disks, ROMs, RAMs, EPROMs, EEPROMs, magnetic or optical cards, flash memory, or other type of media or machine-readable mediums suitable for storing electronic instructions.

In the foregoing description, numerous specific details have been set forth such as examples of specific systems, languages, components, etc. in order to provide a thorough understanding of the present invention. It will be apparent, however, to one skilled in the art that these specific details need not be employed to practice the present invention. In other instances, well known materials or methods have not been described in detail in order to avoid unnecessarily obscuring the present invention.

In the foregoing specification, the invention has been described with reference to specific exemplary embodiments thereof. It will, however, be evident that various modifications and changes may be made thereto without departing from the broader spirit and scope of the invention as set forth in the appended claims. The specification and drawings are, accordingly, to be regarded in an illustrative rather than a restrictive sense.

What is claimed is:

1. A method comprising:
  - generating acceleration measurements by an inertial sensor that is integrated into a garment made of materials that incorporate one or more sensors and provide body coverage;
  - storing the acceleration measurements in a memory that is integrated into the garment;
  - periodically establishing a connection to an electronic device for communication, the electronic device remote from the garment into which the inertial sensor is integrated;
  - transmitting a formatted version the acceleration measurements to the electronic device via the connection, the electronic device used to identify a current user activity and a current user activity level; and
  - assigning a dominant axis to the inertial sensor, the dominant axis an axis most influenced by gravity, by creating a rolling average of accelerations for each of the plurality of axes, comparing a value of the rolling average of accelerations for a first axis to values of the rolling averages of accelerations for one or more additional axes of the plurality of axes, and based upon relative values of the rolling averages of accelerations assigning the dominant axis.
2. The method of claim 1, further comprising:
  - processing the acceleration measurements by the electronic device to identify the current user activity, from among a plurality of activities; and
  - processing the acceleration measurements to detect periodic human motions associated with the identified user activity, such that a separate motion count is maintained for each of the plurality of types of periodic human motions.
3. The method of claim 2, further comprising:
  - processing the acceleration measurements to determine user activity statistics associated with the identified user activity, wherein the user activity statistics include at least one of a count of periodic human motions, a total distance traveled, a vertical distance traveled, a current speed, an average speed, calories burned, and a user orientation to gravity.
4. The method of claim 1, further comprising:
  - formatting the acceleration measurements to a generic markup language format understandable by a plurality of devices before transmitting the acceleration measurements to the electronic device.
5. The method of claim 1, further comprising:
  - generating measurement data by one or more additional sensors that are integrated into the garment;
  - storing the measurement data in the memory; and
  - transmitting the measurement data to the electronic device via the connection.
6. The method of claim 5, wherein the one or more additional sensors include at least one of a heart rate sensor, a pressure sensor, a moisture sensor, a capacitance sensor, a sound sensor and a heat sensor.
7. The method of claim 1, further comprising:
  - receiving a user feedback signal from the electronic device by the garment; and
  - providing user feedback to a wearer of the garment by a feedback mechanism integrated into the garment based on the user feedback signal, wherein the user feedback includes at least one of aural, visual, and tactile feedback.

15

8. The method of claim 1, wherein the acceleration measurements are transmitted to the electronic device as the acceleration measurements are generated.

9. A garment comprising:  
 a garment portion to cover a portion of a user's body made of materials that incorporate one or more sensors;  
 a computing portion that is one of: embedded in, attached to, integral with, or a part of the garment portion;  
 the computing portion including:  
 an inertial sensor to generate acceleration measurements;  
 a memory to store the acceleration measurements; and  
 a transmitter to periodically transmit at least one of the acceleration measurements or formatted data based on the acceleration measurements to an electronic device, the electronic device remote from the garment, the electronic device used to calculate a user activity based on the formatted data;

wherein the inertial sensor is assigned a dominant axis, the dominant axis an axis most influenced by gravity, by creating a rolling average of accelerations for each of the plurality of axes, comparing a value of the rolling average of accelerations for a first axis to values of the rolling averages of accelerations for one or more additional axes of the plurality of axes, and based upon relative values of the rolling averages of accelerations assigning the dominant axis.

10. The garment of claim 9, wherein the computing portion further comprises a processor to process the acceleration measurements to identify a user activity and to detect periodic human motion associated with the identified user activity.

11. The garment of claim 10, further comprising:  
 the processor to determine user activity statistics associated with the user activity, wherein the user activity statistics include at least one of a count of periodic human motions, a total distance traveled, a vertical distance traveled, a current speed, an average speed, calories burned, and a user orientation to gravity.

12. The garment of claim 11, further comprising:  
 the processor to format the user activity statistics to a generic format readable by a plurality of devices; and  
 the transmitter to transmit the formatted user activity statistics to the electronic device.

13. The garment of claim 9, the computing portion further comprising:  
 one or more additional sensors to make additional measurements;

the memory to store the additional measurements; and  
 the transmitter to transmit at least one of the additional sensor measurements or additional formatted data based on the additional measurements.

14. The garment of claim 9, the computing portion further comprising:

a feedback mechanism to provide user feedback to a wearer of the garment based on at least one of the formatted data or a feedback signal received from the electronic device, wherein the feedback mechanism provides at least one of aural, visual and tactile feedback.

16

15. The garment of claim 10, wherein the computing portion further determines an orientation of the garment with respect to gravity and an axis aligned closest to gravity, such that measurements along the axis are utilized to identify the user activity.

16. An inertial sensor based device comprising:  
 a garment portion to be worn on a user's torso, the garment portion made of a fabric, the garment portion made of materials that incorporate one or more sensors;

an inertial sensor integral with the garment portion to monitor accelerations along a plurality of axes, the inertial sensor incorporated into the fabric of the garment portion, the inertial sensor having an assigned dominant axis, the dominant axis an axis most influenced by gravity, by creating a rolling average of accelerations for each of the plurality of axes, comparing a value of the rolling average of accelerations for a first axis to values of the rolling averages of accelerations for one or more additional axes of the plurality of axes, and based upon relative values of the rolling averages of accelerations assigning the dominant axis;

a processor integral with the garment portion and coupled to the inertial sensor to process the accelerations to determine one or more user activity statistics;

a transmitter integral with the garment portion to periodically transmit formatted user activity statistics in a generic format from the garment portion to a remote electronic device, the remote electronic device providing a display to enable a user to view the user activity statistics.

17. The inertial sensor based device of claim 16, wherein integral with the garment comprises being: embedded in, attached to, or a part of the garment portion.

18. The inertial sensor based device of claim 16, further comprising:

a feedback mechanism to provide feedback to a wearer of the garment based on at least one of aural, visual, and tactile feedback.

19. The inertial sensor based device of claim 16, further comprising:

the processor to process the acceleration measurements to determine user activity statistics associated with the identified user activity, wherein the user activity statistics include at least one of a count of periodic human motions, a total distance traveled, a vertical distance traveled, a current speed, an average speed, calories burned, and a user orientation to gravity.

20. The inertial sensor based device of claim 16, further comprising:

the processor to determine user activity statistics associated with the user activity, wherein the user activity statistics include at least one of a count of periodic human motions, a total distance traveled, a vertical distance traveled, a current speed, an average speed, calories burned, and a user orientation to gravity.

\* \* \* \* \*

专利名称(译)	人体活动监测装置		
公开(公告)号	<a href="#">US8876738</a>	公开(公告)日	2014-11-04
申请号	US12/834845	申请日	2010-07-12
[标]申请(专利权)人(译)	KAHN PHILIPPE KINSOLVING ARTHUR CHRISTENSEN MARK ANDREW LEE BRIAN Y VOGEL DAVID		
申请(专利权)人(译)	卡恩PHILIPPE KINSOLVING , ARTHUR 克里斯滕森MARK ANDREW LEE , BRIAN Y. VOGEL , DAVID		
当前申请(专利权)人(译)	DP TECHNOLOGIES , INC.		
[标]发明人	KAHN PHILIPPE KINSOLVING ARTHUR CHRISTENSEN MARK ANDREW LEE BRIAN Y VOGEL DAVID		
发明人	KAHN, PHILIPPE KINSOLVING, ARTHUR CHRISTENSEN, MARK ANDREW LEE, BRIAN Y. VOGEL, DAVID		
IPC分类号	A61B5/103 A61B5/00 A61B5/117 A63B71/00		
CPC分类号	A61B2562/0219 A61B5/1118 A61B5/6831 A61B5/1123		
外部链接	<a href="#">Espacenet</a> <a href="#">USPTO</a>		

**摘要(译)**  
一种使用惯性传感器监测人类活动的方法包括监测来自集成到服装中的惯性传感器的加速度。处理加速度以确定一个或多个加速度统计，并发送加速度统计。

