



(19) **United States**

(12) **Patent Application Publication**

(10) **Pub. No.: US 2004/0082841 A1**

**Furnary et al.**

(43) **Pub. Date:**

**Apr. 29, 2004**

(54) **METHOD AND APPARATUS FOR MONITORING BLOOD CONDITION AND CARDIOPULMONARY FUNCTION**

**Publication Classification**

(51) **Int. Cl.<sup>7</sup>** ..... **A61B 5/00**  
(52) **U.S. Cl.** ..... **600/325**

(76) **Inventors:** **Anthony P. Furnary**, Portland, OR (US); **Robert I. Lowe**, Portland, OR (US)

(57) **ABSTRACT**

Correspondence Address:  
**CHERNOFF, VILHAUER, MCCLUNG & STENZEL**  
**1600 ODS TOWER**  
**601 SW SECOND AVENUE**  
**PORTLAND, OR 97204-3157 (US)**

Sensors located on a sensor carrier are placed adjacent one or more of a surgical patient's major thoracic blood-containing structures such as the aorta or pulmonary artery, and characteristics of blood in the blood-containing structures are determined noninvasively by measuring transmission or reflection of light or other types of energy by the blood. Emitters and receptors included in the sensors are connected electrically with suitable electronic signal generating and processing components in a package remote from the sensor carrier.

(21) **Appl. No.:** **10/280,970**

(22) **Filed:** **Oct. 24, 2002**

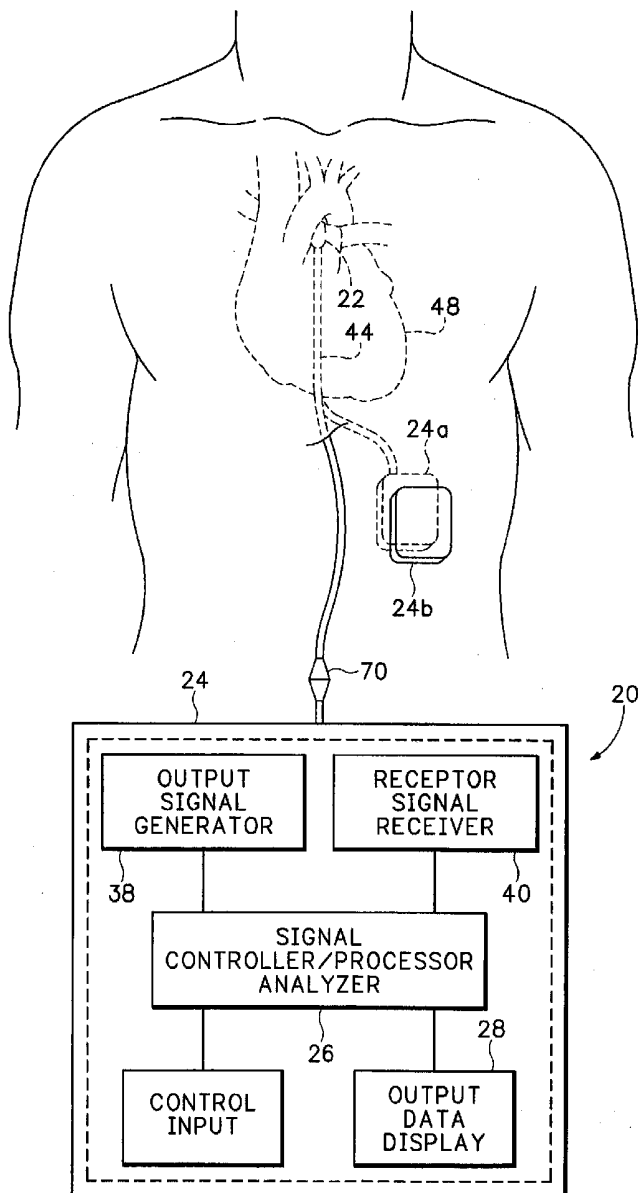

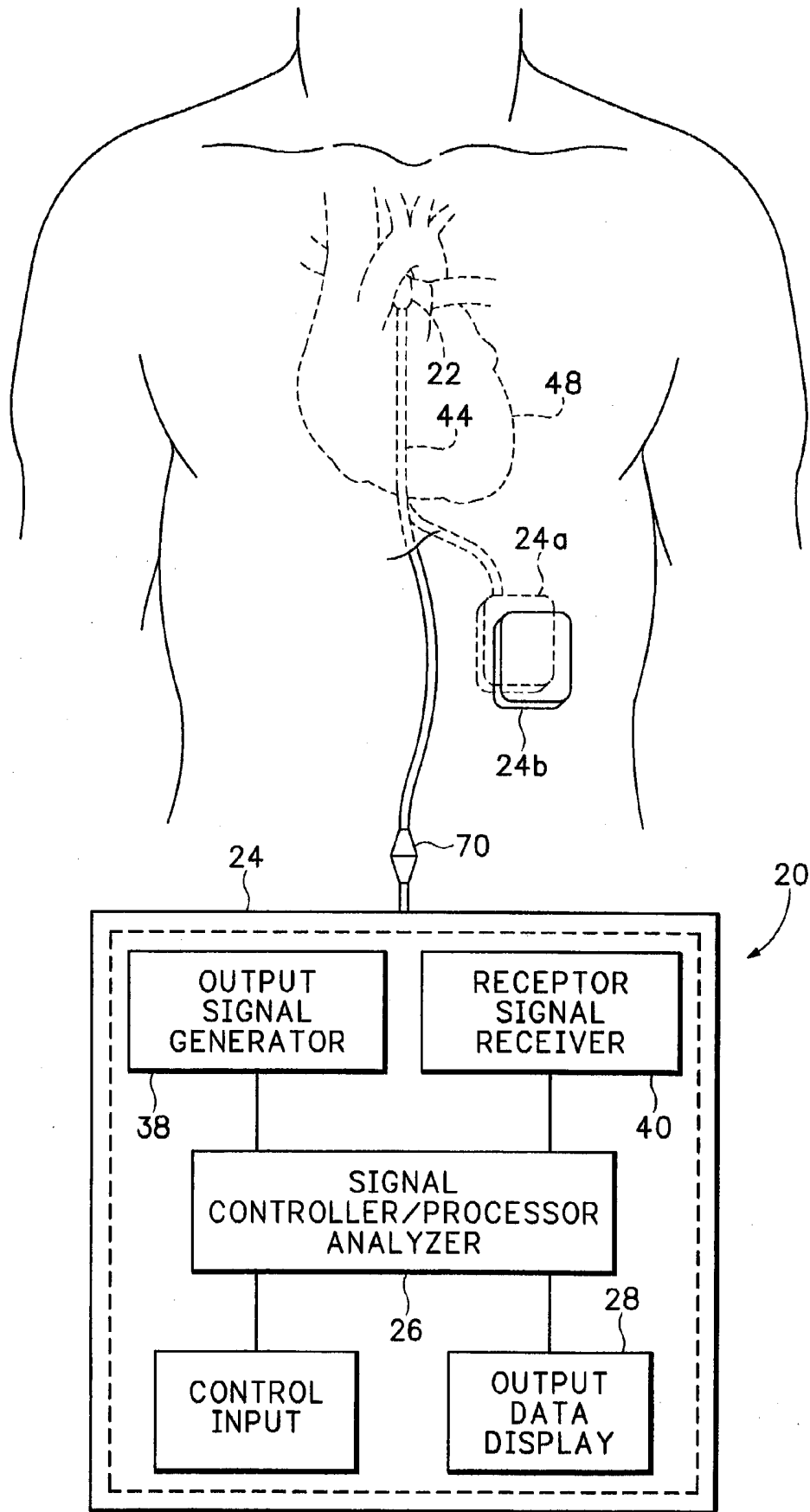
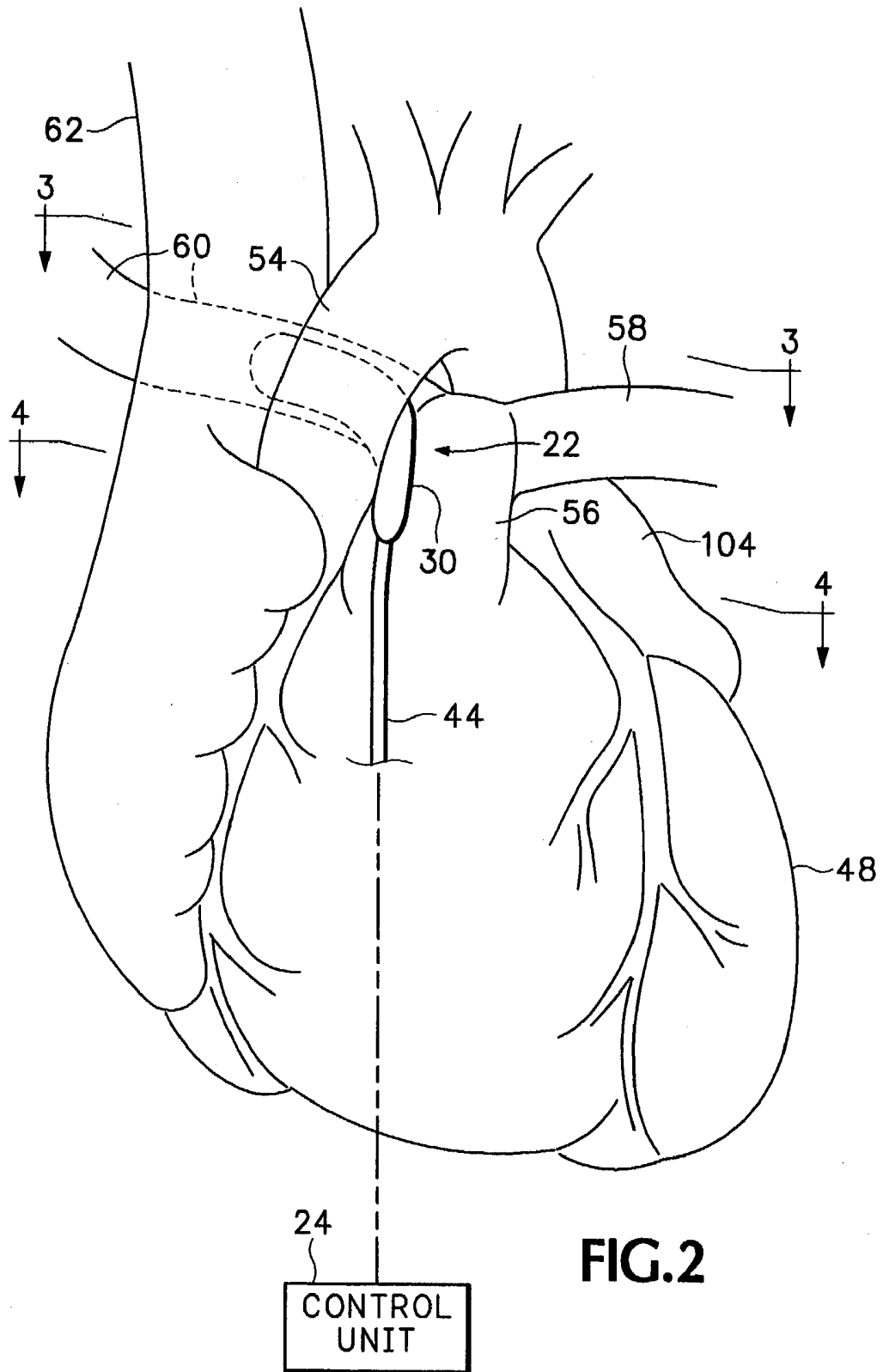
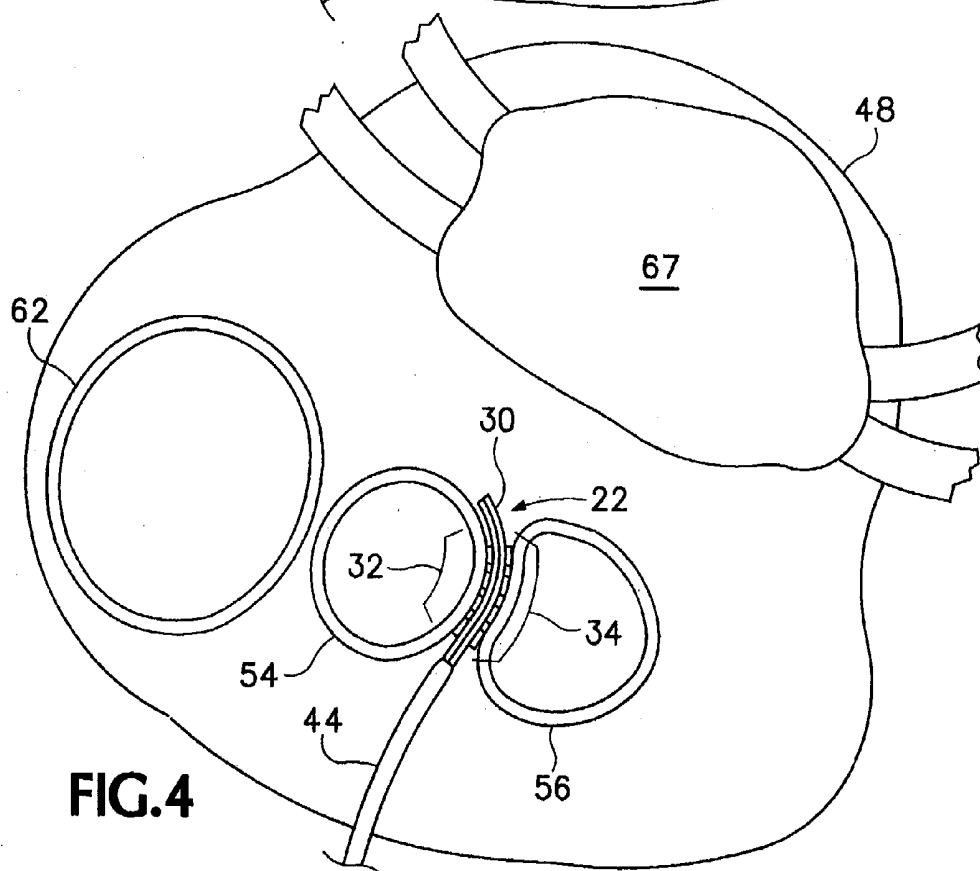
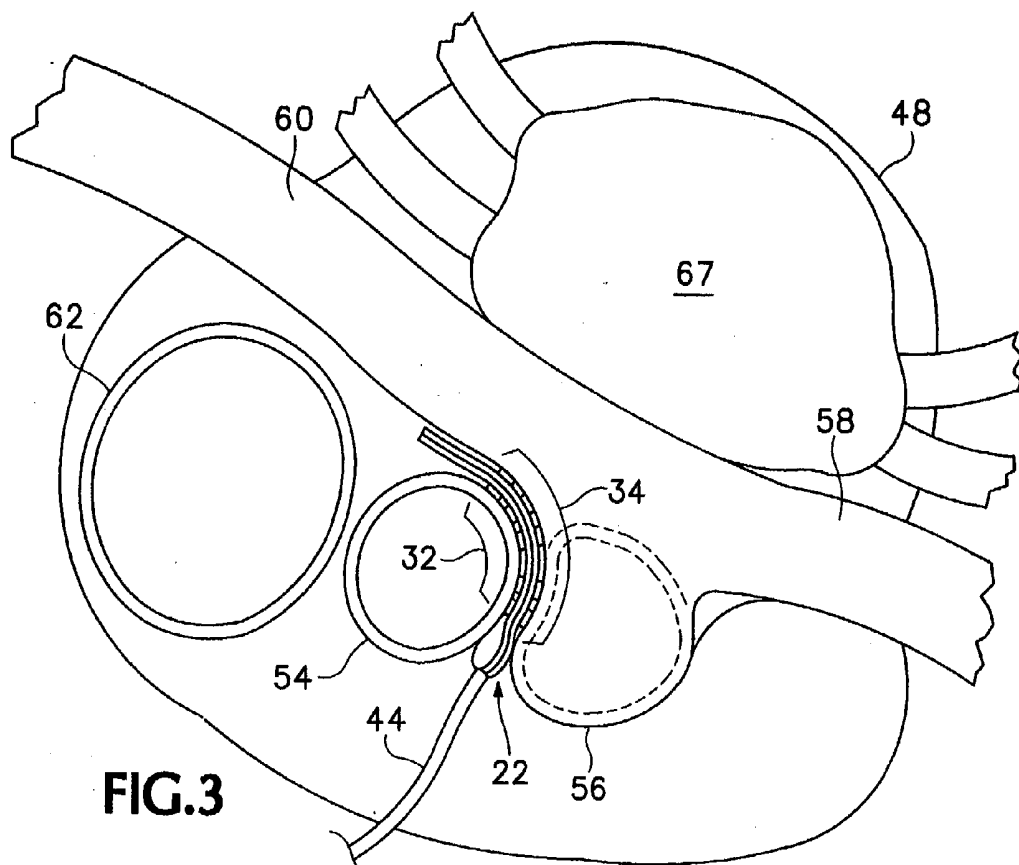
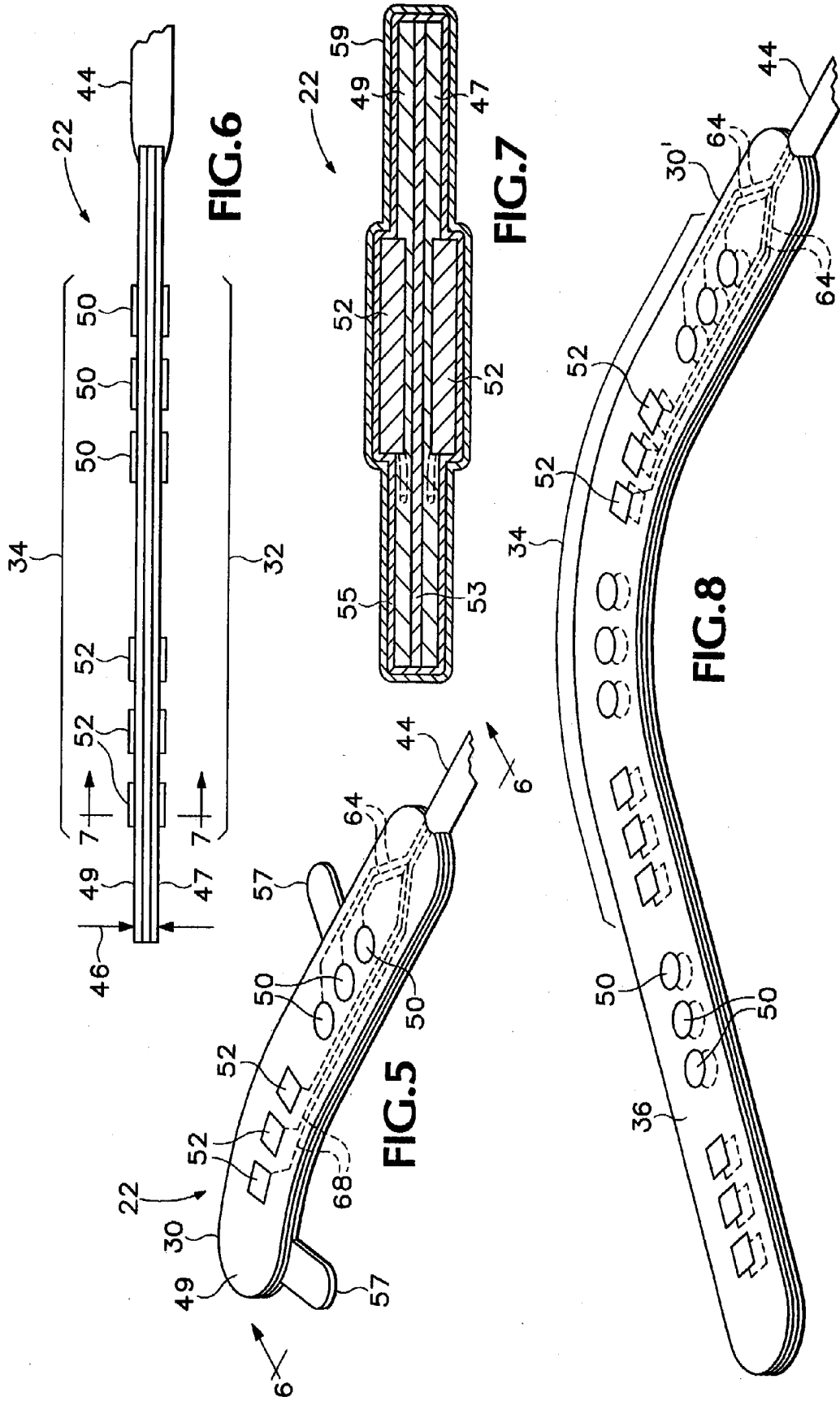
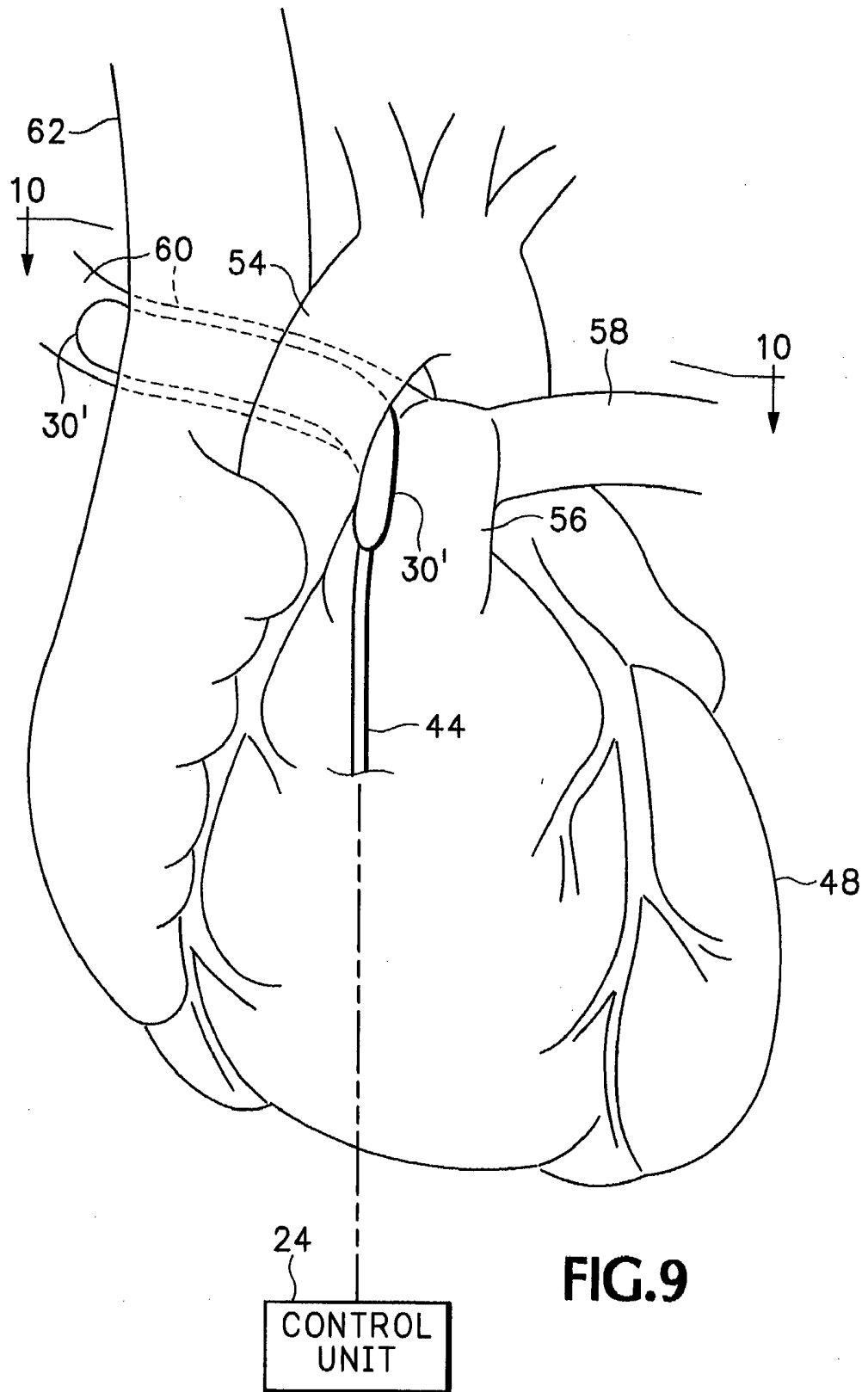

FIG.1

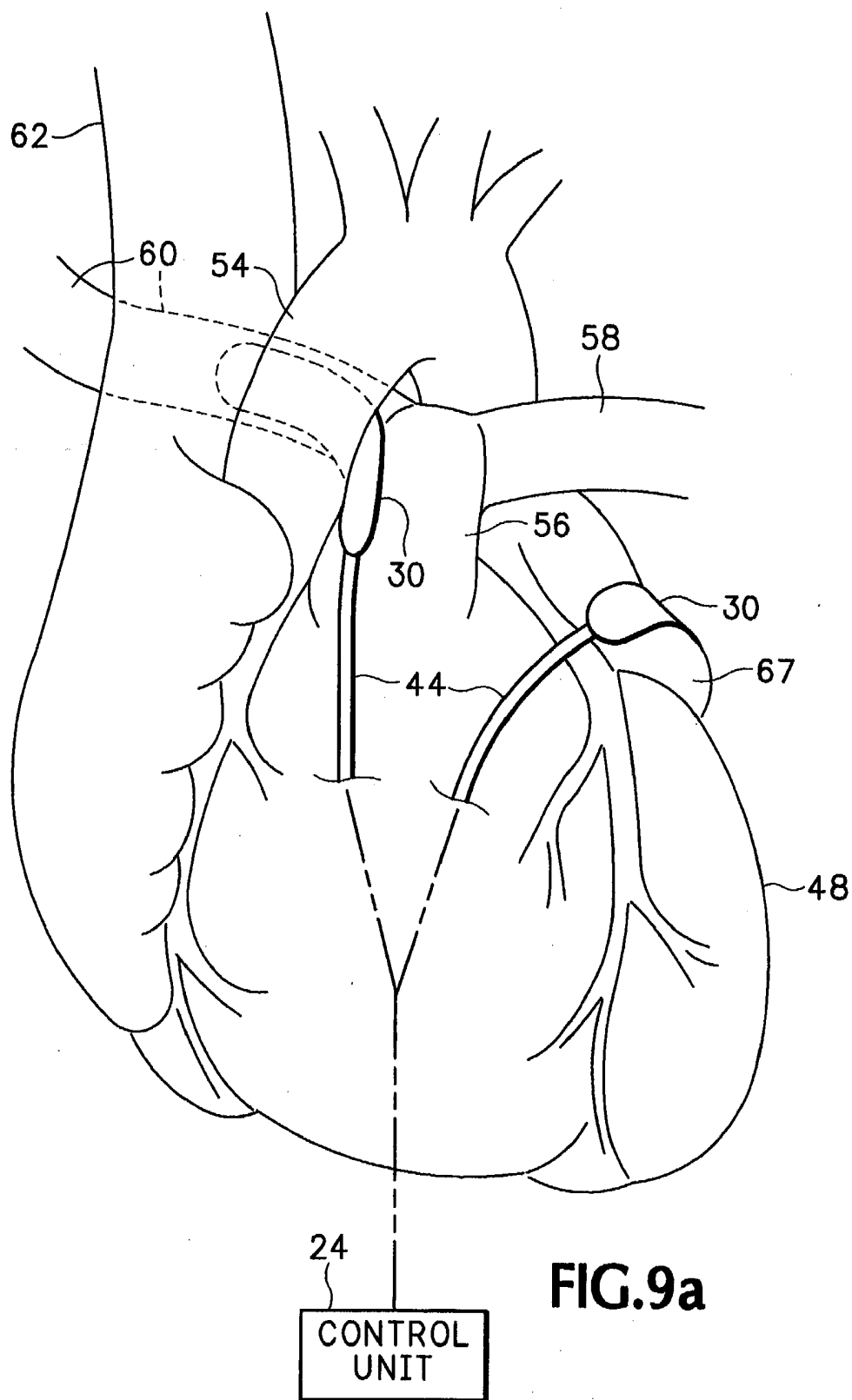

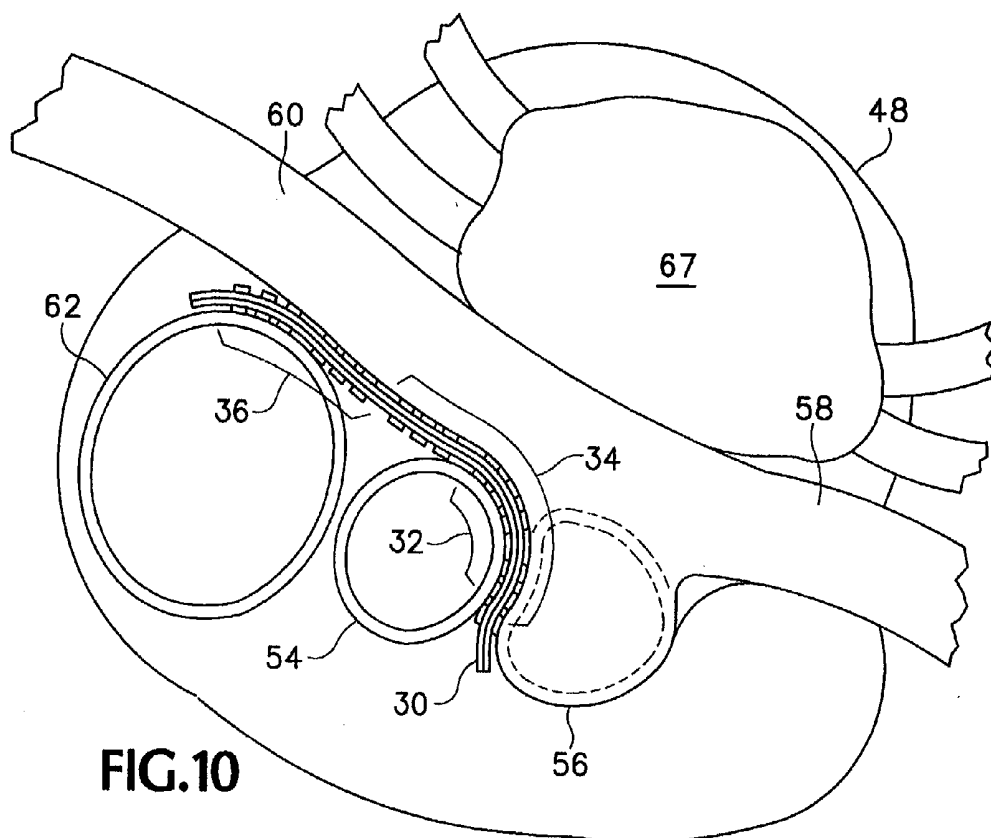



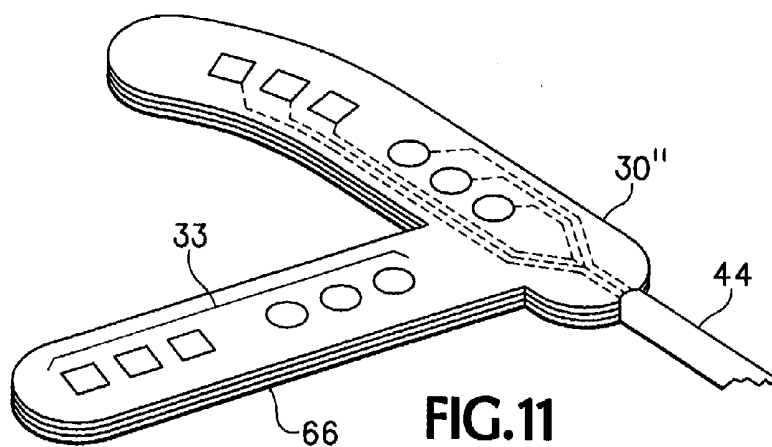

**FIG.9**

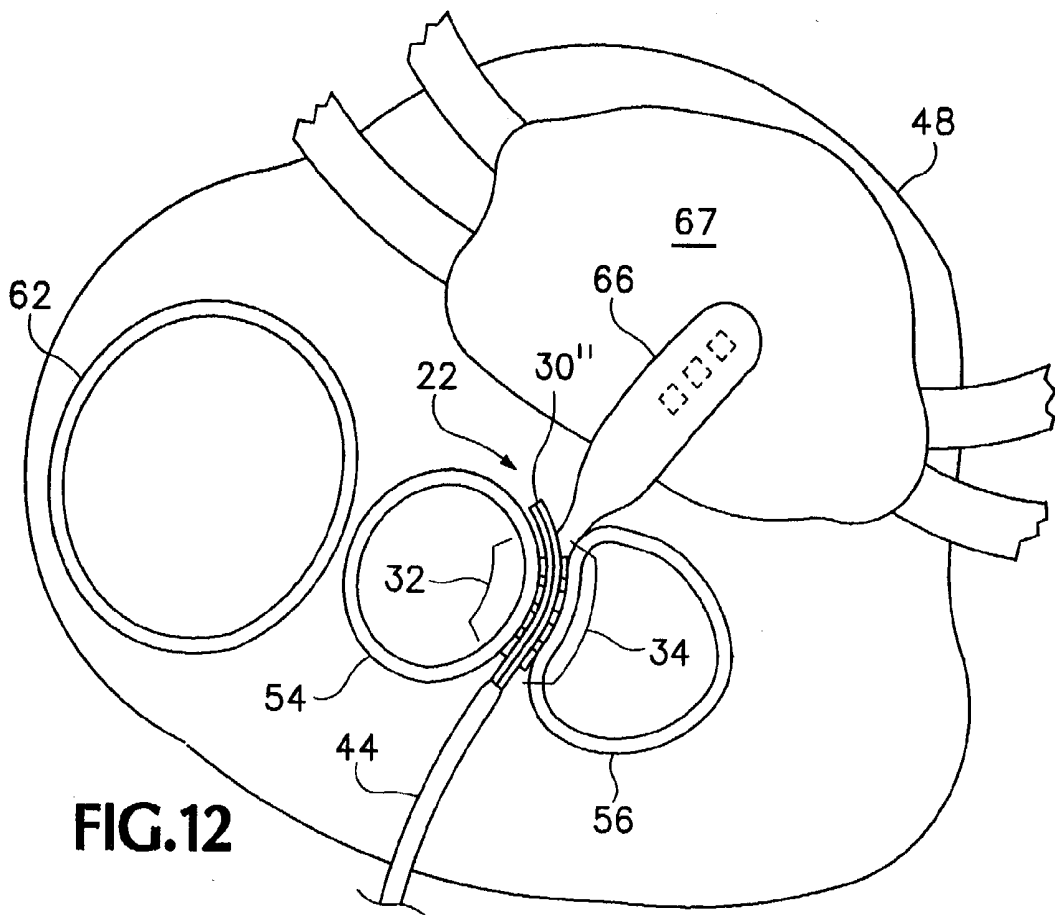

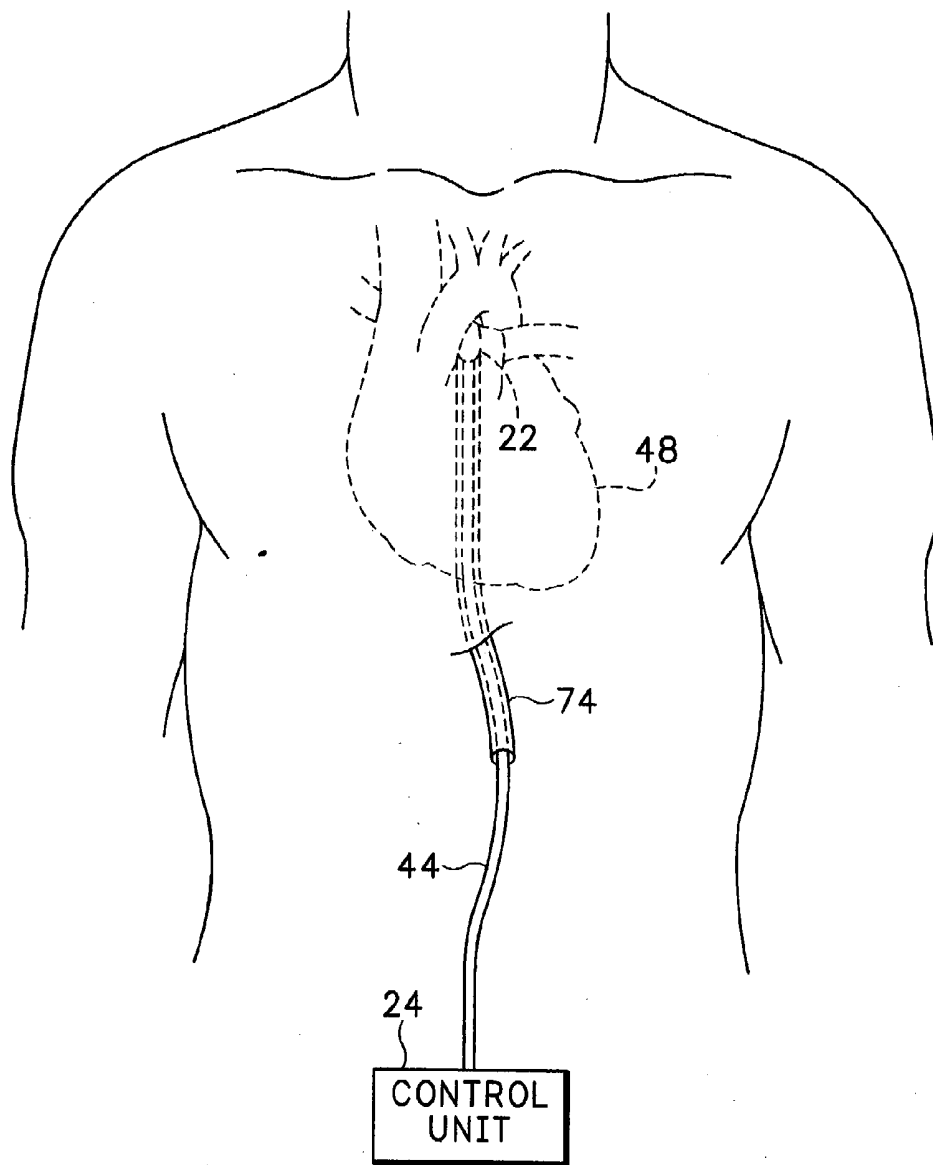

**FIG.10**



**FIG.11**





**FIG.13**

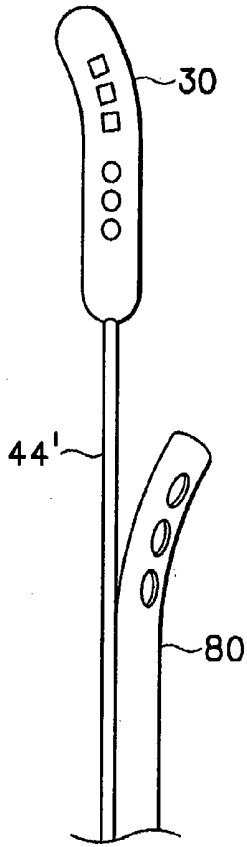

FIG. 14

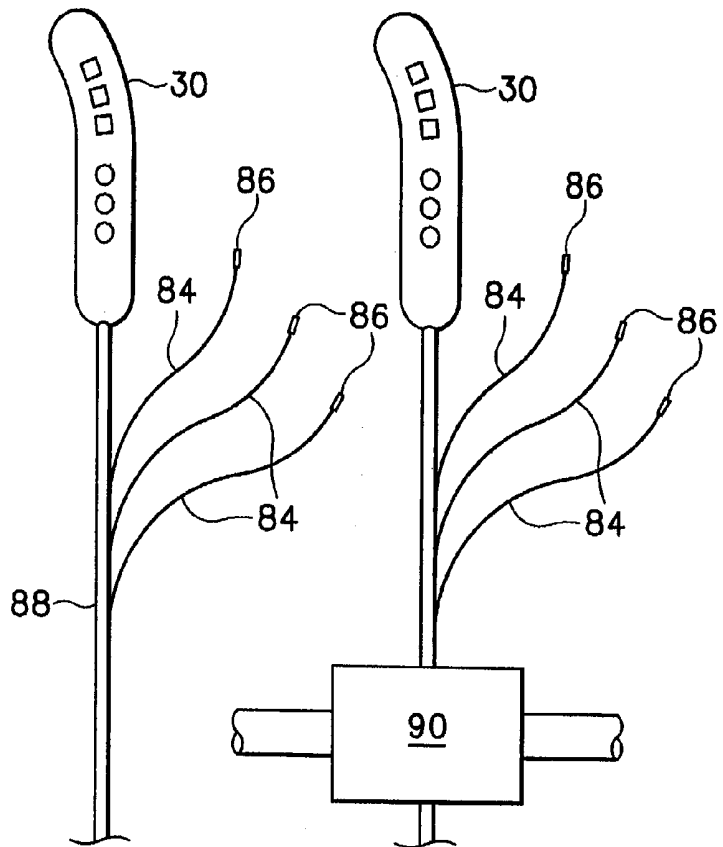

FIG. 15

FIG. 16

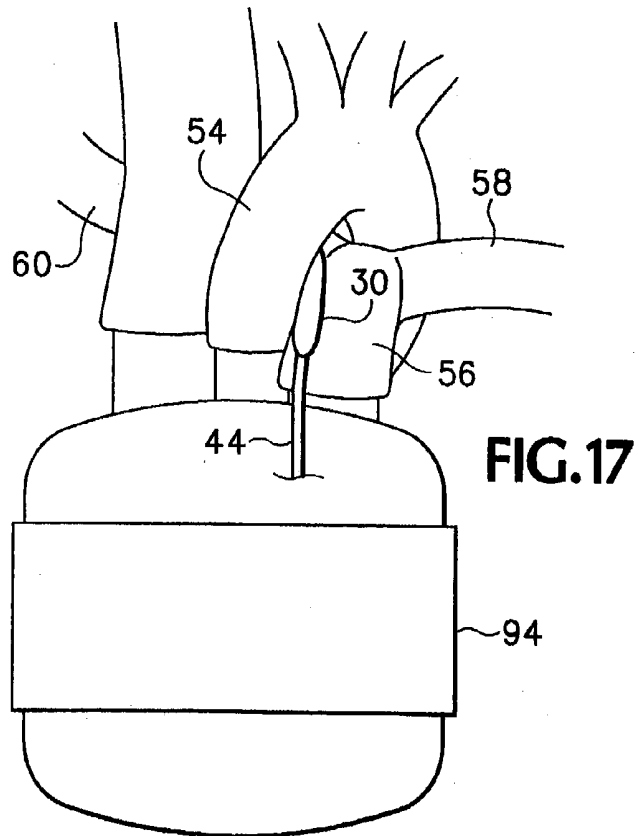

FIG. 17

## METHOD AND APPARATUS FOR MONITORING BLOOD CONDITION AND CARDIOPULMONARY FUNCTION

### BACKGROUND OF THE INVENTION

[0001] The present invention relates to monitoring a patient's cardiopulmonary function and blood condition, and particularly to a method and apparatus for monitoring the performance of a patient's heart and lungs during and following thoracic surgery.

[0002] Cardiac output means the volume rate at which the heart pumps blood. The cardiac output is important to a clinician as an indication of how well a person's heart is able to function. Using conventional techniques and available apparatus it is difficult and costly to evaluate a patient's cardiac output and respiratory efficiency, and the process cannot be performed as quickly as desirable. Following surgery, and particularly heart surgery, it would be advantageous to be able to determine quickly and frequently how well a patient's heart and lungs are performing in delivering oxygenated blood to the patient's tissues in relation to how quickly the same tissues are removing the oxygen with which they are being supplied.

[0003] To accurately determine the efficiency of the heart and lungs relative to the body's need for oxygen it is advantageous to analyze the percentage of oxygen saturation of hemoglobin (hereinafter simply called oxygen saturation) in mixed venous blood, as found in the pulmonary artery. It is also advantageous, and even more accurate in assessing a person's cardiac function, to compare the oxygen saturation of blood in the pulmonary artery with oxygen saturation in freshly oxygenated blood, as found in the aorta. In the past it has been necessary to chemically analyze drawn samples of blood to evaluate blood oxygen saturation levels accurately. Such analysis is costly, and it has usually not been practical to obtain such blood samples.

[0004] It is known to approximately evaluate the percentage of saturation of hemoglobin by oxygen (oxygen saturation) of the blood in peripheral tissues by use of an external sensor involving a light source and a receptor and evaluating the blood's effect on transmission of light through tissues immediately below the skin of an external part of a patient's body, such as the ear lobe, nose or finger. Such external sensors, known as oximeters, are available, for example, from Nellcor of Pleasanton, Calif. A measurement obtained using such a device can be used to evaluate major changes in arterial blood oxygenation, but does not provide enough information for determining a patient's cardiac output, since it does not provide enough information regarding oxygen extraction or utilization by tissues and thus is not a good enough tool for valid evaluation of a patient's cardiopulmonary function during and after cardiac surgery.

[0005] Catheters equipped with light-emitting and receiving sensors can be placed within the blood flowing through the pulmonary artery itself. Such sensors, when thus residing in the bloodstream, can be used to measure oxygen saturation in mixed venous blood. This is a relatively invasive procedure, however, and can be used for only a limited time, after which the sensors would become covered with protein deposits from the blood and would thereby lose their sensitivity.

[0006] There is no currently available implantable device that remains separate from and outside the flow of blood for measuring oxygen saturation in blood without blood samples having to be drawn for analysis.

[0007] What is desired, then, is to be able to measure various blood characteristics, such as to analyze the level of blood oxygen saturation and the levels or concentrations of other blood components, including potassium, lactate, glucose, pH, hemoglobin or hematocrit (red blood cell volume percentage), to be able to determine those aspects of blood condition rapidly and repeatedly during and following a surgical procedure and for a period of time thereafter, and to do so at a cost which is less than the cost for repeatedly drawing and chemically analyzing or microscopically examining blood samples. Additionally, it is desirable to be able to monitor such blood characteristics over a long term in some persons.

### SUMMARY OF THE INVENTION

[0008] According to the present invention, electronically operated sensors are utilized to determine or evaluate certain characteristics of blood in certain major thoracic blood-containing structures, including particularly the pulmonary artery or the aorta of a mammal, particularly a human patient, and to obtain the desired information regarding those blood characteristics substantially instantaneously, without having to withdraw blood from the patient's body to analyze it. By measuring a characteristic such as oxygen saturation of hemoglobin of blood in certain blood vessels or portions of the heart the patient's pulmonary function can be evaluated. By measuring the level of oxygen saturation of the hemoglobin in mixed venous blood such as is found in the pulmonary artery, a reasonable estimate of cardiac function can be deduced.

[0009] By comparing the level of oxygen saturation of the hemoglobin in the mixed venous blood, such as is found in the pulmonary arteries, or in non-mixed venous blood such as is found in the superior or inferior vena cava, with the level of oxygen saturation in recently oxygenated blood, as may be found in the aorta or the left atrium, the efficiency of a patient's heart and lungs relative to the body's extraction of oxygen from the blood can be evaluated quickly and easily, so that a clinician can determine what, if any, intervention may be necessary for improvement of the patient's condition.

[0010] In addition, such an evaluation of the patient's condition on a repeated basis during and immediately after cardiac surgery can inform health care personnel whether a patient is satisfactorily enduring a surgical procedure and whether the patient's heart, lungs and other organs are performing as expected during recovery from surgery. Similarly, such repeated evaluation can inform health care experts as to whether devices such as an artificial heart or a ventricular assist device is providing the body with enough oxygenated blood. Such repeated evaluations could be used to signal such a support device, or a cardiac pacemaker, to increase or decrease its rate of operation in order to accommodate the variations in oxygen requirements of the body during exercise as compared with rest. By measuring and comparing the level of oxygen saturation of the hemoglobin of the blood in various parts of the heart or in various other blood vessels near the base of the heart various imperfec-

tions such as an inefficient part of lung, or an abnormal non-physiologic leak or "shunt" between the chambers of the heart, may be detected and surgical repair thereof may be evaluated.

[0011] In accordance with one aspect of the present invention, a sensor carrier is utilized to hold one or more sensors respectively adjacent the heart or one of the major blood vessels such as the pulmonary artery, the aorta or the vena cava, preferably at the location where the pulmonary artery and the aorta are located closely alongside each other above the heart. The sensors may be located on opposite faces of a ribbon-like sensor carrier placed between the aorta and the pulmonary artery and alongside the respective blood vessel.

[0012] A related aspect of the present invention is the surgical provision of a space to receive sensors between the aorta and the pulmonary artery by making an appropriate incision through the connective tissue between those blood vessels and, optionally, extending along the right branch of the pulmonary artery toward the posterior side of the superior vena cava.

[0013] One preferred sensor includes a remotely controlled and electrically powered light emitter, an electronic light receptor and associated electronic circuitry for evaluating the light that originated from that light emitter after the light has passed through the patient's blood. By using the receptor to measure the remaining light received after emission of known intensities and wavelengths of light and passage of that light through the wall of a blood vessel and through the blood within the blood vessel, the quantity of certain elements and compounds as constituents of the blood can be determined by comparison of the measurement of received light with known data. This can be accomplished instantaneously by the use of appropriately programmed electronic computers, which are necessary to but whose details are not an integral part of the present invention.

[0014] In addition to or instead of visible light, various forms of energy such as ultrasound, electromagnetic radiation at various radio frequencies, and light of wavelengths outside the visible spectrum, may be used by an appropriate sensor to evaluate one or more qualities of a patient's blood.

[0015] Although such sensors for analyzing the blood may be utilized separately and temporarily placed or permanently implanted, they may also be associated with and used advantageously in connection with other devices, such as heart pacing leads, ventricular assist devices, implanted artificial hearts, and chest drains.

[0016] The foregoing and other objectives, features, and advantages of the invention will be more readily understood upon consideration of the following detailed description of the invention, taken in conjunction with the accompanying drawings.

#### BRIEF DESCRIPTION OF THE SEVERAL VIEWS OF THE DRAWINGS

[0017] FIG. 1 is a frontal view of a person in whom an apparatus according to one embodiment of the invention is being used to evaluate the person's cardiopulmonary function, together with a block diagram of part of the apparatus.

[0018] FIG. 2 is a view showing the anterior side of a human heart together with a sensor carrier in place accord-

ing to the present invention, and also showing some of the major blood vessels that interconnect the heart with the lungs and other body parts.

[0019] FIG. 3 is a simplified sectional view of the major blood vessels above the heart, taken along line 3-3 in FIG. 2, and showing the sensor carrier in place adjacent those blood vessels.

[0020] FIG. 4 is a simplified sectional view of the heart and major blood vessels shown in FIG. 2, taken along line 4-4, with the sensor carrier in place.

[0021] FIG. 5 is a perspective view of the sensor carrier shown in FIGS. 2, 3 and 4.

[0022] FIG. 6 is a view of the sensor carrier shown in FIG. 5 taken in the direction indicated by line 6-6 in FIG. 5.

[0023] FIG. 7 is a sectional view of the sensor carrier shown in FIGS. 2-6, taken on line 7-7 of FIG. 6.

[0024] FIG. 8 is a perspective view similar to FIG. 5, showing a sensor carrier that is an alternative embodiment of the apparatus according to the invention.

[0025] FIG. 9 is a view similar to FIG. 2, showing the sensor carrier shown in FIG. 8 in place adjacent a patient's heart.

[0026] FIG. 9A is a view similar to FIG. 2, showing the use of a pair of separate sensor carriers adjacent to a patient's heart.

[0027] FIG. 10 is a view similar to FIG. 3, taken along line 10-10 of FIG. 9, showing the sensor carrier shown in FIG. 8 in place adjacent a patient's heart.

[0028] FIG. 11 is a perspective view, similar to FIG. 5, showing a sensor carrier that is another embodiment of the apparatus of the present invention.

[0029] FIG. 12 is a view similar to FIG. 4, showing the sensor carrier shown in FIG. 11 in place adjacent a patient's heart.

[0030] FIG. 13 is a view of a sensor carrier protected by a flexible tube attached to a support member and extending outward from a surgical opening.

[0031] FIG. 14 is a view of a sensor carrier according to the present invention with a chest drain tube supporting a sensor conductor cable.

[0032] FIG. 15 is a view of a sensor carrier according to the present invention together with a sensor conductor cable with which cardiac pacing leads and electrodes are associated.

[0033] FIG. 16 is a view of a sensor carrier and sensor conductor cable according to the present invention together with a ventricular assist device and a set of cardiac pacing leads.

[0034] FIG. 17 is a view of an implanted artificial heart showing the placement of a sensor carrier according to the present invention adjacent the patient's aorta and pulmonary artery.

#### DETAILED DESCRIPTION OF THE PREFERRED EMBODIMENTS

[0035] Referring now to FIGS. 1-7 of the drawings which form a part of the disclosure herein, a blood condition

monitor **20** includes an implantable sensor section **22** and an electronics portion, or control unit **24**, which may include an electronic controller and processor package **26** and an associated output data display section **28**. The sensor section **22** of the blood condition monitor **20** includes a sensor carrier **30** and associated non-invasive sensors **32** and **34** used to quickly and conveniently determine the condition of a patient's blood without the need to withdraw blood samples from the patient.

[0036] The control unit **24** shown in simplified form in FIGS. 1-2 includes an electronic emitter signal generator portion **38**, an electronic receptor signal receiver portion **40**, and the output data display section **28**. Preferably, the control unit **24** is provided as a self-contained unit incorporating suitable integrated circuit logic and data handling components to accept user instructions and provide for control of operation of the blood character monitor **20**, and to provide signals to the output data display **28**, which may include a suitable LCD array or other displays, to indicate the blood characteristics and constituent values determined by the device.

[0037] The sensor section **22**, as shown in FIGS. 2-7, includes a sensor carrier **30**, connected electrically to a suitable cable **44** that can be left extending out through a patient's abdominal or chest wall to the control unit **24** after the completion of thoracic surgery, as shown in FIG. 1. Alternatively, if a sensor carrier **30** is to be left in place for an extended time, a control unit **24a** equipped to communicate percutaneously with an external unit **24b** shown in simplified form, may be implanted in the patient, as shown broken line in FIG. 1. Thus, in one version of the apparatus disclosed herein, a sensor carrier **30** with a set of sensors **32**, **34**, etc., may be implanted in a patient, to be left in place for an extended period of time. In such a case the cable **44** including the sensor conductors may extend to a control and power package including a communication module (not shown) implanted within the patient. Known devices (not shown) depending, for example, on electromagnetic coupling and digital signal transmission, may be utilized in connection with such a communication module to monitor the patient's blood condition periodically.

[0038] The sensor carrier **30** is preferably constructed of inert and suitably flexible elastomeric material such as a molded rubberlike thermoplastic material in the form of a ribbon-like strip, having a thickness **46** small enough to allow the sensor carrier **30** to be placed in the space that can be made available adjacent to the major thoracic blood-containing structures in which a characteristic of blood is to be sensed, for example, about 6 mm. At least a sensor **32**, and preferably at least a pair of sensors **32** and **34** are located on the sensor carrier **30** in respective positions as shown in FIGS. 2-6. Thus, the sensor **32** is on a first face of the sensor carrier **30**, mounted in the layer **47** of material while the sensor **34**, if present, is located on the opposite, or second, face of the sensor carrier mounted in the layer **49**, and the sensors **32**, **34** are directed oppositely outward from the faces on which they are located. Each of the sensors **32**, **34** is located adjacent and preferably in contact with a respective major blood vessel or a portion of the heart **48** when the sensor carrier **30** is located properly, as shown in FIGS. 2 and 3. While two sensors **32** and **34** may thus be located on opposite faces of the sensor carrier **30** they may both be on

the same face of the sensor carrier **30**, so as to sense two different characteristics of blood in one blood vessel.

[0039] For ease of collective reference, the term major thoracic blood-containing structures will be used to refer to any or all of the major veins, arteries, and portions of the heart adjacent to which the sensor carrier **30** or a variation thereof can be used, namely: the aorta, including the ascending aorta, the aortic arch, and the descending aorta, the main pulmonary artery and the right and left pulmonary arteries, the right and left carotid arteries, the right and left subclavian arteries, the innominate artery, the inferior vena cava, the superior vena cava, the pulmonary veins, the brachiocephalic vein, the azygous vein, and the left atrium and the right atrium of the heart.

[0040] Preferably, each sensor **32**, **34** includes a respective emitter portion **50** or an array of such emitter portions **50**, as will be explained presently, and a receptor portion **52** or an array of such receptor portions **52**, which may be closely associated with each other or spaced slightly apart from each other, depending on the particular type of sensor utilized to determine a particular characteristic of the patient's blood.

[0041] The emitter **50** of a sensor **32** or **34** may include one or more electrically powered and controlled light-emitting components such as light-emitting diodes, designed to emit light in one or more selected wavelengths. Light in wavelengths outside the humanly visible spectrum, such as infrared and ultraviolet light, may be useful. Preferably, a sheet or layer **53** of flexible material substantially opaque to the light or other form of energy emitted by the emitters **50** is present in the sensor carrier **30** or **30'**, as shown best in FIG. 7, to prevent sensors in the opposite faces from interfering with each other. The sensor carrier **30** or **30'**, including the sensors **32**, **34**, etc., may be protected by a sterilizable layer **55** of flexible plastic or rubberlike material that is transparent to the type of light or other energy utilized by the sensors **32**, **34**, etc. The sensor carrier **30** or **31** may also be provided with a thin coating **59** of a hydrophilic material to facilitate its placement and removal.

[0042] The receptor **52** in each sensor **32**, **34**, etc., may include a suitable light-sensitive electronic component such as a photo-diode or other opto-electric device capable of measuring an amount of received light in a selected wavelength range and producing an electrically detectable result such as a change in voltage or current. As shown in FIGS. 3-7, each receptor **52** should be properly located in the sensor **32** or **34** to be able to detect light that has been emitted from a respective emitter **50** and that has then passed through the wall of the intended blood vessel, through a portion of the blood contained within the blood vessel, and again through the wall of the blood vessel into the receptor **52**. Thus, the receptor **52** may be closely alongside the corresponding emitter **50**, or it may be separated from the emitter **50** along the blood vessel by some distance, or it may be located far enough from the emitter **50** to be located on an opposite side of the blood vessel whose blood is being examined, with a part of the sensor carrier **30** being wrapped partway around the blood vessel.

[0043] It is desirable to evaluate blood at or near the same time in each of the separate blood vessels where the sensors **32**, **34**, etc., are located, but some amount of time between measurements in the separate blood vessels is generally not critical in measuring the various components and character-

istics of the blood, and measurements made within a minute or two can be considered to be substantially simultaneous. The closer together in time measurements are made of the blood in different blood vessels or parts of the heart, the more accurate the resulting evaluation of cardiac or cardiopulmonary function will be, but even measurements made an hour apart can be useful for comparisons.

[0044] The sensor carrier **30** is most preferably installed between the aorta **54** and the main pulmonary artery **56**, and extending along the right pulmonary artery in contact with both, in a space which must be created surgically, by dissecting connective tissue that ordinarily binds together several major blood vessels near their points of conjunction with the base of the heart **48**. The sensor carrier **30** may instead lie alongside or extend partially around the aorta **54** or pulmonary artery **56** as shown in **FIG. 9**, or there may be two separate sensor carriers **30**, as shown in **FIG. 9A**, with each carrier **30** located in contact with a separate major thoracic blood-containing structure. For example, one sensor carrier **30** may be located in contact with the aorta **54** while the other is located in contact with the left atrium **67**.

[0045] Suitable tabs or ears **57** may be provided on the sensor carrier **30**, as shown in **FIG. 5**, as convenient places to attach sutures to hold the sensor carrier **30** in place, although sutures may be deemed unnecessary in many cases. Suitable sutures may be fastened through the ears **57** to attach the sensor carrier to the adventitia of the aorta **54**, the pulmonary artery **56**, or another major blood vessel to retain the sensor carrier in a required position during surgery and for a subsequent period of time after which the sensor carrier **30** can be removed by pulling it out, breaking the sutures, without endangering the patient. It may also be desirable to keep the sensor carrier **30** in place for an extended time to facilitate long-term monitoring of the blood and to provide data useful for controlling a ventricular assist device, an artificial heart or a pacemaker.

[0046] As shown in **FIGS. 2 and 3**, the sensor **32** is located properly on the sensor carrier **30** to be able to evaluate a chosen characteristic of the blood in the patient's aorta **54**, while the sensor **34** is located on the sensor carrier **30** in an appropriate position to be able to evaluate a characteristic of the patient's blood in the main pulmonary artery **56** substantially simultaneously. The sensor **34** might, instead, be located in a position better adapted to evaluate blood in one of the left and right branches **58, 60** of the pulmonary artery, if desired.

[0047] A third sensor **36** may also be provided in an alternative sensor carrier **30'**, as shown in **FIG. 8**. The third sensor **36** is located on the same face of the carrier **30'** as the sensor **34** so as to evaluate a chosen characteristic of the blood in the patient's superior vena cava **62**, as shown in **FIGS. 9 and 10**, when the sensor carrier **30'** is properly located with respect to the patient's heart **48**. Placement of the sensor carrier **30'** also requires that a space posterior and adjacent to the superior vena cava be created by cutting through or into a portion of the associated connective tissue between the superior vena cava and the right pulmonary artery. Similarly, using an appropriate sensor carrier, sensors may be placed adjacent the inferior vena cava.

[0048] As shown in **FIGS. 11 and 12**, a sensor carrier **30''** may include a ribbon-like branch portion **66** carrying a sensor **33** to sense selected characteristics of blood in the left

atrium instead of, or in addition to, sensing the blood in the aorta **54**. As shown in **FIG. 12**, the branch **66** of the sensor carrier **30''** is placed on the exterior of the dome **67** of the left atrium of the heart **48** in position to emit energy into and receive energy from blood in the left atrium through its dome. Alternatively, the branch **68** can be placed effectively against the pulmonary veins near their points of entry into the left atrium. An appropriately shaped sensor carrier (not shown) can also be used in a similar manner to place such sensors adjacent to the right atrium or another structure of the heart.

[0049] Suitable electrical conductors such as small, flexible, insulated wires or pairs of wires **64, 68 (FIGS. 5, 8)** extend from each sensor **32, 34** or **36** along the body of the sensor carrier **30** through the cable **44**. It will be understood that there may be a different number of such conductors, depending on the structures of the particular sensors **32, 34**, and the wires **64, 68** are merely representative of one possibility. The wires **64, 68** of the cable **44** are connected electrically to the control unit **24** outside the patient's body by suitable connectors such as, for example, a plug and socket combination **70 (FIG. 1)**. The conductors **64** may thus carry control signals and power from the control unit **24** to the emitter **50** to cause it to transmit energy in a suitable form, such as a pulse of light, toward an adjacent blood-containing structure. The conductors **68** may carry electricity between the control unit **24** and the receptor **52** to energize the receptor **52** and enable it to provide a signal to the signal receiver portion **40** of the monitor **20**, in response to detection of the relevant form of energy.

[0050] Preferably, the emitters **50** can simultaneously or sequentially emit quantities of light or another suitable form of energy in two or more discrete wavelengths or frequencies. The receptors **52**, in turn, are sensitive to the same form of energy and function to receive portions of the energy transmitted by the emitters **50** and not absorbed in the blood and surrounding tissues. The receptors **52** thus receive some of the emitted energy that has been conducted or reflected by the blood and blood vessel walls in wavelengths or frequencies including those radiated by the emitter. It may also be necessary or desirable for a receptor **52** to be sensitive to light of a different wavelength in order to detect, for example, fluorescence of a substance added to the patient's blood as an identifier, in response to energy emitted from the appropriate emitter **50**.

[0051] Simultaneous or sequential emission and reception of and evaluation of light of three different wavelengths can reduce or eliminate ambiguity in interpreting the condition of blood being evaluated by a particular one of the sensors **32, 34, 36**. A particular combination of levels of transmission or reflectance of light of different wavelengths by the blood can be interpreted reliably as an indication of a certain level of concentration of a particular blood constituent, or of a particular value of, a blood characteristic of interest.

[0052] It is particularly desirable to determine the oxygen saturation level of the blood, that is, the percentage of saturation by oxygen of the hemoglobin component of the blood, substantially simultaneously both in a blood vessel such as the aorta **54**, where freshly oxygenated blood is present, and in a blood vessel, such as the pulmonary artery **56**, where mixed venous blood, whose oxygen content is naturally lower than that of the blood in the aorta, is present.

By determining and comparing the oxygen saturation level of the freshly oxygenated blood, as in the aorta **54**, and of the mixed venous blood, as in the pulmonary artery **56**, the patient's cardiopulmonary performance can be determined in accordance with the Fick principle to calculate the patient's cardiac output and cardiac index.

[0053] Cardiac output or cardiac index can be used to monitor whether a patient is generally dealing successfully with the stress of surgery.

[0054] By using the information made available by sensing characteristics of blood in one of the major thoracic blood-containing structures it is also possible to diagnose, more specifically than has previously been possible, an abnormal shunt of blood, indicating an anatomic or physiological deficiency within the heart or lungs. For example, the percentage of oxygen saturation of blood in the pulmonary artery or right atrium, left atrium, or aorta can be compared with the percentage of oxygen saturation of blood in other chambers of the heart to detect an abnormal shunt of blood from one chamber to another. As a further example, if the blood in the right atrium has 62 percent oxygen saturation and the blood in the aorta has 100 percent oxygen saturation, but the blood in the pulmonary artery has 85 percent oxygen saturation, there is apparently a shunt from the left side to the right side of the heart. Similarly, a shunt in the lungs could be indicated by oxygen saturation less than 100 percent in blood present in the left atrium. Such information can also indicate whether surgery has successfully repaired blood shunt conditions within a patient.

[0055] Light absorption, transmission, and reflectance values of blood are known for light in various wavelengths directed into blood of various oxygen saturation levels. These values can be stored as data in the microprocessor **26** in the blood monitor control unit **24**. Signals from the receptors **52** of the sensors **32, 34** located adjacent to the aorta and the pulmonary artery can be interpreted by the microprocessor **26** to periodically evaluate the percentage of oxygen saturation present in the aortic or mixed venous blood.

[0056] Secondly, the level of hemoglobin in the blood or the percentage of the blood that is made up of red blood cells, both of which affect the ability of the blood to deliver oxygen to the cells, may similarly be evaluated by the use of appropriate sensors **32, 34** transmitting light in appropriate wavelengths into the blood contained in a major blood vessel such as the aorta or the pulmonary artery and using the receptors **52** to measure the light that is returned from the aorta or pulmonary artery.

[0057] Specific non-invasive sensors **32, 34** and **36**, which may function similarly, can also be used in the locations shown in **FIGS. 2, 3, 4, 9, 9A** and **10** to evaluate the hemoglobin content, hematocrit, potassium content, lactate content, glucose content, or pH of blood in a major thoracic blood-containing structure such as the pulmonary artery, the aorta or the superior vena cava by utilizing emissions of the appropriate type of energy and subsequent detection of quantities of that energy that has passed through or been reflected by blood contained in the particular blood-containing structure.

[0058] It should be understood that while the sensors **32, 34, 36** have been described as operating by measuring

transmission of light, such light need not be of frequencies in the spectrum visible to humans. Additionally, in order to measure certain characteristics or the amounts of certain components of the blood it may be desirable to add to the blood a chemical identifying agent that can become attached chemically to certain blood components. Such an identifier can cause fluorescence varied in intensity in relation to the amount of such a blood component, in response to light emitted in a particular wavelength by a sensor.

[0059] Also, various sensors **32, 34** and **36** may be utilized which emit and receive and evaluate the transmission of ultrasound through blood contained in the respective major thoracic blood-containing structure, or which evaluate optical coherence resonance of the blood, or which transmit and receive and evaluate the interaction with the blood of energy other than visible light, such as infrared light, ultraviolet light, radio frequency energy, for which the characteristics of absorption or transmission through blood and blood vessel walls or a measurable harmless effect on the blood can be utilized to analyze the blood characteristic of concern.

[0060] For the use of sensors **32, 34** and **36** that may be considered too expensive for disposal after a single period of use or that cannot be sterilized without suffering damage, the sensor carrier **30** or **30'** may be enclosed in a flexible sensor-protective sleeve **74** as shown in **FIG. 13**.

[0061] When it is intended to leave the sensor carrier in place for a time after completion of surgery, the sensor carrier may be interconnected through a cable **44'** that may be attached to a support member such as a chest drain tube, as shown in **FIG. 14**.

[0062] In some patients cardiac pacing leads **84** including suitable electrodes **86** as shown in **FIG. 15** may be connected to the patient's heart **48**. In some cases pacing is needed only temporarily, while in others implantation of pacing leads is intended to be permanent. The pacing leads **84** are preferably included in a cable **88** interconnected with the sensor carrier **30** or **30'** of an implantable sensor section **22** as previously described herein, and the sensor carrier **30** or **30'** can remain in place adjacent the patient's heart and associated major blood vessels so long as the pacing leads **84** are in place.

[0063] Similarly, it may be desirable in certain patients to have the sensor carrier **30** or **30'** and sensors **32, 34**, etc., disclosed herein remain substantially permanently implanted. In such a situation, the electrical conductors for the sensors **32, 34**, etc., disclosed herein may be included in a cable **88** together with pacing leads **84** as shown in **FIG. 15**. An implantable communication and power device as mentioned above may be connected with the cable **88** and may be included with the power and control devices for a pacemaker, as a single implanted package (not shown) including the ability to communicate percutaneously with a related external unit.

[0064] As a similar and somewhat related application, the sensor carrier **30** and sensors **32, 34**, etc., may be implanted in a patient along with a ventricular assist device **90**, as shown in **FIG. 16**, so that sensor-derived information, particularly cardiac output information, available as a result of the use of the sensors **32, 34**, etc., may be utilized in connection with operation and control of the ventricular assist device **90**.

[0065] Referring now to **FIG. 17**, in the case of an implanted artificial heart **94**, the patient's blood condition and the performance of the artificial heart **94** may be monitored by use of the sensor carrier **30** and sensors **32, 34**, etc., disclosed herein, since the artificial heart **94** will be connected to the major blood vessels of the patient's own circulatory system. The control unit (not shown) for the sensor **32, 34**, etc., may also be associated with the controller for the artificial heart.

[0066] The terms and expressions which have been employed in the foregoing specification are used therein as terms of description and not of limitation, and there is no intention, in the use of such terms and expressions, of excluding equivalents of the features shown and described or portions thereof, it being recognized that the scope of the invention is defined and limited only by the claims which follow.

1. A method of at least partially evaluating a selected aspect of a patient's metabolic function, comprising:

measuring separately at least one selected characteristic of blood present in each of at least two selected major thoracic blood-containing structures by using at least one electronic sensor located within said patient's thoracic cavity, but outside said selected major thoracic blood-containing structures, to observe said blood through a respective wall of each of said selected major thoracic blood-containing structures without removing any of said blood from said selected major thoracic blood-containing structures, and comparing respective resulting values of said at least one selected characteristic as measured in each of said at least two selected major thoracic blood vessels.

2. The method of claim 1, wherein one of said at least two selected major thoracic blood-containing structures is said patient's aorta.

3. The method of claim 1, wherein one of said at least two selected major thoracic blood-containing structures is said patient's main pulmonary artery.

4. The method of claim 1, wherein one of said at least two selected major thoracic blood-containing structures is said patient's right pulmonary artery.

5. The method of claim 1, wherein one of said at least two selected major thoracic blood-containing structures is said patient's left pulmonary artery.

6. The method of claim 1, wherein one of said at least two selected major thoracic blood-containing structures is said patient's left atrium.

7. The method of claim 1, wherein one of said at least two selected major thoracic blood-containing structures is said patient's inferior vena cava.

8. The method of claim 1, wherein one of said at least two selected major thoracic blood-containing structures is said patient's superior vena cava.

9. The method of claim 1, wherein one of said at least two selected major thoracic blood-containing structures is of said patient's right atrium.

10. The method of claim 1, wherein one of said at least two selected major thoracic blood-containing structures is one of said patient's pulmonary veins.

11. The method of claim 1, wherein one of said at least two selected major thoracic blood-containing structures is said patient's innominate artery.

12. The method of claim 1, wherein one of said at least two selected major thoracic blood-containing structures is one of said patient's carotid arteries.

13. The method of claim 1, wherein one of said at least two selected major thoracic blood-containing structures is one of said patient's subclavian arteries.

14. The method of any one of claims **3-13** wherein another one of said at least two selected major thoracic blood-containing structures is said patient's aorta.

15. The method of any one of claims **2** and **4-13** wherein another one of said at least two selected major thoracic blood-containing structures is said patient's main pulmonary artery.

16. The method of any one of claims **2-3** and **5-13** wherein another one of said at least two selected major thoracic blood-containing structures is said patient's right pulmonary artery.

17. The method of any one of claims **2-4** and **6-13** wherein another one of said at least two selected major thoracic blood-containing structures is said patient's left pulmonary artery.

18. The method of any one of claims **2-5** and **6-13** wherein another one of said at least two selected major thoracic blood-containing structures is said patient's left atrium.

19. The method of any one of claims **2-6** and **7-13** wherein another one of said at least two selected major thoracic blood-containing structures is said patient's inferior vena cava.

20. The method of any one of claims **2-7** and **8-13** wherein another one of said at least two selected major thoracic blood-containing structures is said patient's superior vena cava.

21. The method of any one of claims **2-8** and **9-13** wherein another one of said at least two selected major thoracic blood-containing structures is said patient's right atrium.

22. The method of any one of claims **2-9** and **10-13** wherein another one of said at least two selected major thoracic blood-containing structures is one of said patient's pulmonary veins.

23. The method of any one of claims **2-10** and **11-13** wherein another one of said at least two selected major thoracic blood-containing structures is said patient's innominate artery.

24. The method of any one of claims **2-11** and **13** wherein another one of said at least two selected major thoracic blood-containing structures is one of said patient's carotid arteries.

25. The method of any one of claims **2-12** wherein another one of said at least two selected major thoracic blood-containing structures is one of said patient's subclavian arteries.

26. The method of claim 1, wherein said selected characteristic of blood is the degree of saturation by oxygen of hemoglobin in said blood.

27. The method of claim 1, wherein said selected characteristic of blood is hemoglobin content of said blood.

28. The method of claim 1, wherein said selected characteristic of blood is hematocrit of said blood.

29. The method of claim 1, wherein said selected characteristic of blood is pH of said blood.

30. The method of claim 1, wherein said selected characteristic of blood is glucose content of said blood.

31. The method of claim 1, wherein said selected characteristic of blood is potassium content of said blood.

32. The method of claim 1, wherein said selected characteristic of blood is lactate content of said blood.

33. The method of any of claims 27-32, including measuring the degree of saturation by oxygen of hemoglobin as a second one of said at least one selected characteristic of blood.

34. The method of any of claims 26 and 28-32, including measuring hemoglobin content as a second one of said at least one selected characteristic of blood.

35. The method of any of claims 26-27 and 29-32, including measuring hematocrit as a second one of said at least one selected characteristic of blood.

36. The method of any of claims 26-28 and 30-32, including measuring pH as a second one of said at least one selected characteristic of blood.

37. The method of any of claims 26-29 and 31-32, including measuring glucose content as a second one of said at least one selected characteristic of blood.

38. The method of any of claims 26-30 and 32, including measuring potassium content as a second one of said at least one selected characteristic of blood.

39. The method of any of claims 26-31, including measuring lactate content as a second one of said at least one selected characteristic of blood.

40. The method of claim 1, wherein said selected aspect of a patient's metabolic function is cardiac function.

41. The method of claim 1, wherein said selected aspect of a patient's metabolic function is cardiovascular function.

42. The method of claim 1, wherein said selected aspect of a patient's metabolic function is cardiopulmonary function.

43. The method of claim 1, wherein said selected aspect of a patient's metabolic function is pulmonary function.

44. The method of claim 1, wherein said selected aspect of a patient's metabolic function is glucose metabolism.

45. The method of claim 1, wherein said selected aspect of a patient's metabolic function is pH maintenance.

46. The method of claim 1, wherein said selected aspect of a patient's metabolic function is biochemical metabolic function.

47. The method of claim 1, wherein said selected aspect of a patient's metabolic function is an abnormal shunt of blood, indicating either or both of an anatomic or a physiological deficiency of at least one of said patient's heart and lungs.

48. The method of claim 1, including the additional step of introducing an identifying agent into said patient's bloodstream to enable said electronic sensor to measure said at least one selected characteristic of said blood.

49. The method of claim 45 wherein said identifying agent causes fluorescence of said blood in response to receiving a pulse of energy from said electronic sensor and in relation to a level of one of said at least one selected characteristic of said blood.

50. The method of claim 1, including the further steps of:

- (a) providing a sensor carrier with at least a first one of said at least one electronic sensor mounted thereon;
- (b) surgically creating a space for said sensor carrier between two of said at least two selected major thoracic blood-containing structures;
- (c) placing said sensor carrier in said space;

(d) directing a first quantity of energy toward a first of said selected major thoracic blood-containing structures from an emitter portion of said first one of said at least one electronic sensor and receiving a portion of said first quantity of energy in a receptor portion of said first sensor located closely adjacent said first of said selected major thoracic blood-containing structures, and forming an electrical signal from said receptor portion of said first one of said at least one electronic sensor representative of said portion of said energy received thereby;

(e) directing a second quantity of energy toward a second of said selected major thoracic blood-containing structures from an emitter portion of a second one of said at least one electronic sensor and receiving a portion of said second quantity of energy in a receptor portion of said second one of said at least one electronic sensor located closely adjacent said second of said selected major thoracic blood-containing structures, and forming an electrical signal from said receptor portion of said second one of said at least one electronic sensor representative of said portion of said energy received thereby;

(f) from said electrical signal from said receptor portion of said first one of said at least one electronic sensor determining a measurement of said at least one selected characteristic of said blood in said first of said selected major thoracic blood-containing structures; and

(g) from said electrical signal from said receptor portion of said second one of said at least one electronic sensor determining a level of said at least one selected characteristic of said blood in said second of said selected major thoracic blood-containing structures.

51. The method of claim 50, including the step of providing both said first and second ones of said electronic sensors on a first side of said sensor carrier.

52. The method of claim 51, including the step of temporarily fastening said sensor carrier to tissue associated with a major thoracic blood-containing structure adjacent said patient's heart.

53. The method of claim 50, including the step of providing said sensor carrier with said first one of said electronic sensors mounted on a first side thereof and said second one of said sensors mounted on an opposite second side thereof.

54. The method of claim 53, including providing a third one of said at least one electronic sensor on said sensor carrier and placing said third one of said sensors adjacent a selected third major thoracic blood-containing structure of said patient and measuring an amount of a selected blood constituent present in blood in said third major thoracic blood-containing structure by evaluating transmission and reception of a selected form of energy by said third one of said sensors through a wall of said third major thoracic blood-containing structure.

55. The method of claim 50, including the steps of leaving said sensor carrier in place for an extended time after first measuring said at least one selected characteristic of said blood, and periodically again measuring said at least one selected characteristic of said blood during said extended time.

56. The method of claim 50, wherein said first and second one of said at least one electronic sensor measure said at

least one selected characteristic of said blood by measuring transmission of light through said blood.

57. The method of claim 56, including the steps of separately measuring transmission of light having each of a plurality of different wavelengths through said blood.

58. The method of claim 50, including directing said quantities of energy from said first and second one of said at least one electric sensor substantially contemporaneously toward said first and second of said selected major thoracic blood-containing structures.

59. The method of claim 50, wherein said first and second quantities of energy are light energy.

60. The method of claim 50, wherein said space is between said patient's aorta and right pulmonary artery, including the additional step of surgically forming a further space adjacent said patient's inferior vena cava and placing a part of said sensor carrier carrying a third sensor into said further space.

61. The method of claim 50 including the step of providing at least one said electronic sensor on a second sensor carrier and placing said second sensor carrier adjacent a respective one of said at least two selected major thoracic blood-containing structures.

62. The method of claim 1 including measuring separately at least two selected characteristics of blood present in at least one of said at least two selected major thoracic blood-containing structures by using said at least one electronic sensor.

63. The method of claim 1 including measuring said selected characteristic of blood substantially simultaneously in each of said at least two selected major blood-containing structures.

64. Apparatus for measuring a selected characteristic of a patient's blood, comprising:

(a) a sensor carrier;

(b) first and second sensors mounted on said sensor carrier and spaced apart from each other by a predetermined distance, each of said first and second sensors having a respective receptor capable of providing a receptor output signal representative of a level of a selected characteristic of blood within an adjacent blood-containing structure, said sensor carrier and said first and second sensors all being small enough to be placed within said patient's body cavity and proximate said patient's heart, permitting substantially simultaneous observation of blood in a first blood vessel by said first sensor and of blood in a second blood vessel by said second sensor.

65. The apparatus of claim 64, wherein said sensor carrier has a coating of a hydrophilic material.

66. The apparatus of claim 64 wherein each of said first and second sensors includes an emitter adapted to transmit energy into blood within a respective one of said first and second blood vessels, and a receptor sensitive to energy from said emitter that has passed through said blood inside respective one of said first and second blood vessels.

67. The apparatus of claim 66 wherein said emitter of one of said sensors is a radio frequency transmitter and said receptor of said one of said sensors is a radio frequency receiver.

68. The apparatus of claim 66 wherein each of said emitters is an electrically driven light emitter.

69. The apparatus of claim 66 wherein one of said sensors includes a plurality of said receptors, each of said receptors measuring reception of light in a different respective wavelength and providing a respective signal representative thereof.

70. The apparatus of claim 64 wherein at least one of said sensors separately measures reception of light in each of a plurality of different wavelengths and provides a respective signal representative of reception of light in each of said different wavelengths.

71. The apparatus of claim 64 wherein one of said sensors includes an ultrasound transducer.

72. The apparatus of claim 64 wherein said sensor carrier includes a suture tab.

73. The apparatus of claim 64, including a sterile protective sleeve surrounding said sensor carrier.

74. The apparatus of claim 64, wherein said sensor carrier is of a flexible material.

75. The apparatus of claim 64 wherein said sensor carrier includes an elongate ribbon-like member having a pair of opposite faces and wherein said emitter and receptor are both on the same one of said opposite faces.

76. The apparatus of claim 64, wherein said sensor carrier includes an elongate ribbon-like member having a pair of opposite faces, and wherein said first sensor is directed outwardly from a first one of said pair of opposite faces and said second sensor is directed outwardly from the other one of said pair of opposite faces.

77. The apparatus of claim 76 wherein said sensor carrier includes an emission-opaque central layer located between said opposite faces and separating said first and second sensors from each other.

78. The apparatus of claim 64 including a cable including a plurality of cardiac pacing leads, and wherein said sensors are connected to a control unit through said cable.

79. The apparatus of claim 64 including a cable associated with a ventricular assist device, and wherein said sensors are connected electrically with a control unit through conductors included in said cable.

80. The apparatus of claim 64 wherein said control unit is connected electrically with a control unit of a ventricular assist device thereby providing to said ventricular assist device a signal representative of a patient's cardiac function.

81. The apparatus of claim 64 wherein said control unit is connected electrically with a control unit of a ventricular assist device thereby providing to said ventricular assist device a signal representative of a patient's cardiopulmonary function.

82. The apparatus of claim 64, including a cable associated with an artificial heart, and wherein said sensors are connected electrically with a control unit through conductors included in said cable.

83. The apparatus of claim 82 wherein said control unit is connected electrically with a controller of an artificial heart, thereby providing to said control unit of said artificial heart a signal representative of how effectively said artificial heart is functioning.

84. The apparatus of claim 64, including a cable associated with a pacemaker, and wherein said sensors are connected electrically with a control unit through said cable.

85. The apparatus of claim 64 wherein said control unit is connected electrically with a control unit of a pacemaker thereby providing to said pacemaker a signal representative of a patient's cardiac function.

**86.** The apparatus of claim 64 wherein said sensors are connected electrically with a control unit through a cable attached to a mediastinal chest drain tube.

**87.** The apparatus of claim 64 further including a second sensor carrier and a respective sensor mounted thereon capable of providing a receptor output signal representative

of a level of a respective selected characteristic of blood in an adjacent blood-containing structure.

**88.** The apparatus of claim 64 wherein each of said sensors is connected functionally with an implantable control unit equipped to communicate percutaneously with an external unit.

\* \* \* \* \*

专利名称(译)	用于监测血液状况和心肺功能的方法和设备		
公开(公告)号	<a href="#">US20040082841A1</a>	公开(公告)日	2004-04-29
申请号	US10/280970	申请日	2002-10-24
[标]申请(专利权)人(译)	FURNARY ANTHONY P LOWE 罗伯特一世		
申请(专利权)人(译)	FURNARY ANTHONY P. 洛罗伯特.		
当前申请(专利权)人(译)	FURNARY ANTHONY P. 洛罗伯特.		
[标]发明人	FURNARY ANTHONY P LOWE ROBERT I		
发明人	FURNARY, ANTHONY P. LOWE, ROBERT I.		
IPC分类号	A61B5/00		
CPC分类号	A61B5/14542 A61B5/1459 A61B2562/164 A61B2562/043 A61B2562/0233		
其他公开文献	US7010337		
外部链接	<a href="#">Espacenet</a> <a href="#">USPTO</a>		

摘要(译)

位于传感器载体上的传感器放置在手术患者的主要胸主血液结构(例如主动脉或肺动脉)中的一个或多个附近,并且通过测量光的透射或反射无创地确定含血结构中的血液特征。血液或其他类型的能量。包括在传感器中的发射器和接收器与远离传感器载体的封装中的适当电子信号产生和处理部件电连接。

