



(19) **United States**

(12) **Patent Application Publication**  
Talbot et al.

(10) **Pub. No.: US 2009/0112626 A1**  
(43) **Pub. Date: Apr. 30, 2009**

(54) **REMOTE WIRELESS MONITORING,  
PROCESSING, AND COMMUNICATION OF  
PATIENT DATA**

(52) **U.S. Cl. .... 705/3; 600/300**

(57) **ABSTRACT**

(76) **Inventors: Cary Talbot, Santa Clarita, CA  
(US); Arieh S. Halpern, Beverly  
Hills, CA (US)**

A remote wireless monitoring system for patient data, and an ambulatory system for processing and transmitting physiological characteristic data are provided. An embodiment of a system for remote wireless monitoring of data for a patient includes an ambulatory sensor/transmitter subsystem that wirelessly transmits measured values of a physiological characteristic of the patient, a base station that wirelessly receives signals from the sensor/transmitter subsystem, and a remote monitor that wirelessly receives signals from the base station. The remote monitor is configured to generate audio and/or visual indicia (representing alarms, the measured values, device or system status information, etc.) in response to the base station signals. An embodiment of an ambulatory system includes a physiological characteristic sensor, a self-contained sensor processor module coupled to the ambulatory physiological characteristic sensor, and an ambulatory data receiver device coupled to the self-contained sensor processor module.

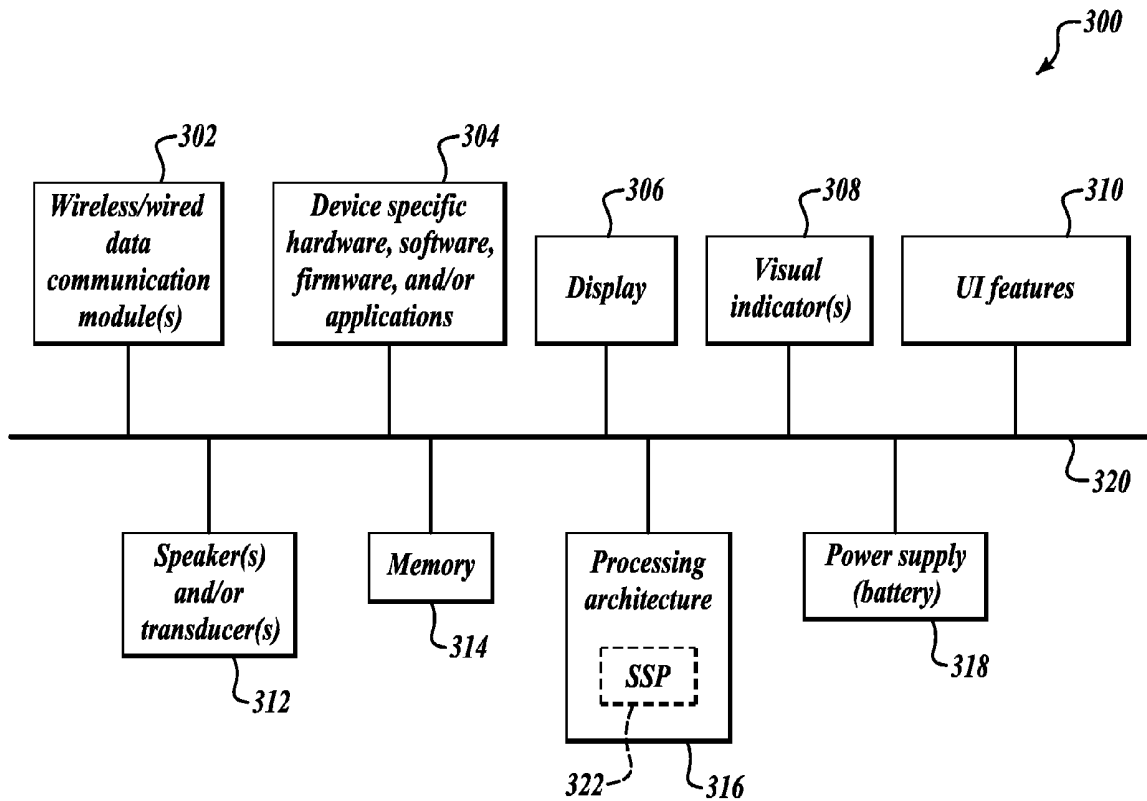
**Correspondence Address:  
INGRASSIA FISHER & LORENZ, P.C.  
7010 E. COCHISE ROAD  
SCOTTSDALE, AZ 85253 (US)**

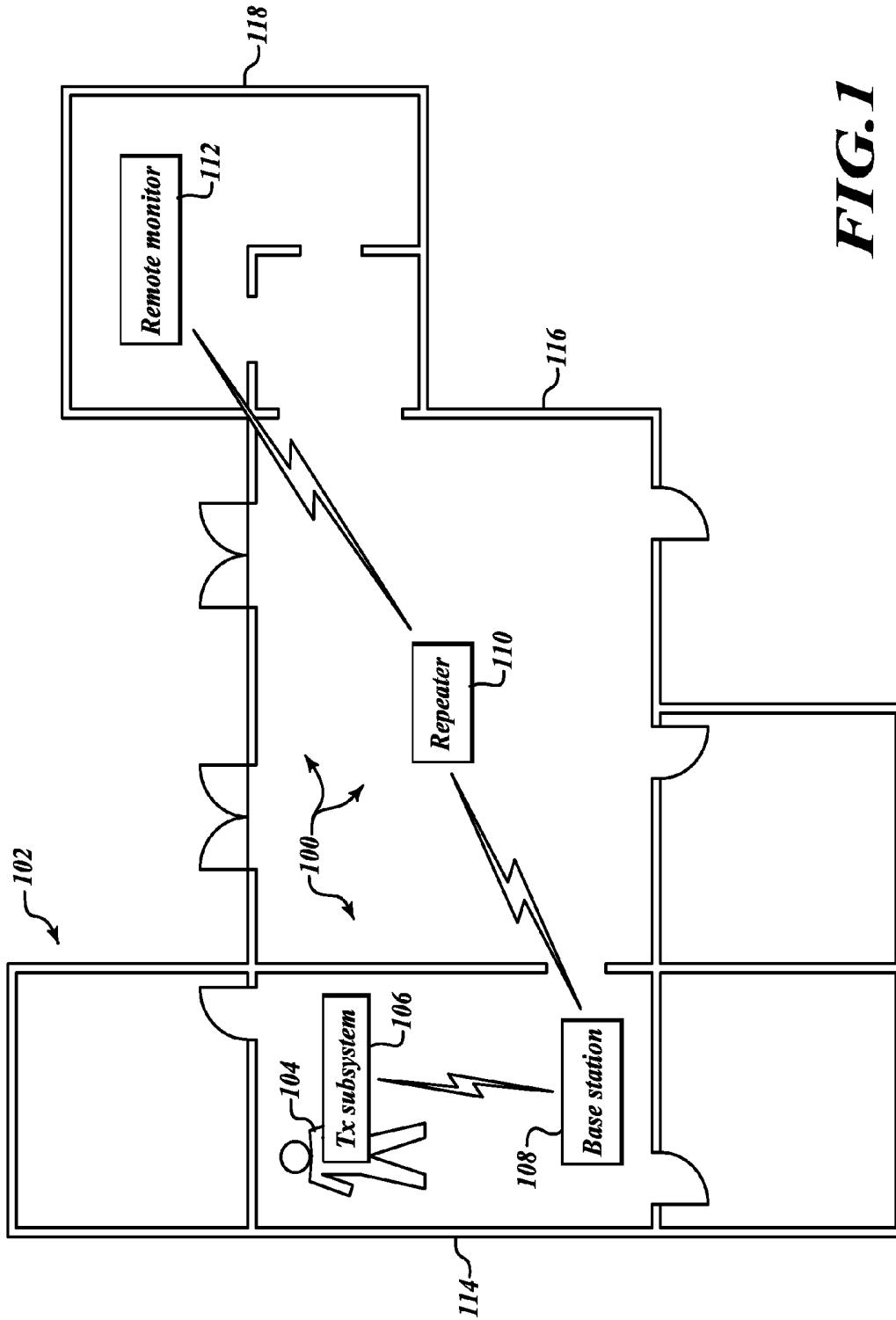
(21) **Appl. No.: 11/929,988**

(22) **Filed: Oct. 30, 2007**

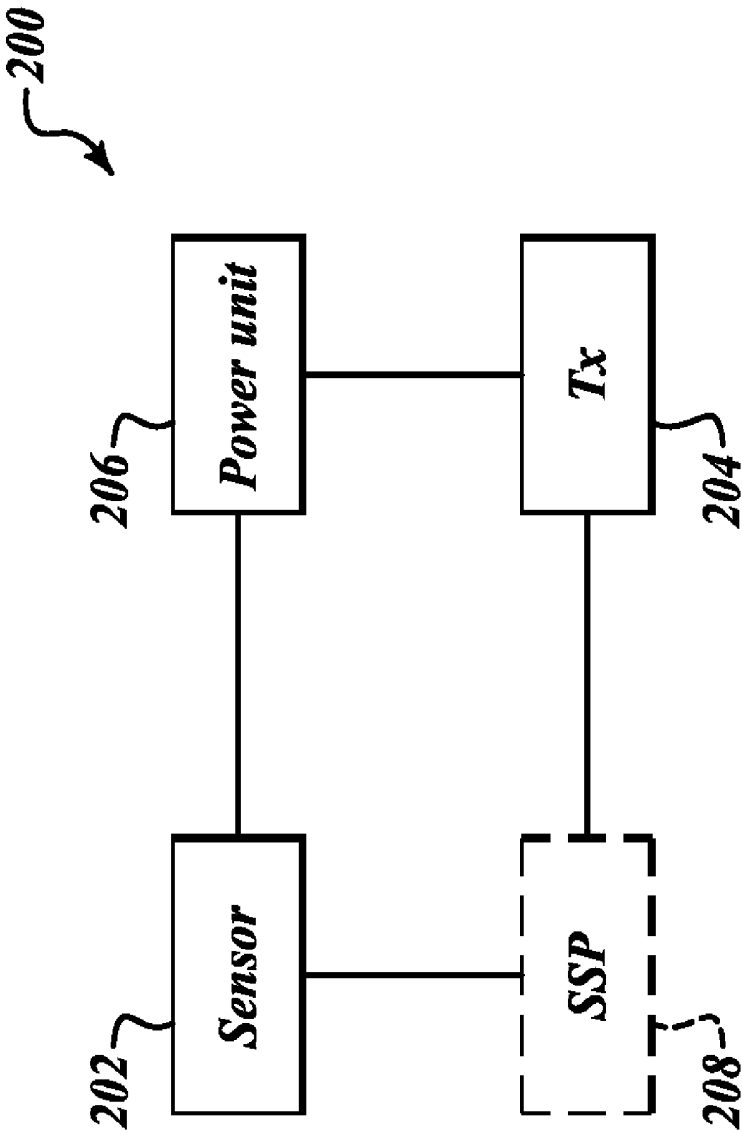
**Publication Classification**

(51) **Int. Cl.**  
**G06Q 50/00 (2006.01)**  
**A61B 5/00 (2006.01)**

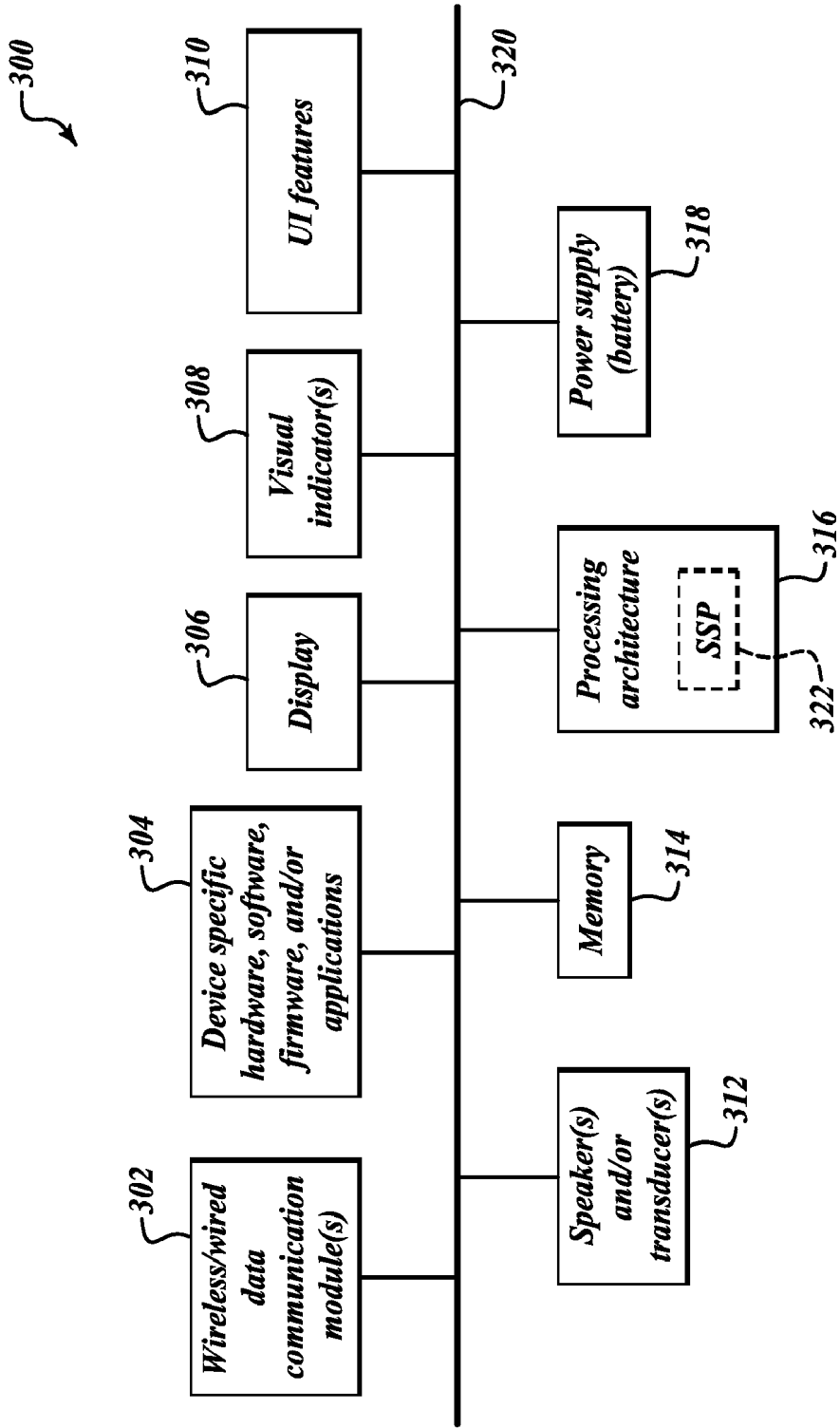




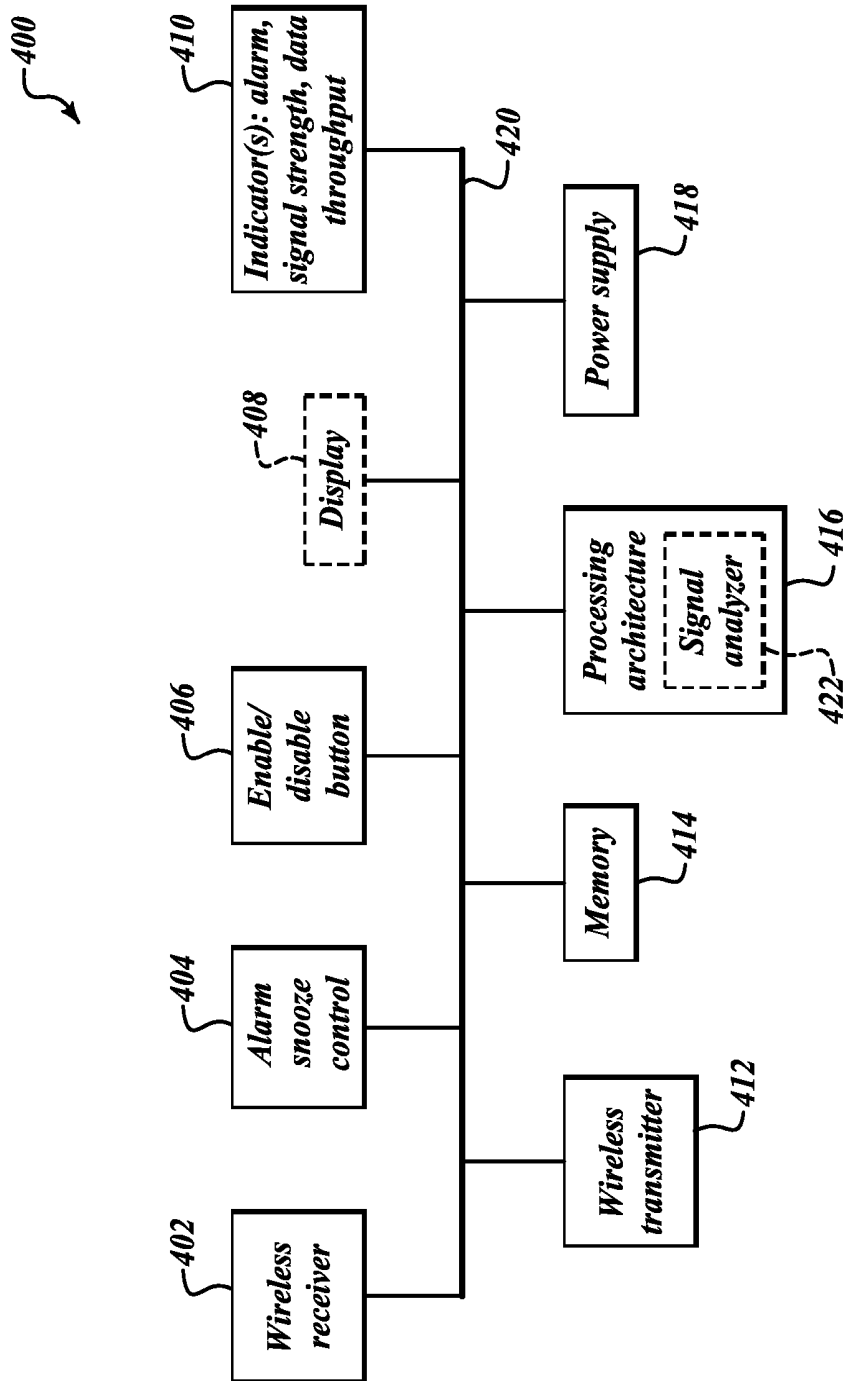
**FIG. 1**



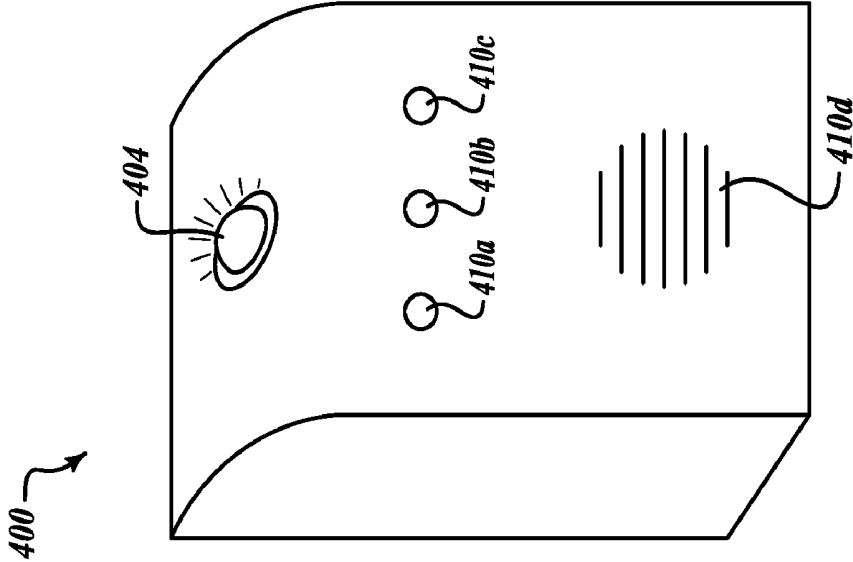
**FIG. 2**



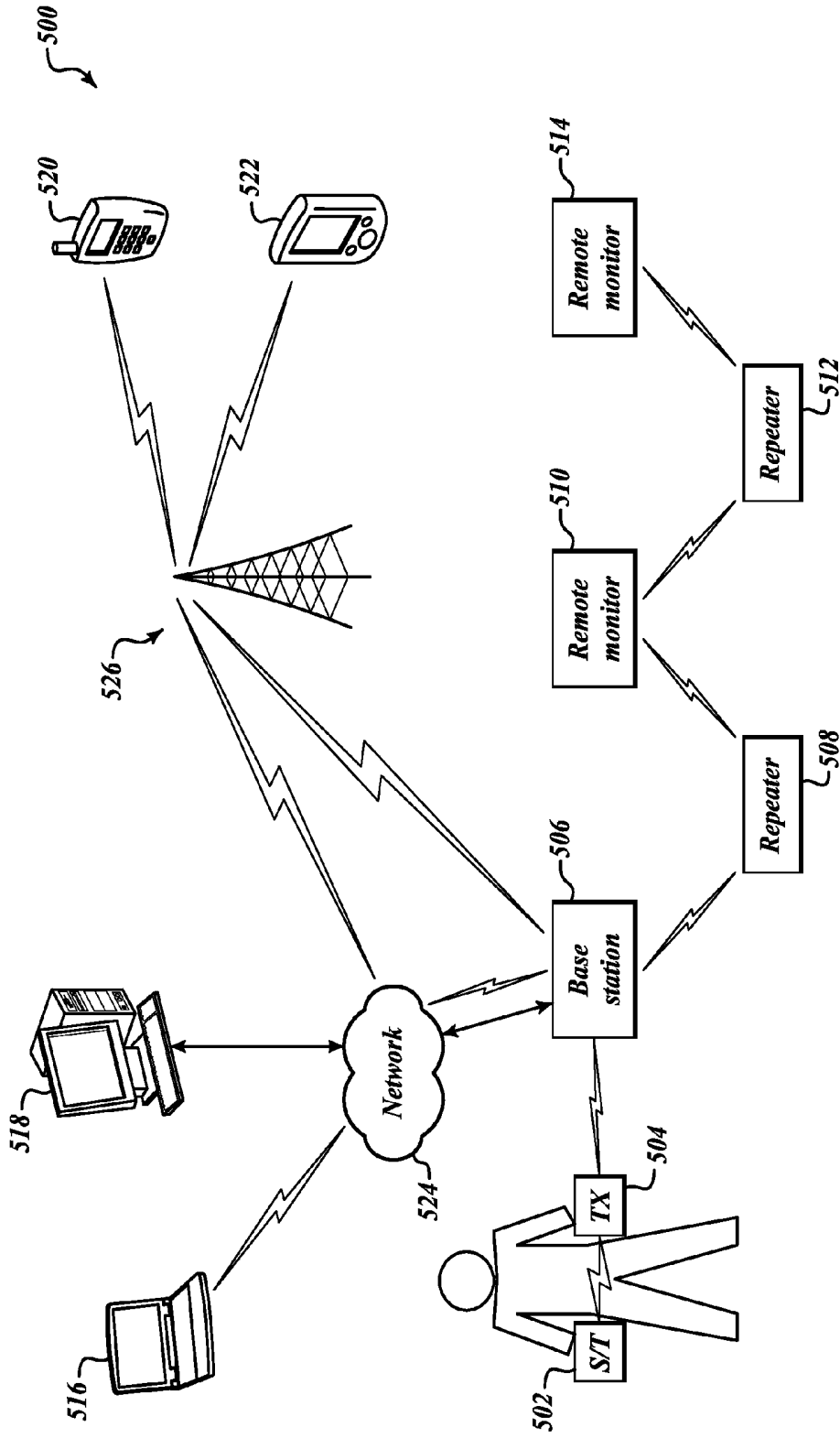
**FIG. 3**



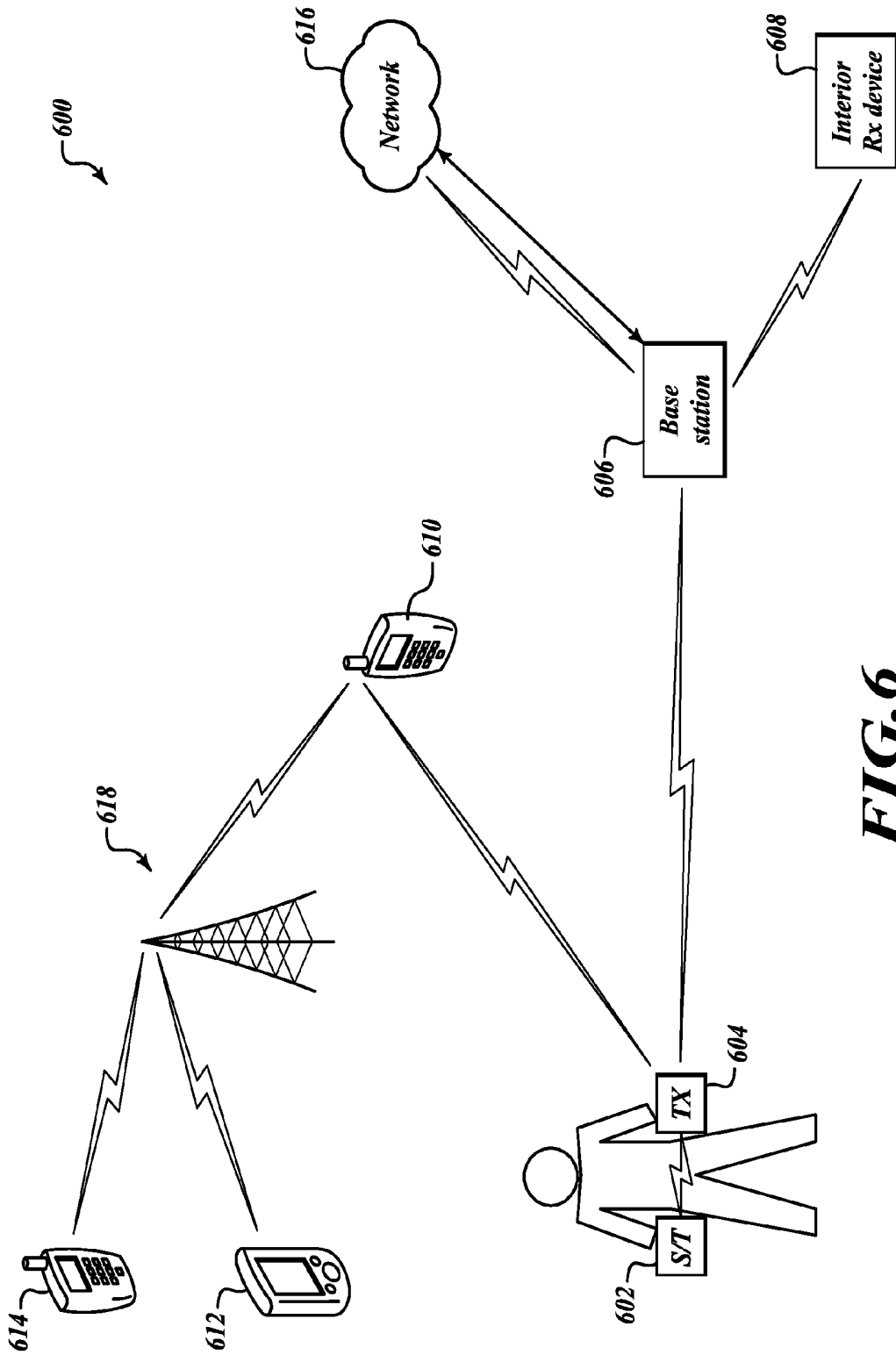
**FIG. 4A**



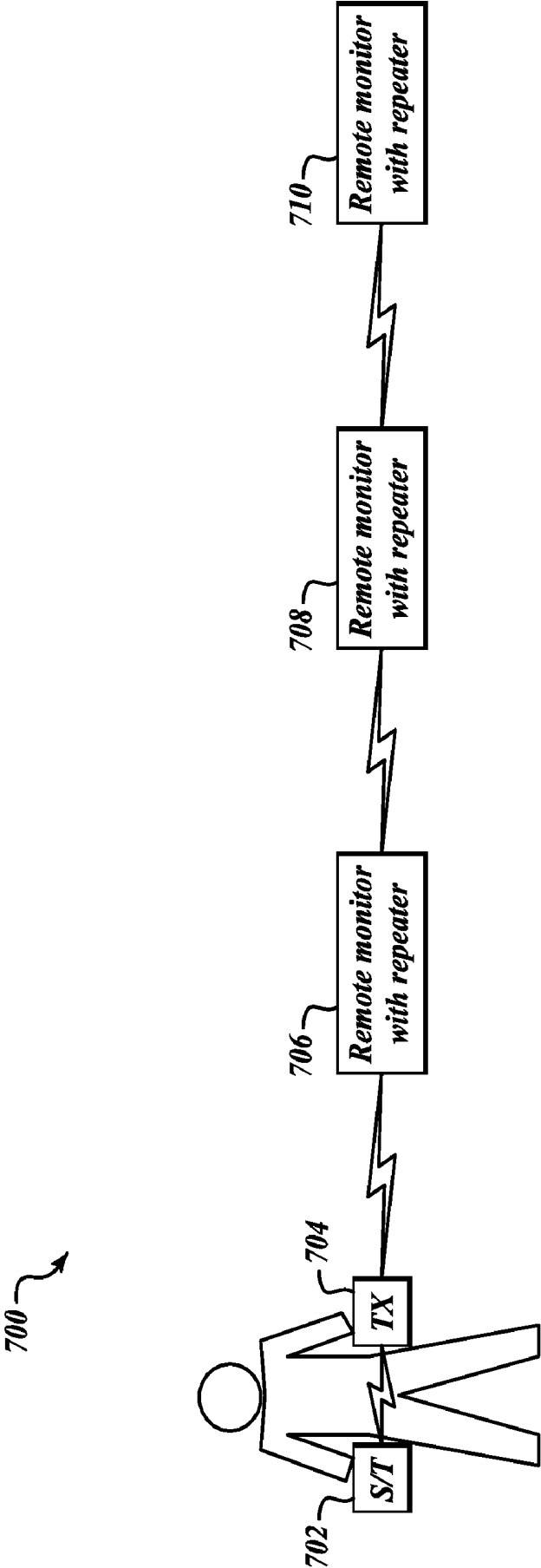
**FIG. 4B**



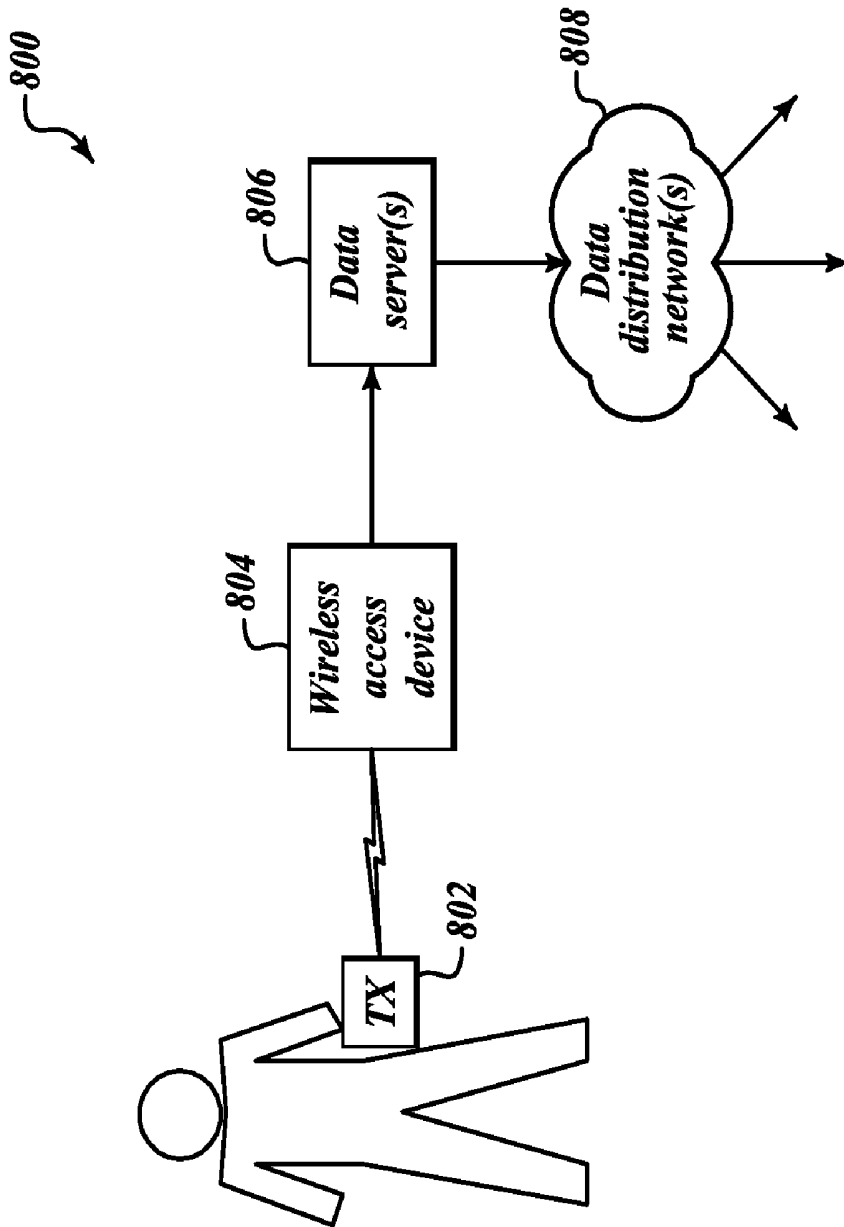
**FIG. 5**



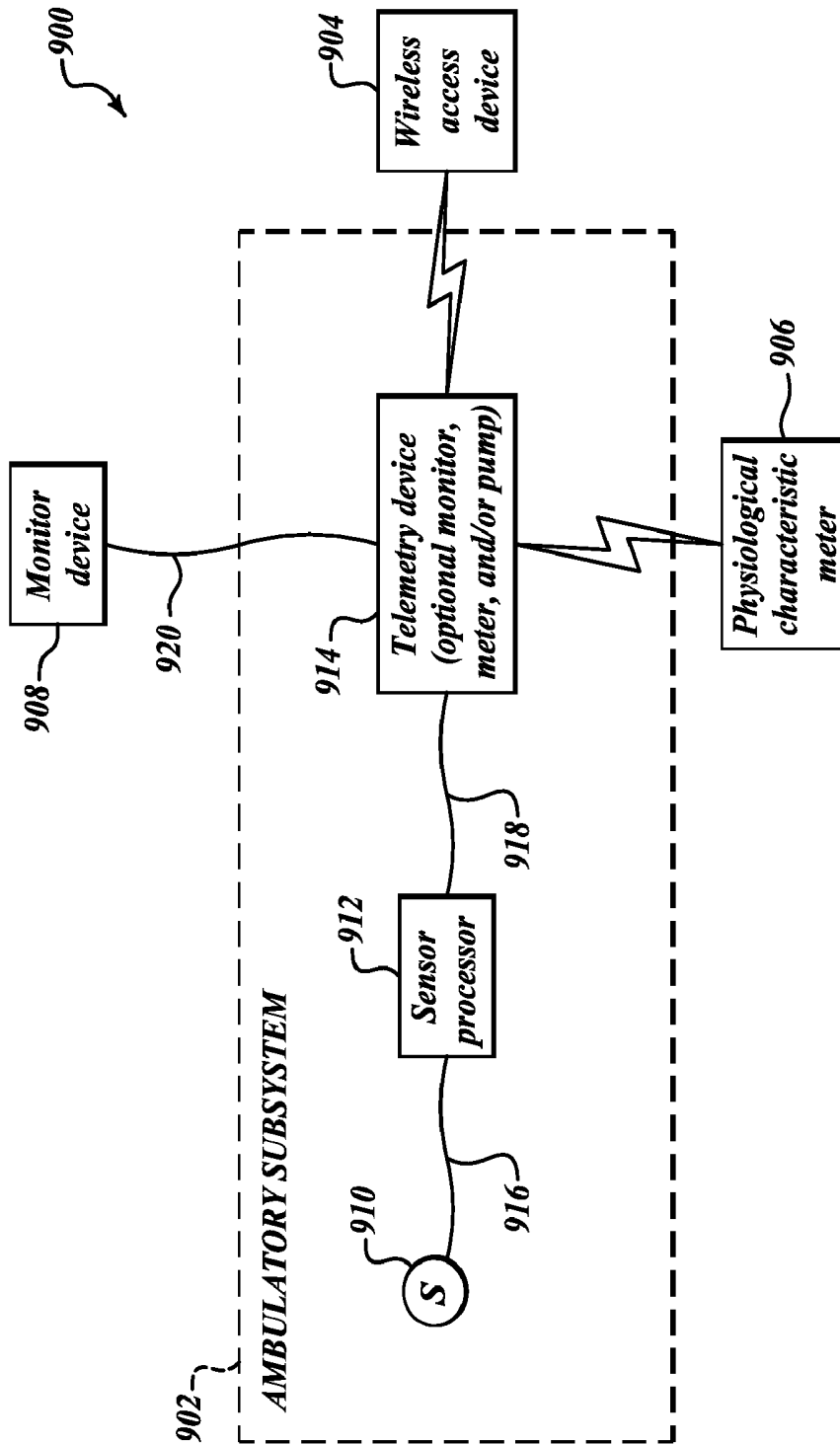
**FIG. 6**



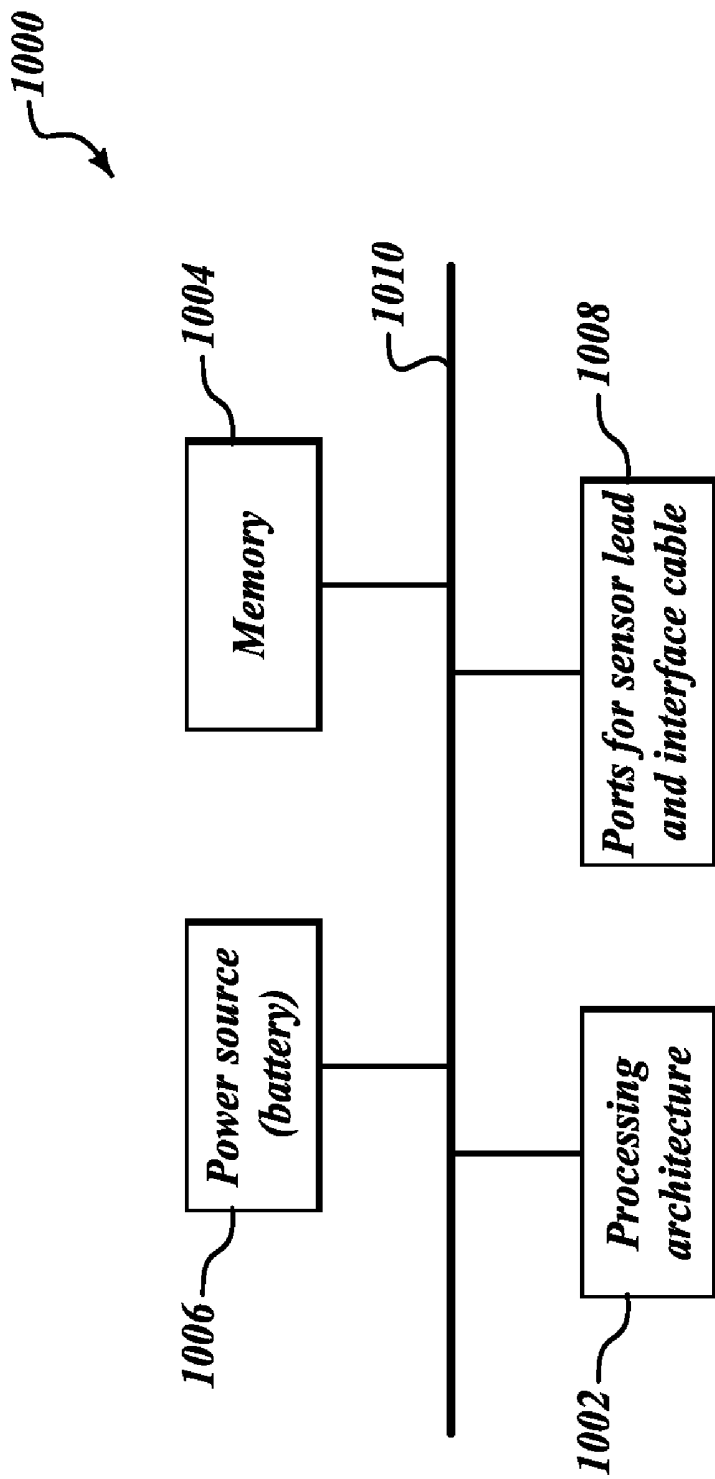
**FIG. 7**



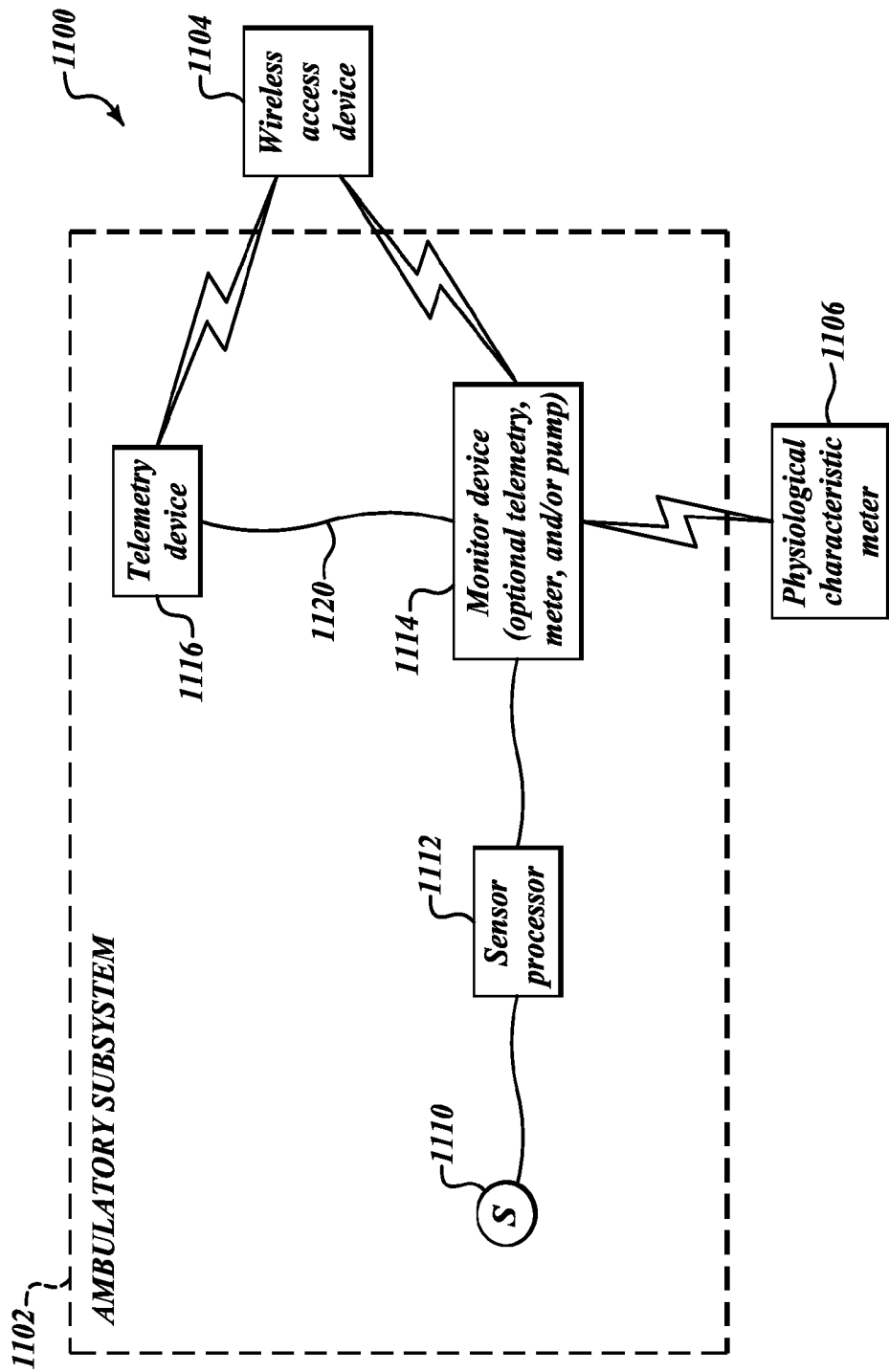
**FIG. 8**



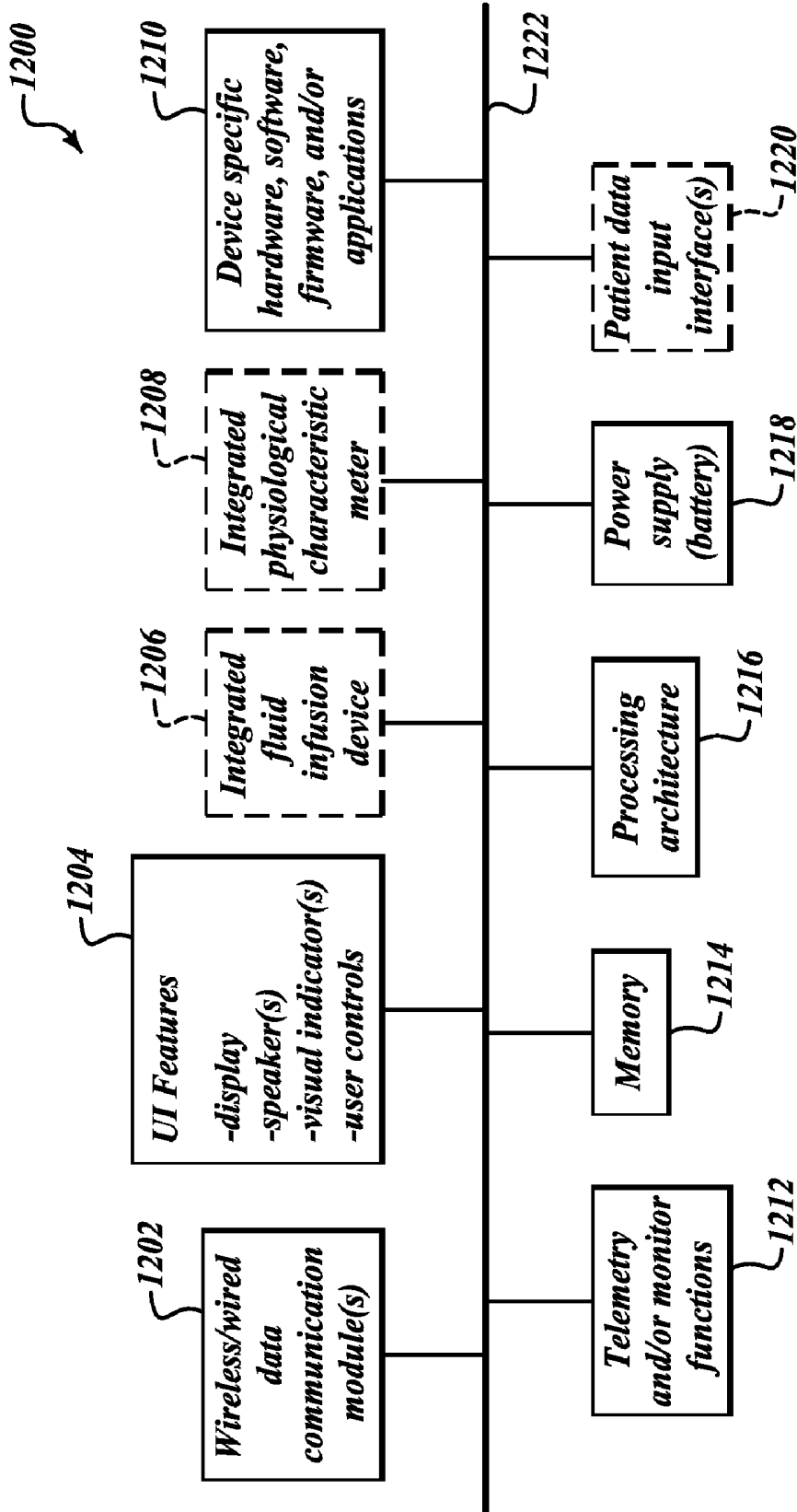
**FIG. 9**



**FIG. 10**



**FIG. 11**



**FIG. 12**

## REMOTE WIRELESS MONITORING, PROCESSING, AND COMMUNICATION OF PATIENT DATA

### TECHNICAL FIELD

[0001] Embodiments of the subject matter described herein relate generally to medical device systems that handle physiological patient data. More particularly, embodiments of the subject matter relate to the remote wireless monitoring and wireless communication of physiological patient data and/or data related to the operation or status of medical device system components that process physiological patient data.

### BACKGROUND

[0002] Portable medical devices having wireless data communication capabilities are becoming increasingly popular, especially for patients that have conditions that must be monitored on a continuous or frequent basis. For example, diabetics are usually required to modify and monitor their daily lifestyle to keep their body in balance, in particular, their blood glucose (“BG”) levels. Individuals with Type 1 diabetes and some individuals with Type 2 diabetes use insulin to control their BG levels. To do so, diabetics routinely keep strict schedules, including ingesting timely nutritious meals, partaking in exercise, monitoring glucose levels daily, and adjusting and administering insulin dosages accordingly.

[0003] The prior art includes a number of insulin pump systems that are designed to deliver accurate and measured doses of insulin via infusion sets (an infusion set delivers the insulin through a small diameter tube that terminates at a cannula inserted under the patient’s skin). In lieu of a syringe, the patient can simply activate the insulin pump to administer an insulin bolus as needed, for example, in response to the patient’s current glucose level. A patient can measure his glucose level using a glucose measurement device, such as a test strip meter, a continuous glucose measurement system, or the like. Glucose measurement devices use various methods to measure the glucose level of a patient, such as a sample of the patient’s blood, a sensor in contact with a bodily fluid, an optical sensor, an enzymatic sensor, or a fluorescent sensor. When the measurement device has generated a glucose measurement, the value is displayed on the measurement device. A continuous glucose monitoring system can monitor the patient’s glucose level in real time.

[0004] Insulin pumps and continuous glucose monitoring devices may also be configured to communicate with remote control devices, monitoring or display devices, BG meters, and other devices associated with such an infusion system. Individual devices within conventional infusion systems may be configured to support a limited amount of wired or wireless data communication to support the operation of the infusion system. For example, a continuous glucose monitoring sensor may include a wireless transmitter that communicates with a glucose monitor device or an insulin pump within the infusion system. Moreover, an insulin pump device itself may include a display and monitoring functions for pump-related and/or patient-related data and alarms.

### BRIEF SUMMARY

[0005] A system that performs remote wireless monitoring of a physiological characteristic of a patient (such as glucose level), an ambulatory telemetry subsystem suitable for use with such a system, and related operating methods are pro-

vided. The embodiments of the systems and methods provided herein facilitate the wireless transmission of patient data and/or operating status data of the system components within a local setting such as a dwelling or a building. Moreover, certain embodiments of the systems and methods provided herein facilitate transmission of patient data and/or operating status data of the system components via an external data communication network.

[0006] The above and other aspects may be carried out by an embodiment of a system for remote wireless monitoring of data for a patient. The system includes: an ambulatory sensor/transmitter subsystem configured to obtain measured values of a physiological characteristic of the patient, and to wirelessly transmit sensor signals that convey the measured values; a base station in wireless communication with the ambulatory sensor/transmitter subsystem, the base station being configured to wirelessly receive the sensor signals, generate base station signals in response to the sensor signals, and wirelessly transmit the base station signals; and a remote monitor in wireless communication with the base station. The remote monitor is configured to wirelessly receive the base station signals, and generate audio/visual indicia in response to the base station signals.

[0007] The above and other aspects may be carried out by another embodiment of a system for remote wireless monitoring of data for a patient. This system includes: an ambulatory telemetry device configured to wirelessly transmit physiological characteristic data for the patient; a base station in wireless communication with the ambulatory telemetry device, the base station being configured to wirelessly receive the physiological characteristic data, generate base station signals in response to the physiological characteristic data, and wirelessly transmit the base station signals; and a remote monitor in wireless communication with the base station. The remote monitor is configured to wirelessly receive the base station signals, and generate audio/visual indicia in response to the base station signals.

[0008] The above and other aspects may be carried out by another embodiment of a system for remote wireless monitoring of data for a patient. This system includes: a transmitting device configured to wirelessly transmit patient data signals that convey measured values of a physiological characteristic of the patient; and a plurality of wireless remote units for the transmitting device. The plurality of wireless remote units are cooperatively configured to operate as a wireless repeater network for the patient data signals. Moreover, the plurality of wireless remote units includes a wireless remote monitor in communication with the transmitting device, the wireless remote monitor being configured to wirelessly receive the patient data signals or retransmitted versions thereof, and generate audio/visual indicia of the measured values.

[0009] The above and other aspects may be carried out by an embodiment of a method for remote wireless monitoring of data for a patient. The method involves: measuring a physiological characteristic of the patient; wirelessly transmitting a sensor signal that conveys a measured value of the physiological characteristic; wirelessly receiving the sensor signal at a base station; generating a base station signal in response to the sensor signal; wirelessly transmitting the base station signal from the base station; and wirelessly receiving the base station signal, or a retransmitted version thereof, at a remote monitor.

**[0010]** The above and other aspects may be carried out by an embodiment of a wireless repeater for a system that remotely monitors patient data. The wireless repeater includes: a receiver configured to wirelessly receive sensor signals that convey measured values of a physiological characteristic of a patient; a transmitter coupled to the receiver, and configured to wirelessly retransmit the sensor signals; a signal analyzer coupled to the receiver, and configured to analyze characteristics and content of received signals; a wireless signal strength indicator coupled to the signal analyzer, and configured to generate audio/visual indicia of received signal strength while the wireless repeater is operating in a setup mode; and a data throughput indicator coupled to the signal analyzer, and configured to generate audio/visual indicia of wirelessly received data while the wireless repeater is operating in the setup mode.

**[0011]** The above and other aspects may be carried out by an embodiment of an ambulatory system for processing physiological characteristic data for a patient. The system includes: an ambulatory physiological characteristic sensor configured to generate electrical signals that are indicative of a physiological characteristic of the patient; a self-contained sensor processor module coupled to the ambulatory physiological characteristic sensor, the self-contained sensor processor module being configured to receive the electrical signals from the ambulatory physiological characteristic sensor, and generate measured values of the physiological characteristic from the electrical signals; and an ambulatory telemetry device coupled to the self-contained sensor processor module, the ambulatory telemetry device being configured to receive the measured values, generate sensor signals that convey the measured values, and wirelessly transmit the sensor signals for reception at a destination device.

**[0012]** The above and other aspects may be carried out by another embodiment of an ambulatory system for processing physiological characteristic data for a patient. This system includes: an ambulatory physiological characteristic sensor configured to generate electrical signals that are indicative of a physiological characteristic of the patient; a self-contained sensor processor module coupled to the ambulatory physiological characteristic sensor, the self-contained sensor processor module being configured to receive the electrical signals from the ambulatory physiological characteristic sensor, and generate measured values of the physiological characteristic from the electrical signals; and an ambulatory monitor device coupled to the self-contained sensor processor module, the ambulatory monitor device being configured to receive the measured values, and produce audio/visual indicia associated with the measured values.

**[0013]** The above and other aspects may be carried out by an embodiment of a system comprising an ambulatory physiological characteristic sensor, an ambulatory data receiver device, and a self-contained sensor processor module coupled between the ambulatory physiological characteristic sensor and the ambulatory data receiver device. The system performs an embodiment of a method for communicating physiological characteristic data for a patient. The method involves: generating, with the ambulatory physiological characteristic sensor, electrical signals that are indicative of a physiological characteristic of the patient; receiving the electrical signals at the self-contained sensor processor module; generating, with the self-contained sensor processor module, measured values

of the physiological characteristic from the electrical signals; and receiving the measured values at the ambulatory data receiver.

**[0014]** This summary is provided to introduce a selection of concepts in a simplified form that are further described below in the detailed description. This summary is not intended to identify key features or essential features of the claimed subject matter, nor is it intended to be used as an aid in determining the scope of the claimed subject matter.

#### BRIEF DESCRIPTION OF THE DRAWINGS

**[0015]** A more complete understanding of the subject matter may be derived by referring to the detailed description and claims when considered in conjunction with the following figures, wherein like reference numbers refer to similar elements throughout the figures.

**[0016]** FIG. 1 is a diagram that depicts an embodiment of a system for remote wireless monitoring of patient data as deployed within a dwelling;

**[0017]** FIG. 2 is a schematic representation of an embodiment of a sensor/transmitter unit suitable for use with a remote wireless monitoring system;

**[0018]** FIG. 3 is a schematic representation of a device that represents an embodiment of an ambulatory telemetry device, an embodiment of a base station, or an embodiment of a remote monitor suitable for use with a remote wireless monitoring system;

**[0019]** FIG. 4A is a schematic representation of an embodiment of a repeater suitable for use with a remote wireless monitoring system;

**[0020]** FIG. 4B is a perspective view of an embodiment of a repeater suitable for use with a remote wireless monitoring system;

**[0021]** FIG. 5 is a schematic representation of an alternate embodiment of a system for remote wireless monitoring of patient data;

**[0022]** FIG. 6 is a schematic representation of another alternate embodiment of a system for remote wireless monitoring of patient data;

**[0023]** FIG. 7 is a schematic representation of yet another alternate embodiment of a system for remote wireless monitoring of patient data;

**[0024]** FIG. 8 is a schematic representation of an embodiment of a system for communicating and processing physiological characteristic data for a patient;

**[0025]** FIG. 9 is a schematic representation of an embodiment of an ambulatory system for communicating and processing physiological characteristic data for a patient;

**[0026]** FIG. 10 is a schematic representation of an embodiment of a sensor processor module suitable for use with an ambulatory system for communicating and processing physiological characteristic data for a patient;

**[0027]** FIG. 11 is a schematic representation of an alternate embodiment of an ambulatory system for communicating and processing physiological characteristic data for a patient; and

**[0028]** FIG. 12 is a schematic representation of an embodiment of an ambulatory data receiver device suitable for use with an ambulatory system for communicating and processing physiological characteristic data for a patient.

#### DETAILED DESCRIPTION

**[0029]** The following detailed description is merely illustrative in nature and is not intended to limit the embodiments

of the invention or the application and uses of such embodiments. Furthermore, there is no intention to be bound by any expressed or implied theory presented in the preceding technical field, background, brief summary or the following detailed description.

**[0030]** Techniques and technologies may be described herein in terms of functional and/or logical block components, and with reference to symbolic representations of operations, processing tasks, and functions that may be performed by various computing components or devices. Such operations, tasks, and functions are sometimes referred to as being computer-executed, computerized, software-implemented, or computer-implemented. In practice, one or more processor devices can carry out the described operations, tasks, and functions by manipulating electrical signals representing data bits at memory locations in the system memory, as well as other processing of signals. The memory locations where data bits are maintained are physical locations that have particular electrical, magnetic, optical, or organic properties corresponding to the data bits. It should be appreciated that the various block components shown in the figures may be realized by any number of hardware, software, and/or firmware components configured to perform the specified functions. For example, an embodiment of a system or a component may employ various integrated circuit components, e.g., memory elements, digital signal processing elements, logic elements, look-up tables, or the like, which may carry out a variety of functions under the control of one or more microprocessors or other control devices.

**[0031]** When implemented in software or firmware, various elements of the systems described herein are essentially the code segments or instructions that perform the various tasks. The program or code segments can be stored in a processor-readable medium or transmitted by a computer data signal embodied in a carrier wave over a transmission medium or communication path. The “processor-readable medium” or “machine-readable medium” may include any medium that can store or transfer information. Examples of the processor-readable medium include an electronic circuit, a semiconductor memory device, a ROM, a flash memory, an erasable ROM (EROM), a floppy diskette, a CD-ROM, an optical disk, a hard disk, a fiber optic medium, a radio frequency (RF) link, or the like. The computer data signal may include any signal that can propagate over a transmission medium such as electronic network channels, optical fibers, air, electromagnetic paths, or RF links. The code segments may be downloaded via computer networks such as the Internet, an intranet, a LAN, or the like.

**[0032]** The following description refers to elements or nodes or features being “connected” or “coupled” together. As used herein, unless expressly stated otherwise, “connected” means that one element/node/feature is directly joined to (or directly communicates with) another element/node/feature, and not necessarily mechanically. Likewise, unless expressly stated otherwise, “coupled” means that one element/node/feature is directly or indirectly joined to (or directly or indirectly communicates with) another element/node/feature, and not necessarily mechanically.

**[0033]** For the sake of brevity, conventional techniques related to infusion system operation, insulin pump and/or infusion set operation, blood glucose sensing and monitoring, signal processing, data transmission, signaling, network control, and other functional aspects of the systems (and the individual operating components of the systems) may not be

described in detail here. Examples of infusion pumps and/or communication options may be of the type described in, but not limited to, U.S. Pat. Nos. 4,562,751; 4,685,903; 5,080,653; 5,505,709; 5,097,122; 6,554,798; 6,558,320; 6,558,351; 6,641,533; 6,659,980; 6,752,787; 6,817,990; and 6,932,584, which are herein incorporated by reference. Examples of glucose sensing and/or monitoring devices may be of the type described in, but not limited to, U.S. Pat. Nos. 6,484,045; 6,809,653; 6,892,085; and 6,895,263, which are herein incorporated by reference. Furthermore, the connecting lines shown in the various figures contained here are intended to represent example functional relationships and/or physical couplings between the various elements. It should be noted that many alternative or additional functional relationships or physical connections may be present in an embodiment of the described subject matter.

**[0034]** FIG. 1 is a diagram that depicts an embodiment of a system **100** for remote wireless monitoring of data within a dwelling **102**. As used here, a “dwelling” is any physical structure that can be occupied by a patient. This includes but is not limited to free-standing structures, multiple unit structures (e.g., duplex, condominium, townhouse, apartments), hotels or motels, boats, airplanes, spaceships, space stations, remote interstellar plant habitats, etc. For this embodiment, system **100** is configured to monitor at least one physiological characteristic of a patient **104**. System **100** may be alternatively or additionally configured to perform remote wireless monitoring of other data types, such as operating status data of one or more of components of system **100**. As used here, a “physiological characteristic” is any detectable, observable, or measurable quantity, parameter, condition, status, or the like, that is associated with the biological functioning of patient **104**. For example, glucose level, blood oxygen level, heart rate, and blood pressure represent different physiological characteristics that could be handled by system **100**. The various systems described here, including system **100**, are suitably configured to process and communicate glucose level data. However, embodiments of these systems can be alternately configured to support other monitored physiological characteristics.

**[0035]** System **100** generally includes, without limitation: an ambulatory sensor/transmitter subsystem **106**; a base station **108**; a repeater **110**; and a remote monitor **112**. FIG. 1 depicts patient **104**, ambulatory sensor/transmitter subsystem **106**, and base station **108** in a first room **114** of the dwelling **102**, depicts repeater **110** in a second room **116** of the dwelling **102**, and depicts remote monitor **112** in a third room **118** of the dwelling. FIG. 1 also depicts an operating state where ambulatory sensor/transmitter subsystem **106** is in wireless communication with base station **108**, which is in wireless communication with repeater **110**, which is in wireless communication with remote monitor **112**. In practice, the components of system **100** can be configured to wirelessly communicate with each other in any fashion (subject to transmit/receive ranges, supported data communication protocols, transmit power levels, and the like). Thus, under certain conditions ambulatory sensor/transmitter subsystem **106** could wirelessly communicate directly with repeater **110** and/or directly with remote monitor **112**. Likewise, under certain conditions base station **108** could wirelessly communicate directly with remote monitor **112**.

**[0036]** System **100** depicted in FIG. 1 represents a relatively simple implementation that employs one base station **108**, one repeater **110**, and one remote monitor **112**, all oper-

ating within the general confines of dwelling **102**. Ambulatory sensor/transmitter subsystem **106** wirelessly transmits sensor signals in compliance with a relatively short range wireless data communication protocol, such as WMTS or BLUETOOTH®, and base station **108** wirelessly receives the sensor signals in compliance with the same relatively short range wireless data communication protocol. In contrast, base station **108** wirelessly transmits base station signals in compliance with a relatively long range wireless data communication protocol, such as IEEE 802.11, and repeater **110** wirelessly receives the base station signals in compliance with the same relatively long range wireless data communication protocol. Likewise, repeater **110** wirelessly retransmits the base station signals in compliance with the same relatively long range wireless data communication protocol, and remote monitor **112** wirelessly receives the retransmitted base station signals in compliance with the same relatively long range wireless data communication protocol.

[0037] System **100** (and other embodiments described here) facilitates the remote wireless monitoring of patient data and/or system data at remote monitor **112**. System **100** provides the ability to remotely monitor the patient's glucose values continuously, and system **100** can be configured to automatically generate alarms for patient-triggered events (e.g., a hypoglycemic or a hyperglycemic event) and/or for operational device-triggered events. Notably, these alarms can be generated from: any location within the dwelling **102** using, for example, WiFi wireless data communication techniques; outside the dwelling **102** in an open area using cellular data communication techniques; or anywhere around the world using cellular and/or internet data communication techniques.

[0038] Ambulatory sensor/transmitter subsystem **106** is "ambulatory" in the sense that it is designed to be worn, carried, or attached to patient **104** in a manner that allows it to move about from place to place along with patient **104**. Ambulatory sensor/transmitter subsystem **106** is suitably configured to obtain measured values of a physiological characteristic (e.g., glucose level) of patient **104**, and to wirelessly transmit sensor signals that convey the measured values. Ambulatory sensor/transmitter subsystem **106** utilizes a relatively short range (low transmit power) wireless data communication protocol to transmit the sensor signals and/or other outgoing data. The short range wireless data communication protocol may be, without limitation: BLUETOOTH®; wireless medical telemetry (WMTS); amplitude modulated or frequency modulated radio communication using standard or proprietary protocols; or the like. The use of relatively low transmit power is preferred for use with a portable, battery powered, ambulatory sensor/transmitter subsystem **106**.

[0039] As described in more detail below, ambulatory sensor/transmitter subsystem **106** includes one or more components that cooperate to support the particular system deployment. For example, a first embodiment of ambulatory sensor/transmitter subsystem **106** includes a physiological characteristic sensor and a sensor transmitter coupled to the physiological characteristic sensor (the sensor transmitter may be combined with the physiological characteristic sensor as an integrated unit). In such an embodiment, the sensor transmitter wirelessly transmits the sensor signals for reception at a destination device.

[0040] FIG. 2 is a schematic representation of an embodiment of a sensor/transmitter unit **200** suitable for use with the first embodiment of ambulatory sensor/transmitter subsystem

**106**. Sensor/transmitter unit **200** includes, without limitation, a physiological characteristic sensor **202**, a sensor transmitter **204**, and a power unit **206** coupled to physiological characteristic sensor **202** and to sensor transmitter **204**. For this example, sensor/transmitter unit **200** also includes a sensor signal processor (SSP) **208**—the dashed lines in FIG. 2 indicate the optional nature of SSP **208**. Power unit **206**, which may be realized as a replaceable or rechargeable battery, or as a non-replaceable battery in a disposable transmitter implementation, provides the operating power for physiological characteristic sensor **202**, sensor transmitter **204**, and SSP **208**.

[0041] For this example, physiological characteristic sensor **202** is used for the continuous detection of patient glucose levels. Suitable sensor types include, without limitation: subcutaneous interstitial fluid contacting sensors; direct blood contacting sensors; non-invasive sensors; or ocular fluid contacting sensors. In practice, physiological characteristic sensor **202** is configured to generate electrical signals having voltages and/or currents that are indicative of the glucose level of the patient. For the first embodiment of ambulatory sensor/transmitter subsystem **106**, SSP **208** processes these raw electrical signals into sensor signals that convey the measured glucose values. Thereafter, sensor transmitter **204** wirelessly transmits the sensor signals. In practice, SSP **208** converts the raw sensor data (i.e., electrical signals) as detected by physiological characteristic sensor **202**, and derives glucose values for the patient from the raw electrical sensor signals. Other information may be transmitted from the ambulatory sensor/transmitter system, such as, without limitation: alarm commands; error codes; warnings; device ID; and/or patient ID. The ambulatory sensor/transmitter subsystem may contain algorithms to analyze the physiologic characteristic, such as, without limitation: high or low glucose levels; rising or falling glucose levels; predicted high or low glucose levels; and the like. These algorithms can generate alert or alarm messages or commands for transmission to other devices. Alternatively, the alarm algorithms may reside in another device such as the base station, remote monitor, or a repeater.

[0042] Sensor transmitter **204** is configured to wirelessly transmit the sensor signals to an appropriate destination device, such as base station **108**. In certain embodiments, sensor transmitter **204** is a self contained transceiver that is attached to physiological characteristic sensor **202**. Sensor transmitter **204** is capable of wirelessly transmitting: the raw unprocessed electrical sensor signals (if SSP **208** is not used); the processed sensor signals (if SSP **208** is embodied in sensor/transmitter unit **200**); sensor operational status data; operational status data for SSP **208**, if implemented; and operational power level of power unit **206**. This information can be continuously transmitted to remote monitor **112** via base station **108** and/or repeater **110**. Sensor transmitter **204** can be designed as a modular unit to facilitate the ability to interchange various types of wireless radio frequency (RF) units, thereby allowing sensor transmitter **204** to be configured for operation on different radio frequencies per the host country requirements and/or the use of various types of wireless communication technologies (e.g., BLUETOOTH®, IEEE 802.11, infrared, cellular, etc).

[0043] A second embodiment of ambulatory sensor/transmitter subsystem **106** includes a physiological characteristic sensor, a sensor transmitter coupled to the physiological characteristic sensor, and a telemetry device in wireless commu-

nication with the sensor transmitter. In this embodiment, the sensor transmitter is configured to wirelessly transmit sensor origination signals, and the telemetry device is configured to wirelessly receive the sensor origination signals, generate the sensor signals from the sensor origination signals, and wirelessly transmit the sensor signals for reception at a destination device. This second embodiment of ambulatory sensor/transmitter subsystem 106 is desirable when the wireless transmit range of the sensor transmitter is limited—the telemetry device has a longer wireless transmit range than the sensor transmitter. The second embodiment of ambulatory sensor/transmitter subsystem 106 may utilize a sensor/transmitter unit (such as sensor/transmitter unit 200) in conjunction with a suitably configured telemetry device. In such an embodiment, an SSP may be implemented in the sensor/transmitter unit, the telemetry device, or in a distributed manner in both. Alternatively, the SSP may be implemented elsewhere in system 100. The raw electrical sensor signals can be transmitted by sensor transmitter 204 to the telemetry device, or the raw electrical sensor signals can be initially processed by SSP 208 prior to transmission by sensor transmitter 204.

[0044] FIG. 3 is a schematic representation of a device 300 that represents an embodiment of an ambulatory telemetry device suitable for use with system 100. As mentioned above, the second embodiment of ambulatory sensor/transmitter subsystem 106 includes an ambulatory telemetry device together with sensor/transmitter unit 200. For the illustrated embodiment, device 300 includes: wireless/wired data communication module(s) 302; device specific hardware, software, firmware, and/or applications 304; a display element 306; one or more visual indicators 308; one or more user interface (UI) features 310; one or more speakers and/or transducers 312; a suitable amount of memory 314; a processing architecture 316; and a rechargeable or replaceable power supply, such as a battery 318. The elements of device 300 may be coupled together via a bus 320 or any suitable interconnection architecture.

[0045] Processing architecture 316 may be implemented or performed with a general purpose processor, a content addressable memory, a digital signal processor, an application specific integrated circuit, a field programmable gate array, any suitable programmable logic device, discrete gate or transistor logic, discrete hardware components, or any combination designed to perform the functions described here. A processor may be realized as a microprocessor, a controller, a microcontroller, or a state machine. Moreover, a processor may be implemented as a combination of computing devices, e.g., a combination of a digital signal processor and a microprocessor, a plurality of microprocessors, one or more microprocessors in conjunction with a digital signal processor core, or any other such configuration. Notably, ambulatory telemetry device 300 may include an optional SSP 322 (the dashed lines in FIG. 3 indicate its optional nature), which may be implemented in processing architecture 316. SSP 322 has the characteristics and functionality of SSP 208 (see FIG. 2).

[0046] Memory 314 may be realized as RAM memory, flash memory, EPROM memory, EEPROM memory, registers, a hard disk, a removable disk, a CD-ROM, or any other form of storage medium known in the art. In this regard, memory 314 can be coupled to processing architecture 316 such that processing architecture 316 can read information from, and write information to, memory 314. In the alterna-

tive, memory 314 may be integral to processing architecture 316. As an example, processing architecture 316 and memory 314 may reside in an ASIC.

[0047] Device-specific hardware, software, firmware, and/or applications 304 may vary from one embodiment of device 300 to another. For example, an ambulatory telemetry device can be implemented in different formats to address the needs of the particular application. In this regard, an ambulatory telemetry device may be configured as a telemetry-only unit, a telemetry unit combined and integrated with an ambulatory monitor device, a telemetry unit combined and integrated with an ambulatory fluid infusion device (e.g., an insulin pump), a telemetry unit combined and integrated with an ambulatory monitor device and an ambulatory fluid infusion device, etc. Thus, a combined ambulatory telemetry/monitor device is configured to perform wireless data telemetry, and produce audio/visual indicia associated with the measured values of the physiological characteristic, where such indicia may represent, without limitation: a text or graphical display of the measured values; alarms or alerts triggered by the measured values; patient instructions; or operating status data for one or more components of the remote wireless monitoring system. On the other hand, a combined ambulatory telemetry/pump device is configured to perform wireless data telemetry, and deliver fluid (such as insulin) to the patient as needed. Accordingly, device-specific hardware, software, firmware, and/or applications 304 will support telemetry functions and features, monitor functions and features (when device 300 includes monitor device functionality), and fluid infusion pump functions and features (when device 300 includes fluid infusion device functionality). Of course, device-specific hardware, software, firmware, and/or applications 304 may additionally or alternatively support other features and functionality, such as, without limitation: physiological characteristic meter functionality; alarm clock functionality; or the like. In practice, certain portions or aspects of device-specific hardware, software, firmware, and/or applications 304 may be implemented in one or more of the other blocks depicted in FIG. 3.

[0048] An embodiment of device 300 may employ any number of wireless and/or wired data communication modules 302. These data communication modules are suitably configured to support wireless/wired data communication (unidirectional or bidirectional, depending upon the particular implementation) between device 300 and other devices in the remote wireless monitoring system, for example, sensor transmitter 204 (see FIG. 2), base station 108, repeater 110, or remote monitor 112 (see FIG. 1).

[0049] A wireless data communication module is configured to support one or more wireless data communication protocols. Any number of suitable wireless data communication protocols, techniques, or methodologies may be supported by ambulatory telemetry device 300, including, without limitation: RF; IrDA (infrared); BLUETOOTH®; ZigBee (and other variants of the IEEE 802.15 protocol); IEEE 802.11 (any variation); IEEE 802.16 (WiMAX or any other variation); Direct Sequence Spread Spectrum; Frequency Hopping Spread Spectrum; cellular/wireless/cordless telecommunication protocols; wireless home network communication protocols; paging network protocols; magnetic induction; satellite data communication protocols; wireless hospital or health care facility network protocols such as those operating in the WMTS bands; GPRS; and proprietary wireless data communication protocols such as variants of Wireless USB. In an

embodiment of device **300**, a wireless data communication module may include or be realized as hardware, software, and/or firmware, such as an RF front end, a suitably configured radio module (which may be a stand alone module or integrated with other or all functions of the device), a wireless transmitter, a wireless receiver, a wireless transceiver, an infrared sensor, an infrared diode and sensor, an electromagnetic transducer, or the like. Moreover, device **300** may include one or more antenna arrangements that cooperate with the wireless data communication module.

[0050] A wired data communication module supports data transfer over a cable, a wired connection, or other physical link. A wired data communication module is configured to support one or more wired/cabled data communication protocols. Any number of suitable data communication protocols, techniques, or methodologies may be supported by device **300**, including, without limitation: Ethernet; home network communication protocols; USB; IEEE 1394 (Firewire); hospital network communication protocols; and proprietary data communication protocols. In an embodiment of device **300**, a wired data communication module may include or be realized as hardware, software, and/or firmware, such as a suitably configured and formatted port, connector, jack, plug, receptacle, socket, adaptor, or the like.

[0051] Device **300** may also be designed to accommodate UI features **310** that allow the user to control the operation of device **300** and/or other devices within the system. UI features **310** may include a keypad, keys, buttons, switches, knobs, a touchpad, a joystick, a pointing device, a virtual writing tablet, or any device, component, or function that enables the user to select options, input information, or otherwise control the operation of device **300** and/or other devices within the system.

[0052] Display element **306** is suitably configured to enable device **300** to render and display information such as measured values of the physiological characteristic, alarms, device status information, clock/calendar data, and/or other information and data received or processed by device **300**. Display element **306** is optional because certain embodiments of an ambulatory telemetry device need not display any information or data to the patient. Notably, the specific configuration, operating characteristics, size, resolution, and functionality of display element **306** can vary depending upon the practical implementation of device **300**. For example, display element **306** may be implemented using a liquid crystal display (LCD), a plasma monitor, a stylus writing screen, a touchpad, or the like.

[0053] In addition to (or in lieu of) display element **306**, device **300** may include one or more visual indicators **308**, e.g., lights, mechanically actuated buttons, or the like. Visual indicators **308** can be utilized to generate a visually perceptible representation of an alarm, a reminder, an operating status of device **300** (or another device within the wireless remote monitoring system), a measured value of a physiological characteristic, or other visible indicia associated with the operation of device **300** and/or the operation of other devices within the remote wireless monitoring system.

[0054] Device **300** may also include one or more speakers or transducers **312**, which serve as audio indicator(s). Speakers **312** can be utilized to generate audible alarms, reminder tones, audio messages, media clips, or other audible indicia associated with the operation of device **300** and/or the operation of other devices within the remote wireless monitoring system. For example, speakers **312** can be utilized to generate

an audible representation of an operating status of device **300** (or another device within the wireless remote monitoring system), a measured value of a physiological characteristic, or the like.

[0055] Referring again to FIG. 1, base station **108** is a portable, tabletop, or wall mounted device that is preferably located in a room where patient **104** spends a significant amount of time (e.g., a bedroom or an office). The general configuration and functionality of device **300** (see FIG. 3) may also be utilized to implement base station **108**. For use as a base station, however, certain components of device **300** (e.g., wireless/wired data communication modules **302**, and device specific hardware, software, firmware, and/or applications **304**) may need to be specifically configured to support the desired operation of base station **108**.

[0056] Base station **108** represents a host device for system **100**, and more than one base station **108** could be supported by system **100**. Base station **108** is capable of being powered from an external power supply, such as a standard AC wall outlet, or from an internal battery. In certain embodiments, base station **108** uses discrete LED indicators to indicate the operational status and condition of base station **108**, an alphanumeric display element to display the patient's glucose values, patient alarms, system alarms, etc., an audio speaker configured to emit audible alarm tones and other sounds, and UI features for operation of base station **108**.

[0057] Base station **108** is suitably configured to wirelessly receive sensor signals transmitted by ambulatory sensor/transmitter subsystem **106**, generate base station signals in response to the sensor signals, and wirelessly transmit the base station signals. A base station signal may convey or represent the measured values, alarm notifications, reminder notifications, device status data, or the like. An embodiment of base station **108** that utilizes an SSP will process raw electrical sensor signals (received from ambulatory sensor/transmitter subsystem **106**) to derive the usable glucose values of the patient. The memory of base station **108** can be used for the storage and trending of the patient's glucose values, glucose alarm events, and system alarm events.

[0058] Certain embodiments of base station **108** include wireless and/or wired communication modules that are configured to facilitate data communication using an external communication network, e.g., a cellular telecommunication network, a wide area network, the Internet, a local area network, or the like. In contrast to ambulatory sensor/transmitter subsystem **106**, base station **108** is suitably configured to wirelessly transmit its base station signals using a relatively long range wireless data communication protocol. The long range wireless data communication protocol may be, without limitation: any variant of IEEE 802.11; wireless USB; or the like. This extended range increases the likelihood that base station **108** will be able to wirelessly communicate with repeater **110** and/or remote monitor **112**.

[0059] In practical embodiments, the data communication modules of base station **108** may include multipurpose PCM-CIA ports that accommodate the insertion of various types of wireless communication cards for the wireless communication of the patient's glucose values and system operational status conditions to other devices. These other devices include, without limitation: repeater **110**; remote monitor **112**; or broadband wireless communication devices (e.g., a cellular telecommunication device, a personal digital assistant, or a mobile computing device).

[0060] For the embodiment depicted in FIG. 1, repeater 110 is in wireless communication with base station 108 (to wirelessly receive data from base station 108) and with remote monitor 112 (to wirelessly transmit data to remote monitor 112). Alternatively or additionally, repeater 110 could communicate directly with ambulatory sensor/transmitter subsystem 106. Repeater 110 is suitably configured to wirelessly receive base station signals generated by base station 108 and retransmit the base station signals to remote monitor 112, which receives the retransmitted versions of the base station signals. In this manner, repeater 110 functions to extend the transmission range of base station 108. In certain embodiments, repeater 110 is implemented as a small and self-contained unit that can be mounted on a wall, plugged into a standard AC wall socket, or placed on a table, shelf, mantle, bookcase, or the like.

[0061] FIG. 4A is a schematic representation of an embodiment of a repeater 400 suitable for use with a remote wireless monitoring system such as system 100, and FIG. 4B is a perspective view of an embodiment of repeater 400. For the illustrated embodiment, repeater 400 includes: a wireless receiver 402; an alarm snooze control 404; an enable/disable button 406; a display element 408; one or more audio/visual indicators 410; a wireless transmitter 412; a suitable amount of memory 414; a processing architecture 416; and a power supply 418. The elements of repeater 400 may be coupled together via a bus 420 or any suitable interconnection architecture. Power supply 418 can be a rechargeable or replaceable backup power supply, such as a battery. Alternatively or additionally, power supply 418 can be configured to obtain operating power from a standard AC outlet.

[0062] Processing architecture 416 and memory 414 may be implemented or performed in the manner described above for processing architecture 316 and memory 314, respectively. Notably, repeater 400 may include a suitably configured signal analyzer 422, which may be implemented in processing architecture 416. The operation of signal analyzer 422 will be described in more detail below.

[0063] Repeater 400 utilizes wireless receiver 402 to wirelessly receive signals from base station 108 (or from other devices in system 100), and utilizes wireless transmitter 412 to wirelessly retransmit the received signals to one or more destination devices in system 100. In practice, wireless receiver 402 and wireless transmitter 412 may be implemented as one or more wireless data communication modules as generally described above in the context of wireless/wired data communication modules 302. Although not depicted in FIG. 4A, repeater 400 may also include one or more wired data communication modules.

[0064] Display element 408 is an optional element of repeater 400 (the dashed lines in FIG. 4A indicates the optional nature of display element 408). Display element 408 is optional because certain embodiments of repeater 400 need not display any information or data to the user. Display element 408, which can be generally configured as described above for display element 306, is suitably configured to enable repeater 400 to render and display information such as measured values of the physiological characteristic, alarms, device status information, clock/calendar data, and/or other information and data received or processed by repeater 400.

[0065] Signal analyzer 422 is suitably configured to analyze characteristics and/or content of received signals obtained by repeater 400. For this particular embodiment, signal analyzer 422 obtains or determines the received signal

strength of received signals, and obtains or determines a data throughput quantifier associated with received signals. Signal analyzer 422 may indicate the received signal strength using any suitable technique or algorithm, and the manner in which the received signal strength is indicated may be simple or complex in nature. For instance, a simple methodology might compare the received signal strength to a threshold value, while a complex methodology might generate the actual signal strength values. Regarding data throughput, signal analyzer 422 may simply indicate whether or not any data of interest is being conveyed in the received signals. Alternatively, signal analyzer 422 may generate a data throughput value or quantity that indicates the amount of data currently passing through repeater 400.

[0066] Audio/visual indicators 410 may be generally configured as described above in the context of visual indicators 308 and speakers 312. Certain embodiments of repeater 400 use audio/visual indicators 410 as a wireless signal strength indicator, which is configured to generate audio and/or visual indicia of received signal strength while repeater 400 is operating. Thus, audio/visual indicators 410 are coupled to signal analyzer 422 such that they can be activated in response to the received signal strength determined by signal analyzer 422. Signal analyzer 422 and the signal strength indicator can be activated while repeater is operating in a setup mode to facilitate proper placement of repeater 400 within the intended system environment. While in the setup mode, a transmitting device generates a test signal for repeater 400, and the signal strength indicator will indicate (using a tone, a visual indicator, etc.) whether repeater 400 is receiving the test signal. Using the signal strength indicator the user can position repeater 400 in an appropriate location that maintains wireless coverage.

[0067] Certain embodiments of repeater 400 use audio/visual indicators 410 as a data throughput indicator, which is configured to generate audio and/or visual indicia of wirelessly received data while repeater 400 is operating. Thus, audio/visual indicators 410 are coupled to signal analyzer 422 such that they can be activated in response to the data throughput information determined by signal analyzer 422. Signal analyzer 422 and the data throughput indicator can be activated while repeater is operating in a setup mode to test whether repeater 400 is actually receiving data as intended. While in the setup mode, a transmitting device generates a test signal that conveys test data for repeater 400, and the data throughput indicator will indicate (using a tone, a visual indicator, etc.) whether repeater 400 is actually receiving the test data.

[0068] Certain embodiments of repeater 400 use audio/visual indicators 410 as an alarm indicator, which is configured to generate audio and/or visual alarms in response to received signals. In this regard, audio/visual indicators 410 are coupled to signal analyzer 422 such that they can be activated in response to received sensor signals that convey measured glucose values of the patient. These alarms can be triggered by the measured values, operating status information for repeater 400 or other devices in the system, low battery status, or any alarm-generating event described here in the context of a monitor device. Notably, repeater 400 need not provide any additional information related to the type of alarm, the alarm-triggering values, or other alarm-related details. Such additional information can be displayed at the source device and/or at a remote monitor in the system.

[0069] Embodiments of repeater **400** that include an alarm indicator may also employ alarm snooze control **404**, which is configured to disable audio and/or visual alarms generated by repeater **400**. Alarm snooze control **404** can be implemented as a hardware feature, a soft button (i.e., a graphical user interface feature), or any UI element that is designed to respond to a user-initiated command. When a user activates alarm snooze control **404**, the alarm is silenced at repeater **400**. Although not a requirement, repeater **400** may be configured to transmit, in response to the user activation of alarm snooze control **404**, an alarm snooze signal to other devices in the system. Furthermore, the repeater may employ an alarm cancel control as described in more detail herein.

[0070] Referring to FIG. 4B, alarm snooze control **404** may be an illuminated snooze button that illuminates when an alarm is active. The embodiment shown in FIG. 4B includes an indicator **410a** that when lit indicates that repeater **400** is in communication with the network, an indicator **410b** that when lit indicates that repeater **400** is powered on, and an indicator **410c** that when lit indicates that the user device is in communication with the network. This embodiment also includes an audio indicator **410d** (e.g., a speaker or a transducer) that can be used to generate audible alarms, reminders, and/or notifications.

[0071] Repeater **400** and/or other components in the wireless remote monitoring system can generate an out-of-range alarm, which indicates that the ambulatory sensor/transmitter subsystem has lost wireless connectivity. Enable/disable button **406** is a UI feature of repeater **400** that, when activated by the user, temporarily disables alarms generated by the system for that particular user. This feature allows the patient to leave the premises without triggering an out-of-range alarm. Some embodiments may also utilize enable/disable button **406** to activate alarms that have been temporarily disabled by the user. Alternatively, alarms may be reactivated automatically upon detection of the ambulatory sensor/transmitter subsystem. In certain embodiments, automatic reactivation is enabled after a designated time delay. It should be appreciated that an equivalent enable/disable feature may also be supported by the ambulatory sensor/transmitter subsystem, base stations, and remote monitors.

[0072] Referring again to FIG. 1, remote monitor **112** is preferably implemented as a small transportable device which can take several forms—from a custom designed device for use within an enclosed dwelling, to an off the shelf smart phone that contains appropriate software applications that support operation in system **100**. In this regard, remote monitor **112** can be in the form of a mobile computing device (e.g., a laptop computer), a mobile communication device (e.g., a cellular telephone, a personal digital assistant, or a portable video game device), or a bedside device that is small enough to fit on a nightstand.

[0073] Remote monitor **112** can be suitably configured to support a number of monitor-related operations, functions, and features. In this regard, remote monitor **112** (and other devices and components in system **100**) may be implemented and configured as needed for the given deployment. For example, system **100** and the devices therein may employ the techniques, architectures, and technologies described in: U.S. patent application Ser. No. 11/413,268, publication number \_\_\_\_\_ (docket number 009.5003); U.S. patent application Ser. No. 11/583,344, publication number \_\_\_\_\_ (docket number 009.5005×1); U.S. patent application Ser. No. 11/671,174, publication number \_\_\_\_\_ (docket number

009.5005×2); and U.S. patent application Ser. No. 11/757,153, publication number \_\_\_\_\_ (docket number 009.5008); which are all incorporated herein by reference.

[0074] Remote monitor **112** is configured to wirelessly receive base station signals, repeater signals, and/or sensor SSP signals, (or retransmitted versions thereof) and, in response to the received base station signals, generate appropriate audio/visual indicia. This indicia may include an audio and/or visual representation of the measured values of the monitored physiological characteristic, an audio and/or visual representation of an alarm triggered by the measured values, an audio and/or visual representation of an operating status of ambulatory sensor/transmitter subsystem **106**, an audio and/or visual representation of an operating status of base station **108**, or the like. An embodiment of remote monitor **112** that utilizes an SSP will process raw electrical sensor signals (received from ambulatory sensor/transmitter subsystem **106**, base station **108**, or repeater **110**) to derive the usable glucose values of the patient. The memory of remote monitor **112** can be used for the storage and trending of the patient's glucose values, glucose alarm events, and system alarm events.

[0075] More specifically, remote monitor **112** provides the ability to: remotely monitor the patient's glucose data continuously; display the glucose data either continuously, upon demand, or automatically upon detection of alarm event; enable the user to set upper and lower glycemic alarm limits; and upon the detection of an alarm event, trigger audible and/or visual alarms at remote monitor **112**, thereby alerting the user to a patient and/or device alarm event. Remote monitor **112** also allows the user to view retrospective trend data in various formats, and performs other functions depending upon the application program. Upon the detection of a patient alarm (e.g., a hypoglycemic or hyperglycemic alarm event) and/or operational device alarm condition, remote monitor **112** triggers an alarm, and provides a displayed readout of the patient glucose value and upper and lower alarm limit values.

[0076] The general configuration and functionality of device **300** (see FIG. 3) may also be utilized to implement remote monitor **112**. For use as a remote monitor, however, certain components of device **300** (e.g., UI features **310**, display element **306**, and device specific hardware, software, firmware, and/or applications **304**) may need to be specifically configured to support the desired operation of remote monitor **112**.

[0077] A network architecture such as that utilized by system **100** allows certain processing tasks and intelligence to be located in different physical components as needed or as desired. As one non-limiting example, the processing logic utilized to perform calibration of glucose measurements and the processing logic utilized to generate glucose level alarms may reside at one or more of the following components: ambulatory sensor/transmitter subsystem **106**; base station **108**; repeater **110**; remote monitor **112**. This type of flexibility allows a user or a network administrator to configure system **100** in a manner that best suits the needs of the particular deployment.

[0078] System **100** depicted in FIG. 1 represents only one possible implementation of a wireless remote monitoring system for patient data. FIGS. 5-7 depict alternate embodiments of such a system. The configuration and operation of some components in these alternate systems are similar to that described above in the context of system **100** and, there-

fore, the individual components will not be redundantly described with reference to FIGS. 5-7.

[0079] System 100 is a “local” system in that all of its components reside within dwelling 102. Moreover, the components of system 100 do not communicate with any external devices or external data communication networks. In contrast, FIG. 5 depicts a system 500 that contemplates data communication with one or more external devices. System 500 includes local devices, which may reside in a dwelling/building, and external devices that need not reside in the dwelling/building. The local devices include, without limitation: an ambulatory sensor/transmitter subsystem 502; an ambulatory telemetry device 504; a base station 506; a repeater 508; a remote monitor 510; a repeater 512; and a remote monitor 514. In this embodiment, the external devices include, without limitation: a laptop computer 516; a desktop computer 518; a remote monitor 520 having the form of a mobile communication device (e.g., a cellular telephone); and a remote monitor 522 having the form of a mobile computing device (e.g., a personal digital assistant, a smart phone, or a palmtop computer). Another suitable external device might be a remote monitor that displays data on a television screen. Such an external device could be used to send data on a phone line for display (similar to a caller ID display) on home phones or televisions.

[0080] System 500 employs a single base station 506, two repeaters 508/512, and two remote monitors 510/514 dispersed throughout the premises. In this embodiment, remote monitor 510 also includes the functionality of a wireless repeater—remote monitor 510 can retransmit its received data to one or more destination devices, such as repeater 512. Remote monitor 514 may be similarly configured to operate as a wireless repeater. As used here, base station 506, repeaters 508/512, and remote monitors 510/514 are considered to be wireless remote units for a transmitting device, such as ambulatory telemetry device 504. In this context, these wireless remote units are cooperatively configured to operate as a wireless repeater network for patient data signals and other data signals transmitted by the transmitting device. At least one of these wireless remote units takes the form of a wireless remote monitor (e.g., remote monitor 510 or remote monitor 514) that wirelessly receives patient data signals or retransmitted versions thereof, and generates audio/visual indicia in response to the received signals.

[0081] Base station 506 is capable of transmitting external network data communication signals to external devices. Such external network data communication signals can convey raw sensor data, measured values of the monitored physiological characteristic, status and/or operating data associated with components of system 500, or the like. In practice, an external network data communication signal can convey data via a LAN, a WAN, the Internet, a cellular telecommunication network, a satellite network, etc. For example, FIG. 5 depicts base station 506 communicating with laptop computer 516 and desktop computer 518 via a network 524. In this regard, base station 506 may communicate with network 524 using a dial-up connection, a DSL connection, a fiber optic link, a cable modem connection, or the like. Alternatively or additionally, base station 506 may communicate with network 524 using a wireless data communication protocol, as described above with reference to FIG. 3. In certain embodiments, base station 506 includes a cellular radio that supports wide area communication of data to remote monitors 520/522 via a cellular telecommunication network 526. This feature

enables base station 506 to communicate with remote monitors 520/522 using cellular telecommunication data transmission techniques, technologies, and protocols. As depicted in FIG. 5, it may also be possible for a component in network 524 to communicate with remote monitors 520/522 via cellular telecommunication network 526.

[0082] FIG. 6 is a schematic representation of another alternate embodiment of a system 600 for remote wireless monitoring of patient data. System 600 includes local devices, which may reside in a dwelling/building, and external devices that need not reside in the dwelling/building. The local devices include, without limitation: an ambulatory sensor/transmitter subsystem 602; an ambulatory telemetry device 604; a base station 606; and at least one interior receiving device 608 (e.g., a wireless repeater, a remote monitor, another base station, or any compatible device). In this embodiment, the external devices include, without limitation: a first remote monitor 610 having the form of a mobile communication device (e.g., a cellular telephone); a second remote monitor 612 having the form of a mobile computing device (e.g., a personal digital assistant, a smart phone, or a palmtop computer); and a third remote monitor 614 having the form of another mobile communication device.

[0083] Base station 606 is similar to base station 506 (FIG. 5) in that it supports data communication with an external network 616, which in turn can communicate with one or more destination devices (not shown in FIG. 6). Base station 606, however, need not be configured to communicate directly with a cellular data communication network 618. Rather, as depicted in FIG. 6, ambulatory telemetry device 604 is suitably configured to wirelessly communicate in a direct manner with remote monitor 610, which is realized as a cellular telephone. Notably, ambulatory telemetry device 604 wirelessly communicates with remote monitor 610 using a relatively short range wireless data communication protocol, such as BLUETOOTH® or wireless USB. In this embodiment, remote monitor 610 functions as a relay device by communicating with cellular data communication network 618. Thus, data transmitted by ambulatory telemetry device 604 can be received by remote monitor 610, reformatted if necessary, then retransmitted to remote monitor 612 and/or remote monitor 614 using cellular data communication network 618. It should be appreciated that the base station and the interior receiving device(s) in system 600 are optional. In other words, an alternate embodiment of system 600 can rely on the direct communication between ambulatory telemetry device 604 and remote monitor 610 in the absence of any in-dwelling components.

[0084] FIG. 7 is a schematic representation of yet another alternate embodiment of a system 700 for remote wireless monitoring of patient data. System 700 includes, without limitation: an ambulatory sensor/transmitter subsystem 702; an ambulatory telemetry device 704; and a plurality of wireless remote monitors, where each remote monitor also functions as a wireless repeater for ambulatory telemetry device 704. The illustrated embodiment includes remote monitors 706/708/710, although an embodiment of system 700 can include any number of such remote monitors. Remote monitors 706/708/710 are cooperatively configured to operate as a wireless repeater network for signals transmitted by ambulatory telemetry device 704. FIG. 7 depicts a simple scenario where ambulatory telemetry device 704 wirelessly communicates with remote monitor 706, which in turn wirelessly communicates with remote monitor 708, which in turn wire-

lessly communicates with remote monitor **710**. In practice, however, each of these components may be capable of wirelessly communicating with any number of the other components. Moreover, at least one of the remote monitors **706/708/710** is utilized to generate audio/visual indicia in response to the received data. In other words, at least one of the remote monitors **706/708/710** functions as a monitor device for the physiological characteristic data, patient data, alarms, status information, reminders, and other data types described in more detail above.

**[0085]** An alternate embodiment of system **700** might employ one or more repeaters that do not have monitor functionality. Indeed, one possible system deployment includes ambulatory sensor/transmitter subsystem **702**, ambulatory telemetry device **704**, and one or more repeaters, without any additional monitor or base station elements. This simple architecture can be used to extend the range of the user device in a cost effective manner. For example, a single repeater outfitted with indicators and an alarm snooze button would be an inexpensive way to extend the range and alarm generation capabilities of the user device. Likewise, a network of repeater devices can be dispersed throughout a dwelling to ensure full coverage for alarms, even in the absence of any remote monitoring devices.

**[0086]** The features and components of the systems depicted in FIG. 1 and FIGS. 5-7 can be combined and utilized in different system configurations, and a system embodiment need not be restricted to any of the particular topologies shown in these figures. Indeed, a given system component may have optional user settings that allow the user to customize the data communication capabilities as needed to suit the needs of the particular deployment, dwelling layout, and available device types. That being said, one preferred system embodiment includes the following features and functions: calibration of physiological patient data and the generation of alarms are performed at the ambulatory user device; the user device transmits patient data, alerts, error messages, and the like; any device within the dwelling-based network can receive data transmitted by the user device; any device within the dwelling-based network can re-transmit data to other devices; any device within the dwelling-based network can generate an alarm sound in response to a received alert/alarm message; any device within the dwelling-based network can be used to snooze an alarm; the user device is the only device that is capable of canceling (in contrast to snoozing) certain types of alarms, for example, blood glucose alerts and other critical alarms; and early warning reminders or messages (e.g., "calibration needed in the next two hours" or "change infusion set in eight hours") can be cancelled at remote devices.

**[0087]** FIG. 8 is a schematic representation of an embodiment of a system **800** for communicating and processing physiological characteristic data for a patient. System **800** generally includes, without limitation: an ambulatory system **802** for processing physiological characteristic data; a wireless access device **804**, such as an IEEE 802.11 compliant WLAN access point; one or more data servers **806**; and one or more data distribution networks **808**.

**[0088]** Ambulatory system **802** may include a self-contained, patient wearable, glucose monitor and wireless telemetry unit, which provides the ability to: continuously monitor the patient's glucose data throughout a healthcare facility or other premises; and continuously communicate the patient's glucose data to data servers **806** or a central monitoring sta-

tion for continuous remote monitoring of the patient's glucose levels via a wireless network, and/or to a bedside patient monitor from which the glucose data can be displayed on the bedside monitor and communicated to a central monitoring station. Ambulatory system **802** can be embodied in various types of configurations depending upon the desired product feature set. For example, ambulatory system **802** can be configured to support a wireless telemetry mode or a standalone monitoring mode. In the wireless telemetry mode, the ambulatory system **802** functions both as a monitor, continuously monitoring the patient's glucose data in real-time, and as a wireless telemetry device, continuously communicating the patient's glucose data in real-time over a wireless network infrastructure to a data server **806**. The data server **806** can then distribute the data to a host of centralized and remote monitoring systems (e.g., a central monitoring station, a wireless hand held PDA or smart phone device, or remote display monitors). Additionally or alternatively, data server **806** can provide the data to hospital clinical information systems, or communicate the data via the internet or an intranet for remote monitoring.

**[0089]** In the standalone monitoring mode ambulatory system **802** continues to monitor the patient's glucose data continuously but without an integrated telemetry radio frequency (RF) module. In this application the ambulatory system **802** provides the ability to continuously monitor the patient's glucose data, and provides both audible and visual indication of the patient's glucose value, high and low alarm limits, and device operational alarms/alerts, but is not capable of wirelessly communicating the data to a wireless network infrastructure on its own.

**[0090]** Certain embodiments of ambulatory system **802** are intended for use in the continuous monitoring and wireless communication physiological patient data of bed ridden patients, ambulatory patients, and intra-hospital transport patients within a hospital patient care ward, extended health-care facility, and nursing facility. Ambulatory system **802** is capable of being used in the continuous monitoring of patient's glucose data during inter-hospital transport (ground or air), and is capable of communicating the glucose data via a multitude of wireless communication networks including, but not limited to, WANs (e.g., cellular networks) and LANs (e.g., WiFi networks).

**[0091]** Through the use of an integrated display element, user interface controls, memory, and wireless auto-detect circuitry, ambulatory system **802** can continue to monitor the patient's glucose data locally, with alarms in the event that ambulatory system **802** is out of telemetry operating range, or in the event of power loss. In addition, ambulatory system **802** provides clinicians with the ability to remotely monitor physiological characteristics for one or more patients on a continuous real-time basis, and to be immediately alerted to any patient's glucose data that is outside the pre-defined limit ranges (e.g., hyperglycemic or hypoglycemic), and to be alerted to any operational device or sensor status alarms.

**[0092]** FIG. 9 is a schematic representation of an embodiment of an ambulatory system **900** for communicating and processing physiological characteristic data for a patient. This embodiment of system **900** includes: an ambulatory subsystem **902**; a wireless access device **904**; an optional physiological characteristic meter **906**; and an optional monitor device **908**.

**[0093]** Ambulatory subsystem **902** is "ambulatory" in the sense that it is designed to be worn, carried by, or attached to

a patient in a manner that allows it to move freely with the patient. In other words, ambulatory subsystem **902** need not be stationary, and it need not rely on any stationary power cables or connections. Ambulatory subsystem **902** includes an ambulatory physiological characteristic sensor **910**, a self-contained sensor processor module **912**, and an ambulatory telemetry device **914**. Sensor **910** is used to measure a physiological characteristic of the patient, such as glucose level. Sensor **910** may be generally configured as described above for physiological characteristic sensor **202** (see FIG. 2). In this embodiment, sensor **910** is configured to generate electrical signals that are indicative of the monitored physiological characteristic of the patient. For example, the electrical signals may have an associated voltage or current that varies in accordance with changes in the monitored physiological characteristic.

[0094] Sensor **910** is coupled to sensor processor module **912** in a manner that facilitates transmission of the electrical signals from sensor **910** to sensor processor module **912**. The illustrated embodiment employs a sensor lead **916** connected between sensor **910** and sensor processor module **912**. Sensor lead **916** includes at least one electrical conductor for the electrical signals generated by sensor **910**, and for providing operating power from sensor processor module **912** to sensor **910**. Sensor lead **916** can be attached to sensor **910**, with a connector for sensor processor module **912** at its free end. Alternatively, sensor lead **916** can be provided as a distinct component with two connectors. In practice, sensor lead **916** is shielded against electromagnetic interference, and the connector end(s) are water tight.

[0095] Sensor processor module **912** receives the electrical signals from sensor **910** via sensor lead **916**. Sensor processor module **912** is suitably configured to generate measured values of the physiological characteristic from the received electrical signals. As a standalone component, sensor processor module **912** includes its own power supply (battery) that can be recharged by ambulatory telemetry device **914**. Sensor processor module **912** also includes its own processing capabilities and memory for data storage. Thus, if the patient needs to travel somewhere without ambulatory telemetry device **914**, he can disconnect sensor processor module **912** from ambulatory telemetry device **914**, but leave sensor processor module **912** connected to sensor **910**. This allows sensor processor module **912** to continue receiving, processing, and storing the sensor data. Eventually, the stored sensor data can be transferred to ambulatory telemetry device **914** at an appropriate time.

[0096] The standalone nature of sensor processor module **912** also enables ambulatory telemetry device **914** to be generically configured in the sense that it need not be specifically designed to accommodate any sensor-specific data processing algorithms. Rather, ambulatory telemetry device **914** can be generally designed to relay the already-processed data to other destination devices in the system. Moreover, sensor processor module **912** can be suitably configured for compatibility with other monitoring devices such that the user can transport sensor processor module **912** as needed for connection with remote monitoring devices.

[0097] FIG. 10 is a schematic representation of an embodiment of a sensor processor module **1000** suitable for use with system **900**. Sensor processor module **1000** is preferably realized as a self-contained component that is physically distinct from the associated sensor and ambulatory telemetry device. Sensor processor module **1000** includes, without

limitation: a processing architecture **1002**; a suitable amount of memory **1004**; a power source **1006**; and one or more ports or interfaces **1008** for a sensor lead and/or an interface cable. The elements of sensor processor module **1000** are coupled together by a bus **1010**, a conductive architecture, or any suitable interconnection arrangement.

[0098] Processing architecture **1002** and memory **1004** may be implemented or performed in the manner described above for processing architecture **316** and memory **314**, respectively (see FIG. 3). Processing architecture **1002** is suitably configured as the front end signal processor for electrical signals received from the respective sensor. In practice, processing architecture **1002** performs acquisition, filtering, and conversion of the electrical signals (as detected from the sensor) into glucose values. Memory **1004** can be utilized for the storage of the raw sensor data, processed glucose values, calibration data points (as provided from either an external finger stick glucose meter, an integrated finger stick meter, or manually by a user), glucose trend data, high/low glucose alarm limit settings, or the like.

[0099] Power source **1006** can be realized as a removable internal rechargeable battery. Alternatively, power source **1006** might be a hermetically sealed, non-replaceable battery that is rechargeable using inductive charging. Power source **1006** provides operating power for sensor processor module **1000** and, in some embodiments, operating power for the associated ambulatory physiological characteristic sensor. Power source **1006** provides the ability for the sensor processor module **1000** to continue to operate upon disconnection from the host ambulatory telemetry device, and/or upon loss of external power. During the time period when sensor processor module **1000** is not connected to the ambulatory telemetry device, it will continue to provide electrical operating power to the sensor, and it will continue to process and store the patient's glucose data. Upon re-connection with the ambulatory telemetry device, all internally stored data within memory **1004** will be communicated to the ambulatory telemetry device.

[0100] Referring again to FIG. 9, ambulatory telemetry device **914** is coupled to self-contained sensor processor module **912** in a manner that facilitates transmission of signals that convey measured values of the physiological characteristic (as generated by sensor processor module **912**). The illustrated embodiment employs an interface cable **918** connected between sensor processor module **912** and ambulatory telemetry device **914**. Interface cable **918** includes at least one electrical conductor, and interface cable **918** is configured to facilitate data communication between sensor processor module **912** and ambulatory telemetry device **914**. Interface cable **918** may also provide operating power from ambulatory telemetry device **914** to sensor processor **912**. In one embodiment, interface cable **918** is shielded against electromagnetic interference, and it has a connector for sensor processor module **912** at one end and a connector for ambulatory telemetry device **914** at the other end.

[0101] Ambulatory telemetry device **914** receives the measured values of the monitored physiological characteristic (e.g., glucose level), generates sensor signals that convey the measured values, and wirelessly transmits the sensor signals for reception at an appropriate destination device. In system **900**, wireless access device **904** represents the destination device. Ambulatory telemetry device **914** represents one embodiment of an ambulatory data receiver device that receives and processes measured values of a physiological

characteristic. A generalized ambulatory data receiver device is described in more detail below with reference to FIG. 12.

[0102] In one embodiment, ambulatory telemetry device 914 includes hardware, firmware, software, and/or applications that support wireless data telemetry with one or more destination devices. Alternate embodiments may include one or more optional features. For example, ambulatory telemetry device 914 may be suitably configured to also function as an ambulatory monitor device for the patient. In such an embodiment, ambulatory telemetry device 914 includes an integrated monitor that produces audio/visual indicia associated with the measured values, device or system status information, or the like. In practice, this integrated ambulatory monitor can include any of the monitor features described in more detail herein. Ambulatory telemetry device 914 may also include an (optional) ambulatory fluid infusion device for the patient, such as an insulin pump. For such an embodiment, ambulatory telemetry device 914 can process and transmit status data, alarms, and/or other information related to the operation of the integrated fluid infusion device. Ambulatory telemetry device 914 may also include an (optional) integrated meter device that is configured to directly measure the physiological characteristic of the patient. The integrated meter device enables ambulatory telemetry device 914 to process the direct measurements along with the measured values obtained from sensor 910, for purposes of calibration, redundancy, etc. In one particular embodiment, the integrated meter device is realized as a BG meter that receives and analyzes blood sample test strips. Such “fingerstick” BG meters are well known and, therefore, will not be described in detail here.

[0103] As mentioned above, ambulatory telemetry device 914 may be configured to cooperate with an external monitor device 908 (this is another optional feature). The illustrated embodiment shows monitor device 908 connected to ambulatory telemetry device 914 through an interface cable 920. Alternatively or additionally, monitor device 908 can be coupled to ambulatory telemetry device 914 via one or more wireless links. In practice, monitor device 908 receives signals (e.g., sensor signals that convey the measured values of the monitored physiological characteristic) from ambulatory telemetry device 914 via interface cable 920, processes the received signals, and generates audio/visual indicia in response to the received signals. In practice, monitor device 908 can include any of the monitor features described in more detail herein, and monitor device 908 can generate indicia of items such as the measured values, alarms, device or system status, reminders, or the like.

[0104] System 900 may include an optional physiological characteristic meter device 906, which is suitably configured to directly measure a physiological characteristic of interest (e.g., glucose level), and to transmit such directly-measured values of the physiological characteristic to ambulatory telemetry device 914. The illustrated embodiment depicts meter device 906 as a wireless device that contains a wireless transmitter/transceiver that supports wireless transmission of data with ambulatory telemetry device 914. Alternatively or additionally, meter device 906 can be coupled to ambulatory telemetry device 914 via a physical connection, such as an interface cable. Ambulatory telemetry device 914 can process the direct measurements received from meter device 906, along with the measured values obtained from sensor 910, for purposes of calibration, redundancy, etc. In one particular embodiment, meter device 906 is realized as a BG meter that

receives and analyzes blood sample test strips. Such “fingerstick” BG meters are well known and, therefore, will not be described in detail here.

[0105] Ambulatory subsystem 902 employs a host device that primarily functions as a telemetry device. Alternate system embodiments can instead utilize a host device that primarily functions as a monitor device. In this regard, FIG. 11 is a schematic representation of an alternate embodiment of an ambulatory system 1100 for communicating and processing physiological characteristic data for a patient. This embodiment of system 1100 includes: an ambulatory subsystem 1102; an optional wireless access device 1104; and an optional physiological characteristic meter 1106. This embodiment of ambulatory subsystem 1102 includes, without limitation: an ambulatory physiological characteristic sensor 1110; a self-contained sensor processor module 1112; an ambulatory monitor device 1114; and an optional ambulatory telemetry device 1116. Some of the components in system 1100 are identical, similar, or equivalent to counterpart components in system 900. For the sake of brevity, common features, functions, and characteristics will not be redundantly described here in the context of system 1100.

[0106] Ambulatory monitor device 1114 is coupled to sensor processor module 1112 such that it can receive the measured values of the monitored physiological characteristic (e.g., glucose level) from sensor processor module 1112, process the measured values, and produce audio/visual indicia associated with the measured values. Ambulatory monitor device 1114 represents one embodiment of an ambulatory data receiver device that receives and processes measured values of a physiological characteristic. A generalized ambulatory data receiver device is described in more detail below with reference to FIG. 12.

[0107] In one embodiment, ambulatory monitor device 1114 includes hardware, firmware, software, and/or applications that support patient monitoring features and functions. In practice, ambulatory monitor device 1114 can include any of the monitor features, functions, and options described in more detail herein, and ambulatory monitor device 1114 can generate indicia of items such as the measured values, alarms, device or system status, reminders, or the like. For instance, ambulatory monitor device 1114 can continuously monitor and display the patient glucose values (as detected by sensor 1110, processed by sensor processor module 1112, and communicated to ambulatory monitor device 1114). Ambulatory monitor device 1114 can also display retrospective trend data, glucose alarm limits (high and/or low), calibration reference values (as measured by either an external finger stick meter, internal finger stick meter, or manually entered), and operational status alarms for the devices in the system.

[0108] Alternate embodiments of ambulatory monitor device 1114 may include one or more optional features. For example, ambulatory monitor device 1114 may be suitably configured to also function as an ambulatory fluid infusion device for the patient and/or to also function as an integrated meter device that directly measures the physiological characteristic of interest (these optional features were described above in the context of ambulatory telemetry device 914). Ambulatory monitor device 1114 may also include an (optional) ambulatory telemetry device integrated therein, where the integrated telemetry function is suitably configured to generate sensor signals that convey the measured values of the physiological characteristic of interest, and to wirelessly transmit the sensor signals for reception at a compatible des-

mination device. Accordingly, the primary telemetry functionality of ambulatory telemetry device **914** can be incorporated into ambulatory monitor device **1114** to implement this option. For the embodiment of system **1100** illustrated in FIG. **11**, the optional wireless access device **1104** represents a destination device that wirelessly communicates with ambulatory monitor device **1114**.

[**0109**] As mentioned above, ambulatory monitor device **1114** may be configured to cooperate with an external ambulatory telemetry device **1116** (this is another optional feature). This ambulatory telemetry device **1116** is “external” relative to ambulatory monitor device **1114** because it is a physically distinct component. However, ambulatory telemetry device **1116** is “ambulatory” in the sense that it is designed to be worn, carried, or attached to the patient in a manner that allows it to move about from place to place along with the patient. Ambulatory telemetry device **1116** may be configured to support any of the features, functions, and operations supported by ambulatory telemetry device **914**. Moreover, ambulatory telemetry device **1116** may be realized as a single-parameter device (e.g., a device that only handles glucose data obtained from ambulatory monitor device **1114**), or as a multi-parameter device that has one or more additional patient data input interfaces for receiving additional physiological patient data corresponding to different physiological characteristics (e.g., data other than glucose levels).

[**0110**] The illustrated embodiment shows ambulatory telemetry device **1116** connected to ambulatory monitor device **1114** through an interface cable **1120**. Alternatively or additionally, ambulatory telemetry device **1116** can be coupled to ambulatory monitor device **1114** via one or more wireless links. In this example, ambulatory telemetry device **1116** receives data from ambulatory monitor device **1114** via interface cable **1120**, processes the received data, and transmits wireless signals to a compatible destination device, such as wireless access device **1104**. Thereafter, the data received at the destination device can be further processed, routed, or communicated as desired.

[**0111**] System **1100** may include an optional physiological characteristic meter device **1106**, which is suitably configured to directly measure a physiological characteristic of interest (e.g., glucose level), and to transmit such directly-measured values of the physiological characteristic to ambulatory monitor device **1114**. The above description of meter device **906** also applies to meter device **1106**.

[**0112**] As mentioned above, ambulatory telemetry device **914** (see FIG. **9**) and ambulatory monitor device **1114** (see FIG. **11**) represent two different embodiments of an ambulatory data receiver device that receives and processes measured values of the physiological characteristic. FIG. **12** is a schematic representation of a generalized ambulatory data receiver device **1200** suitable for use with an ambulatory system for communicating and processing physiological characteristic data for a patient. This embodiment of ambulatory data receiver device **1200** includes, without limitation: wireless/wired data communication module(s) **1202**; one or more UI features **1204**; an optional integrated fluid infusion device **1206**; an optional integrated physiological characteristic meter **1208**; device specific hardware, software, firmware, and/or applications **1210**; telemetry and/or monitor functions **1212**; a suitable amount of memory **1214**; a processing architecture **1216**; a power supply **1218**; and one or more optional patient data input interfaces **1220**. The ele-

ments of ambulatory data receiver device **1200** may be coupled together via a bus **1222** or any suitable interconnection architecture.

[**0113**] Processing architecture **1216** and memory **1214** may be implemented or performed in the manner described above for processing architecture **316** and memory **314**, respectively (see FIG. **3**). Device-specific hardware, software, firmware, and/or applications **1210** may vary from one embodiment of ambulatory data receiver device **1200** to another. Again, one embodiment supports at least the primary telemetry functions, while another embodiment supports at least the primary monitor functions (represented by telemetry and/or monitor functions **1212**). In practice, an embodiment may combine one or more of: telemetry functions; monitor functions; integrated fluid infusion device **1206**; integrated physiological characteristic meter **1208**; and possibly other features. Accordingly, device-specific hardware, software, firmware, and/or applications **1210** will support the particular set of features implemented by ambulatory data receiver device **1200**. In practice, certain portions or aspects of device-specific hardware, software, firmware, and/or applications **1210** may be implemented in one or more of the other blocks depicted in FIG. **12**.

[**0114**] An embodiment of ambulatory data receiver device **1200** may employ any number of wireless and/or wired data communication modules **1202**. These data communication modules are suitably configured to support wireless/wired data communication (unidirectional or bidirectional, depending upon the particular implementation) between ambulatory data receiver device **1200** and other devices in the system, for example, a sensor processor module, an external physiological characteristic meter, an external monitor device, an external telemetry device, a wireless access device, a computing device, etc. Wireless/wired data communication modules **1202** may be configured as generally described above in the context of wireless/wired data communication modules **302** (see FIG. **3**). In practice, wireless/wired data communication modules **1202** may include (or be realized as) a data input/output port that is used to connect ambulatory data receiver device **1200** to an external data gathering, data processing, data recording, or data communication device, network, or architecture. In this manner, ambulatory data receiver device **1200** can support wireless and/or wired data communication with remote network devices using appropriate data communication protocols.

[**0115**] Ambulatory data receiver device **1200** may also be designed to accommodate various UI features **1204** that allow the user to control and interact with ambulatory data receiver device **1200** and/or other devices within the system. In practice, UI features **1204** may include any number of the UI elements, components, or features described above, including, without limitation: a display element; speakers; visual indicators; and user controls.

[**0116**] Patient data input interfaces **1220** are configured for receiving additional data signals that are indicative of one or more additional physiological characteristics of the patient. For example, patient data input interfaces **1220** may be designed for compatibility with existing connector types or standard connector configurations that are employed in the medical device and equipment industry. In particular, patient data input interfaces **1220** may be suitably configured to accommodate: ECG lead wires that can be affixed to the patient; pulse oximetry sensors; respiration sensors; thermometers; blood pressure equipment; or the like. Thus,

patient data input interfaces **1220** enable an embodiment of ambulatory data receiver device **1200** to operate in a multi-parameter mode.

**[0117]** Power supply **1218** may include one or more batteries, including a main system removable rechargeable battery, which is used to provide operational power for ambulatory data receiver device **1200** and the sensor processor module, and a smaller backup battery, which is used to provide temporary operating power for ambulatory data receiver device **1200** battery exchange periods. The internal backup battery is automatically selected when the main battery is either very low or is removed from ambulatory data receiver device **1200**. Upon insertion of a fully charged battery, the backup battery is switched out and begins to recharge from the main battery. Some embodiments of ambulatory data receiver device **1200** include a battery charging docking unit that can be used to recharge the backup battery and/or the main battery.

**[0118]** In summary, systems, devices, and methods configured in accordance with the embodiments described herein relate to:

**[0119]** (1) A system for remote wireless monitoring of data for a patient, where the system comprises: an ambulatory sensor/transmitter subsystem configured to obtain measured values of a physiological characteristic of the patient, and to wirelessly transmit sensor signals that convey the measured values; a base station in wireless communication with the ambulatory sensor/transmitter subsystem, the base station being configured to wirelessly receive the sensor signals, generate base station signals in response to the sensor signals, and wirelessly transmit the base station signals; and a remote monitor in wireless communication with the base station, the remote monitor being configured to wirelessly receive the base station signals, and generate audio/visual indicia in response to the base station signals.

**[0120]** The system may further comprise a repeater in wireless communication with the base station and in wireless communication with the remote monitor, the repeater being configured to wirelessly receive the base station signals from the base station, and wirelessly retransmit the base station signals to the remote monitor.

**[0121]** In this system, the remote monitor may comprise a repeater, the repeater being configured to wirelessly receive the base station signals from the base station, and wirelessly retransmit the base station signals to a receiving device.

**[0122]** In this system, the ambulatory sensor/transmitter subsystem may comprise: a physiological characteristic sensor; a sensor transmitter coupled to the physiological characteristic sensor, the sensor transmitter being configured to wirelessly transmit sensor origination signals; and a telemetry device in wireless communication with the sensor transmitter, the telemetry device being configured to wirelessly receive the sensor origination signals, generate the sensor signals from the sensor origination signals, and wirelessly transmit the sensor signals. The telemetry device may comprise an ambulatory monitor device for the patient, the ambulatory monitor device being configured to produce audio/visual indicia associated with the measured values. The telemetry device may comprise an ambulatory fluid infusion device for the patient.

**[0123]** In this system, the base station may comprise a communication module configured to facilitate data communication using an external communication network. The communication module may be configured to facilitate data com-

munication using a cellular telecommunication network, a wide area network, or a local area network.

**[0124]** In this system, the ambulatory sensor/transmitter subsystem can be configured to wirelessly transmit sensor signals using a relatively short range wireless data communication protocol; and the base station can be configured to wirelessly transmit base station signals using a relatively long range wireless data communication protocol.

**[0125]** In this system, the remote monitor may comprise a mobile computing device or a mobile communication device.

**[0126]** In this system, the audio/visual indicia may comprise an audio/visual representation of the measured values, an audio/visual representation of an alarm triggered by the measured values, an audio/visual representation of an operating status of the ambulatory sensor/transmitter subsystem, or an audio/visual representation of an operating status of the base station.

**[0127]** (2) A system for remote wireless monitoring of data for a patient, where the system comprises: an ambulatory telemetry device configured to wirelessly transmit physiological characteristic data for the patient; a base station in wireless communication with the ambulatory telemetry device, the base station being configured to wirelessly receive the physiological characteristic data, generate base station signals in response to the physiological characteristic data, and wirelessly transmit the base station signals; and a remote monitor in wireless communication with the base station, the remote monitor being configured to wirelessly receive the base station signals, and generate audio/visual indicia in response to the base station signals.

**[0128]** The ambulatory telemetry device may comprise an ambulatory monitor device for the patient, the ambulatory monitor device being configured to produce audio/visual indicia associated with the physiological characteristic data. In another embodiment, the ambulatory telemetry device comprises an ambulatory fluid infusion device for the patient.

**[0129]** The system may further comprise an ambulatory sensor/transmitter subsystem in wireless communication with the ambulatory telemetry device, the ambulatory sensor/transmitter subsystem being configured to measure a physiological characteristic of the patient and to wirelessly transmit sensor signals that convey measured values of the physiological characteristic, wherein the ambulatory telemetry device is configured to wirelessly receive the sensor signals, and generate the physiological characteristic data in response to the sensor signals.

**[0130]** (3) A system for remote wireless monitoring of data for a patient, where the system comprises: a transmitting device configured to wirelessly transmit patient data signals that convey measured values of a physiological characteristic of the patient; and a plurality of wireless remote units for the transmitting device, the plurality of wireless remote units being cooperatively configured to operate as a wireless repeater network for the patient data signals; wherein the plurality of wireless remote units comprises a wireless remote monitor in communication with the transmitting device, the wireless remote monitor being configured to wirelessly receive the patient data signals or retransmitted versions thereof, and generate audio/visual indicia of the measured values.

**[0131]** The transmitting device may comprise: an ambulatory sensor/transmitter subsystem that is configured to measure the physiological characteristic of the patient; an ambulatory monitor device for the patient, the ambulatory monitor

device being configured to produce audio/visual indicia of the measured values; an ambulatory fluid infusion device for the patient; or an ambulatory monitor/pump device for the patient.

**[0132]** (4) A method for remote wireless monitoring of data for a patient, the method comprising: measuring a physiological characteristic of the patient; wirelessly transmitting a sensor signal that conveys a measured value of the physiological characteristic; wirelessly receiving the sensor signal at a base station; generating a base station signal in response to the sensor signal; wirelessly transmitting the base station signal from the base station; and wirelessly receiving the base station signal, or a retransmitted version thereof, at a remote monitor.

**[0133]** The method may further comprise: wirelessly receiving the base station signal at a repeater; and wirelessly retransmitting the base station signal from the repeater, wherein the remote monitor wirelessly receives a retransmitted version of the base station signal from the repeater.

**[0134]** The method may further comprise the remote monitor generating, in response to the base station signal received at the remote monitor, audio/visual indicia of the measured value.

**[0135]** The method may further comprise the base station transmitting, in response to the sensor signal received at the base station, an external network data communication signal that conveys the measured value.

**[0136]** In certain embodiments of this method, wirelessly transmitting a sensor signal that conveys a measured value of the physiological characteristic is performed in compliance with a relatively short range wireless data communication protocol; wirelessly receiving the sensor signal at a base station is performed in compliance with the relatively short range wireless data communication protocol; wirelessly transmitting the base station signal from the base station is performed in compliance with a relatively long range wireless data communication protocol; and wirelessly receiving the base station signal, or a retransmitted version thereof, at a remote monitor is performed in compliance with the relatively long range wireless data communication protocol.

**[0137]** (5) A wireless repeater for a system that remotely monitors patient data, the wireless repeater comprising: a receiver configured to wirelessly receive sensor signals that convey measured values of a physiological characteristic of a patient; a transmitter coupled to the receiver, and configured to wirelessly retransmit the sensor signals; a signal analyzer coupled to the receiver, and configured to analyze characteristics and content of received signals; a wireless signal strength indicator coupled to the signal analyzer, and configured to generate audio/visual indicia of received signal strength while the wireless repeater is operating in a setup mode; and a data throughput indicator coupled to the signal analyzer, and configured to generate audio/visual indicia of wirelessly received data while the wireless repeater is operating in the setup mode.

**[0138]** The data throughput indicator may be configured to generate audio/visual indicia of received sensor signals.

**[0139]** The wireless repeater may further comprise an alarm indicator coupled to the signal analyzer, the alarm indicator being configured to generate an audio/visual alarm in response to received sensor signals. This wireless repeater may further comprise an alarm snooze control that is configured to disable the audio/visual alarm.

**[0140]** (6) An ambulatory system for processing physiological characteristic data for a patient, the system comprising: an ambulatory physiological characteristic sensor configured to generate electrical signals that are indicative of a physiological characteristic of the patient; a self-contained sensor processor module coupled to the ambulatory physiological characteristic sensor, the self-contained sensor processor module being configured to receive the electrical signals from the ambulatory physiological characteristic sensor, and generate measured values of the physiological characteristic from the electrical signals; and an ambulatory telemetry device coupled to the self-contained sensor processor module, the ambulatory telemetry device being configured to receive the measured values, generate sensor signals that convey the measured values, and wirelessly transmit the sensor signals for reception at a destination device.

**[0141]** In this system, the ambulatory telemetry device may comprise: an ambulatory monitor device for the patient, the ambulatory monitor device being configured to produce audio/visual indicia associated with the measured values; or an ambulatory fluid infusion device for the patient.

**[0142]** This system may further comprise a sensor lead connected between the ambulatory physiological characteristic sensor and the self-contained sensor processor module, the sensor lead comprising an electrical conductor for the electrical signals.

**[0143]** In this system, the self-contained sensor processor module may further comprise a power source that provides operating power for the ambulatory physiological characteristic sensor.

**[0144]** The system may further comprise an interface cable connected between the self-contained sensor processor module and the ambulatory telemetry device, the interface cable being configured to facilitate data communication between the self-contained sensor processor module and the ambulatory telemetry device.

**[0145]** The system may further comprise a meter device configured to directly measure the physiological characteristic of the patient, and transmit directly-measured values of the physiological characteristic to the ambulatory telemetry device. For this system, the meter device may comprise a wireless transmitter configured to wirelessly transmit the directly-measured values to the ambulatory telemetry device.

**[0146]** The ambulatory telemetry device may comprise an integrated meter device that is configured to directly measure the physiological characteristic of the patient.

**[0147]** The system may further comprise: a monitor device; and an interface cable that connects the monitor device to the ambulatory telemetry device, the monitor device being configured to receive the sensor signals from the ambulatory telemetry device via the interface cable, and to generate audio/visual indicia in response to the sensor signals.

**[0148]** The ambulatory telemetry device may comprise a patient data input interface for receiving a second signal that is indicative of a second physiological characteristic of the patient.

**[0149]** (7) An ambulatory system for processing physiological characteristic data for a patient, the system comprising: an ambulatory physiological characteristic sensor configured to generate electrical signals that are indicative of a physiological characteristic of the patient; a self-contained sensor processor module coupled to the ambulatory physiological characteristic sensor, the self-contained sensor processor module being configured to receive the electrical sig-

nals from the ambulatory physiological characteristic sensor, and generate measured values of the physiological characteristic from the electrical signals; and an ambulatory monitor device coupled to the self-contained sensor processor module, the ambulatory monitor device being configured to receive the measured values, and produce audio/visual indicia associated with the measured values.

**[0150]** In this system, the ambulatory monitor device may comprise an ambulatory telemetry device that is configured to generate sensor signals that convey the measured values, and wirelessly transmit the sensor signals for reception at a destination device.

**[0151]** The system may further comprise an ambulatory telemetry device coupled to the ambulatory monitor device.

**[0152]** The ambulatory monitor device may comprise an ambulatory fluid infusion device for the patient.

**[0153]** The system may further comprise an interface cable connected between the self-contained sensor processor module and the ambulatory monitor device, the interface cable being configured to facilitate data communication between the self-contained sensor processor module and the ambulatory monitor device.

**[0154]** The system may further comprise a meter device configured to directly measure the physiological characteristic of the patient, and transmit directly-measured values of the physiological characteristic to the ambulatory monitor device. In this system, the meter device may comprise a wireless transmitter configured to wirelessly transmit the directly-measured values to the ambulatory monitor device.

**[0155]** The ambulatory monitor device may comprise an integrated meter device that is configured to directly measure the physiological characteristic of the patient.

**[0156]** The ambulatory monitor device may comprise a patient data input interface for receiving a second signal that is indicative of a second physiological characteristic of the patient.

**[0157]** (8) In a system comprising an ambulatory physiological characteristic sensor, an ambulatory data receiver device, and a self-contained sensor processor module coupled between the ambulatory physiological characteristic sensor and the ambulatory data receiver device, a method for communicating physiological characteristic data for a patient. The method involves: generating, with the ambulatory physiological characteristic sensor, electrical signals that are indicative of a physiological characteristic of the patient; receiving the electrical signals at the self-contained sensor processor module; generating, with the self-contained sensor processor module, measured values of the physiological characteristic from the electrical signals; and receiving the measured values at the ambulatory data receiver.

**[0158]** The method may further comprise producing audio/visual indicia of the measured values at the ambulatory data receiver.

**[0159]** The method may further comprise: generating, with the ambulatory data receiver, sensor signals that convey the measured values; and wirelessly transmitting the sensor signals for reception at a destination device.

**[0160]** In this method, receiving the electrical signals may comprise wirelessly receiving the electrical signals from the ambulatory physiological characteristic sensor.

**[0161]** In this method, receiving the measured values may comprise wirelessly receiving the measured values from the self-contained sensor processor module.

**[0162]** The method may further comprise receiving directly-measured values of the physiological characteristic at the ambulatory data receiver, the directly-measured values being directly measured by a meter device that is distinct from the ambulatory data receiver.

**[0163]** The method may further comprise obtaining, with the ambulatory data receiver, directly-measured values of the physiological characteristic.

**[0164]** The method may further comprise: generating, with the ambulatory data receiver, sensor signals that convey the measured values; and transmitting the sensor signals over an external communication network to a destination device.

**[0165]** While at least one example embodiment has been presented in the foregoing detailed description, it should be appreciated that a vast number of variations exist. It should also be appreciated that the example embodiment or embodiments described herein are not intended to limit the scope, applicability, or configuration of the claimed subject matter in any way. Rather, the foregoing detailed description will provide those skilled in the art with a convenient road map for implementing the described embodiment or embodiments. It should be understood that various changes can be made in the function and arrangement of elements without departing from the scope defined by the claims, which includes known equivalents and foreseeable equivalents at the time of filing this patent application.

What is claimed is:

1. A system for remote wireless monitoring of data for a patient, the system comprising:

an ambulatory sensor/transmitter subsystem configured to obtain measured values of a physiological characteristic of the patient, and to wirelessly transmit sensor signals that convey the measured values;

a base station in wireless communication with the ambulatory sensor/transmitter subsystem, the base station being configured to wirelessly receive the sensor signals, generate base station signals in response to the sensor signals, and wirelessly transmit the base station signals; and

a remote monitor in wireless communication with the base station, the remote monitor being configured to wirelessly receive the base station signals, and generate audio/visual indicia in response to the base station signals.

2. The system of claim 1, further comprising a repeater in wireless communication with the base station and in wireless communication with the remote monitor, the repeater being configured to wirelessly receive the base station signals from the base station, and wirelessly retransmit the base station signals to the remote monitor.

3. The system of claim 1, the remote monitor comprising a repeater, the repeater being configured to wirelessly receive the base station signals from the base station, and wirelessly retransmit the base station signals to a receiving device.

4. The system of claim 1, the ambulatory sensor/transmitter subsystem comprising:

a physiological characteristic sensor;

a sensor transmitter coupled to the physiological characteristic sensor, the sensor transmitter being configured to wirelessly transmit sensor origination signals; and

a telemetry device in wireless communication with the sensor transmitter, the telemetry device being configured to wirelessly receive the sensor origination signals,

generate the sensor signals from the sensor origination signals, and wirelessly transmit the sensor signals.

5. The system of claim 4, the telemetry device comprising an ambulatory monitor device for the patient, the ambulatory monitor device being configured to produce audio/visual indicia associated with the measured values.

6. The system of claim 4, the telemetry device comprising an ambulatory fluid infusion device for the patient.

7. The system of claim 1, the base station comprising a communication module configured to facilitate data communication using a network selected from the group consisting of an external communication network, a cellular telecommunication network, a wide area network, and a local area network.

8. The system of claim 1, wherein:

the ambulatory sensor/transmitter subsystem is configured to wirelessly transmit sensor signals using a relatively short range wireless data communication protocol; and the base station is configured to wirelessly transmit base station signals using a relatively long range wireless data communication protocol.

9. The system of claim 1, the remote monitor comprising a mobile computing device.

10. A wireless repeater for a system that remotely monitors patient data, the wireless repeater comprising:

a receiver configured to wirelessly receive sensor signals that convey measured values of a physiological characteristic of a patient;

a transmitter coupled to the receiver, and configured to wirelessly retransmit the sensor signals;

a signal analyzer coupled to the receiver, and configured to analyze characteristics and content of received signals;

a wireless signal strength indicator coupled to the signal analyzer, and configured to generate audio/visual indicia of received signal strength while the wireless repeater is operating in a setup mode; and

a data throughput indicator coupled to the signal analyzer, and configured to generate audio/visual indicia of wirelessly received data.

11. The wireless repeater of claim 10, the data throughput indicator being configured to generate audio/visual indicia of received sensor signals.

12. The wireless repeater of claim 10, further comprising an alarm indicator coupled to the signal analyzer, the alarm indicator being configured to generate an audio/visual alarm in response to received sensor signals.

13. The wireless repeater of claim 12, further comprising an alarm snooze control that is configured to disable the audio/visual alarm.

14. An ambulatory system for processing physiological characteristic data for a patient, the system comprising:

an ambulatory physiological characteristic sensor configured to generate electrical signals that are indicative of a physiological characteristic of the patient;

a self-contained sensor processor module coupled to the ambulatory physiological characteristic sensor, the self-contained sensor processor module being configured to receive the electrical signals from the ambulatory physiological characteristic sensor, and generate measured values of the physiological characteristic from the electrical signals; and

an ambulatory telemetry device coupled to the self-contained sensor processor module, the ambulatory telemetry device being configured to receive the measured values, generate sensor signals that convey the measured values, and wirelessly transmit the sensor signals for reception at a destination device.

15. The system of claim 14, the ambulatory telemetry device comprising an ambulatory monitor device for the patient, the ambulatory monitor device being configured to produce audio/visual indicia associated with the measured values.

16. The system of claim 14, the ambulatory telemetry device comprising an ambulatory fluid infusion device for the patient.

17. The system of claim 14, further comprising an interface cable connected between the self-contained sensor processor module and the ambulatory telemetry device, the interface cable being configured to facilitate data communication between the self-contained sensor processor module and the ambulatory telemetry device.

18. The system of claim 14, further comprising a meter device configured to directly measure the physiological characteristic of the patient, and transmit directly-measured values of the physiological characteristic to the ambulatory telemetry device.

19. The system of claim 18, the meter device comprising a wireless transmitter configured to wirelessly transmit the directly-measured values to the ambulatory telemetry device.

20. The system of claim 14, the ambulatory telemetry device comprising an integrated meter device that is configured to directly measure the physiological characteristic of the patient.

\* \* \* \* \*

专利名称(译)	远程无线监控，处理和患者数据通信		
公开(公告)号	<a href="#">US20090112626A1</a>	公开(公告)日	2009-04-30
申请号	US11/929988	申请日	2007-10-30
[标]申请(专利权)人(译)	TALBOT CARY HALPERN亚利耶小号		
申请(专利权)人(译)	TALBOT CARY HALPERN亚利耶小号		
当前申请(专利权)人(译)	TALBOT CARY HALPERN亚利耶小号		
[标]发明人	TALBOT CARY HALPERN ARIEH S		
发明人	TALBOT, CARY HALPERN, ARIEH S.		
IPC分类号	G06Q50/00 A61B5/00		
CPC分类号	A61B5/14532 G06Q50/24 A61B5/0022 A61B5/002 G06F19/3418 A61B5/7405 G16H20/17 G16H40/67		
外部链接	<a href="#">Espacenet</a>	<a href="#">USPTO</a>	

摘要(译)

提供了一种用于患者数据的远程无线监控系统，以及一种用于处理和传输生理特征数据的移动系统。用于远程无线监视患者数据的系统的实施例包括：移动传感器/发射器子系统，其无线地发送患者的生理特征的测量值，基站，其无线地从传感器/发射器子系统接收信号，以及远程监控器，无线接收来自基站的信号。远程监控器被配置为响应于基站信号生成音频和/或视觉标记（表示警报，测量值，设备或系统状态信息等）。移动系统的实施例包括生理特征传感器，耦合到移动生理特征传感器的独立传感器处理器模块，以及耦合到独立传感器处理器模块的移动数据接收器设备。

