



US007104964B2

(12) **United States Patent**  
**Kline**

(10) **Patent No.:** **US 7,104,964 B2**  
(45) **Date of Patent:** **Sep. 12, 2006**

(54) **NON-INVASIVE DEVICE AND METHOD FOR THE DIAGNOSIS OF PULMONARY VASCULAR OCCLUSIONS**

(75) Inventor: **Jeffrey A. Kline**, Charlotte, NC (US)

(73) Assignee: **Charlotte-Mecklenburg Hospital**, Charlotte, NC (US)

(\*) Notice: Subject to any disclaimer, the term of this patent is extended or adjusted under 35 U.S.C. 154(b) by 24 days.

(21) Appl. No.: **11/108,363**

(22) Filed: **Apr. 18, 2005**

(65) **Prior Publication Data**

US 2005/0197589 A1 Sep. 8, 2005

**Related U.S. Application Data**

(60) Division of application No. 10/109,301, filed on Mar. 27, 2002, now Pat. No. 6,881,193, which is a continuation-in-part of application No. 09/965,303, filed on Sep. 27, 2001, now Pat. No. 6,575,918.

(51) **Int. Cl.**  
**A61B 5/00** (2006.01)

(52) **U.S. Cl.** ..... **600/532; 73/23.3; 422/84**

(58) **Field of Classification Search** ..... None  
See application file for complete search history.

(56) **References Cited**

U.S. PATENT DOCUMENTS

5,533,512 A *	7/1996	Novotny et al.	600/532
6,076,392 A *	6/2000	Drzewiecki	73/23.2
6,599,253 B1 *	7/2003	Baum et al.	600/532
2003/0208133 A1 *	11/2003	Mault	600/532

\* cited by examiner

*Primary Examiner*—Robert L. Nasser, Jr.

(74) *Attorney, Agent, or Firm*—George R. McGuire; Bond, Schoeneck & King, PLLC

(57) **ABSTRACT**

This invention involves a device and method for ascertaining the functioning of the respiratory system and determining whether a pulmonary embolism is present. The device comprises an apparatus containing sensors which measure the amount of a particular gas expired from a patient's lungs, including a non-ambient gas which is previously provided to the patient. From this data, a processor computes the concentration of expired gas as a function of expired volume and displays the results on a screen. By comparing the results to predetermined values from afflicted and healthy patient populations, an accurate determination can be made regarding the presence of a pulmonary embolism.

**6 Claims, 4 Drawing Sheets**

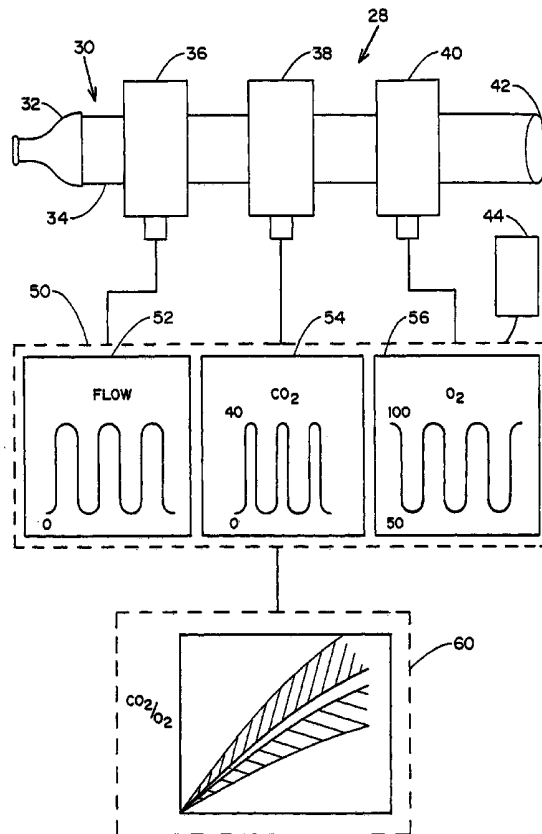

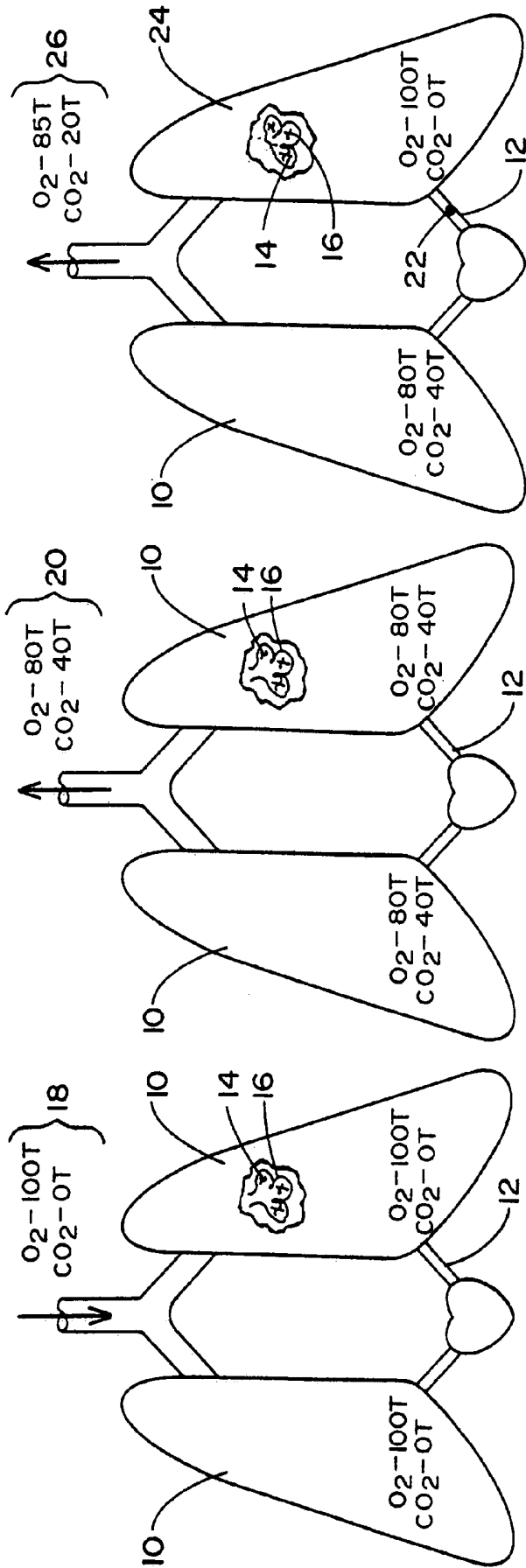
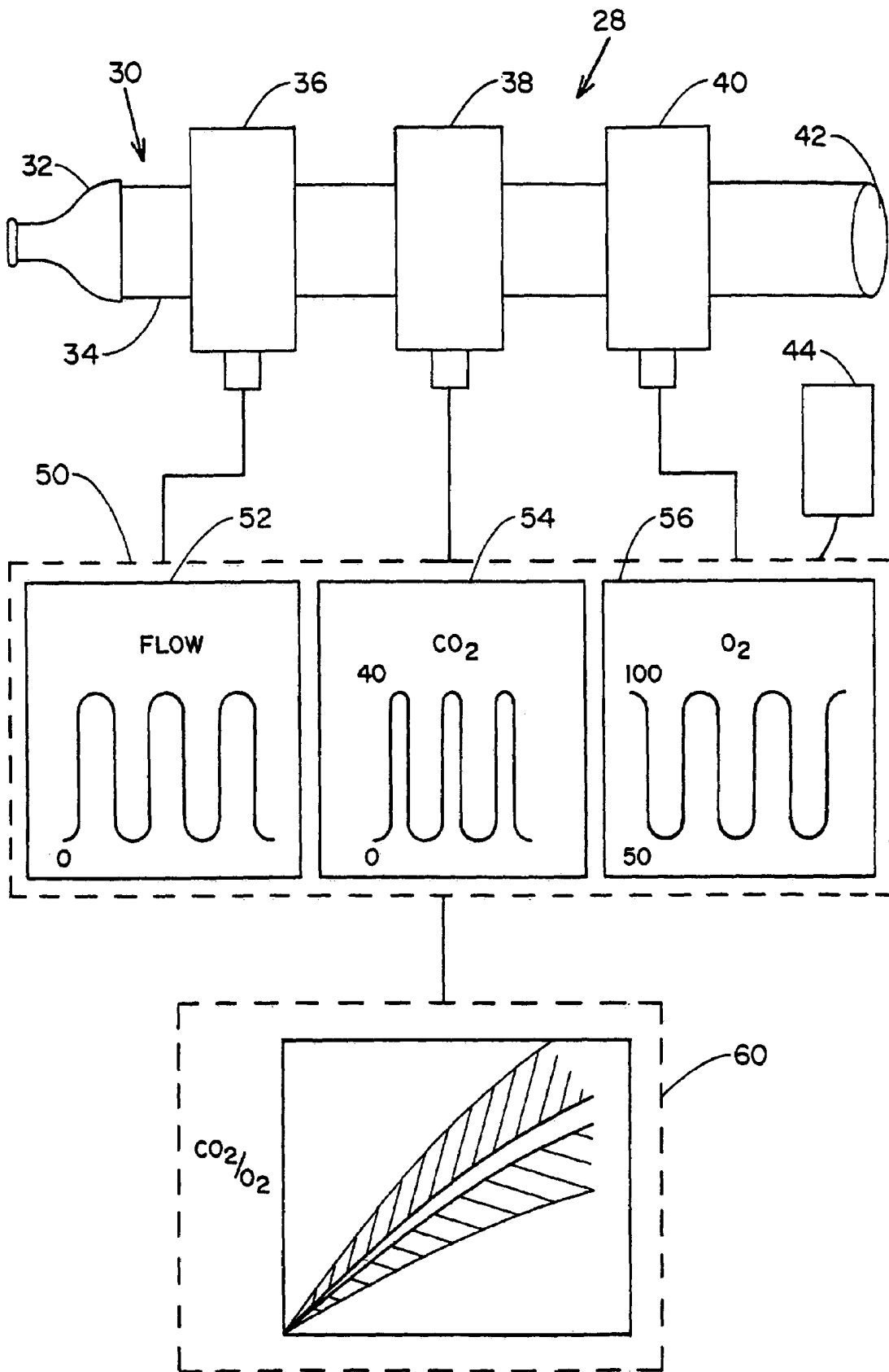

FIG. 1

FIG. 2

FIG. 3



**FIG. 4**

FIG. 5

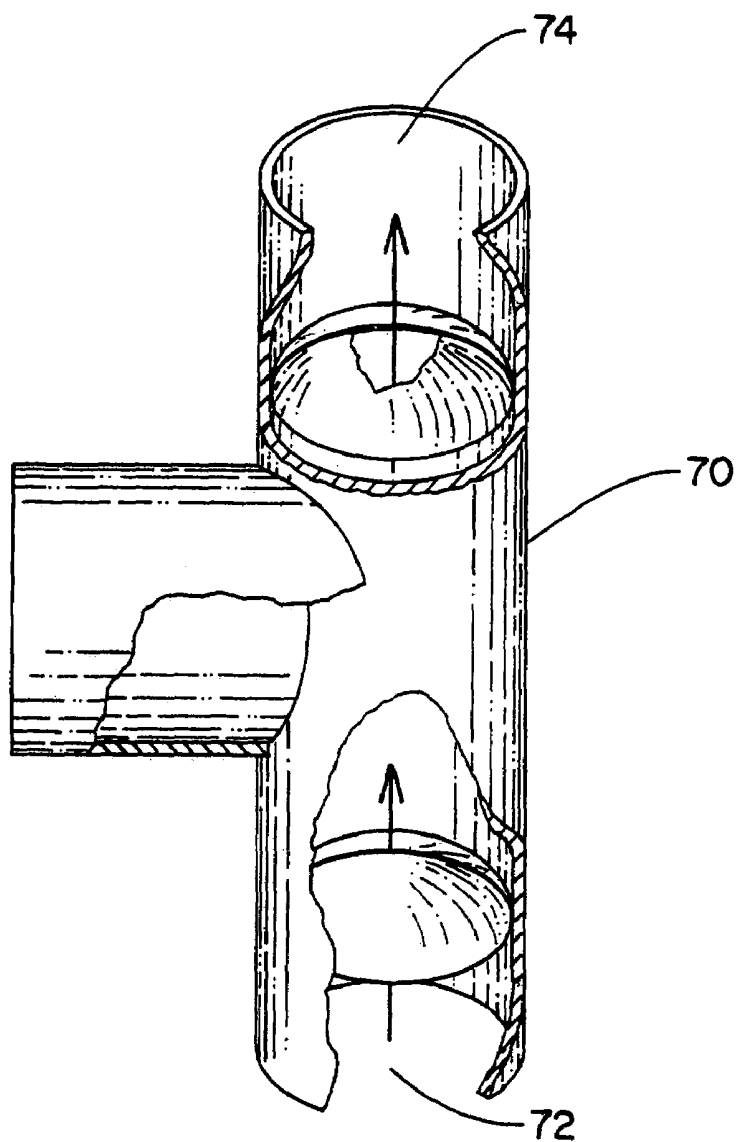
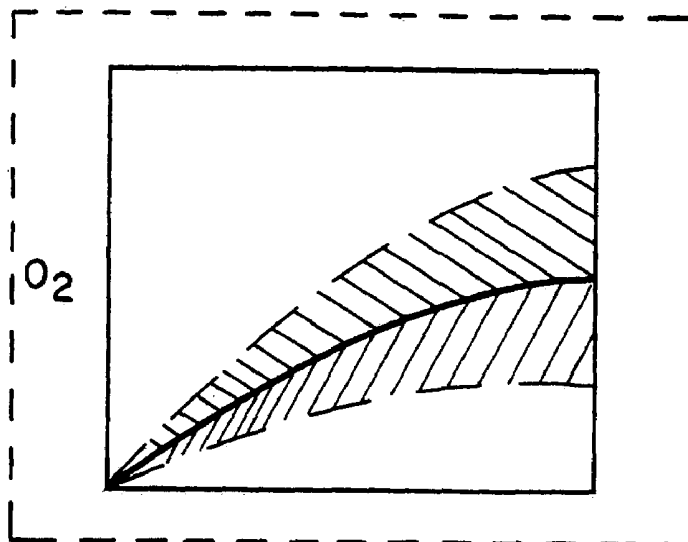
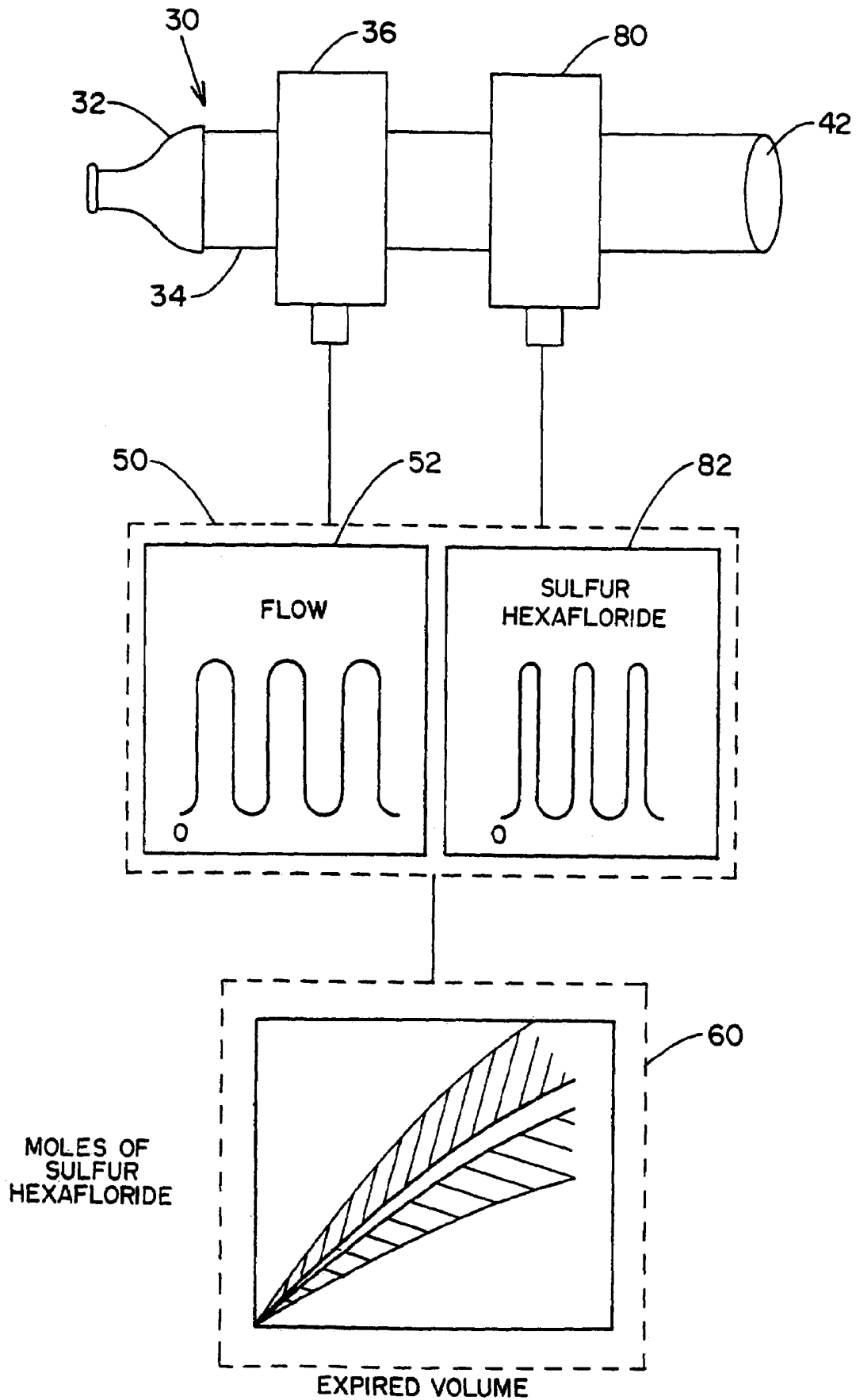

FIG. 6



**FIG. 7**



## NON-INVASIVE DEVICE AND METHOD FOR THE DIAGNOSIS OF PULMONARY VASCULAR OCCLUSIONS

### CROSS-REFERENCE TO PRIOR APPLICATION

The present application is divisional of U.S. patent application, Ser. No. 10/109,301 filed Mar. 27, 2002 U.S. Pat. No. 6,881,193 which is a continuation-in-part of U.S. patent application, Ser. No. 09/965,303 filed Sep. 27, 2001, U.S. Pat. No. 6,575,918.

### BACKGROUND OF THE INVENTION

#### 1. Field of Invention

The present invention relates generally to vascular occlusions of the respiratory system, and more particularly to non-invasive devices and methods for the diagnosis of a pulmonary embolism and related disorders.

#### 2. Description of Prior Art

A pulmonary embolism occurs when an embolus become lodged in lung arteries, thus blocking blood flow to lung tissue. An embolus is usually a blood clot, known as a thrombus, but may also comprise fat, amniotic fluid, bone marrow, tumor fragments, or even air bubbles that block a blood vessel. Unless treated promptly, a pulmonary embolism can be fatal. In the United States alone, around 600,000 cases occur annually, 10 percent of which result in death.

The detection of a pulmonary embolism is extremely difficult because signs and symptoms can easily be attributed to other conditions and symptoms may vary depending on the severity of the occurrence. Frequently, a pulmonary embolism is confused with a heart attack, pneumonia, hyperventilation, congestive heart failure or a panic attack. In other cases, there may be no symptoms at all.

Often, a physician must first eliminate the possibility of other lung diseases before determining that the symptoms, if any, are caused by a pulmonary embolism. Traditional diagnostic methods of testing involve blood tests, chest X-rays, and electrocardiograms. These methods are typically more effective in ruling out other possible reasons than for actually diagnosing a pulmonary embolism. For example, a chest x-ray may reveal subtle changes in the blood vessel patterns after an embolism and signs of pulmonary infarction. However, chest x-rays often show normal lungs even when an embolism is present and even when the x-rays show abnormalities they rarely confirm a pulmonary embolism. Similarly, an electrocardiogram may show abnormalities, but it is only useful in establishing the possibility of a pulmonary embolism.

As a pulmonary embolism alters the ability of the lungs to oxygenate the blood and to remove carbon dioxide from the blood, one method of diagnosing the condition involves taking a specimen of arterial blood and measuring the partial pressure of oxygen and carbon dioxide in the arterial blood (i.e., an arterial blood gas analysis). Although a pulmonary embolism usually causes abnormalities in these measurements, there is no individual finding or combination of findings from the arterial blood gas analysis that allows either a reliable way to exclude or specific way of diagnosing pulmonary embolism. In particular, at least 15–20% of patients with a documented pulmonary embolism have normal oxygen and carbon dioxide contents of the arterial blood. Accordingly, the arterial blood analysis cannot reliably include or exclude the diagnosis of a pulmonary embolism.

The blood D-dimer assay is another diagnostic method that has become available for commercial use. The D-dimer protein fragment is formed when fibrin is cleaved by plasmin and therefore produced naturally whenever clots form in the body. As a result, the D-dimer assay is extremely sensitive for the presence of a pulmonary embolism but is very nonspecific. In other words, if the D-dimer assay is normal, the clinician has a reasonably high degree of certainty that no pulmonary embolism is present. However, many studies have shown a D-dimer assay is only normal in less than 1/3 of patients and thus produces a high degree of false positives. As a result, the D-dimer assay does not obviate formal pulmonary vascular imaging in most patients with symptoms or a pulmonary embolism.

In an attempt to increase the accuracy of diagnostic, physicians have recently turned to methods which can produce an image of a potentially afflicted lung. One such method is a nuclear perfusion study which involves the injection of a small amount of radioactive particles into a vein. The radioactive particles then travel to the lungs where they highlight the perfusion of blood in the lung based upon whether they can penetrate a given area of the lung. While normal results can indicate that a patient lacks a pulmonary embolism, an abnormal scan does not necessarily mean that a pulmonary embolism is present. Nuclear perfusion is often performed in conjunction with a lung ventilation scan to optimize results.

During a lung ventilation scan, the patient inhales a gaseous radioactive material. The radioactive material becomes distributed throughout the lung's small air sacs, known as alveoli, and can be imaged. By comparing this scan to the blood supply depicted in the perfusion scan, a physician may be able to determine whether the person has a pulmonary embolism based upon areas that show normal ventilation but lack sufficient perfusion. Nevertheless, a perfusion scan does not always provide clear evidence that a pulmonary embolism is the cause of the problem as it often yields indeterminate results in as many as 70% of patients.

Pulmonary angiograms are popular means of diagnosing a pulmonary embolism, but the procedure poses some risks and is more uncomfortable than other tests. During a pulmonary angiogram, a catheter is threaded into the pulmonary artery so that iodine dye can be injected into the bloodstream. The dye flows into the regions of the lung and is imaged using x-ray technology, which would indicate a pulmonary embolism as a blockage of flow in an artery. Pulmonary angiograms are more useful in diagnosing a pulmonary embolism than some of the other traditional methods, but often present health risks and can be expensive. Although frequently recommended by experts, few physicians and patients are willing to undergo such an invasive procedure.

Spiral volumetric computed tomography is another diagnostic tool that has recently been proposed as a less invasive test which can deliver more accurate results. The procedure's reported sensitivity has varied widely, however, and it may only be useful for diagnosing an embolism in central pulmonary arteries as it is relatively insensitive to clots in more remote regions of the lungs.

These pulmonary vascular imaging tests have several disadvantages in common. Nearly all require ionizing radiation and invasiveness of, at a minimum, an intravenous catheter. The imaging tests also typically involve costs of more than \$1,000 for the patient, take more than two hours to perform, and require special expertise such as a trained technician to perform the tests and acquire the images and a board-certified radiologist to interpret the images. Notably,

none are completely safe for patients who are pregnant. As a result of these shortcomings, the imaging procedures are not available in many outpatient clinic settings and in many portions of third world countries.

### 3. Objects and Advantages

It is a principal object and advantage of the present invention to provide physicians with an instrument for non-invasively diagnosing pulmonary vascular occlusions.

It is an additional object and advantage of the present invention to provide an instrument that accurately diagnoses pulmonary vascular occlusions.

It is a further object and advantage of the present invention to provide an instrument for measuring and interpreting pulmonary test data.

Other objects and advantages of the present invention will in part be obvious, and in part appear hereinafter.

### SUMMARY OF THE INVENTION

In accordance with the foregoing objects and advantages, the present invention provides a device and method for non-invasively diagnosing a pulmonary embolism. The device of the present invention comprises a breathing tube having sensors for measuring the flow of air into and out of a patient's lungs as well as the amount of oxygen, carbon dioxide, or nitrogen. Alternatively, the device can comprise a sensor such as an infrared or mass spectrometer capable of measuring the quantity of a non-ambient gas which is excreted via the lungs after injection into a patient. The device further comprises a data processing unit which determines the concentrations of the expired gases and total volume of gas expired for display on a screen. The likelihood that a pulmonary embolism is present can be determined by comparison of the results to predetermined data from normal and afflicted populations.

### BRIEF DESCRIPTION OF THE DRAWINGS

FIG. 1 is an illustration of a respiratory system during inhalation.

FIG. 2 is an illustration of a respiratory system during exhalation.

FIG. 3 is an illustration of a respiratory system afflicted with a pulmonary vascular occlusion during exhalation.

FIG. 4 is a schematic representation of the system of the present invention.

FIG. 5 is a perspective view of an attachment to the invention.

FIG. 6 is an illustration of a display screen readout.

FIG. 7 is a schematic representation of the system of the present invention.

### DETAILED DESCRIPTION

Referring now to the drawing in which like reference numerals refer to like parts throughout, there is seen in FIG. 1 a representation of lungs 10 free from any pulmonary occlusions. In healthy lungs 10, blood flows freely from the pulmonary arteries 12 into the capillaries 14 surrounding the individual alveoli 16 of the lungs 10. When inhaled air 18 is drawn into the lungs 10 and alveoli 16, oxygen is transferred from the inhaled air 18 to the blood stream and carbon dioxide is transferred out. Inhaled air 18 typically contains an oxygen partial pressure of approximately one hundred (100) torr and a carbon dioxide partial pressure of zero (0) torr.

Once the inhaled air 18 reaches the alveoli 16, the oxygen content decreases while the carbon dioxide content increases until an equilibrium with blood gas levels in the pulmonary arteries 12 is reached. The inhaled air 18 is then, as seen in FIG. 2, expired as exhaled air 20. Exhaled air 20 from properly functioning lungs typically contains a partial pressure of oxygen of about eighty (80) torr and a partial pressure of carbon dioxide of about forty (40) torr.

FIG. 3 depicts the functioning of a respiratory system afflicted with a pulmonary embolism 22 which, as an example, occludes blood flow to an afflicted lung 24. As a result, there is a reduction in the number of alveoli 16 that participate in gas exchange. This volume of space available in the alveoli 16 that is lost from participation is commonly referred to as alveolar deadspace. Due to the deadspace and loss of total alveolar volume available for gas exchange, afflicted lung 24 does not exchange gases as readily as the healthy lung 10. Accordingly, exhaled air 26 contains a higher partial pressure of oxygen and lower partial pressure of carbon dioxide than air exhaled from a healthy lung. In the example depicted in FIG. 3, exhaled air 26 exiting the respiratory system contains a partial pressure of oxygen of about eighty-five (85) torr and a partial pressure of carbon dioxide of about twenty (20) torr. Thus, the ratio of carbon dioxide to oxygen in exhaled air 26 from afflicted lung 24 (i.e., 20:85) is smaller than the ratio in exhaled air 20 from healthy lung 10 (i.e., 40:80) as seen in FIG. 2.

As seen in FIG. 4, a system 28 for measuring and diagnosing pulmonary disorders comprises a measuring unit 30 in combination with a data processing unit 50 and a display screen 60. Measuring unit 30 determines the overall flow of air inhaled into and exhaled out of the lungs while simultaneously determining the partial pressure of oxygen and carbon dioxide. Data processing unit 50 computes the concentrations of carbon dioxide, oxygen, and nitrogen from the partial pressures and determines the ratio of carbon dioxide to oxygen from the raw data obtained by measuring unit 30. The ratio of carbon dioxide to oxygen is then plotted against expired volume on display screen 60. By comparing the carbon dioxide ratios to average readings, the likelihood that a given patient has a pulmonary embolism can be determined.

Measuring unit 30 comprises a patient mouthpiece 32 connected in fluid communication to a breathing tube 34 having an open end 42 through which air can be inhaled or exhaled. Measuring unit 30 further comprises three sensors; a pneumotach 36, a capnometer 38, and an oxygen monitor 40. The three sensors are situated in series and in-line with breathing tube 34 for simultaneously measuring the flow, carbon dioxide, and oxygen levels of inhaled and exhaled air. Infrared and paramagnetic type sensors are preferred respectively. Sensors using spectrometric techniques may also work for both oxygen and carbon dioxide measurements providing they can supply data with rapid enough response time for breath-to-breath, real-time plotting. The mainstream technique for measuring the inhaled or exhaled air is preferred, but the sidestream technique may also be effective.

As seen in FIG. 5, a T-piece adaptor 70 may optionally be provided at open end 42 of breathing tube 34 for use with patients that are oxygen dependant. T-piece adapter 70 contains an inlet valve 72 and an outlet valve 74 which properly direct the passage of inhaled and exhaled air through the breathing tube 34. By connecting an oxygen dependant patient's supply to the inlet valve 72, inhaled air can first be passed through the three sensors 36, 38, 40 to establish baseline readings of the oxygen and carbon dioxide

concentrations for comparison to exhaled air, since an oxygen dependent patient receives air that has different concentrations than present in ambient air.

Data processing unit 50 comprises a commercially available computer processor programmed with software for the interpretation of the data obtained from measuring unit 30 and background comparison data. Software can be specifically developed to perform the necessary calculations to determine the partial pressures and carbon dioxide to oxygen ratios or software can optionally be purchased commercially and, if necessary, modified to run the appropriate algorithms. After additional research, the background comparison data can be updated based on data obtained from use of the invention to further refine expected normal values.

Display screen 60 comprises a cathode ray tube or other visual display for displaying computerized data. Screen 60 can optionally display graphs representing predetermined reference or background data for test populations against which the current readings can be plotted for a visual comparison. In addition to displaying the carbon dioxide to oxygen ratios as a function of time calculated by data processing unit 50, screen 60 may optionally display a plot of the expired oxygen and carbon dioxide partial pressures. Using this display, a physician may estimate the efficiency of alveolar ventilation in patients with acute respiratory distress syndromes to assist in deciding the mechanical ventilation settings.

In addition to the three primary sensors 36, 38, 40, data processing unit 50 may optionally be connected to a pulse oximeter 44 that measures arterial oxygen saturation of hemoglobin in the arterial blood. From this data, and the additional measurement of pH and hemoglobin concentration in a peripheral venous blood sample, the cardiac output of the patient can be calculated according to the Fick equation. In order to perform the Fick equation, the average total oxygen consumed, the arterial oxygen content and venous oxygen content must be determined. The average total oxygen consumed can be determined from the oxygen tension and flow curves over a predetermined time period. For the purposes of determining cardiac output, a one minute time period is sufficient. The arterial oxygen content can be estimated by multiplying the arterial oxygen saturation (measured by pulse oximeter 44) by the hemoglobin concentration (determined from the venous blood sample). The venous oxygen content can be calculated by determining the nadir (mean lowest) oxygen tension measured during expiration over the predetermined time period. From the nadir oxygen tension, venous oxygen saturation can be estimated according to published oxygen binding curves for the measured pH. The venous oxygen content is then calculated by multiplying the venous oxygen saturation by the venous hemoglobin (measured from the venous blood sample). Once these calculations have been made, the cardiac output is determined by dividing the total oxygen consumed by the difference between the arterial oxygen content and the venous oxygen content. The algorithm for the Fick calculation can be programmed into the data processing unit software and the results displayed on screen 60. The cardiac output measurement is useful for assisting the physician in determining the success or failure of treatment designed to relieve pulmonary vascular obstructions, or to treat circulatory shock.

Device 28 is used by having a patient breathe (inhale and exhale a predetermined number of times in succession) through mouthpiece 32 of the measuring unit 30. As the patient inhales and exhales the pneumotach now sensor 36, capnometer 38, and oxygen monitor 40 perform their

respective readings, which are then electrically transmitted via wires or cabling to data processing unit 50. The programmable software loaded into data processing unit 50 convert the measurements into volume and concentration readings, calculate the carbon dioxide to oxygen ratio, and display this ratio on screen 60 in the form of a graph against the volume of air expired.

Readings may be optimized by requiring the patient to hold in inhaled air for several heartbeats before exhaling through the mouthpiece 32 of the measuring unit 30. It is generally accepted that patients without a pulmonary embolism will normally have a carbon dioxide to oxygen ratio of 0.30 or greater while patients with a pulmonary embolism will have a carbon dioxide to oxygen ratio 0.25 or less.

Device 28 may also be used for the detection of whole-body oxygen consumption and determination of the adequacy of oxygen delivery during resuscitation from shock. During conditions of systemic inflammation the body will extract oxygen at higher levels than normal, resulting in an increase in the carbon dioxide to oxygen ratio in exhaled air. By using T-piece 70 in the manner explained above, the concentration of the oxygen provided to the patient and the concentration of the oxygen exhaled can be determined. As illustrated in FIG. 6, when the level of oxygen delivery (i.e., the amount provided minus the amount exhaled) observed at two inspired oxygen concentrations reaches normal levels a physician has visual conformation that the resuscitation performed is adequate. One method of determining the adequacy of resuscitation is to determine oxygen delivery at both relatively low fixed concentrations of oxygen and at relatively high fixed concentration. Relatively low concentrations include from about twenty-one to thirty percent (21–30%) oxygen and relatively high oxygen concentrations involve about forty-five to fifty percent (45–50%) oxygen. The difference between oxygen delivery at relatively low concentrations verses relatively high concentrations can be compared against a nomogram for healthy patients of similar age, body mass, body mass index, and gender and used to assess the adequacy of fluid and vasopressor resuscitation.

Data processing unit 50 can additionally be programmed to display on screen 60 any of the individual measurements taken by sensors 36, 38, 40, and 44, or combinations thereof for diagnostic purposes. For example, a plot of the expired carbon dioxide and oxygen concentration over time could be used to estimate the efficiency of alveolar ventilation in patients with acute respiratory distress syndrome. Additionally, the plotted data from sensors 36, 38, 40, and 44 could be used to assist in deciding how to properly adjust mechanical ventilators setting, such as the degree of positive end-expiratory pressure, minute ventilation, and peak inspiratory pressure settings, to optimize patient care. For example, data from sensors 36, 37, 40, and 44, can be plotted individually in patients who are being mechanically ventilated. By simultaneously plotting the partial pressures of oxygen and carbon dioxide as a function of volume of each breath, the amount of carbon dioxide released and percentage of oxygen extracted can be determined. If the barometric pressure is known or inputted into data processing unit 50, the efficiency of alveolar ventilation during each tidal volume breath can be calculated. This information can then be used to adjust mechanical ventilation to optimize alveolar efficiency or breathing alveolar ventilation efficiency.

Measuring unit 30 may comprise a pneumotach 36 and an infrared spectrometer 80 in fluid communication with breathing tube 34. Spectrometer 80 is capable of measuring the expired concentration of other substances, such as gases not normally present in ambient air, which are eliminated or

excreted from a patient via the lungs. The patient is injected intravenously with a predetermined safe quantity of the substance and allowed to exhale through measuring unit **30** for approximately five minutes. During this time period, the measurements from pneumotach **36** and spectrometer **80** are provided to data processing unit **50** which computes the concentration of the substance (as either a percentage or partial pressure) and provides the results for display on screen **60**. As with the previous embodiments of the present invention, the presence or absence of a pulmonary embolism can be determined based upon a comparison of the particular patient's displayed results to elimination curves derived from a large sampling of normal and affected populations. A mass spectrometer in fluid communication with measuring unit **30** could alternatively be used to measure the quantity of inert gas expired by the patient.

One substance which is medically safe for use in humans is sulfur hexafluoride. For example, a useful preparation of sulfur hexafluoride is SonoVue® a suspension of stabilized sulfur hexafluoride microbubbles in a 0.9% saline solution produced by Bracco SpA, Milan, Italy. The patient is injected via a "butterfly" needle with 0.03 ml/kg of the sulfur hexafluoride preparation, thus avoiding the need for an intravenous catheter. Infrared spectrometer **80** measures the concentration of sulfur hexafluoride (as either a percent or partial pressure) and provides the data **82** to data processing unit **50**. The moles of expired sulfur hexafluoride are then calculated and plotted on screen **60** as a function of expired volume along. Screen **60** can also display data from normal and afflicted populations for diagnostic purposes. Other substances which can be prepared in solution and used in this manner are acetylene, ethane, cyclopropane, halothane, ether, and acetone.

While measuring unit **30** optimally includes capnometer **38** for measuring expired carbon dioxide concentration and oxygen monitor **40** for measuring expired oxygen concentrations, either capnometer **38** or oxygen monitor **40** may be replaced by a mass spectrometer which can measure expired nitrogen and provide the data to data processing unit **50** for calculation of concentration. As ambient air is primarily comprised of three gases, i.e., nitrogen, oxygen, and carbon dioxide, measurement of the concentration of any two gases will allow an approximate determination of the third using standard tables or calculations. Thus, the mass spectrometer can replace either capnometer **38** or oxygen monitor **40** and data processing unit **50** can be programmed with the necessary calculations to determine the oxygen and carbon dioxide concentrations needed for diagnosis.

What is claimed is:

1. A device for non-invasively diagnosing abnormal respiratory function, comprising:
  - a patient breathing tube;
  - a flow meter connected to said tube;
  - an oxygen meter connector to said tube;
  - a nitrogen meter connected to said tube; and
  - a data processing unit programmed to calculate the concentration of oxygen and carbon dioxide connected to said flow meter, said oxygen meter, and said nitrogen meter.
2. The device of claim 1, wherein said nitrogen meter is a mass spectrometer.
3. A device for non-invasively diagnosing abnormal respiratory function, comprising:
  - a patient breathing tube;
  - a flow meter connected to said tube;
  - an carbon dioxide meter connector to said tube;
  - a nitrogen meter connected to said tube; and
  - a data processing unit programmed to calculate the concentration of oxygen and carbon dioxide connected to said flow meter, said carbon dioxide, and said nitrogen meter.
4. The device of claim 3, wherein said nitrogen meter is a mass spectrometer.
5. A system for non-invasively diagnosing abnormal respiratory function, comprising:
  - a patient breathing tube;
  - a flow meter connected to said tube;
  - an oxygen meter connector to said tube;
  - a carbon dioxide meter connected to said tube;
  - a spectrometer connected to said tube; and
  - a data processing unit connected to said flow meter, said oxygen meter, said carbon dioxide meter, and spectrometer, wherein said data processing unit is programmed to calculate the oxygen, carbon dioxide, and nitrogen concentrations of air in said tube and compare said concentrations to corresponding data from afflicted and normal patient populations.
6. The system of claim 5, further comprising a display screen coupled to said data processing unit for displaying said comparison of said concentrations to corresponding data from afflicted and normal patient populations.

\* \* \* \* \*

UNITED STATES PATENT AND TRADEMARK OFFICE  
**CERTIFICATE OF CORRECTION**

PATENT NO. : 7,104,964 B2  
APPLICATION NO. : 11/108363  
DATED : September 12, 2006  
INVENTOR(S) : Jeffrey A. Kline

Page 1 of 1

It is certified that error appears in the above-identified patent and that said Letters Patent is hereby corrected as shown below:

Col. 8, Claim 1, line 6, delete "connector" and substitute therefor --connected--;

Col. 8, Claim 3, line 5, delete "an" and substitute therefor --a--; delete "connector" and substitute therefor --connected--;

Col. 8, Claim 5, line 5, delete "connector" and substitute therefor --connected--.

Signed and Sealed this

Fifth Day of December, 2006

A handwritten signature in black ink on a light gray dotted background. The signature reads "Jon W. Dudas" in a cursive style.

JON W. DUDAS

*Director of the United States Patent and Trademark Office*

专利名称(译)	用于诊断肺血管闭塞的非侵入性装置和方法		
公开(公告)号	<a href="#">US7104964</a>	公开(公告)日	2006-09-12
申请号	US11/108363	申请日	2005-04-18
[标]申请(专利权)人(译)	川崎汽船一个JEFFREY		
申请(专利权)人(译)	川崎汽船JEFFREY A.		
当前申请(专利权)人(译)	夏洛特 - 梅克伦堡医院		
[标]发明人	KLINE JEFFREY A		
发明人	KLINE, JEFFREY A.		
IPC分类号	A61B5/00 A61B5/026 A61B A61B5/08 A61B5/083 A61B5/087 A61B5/091 A61B5/097 A61B5/145 A61B5/1455 B32B5/02 G01N1/22 H02M5/458		
CPC分类号	A61B5/083 A61B5/417 A61B5/091 A61B5/087 H02M5/4585 A61B5/08 A61B5/082 A61B5/0833 A61B5/0836		
其他公开文献	US20050197589A1		
外部链接	<a href="#">Espacenet</a> <a href="#">USPTO</a>		

摘要(译)

本发明涉及一种用于确定呼吸系统功能和确定是否存在肺栓塞的装置和方法。该装置包括含有传感器的装置，该传感器测量从患者肺部呼出的特定气体的量，包括先前提供给该专利的非环境气体。根据这些数据，处理器根据过期体积计算呼出气体的浓度，并在屏幕上显示结果。通过将结果与患病和健康患者群体的预定值进行比较，可以对肺栓塞的存在进行准确的确定。

