



(19) **United States**

(12) **Patent Application Publication**

(10) **Pub. No.: US 2004/0116822 A1**

Lindsey

(43) **Pub. Date:**

Jun. 17, 2004

(54) **SYSTEM AND METHOD FOR MONITORING BODY TEMPERATURE**

(52) **U.S. Cl. 600/549**

(76) **Inventor: Carol Lindsey, Austin, TX (US)**

(57) **ABSTRACT**

Correspondence Address:
TAYLOR RUSSELL & RUSSELL, P.C.
4807 SPICEWOOD SPRINGS ROAD
BUILDING ONE, SUITE 1200
AUSTIN, TX 78759 (US)

The system comprises one or more sensor devices, where each sensor device is capable of measuring a temperature at a known location of a body of a human or other animal. Each sensor transmits a temperature measurement value and sensor identification to a monitor device. The monitor device receives the temperature measurement value and sensor identification, and computes an adjusted temperature value based upon the position of the measuring sensor, body age, and time of day. The adjusted temperature value is tested for alarm conditions and displayed for use by a caretaker.

(21) **Appl. No.: 10/248,041**

(22) **Filed: Dec. 12, 2002**

Publication Classification

(51) **Int. Cl.⁷ A61B 5/00**

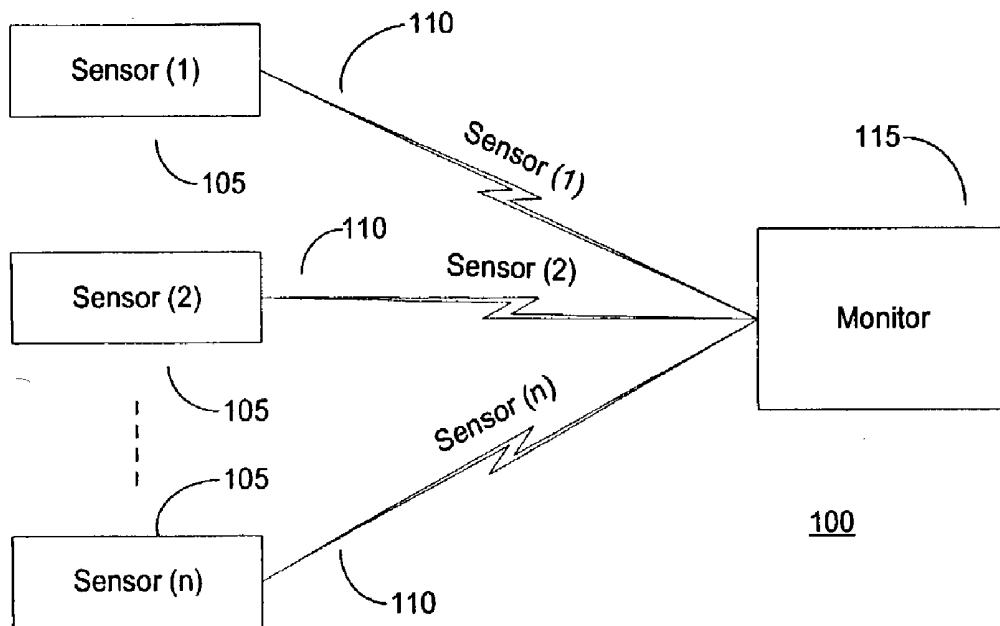

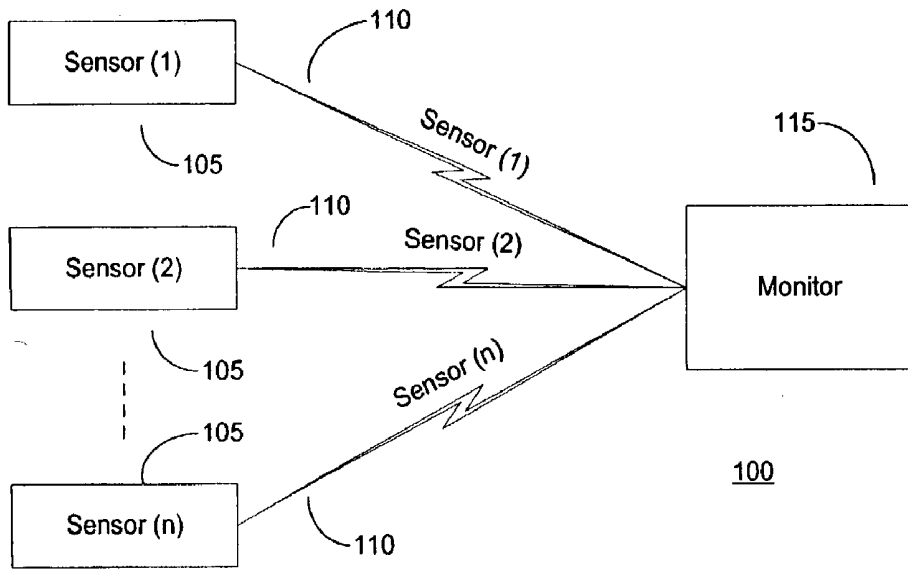

Figure 1A

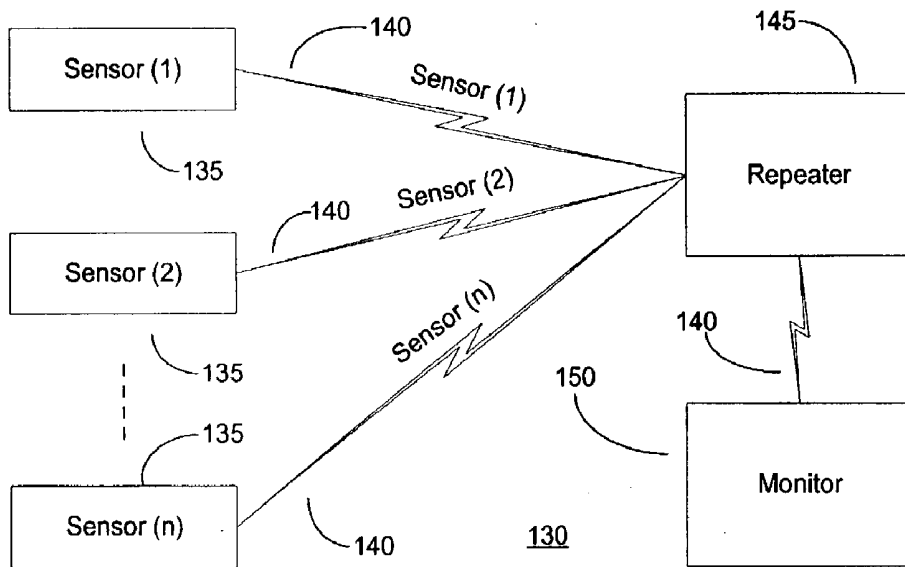

Figure 1B

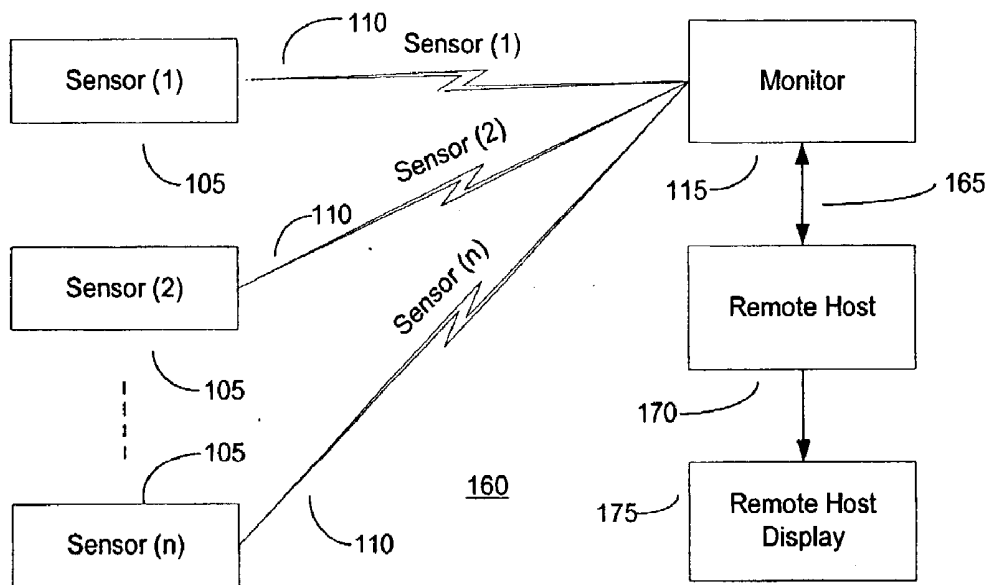

Figure 1C

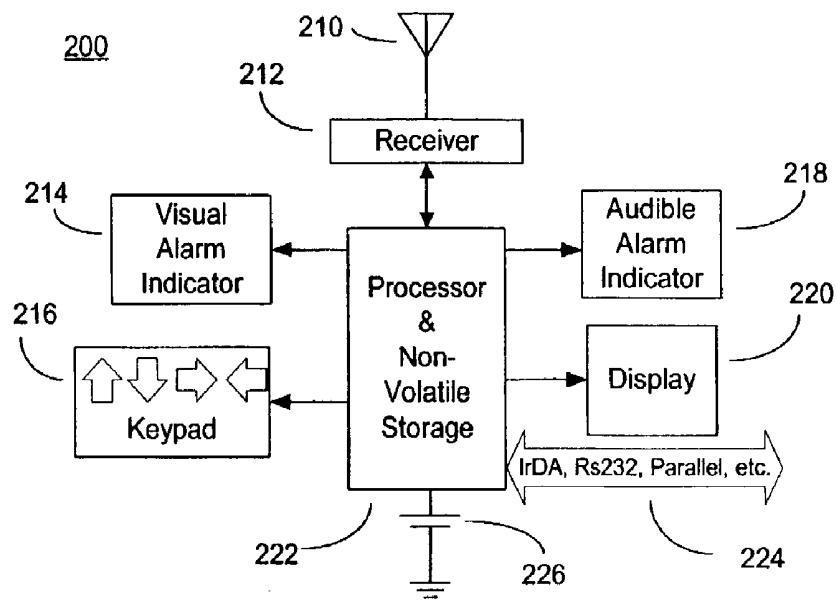

Figure 2A

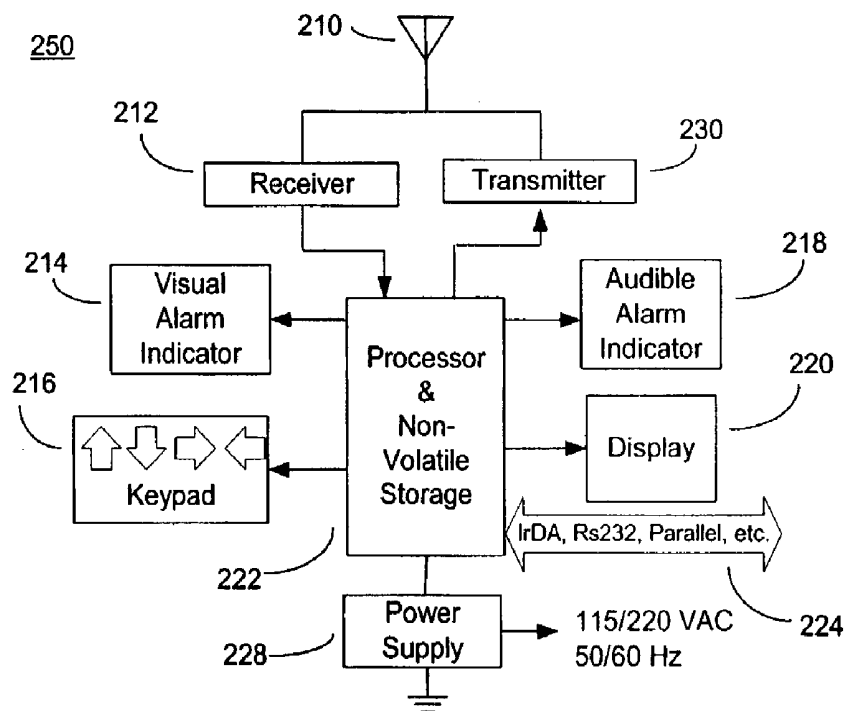

Figure 2B

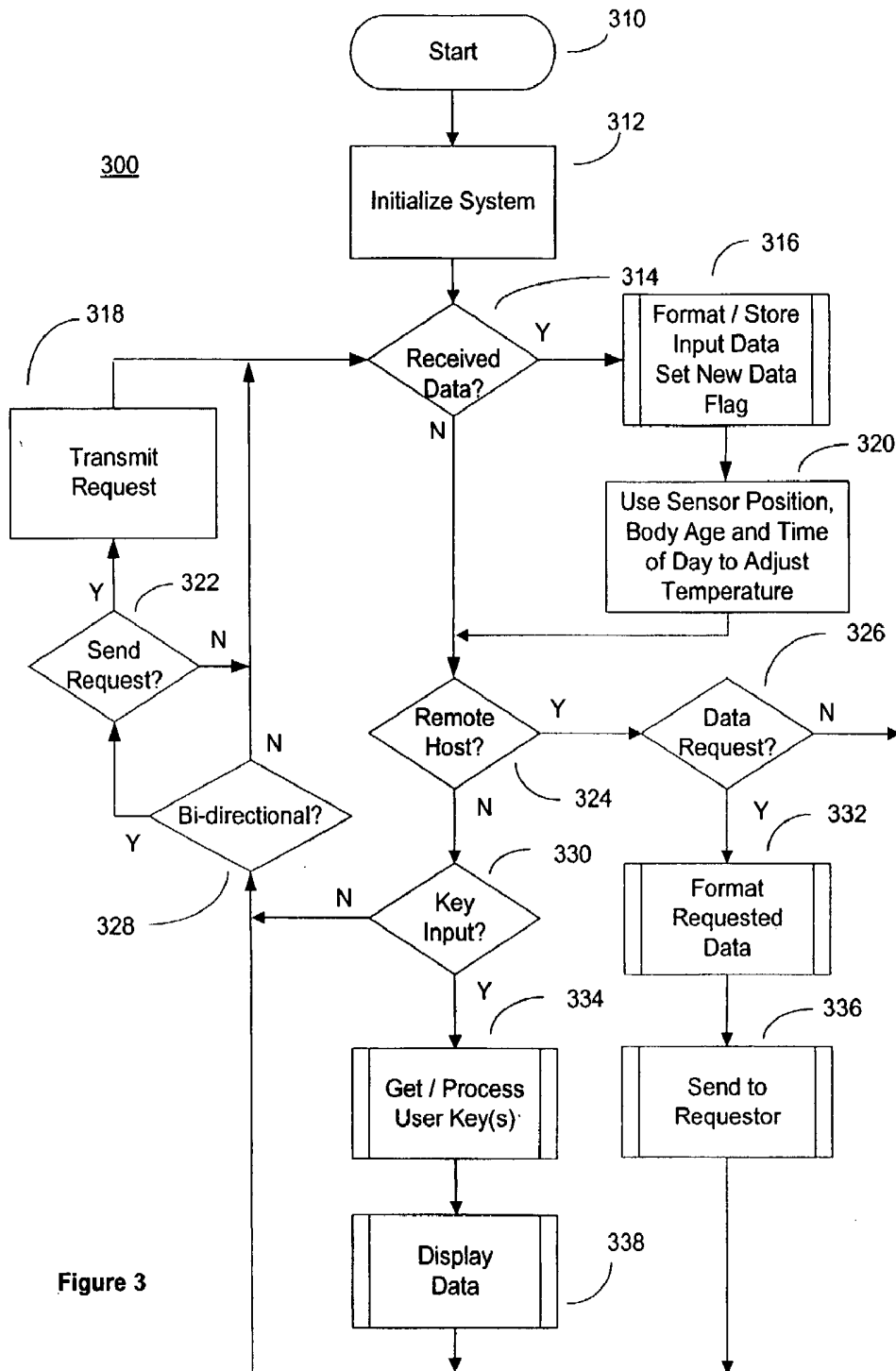

Figure 3

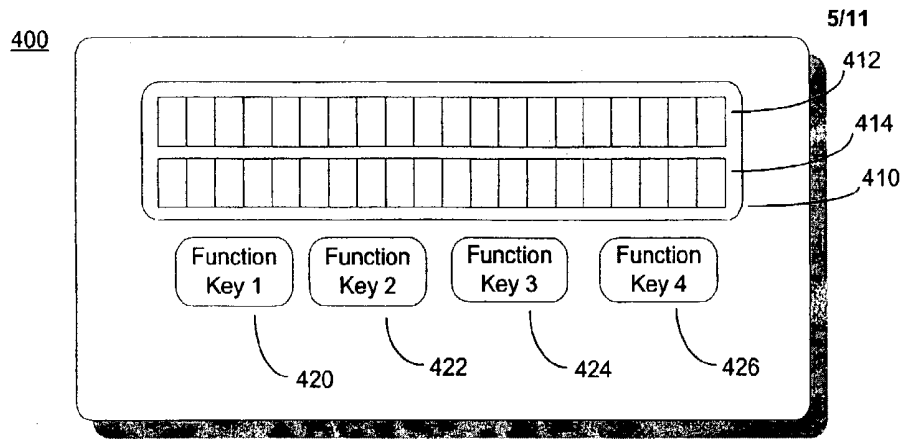

Figure 4

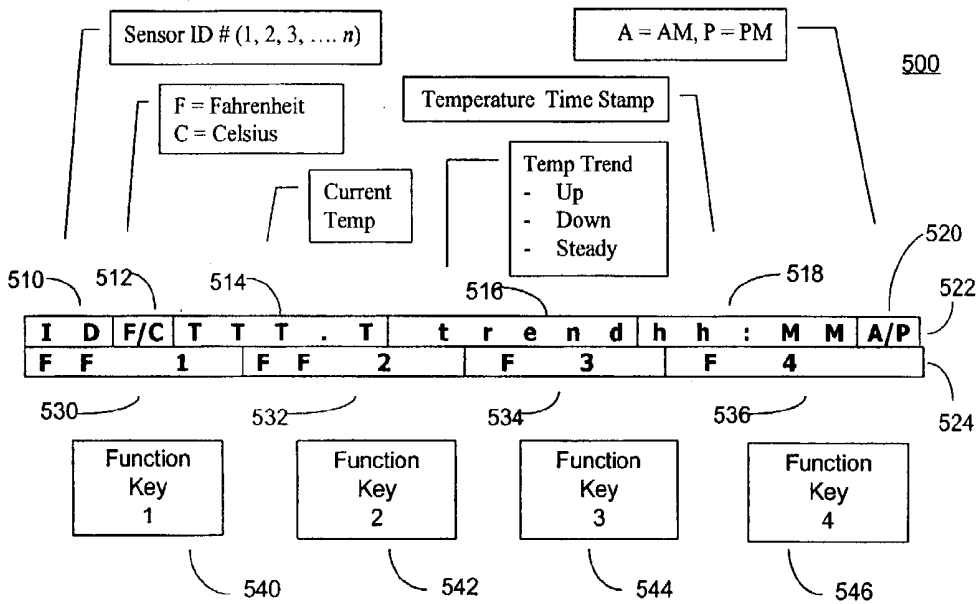

Figure 5

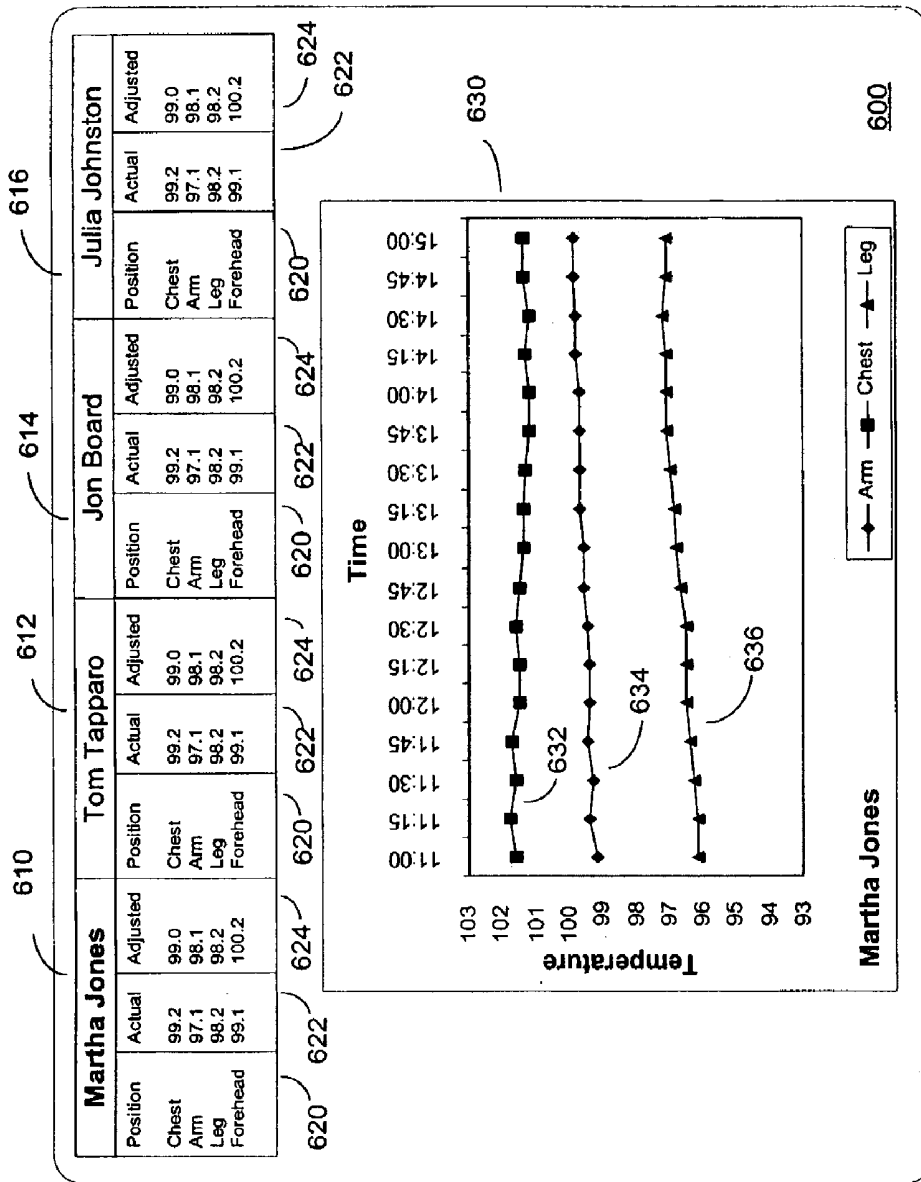

Figure 6

710	720	730	740	750	760
ID #	Unique ID	Sensor Position	Age	Upper Limit	Lower Limit

Figure 7A

	FIELD	LENGTH	DEFINITION
710	ID #	2 bytes	Sensor ID number assigned within this monitor
720	Unique ID	4 bytes	Unique sensor ID assigned during sensor manufacture
730	Sensor Position	1 byte	Indicates where sensor is located on a body
740	Age	1 byte	Indicates Age of Body
750	Upper Limit	2 bytes	Upper alarm limit
760	Lower Limit	2 bytes	Lower alarm limit

Figure 7B

810	820	830	840	850	860	870	880
End	New Entry	ID #	Status	Measured Temperature	Adjusted Temperature	Time HH:MM	Date DD:MM

Figure 8A

	FIELD	LENGTH	DEFINITION
810	End	1 bit	When set, indicates that this is the last table data entry
820	New Entry	1 bit	Indicates a new entry for sensor ID #n
830	ID #	6 bits	Sensor ID #
840	Status	1 byte	Sensor ID #(n) status
850	Measured Temp	2 bytes	Absolute temperature
860	Adjusted Temp	2 bytes	Adjusted temperature
870	Time HH:MM	2 bytes	Time stamp in <i>Hour Hour : Minute Minute</i> format
880	Date DD:MM	2 bytes	Day stamp in <i>Day Day : Month Month</i> format

Figure 8B

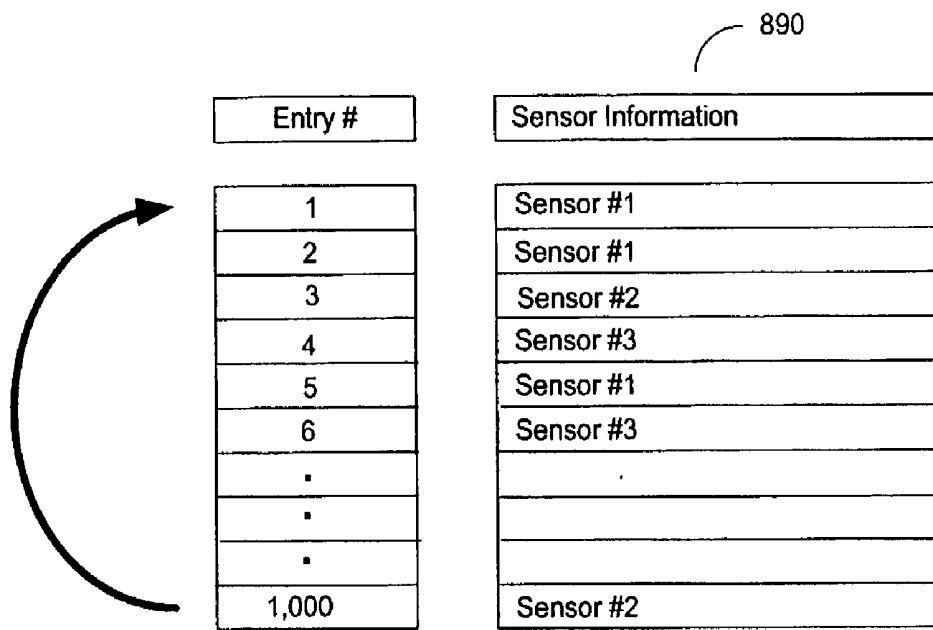

Figure 8C

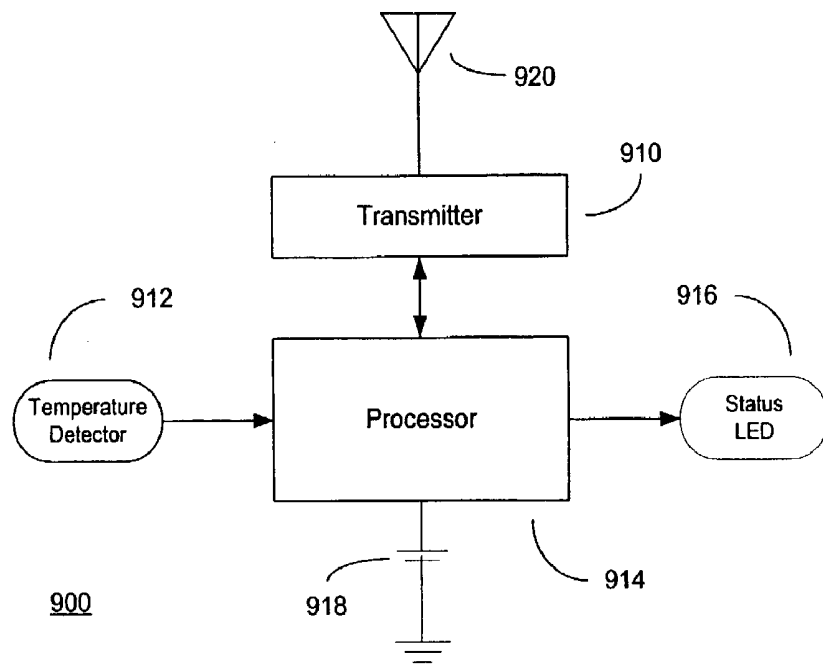

Figure 9A

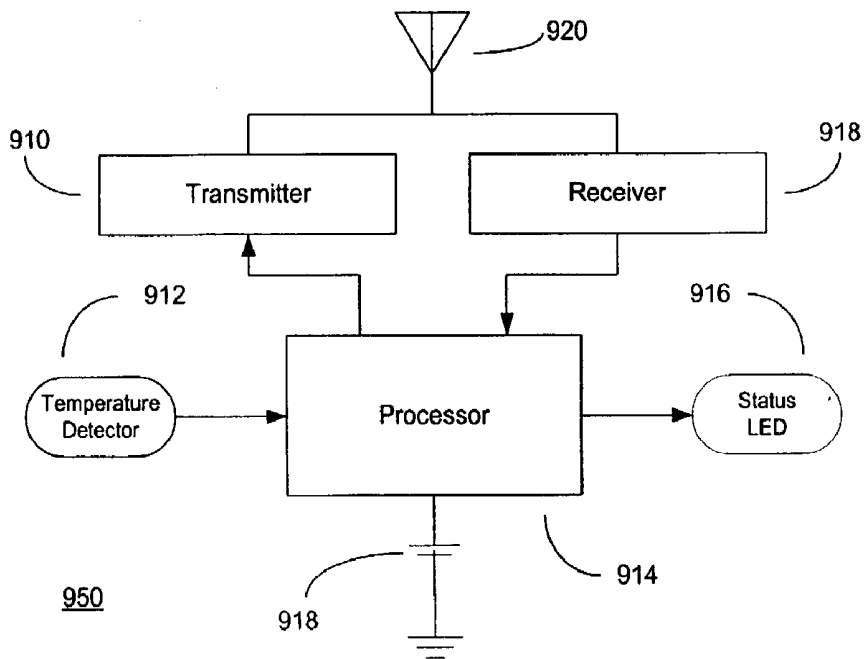

Figure 9B

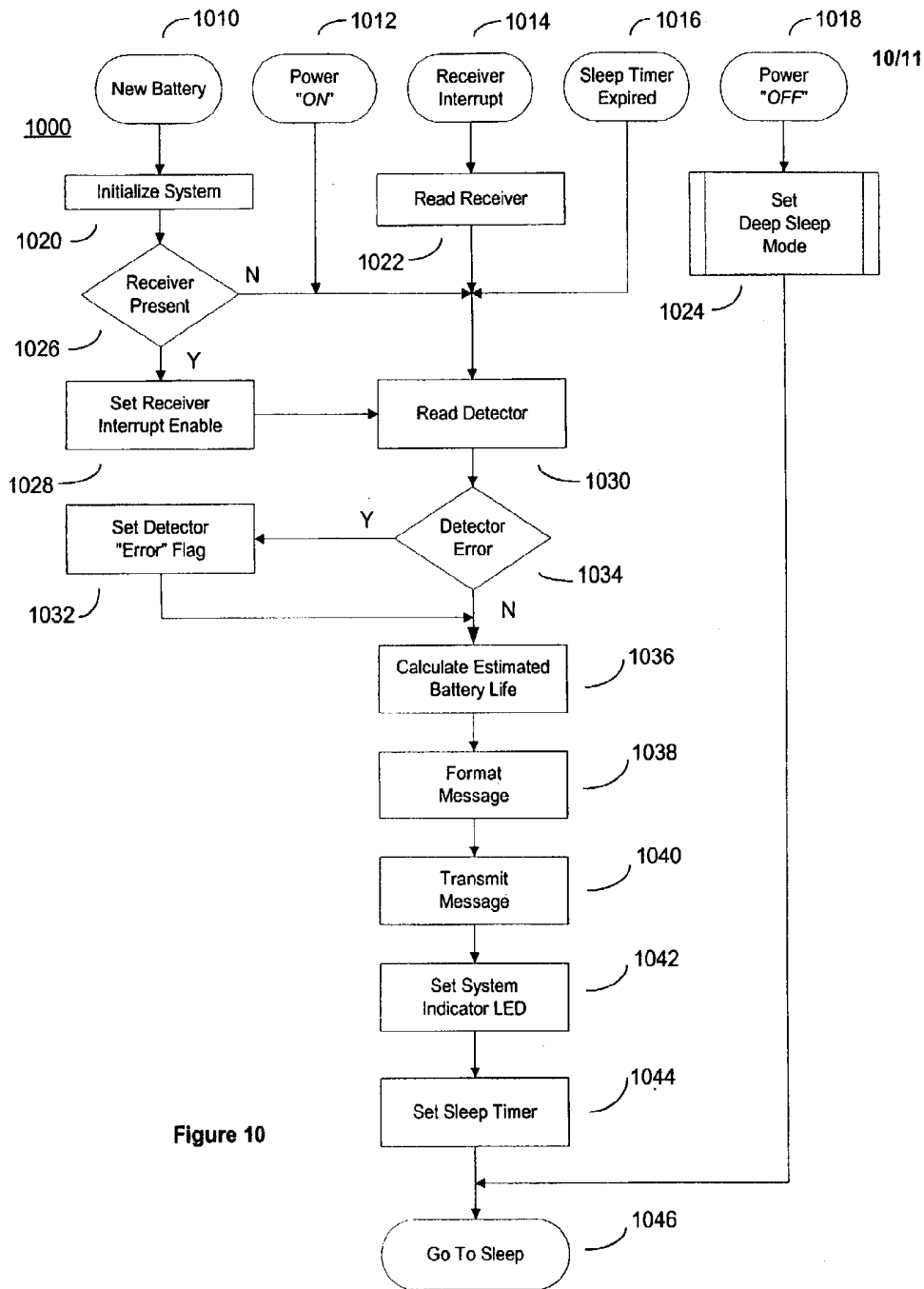

Figure 10

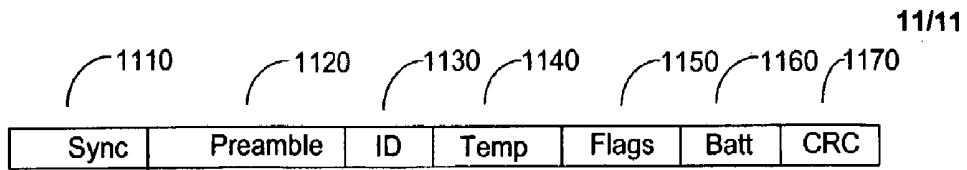

Figure 11A

	FIELD	LENGTH	DEFINITION
1110	Sync	1 byte	Predefined
1120	Preamble	1 byte	Predefined
1130	ID	4 bytes	Unique ID assigned during sensor manufacture
1140	Temp	2 bytes	Temperature data
1150	Flags	1 byte	Status flags
1160	Batt	2 bytes	Estimated remaining battery life
1170	CRC	2 bytes	Cyclic redundancy check

Figure 11B

SYSTEM AND METHOD FOR MONITORING BODY TEMPERATURE

BACKGROUND OF INVENTION

[0001] The invention relates generally to the field of healthcare monitoring, and more particularly to a system and method for wireless temperature monitoring of human or other animals in a home, clinical or institutional setting. It provides a capability of adjusting temperature readings depending upon a body age, a temperature sensor position on the body, and time of day.

[0002] One of the most common methods of monitoring the condition of a human or other animal body is by monitoring the body temperature. This is particularly important when a body is suffering from an illness, and particularly febrile or fever producing infections. Mercury filled glass thermometers have historically been the standard for measuring body temperature. Using conventional thermometers, body temperature is most accurately measured by taking oral, tympanic (ear), axillary (armpit), or rectal temperature readings. Because of the potential health and safety risk resulting from the use of mercury filled glass thermometers and the reduction in the price of digital thermometers, consumers are increasingly turning to digital thermometers distributed by large drugstore chains and discount department stores for monitoring body temperature. Because of the large number of children under the age of five years and the growing aging population in the United States, there is a need for new temperature monitoring products that are medically accurate, safe, comfortable, easy to use, and operationally reliable.

[0003] While the present invention is applicable to people of all ages, it is more likely to find application in monitoring body temperatures of children, elderly individuals and those suffering from an illness. Children under the age of five who are kept at home generally encounter at least six febrile infections a year. This number increases by about fifty percent if the child attends a daycare center and is exposed to other children. Even though this number decreases somewhat between the ages of five and sixteen years, it is still common to experience several episodes of febrile infections per year at age sixteen. Since young children are oftentimes unable to understand or communicate when they may urgently need assistance, parents and other caretakers must be vigilant to determine the need for medical evaluation or therapy for these children. This is especially true at night when parents are apt to be sleeping. Although excessive or rapidly increasing temperature of the body is a more common cause of health concern, it is oftentimes equally important to monitor low or rapidly decreasing body temperature to be in a position to take remedial action, especially in the case of elderly patients.

[0004] Since caretakers may also be family members of the sick as well as professional caretakers, they may also require rest and schedule flexibility in order to handle the demands of the sick family member as well as other demands and responsibilities of home and work. This often requires that the family caretaker endure an interrupted nights sleep in order to monitor a sick family member's temperature on a regular basis throughout the night, even though the sick family member's temperature remains within a nominally acceptable range. This regimen of

repeated temperature measurements may be further compounded by diurnal variations in a patient's temperature as well as temporary responses to fever-reducing drugs, even though the fever appears to have subsided. This requirement for repeated temperature measurements also disrupts the patient's sleep when using conventional or digital thermometers. The result may be missed temperature measurements and sleep deprivation for both the caretaker and patient.

SUMMARY OF INVENTION

[0005] The present invention provides a method and system for monitoring body temperature that is medically accurate, safe, comfortable, easy to use, and operationally reliable. It provides not only a continuous monitoring of body temperature, it also provides for notifying a caretaker when adjustable temperature alarm limits are exceeded. This reduces the time required for monitoring temperature by professional caretakers and enables family caretakers to get an uninterrupted night's sleep, if temperature alarm limits are not exceeded. It also enables the patient to get an uninterrupted night's sleep if temperature alarm limits are not exceeded. Another medically important parameter to monitor is the rate of change of body temperature. Alarm limits may be set for notifying a caretaker when temperature rate of change exceeds the adjustable alarm limits. The system may be readily used in an institutional, clinical, or home setting, and may be used to monitor a single temperature sensor affixed to a body or a multitude of temperature sensors.

[0006] The invention is a temperature monitoring system consisting of a small sensor, a transmitter, and a receiver. The sensor may be attached to various locations on a body. There are numerous methods of attaching the sensor in a position to sense body temperature, including placement in a pocket of an adhesive strip or in a pocket pouch sewn into the armpit area of a person's shirt or nightgown. An elasticized panel is sewn into the shoulder armpit area in a manner that would not restrict the wearer's freedom of movement but would exert steady and gentle pressure on the sensor to keep it against the body. The sensor may also be secured to an appendage or other body locations. The cloth between the sensor and the skin, if any, is thin and highly heat conductive so as to allow accurate temperature readings. The sensor can be removed from the garment for washing but is difficult for a child to remove due to the number and size of snaps on the pocket. The adhesive strip is intended for children who may be tempted to remove a probe or other sensor. The garment is intended for children who may be tempted to remove a sensor if an adhesive strip was used. A sub-cutaneous version of the sensor may also be positioned under the skin of a human or other animal.

[0007] The system may provide alerts to a caretaker by computing two different body temperature parameters, absolute temperature alarm limits and temperature trend alarm limits. If the body temperature exceeds a specified maximum or falls below a specified minimum level, an alarm may be activated. If the body temperature changes at a specified rate or faster, the alarm will also be activated. Different audible alarm sounds may be used, depending on why the alarm was activated. The system may also include a low battery alarm. Alarms may also provide for an escalating audible volume.

[0008] The monitor houses the means to either receive temperature readings from the sensor using unidirectional

communications or actively seek readings from the sensor upon request or at certain time intervals, using bi-directional communications. The monitor is located in the vicinity of a caretaker and detects whether an alarm condition exists based upon the temperature readings it receives from the sensor. The monitor may be easily carried by a caretaker throughout the vicinity of one or more sensors and may house an LCD display that indicates sensor identification, adjusted temperature, temperature trend, and a temperature time stamp. The monitor may include a memory function so recent temperatures could be displayed, and an alarm that sounds under the conditions described above. A version of the monitor may also include an annunciator for announcing temperature values.

[0009] The system comprises at least one monitor device and one or more temperature sensors that communicate with the monitor device using wireless technology. The monitor device is capable of displaying current temperature, and temperature trends in either Celsius or Fahrenheit degrees, as well as identifying the selected sensor and time of day. The method also allows for adjustment of measured temperature due to locating a temperature sensor on different parts of a body, the age of the body, and time of day. The monitor device provides a means for adjusting temperature alarm limits and sounding an alarm when the temperature alarm limits are exceeded.

[0010] Using conventional thermometers, body temperature is most accurately measured by taking oral, tympanic (ear), axillary (armpit), or rectal temperature readings. This is because the temperature measured at these locations is closer to the core temperature of a person's body. Since it is not practical to locate a sensor at some of these locations for periods of up to twelve hours or more, more practical locations for sensor placement include arm, trunk, leg or forehead.

[0011] Sensors may be positioned either cutaneously or sub-cutaneously. However, there are varying differences between temperatures measured at these locations and the core temperature of a person's body. Since these differences are predictable, the present invention may use sensor location, body age, and time of day to adjust the measured temperature from the sensor to an adjusted body core temperature, which is a more meaningful measure of body temperature for determining medical condition and diagnosing illnesses.

[0012] A method having features of the present invention comprises a method for monitoring body temperature that comprises the steps of measuring one or more temperature values by sensors at known locations on one or more bodies, transmitting the measured temperature values and corresponding sensor identifications from the sensors to a monitoring device, receiving the measured temperature values and corresponding sensor identifications by the monitoring device, computing adjusted temperature values from the measured temperature values based on the age, time of day, and known body locations of the corresponding sensors, and displaying the adjusted temperature values for use by a caretaker. The step of measuring may further comprise measuring at predetermined time intervals, and the step of transmitting may further comprise transmitting at the predetermined time intervals. The step of measuring may further comprise measuring in response to requests received

from the monitor, and the step of transmitting may further comprise transmitting in response to the requests received from the monitor. The method may further comprise the step of calculating estimated remaining battery life of each sensor and transmitting the estimated battery life from each sensor to the monitoring device. The method may further comprise the step of detecting sensor errors/status, setting sensor error/status flags, and transmitting the sensor error/status flags from each sensor to the monitoring device. The method may further comprise the step of activating a sensor status indicator. The method may further comprise the step of switching the sensor to a low power mode when not measuring and transmitting. The step of transmitting the measured temperature values may comprise transmitting the measured temperature values via a wireless communication link, and the step of receiving the measured temperature values may comprise receiving the measured temperature values via a wireless communication link. The step of transmitting the measured temperature values may comprise transmitting the measured temperature values via a wireless area network, and the step of receiving the measured temperature values may comprise receiving the measured temperature values via a wireless area network. The step of displaying the adjusted temperature values may comprise displaying the adjusted temperature values via a multi-line display. The step of displaying the adjusted temperature values may comprise displaying the adjusted temperature values on a remote host display. The method may further comprise the step of selecting a sensor identification for displaying adjusted temperature values using a programmable keypad. The method may further comprise the step of providing visual alarm indication. The method may further comprise the step of providing audible alarm indication. The method may further comprise the step of setting upper and lower alarm limit values. The method may further comprise the step of setting upper and lower trend alarm limit values. The method may further comprise the step of computing adjusted temperature values from the measured temperature values based on the age of the body and time of day. The method may further comprise the step of positioning the sensors at locations selected from the group consisting of cutaneous locations, sub-cutaneous locations, appendages, trunk, neck and head. The method may further comprise the step of annunciating a selected adjusted temperature by the monitoring device. The audible alarm indication may be a time escalating volume audible alarm indication. The method may further comprise the step of providing an audible and text message display for alerting a caretaker of off-normal conditions. The method may further comprise the steps of calculating a cyclic redundancy check value within the sensor devices for the data to be transmitted, transmitting the cyclic redundancy check value with the temperature values, receiving the cyclic redundancy check values by the monitor device, computing a cyclic redundancy check value within the monitor device for the received data, and comparing the received and computed cyclic redundancy check value for error detection.

[0013] In an alternate embodiment of the present invention, a system for monitoring body temperature comprises sensor devices for measuring one or more temperature values at known locations on one or more bodies, the sensor devices for transmitting the measured temperature values and corresponding sensor identifications from the sensors to a monitoring device, a monitor device for receiving the

measured temperature values and corresponding sensor identifications, the monitor device for computing adjusted temperature values from the measured temperature values based on the known body locations of the corresponding, and means for displaying the adjusted temperature values for use by a caretaker. The system may further comprise a wireless communication link for conducting the transmitted and received temperature values and sensor identifications between the sensor devices and the monitor device. The system may further comprise a wireless area network for conducting the transmitted and received temperature values and sensor identifications between the sensor devices and the monitor device. The system may further comprise a remote host application and a remote host display for displaying adjusted temperature values to a caretaker. The monitor device may comprise an antenna connected to a receiver for receiving wireless signals from sensor devices, the receiver connected to a processor and non-volatile storage for demodulating and formatting the wireless signals, a visual alarm indicator connected to the processor, an audible alarm indicator connected to the processor, a programmable keypad connected to the processor, a display connected to the processor, an external communication means connected to the processor, and a battery for powering the circuits in the monitor device. The system may further comprise a transmitter connected between the antenna and the processor and non-volatile storage for transmitting commands and data-to sensor devices. The battery may be replaced by a power supply connected to an alternating current power source. The system may further comprise a remote host application connected to the external communication means and a remote host display connected to the remote host application for displaying adjusted historical and current temperature values for use by caretakers. The system may further comprise a sensor registration table including an entry for each sensor assigned to the monitor, the sensor registration table comprising a sensor identification number, a unique sensor registration number assigned during sensor manufacture, a sensor position indicator, body age, and upper and lower alarm limits. Each sensor device may comprise an antenna connected to a transmitter for sending wireless signals to a monitor device, the transmitter connected to a processor for modulating data and generating wireless signals, a temperature sensor connected to the processor, a status indicator connected to the processor, and a battery for powering the circuits in the sensor device. The system may further comprise a receiver connected between the antenna and the processor for receiving commands and data from the monitor device. The system may further comprise the monitor device for computing adjusted temperature values from the measured temperature values based on the age of the body and time of day. The system may further comprise means for positioning the sensors at locations selected from the group consisting of cutaneous locations, sub-cutaneous locations, appendages, trunk, neck and head. The system may further comprise the monitor device for annunciating a selected adjusted temperature by the monitoring device. The system may further comprise an audible alarm indication provided by the monitor device that is a time escalating volume audible alarm indication. The system may further comprise an audible and text message display on the monitor device for alerting a caretaker to off-normal conditions.

[0014] Another embodiment of the present invention is a system for monitoring body temperature, including one or more sensor devices and a monitor device, the monitor device comprising means for receiving a measured temperature and sensor identification over a wireless link, a processor for controlling operation of the monitor device, means for computing an adjusted temperature value from the measured temperature value using a known body location of the measuring sensor, and means for displaying the adjusted temperature value for use by caretakers. Each sensor device may comprise means for measuring temperature at a known location of a body, a processor for controlling operation of the sensor device, and means for transmitting the measured temperature value and sensor identification over a wireless communication link. The system may further comprise means for computing an adjusted temperature value from the measured temperature value using the age of the body and time of day. The sensor may be positioned at a cutaneous location. The sensor may be positioned at a sub-cutaneous location.

BRIEF DESCRIPTION OF DRAWINGS

[0015] These and other features, aspects and advantages of the present invention will become better understood with regard to the following description, appended claims, and accompanying drawings wherein:

[0016] **FIG. 1** shows system diagrams of a single monitor communicating with a multiplicity of temperature sensors;

[0017] **FIG. 2** shows block diagrams of a monitor;

[0018] **FIG. 3** shows a flow diagram that depicts monitor operation;

[0019] **FIG. 4** shows a typical user interface for a stand-alone monitor;

[0020] **FIG. 5** shows a display definition for a stand-alone monitor;

[0021] **FIG. 6** shows an example of a remote host display;

[0022] **FIG. 7** shows a definition of a sensor registration table;

[0023] **FIG. 8** shows a definition of a sensor data table;

[0024] **FIG. 9** shows block diagrams of a sensor;

[0025] **FIG. 10** shows a flow diagram that depicts sensor operation; and

[0026] **FIG. 11** shows a definition of sensor transmission data.

DETAILED DESCRIPTION

[0027] Turning now to **FIG. 1**, **FIG. 1** shows diagrams in **FIG. 1A100**, **FIG. 1B130**, and **FIG. 1C160** of systems for sensing and monitoring the temperature at locations on a body that makes use of a wireless communication link. The embodiment system **100** of **FIG. 1A** depicts a single monitor **115** communicating directly with a multiplicity of sensors **105** via wireless communication links **110**. An alternative embodiment system **130** of **FIG. 1B** depicts the use of a wireless area network **145** for linking a monitor **150** with a multiplicity of sensors **135** via a wireless area network **145** using communication links **140**. The sensors **105**, **135** are wireless devices that sense temperature at a specific location

on an individual's body and transmit the temperature information. The monitor **115, 150** is a device that receives the transmitted temperature data from the sensors **105, 135** and processes the data for display to a caretaker. The communication links **110, 140** are capable of reliable communication over distances of several hundred feet within a home or institutional setting. **FIG. 1C** depicts an augmentation to the system of **FIG. 1A**, with the addition of a remote host application **170** connected to the monitor **115**, and a remote host display **175** connected to the remote host application **170**. In this configuration **160**, the monitor **115** is typically configured without an internal display, and has the capability of interfacing to a variety of external devices via RS232 Serial, IrDA, USB, Parallel, Firewire or other compatible communication port types. This configuration **160** allows the monitor to be used in a clinical environment where the monitor is configured to observe numerous temperature sensors positioned on numerous bodies. A wide variety of processing and displays are available in this configuration **160**. The wireless communication links may comprise any one of many communication configurations, including a wireless local area network (LAN) or a wireless personal area network (PAN).

[0028] Turning now to **FIG. 2**, **FIG. 2A** and **FIG. 2B** show block diagrams of monitor devices **200, 250** for receiving, formatting, analyzing, and displaying temperature measurements from multiple assigned temperature sensors via wireless communication links. The monitor device **200, 250** alerts a caregiver when certain predefined conditions are occurring, such as temperature rising or falling, temperature has exceeded a certain value, a sensor battery life is minimal, intermittent reception from a sensor, and reception errors. These conditions may be displayed, and when enabled, alert the caregiver with various audible tones. The monitor device **200, 250** operates in a polling mode of operation, as depicted in **FIG. 3**. These configurations **200, 250** depict a monitor in a stand-alone mode and containing a user-friendly interface, such as an LCD 2x20 character display and up/down, right/left keypad, which allows a caretaker means to display the time and temperature of the sensors associated with the monitor. The monitor shown in **FIG. 2A** depicts a unidirectional receive only monitor communication configuration, and the monitor shown in **FIG. 2B** depicts a bi-directional transmit/receive monitor communication configuration. **FIG. 2A** depicts a monitor **200** that is battery operated and receives, formats, analyzes, alerts and displays temperature information supplied by each temperature sensor assigned to the monitor that is time and date stamped. Although the monitor **200** shown in **FIG. 2A** is powered by a battery **226**, it may also receive power from a power supply, as shown in **FIG. 2B**, connected to an AC power source, typically 115/220 VAC, 50/60 Hz. In the receive only configuration of **FIG. 2A**, an antenna **210** connected to a receiver **212** receives formatted temperature data from multiple sensors via wireless communication links. The receiver **212** sends the formatted temperature data to a processor and non-volatile storage **222**. A keypad **216** is also connected to the processor **222** to enable a user to select a designated temperature sensor for displaying the temperature sensor data on a display **220** connected to the processor **222**. The monitor **200** also has a visual alarm indicator **214** and an audible alarm indicator **218** for alerting a caretaker when a settable alarm limit has been exceeded. An additional voice feature may be activated that allows the monitor to

annunciate the temperature of the selected sensor over the audible alarm indicator **218**. This feature is a software Implementation within the processor **222**. The monitor may also have the capability of connecting to other devices for exchanging data through other standard communication means, such as IrDA communication, RS232 serial communication, parallel communication, USB, Firewire, etc. **224**.

[0029] **FIG. 2B** differs from **FIG. 2A** in that the monitor **250** also has a transmitter **230** connected between the antenna **210** and the processor **222** for providing bi-directional wireless communication with multiple temperature sensors, and a power supply **228** connected to an AC power source for powering the circuits in the monitor **250**. To make use of the bi-directional capabilities of the monitor **250**, the associated sensors must also have bi-directional wireless communication capability. The bi-directional communication capability enables a monitor to send address, command and response messages to the temperature sensors. This capability may provide a more reliable communication format.

[0030] Turning now to **FIG. 3**, **FIG. 3** shows a flow diagram that depicts monitor operation **300**. The monitor is a device that receives, formats, analyzes and displays the information received from its assigned sensors. The monitor also has the capability of alerting a caretaker when designated predefined conditions occur, e.g., a temperature exceeding an alarm point. The monitor operates in a polling mode by sequentially reading temperature values received from temperature sensors. When a monitor is started **310** by applying power to the device, the monitor system is initialized **312**. A test is then made to see if data has been received **314** from a sensor. If data is received **314**, it is formatted and stored, and a new data flag is set **316**. The sensor position on a body, the age of the body, and the time of day may be then used to compute an adjusted temperature **320**. If data is not received **314**, or after a new data flag has been set **316** and adjusted temperature computed **320**, a test is made to determine if a remote host is connected to the monitor **324**. If there is a remote host connected to the monitor **324** and there is a data request from the remote host **326**, the requested data is formatted **332** and sent to the requestor host **336**. Control is then directed to the step of testing for bi-directional communication **328**. If there is a remote host connected to the monitor **324** and there is no data request from the remote host **326**, control is then directed to the step of testing for bi-directional communication **328**. If there is no remote host connected to the monitor **324**, a test is made to determine if there has been a keypad input **330**. If there has not been a keypad input **330**, control is then directed to the step of testing for bi-directional communication **328**. If there has been a keypad input **330**, the user key input is processed **334** and associated data is displayed **338**, and control is then directed to the step of testing for bi-directional communication **328**. A test is conducted to determine if the monitor is utilizing bi-directional communication **328**. If not, control is returned to the step of testing for the presence of received data **314**. If bi-directional communication is being utilized **328**, a test is made to determine if it is time to send a request to a sensor for data transfer **322**. If not, control is returned to the step of testing for the presence of received data **314**. If it is determined that a new data reading from a sensor is required **322**, a transmit request is sent to an appropriate sensor **318** and control is returned to the step of testing for the presence of received data **314**.

[0031] Turning to FIG. 4, FIG. 4 shows a typical user interface 400 for a stand-alone monitor. The typical monitor user interface 400 may comprise a display 410 of two rows 412, 414 of 20 characters each using LCD display devices. Depending upon the target environment, a larger display such as a 4x20 or QVGA display may be configured into the monitor device. The first row of characters 412 could display information pertaining to a selected sensor reading, and the second row of characters 414 may be used to display functions relating to the function keys 420, 422, 424, 426. Although the display device is depicted as a 2x20 LCD character array, it may be any display device capable of displaying the required text and numbers.

[0032] Turning to FIG. 5, FIG. 5 shows a typical display definition 500 for a stand-alone monitor. A first row 522 may contain a sensor identification number 510, a Fahrenheit/Celsius indicator 512, a current temperature reading from the selected sensor 514, a temperature trend indication 516, a temperature time stamp 518, and an AM/PM indicator. A second row 524 may contain an indicator of the functions 530, 532, 534, 536 assigned to each of the four programmable function keys 540, 542, 544, 546 for providing a wide variety of functions for navigating displaying and setting conditions to be monitored.

[0033] Turning to FIG. 6, FIG. 6 shows an example 600 of a remote host display. A remote host display (175 in FIG. 1C) connects to a remote host application (170 in FIG. 1C), which connects to a monitor (115 in FIG. 1C) for providing temperature data to the host application. The remote host display is controlled by the specific host application that may be provided for the environment in which it is being used, e.g., day care, nursery, neo-natal, etc. The example display shown in FIG. 6 depicts tabular information for several individuals 610, 612, 614, 616. The tabular information for each individual shows a column indicating the position of sensors located on different parts of an individual's body 620, a column showing actual temperature measurements 622 of the sensors, and a column showing temperature measurements adjusted for the position of the sensors, age of the body and time of day 624. By selecting one of the individuals 610, the host application creates graphs of selected temperatures 630 of the selected individual over a selected time period. The graphs shown in FIG. 6 shows temperature trends from a sensor located on the selected individual's chest 632, from a sensor located on the selected individual's arm 634, and from a sensor located on the selected individual's leg 636.

[0034] Turning to FIG. 7, FIG. 7 shows a definition of a sensor registration table entry. The sensor registration table is a dynamic table that contains specific information pertaining to a specific sensors assigned to a monitor. As each sensor is assigned, an entry is created in the table for that specific sensor. FIG. 7A identifies fields in sensor table entries, including ID#710, Unique ID 720, Sensor Position 730, Age 740, Upper Limit 750, and Lower Limit 760. Each of these fields is identified, sized, and defined in FIG. 7B. The Sensor Position field 730 indicates which part of a body the sensor is associated with. Adjustment to the actual temperature reading may be applied, depending on the sensor location or area 730. Adjustment to the actual temperature reading may also be applied, depending on the age of the body or time of day 740. The Upper Limit field 750 and the Lower Limit field 760, values set by caretakers, are

limits that can be used to generate an alarm condition to notify a caretaker when a temperature has exceeded the predefined limit value. An alarm condition may also be a rate of change or trend of temperature that is indicated by the Upper Limit field 750 and the Lower Limit field 760. The alarm condition may generate any combination of audible or visual alerts.

[0035] Turning to FIG. 8, FIG. 8 shows a definition of a sensor data table entry. The sensor data table is a table used to archive sensor information as a monitor receives it. The table is circular in definition, in that once the last entry in the buffer has been used, the next location will be the first location in the table. The result is that old data from a particular sensor will be over-written by new data from that sensor. The sensor data table contains multiple entries for each sensor associated with a monitor. As sensor information is received from each sensor, the information received in the transmission is entered into the table. FIG. 8A identifies fields in the sensor data table, including End 810, New Entry 820, ID#830, Status 840, Measured Temperature 850, Adjusted Temperature 860, Time 870, and Date 880. Each of these fields is identified, sized, and defined in FIG. 8B. FIG. 8C depicts a sensor data table. The sensor data table is a dynamic table that contains all the information received by each of the sensors 890 assigned to a monitor. It is variable in length and circular in nature. After the last entry (1,000 in the example of FIG. 8C) has been logged, the next information received from any of the three sensors will be written into entry #1 location.

[0036] Turning to FIG. 9, FIG. 9 shows block diagrams of a sensor. FIG. 9A depicts a sensor that has unidirectional communication capabilities 900, and FIG. 9B depicts a sensor that has bi-directional communication capabilities 950. The sensor block diagram 950 of FIG. 9B is identical to that shown in FIG. 9A900, but with the addition of a receiver 930 connected between the antenna 920 and the processor 914. The receiver 930 provides an additional capability of bi-directional communication to enables a sensor to receive address, command and response messages from a monitor. This capability may provide a more reliable communication format. The sensor 900, 950 is a self-contained battery operated wireless device that senses and transmits temperature to a monitor. The sensor 900, 950 contains all the necessary electronics and software to sense temperature, convert the sensed temperature data, format the data, and transmit the appropriate information. As shown in FIG. 9A, the sensor 900 comprises an antenna 920 connected to a transmitter 910 for transmitting information to a monitor. The transmitter 910 connects to a processor 914, which reads data from a temperature detector 912, and may activate a status LED 916. A battery 918 is provided to power the sensor 900. The sensor 900 may contain diagnostic programs running in the processor 914 for determining if the detector 912 is connected and for determining approximate remaining battery capacity. If a failure occurs that is detected by the diagnostic program, the LED 916 may be activated.

[0037] Turning to FIG. 10, FIG. 10 shows a flow diagram that depicts sensor operation 1000. The sensor operates as a polling device when activated. When a new battery is installed, or removed and reinstalled 1010, the sensor will initialize 1020. After initialization 1020, if an ON/OFF switch is in an ON position 1012 and there is no receiver

present **1026**, the sensor will start polling by reading the temperature detector **1030**. If the ON/OFF switch is in the OFF position **1018**, the sensor will enter a deep sleep mode **1024**. All stored information is lost when a battery is removed. If there is a receiver present **1026**, the sensor will set a receiver interrupt enable **1028** and initiate a polling operation by reading the temperature detector **1030**. Subsequently, when a receiver interrupt occurs **1014**, the sensor reads the receiver **1022** to identify a command and initiate a polling operation by reading the temperature detector **1030**. During normal operation, the sensor will always put itself into some type of sleep mode to conserve battery power. The level of sleep depends on the ON/OFF switch. In the OFF position **1018**, the sensor enters into a deep sleep mode **1024** whereby it only maintains its configuration parameters and enables interrupt capability. In the ON position, the sensor runs its polling loop, transmits information and then will enter into a predetermined sleep mode **1016**. After the predetermined amount of time, the sensor will awake **1016** and conduct polling operations. The polling loop generally follows a repetitive sequence. After the temperature detector is read **1030**, the sensor determines if a detector error has occurred **1034**. If a detector error has occurred **1034**, a detector error flag is set **1032** and the polling operation continues. If a detector error has not occurred **1034**, the polling operation continues by calculating an estimated remaining battery life **1036**, formatting a message to be transmitted **1038**, transmitting the message to a monitor **1040**, setting the system indicator **1042**, setting a sleep timer **1044** and entering a normal sleep mode **1046** for a predetermined period of time or until a receiver interrupt occurs **1014**. When the normal sleep timer has expired **1016** or a receiver interrupt occurs **1014**, the polling operation is again initiated by reading the temperature detector **1030**. The sensor will continue to transmit information until the ON/OFF switch is placed in the OFF position or the battery is removed.

[0038] Turning to **FIG. 11**, **FIG. 11** shows a definition of sensor transmission data. The sensor transmits data at a pre-determined interval. **FIG. 11A** identifies fields in a data transmission, including Sync **1110**, Preamble **1120**, ID **1130**, Temp **1140**, Flags **1150**, Batt **1160** and CRC **1170**. Each of these fields is identified, sized, and defined in **FIG. 11B**. The rate at which the sensor transmits information to the monitor may vary depending on the temperature sensing device used.

[0039] Although the present invention has been described in detail with reference to certain preferred embodiments, it should be apparent that modifications and adaptations to those embodiments might occur to persons skilled in the art without departing from the spirit and scope of the present invention.

1. A method for monitoring body temperature, comprising the steps of:

measuring one or more temperature values by sensors at known locations on one or more bodies;

transmitting the measured temperature values and corresponding sensor identifications from the sensors to a monitoring device;

receiving the measured temperature values and corresponding sensor identifications by the monitoring device;

computing adjusted temperature values from the measured temperature values based on the known body locations of the corresponding sensors; and

displaying the adjusted temperature values for use by a caretaker.

2. The method of claim 1, wherein:

the step of measuring further comprises measuring at predetermined time intervals; and

the step of transmitting further comprises transmitting at the predetermined time intervals.

3. The method of claim 1, wherein:

the step of measuring further comprises measuring in response to requests received from the monitor; and

the step of transmitting further comprises transmitting in response to the requests received from the monitor.

4. The method of claim 1, further comprising the step of calculating estimated remaining battery life of each sensor and transmitting the estimated battery life from each sensor to the monitoring device.

5. The method of claim 1, further comprising the step of detecting sensor errors/status, setting sensor error/status flags, and transmitting the sensor error/status flags from each sensor to the monitoring device.

6. The method of claim 1, further comprising the step of activating a sensor status indicator.

7. The method of claim 1, further comprising the step of switching the sensor to a low power mode when not measuring and transmitting.

8. The method of claim 1, wherein:

the step of transmitting the measured temperature values comprises transmitting the measured temperature values via a wireless communication link; and

the step of receiving the measured temperature values comprises receiving the measured temperature values via a wireless communication link.

9. The method of claim 1, wherein:

the step of transmitting the measured temperature values comprises transmitting the measured temperature values via a wireless area network; and

the step of receiving the measured temperature values comprises receiving the measured temperature values via a wireless area network.

10. The method of claim 1, wherein the step of displaying the adjusted temperature values comprises displaying the adjusted temperature values via a multi-line display.

11. The method of claim 1, wherein the step of displaying the adjusted temperature values comprises displaying the adjusted temperature values on a remote host display.

12. The method of claim 1, further comprising the step of selecting a sensor identification for displaying adjusted temperature values using a programmable keypad.

13. The method of claim 1, further comprising the step of providing visual alarm indication.

14. The method of claim 1, further comprising the step of providing audible alarm indication.

15. The method of claim 1, further comprising the step of setting upper and lower alarm limit values.

16. The method of claim 1, further comprising the step of setting upper and lower trend alarm limit values.

17. The method of claim 1, further comprising the step of computing adjusted temperature values from the measured temperature values based on the age of the body and time of day.

18. The method of claim 1, further comprising the step of positioning the sensors at locations selected from the group consisting of cutaneous locations, sub-cutaneous locations, appendages, trunk, neck and head.

19. The method of claim 1, further comprising the step of annunciating a selected adjusted temperature by the monitoring device.

20. The method of claim 14, wherein the audible alarm indication is a time escalating volume audible alarm indication.

21. The method of claim 1 further comprising the step of providing an audible and text message display for alerting a caretaker of off-normal conditions.

22. The method of claim 1, further comprising the steps of: calculating a cyclic redundancy check value within the sensor devices for the data to be transmitted;

transmitting the cyclic redundancy check value with the temperature values;

receiving the cyclic redundancy check values by the monitor device;

computing a cyclic redundancy check value within the monitor device for the received data; and

comparing the received and computed cyclic redundancy check value for error detection.

23. A system for monitoring body temperature, comprising:

sensor devices for measuring one or more temperature values at known locations on one or more bodies;

the sensor devices for transmitting the measured temperature values and corresponding sensor identifications from the sensors to a monitoring device;

a monitor device for receiving the measured temperature values and corresponding sensor identifications;

the monitor device for computing adjusted temperature values from the measured temperature values based on the known body locations of the corresponding; and

means for displaying the adjusted temperature values for use by a caretaker.

24. The system of claim 23, further comprising a wireless communication link for conducting the transmitted and received temperature values and sensor identifications between the sensor devices and the monitor device.

25. The system of claim 23, further comprising a wireless area network for conducting the transmitted and received temperature values and sensor identifications between the sensor devices and the monitor device.

26. The system of claim 23, further comprising a remote host application and a remote host display for displaying adjusted temperature values to a caretaker.

27. The system of claim 23, wherein the monitor device comprises:

an antenna connected to a receiver for receiving wireless signals from sensor devices;

the receiver connected to a processor and non-volatile storage for demodulating and formatting the wireless signals;

a visual alarm indicator connected to the processor;

an audible alarm indicator connected to the processor;

a programmable keypad connected to the processor;

a display connected to the processor;

an external communication means connected to the processor; and

a battery for powering the circuits in the monitor device.

28. The system of claim 27, further comprising a transmitter connected between the antenna and the processor and non-volatile storage for transmitting commands and data to sensor devices.

29. The system of claim 28, wherein the battery is replaced by a power supply connected to an alternating current power source.

30. The system of claim 27, further comprising a remote host application connected to the external communication means and a remote host display connected to the remote host application for displaying adjusted historical and current temperature values for use by caretakers.

31. The system of claim 27, further comprising a sensor registration table including an entry for each sensor assigned to the monitor, the sensor registration table comprising:

a sensor identification number;

a unique sensor registration number assigned during sensor manufacture;

a sensor position indicator;

body age; and

upper and lower alarm limits.

32. The system of claim 23, wherein each sensor device comprises:

an antenna connected to a transmitter for sending wireless signals to a monitor device;

the transmitter connected to a processor for modulating data and generating wireless signals;

a temperature sensor connected to the processor;

a status indicator connected to the processor; and

a battery for powering the circuits in the sensor device.

33. The system of claim 32, further comprising a receiver connected between the antenna and the processor for receiving commands and data from the monitor device.

34. The system of claim 23, further comprising the monitor device for computing adjusted temperature values from the measured temperature values based on the age of the body and time of day.

35. The system of claim 23, further comprising means for positioning the sensors at locations selected from the group consisting of cutaneous locations, sub-cutaneous locations, appendages, trunk, neck and head.

36. The system of claim 23, further comprising the monitor device for annunciating a selected adjusted temperature by the monitoring device.

37. The system of claim 23, further comprising an audible alarm indication provided by the monitor device that is a time escalating volume audible alarm indication.

38. The system of claim 23, further comprising an audible and text message display on the monitor device for alerting a caretaker to off-normal conditions.

39. A system for monitoring body temperature, including one or more sensor devices and a monitor device, the monitor device comprising:

means for receiving a measured temperature and sensor identification over a wireless link;

a processor for controlling operation of the monitor device;

means for computing an adjusted temperature value from the measured temperature value using a known body location of the measuring sensor; and

means for displaying the adjusted temperature value for use by caretakers.

40. The system of claim 39, wherein each sensor device comprises:

means for measuring temperature at a known location of a body;

a processor for controlling operation of the sensor device; and

means for transmitting the measured temperature value and sensor identification over a wireless communication link.

41. The system of claim 39, further comprising means for computing an adjusted temperature value from the measured temperature value using the age of the body and time of day.

42. The system of claim 39, wherein the sensor is positioned at a cutaneous location.

43. The system of claim 39, wherein the sensor is positioned at a sub-cutaneous location.

* * * * *

专利名称(译)	用于监测体温的系统和方法		
公开(公告)号	US20040116822A1	公开(公告)日	2004-06-17
申请号	US10/248041	申请日	2002-12-12
[标]申请(专利权)人(译)	LINDSEY CAROL		
申请(专利权)人(译)	LINDSEY CAROL		
当前申请(专利权)人(译)	ALERT CARE , INC.		
[标]发明人	LINDSEY CAROL		
发明人	LINDSEY, CAROL		
IPC分类号	A61B5/01 G01K1/02 G01K13/00 A61B5/00		
CPC分类号	G01K1/024 Y10S128/903 G01K13/002		
其他公开文献	US7004910		
外部链接	Espacenet USPTO		

摘要(译)

该系统包括一个或多个传感器装置，其中每个传感器装置能够测量人或其他动物的身体的已知位置处的温度。每个传感器将温度测量值和传感器标识传输到监视器设备。监视器装置接收温度测量值和传感器识别，并基于测量传感器的位置，身体年龄和一天中的时间计算调节的温度值。调整温度值以测试警报条件并显示以供看护人使用。

