



(11) **EP 1 770 352 B1**

(12) **EUROPEAN PATENT SPECIFICATION**

(45) Date of publication and mention of the grant of the patent:
02.07.2008 Bulletin 2008/27

(51) Int Cl.:
G01B 9/02 ^(2006.01) **A61B 5/00** ^(2006.01)
G01N 21/47 ^(2006.01)

(21) Application number: **06020527.5**

(22) Date of filing: **29.09.2006**

(54) **Optical tomography system**

Vorrichtung zur optischen Tomographie

Système optique de tomographie

(84) Designated Contracting States:
DE FR GB

(30) Priority: **30.09.2005 JP 2005289119**

(43) Date of publication of application:
04.04.2007 Bulletin 2007/14

(73) Proprietor: **FUJIFILM Corporation**
Minato-ku
Tokyo (JP)

(72) Inventor: **Kuroiwa, Karin**
Ashigarakami-gun,
Kanagawa-ken (JP)

(74) Representative: **Klunker . Schmitt-Nilson . Hirsch**
Winzererstrasse 106
80797 München (DE)

(56) References cited:
EP-A2- 1 704 814 **WO-A2-20/05001401**
JP-A- 10 332 329

- **HUBER R ET AL: "Fourier domain mode locked lasers for OCT imaging at up to 290 kHz sweep rates" PROCEEDINGS OF THE SPIE - THE INTERNATIONAL SOCIETY FOR OPTICAL ENGINEERING SPIE-INT. SOC. OPT. ENG USA, vol. 5861, no. 1, 2005, pages 58611B-1, XP002415696 ISSN: 0277-786X**

EP 1 770 352 B1

Note: Within nine months of the publication of the mention of the grant of the European patent in the European Patent Bulletin, any person may give notice to the European Patent Office of opposition to that patent, in accordance with the Implementing Regulations. Notice of opposition shall not be deemed to have been filed until the opposition fee has been paid. (Art. 99(1) European Patent Convention).

Description

BACKGROUND OF THE INVENTION

5 Field of the Invention

[0001] This invention relates to an optical tomography system for obtaining an optical tomographic image by measurement of OCT (optical coherence tomography).

10 Description of the Related Art

[0002] As a system for obtaining a tomographic image of an object of measurement in a body cavity, there has been known an ultrasonic tomography system. In addition to such an ultrasonic tomography system, there has been proposed an optical tomography system where an optical tomographic image is obtained on the basis of an interference of light by low coherence light. See, for instance, Japanese Unexamined Patent Publication No. 2003-172690. In the system disclosed in Japanese Unexamined Patent Publication No. 2003-172690, an optical tomographic image is obtained by measuring TD-OCT (time domain OCT) and the measuring light is guided into the body cavity by inserting a probe into the body cavity from the forceps port of an endoscope by way of a forceps channel.

[0003] More specifically, low coherence light emitted from a light source is divided into measuring light and reference light and the measuring light is projected onto the object of measurement, while the reflected light from the object of measurement is led to a multiplexing means. The reference light is led to the multiplexing means after its optical path length is changed. By the multiplexing means, the reflected light and the reference light are superposed one on another, and interference light due to the superposition is detected by, for instance, heterodyne detection. In the TD-OCT measurement, a phenomenon that interference light is detected when the optical path of the measuring light conforms to the optical path of the reference light in length is used and the measuring position (the depth of measurement) in the object is changed by changing the optical path length of the reference light.

[0004] When measuring the OCT by inserting a probe into a body cavity, the probe is mounted on the system body to be demountable since disinfection, cleaning and the like of the probe after use are necessary. That is, a plurality of probes are prepared for one optical tomography system and the probes are changed by the measurement. However there is an individual difference in the length of the optical fiber due to the manufacturing errors and the like, and the optical path length of the measuring light can change each time the probe is changed. Accordingly, in Japanese Unexamined Patent Publication No. 2003-172690, on the basis of the reflected light from the inner surface of a tube (sheath) covering an optical fiber of the probe, the optical path length of the reference light is adjusted to conform to the optical path length of the measuring light.

[0005] Whereas, as a system for rapidly obtaining a tomographic image without changing the optical path length of the reference light such as disclosed above, there has been proposed an SS-OCT (swept source OCT) system where interference light is detected while the frequency of the light emitted from the light source is changed with time. In the SS-OCT system, an interferogram interference intensity signal is obtained without changing the optical path length by sweeping the frequency of the laser beam emitted from the light source to cause the reflected light and the reference light to interfere with each other by the use of a Michelson interferometer. Then a tomographic image is generated by carrying out a Fourier analysis on the interferogram signal in the region of an optical frequency.

[0006] WO-A-2005 001 401 describes an optical tomography system with a light source emitting light while sweeping the wavelength thereof. A beam splitter divides this light into a measuring beam directed to a sample and a reference beam directed to a mirror. The reflected beams from both paths are brought to interference, detected and tomographic information is obtained. The sweeping of the wavelength is realised through a rotating mirror which is controlled by a motor driver to rotate up to 15700 rps.

SUMMARY OF THE INVENTION

[0007] In the SS-OCT measurement, it is not necessary to conform the optical path length of the measuring light to that of the reference light since information on the reflection in positions in the direction of depth can be obtained by carrying out frequency-analysis. However, there arises a problem that when the optical path length difference becomes large, the spatial frequency of the interference signal is enlarged and the S/N of the detected interference signal deteriorates due to limitation on the sampling time of the photodiodes such as CCDs for detecting the interference light. Accordingly, also in the SS-OCT measurement, it is still necessary to adjust the optical path length so that the optical path length of the measuring light substantially conforms to that of the reference light and the measurement initiating position is adjusted to a position in which the object is included in the measurable range.

[0008] The measurable range (measuring depth) over which a tomographic image is obtainable by the SS-OCT

measurement is reverse proportional to the fluctuation width of the wavelength per unit time of the light source, and the resolution in the direction of the optical axis when a tomographic image is obtained increases as the fluctuation width of the wavelength per unit time of the light source becomes wider. That is, the measurable range (measuring depth) becomes narrow when a tomographic image is obtained at a high resolution in a predetermined time. Accordingly, it takes a long time to bring the optical path length difference between the measuring light and the reference light to the measurable range since the measurable range (measuring depth) is narrow to obtain a tomographic image in order to adjust the measurement initiating position in an SS-OCT system for obtaining a high resolution tomographic image. Similarly, there is a problem that when layer structure such as of the stomach wall is to be observed, the tomographic image thereof cannot be obtained due to the measurable range (measuring depth).

[0009] In view of the foregoing observations and description, the primary object of the present invention is to provide an optical tomography system where a tomographic information is obtained by projecting the measuring light onto the object while sweeping at the wavelength of the measuring light and carrying out frequency-analysis on the interference light at that time which can be switched in its measurable range (measuring depth) according to the application and is improved in convenience.

[0010] In accordance with the present invention, there is provided an optical tomography system for obtaining a tomographic image of an object to be measured comprising a light source unit which emits light while sweeping the wavelength thereof at predetermined periods, a light dividing means which divides the light emitted from the light source unit into measuring light and reference light, a multiplexing means which multiplexes the reflected light from the object when the measuring light divided by the light dividing means is projected onto the object and the reference light, an interference light detecting means which detects interference light of the reflected light and the reference light which have been multiplexed by the multiplexing means, and a tomographic information obtaining means which obtains a tomographic information of the object by carrying out frequency-analysis on the interference light detected by the interference light detecting means, a detecting mode control means which switches between a first detecting mode in which the interference light is detected at a first wavelength resolution and a second detecting mode in which the interference light is detected at a second wavelength resolution higher than the first wavelength resolution being provided.

[0011] Since the wavelength is an inverse of the frequency, the expression "a first detecting mode in which the interference light is detected at a first wavelength resolution and a second detecting mode in which the interference light is detected at a second wavelength resolution higher than the first wavelength resolution" can be expressed in other words "a first detecting mode in which the interference light is detected at a first frequency resolution and a second detecting mode in which the interference light is detected at a second frequency resolution higher than the first frequency resolution". Similarly, the light source unit 10 may be expressed in other words "a light source unit which emits light while sweeping the frequency thereof at predetermined periods."

[0012] Expression "the reflected light from the object when the measuring light is projected onto the object" means light reflected by the object or light scattered by the object.

[0013] The detecting mode control means may increase the wavelength resolution by controlling the light source unit so that the fluctuation width of the wavelength per unit time of the light when the wavelength is swept is smaller in the second detecting mode than in the first detecting mode.

[0014] The light source unit may be any so long as it emits light while sweeping the wavelength (frequency) thereof at predetermined periods. For example, various wavelength tunable lasers may be employed as the light source unit.

[0015] Further, the detecting mode control means may increase the wavelength resolution by controlling the interference light detecting means so that the sampling frequency is higher in the second detecting mode than in the first detecting mode.

[0016] The first detecting mode is an image obtaining mode for obtaining a tomographic image of the object and the second detecting mode is a measurement initiating position adjusting mode in which the position in the direction of depth of the object in which tomographic image signal is to be obtained is adjusted.

[0017] An optical path length adjusting means which adjusts the optical path length of the measuring light or the reference light may be provided.

[0018] In an optical tomography system for obtaining a tomographic image of an object to be measured comprising a light source unit which emits light while sweeping the wavelength thereof at predetermined periods, a light dividing means which divides the light emitted from the light source unit into measuring light and reference light, a multiplexing means which multiplexes the reflected light from the object when the measuring light divided by the light dividing means is projected onto the object and the reference light, an interference light detecting means which detects interference light of the reflected light and the reference light which have been multiplexed by the multiplexing means, and a tomographic information obtaining means which obtains a tomographic information of the object by carrying out frequency-analysis on the interference light detected by the interference light detecting means, since the measurable range (measuring depth) becomes larger when the wavelength resolution upon detection of the interference light is high and becomes

smaller when the wavelength resolution upon detection of the interference light is low, when a first detecting mode in which the interference light is detected at a first wavelength resolution and a second detecting mode in which the interference light is detected at a second wavelength resolution higher than the first wavelength resolution can be switched, the user can switch the measurable range (measuring depth) according to the application and the convenience of the optical tomography system can be improved.

[0019] When the wavelength resolution in the second detecting mode is increased by controlling the light source unit so that the fluctuation width of the wavelength per unit time of the light when the wavelength is swept is smaller in the second detecting mode than in the first detecting mode, the measurable range (measuring depth) can be easily switched.

[0020] When the wavelength resolution in the second detecting mode is increased by controlling the interference light detecting means so that the sampling frequency is higher in the second detecting mode than in the first detecting mode, the measurable range (measuring depth) can be switched without adding to the time for obtaining a tomographic image.

[0021] When the first detecting mode is an image obtaining mode for obtaining a tomographic image of the object and the second detecting mode is a measurement initiating position adjusting mode in which the position in the direction of depth of the object in which tomographic image signal is to be obtained is adjusted, since the wavelength resolution can be increased in the measurement initiating position adjusting mode so that the measurable range (measuring depth) is broadened and the object can be easily found, the object can be apt to be obtained as a tomographic image in the measurement initiating position adjusting mode and the measurement initiating position can be efficiently adjusted.

BRIEF DESCRIPTION OF THE DRAWINGS

[0022]

Figure 1 is a schematic diagram showing an optical tomography system in accordance with a preferred embodiment of the present invention,

Figure 2 is a view for illustrating an example of the wavelength fluctuation of a laser beam output from the light source unit shown in Figure 1 in the image obtaining mode,

Figures 3A to 3C are views for illustrating an example of the interference light detected in the interference light detecting means shown in Figure 1,

Figure 4 is a view for illustrating an example of the interference light detected in the interference light detecting means shown in Figure 1, and

Figure 5 is a view for illustrating an example of the wavelength fluctuation of a laser beam output from the light source unit shown in Figure 1 in the measurement initiating position adjusting mode.

DESCRIPTION OF THE PREFERRED EMBODIMENTS

[0023] Embodiments of the optical tomography system of the present invention will be described in detail with reference to the drawings, hereinbelow. Figure 1 is a schematic diagram that illustrates an optical tomography system in accordance with a preferred embodiment of the present invention. The optical tomography system 1 of this embodiment is for obtaining a tomographic image of an object of measurement such as a living tissue or a cell in a body cavity by measuring the SS-OCT. The optical tomography apparatus 1 of this embodiment comprises: a light source unit 10 for emitting a laser beam L; a light dividing means 3 for dividing the laser beam L emitted from the light source unit 10 into a measuring light beam L1 and a reference light beam L2; an optical path length adjusting means 20 for adjusting the optical path length of the reference light beam L2 divided by the light dividing means 3; a probe 30 which guides to the object S to be measured the measuring light beam L1 divided by the light dividing means 3; a multiplexing means 4 for multiplexing a reflected light beam L3 from the object S when the measuring light beam L1 is irradiated onto the object S from the probe 30, and the reference light beam L2; an interference light detecting means 40 for detecting interference light beam L4 of the reflected light beam L3 and the reference light beam L2 which have been multiplexed and an image obtaining means 50 which obtains a tomographic image of the object S by carrying out frequency-analysis on the interference light beam L4 detected by the interference light detecting means 40.

[0024] The light source unit 10 emits the laser beam L while sweeping the frequency at a constant period and comprises, for instance, a synchronized semiconductor laser. Specifically, the light source unit 10 comprises: a semiconductor optical amplifier 11 (semiconductor gain medium); and an optical fiber FB10 and the optical fiber FB10 is connected to both ends of the semiconductor optical amplifier 11. The semiconductor optical amplifier 11 functions to emit weak release light into a first end of the optical fiber FB10, when a drive current is injected thereinto, and to amplify the light that enters it from a second end of the optical fiber FB10. When the drive current is supplied to the semiconductor optical amplifier 11, a pulse-like laser light beam L is emitted to an optical fiber FB1 from an optical resonator formed by the semiconductor optical amplifier 11 and the optical fiber FB10.

[0025] Further, an optical divider 12 is linked to the optical fiber FB10, and a portion of the light beam that propagates

within the optical fiber FB10 is emitted into an optical fiber FB11 from the optical divider 12. The Light beam, which is emitted from the optical fiber FB11, passes through a collimator lens 13, a diffraction grating 14, and an optical system 15, to be reflected by a rotating polygon mirror 16. The light beam reflected by the rotating polygon mirror 16 reenters the optical fiber FB11 by way of the optical system 15, the diffraction grating 14, and the collimator lens 13.

5 [0026] The rotating polygon mirror 16 rotates in the direction indicated by arrow R1, to vary the angle of each reflective surface thereof with respect to the optical axis of the optical system 15. Thereby, only a light beam having a specific frequency, from among the light spectrally split by the diffraction grating 14, is returned to the optical fiber FB11. The frequency of the light beam that reenters the optical fiber FB11 is determined by the angle formed by the optical axis of the optical system 15 and the reflective surface of the rotating polygon mirror 16. Light beam of the specific wavelength band entering the optical fiber FB11 enters the optical fiber FB10 from the optical divider 12, and, as a result, a laser beam L of a specific wavelength band is emitted to the optical fiber FB1. Accordingly, when the rotating polygon mirror 16 rotates in the direction indicated by arrow R1 at a constant speed, the wavelength of the light beam which reenters the optical fiber FB11 is swept at a period as shown in Figure 2. As a result, a laser beam L the wavelength of which has been swept at constant periods is emitted from the light source unit 10 to the optical fiber FB1.

10 [0027] The light dividing means 3 of Figure 1 comprises, for instance, a 2x2 fiber optic coupler and divides the light beam L led thereto by way of the optical fiber FB1 from the light source unit 10 into the measuring light beam L1 and the reference light beam L2. The light dividing means 3 is optically connected to two optical fibers FB2 and FB3, and the measuring light beam L1 is propagated through the optical fiber FB2 while the reference light beam L2 is propagated through the optical fiber FB3. In Figure 1, the light dividing means 3 also functions as the multiplexing means 4.

15 [0028] The probe 30 is optically connected to the optical fiber FB2 and the measuring light beam L1 is guided to the probe 30 from the optical fiber FB2. The probe 30 is inserted into a body cavity, for instance, through a forceps port by way of a forceps channel and is removably mounted on the optical fiber FB2 by an optical connector OC.

20 [0029] The optical path length adjusting means 20 is disposed on the side of the optical fiber FB3 radiating the reference light beam L2. The optical path length adjusting means 20 changes the optical path length of the reference light beam L2 in order to adjust the measurement initiation position with respect to the object S and comprises a collimator lens 21 and a reflecting mirror 22. The reference light beam L2 radiated from the optical fiber FB3 passes through the collimator lens 21 and is reflected by the reflecting mirror 22 and reenters the optical fiber FB3 by way of the collimator lens 21.

25 [0030] The reflecting mirror 22 is disposed on a movable stage 23 which is moved in the direction of arrow A by a mirror moving means 24. In response to movement of the movable stage 23 in the direction of arrow A, the optical path length of the reference light L2 is changed.

30 [0031] The multiplexing means 4 comprises a 2x2 fiber optic coupler, and multiplexes the reference light beam L2 which has been changed in its optical path length and its frequency by the optical path length adjusting means 20 and the reflected light from the object S to emit the multiplexed light beam toward an interference light detecting means 40 by way of an optical fiber FB4.

35 [0032] The interference light detecting means 40 detects interference light L4 of the reflected light beam L3 and the reference light beam L2 which have been multiplexed by the multiplexing means 4 at a predetermined sampling frequency and comprises InGaAs series photodetectors 40a and 40b for measuring the intensity of the interference light L4 and calculating portion 42 for carrying out balance detection of the detecting value of the photodetector 40a and the detecting value of the photodetector 40b. The interference light L4 is divided into two and detected in the photodetectors 40a and 40b.

40 [0033] The image obtaining means 50 detects the intensities of the reflected light beam L3 in positions in the direction of depth of the object S by carrying out Fourier-transform on the interference light L4 detected by the interference light detecting means 40 and obtains a tomographic image of the object S. The obtained tomographic image is displayed on a display means 60.

45 [0034] Here, detection of the interference light beam L4 in the interference light detecting means 40 and image generation in the image obtaining means 50 will be described briefly. Note that a detailed description of these two points can be found in M. Takeda, "Optical Frequency Scanning Interference Microscopes", Optical Engineering Contact, Vol. 41, No. 7, pp. 426-432, 2003.

50 [0035] When it is assumed that the light intensity of the interference fringes corresponding to each optical path length l when the reflected light beams L3 from depths of the object S and the reference light beam L2 interfere with each other with various optical path length differences is S(l), the light intensity I(k) detected in the interference light detecting means 40 is expressed by the following formula.

$$55 \quad I(k) = \int_0^{\infty} S(l) [1 + \cos(kl)] dl \quad \dots \quad (1)$$

wherein k represents the wave number and l represents the optical path length difference. Formula (1) may be considered to be given as an interferogram of a frequency range having a wave number of ω/c ($k=\omega/c$) as a variable. Accordingly,

a tomographic image is obtained by obtaining in the image obtaining means 50 information on the distance of the object S from the measurement initiating position and information on the intensity of reflection by carrying out frequency analysis by Fourier-transform on the spectral interference fringes detected by the interference light detecting means 40 and determining the intensity $S(l)$ of the interference light L4. The tomographic image is displayed by a display 60.

[0036] Operation of the optical tomography system 1 having a structure described above will be described with reference to Figures 1 and 2, hereinbelow. When a tomographic image is to be obtained, the optical path length is first adjusted by moving the movable stage 23 in the direction of the arrow A so that the object S is positioned in the measurable area. The laser beam L is subsequently emitted from the light source unit 10 by sweeping the wavelength at a period and the laser beam L is divided into the measuring light beam L1 and the reference light beam L2 by the dividing means 3. The measuring light beam L1 is led by the optical probe 30 into a body cavity and is projected onto the object S. Then the reflected light beam L3 from the object S and the reference light beam L2 reflected by the reflecting mirror 22 are multiplexed, and the interference light beam L4 of the reflected light beam L3 and the reference light beam L2 is detected by the interference light detecting means 40. A tomographic image is obtained by carrying out frequency analysis on a signal of the detected interference light beam L4 in the image obtaining means 50. In the optical tomography system 1 where a tomographic image is obtained by SS-OCT measurement, image information in the position in the direction of depth is obtained on the basis of the frequency and the intensity of the interference light beam L4, and the movement of the reflecting mirror 22 in the direction of arrow A is employed to adjust the measurement initiating position.

[0037] In the SS-OCT measurement described above, when the optical path length difference between the measuring light beam L1 and the reference light beam L2 becomes large, the quality of the image deteriorates due to increase in the spatial frequency, the relation of the sampling periods and/or the like. Accordingly, it is necessary to adjust the optical path length so that the optical path lengths of the measuring light beam L1 and the reference light beam L2 substantially conform to each other. The measurable range (measuring depth) is reverse proportional to a wavelength fluctuation width $\Delta\lambda$ of the laser beam L, and the resolution when a tomographic image is obtained increases as the wavelength fluctuation width $\Delta\lambda$ becomes larger. (See Figure 2) That is, the measurable range becomes narrow when a tomographic image is obtained at a high resolution. Accordingly, it takes a large labor to bring the optical path length difference between the measuring light and the reference light to the measurable range since the measurable range (measuring depth) is narrow to obtain a tomographic image in order to adjust the measurement initiating position in an SS-OCT system for obtaining a high resolution tomographic image.

[0038] Accordingly, the optical tomography system 1 shown in Figure 1 is provided with a control means 70 which switches between a measurement initiating position adjusting mode where a position for obtaining a tomographic image signal is adjusted in the direction of depth of the object S and an image obtaining mode where a tomographic image of the object S is obtained. The control means 70 controls the light source unit 10 or the interference light detecting means 40 so that the wavelength resolution of the interference light detecting means 40 is higher in the measurement initiating position adjusting mode than in the image obtaining mode.

[0039] That is, there are two ways to improve the wavelength resolution in detecting interference in the measurement initiating position adjusting mode. One is a method in which the wavelength resolution is increased by controlling the light source unit 10 so that the optical wavelength fluctuation width per unit time when the wavelength is swept is smaller in the measurement initiating position adjusting mode than in the image obtaining mode and the other is a method in which the wavelength resolution is increased by controlling the interference light detecting means 40 so that the sampling frequency is higher in the measurement initiating position adjusting mode than in the image obtaining mode. This point will be described in detail, hereinbelow.

[0040] Assuming that the optical path length difference Δl between the optical path length l_s of the measuring light beam L1 and the optical path length l_r of the reference light beam L2 is $\Delta l = |l_r - l_s|$, the period Γ of the interference light beam L4 detected by the interference light detecting means 40 such as shown in Figure 4 is expressed by the following formula.

$$\Gamma = \lambda_0^2 / \Delta l \cdot \tau / \Delta \lambda \quad \dots \quad (2)$$

wherein λ_0 represents the central wavelength of the spectrum, τ represents the fluctuating period at which the wavelength fluctuates when the wavelength is swept and $\Delta\lambda$ represents the wavelength fluctuation width (Figure 2). Figures 3A, 3B and 3C respectively show the waveforms when $\Delta l = 100\mu\text{m}$, $\Delta l = 500\mu\text{m}$, $\Delta l = 1000\mu\text{m}$ with the sampling frequency of $500/\tau$. As can be understood from Figures 3A, 3B and 3C and the formula (2), as the optical path length difference Δl increases, the period Γ of the interference light beam L4 becomes shorter.

[0041] In order to obtain a signal at a sufficient resolution, four or more than four samplings per one period of fluctuation is necessary as follows.

sampling periods $\Delta t < r/4$ of the interference light beam ... (3)

[0042] When formula (3) is not satisfied, the period r of the interference light beam L4 exceeds the resolution of the interference light detecting means 40 as shown in Figure 3C and S/N deteriorates, which results in deterioration of the quality of the image.

[0043] The final measurable depth Δl_{lim} of the object S is as follows from the formulae (2) and (3).

$$\Delta l_{lim} = 1/4 \cdot (\tau/\Delta\lambda) \cdot \lambda_0^2 \cdot (1/\Delta t) \cdots (4)$$

Formula (4) represents that the measurable depth Δl_{lim} of the object S, that is, the measurable range (measuring depth), is reverse proportional to the inverse number of the wavelength fluctuation width ($\Delta\lambda/\tau$) per unit time and proportional to the inverse number of the sampling interval Δt or the sampling frequency.

[0044] In the image obtaining mode, it is necessary to obtain a high quality image. For this purpose, it is preferred that the wavelength fluctuation width $\Delta\lambda$ be large and the measuring resolution be high. Further, since it is necessary to obtain a tomographic image within a predetermined time, it is preferred that the wavelength sweeping period τ be short. Further, when the sampling frequency is large, the sampling time for one sampling becomes short, and when the amount of interference light detected by the interference light detecting means 40 is small, an amount of detected light is insufficient, which involves a fear that S/N deteriorates. Accordingly, it is not preferred that the sampling frequency is too large. Taking into account these conditions, the wavelength fluctuation width $\Delta\lambda$, the wavelength sweeping period τ , the sampling frequency and the like in the image obtaining mode are determined. Accordingly, the measurable range (measuring depth) where a tomographic image can be obtained is normally not so large. For example, when the measurable range is several tens of μm and the object is apart from the probe 30 by several hundreds of μm , the position of the object S cannot be realized even if a tomographic image is obtained.

[0045] In this embodiment, the control means 70, for instance, reduces the rotational speed of the rotating polygon mirror 16 in the measurement initiating position adjusting mode to 1/2 of that in the image obtaining mode. With this arrangement, the wavelength sweeping period τ is doubled, and a laser beam L which is 1/2 in the wavelength fluctuation width ($\Delta\lambda/\tau$) per unit time is emitted from the light source unit 10 as shown in Figure 5. Thus when the wavelength fluctuation width ($\Delta\lambda/\tau$) per unit time is reduced ($\tau/\Delta\lambda$ is increased), the wavelength fluctuation width for one sampling in the interference light detecting means 40 is reduced that is, the apparent resolution in the interference light detecting means 40 is increased. In this embodiment, the measurable range Δl_{lim} of the object S shown in formula (4) is doubled. By this, a tomographic image which is doubled in the measurable range (measuring depth) can be obtained and the object S comes to be easily imaged in the tomographic image. The user can carry out adjustment of the measurement initiating position simply at high speed observing the tomographic image.

[0046] In the case where the light source unit 10 is controlled so that the wavelength fluctuation width per unit time of the light when the wavelength is swept is smaller in the measurement initiating position adjusting mode than in the image obtaining mode to increase the resolution, though an obtaining time required to obtain one tomographic image is increased, there is no trouble in the normal tomographic image obtaining action since it is only when the measurement initiating position is adjusted.

[0047] Also when a wide measurable range (measuring depth) is required as when the layer structure of the stomach wall, for instance, a tomographic image which is wide in the measurable range (measuring depth) can be obtained by thus making smaller the wavelength fluctuation width per unit time.

[0048] Otherwise, the control means 70 may control the interference light detecting means 40 so that the sampling interval Δt is smaller in the measurement initiating position adjusting mode than in the tomographic image obtaining mode or so that the sampling frequency ($1/\Delta t$) is larger in the measurement initiating position adjusting mode than in the tomographic image obtaining mode. That is, when the wavelength resolution in the interference light detecting means 40 is improved, the measurable range Δl_{lim} is widened (see, formula 4) and a tomographic image which is wide in the measurable range (measuring depth) can be obtained. Accordingly, the object S comes to be easily imaged in the tomographic image and the user can carry out adjustment of the measurement initiating position simply at high speed observing the tomographic image. Though a sufficient amount of light cannot be obtained in the interference light detecting means 40, thereby involving deterioration of the image quality when the sampling frequency is high, the tomographic image may only have to be an image which has such a quality in which existence of the object can be recognized and does not require a high image quality in the measurement initiating position adjustment. When the sampling frequency ($1/\Delta t$) is increased, an obtaining time required to obtain one tomographic image is not increased and adjustment of the measurement initiating position can be carried out at high speed,

[0049] Embodiments of the present invention are not limited to the embodiments described above. For example,

though in the embodiment shown in Figure 5, the wavelength period τ is increased, the wavelength fluctuation width $\Delta\lambda$ may be narrowed. In this case, the light source unit 10 may be provided with a pair of rotating polygon mirrors different in diameter so that in the image obtaining mode, a rotating polygon mirror of a larger diameter is employed while in the measurement initiating position adjusting mode, the other mirror is employed. Further, the rotational speeds may be

changed according to the mode described above.
[0050] Though a structure employing a rotating polygon mirror is shown in Figure 1 as an example of the light source unit which emits a laser beam L while sweeping the wavelength thereof, a known wavelength-variable laser can be employed. In this case, the control means 70 controls the drive of the wavelength-variable laser so that $\Delta\lambda/\tau$ is smaller in the measurement initiating position adjusting mode than in the image obtaining mode.

[0051] Further, though in the above embodiments, the light source unit 10 or the interference light detecting means 40 is controlled, both the light source unit 10 and the interference light detecting means 40 may be controlled. That is, it is possible to increase the sampling frequency in the interference light detecting means 40 while the wavelength fluctuation width per unit time in the light source unit 10 is narrowed.

Claims

1. An optical tomography system (1) for obtaining a tomographic image of an object (S) to be measured comprising
 - a light source unit (10) which emits light while sweeping the wavelength thereof at predetermined periods,
 - a light dividing means (3) which divides the light emitted from the light source unit into measuring light (L1) and reference light (L2),
 - a multiplexing means (4) which multiplexes the reflected light from the object (S) when the measuring light (L1) divided by the light dividing means (3) is projected onto the object (S) and the reference light (L2),
 - an interference light detecting means (40) which detects interference light (L4) of the reflected light (L3) and the reference light (L2) which have been multiplexed by the multiplexing means (4), and
 - a tomographic information obtaining means (50) which obtains a tomographic information of the object (S) by carrying out frequency-analysis on the interference light (L4) detected by the interference light detecting means (40), **characterised by**
 - a detecting mode control means (70) which switches between a first detecting mode in which the interference light (L4) is detected at a first wavelength resolution and a second detecting mode in which the interference light (L4) is detected at a second wavelength resolution higher than the first wavelength resolution being provided.
2. An optical tomography system (1) as defined in Claim 1 in which the light source unit (10) comprises a light source (11) where the fluctuation width of the wavelength per unit time of the light when the wavelength is swept can be switched, and
 - the detecting mode control means (70) controls the light source unit (10) so that the fluctuation width of the wavelength per unit time of the light when the wavelength is swept is smaller in the second detecting mode than in the first detecting mode.
3. An optical tomography system (1) as defined in Claim 1 or 2 in which the interference light detecting means detects the interference light (L4) by sampling the interference light (L4) at a predetermined sampling frequency, and
 - the detecting mode control means (70) controls the interference light detecting means (40) so that the sampling frequency is higher in the second detecting mode than in the first detecting mode.
4. An optical tomography system (1) as defined in any one of Claims 1 to 3 in which the first detecting mode is an image obtaining mode for obtaining a tomographic image of the object (S) and the second detecting mode is a measurement initiating position adjusting mode in which the position in the direction of depth of the object (S) in which tomographic image signal is to be obtained is adjusted.
5. An optical tomography system (1) as defined in any one of Claims 1 to 4 further comprising an optical path length adjusting means (20) which adjusts the optical path length of the measuring light (L1) or the reference light (L2).

Patentansprüche

1. Optisches Tomographiesystem (1) zum Gewinnen eines Tomographiebilds eines zu messenden Objekts (S), umfassend:

5
 eine Lichtquelleneinheit (10), die Licht emittiert, während dessen Wellenlänge mit vorbestimmten Perioden gewobbelt wird,
 eine Lichtteilungseinrichtung (3), die das von der Lichtquelleneinheit emittierte Licht in Messlicht (L1) und Referenzlicht (L2) aufteilt,
 10 eine Multiplexereinrichtung (4), die das von dem Objekt (10) reflektierte Licht, wenn das von der Lichtteilungseinrichtung (3) geteilte Messlicht (L1) auf das Objekt (S) projiziert wird, und das Referenzlicht (L2) multiplext,
 eine Interferenzlicht-Detektoreinrichtung (40), die Interferenzlicht (L4) des reflektierten Lichts (L3) und des Referenzlichts (L2), die von der Multiplexereinrichtung (4) gemultiplext wurden, detektiert, und
 15 eine Tomographieinformations-Gewinnungseinrichtung (50), die eine Tomographieinformation des Objekts (S) dadurch gewinnt, dass das Interferenzlicht (L4), welches von der Interferenzlicht-Detektoreinrichtung (40) detektiert wird, einer Frequenzanalyse unterzogen wird, **gekennzeichnet durch**
 eine Detektiermodus-Steuereinrichtung (70), welche umschaltet zwischen einem ersten Detektiermodus, bei dem das Interferenzlicht (L4) mit einer ersten Wellenlängenauflösung detektiert wird, und einem zweiten Detektiermodus, in welchem das Interferenzlicht (L4) bei einer zweiten Wellenlängenauflösung detektiert wird, die
 20 höher ist als die erste Wellenlängenauflösung.

2. System (1) nach Anspruch 1, in welchem die Lichtquelleneinheit (10) eine Lichtquelle (11) enthält, deren Schwingungsbreite für die Wellenlänge pro Einheitszeit des Lichts, in der die Wellenlänge gewobbelt wird, umgeschaltet werden kann, und
 25 die Detektiermodus-Steuereinrichtung (70) die Lichtquelleneinheit (10) derart steuert, dass die Schwingungsbreite der Wellenlänge pro Einheitszeit des Lichts, wenn die Wellenlänge gewobbelt wird, in dem zweiten Detektiermodus kleiner ist als in dem ersten Detektiermodus.

3. System (1) nach Anspruch 1 oder 2, in welchem die Interferenzlicht-Detektoreinrichtung das Interferenzlicht (L4) dadurch detektiert, dass das Interferenzlicht (L4) mit einer vorbestimmten Abtastfrequenz abgetastet wird, und
 30 die Detektiermodus-Steuereinrichtung (70) die Interferenzlicht-Detektoreinrichtung (40) derart steuert, dass die Abtastfrequenz im zweiten Detektiermodus höher ist als im ersten Detektiermodus.

4. System (1) nach einem der Ansprüche 1 bis 3, in welchem der erste Detektiermodus ein Bildgewinnungsmodus zum Gewinnen eines Tomographiebilds des Objekts (S) ist, und der zweite Detektiermodus ein Messanfangsstellungs-Einstellmodus ist, in welchem die Position in Tiefenrichtung des Objekts (S), in der ein Tomographiebildsignal zu gewinnen ist, eingestellt wird.
 35

5. System (1) nach einem der Ansprüche 1 bis 4, weiterhin umfassend eine Optische-Weglängen-Einstelleinrichtung (20), die die optische Weglänge des Messlichts (L1) oder des Referenzlichts (L2) einstellt.
 40

Revendications

1. Système optique de tomographie (1) pour obtenir l'image tomographique d'un objet (S) à mesurer, comprenant :

45
 une unité de source de lumière (10) qui émet une lumière tout en balayant sa longueur d'onde selon des périodes prédéterminées ;
 un moyen de division de lumière (3) qui divise la lumière qui est émise depuis l'unité de source de lumière selon
 50 une lumière de mesure (L1) et une lumière de référence (L2) ;
 un moyen de multiplexage (4) qui multiplexe la lumière réfléchi depuis l'objet (S) lorsque la lumière de mesure (L1) qui est divisée par le moyen de division de lumière (3) est projetée sur l'objet (S) et la lumière de référence (L2) ;
 un moyen de détection de lumière d'interférence (40) qui détecte une lumière d'interférence (L4) de la lumière
 55 réfléchi (L3) et de la lumière de référence (L2), lesquelles lumières ont été multiplexées par le moyen de multiplexage (4) ; et
 un moyen d'obtention d'information tomographique (50) qui obtient une information tomographique de l'objet (S) en mettant en oeuvre une analyse en termes de fréquences sur la lumière d'interférence (L4) qui est détectée

par le moyen de détection de lumière d'interférence (40),

caractérisé par :

5 un moyen de commande de mode de détection (70) qui réalise une commutation entre un premier mode de détection dans lequel la lumière d'interférence (L4) est détectée à une résolution de première longueur d'onde et un second mode de détection dans lequel la lumière d'interférence (L4) est détectée à une résolution de seconde longueur d'onde supérieure à la résolution de première longueur d'onde.

10 **2.** Système optique de tomographie (1) selon la revendication 1, dans lequel :

l'unité de source de lumière (10) comprend une source de lumière (11) au niveau de laquelle la largeur de fluctuation de la longueur d'onde par temps unitaire de la lumière lorsque la longueur d'onde est balayée peut être commutée ; et

15 le moyen de commande de mode de détection (70) commande l'unité de source de lumière (10) de telle sorte que la largeur de fluctuation de la longueur d'onde par temps unitaire de la lumière lorsque la longueur d'onde est balayée soit inférieure dans le second mode de détection par comparaison avec le premier mode de détection.

20 **3.** Système optique de tomographie (1) selon la revendication 1 ou 2, dans lequel :

le moyen de détection de lumière d'interférence détecte la lumière d'interférence (L4) en échantillonnant la lumière d'interférence (L4) à une fréquence d'échantillonnage prédéterminée ; et

25 le moyen de commande de mode de détection (70) commande le moyen de détection de lumière d'interférence (40) de telle sorte que la fréquence d'échantillonnage soit plus élevée dans le second mode de détection que dans le premier mode de détection.

30 **4.** Système optique de tomographie (1) selon l'une quelconque des revendications 1 à 3, dans lequel le premier mode de détection est un mode d'obtention d'image pour obtenir une image tomographique de l'objet (S) et le second mode de détection est un mode de réglage de position d'initiation de mesure dans lequel la position dans la direction de profondeur de l'objet (S) pour laquelle un signal d'image tomographique doit être obtenu est réglée.

35 **5.** Système optique de tomographie (1) selon l'une quelconque des revendications 1 à 4, comprenant en outre un moyen de réglage de longueur de chemin optique (20) qui règle la longueur de chemin optique de la lumière de mesure (L1) ou de la lumière de référence (L2).

40

45

50

55

FIG.1

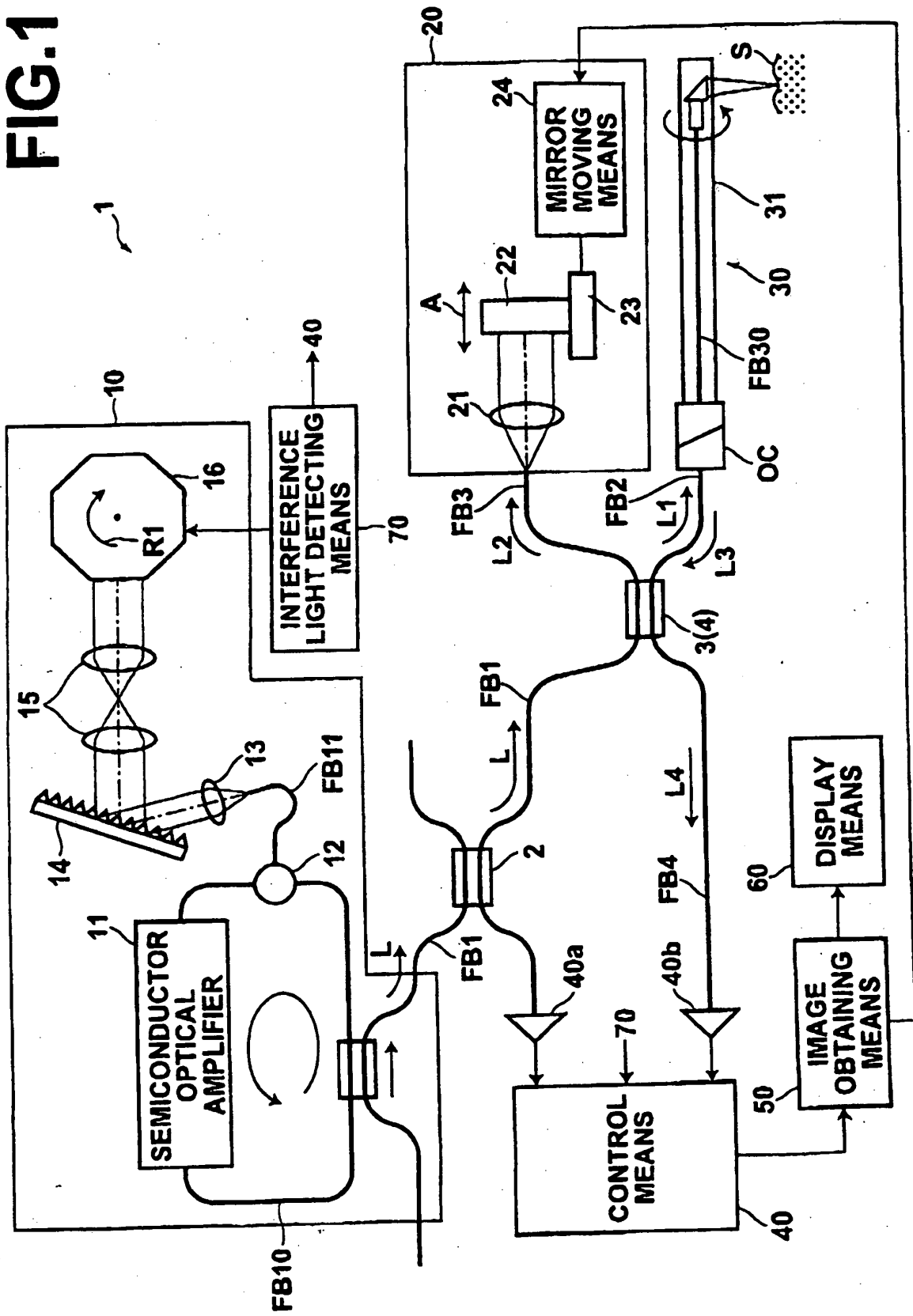
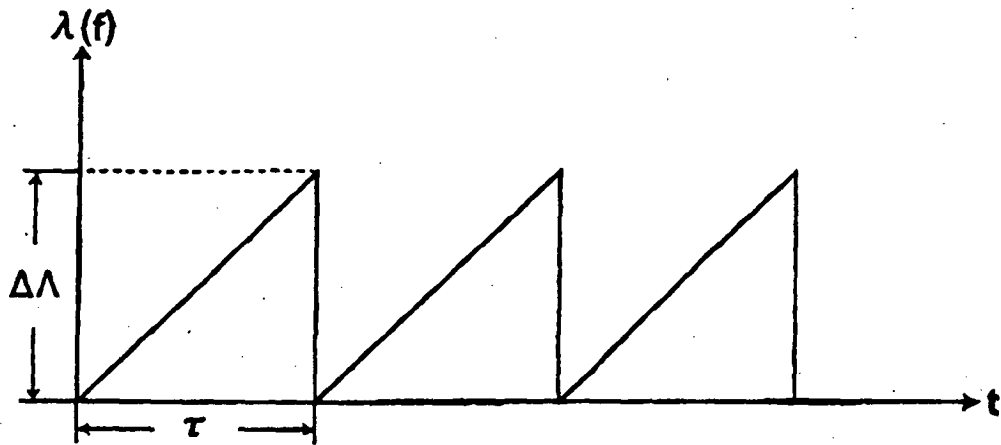

FIG.2

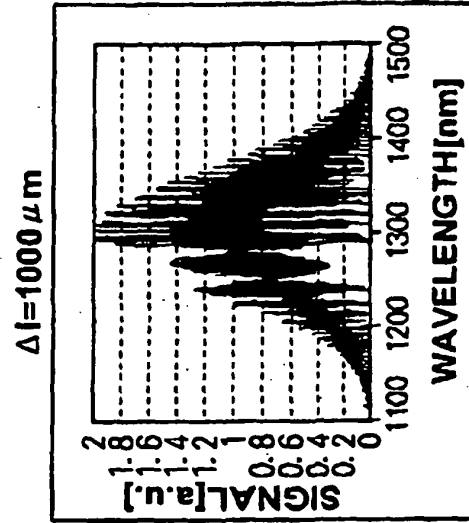

FIG.3C

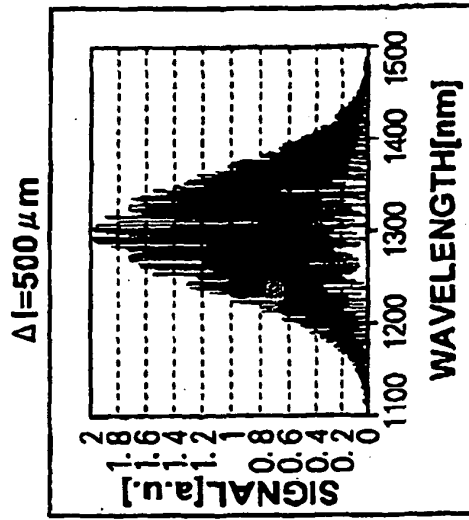

FIG.3B

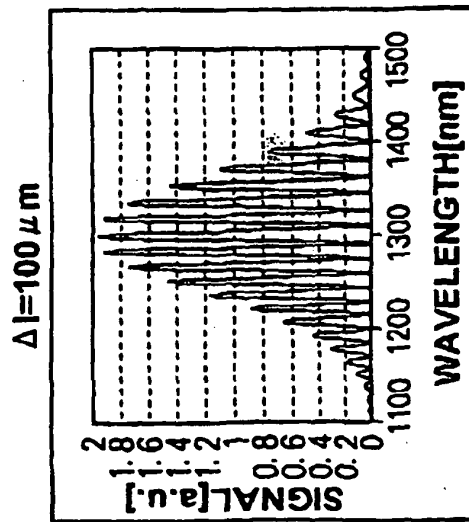
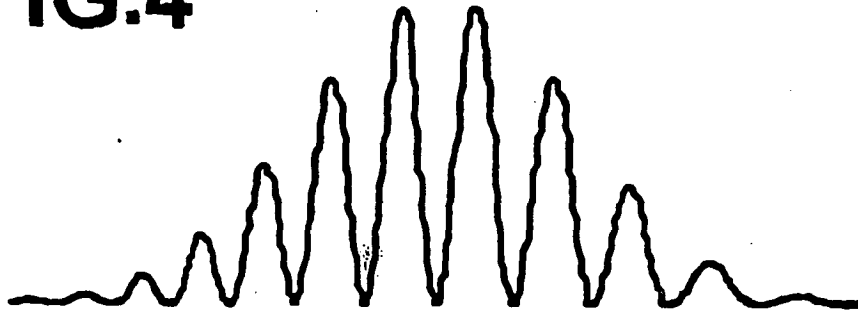

FIG.3A

FIG.4



$$\Gamma = \frac{\lambda_0^2}{\Delta l} \frac{\tau}{\Delta \lambda}$$

FIG.5

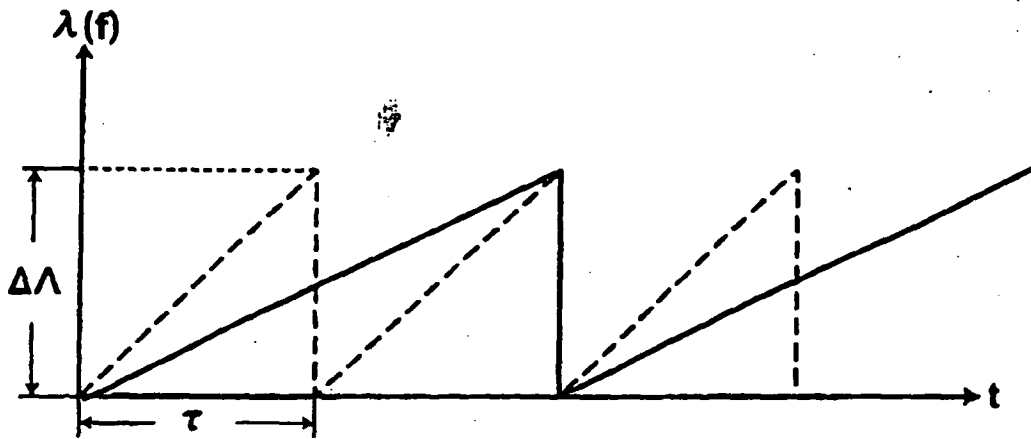

REFERENCES CITED IN THE DESCRIPTION

This list of references cited by the applicant is for the reader's convenience only. It does not form part of the European patent document. Even though great care has been taken in compiling the references, errors or omissions cannot be excluded and the EPO disclaims all liability in this regard.

Patent documents cited in the description

- JP 2003172690 A [0002] [0002] [0004]
- WO 2005001401 A [0006]

Non-patent literature cited in the description

- **M. TAKEDA.** Optical Frequency Scanning Interference Microscopes. *Optical Engineering Contact*, 2003, vol. 41 (7), 426-432 [0034]

专利名称(译)	光学层析成像系统		
公开(公告)号	EP1770352B1	公开(公告)日	2008-07-02
申请号	EP2006020527	申请日	2006-09-29
[标]申请(专利权)人(译)	富士胶片株式会社		
申请(专利权)人(译)	富士胶片株式会社		
当前申请(专利权)人(译)	富士胶片株式会社		
[标]发明人	KUROIWA KARIN		
发明人	KUROIWA, KARIN		
IPC分类号	G01B9/02 A61B5/00 G01N21/47		
CPC分类号	G01B9/02048 A61B5/0066 A61B5/0073 G01B9/02004 G01B9/02089 G01B9/02091 G01N21/4795		
优先权	2005289119 2005-09-30 JP		
其他公开文献	EP1770352A1		
外部链接	Espacenet		

摘要(译)

在用于通过检测反射光 (L3) 和参考光 (L2) 的干涉光 (L4) 来获得待测物体 (S) 的断层图像的光学断层摄影系统 (1) 中，控制器 (70) 切换在以第一波长分辨率检测干涉光 (L4) 的第一检测模式和以高于第一波长分辨率的第二波长分辨率检测干涉光 (L4) 的第二检测模式之间。

$$I(k) = \int_{-\infty}^{\infty} S(x) [1 + \cos(kx)] dx \dots (1)$$