

(19)



(11)

EP 2 175 776 B1

(12)

EUROPEAN PATENT SPECIFICATION

(45) Date of publication and mention of the grant of the patent:
23.03.2016 Bulletin 2016/12

(51) Int Cl.:
A61B 5/053^(2006.01) A61B 5/00^(2006.01)

(21) Application number: **08782894.3**

(86) International application number:
PCT/AU2008/001145

(22) Date of filing: **07.08.2008**

(87) International publication number:
WO 2009/018620 (12.02.2009 Gazette 2009/07)

(54) IMPEDANCE MEASUREMENT PROCESS

IMPEDANZ-MESSVERFAHREN

MESURE DE L'IMPÉDANCE

(84) Designated Contracting States:
AT BE BG CH CY CZ DE DK EE ES FI FR GB GR HR HU IE IS IT LI LT LU LV MC MT NL NO PL PT RO SE SI SK TR

• **SMITH, Jye Geoffrey**
Runcorn, Queensland 4113 (AU)

(30) Priority: **09.08.2007 AU 2007904287 P**

(74) Representative: **Gray, Peter John Bracey**
Thompson Gray LLP
Central Court
25 Southampton Buildings
London WC2A 1AL (GB)

(43) Date of publication of application:
21.04.2010 Bulletin 2010/16

(73) Proprietor: **Impedimed Limited**
Pinkenba, QLD 4008 (AU)

(56) References cited:
WO-A1-98/23204 WO-A2-2004/049936
WO-A2-2004/098389 US-A1- 2004 210 158
US-A1- 2006 085 049 US-A1- 2006 116 599
US-A1- 2006 270 942 US-A1- 2006 270 942
US-B2- 7 212 852

(72) Inventors:
• **CORNISH, Bruce Herbert**
Greenbank, Queensland 4124 (AU)
• **THOMAS, Brian John**
Hill End, Queensland 4101 (AU)

EP 2 175 776 B1

Note: Within nine months of the publication of the mention of the grant of the European patent in the European Patent Bulletin, any person may give notice to the European Patent Office of opposition to that patent, in accordance with the Implementing Regulations. Notice of opposition shall not be deemed to have been filed until the opposition fee has been paid. (Art. 99(1) European Patent Convention).

Description

Background of the Invention

5 [0001] The present invention relates to a method and apparatus for performing impedance measurements, and in particular to performing multiple impedance measurements at a given site to determine the presence, absence or degree of biological anomalies such as tissue lesions, and to allow impedance mapping to be performed accounting for any erroneous measurements.

10 **Description of the Prior Art**

[0002] The reference in this specification to any prior publication (or information derived from it), or to any matter which is known, is not, and should not be taken as an acknowledgment or admission or any form of suggestion that the prior publication (or information derived from it) or known matter forms part of the common general knowledge in the field of endeavour to which this specification relates.

15 [0003] One existing technique for determining biological parameters relating to a subject, such as fluid levels, involves the use of bioelectrical impedance. This involves measuring the electrical impedance of a subject's body using a series of electrodes placed on the skin surface. Changes in electrical impedance at the body's surface are used to determine parameters, such as changes in fluid levels, associated with the cardiac cycle or oedema, or other conditions which affect body habitus.

20 [0004] Prior art publications WO2004/098389 and WO2004049936 disclose, for instance, apparatus and methods for bioimpedance measurements on a subject's body, involving carrying out several impedance measurements on a same site, using different electrode configurations.

25 [0005] However, a number of factors, such as the connectivity of the electrodes to the subject, can effect the accuracy of impedance measuring processes. An example of this is encountered with tetrapolar electrode configurations, which are routinely used for tissue characterisation. The tetrapolar configuration involves injecting a constant drive current between an adjacent pair of electrodes (drive electrodes), and measurement of the resulting potential between another pair of adjacent electrodes (measurement electrodes). This measured potential is dependent on the electrical characteristics of the volume of tissues being analysed. However, the tetrapolar configuration can produce erroneous results in the form of an increase in measured impedance when a low impedance lesion is located between a drive and measurement electrode.

30 [0006] As a result, when readings are obtained, it can be difficult to determine if the readings are accurate and if not, to determine the cause of the inaccuracy.

35 **Summary of the Present Invention**

[0007] The present invention seeks to substantially overcome, or at least ameliorate, one or more disadvantages of existing arrangements.

40 [0008] In a first broad form the present invention seeks to provide an apparatus and a method for use in performing impedance measurements on a subject, according to claims 1 and 15 respectively. Such measurement involve:

- a) determining at least one first impedance value, measured at a site using a first electrode configuration;
- b) determining at least one second impedance value, measured at the site using a second electrode configuration;
- and,
- 45 c) determining the presence, absence or degree of an anomaly using the difference between the first and second impedance values.

50 [0009] It will be appreciated that the invention may be used for diagnosis of the presence, absence or degree of a range of conditions and illnesses, including, but not limited to the detection of lesions, tumours, or the like, as well as to allow impedance mapping to be performed more accurately by accounting for erroneous readings.

Brief Description of the Drawings

55 [0010] An example of the present invention will now be described with reference to the accompanying drawings, in which: -

- Figure 1 is a schematic of an example of impedance measuring apparatus;
- Figure 2 is a flowchart of an example of a process for performing impedance measurements;

Figure 3 is a flowchart of a second example of a process for performing impedance measurements;
 Figure 4 is a schematic of a specific example of impedance measuring apparatus;
 Figures 5A and 5B are a flowchart of an example of a process for performing impedance measurements using the apparatus of Figure 4;
 5 Figures 6A to 6D are schematic diagrams of example tetrapolar electrode configurations;
 Figures 6E to 6J are schematic diagrams of an example of a sequence of electrode configurations used for performing measurements at multiple sites;
 Figure 7 is a schematic diagram of an example of a region of red blood cells introduced to a plasma to show visible diffusion;
 10 Figure 8 is a schematic diagram of varying haematocrit value over an area of the electrode array of Figure 4;
 Figure 9A is a schematic diagram of average R_0 maps for haematocrit of 60% and for the tetrapolar electrode arrangements of Figures 6A to 6D;
 Figure 9B is a plot of an example of a mean value of R_0 for each impedance map of Figure 9A against haematocrit concentration;
 15 Figure 10 is a schematic diagram of example impedance maps for plasma with introduced red blood cells in the lower left corner for the tetrapolar electrode arrangements of Figures 6A to 6D;
 Figure 11 is a schematic diagram of an example impedance difference map for use in identifying a tissue anomaly;
 Figure 12A is a schematic diagram of example impedance maps for plasma with an introduced red blood cell clot covering a central electrode;
 20 Figure 12B is a schematic diagram of example impedance maps for plasma with an introduced red blood cell clot covering four electrodes associated with a respective measurement site; and,
 Figure 12C is a schematic diagram of example impedance maps for plasma with an introduced red blood cell clot covering two measurement sites.

25 Detailed Description of the Preferred Embodiments

[0011] An example of apparatus suitable for performing an analysis of a subject's bioelectric impedance will now be described with reference to Figure 1.

30 **[0012]** As shown the apparatus includes a measuring device 100 including a processing system 102 coupled to a signal generator 111 and a sensor 112. In use the signal generator 111 and the sensor 112 are coupled to first electrodes 113, 114, and second electrodes 115, 116, provided on a subject S, via respective first leads 123, 124, and second leads 125, 126.

35 **[0013]** The connection may be via a switching device 118, such as a multiplexer, allowing the leads 123, 124, 125, 126 to be selectively interconnected to signal generator 111 and the sensor 112, although this is not essential, and connections may be made directly between the signal generator 111, the sensor 112 and the electrodes 113, 114, 115, 116.

40 **[0014]** The processing system 102 typically includes a processor 105, a memory 106, an input/output device 107 such as a keyboard and display, and an external interface 108 coupled together via a bus 109, as shown. The external interface 108 can be used to allow the processing system 102 to be coupled to the signal generator 111 and the sensor 112, as well as to allow connection to one or more peripheral devices (not shown), such as an external database, or the like.

45 **[0015]** In use, the processing system 102 is adapted to generate control signals, which cause the signal generator 111 to generate one or more alternating drive signals, such as voltage or current signals, which can be applied to a subject S, via two of the electrodes 113, 114, 115, 116 (generally referred to as "drive" electrodes). The sensor 112 then determines measured signals representing the induced voltage across or current through the subject S, using the other two of the electrodes 113, 114, 115, 116 (generally referred to as "measurement" electrodes) and transfers appropriate signals to the processing system 102.

50 **[0016]** Accordingly, it will be appreciated that the processing system 102 may be any form of processing system which is suitable for generating appropriate control signals and interpreting an indication of the measured signals to thereby determine the subject's bioelectrical impedance, and optionally determine other information such as the presence, absence or degree of oedema, or the like.

[0017] The processing system 102 may therefore be a suitably programmed computer system, such as a laptop, desktop, PDA, smart phone or the like. Alternatively the processing system 102 may be formed from specialised hardware, such as an FPGA (field programmable gate array), or a combination of a programmed computer system and specialised hardware, or the like.

55 **[0018]** In use, the two electrodes 113, 114, 115, 116 that are to be used as drive electrodes are positioned on the subject to allow one or more signals to be injected into the subject S, with two other electrodes 113, 114, 115, 116 being positioned to act as measurement electrodes to allow signals induced within the subject, to be detected. The location of the electrodes will depend on the segment of the subject S under study.

[0019] Once the electrodes are positioned, one or more alternating signals are applied to the subject S, via the drive electrodes. The nature of the alternating signal will vary depending on the nature of the measuring device and the subsequent analysis being performed.

[0020] For example, the system can use Bioimpedance Analysis (BIA) in which a single low frequency current is injected into the subject S, with the measured impedance being used directly in the identification of anomalies (which can include tissue anomalies, erroneous measurements, or the like), or performing impedance mapping.

[0021] In contrast Bioimpedance Spectroscopy (BIS) devices apply signals at a number of frequencies either simultaneously or sequentially. BIS devices typically utilise frequencies ranging from low frequencies (4 kHz) to higher frequencies (1000 kHz), and can use 256 or more different frequencies within this range, to allow multiple impedance measurements to be made within this range.

[0022] Thus, the measuring device 100 may either apply an alternating signal at a single frequency, at a plurality of frequencies simultaneously, or may apply a number of alternating signals at different frequencies sequentially, depending on the preferred implementation. The frequency or frequency range of the applied signals may also depend on the analysis being performed.

[0023] In one example, the applied signal is a frequency rich current signal from a current source clamped, or otherwise limited, so it does not exceed a maximum allowable subject auxiliary current. However, alternatively, voltage signals may be applied, with a current induced in the subject being measured. The signal can either be constant current, impulse function or a constant voltage signal where the current is measured so it does not exceed the maximum allowable subject auxiliary current.

[0024] A potential difference and/or current are measured between the measurement electrodes. The acquired signal and the measured signal will be a superposition of potentials generated by the human body, such as the ECG, and potentials generated by the applied current.

[0025] To assist accurate measurement of the impedance, buffer circuits may be placed in connectors that are used to connect the electrodes 113, 114, 115, 116 to the leads 123, 124, 125, 126. This helps eliminate contributions to the measured voltage due to the response of the leads 123, 124, 125, 126, and reduce signal losses.

[0026] A further option is for the voltage to be measured differentially, meaning that the sensor used to measure the potential at each measurement electrode only needs to measure half of the potential as compared to a single ended system. In one example, current can also be driven or sourced through the subject S differentially, which again greatly reduced the parasitic capacitances by halving the common-mode current.

[0027] The acquired signal is demodulated to obtain the impedance of the system at the applied frequencies. One suitable method for demodulation of superposed frequencies is to use a Fast Fourier Transform (FFT) algorithm to transform the time domain data to the frequency domain. This is typically used when the applied current signal is a superposition of applied frequencies. Another technique not requiring windowing of the measured signal is a sliding window FFT.

[0028] In the event that the applied current signals are formed from a sweep of different frequencies, then it is more typical to use a processing technique such as multiplying the measured signal with a reference sine wave and cosine wave derived from the signal generator, or with measured sine and cosine waves, and integrating over a whole number of cycles. This process rejects any harmonic responses and significantly reduces random noise.

[0029] Other suitable digital and analog demodulation techniques will be known to persons skilled in the field.

[0030] In the case of BIS, impedance or admittance measurements can be determined from the signals at each frequency by comparing the recorded voltage and current signal. This allows demodulation to be used to produce an amplitude and phase signal at each frequency.

[0031] An example of the operation of the apparatus to detect anomalies when performing impedance mapping or other impedance measurements will now be described with reference to Figure 2.

[0032] At step 200 a first impedance value is measured at a given site. The impedance value is typically measured using a first electrode configuration, and whilst any form of electrode configuration may be used, this is typically a tetrapolar electrode configuration utilised to allow impedance readings to be measured at the specific site.

[0033] At step 210 a second impedance value is measured at the (same) site. This is typically achieved utilising an alternative electrode configuration and in particular, a configuration which is a modified version of the first configuration.

[0034] In this regard, the configuration typically utilises the same electrode placements on the subject, but applies the signals to and measures signals from different ones of the electrodes. Thus, for example, in a tetrapolar electrode configuration, the first measurement may be made by applying a current across first electrodes and measuring a voltage across second electrodes, whereas the second measurement may be made by applying the current across the second electrodes and measuring the induced voltage across first electrodes.

[0035] At step 220 the first and second impedance values can be used to determine if the measurement made at the site is erroneous. In particular, such a reading will typically arise if a low impedance lesion or other biological anomaly is present between a drive and a measurement electrode pair.

[0036] The erroneous measurement (or reading) can then be taken into account when performing analysis of imped-

ance measurements at step 230. For example, the erroneous reading may be used to identify and/or subsequently monitor the development of a low impedance lesion. Thus, this technique can be used to detect the presence, absence or degree of lesions or other biological anomalies. Additionally, and/or alternatively, knowledge of the anomaly can be taken into account when performing analysis of impedance measurements.

5 **[0037]** Thus, for example, impedance measurements can be performed over a region, such as an area of a subject's skin, to allow impedance mapping or other similar analysis to be performed. As the presence of erroneous readings can have a negative impact on any such impedance mapping process, identification of these erroneous readings allows readings at the corresponding site to be rejected or otherwise modified so that they do not adversely affect the impedance mapping process.

10 **[0038]** An example of the process for identifying anomalies, including but not limited to tissue anomalies, erroneous readings, or the like will now be described in more detail with respect to Figure 3.

[0039] In particular, at step 300 the signal generator 111 is used to apply a first drive signal to the subject S using a first electrode configuration. Thus for example, the current source 111 may be connected to the leads 123, 124, via the switching device 118, so that the electrodes 113, 114 act as the drive electrodes.

15 **[0040]** At step 310 a first signal induced across the subject S is measured. This is typically achieved by utilising the switching device 118 to interconnect the remaining measurement electrodes, in this case the electrodes 115, 116, to the sensor 112, thereby allowing signals induced within the subject S to be detected.

[0041] At step 320 the processing system 102 utilises an indication of the applied and induced signals to determine a first impedance value. The first impedance value may be formed from one or more measured impedance values. Thus, for example, if a single frequency BIA device is used, a single measured impedance value may be determined, whereas if a BIS device is used, multiple measured values may be determined, with a single value being determined for each applied frequency.

20 **[0042]** In addition, or alternatively to the impedance values being actual measured values, the impedance values may be based on impedance parameter values derived from the actual measurements. This can include parameter values such as the impedance at zero, characteristic or infinite frequencies (R_0 , Z_c , R_∞), as will be described in more detail below.

25 **[0043]** At step 330 the processing system 102 controls the switching device 118 to switch to an alternative electrode configuration. In this instance, for example, the electrodes 113, 115 may be used as the drive electrodes with the electrodes 114, 116 being used as measurement electrodes. Any other alternative configuration may also be used, depending on the implementation.

30 **[0044]** At step 340, a second signal is applied to the subject S using the second electrode configuration, with the induced signal across subject S being measured at step 350. At step 360 the applied and induced signals are processed to determine a second impedance value, which again can be formed from one or more measured impedance values, or parameter values derived therefrom.

35 **[0045]** At step 370, the processing system 102 uses the first and second impedance values to determine if any tissue anomalies might exist. An erroneous measurement will typically be determined if the difference between the first and second impedance values is greater than a reference amount. The magnitude of this reference may vary depending upon a number of factors and the processing system 102 is therefore typically arranged to compare the difference between the first and second impedance values to a reference value, which can be stored in memory, or the like. The reference value could be previously determined for example based on sample data collected for a nominal reference population, or based on the difference determined for other sites, as will be described in more detail below.

40 **[0046]** Once detected, this information can be used in one of two ways. For example, the measured values can be used to derive information regarding any associated biological anomaly, such as the presence, absence or degree of any tissue lesion, tumour, or the like, at step 380. Alternatively, at step 390, the erroneous measurement can be taken into account when performing other impedance analysis. Thus, for example, if wound or other impedance mapping is being performed to monitor wound healing, or the like, any erroneous reading can be rejected to ensure that this does not overtly influence the outcome of the analysis. Examples of this will be described in more detail below.

45 **[0047]** An example of a specific apparatus arrangement for performing impedance measurements, and in particular, for performing impedance mapping, will now be described with reference to Figure 4.

50 **[0048]** In particular in this instance an impedance measuring device 400 is connected to a multiplexer 410, which is controlled by a computer system 420, such as a personal computer or the like. In this instance the multiplexer 410 is coupled to an electrode array 430 having a number of electrodes 431 provided thereon.

55 **[0049]** In use the measuring device 400 generates signals to be applied to the subject via the electrode array with these signals being coupled to respective ones of the electrodes 431 utilising the multiplexer 410. Similarly, signals induced across the subject S can also be returned from electrodes 431 to the impedance measuring device 400 via the multiplexer 410. Overall operation of the multiplexer 410 can be controlled using the computer system 420, allowing this process to be substantially automated.

[0050] In one specific example, the measuring device 400 is in the form of an Impedimed Imp SFB7™. The drive and measurement electrodes from the SFB7 can be directed through a multiplexer 410, such as a 32 channel multiplexer

(ADG732) from Analog Devices and switching of the multiplexer output channels can be controlled via custom software operating on a standard computer system 420.

[0051] In this example, the electrode array 430 includes twenty five, 1 mm diameter electrodes separated by 0.77 mm in a 5x5 square. This allows a total of 64 separate measurements to be taken at 16 different sites giving an impedance map of 49 mm² on the surface of a subject, which may be an individual, a test medium, or the like. As a result of this, only 25 of the available 32 multiplexer channels are required for this arrangement.

[0052] An example of use of the system will now be described with reference to Figure 5.

[0053] At step 500 the electrode array 430 is applied to the subject S, and connected to the multiplexer 410, as described above. At this stage, systems, such as the measuring device 400, the multiplexer 410 and the computer system 420 are activated and configured as required in order to allow the measurement procedure to be performed.

[0054] At step 510 the computer system 420 selects a next site for measurement. The electrodes 431 are typically selected so as to form a tetrapolar arrangement, with a group of four electrodes 431 in the array 430 defining the site being measured. An example of this is shown in Figures 6A to 6D, in which four electrodes 431A, 431B, 431C, 431D are selectively used as measurement and drive electrodes for a single site.

[0055] In this example, four measurements can be made at each site by using the drive and measurement electrode arrangements shown in Figures 6A to 6D. Thus, in Figure 6A, the electrodes 431 A, 431B act as the measurement electrodes M₁, M₂, whereas the electrodes 431C, 431D act as the drive electrodes D₁, D₂. Successive measurements at the site can be made using different electrode configurations in which the drive and measurement electrodes M₁, M₂, D₁, D₂ are used as shown so that the tetrapolar configuration is effectively rotated by 90° for each successive measurement.

[0056] To achieve this, at step 520 the measuring device 400 controls the multiplexer 410 to couple the measuring device to the electrodes in accordance with a next one of the electrode configurations for the currently selected tetrapolar array. Thus, for example, for the first measurement, the arrangement shown in Figure 6A can be used so that the electrodes 431 A, 431B act as the measurement electrodes M₁, M₂, whereas the electrodes 431C, 431D act as the drive electrodes D₁, D₂.

[0057] The measuring device 400 then applies a drive signal to the subject via the selected drive electrodes 431C, 431D, allowing the signal induced across the measurement electrodes 431 A, 431B to be measured at step 530. An indication of this measured signal is returned to the measuring device 400, to allow the measuring device 400 to process the voltage and current signals and determine one or more an impedance values.

[0058] The impedance values determined will depend on the preferred implementation. For example, in the event that the measuring device 400 is performing BIA, then typically a single impedance value is calculated representing the measured impedance.

[0059] In contrast, if the measuring device performs a multiple frequency BIS analysis, as is the case with the SFB7™ device described above, then the impedance value can be based on impedance parameter values, such as values of the impedance at zero, characteristic or infinite frequencies (R₀, Z_c, R_∞). These values can be derived by the measuring device 400 based on the impedance response of the subject, which at a first level can be modelled using equation (1), commonly referred to as the Cole model:

$$Z = R_{\infty} + \frac{R_0 - R_{\infty}}{1 + (j\omega\tau)} \quad (1)$$

where: R_∞ = impedance at infinite applied frequency,

R₀ = impedance at zero applied frequency,

ω = angular frequency,

τ is the time constant of a capacitive circuit modelling the subject response.

[0060] However, the above represents an idealised situation which does not take into account the fact that the cell membrane is an imperfect capacitor. Taking this into account leads to a modified model in which:

$$Z = R_{\infty} + \frac{R_0 - R_{\infty}}{1 + (j\omega\tau)^{(1-\alpha)}} \quad (2)$$

where: α has a value between 0 and 1 and can be thought of as an indicator of the deviation of a real system from the ideal model.

EP 2 175 776 B1

[0061] The value of the impedance parameters R_0 and R_∞ may be determined in any one of a number of manners such as by:

- solving simultaneous equations based on the impedance values determined at different frequencies;
- using iterative mathematical techniques;
- extrapolation from a "Wessel plot";
- performing a function fitting technique, such as the use of a polynomial function.

[0062] It will be appreciated that as an alternative to the analysis being performed by the measuring device 400, the analysis can be performed in part, or in total, by the computer system 420, depending on the preferred implementation.

[0063] At step 550, the processing system 420 determines if all electrode configurations for the respective site are complete and if not returns to step 520. In this instance a next electrode configuration is selected, with steps 520 to 550 being repeated for this next electrode configuration. This process can then be repeated until each of the four electrode configurations shown in Figures 6A to 6D have been utilised for the current site.

[0064] Whilst it is possible to use all four of the indicated electrode configurations for the tetrapolar configuration, this is not essential, and in some circumstances, it is sufficient to use any two or more of the possible configurations. Thus, for example, the configurations used in Figures 6A and 6B can be used, in which the tetrapolar electrode configuration is effectively rotated by 90° . This is particularly useful as one drive and measurement electrode is effectively exchanged in the two different configurations, thereby maximising the chance of lesions located between the drive and measurement electrodes from being located, without requiring switching of each of the electrodes.

[0065] Furthermore, this arrangement can be used to provide a sequence of drive and measurement electrode configurations that can be used to perform multiple measurements at successive sites, with only a single drive and single measurement electrode being switched between successive measurements. An example of this is shown in Figures 6E to 6J.

[0066] Once all the electrode configurations are complete for a specific site, the measuring device 400 or the computer system 420 is used to analyse the impedance values and determine if the impedance measurements are indicative of a tissue anomaly. As mentioned above this may be achieved in any one of a number of ways but typically involves examining the difference between measured impedance values. The reason for this is that the impedance measured at a given site should be substantially invariant irrespective of the electrode configuration used. Consequently, any variation in measured impedance values for different electrode configurations indicates that the tissue is non-uniform and in particular that there is likely to be a low impedance lesion situated between the drive electrodes D_1 , D_2 and the measurement electrodes M_1 , M_2 .

[0067] In this regard, when the electrodes are provided in the arrangement of Figures 6A to 6D, there are usually regions of positive sensitivity between the drive electrodes D_1 , D_2 and between the measurement electrodes M_1 , M_2 . In addition to this, there are generally regions of negative sensitivity between each pair of drive and measurement electrodes D_1 , M_2 and M_1 , D_2 . These size and magnitude of the areas of negative and positive sensitivity will vary depending on the exact electrode configuration.

[0068] For negative field region, a lower resistance than the surrounding tissue will result in an increase in measured impedance, whereas a lower resistance in the positive field region will result in a decrease in measured impedance. Example tissue electrical properties as given by Brown, B. H., Tidy, J. A., Boston, K., Blackett, A. D., Smallwood, R. H. and Sharp, F. (2000a). "Relation between tissue structure and imposed electrical current flow in cervical neoplasia," The Lancet 355: 892-895, are shown in Table 1 below.

Table 1

Healthy Tissue Mean (SD)	Cancerous Tissue Mean (SD)
$R_E = 19.0 (7.77) \text{ m}$	$R_E = 3.85 (2.89) \text{ m}$
$R_I = 2.31 (4.04) \text{ m}$	$R_I = 6.10 (2.57) \text{ m}$
$C = 1.12 (1.96) \mu\text{F/m}$	$C = 1.01 (1.93) \mu\text{F/m}$

[0069] Thus, as cancerous tissue generally has a lower resistance, a cancerous lesion between the drive electrodes D_1 , D_2 or between the measurement electrodes M_1 , M_2 . will result in a decreased impedance measurement, whereas a lesion between the each pair of drive and measurement electrodes D_1 , M_2 or M_1 , D_2 , will result in an increased impedance measurement.

[0070] It will therefore be appreciated that examining differences between impedance measurements with different

electrode configurations can allow tissue anomalies such as lesions, to be detected.

[0071] In one example this is achieved by determining the difference between the impedance values determined using the different electrode configurations, at step 560. The maximum determined difference is then compared to a reference at step 570. The reference, which is typically previously determined and stored in memory of the measuring device 400 or the computer system 420, represents a threshold value so that if the difference between impedance values is greater than the reference, then this indicates that a tissue anomaly is present.

[0072] The reference can be determined in any one of a number of ways depending on the preferred implementation. For example, the reference may be determined by studying a number of healthy individuals (individuals without lesions or other biological anomalies) and/or unhealthy individuals (individuals with lesions or other anomalies) and calculating a range of variations between impedance values at a given site. This can be used to provide an indication of typical differences between impedance values for a healthy individual, thereby allowing a threshold to be established for tissue anomalies.

[0073] A further alternative is to derive the reference from previous measurements made for the respective individual. For example, if the individual undergoes a medical intervention, such as surgery, or the like, which may result in a lesion forming, then measurements can be made for the individual prior to the intervention, or following initial development of the lesion. This can be used to establish a baseline of differences in impedance values for the individual, either prior to the lesion forming, or following lesion formation. This baseline can then be used as a subject specific reference so that changes in the difference between the impedance values for the individual, can be used to monitor lesion development and/or effectiveness of treatment.

[0074] A further option is to determine the reference using a statistical analysis of measurements made for a number of different sites. This could be performed by examining the mean difference for a number of sites over a region, and then calculating the reference based on a value that is a number of standard deviations from the mean. Accordingly, in this instance, an anomaly is identified if the difference for a site is more than a set number of standard deviations from the mean difference value for a number of sites.

[0075] In any event, if the reference is exceeded and the result is determined to be indicative of a tissue anomaly at step 580, then the site is identified as a tissue anomaly at step 590. Once this is completed or otherwise, at step 600 the computer system 420 will determine if all sites are complete and if not will return to step 510 to select the next site in the electrode array 430. This will typically involve using the electrodes 631C, 631D and two electrodes in the next column in the array.

[0076] This process can be repeated for all of the sites defined by the electrode array 630, allowing an impedance map to be generated at 610. The impedance map can be used to indicate variations in tissue properties, or the like, which in turn can be used for a number of purposes, such as to monitor healing of wounds or the like.

[0077] As will be appreciated by persons skilled in the art, being able to identify, and subsequently discount or otherwise account for such tissue anomalies allows improved results to be obtained for impedance mapping processes.

[0078] Furthermore, this process can also be used to identify and monitor low impedance lesions, tumours or the like. For example, determining the magnitude of the difference between different impedance values obtained for a given site allows an indication of the severity of the lesion to be determined. By monitoring changes in the difference over time, this allows variations in lesion severity over time to be monitored.

[0079] Specific example trials of the process of performing impedance mapping will now be described.

[0080] The blood for each trial was collected from the same animal and treated with 70 mg/L of heparine to prevent coagulation. Blood for each measurement was prepared in the same manner by allowing it to cool to room temperature (22 °C) and the red blood cells separated via a centrifuge. The separated red blood cells and plasma could then be mixed in appropriate proportions to obtain the required haematocrit for testing. Samples were also collected and allowed to coagulate, these were used to represent a high impedance tissue medium at R_0 due to the small extracellular space.

[0081] In a first example, impedance maps were initially established for homogenous haematocrit in an in-vitro environment. To achieve this, bovine blood was used as the conductive medium, with impedance maps being obtained using homogenous samples with a range of haematocrit values (0, 20, 40, 60, 80%).

[0082] The impedance maps of R_0 measured for blood samples of various haematocrit are shown in Figure 8. Each measurement location shown was measured using the tetrapolar electrode orientation arrangement described above, at each of the four possible electrode orientations. These four R_0 values measured using different electrode orientation were then averaged to produce one R_0 map as shown in Figure 9A.

[0083] A plot of mean R_0 for each impedance map against haematocrit is shown in Figure 9B. This highlights that there is a large increase in impedance with haematocrit concentration. The plot follows an exponential trend as expected since the R_0 value of a sample with haematocrit of 100 % would approach infinity due to the very small extracellular space. The range of haematocrit values has also shown to have a significant and measurable change in R_0 . This is useful if impedance maps were to be determined with two or more volumes of blood with differing haematocrits.

[0084] In a second trial, the electrode array 430 was covered with plasma (haematocrit of 0%) and red blood cells (haematocrit of 100%) injected onto the corner of the electrode array, as shown for example in Figure 7.

[0085] An example of the bioimpedance map of an average value of R_0 obtained for each site is shown at 1000 in Figure 10. The smaller four maps 1001, 1002, 1003, 1004, correspond to the impedance values for R_0 measured using respective electrode configurations, as shown for example in Figures 6A to 6D.

[0086] It is evident from the above examples that bioimpedance maps for haematocrit 0 to 80% result in reasonably consistent values of R_0 (standard deviation <3%). The uniform measurements also demonstrate that the remaining 21 electrodes have little effect on the measurements from the 4 electrodes actively involved. Hence these 21 electrodes do not shunt the current between the active drive electrodes.

[0087] The bioimpedance map of plasma with introduced cells clearly shows an increase in R_0 at the site of the introduced cells, shown in Figure 10. The R_0 value in the lower left corner (95 Ω) is much higher than that in the upper right corner (62 Ω) which corresponds to that of the homogenous plasma sample. While the resistance in the lower left corner is higher than that of plasma it is less than that obtain for 80 and 60% haematocrit. The reason for this is due to the cells dispersing throughout the plasma (as shown in Figure 7) effectively reducing the haematocrit of the introduced red blood cell sample.

[0088] As shown in this example, the values of R_0 determined for the site 1005 differ significantly for the four different orientations, thereby indicating the presence of a biological anomaly at the site 1005.

[0089] In this example, the sensitivity region between the two electrodes 431B, 431 D is positive for the maps 1002, 1004 resulting in an increased measured impedance if a higher impedance medium is present between the electrodes. This increase in impedance is clearly seen in the maps 1002, 1004. The maps 1001, 1003 on the left show a decrease in impedance because the region between the two electrodes 431B, 431D is of negative sensitivity in this configuration, thereby resulting in a decreased measured impedance when a higher impedance medium is located in the region.

[0090] When performing an impedance analysis, the can be taken into account by excluding this site from the larger impedance map, allowing an accurate average to be determined that excludes any anomaly. Alternatively different mechanisms may be used for taking this into account. For example, averaging of the four measured values of R_0 , at the given site, can reduce the impact of the tissue anomaly. In this regard, the averaged impedance map would be unaffected since the higher and lower measured impedance values effectively average to cancel each other out, so that the R_0 value in this region of the larger map is not anomalous.

[0091] Alternatively, the impedance of adjacent sites can be used to determine a value for R_0 which is unaffected by the tissue anomaly. Thus, for example, examination of the maps 1001, 1002, 1003, 1004 for each tetrapolar configuration highlights that the determined impedance values determined for the site 1005 in the maps 1001, 1003 are similar to those of adjacent sites, whereas the impedance values determined for the site 1005 in the maps 1002, 1004 are significantly different. This implies that the lesion or other tissue anomaly is located between the drive and measurement electrodes for the electrode configurations used in determining the maps 1002, 1004, meaning that these readings are erroneous. Consequently, the impedance value used for the overall impedance map could be based on the impedance values determined for the impedance maps 1001, 1003 as these readings are more likely to be accurate.

[0092] This can be performed for example to discount readings that are believed to be anomalous, for example due to errors in the measuring process, poor electrode contact, or the like.

[0093] However, more typically the results are used to detect tissue anomalies, such as lesions or the like. Thus, as measurements made using orthogonal electrode orientations at a region of non-homogeneity will produce different measured impedances, whereas a region of homogeneity will produce the same measurements. This allows tissue anomalies, such as lesions, to be identified, and furthermore allows lesion boundaries to be determined.

[0094] An example of this will now be described with reference to Figure 11. For the purpose of this example, the impedance map of plasma with introduced red blood cells shown in Figure 10 was used. In this example, the smaller maps 1001, 1003 are averaged, as are maps 1002, 1004, with the difference between these resulting maps being shown in the map 1100 of Figure 11.

[0095] In this example, a region 1101 is highlighted which has low positive values of R_0 , where dispersed blood is present, and this is due to different haematocrits being located under each of these electrode sets. Within this region, the site 1102 has an R_0 value of zero due to a high but homogeneous haematocrit sample being located under the electrode set.

[0096] In an upper right region 1103 of the impedance map, the average R_0 values are close to zero due to the sample under the electrode sets being homogeneous plasma, the red blood cells having not dispersed into this region.

[0097] At the site 1105, a large negative value of R_0 is present, implying the presence of a tissue anomaly or lesion. The site 1106 is also negative, but not to such a degree. This implies that a tissue anomaly is likely to be present at the site 1105 and that this may extend slightly into the site 1106. Accordingly, it will be appreciated that this not only allows tissue anomalies to be identified, but also allows the extent and/or boundaries of the tissue anomaly to be determined.

[0098] In a third example, a clot was introduced to the plasma in place of the red blood cells. Figures 12A, to 12C, display typical impedance maps 1200 with clots introduced in various regions on the electrode array. In the example of Figures 12A to 12C, the average value of R_0 obtained for each site is shown at 1200, with the four smaller maps 1201, 1202, 1203, 1204, corresponding to the impedance values for R_0 measured using respective electrode configurations,

as shown for example in Figures 6A to 6D.

[0099] In Figure 12A, the clot is introduced beneath a central electrode, the location of which is shown at 1210. In Figure 12B, the clot is located at the site 1220, whilst in the example of Figure 12C, the clot is provided in the region 1230, encompassing the sites 1231, 1232. These examples show clear impedance changes at the boundaries of the red blood cell clots due to minimal dispersion of red blood cells. This highlights how in practice the process can be used to identify the size of tissue anomalies, such as lesions and monitor their growth or change in shape over time.

[0100] It will therefore be appreciated that the above described methods provide techniques for identifying the presence, absence and even extent of tissue anomalies, such as lesions. These anomalies did not appear to alter the resultant impedance map once averaged, meaning that the averaging of results prevents the tissue anomalies being detected. However, this does mean that even in the event that anomalies exist, this avoids the need to remove and discard such measurements.

[0101] Thus, the above described techniques provide a non-subjective method for determining lesion size and hence possible biopsy margins.

[0102] By using an electrode array coupled to a suitable switching system, this allows measurements to be rapidly performed over an area of the subject. Furthermore, by using only two measurements at each site, this can reduce the number of measurements required at each region and minimise the time taken to acquire an impedance map.

[0103] Persons skilled in the art will appreciate that numerous variations and modifications will become apparent. All such variations and modifications which become apparent to persons skilled in the art, should be considered to fall within the spirit and scope that the invention broadly appearing before described.

[0104] Thus, for example, it will be appreciated that features from different examples above may be used interchangeably where appropriate. Furthermore, whilst the above examples have focussed on a subject such as a human, it will be appreciated that the measuring device and techniques described above can be used with any subject such as an animal, including but not limited to, primates, livestock, performance animals, such race horses, or the like, as well as to in-vitro samples, or the like.

[0105] The above described processes can be used for determining the health status of an individual, including determining the presence, absence or degree of a range of biological anomalies. It will be appreciated from this that whilst the above examples use the term lesion, this is for the purpose of example only and is not intended to be limiting.

[0106] Furthermore, whilst the above described examples have focussed on the application of a current signal to allow a voltage to be measured, this is not essential and the process can also be used when applying a voltage signal to allow a current to be sensed.

[0107] The above described impedance maps are determined based on the value of the impedance parameter R_0 . However, it will be appreciated that impedance maps based on other impedance parameters, such as actual measured impedances, or values of R_∞ , Z_C , or the like.

Claims

1. Apparatus for use in analysing impedance measurements performed on a subject, the apparatus including a processing system configured to:

- a) determine at least one first impedance value, measured at a site using a first electrode configuration;
- b) determine at least one second impedance value, measured at the site using a second electrode configuration; **characterized by** the further configuration to
- c) determine a difference between the first and second impedance values; and,
- d) determine the presence, absence or degree of an anomaly using the determined difference.

2. Apparatus according to claim 1, wherein the apparatus includes:

- a) a signal generator for applying drive signals to the subject using drive electrodes; and,
- b) a sensor for determining measured signals using measurement electrodes, and wherein the processing system:
 - i) causes the signal generator to apply one or more drive signals to the subject; and,
 - ii) determines an indication of the measured signals measured using the sensor.

3. Apparatus according to claim 2, wherein the processing system is further configured to:

- a) determine an indication of drive signals applied to the subject;

- b) determines an indication of measured signals determined using the sensor; and,
- c) uses the indications to determine an impedance value.

5 4. Apparatus according to any one of the claims 1 to 3, wherein the apparatus includes an electrode array having a number of electrodes provided thereon, and wherein in use, selected ones of the electrodes are used as drive and measurement electrodes.

5. Apparatus according to claim 4, wherein the apparatus includes:

- 10 a) a signal generator for generating drive signals;
b) a sensor for sensing measured signals; and,
c) a switching device, and wherein the processing system selectively interconnects the signal generator and the sensor to electrodes in the array using the switching device.

15 6. Apparatus according to claim 4, wherein the processing system is further configured to:

- a) cause a first measurement to be performed at a site using first and second electrodes as drive electrodes and using third and fourth electrodes as measurement electrodes; and,
20 b) cause a second measurement to be performed at the site using first and third electrodes as drive electrodes and using second and fourth electrodes as measurement electrodes.

7. Apparatus according to claim 4 or claim 5, wherein the processing system is further configured to:

- 25 a) cause a measurement to be performed at a site using first and second electrodes as drive electrodes and using third and fourth electrodes as measurement electrodes; and,
b) cause a measurement to be performed at a second site using at least two of the first, second, third and fourth electrodes.

30 8. Apparatus according to claim 7, wherein the processing system is further configured to:

- a) cause a first measurement to be performed at a first site using first and second electrodes as drive electrodes and using third and fourth electrodes as measurement electrodes;
b) cause a second measurement to be performed at the first site using first and third electrodes as drive electrodes and using second and fourth electrodes as measurement electrodes;
35 c) cause a third measurement to be performed at a second site using third and fifth electrodes as drive electrodes and using fourth and sixth electrodes as measurement electrodes;
d) cause a fourth measurement to be performed at the second site using third and fourth electrodes as drive electrodes and using fifth and sixth electrodes as measurement electrodes.

40 9. Apparatus according to claim 1, wherein the apparatus includes a tetrapolar electrode arrangement, the first and second electrode configurations using a different configuration of drive and measurement electrodes.

10. Apparatus according to any one of the claims 1 to 9, wherein the processing system is further configured to:

- 45 a) determine impedance values at a number of different sites; and,
b) determine an impedance map using the impedance values at each site.

11. Apparatus according to any one of claims 1 to 10, wherein the processing system is further configured to:

- 50 a) compare the difference to a reference; and,
b) determine an anomaly depending on the result of the comparison.

12. Apparatus according to any one of claims 1 to 11, wherein the impedance values are at least one of:

- 55 a) measured impedance values; and,
b) impedance parameter values derived from measured impedance values.

13. Apparatus according to any one of claims 1 to 12, wherein the processing system is further configured to:

- a) cause at least one first impedance value to be measured at a site using a first electrode configuration; and,
- b) cause at least one second impedance value to be measured at the site using a second electrode configuration.

5 14. Apparatus according to any one of claims 1 to 13, wherein the anomaly includes any one or a combination of:

- a) a tissue anomaly;
- b) an erroneous measurement; and,
- c) a tissue lesion.

10 15. A method for use in performing impedance measurements on a subject, the method including, using a processing system for:

- a) determining at least one first impedance value, measured at a site using a first electrode configuration;
- b) determining at least one second impedance value, measured at the site using a second electrode configuration;
- c) determining a difference between the first and second impedance values; and,
- d) determining the presence, absence or degree of an anomaly using the determined difference.

20 Patentansprüche

21 1. Vorrichtung zur Verwendung in der Analyse von an einem Probanden durchgeführten Impedanzmessungen, wobei die Vorrichtung ein Verarbeitungssystem beinhaltet, das konfiguriert ist zum

- a) Bestimmen von wenigstens einem an einem Ort unter Verwendung einer ersten Elektrodenkonfiguration gemessenen ersten Impedanzwert;
- b) Bestimmen von wenigstens einem an dem Ort unter Verwendung einer zweiten Elektrodenkonfiguration gemessenen zweiten Impedanzwert;

25 **gekennzeichnet durch** die weitere Konfiguration zum

- c) Bestimmen einer Differenz zwischen dem ersten und dem zweiten Impedanzwert und
- d) Bestimmen der Anwesenheit, Abwesenheit oder eines Grads einer Anomalie unter Verwendung der bestimmten Differenz.

30 2. Vorrichtung nach Anspruch 1, wobei die Vorrichtung Folgendes beinhaltet:

- a) einen Signalgenerator zum Anlegen von Ansteuersignalen an den Probanden unter Verwendung von Ansteuerelektroden und
- b) einen Sensor zum Bestimmen gemessener Signale unter Verwendung von Messelektroden, und wobei das Verarbeitungssystem:
 - i) den Signalgenerator zum Anlegen von einem oder mehr Ansteuersignalen an den Probanden veranlasst und
 - ii) eine Anzeige der gemessenen Signale, die unter Verwendung des Sensors gemessen wurden, bestimmt.

35 3. Vorrichtung nach Anspruch 2, wobei das Verarbeitungssystem ferner konfiguriert ist zum:

- a) Bestimmen einer Anzeige von an den Probanden angelegten Ansteuersignalen,
- b) Bestimmen einer Anzeige von gemessenen Signalen, die unter Verwendung des Sensors bestimmt wurden, und
- c) Verwenden der Anzeigen zum Bestimmen eines Impedanzwerts.

40 4. Vorrichtung nach einem der Ansprüche 1 bis 3, wobei die Vorrichtung ein Elektrodenarray mit einer Anzahl von daran bereitgestellten Elektroden beinhaltet und wobei im Gebrauch ausgewählte der Elektroden als Steuer- und Messelektroden verwendet werden.

45 5. Vorrichtung nach Anspruch 4, wobei die Vorrichtung Folgendes beinhaltet:

EP 2 175 776 B1

- a) einen Signalgenerator zum Erzeugen von Ansteuersignalen;
- b) einen Sensor zum Erfassen gemessener Signale und
- c) eine Schalteinrichtung, und wobei das Verarbeitungssystem den Signalgenerator und den Sensor unter Verwendung der Schalteinrichtung selektiv mit Elektroden in dem Array verschaltet.

5

6. Vorrichtung nach Anspruch 4, wobei das Verarbeitungssystem ferner konfiguriert ist zum:

- a) Veranlassen der Durchführung einer ersten Messung an einem Ort unter Verwendung erster und zweiter Elektroden als Ansteuerelektroden und unter Verwendung dritter und vierter Elektroden als Messelektroden und
- b) Veranlassen der Durchführung einer zweiten Messung an dem Ort unter Verwendung erster und dritter Elektroden als Ansteuerelektroden und unter Verwendung zweiter und vierter Elektroden als Messelektroden.

10

7. Vorrichtung nach Anspruch 4 oder Anspruch 5, wobei das Verarbeitungssystem ferner konfiguriert ist zum:

- a) Veranlassen der Durchführung einer Messung an einem Ort unter Verwendung erster und zweiter Elektroden als Ansteuerelektroden und unter Verwendung dritter und vierter Elektroden als Messelektroden und
- b) Veranlassen der Durchführung einer Messung an einem zweiten Ort unter Verwendung von wenigstens zwei der ersten, zweiten, dritten und vierten Elektroden.

15

8. Vorrichtung nach Anspruch 7, wobei das Verarbeitungssystem ferner konfiguriert ist zum:

- a) Veranlassen der Durchführung einer ersten Messung an einem ersten Ort unter Verwendung erster und zweiter Elektroden als Ansteuerelektroden und unter Verwendung dritter und vierter Elektroden als Messelektroden;
- b) Veranlassen der Durchführung einer zweiten Messung an dem ersten Ort unter Verwendung erster und dritter Elektroden als Ansteuerelektroden und unter Verwendung zweiter und vierter Elektroden als Messelektroden;
- c) Veranlassen der Durchführung einer dritten Messung an einem zweiten Ort unter Verwendung dritter und fünfter Elektroden als Ansteuerelektroden und unter Verwendung vierter und sechster Elektroden als Messelektroden;
- d) Veranlassen der Durchführung einer vierten Messung an dem zweiten Ort unter Verwendung dritter und vierter Elektroden als Ansteuerelektroden und unter Verwendung fünfter und sechster Elektroden als Messelektroden.

25

30

9. Vorrichtung nach Anspruch 1, wobei die Vorrichtung eine tetrapolare Elektrodenanordnung beinhaltet, wobei die erste und die zweite Elektrodenkonfiguration eine verschiedene Konfiguration von Ansteuer- und Messelektroden verwenden.

35

10. Vorrichtung nach einem der Ansprüche 1 bis 9, wobei das Verarbeitungssystem ferner konfiguriert ist zum:

- a) Bestimmen von Impedanzwerten an einer Anzahl verschiedener Orte und
- b) Bestimmen eines Impedanzkennfelds unter Verwendung der Impedanzwerte an jedem Ort.

40

11. Vorrichtung nach einem der Ansprüche 1 bis 10, wobei das Verarbeitungssystem ferner konfiguriert ist zum:

- a) Vergleichen der Differenz mit einer Referenz und
- b) Bestimmen einer Anomalie in Abhängigkeit von den Ergebnissen des Vergleichs.

45

12. Vorrichtung nach einem der Ansprüche 1 bis 11, wobei die Impedanzwerte wenigstens eines der Folgenden sind:

- a) gemessene Impedanzwerte und
- b) Impedanzparameterwerte, die von gemessenen Impedanzwerten abgeleitet sind.

50

13. Vorrichtung nach einem der Ansprüche 1 bis 12, wobei das Verarbeitungssystem ferner konfiguriert ist zum:

- a) Veranlassen, dass wenigstens ein erster Impedanzwert an einem Ort unter Verwendung einer ersten Elektrodenkonfiguration gemessen wird, und
- b) Veranlassen, dass wenigstens ein zweiter Impedanzwert an dem Ort unter Verwendung einer zweiten Elek-

55

trodenkonfiguration gemessen wird.

14. Vorrichtung nach einem der Ansprüche 1 bis 13, wobei die Anomalie eine beliebige oder eine Kombination der Folgenden beinhaltet:

- a) eine Gewebeanomalie;
- b) eine fehlerhafte Messung und
- c) eine Gewebeläsion.

15. Verfahren zur Verwendung bei der Durchführung von Impedanzmessungen an einem Probanden, wobei das Verfahren das Verwenden eines Verarbeitungssystems beinhaltet zum:

- a) Bestimmen von wenigstens einem an einem Ort unter Verwendung einer ersten Elektrodenkonfiguration gemessenen ersten Impedanzwert;
- b) Bestimmen von wenigstens einem an dem Ort unter Verwendung einer zweiten Elektrodenkonfiguration gemessenen zweiten Impedanzwert;
- c) Bestimmen einer Differenz zwischen dem ersten und dem zweiten Impedanzwert und
- d) Bestimmen der Anwesenheit, Abwesenheit oder eines Grads einer Anomalie unter Verwendung der bestimmten Differenz.

Revendications

1. Appareil destiné à être utilisé dans l'analyse de mesures d'impédance effectuées sur un sujet, l'appareil comprenant un système de traitement configuré de façon à :

- a) déterminer au moins une première valeur d'impédance, mesurée au niveau d'un site à l'aide d'une première configuration d'électrodes ;
- b) déterminer au moins une seconde valeur d'impédance, mesurée au niveau du site à l'aide d'une seconde configuration d'électrodes ; **caractérisé en ce qu'il** est en outre configuré de façon à
- c) déterminer une différence entre les première et seconde valeurs d'impédance ; et,
- d) déterminer la présence, l'absence ou le degré d'une anomalie à l'aide de la différence déterminée.

2. 2) Appareil selon la revendication 1, l'appareil comprenant :

- a) un générateur de signaux destiné à appliquer des signaux d'attaque au sujet à l'aide d'électrodes d'attaque ; et,
- b) un capteur destiné à déterminer des signaux mesurés à l'aide d'électrodes de mesure ; et le système de traitement :
 - i) amenant le générateur de signaux à appliquer un ou plusieurs signaux d'attaque au sujet ; et,
 - ii) déterminant une indication des signaux mesurés, mesurés à l'aide du capteur.

3. Appareil selon la revendication 2, le système de traitement étant en outre configuré de façon à :

- a) déterminer une indication des signaux d'attaque appliqués au sujet ;
- b) déterminer une indication des signaux mesurés, déterminés à l'aide du capteur ; et,
- c) utiliser les indications afin de déterminer une valeur d'impédance.

4. Appareil selon l'une quelconque des revendications 1 à 3, l'appareil comprenant un réseau d'électrodes sur lequel sont disposées un certain nombre d'électrodes et, en cours d'utilisation, les électrodes sélectionnées parmi les électrodes étant utilisées en tant qu'électrodes d'attaque et de mesure.

5. Appareil selon la revendication 4, l'appareil comprenant :

- a) un générateur de signaux destiné à générer des signaux d'attaque ;
- b) un capteur destiné à détecter des signaux mesurés ; et,
- c) un dispositif de commutation ; et le système de traitement interconnectant sélectivement le générateur de signaux et le capteur aux électrodes du réseau à l'aide du dispositif de commutation.

EP 2 175 776 B1

6. Appareil selon la revendication 4, le système de traitement étant en outre configuré de façon à :

- 5
- a) amener à effectuer une première mesure au niveau d'un site à l'aide de première et deuxième électrodes en tant qu'électrodes d'attaque et à l'aide de troisième et quatrième électrodes en tant qu'électrodes de mesure ; et,
 - b) amener à effectuer une deuxième mesure au niveau du site à l'aide des première et troisième électrodes en tant qu'électrodes d'attaque et à l'aide des deuxième et quatrième électrodes en tant qu'électrodes de mesure.

10 7. Appareil selon la revendication 4 ou 5, le système de traitement étant en outre configuré de façon à :

- 15
- a) amener à effectuer une mesure au niveau d'un site à l'aide de première et deuxième électrodes en tant qu'électrodes d'attaque et à l'aide de troisième et quatrième électrodes en tant qu'électrodes de mesure ; et,
 - b) amener à effectuer une mesure au niveau d'un second site à l'aide d'au moins deux électrodes parmi les première, deuxième, troisième et quatrième électrodes.

8. Appareil selon la revendication 7, le système de traitement étant en outre configuré de façon à :

- 20
- a) amener à effectuer une première mesure au niveau d'un premier site à l'aide de première et deuxième électrodes en tant qu'électrodes d'attaque et à l'aide de troisième et quatrième électrodes en tant qu'électrodes de mesure ;
 - b) amener à effectuer une deuxième mesure au niveau du premier site à l'aide des première et troisième électrodes en tant qu'électrodes d'attaque et à l'aide des deuxième et quatrième électrodes en tant qu'électrodes de mesure ;
 - 25 c) amener à effectuer une troisième mesure au niveau d'un second site à l'aide de troisième et cinquième électrodes en tant qu'électrodes d'attaque et à l'aide de quatrième et sixième électrodes en tant qu'électrodes de mesure ;
 - d) amener à effectuer une quatrième mesure au niveau du second site à l'aide des troisième et quatrième électrodes en tant qu'électrodes d'attaque et à l'aide des cinquième et sixième électrodes en tant qu'électrodes de mesure.
- 30

9. Appareil selon la revendication 1, l'appareil comprenant un agencement d'électrodes tétrapolaire, les première et seconde configurations d'électrodes utilisant une configuration différente d'électrodes d'attaque et de mesure.

35 10. Appareil selon l'une quelconque des revendications 1 à 9, le système de traitement étant en outre configuré de façon à :

- a) déterminer des valeurs d'impédance au niveau d'un certain nombre de différents sites ; et,
- b) déterminer une carte d'impédance à l'aide des valeurs d'impédance au niveau de chaque site.

40 11. Appareil selon l'une quelconque des revendications 1 à 10, le système de traitement étant en outre configuré de façon à :

- 45
- a) comparer la différence à une référence ; et,
 - b) déterminer une anomalie en fonction du résultat de la comparaison.

12. Appareil selon l'une quelconque des revendications 1 à 11, les valeurs d'impédance étant au moins des valeurs parmi :

- 50
- a) des valeurs d'impédance mesurées ; et,
 - b) des valeurs de paramètre d'impédance dérivées des valeurs d'impédance mesurées.

13. Appareil selon l'une quelconque des revendications 1 à 12, le système de traitement étant en outre configuré de façon à :

- 55
- a) amener à mesurer au moins une première valeur d'impédance au niveau d'un site à l'aide d'une première configuration d'électrodes ; et,
 - b) amener à mesurer au moins une seconde valeur d'impédance au niveau du site à l'aide d'une seconde configuration d'électrodes.

EP 2 175 776 B1

14. Appareil selon l'une quelconque des revendications 1 à 13, l'anomalie comprenant une anomalie ou une combinaison d'anomalies quelconque parmi :

5

- a) une anomalie tissulaire ;
- b) une mesure erronée ; et,
- c) une lésion tissulaire.

15. Procédé destiné à être utilisé dans la mise en oeuvre de mesures d'impédance sur un sujet, le procédé consistant, à l'aide d'un système de traitement, à :

10

- a) déterminer au moins une première valeur d'impédance, mesurée au niveau d'un site à l'aide d'une première configuration d'électrodes ;
- b) déterminer au moins une seconde valeur d'impédance, mesurée au niveau du site à l'aide d'une seconde configuration d'électrodes ;
- c) déterminer une différence entre les première et seconde valeurs d'impédance ; et,
- d) déterminer la présence, l'absence ou le degré d'une anomalie à l'aide de la différence déterminée.

15

20

25

30

35

40

45

50

55

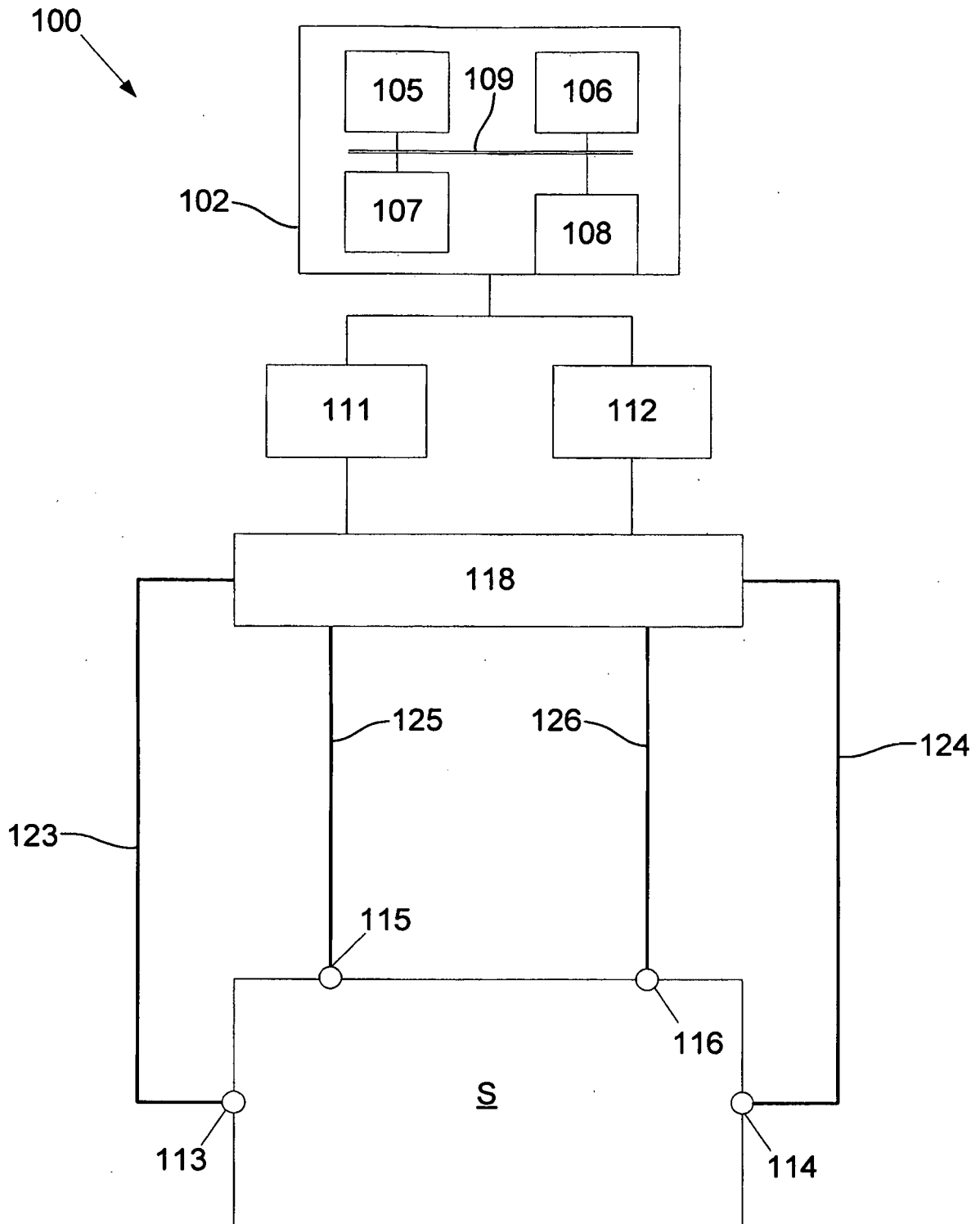

Fig. 1

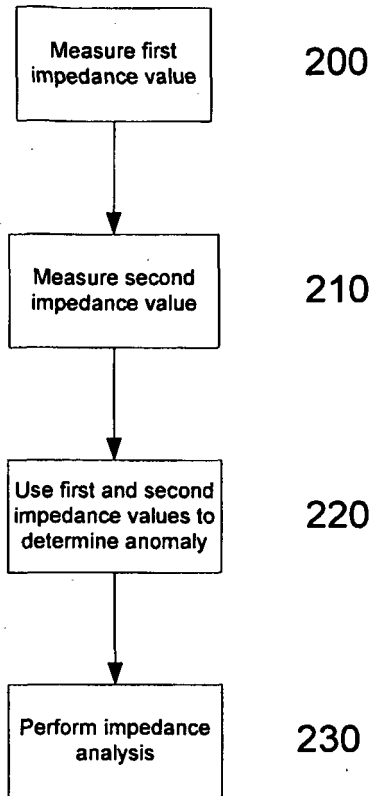

Fig. 2

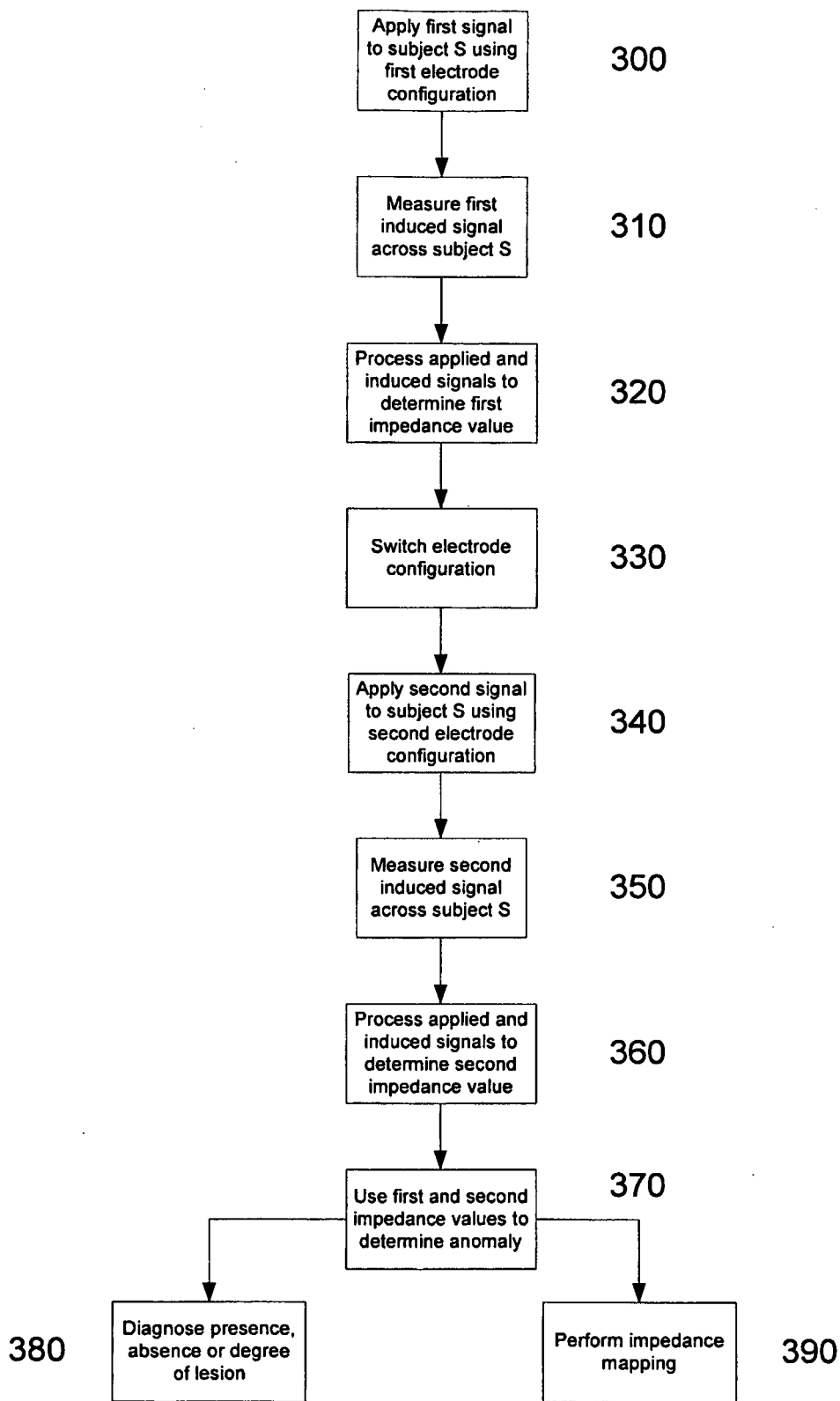

Fig. 3

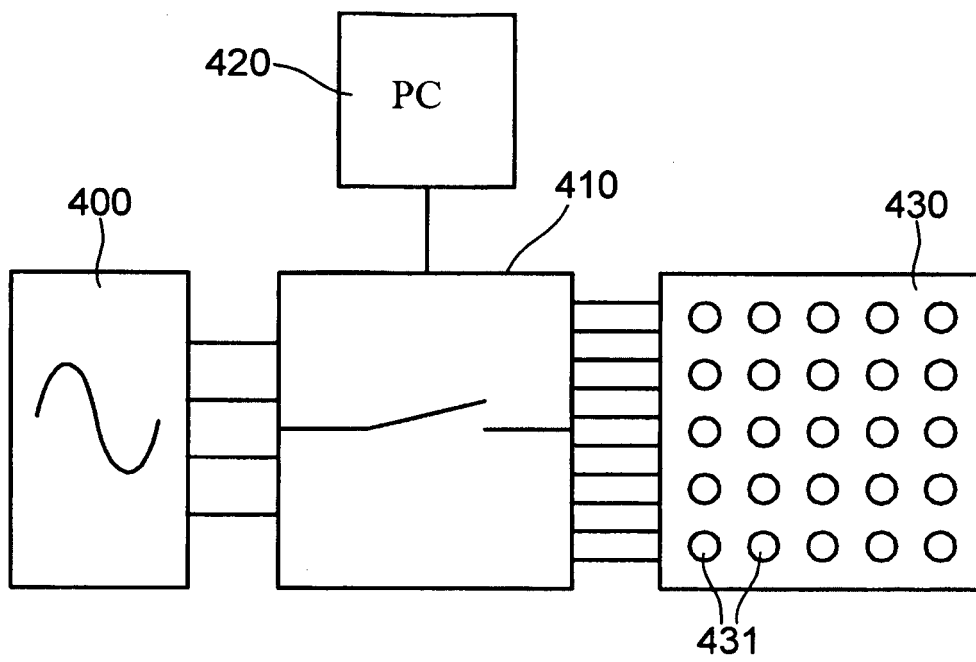

Fig. 4

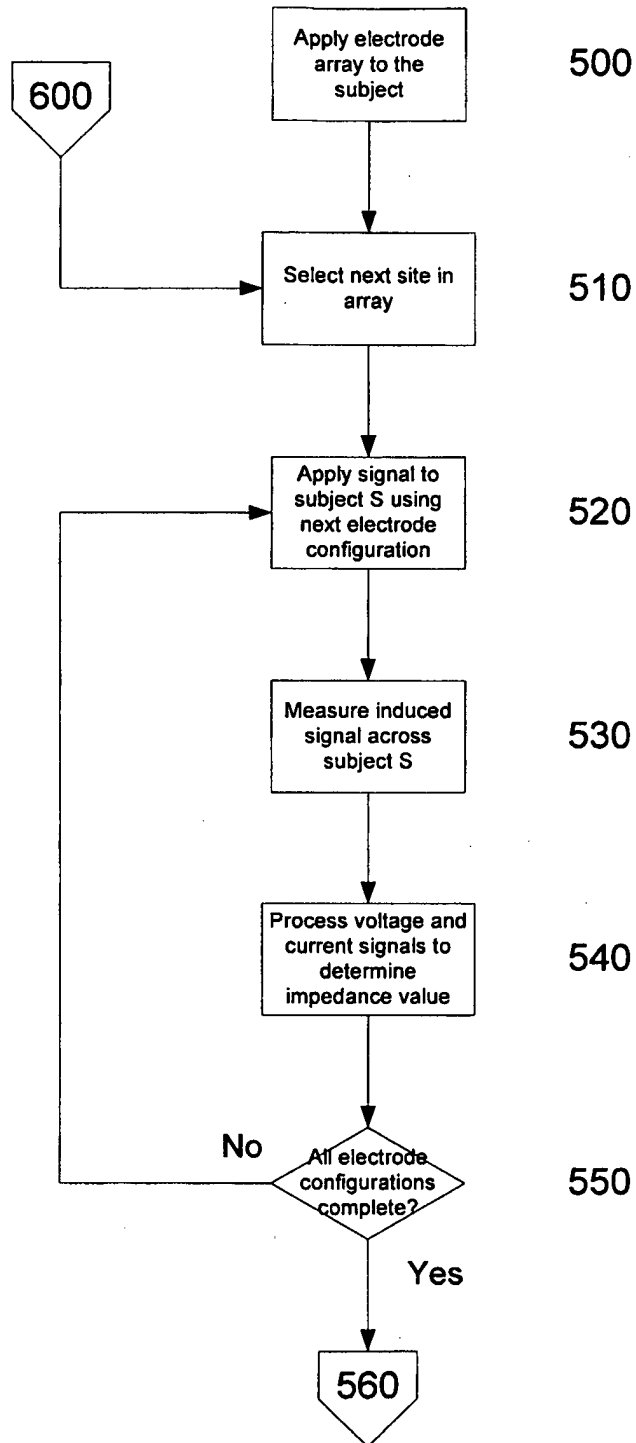

Fig. 5A

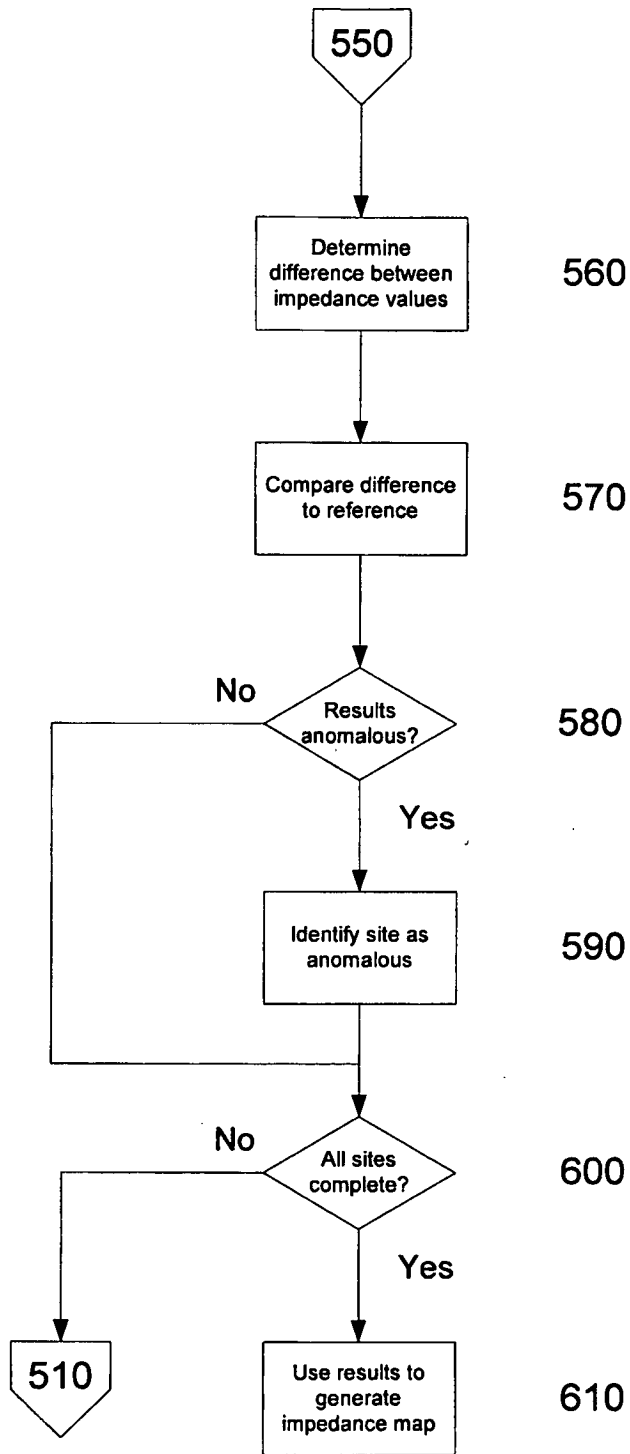

Fig. 5B

Fig. 6A

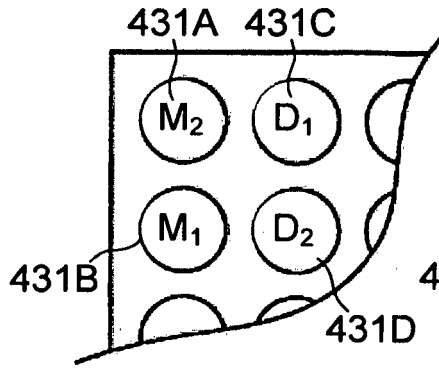

Fig. 6B

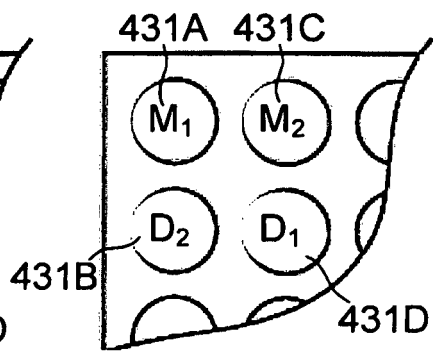

Fig. 6C

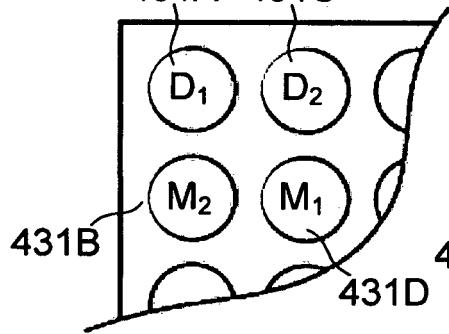

Fig. 6D

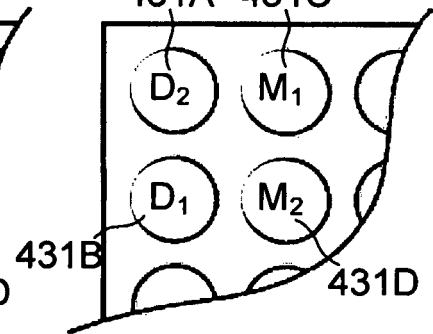

Fig. 6C

Fig. 6D

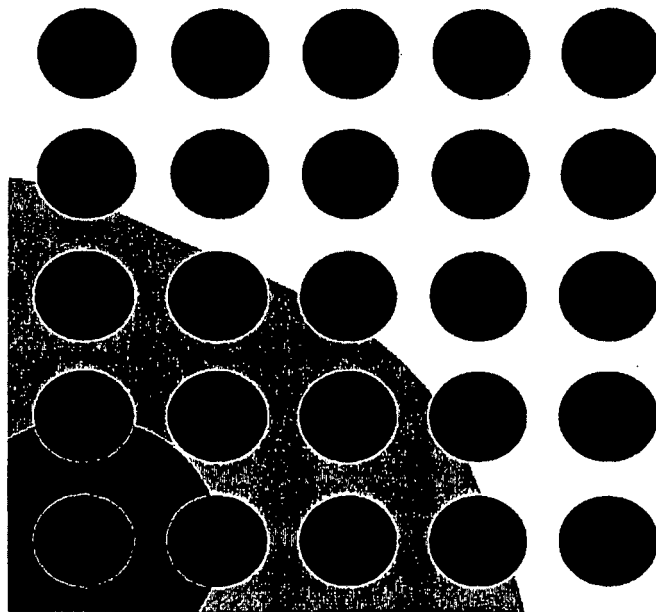

Fig. 7

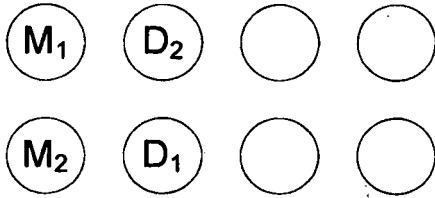

Fig. 6E

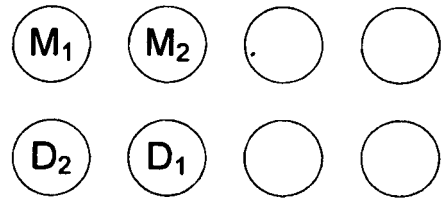

Fig. 6F

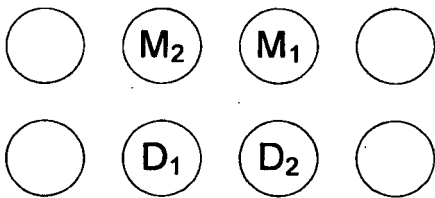

Fig. 6G

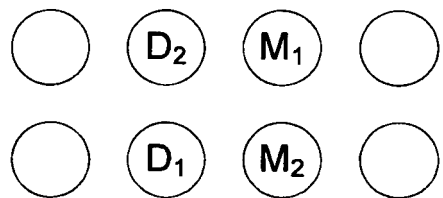

Fig. 6H

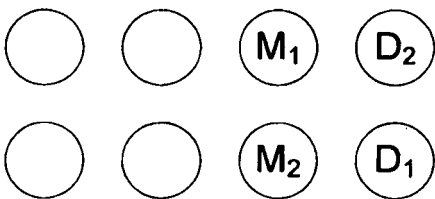

Fig. 6I

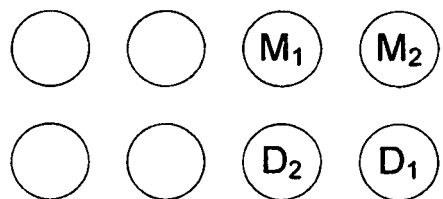

Fig. 6J

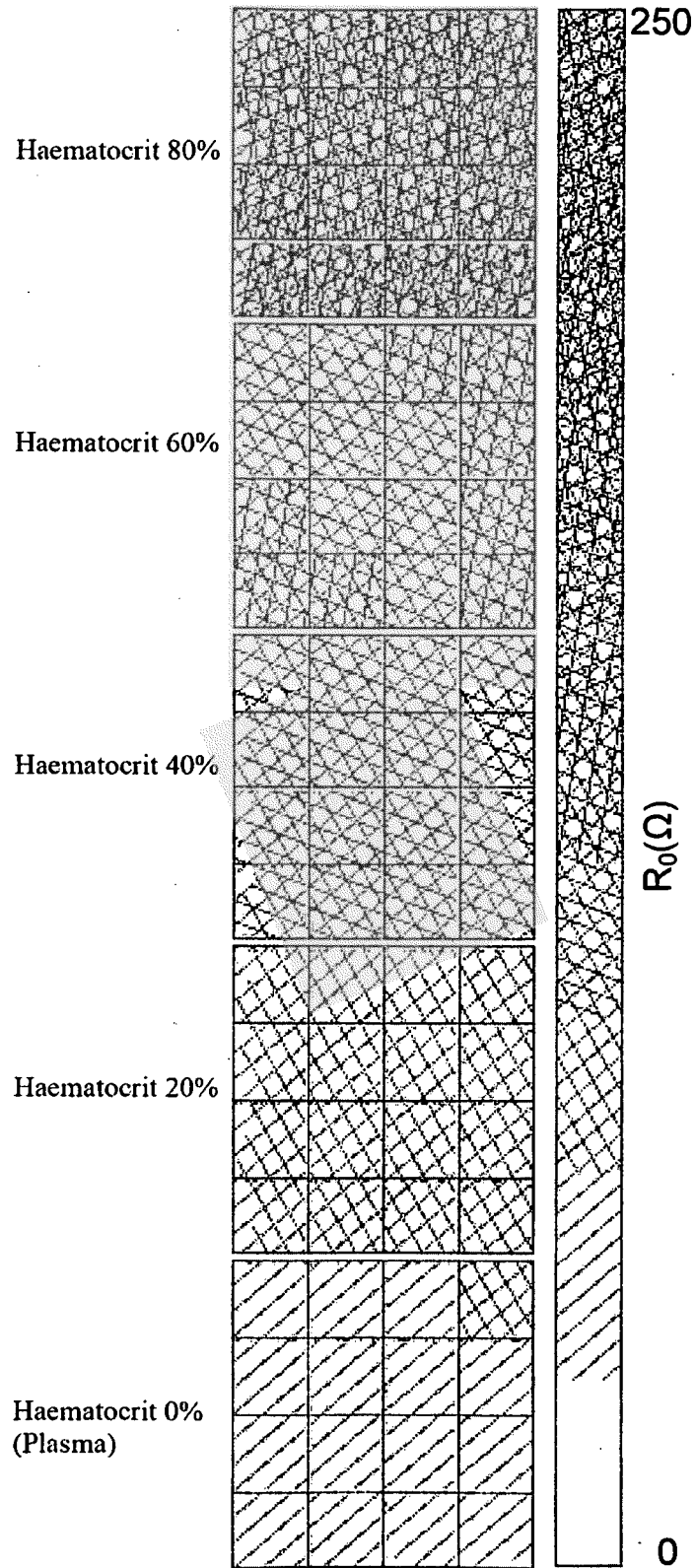

Fig. 8

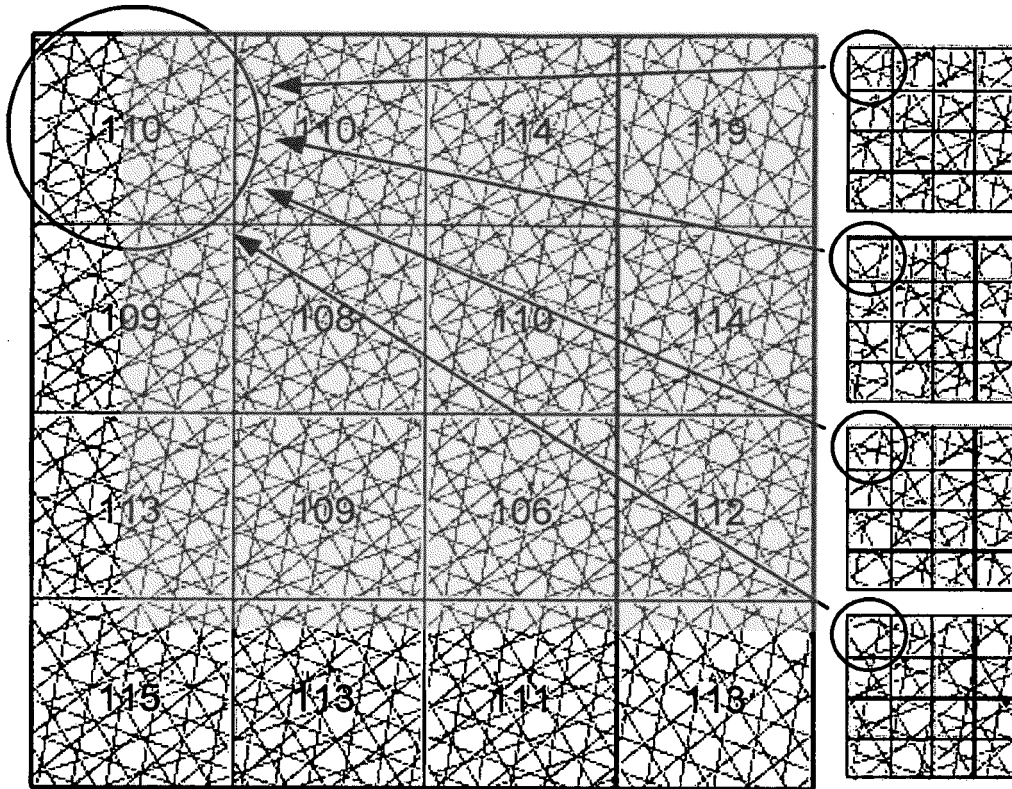

Fig. 9A

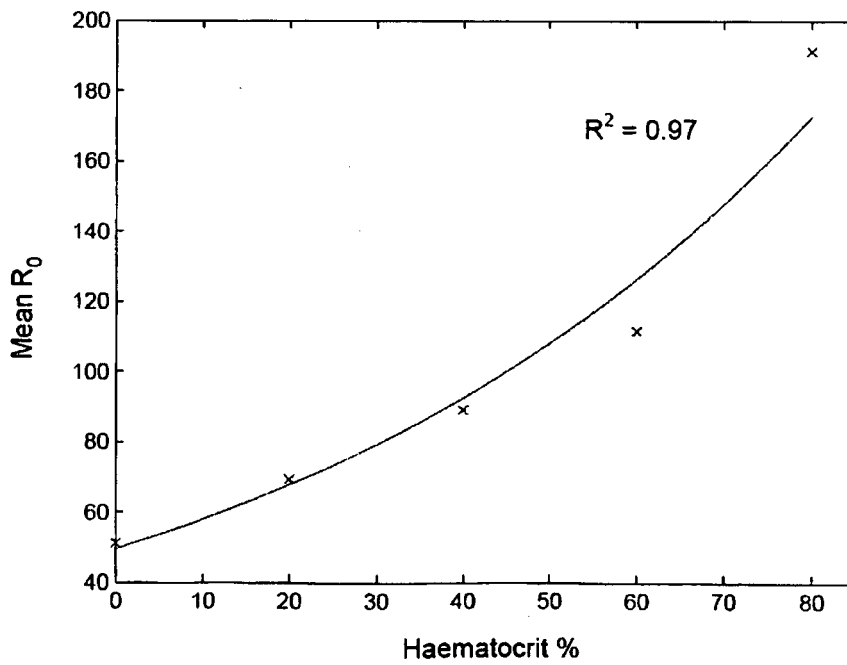

Fig. 9B

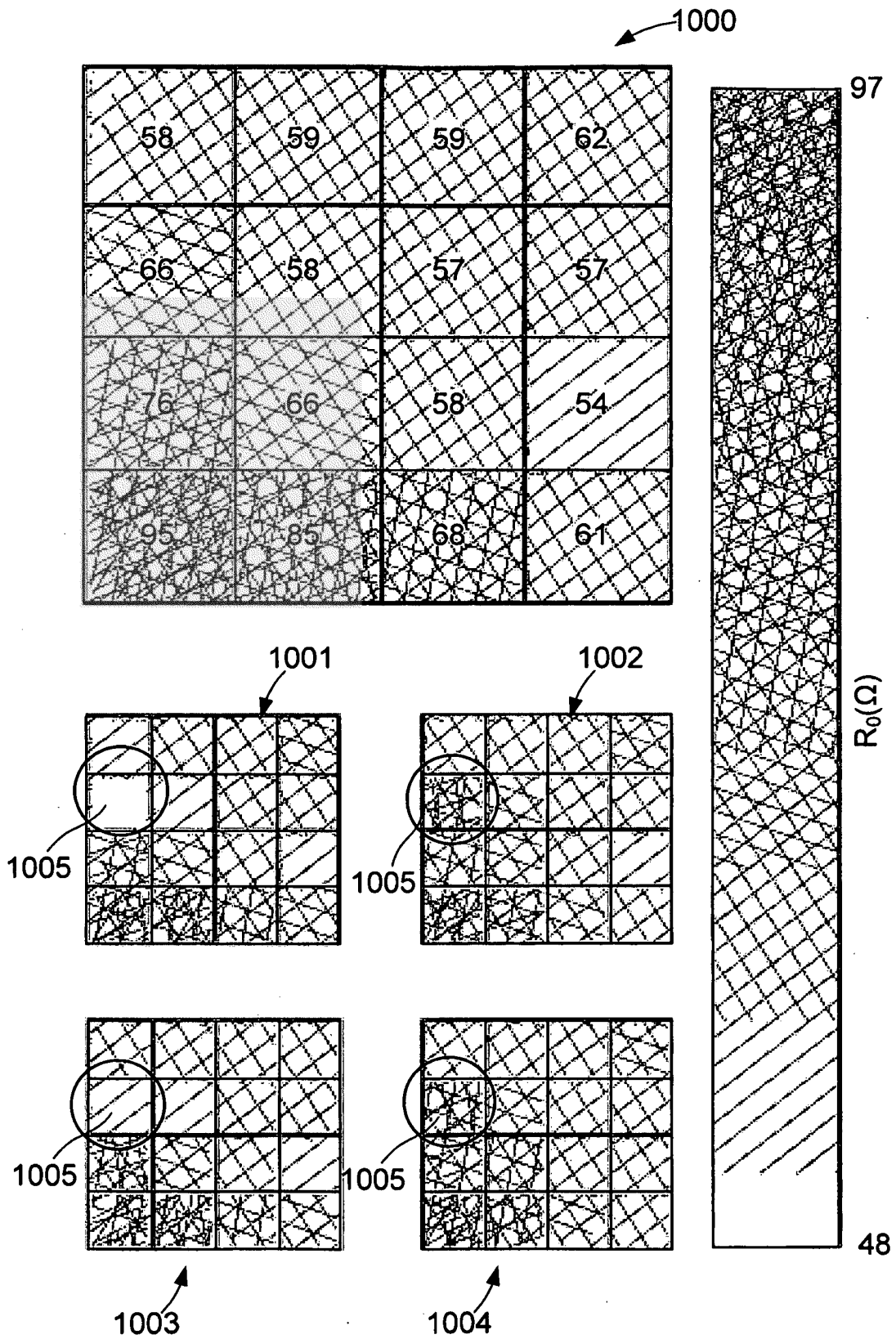

Fig. 10

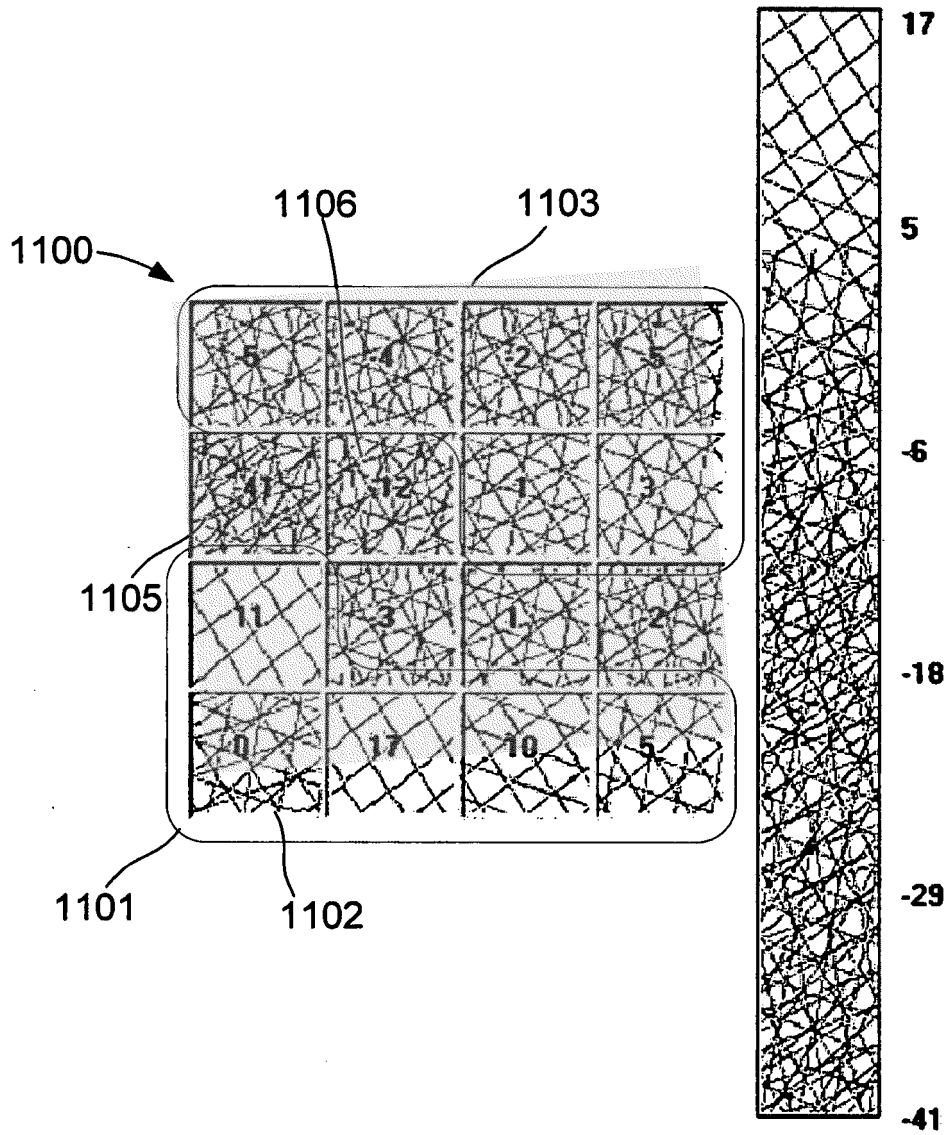

Fig. 11

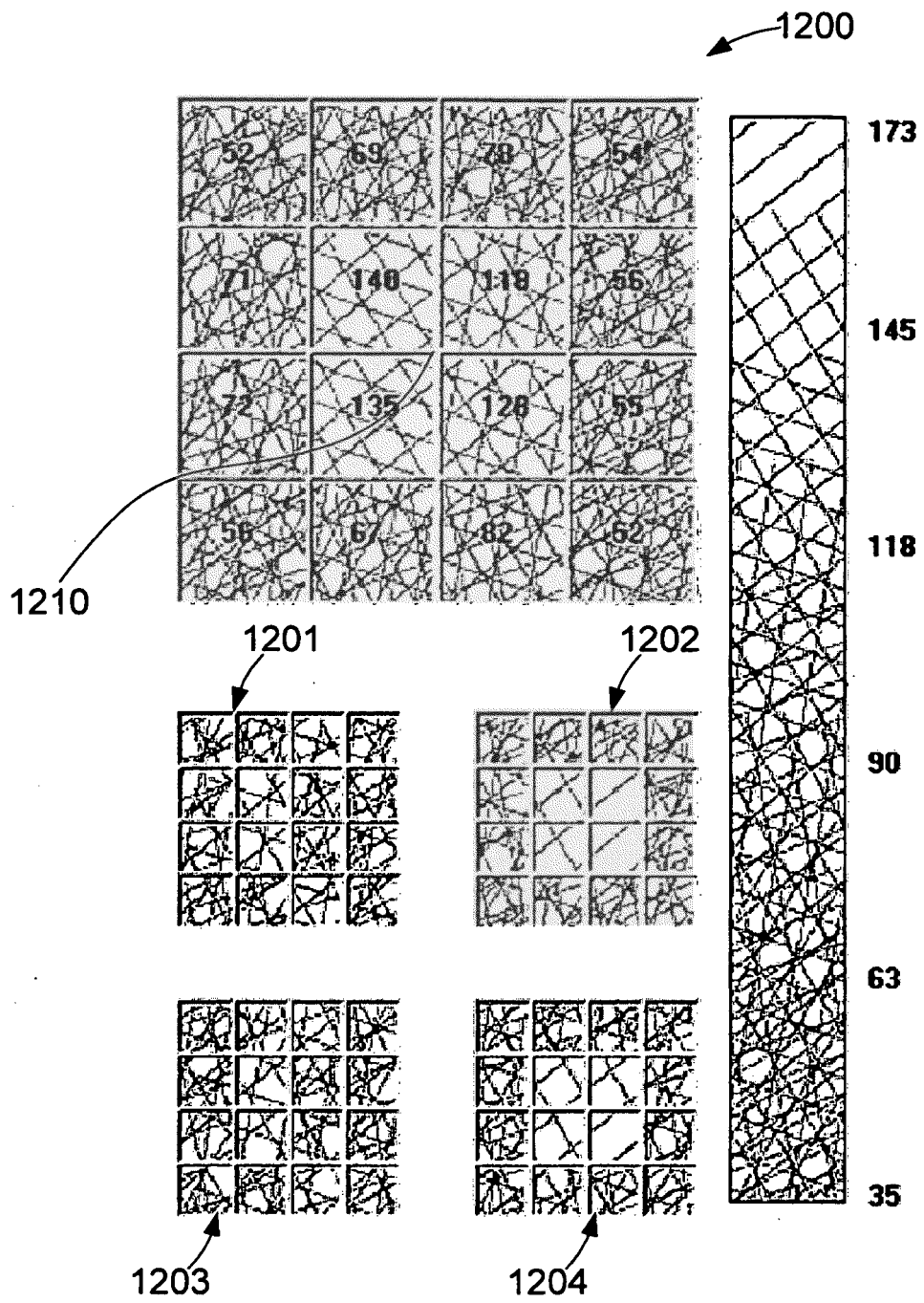

Fig. 12A

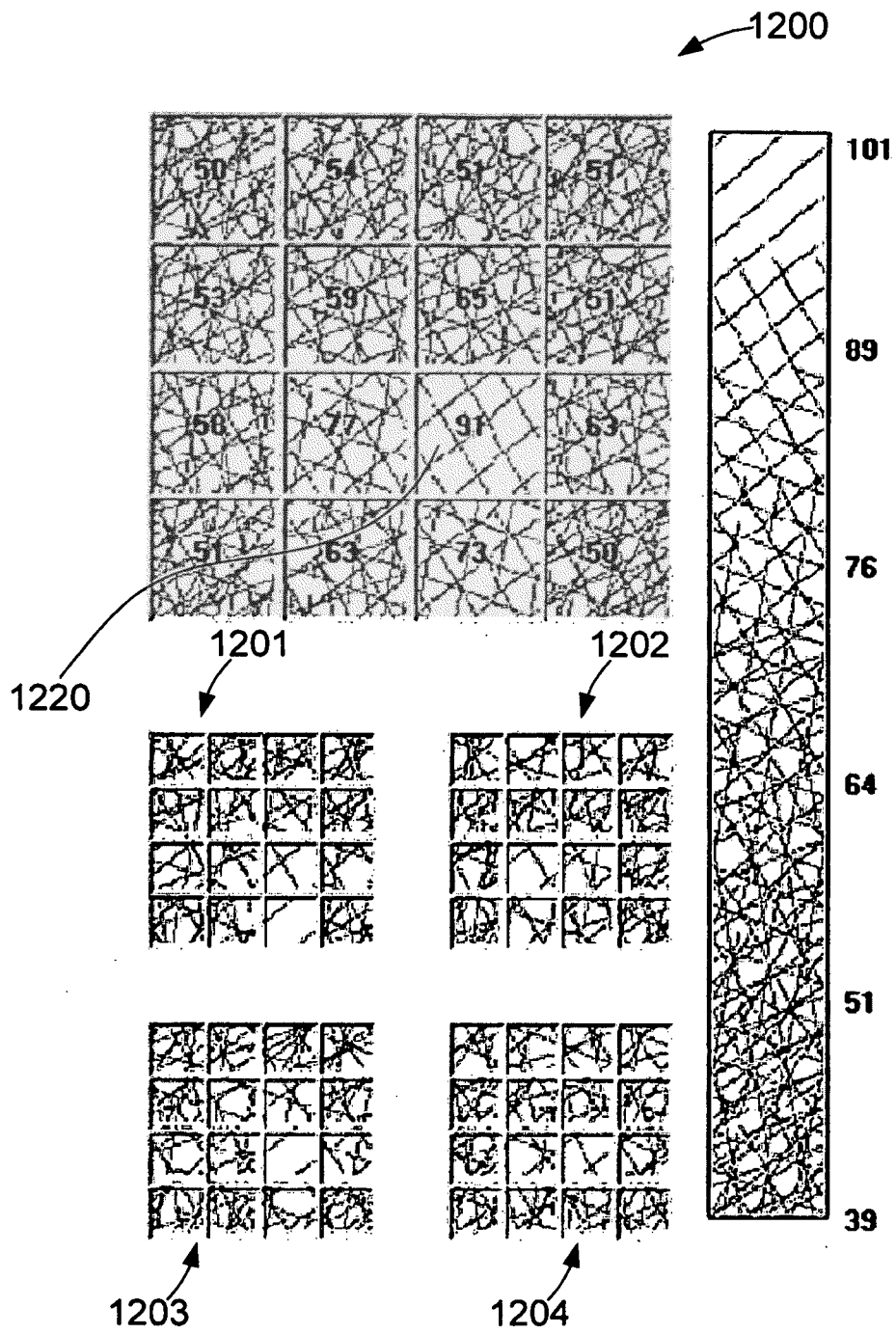

Fig. 12B

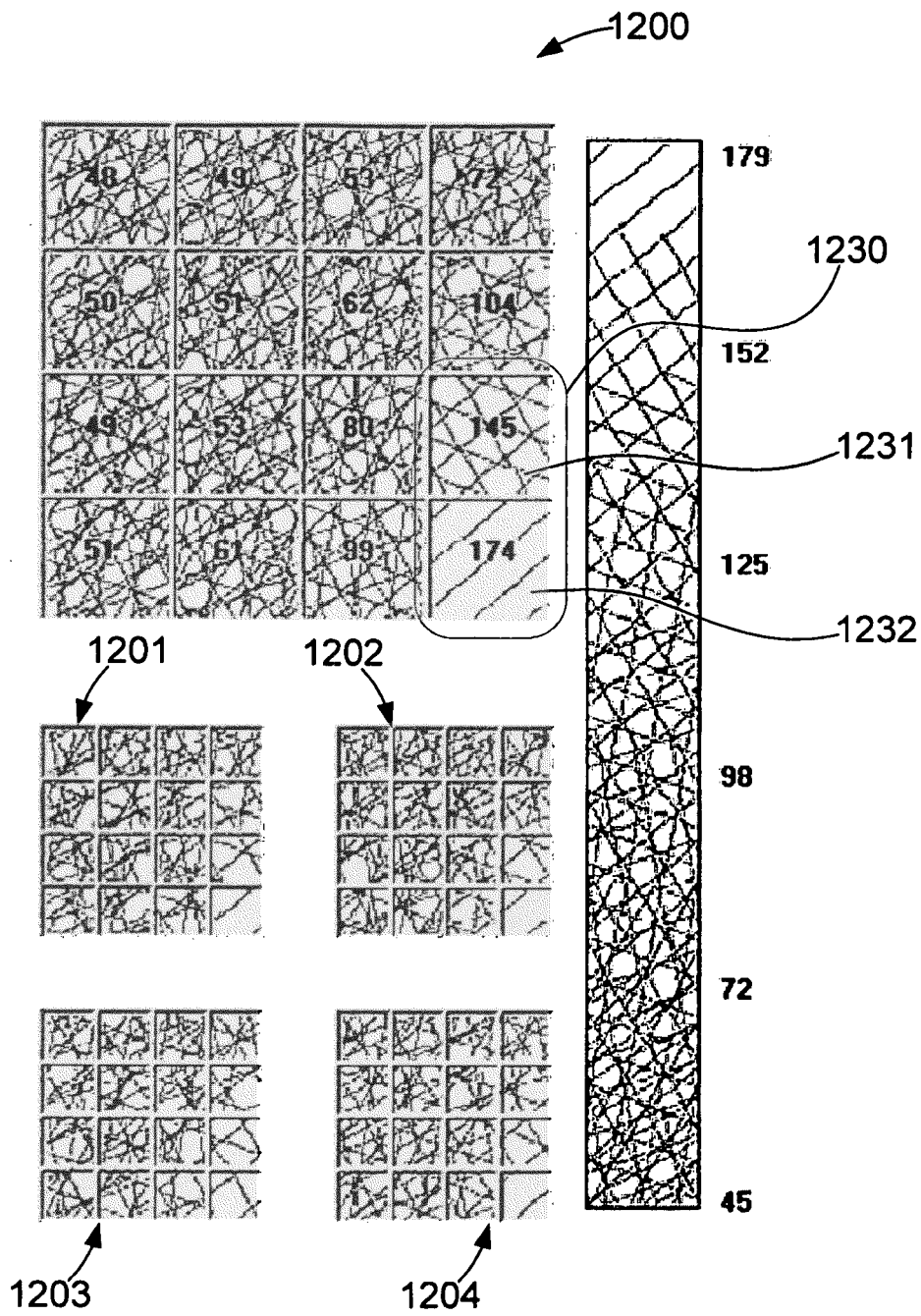

Fig. 12C

REFERENCES CITED IN THE DESCRIPTION

This list of references cited by the applicant is for the reader's convenience only. It does not form part of the European patent document. Even though great care has been taken in compiling the references, errors or omissions cannot be excluded and the EPO disclaims all liability in this regard.

Patent documents cited in the description

- WO 2004098389 A [0004]
- WO 2004049936 A [0004]

Non-patent literature cited in the description

- **BROWN, B. H. ; TIDY, J. A. ; BOSTON, K. ; BLACKETT, A. D. ; SMALLWOOD, R. H. ; SHARP, F.** Relation between tissue structure and imposed electrical current flow in cervical neoplasia. *The Lancet*, 2000, vol. 355, 892-895 [0068]

专利名称(译)	阻抗测量过程		
公开(公告)号	EP2175776A4	公开(公告)日	2013-05-29
申请号	EP2008782894	申请日	2008-08-07
申请(专利权)人(译)	IMPEDIMED有限公司		
当前申请(专利权)人(译)	IMPEDIMED有限公司		
[标]发明人	CORNISH BRUCE HERBERT THOMAS BRIAN JOHN SMITH JYE GEOFFREY		
发明人	CORNISH, BRUCE HERBERT THOMAS, BRIAN JOHN SMITH, JYE GEOFFREY		
IPC分类号	A61B5/053 A61B5/00		
CPC分类号	A61B5/053 A61B5/0537 A61B5/4331 A61B5/444 A61B5/7203 A61B5/7282 A61B2562/0214 A61B2562/046		
优先权	2007904287 2007-08-09 AU		
其他公开文献	EP2175776A1 EP2175776B1		
外部链接	Espacenet		

摘要(译)

一种用于对受试者进行阻抗测量的方法。该方法包括，在处理系统中，确定使用第一电极配置在现场测量的至少一个第一阻抗值，确定使用第二电极配置在现场测量的至少一个第二阻抗值，并确定存在，使用第一和第二阻抗值的不存在或异常程度。