

(19)



(11)

**EP 2 866 162 B1**

(12)

**EUROPEAN PATENT SPECIFICATION**

(45) Date of publication and mention of the grant of the patent:  
**05.12.2018 Bulletin 2018/49**

(51) Int Cl.:  
**G06F 19/00** <sup>(2018.01)</sup>      **A61B 5/00** <sup>(2006.01)</sup>  
**H04N 7/18** <sup>(2006.01)</sup>      **H04L 29/06** <sup>(2006.01)</sup>

(21) Application number: **14188189.6**

(22) Date of filing: **08.10.2014**

(54) **Multi-source medical display**

Medizinische Anzeige mit mehreren Quellen  
Affichage médical multisources

(84) Designated Contracting States:  
**AL AT BE BG CH CY CZ DE DK EE ES FI FR GB GR HR HU IE IS IT LI LT LU LV MC MK MT NL NO PL PT RO RS SE SI SK SM TR**

- **Prescher, Thomas**  
**EI Segundo, CA 90245 (US)**
- **Barnhill, Kim**  
**EI Segundo, CA 90245 (US)**

(30) Priority: **08.10.2013 US 201314048913**

(74) Representative: **Witte, Weller & Partner**  
**Patentanwälte mbB**  
**Postfach 10 54 62**  
**70047 Stuttgart (DE)**

(43) Date of publication of application:  
**29.04.2015 Bulletin 2015/18**

(73) Proprietor: **Karl Storz Imaging, Inc.**  
**Goleta, CA 93117 (US)**

(56) References cited:  
**EP-A1- 2 486 847**      **WO-A1-2010/088515**  
**US-A1- 2003 069 975**

(72) Inventors:  
• **King, Timothy**  
**Goleta, CA 93117 (US)**

**EP 2 866 162 B1**

Note: Within nine months of the publication of the mention of the grant of the European patent in the European Patent Bulletin, any person may give notice to the European Patent Office of opposition to that patent, in accordance with the Implementing Regulations. Notice of opposition shall not be deemed to have been filed until the opposition fee has been paid. (Art. 99(1) European Patent Convention).

**Description**

## FIELD OF THE INVENTION

**[0001]** The present invention relates to a system for displaying medical images. Specifically, the present invention relates to a system for generating an overlay aid on medical images.

## BACKGROUND OF THE INVENTION

**[0002]** In modern medicine, treatments are being carried out more and more using technical imaging methods. By way of example, miniaturized cameras are inserted into the body of a patient, and the image taken by the camera is displayed to the physician on a monitor installed in his/her working area. In this way, the physician can, for example, examine an internal organ or a joint for diagnostic purposes and he/she can also carry out surgical operations in a minimally invasive fashion. By arranging a monitor in the working area of the physician, i.e. in the sterile area, the physician may track all the operations that he or she undertakes on the patient live on the monitor, the corresponding monitor image being picked up by the medical imaging system. Accordingly, during various types of minimally invasive surgeries, such as, endoscopic, arthroscopic and laparoscopic procedures, a surgeon is able to visibly examine the interior of an organ, joint or other anatomical structure while the surgeon is conducting the surgery.

**[0003]** Recent developments have resulted in systems incorporating various audiovisual devices to allow others in the surgical suite or located remotely therefrom who may be assisting or observing, to better monitor the surgical procedure. Accordingly, both still images and live video being acquired during the surgery, can be output to various different monitors or recording devices both within, and outside of the surgical suite. Additionally, various devices have been incorporated into these systems to allow the surgeon, or other individuals assisting or observing, to utilize the imaging capabilities of the system in different ways, simultaneously or at different times, for a variety of different objectives.

**[0004]** Moreover, when there are multiple persons assisting in or observing a surgery, it is often necessary to call attention to or identify certain areas of interest within the patient's body shown on a live surgical monitor. For example, an instructor may wish to call attention to certain internal organs or structures, pathologies or procedures to students while observing a surgery. In addition, a supervising surgeon may direct the main practitioner to add more sutures in an area of interest.

**[0005]** In order to further improve communication during these surgical procedures, it is desired to have a method or device for calling attention to or identifying certain areas of interest displayed on the live surgical monitor. This would facilitate efficient and clear communication regarding a particular area of interest and dimin-

ish confusion, misunderstandings and misinterpretations.

**[0006]** Certain methods and devices have been tried to identify regions of interest on a live surgical monitor, including, use of a laser pointer or cursor or "circling" or annotating on a touch screen by the surgeon or assistants, or others assisting in or observing the surgery. These known methods have many disadvantages. First, the surgeon cannot operate a laser pointer or make indications on a touch screen while also safely performing the surgical procedure. Second, these known methods, including the use of a cursor, require the use of an additional hand, which the surgeon often cannot spare.

**[0007]** EP 2 486 847 A1 discloses a system for identifying an area of interest on a surgical image, including a source of surgical image data, which may be a camera, an image processing unit, which may be a camera control unit, and a destination, which may be a display. The image processing unit is configured to receive the surgical image data and combine it with an overlay pattern for identifying an area of interest, which is then displayed on the display. The overlay may include a key with coordinates or labels. Properties of the overlay and the key may be customized and adjusted.

## SUMMARY OF THE INVENTION

**[0008]** Against this background, it is an object of the present invention to provide a system for indicating regions of interest on images displayed on a monitor, as defined in appended claims 1 - 13.

**[0009]** It is another object of the invention to provide such a system in a simple and cost effective way.

**[0010]** It is another object of the invention that the image properties of the system for indicating regions of interest be configurable and adjustable.

**[0011]** It is yet another object of the invention to enable a physician to configure and adjust the properties of the image in and around an identified region of interest.

**[0012]** In accordance with one aspect of the invention, a configurable overlay pattern for indicating regions of interest on a medical or surgical image is provided. The areas of interest defined by the overlay pattern may be labelled with coordinates, such as numbers and/or letters, for ease of reference. If, for example, the overlay pattern is a grid, the rows and columns of the grid may be labelled with Cartesian coordinates. In accordance with another aspect of the invention, the properties of the image in and/or around an identified region of interest may be adjusted. The overlay pattern may be applied to displayed images recalled from an image archive. The applied overlay pattern may also be maintained on captured images that are subsequently saved to an archive.

**[0013]** The novel system has the advantage that the image including the overlay pattern is directly available for further processing outside the sterile area. This further processing can include, for example, displaying on a remote training monitor and/or archiving in an electronic

patient card file. The novel system therefore offers an extended field of application.

**[0014]** In accordance with another aspect of the invention, a system for indicating an area of interest on a surgical image, comprising a camera for generating surgical image data; a camera control unit receiving processing said surgical image data from said camera; software executing on said camera control unit for applying an overlay pattern to said surgical image data; and a display controlled by said camera control unit for displaying said surgical image data and said overlay pattern, is provided. The system may also include a storage device for saving the surgical image data and the overlay pattern. The surgical image data may be video data, still frame data or combinations thereof. The overlay pattern itself may comprise a grid, crosshairs, quadrants, one or more hash marks, a circle or an oval and the pattern may be applied centered on the image as displayed or at the edges. A key for indicating one or more regions of the overlay pattern may also be provided. At least one property of the overlay pattern may also be adjustable, including brightness, contrast, opacity, resolution and color. The properties of the overlay may be adjusted via one or more buttons located on said camera, via a touch screen or via voice recognition software executing on the camera control unit.

**[0015]** In accordance with a further aspect of the invention, a system for indicating an area of interest on an image, comprising a source of image data; an image processing unit in communication with said source, the image processing unit being configured to receive the image data and combine it with an overlay pattern for indicating an area of interest; and a destination (e.g., a monitor) in communication with said image processing unit for receiving said image data combined with said overlay pattern, is provided. The system may also include a plurality of overlay patterns and a user interface for receiving the plurality of overlay patterns and selecting at least one overlay pattern from the plurality of overlay patterns. The system may further include software executing on said image processing unit for combining the image data with the selected overlay pattern. The source of image data, which may be video data, still frame data and combinations thereof, may be a camera, a storage medium, or a camera control unit. The destination may be a display, which may be configured to simultaneously display image data from more than one source in combination with an overlay pattern, or a storage medium.

**[0016]** The source of image data, the image processing unit for receiving the image data and combining it with an overlay pattern, and the monitor for displaying the overlaid image data of the above system may be located at different places, remotely from each other. For instance, a source of image data may be generated by a surgeon in an operating room; the image data may be processed and combined with an overlay pattern outside the operating room (for example in a pathology laboratory); and then the overlaid image data may be output

to various different monitors both within, and outside of the operation room for being observed by the surgeon and/or other individuals assisting or observing, simultaneously or at different times, for a variety of different objectives.

**[0017]** In addition to the above mentioned overlay patterns, the overlay patterns for the display may comprise centric lines, concentric shapes, or a combination thereof. Preferably, the concentric shapes are concentric ovals, concentric circles, and concentric polygons. In some embodiments, the diameters of the concentric circles are at 25% and 50% of the height of said display. In other embodiments, the centric lines originate from a single point and are shown for every 15 degrees, 20 degrees, 30 degrees, 45 degrees, 60 degrees, or 90 degrees.

**[0018]** The system in accordance with the present invention may comprise multiple sources of image data, which include, but are not limited to, sources of ultrasound, X-ray, Magnetic resonance imaging (MRI), nuclear magnetic resonance imaging (NMRI), magnetic resonance tomography (MRT), computed tomography (CT), and surgical image data. The sources of image data may come from an archived image file. The image data may be video data, still frame data or combinations thereof, which can be streaming in from a hospital system.

**[0019]** It goes without saying that the features mentioned above and those yet to be explained below can be used not only in the combination respectively specified, but also in other combinations or on their own without departing from the scope of the present invention.

## BRIEF DESCRIPTION OF THE DRAWINGS

### **[0020]**

FIG. 1 is a schematic illustration of one embodiment of a system for indicating an area of interest on an image.

FIG. 1a is a schematic illustration of one embodiment of a system for indicating an area of interest on an image, which includes a plurality of designs for an overlay pattern available in an image process unit.

FIG. 1b is a schematic illustration of one embodiment of a system for indicating an area of interest on an image, which includes multiple image data sources for display.

FIG. 2 is a view of an embodiment of an input for use with the system for indicating an area of interest on an image as shown in FIG. 1, 1a, or 1b.

FIG. 3 is a view of an overlay pattern in the form of a grid with a key, both at 100% opacity, combined with image data, for use with the system for indicating an area of interest on an image as shown in FIG. 1,

1a, or 1b.

FIG. 4 is a view of an overlay pattern in the form of a grid with a key, both at 50% opacity, combined with image data, for use with the system for indicating an area of interest on an image as shown in FIG. 1, 1a, or 1b.

FIG. 5 is a view of an overlay pattern combined in the form of a grid at 50% opacity and a key at 100% opacity, combined with image data, for use with the system for indicating an area of interest on an image as shown in FIG. 1, 1a, or 1b.

FIG. 6 is a view of an overlay pattern in the form of a grid with a key, both at 100% opacity, combined with image data, for use with the system for indicating an area of interest on an image as shown in FIG. 1, 1a, or 1b.

FIG. 7 is a view of an overlay pattern in the form of a centered crosshairs, combined with image data, for use with the system for indicating an area of interest on an image as shown in FIG. 1, 1a, or 1b.

FIG. 8 is a view of an overlay pattern for use with the system for indicating an area of interest on an image as shown in FIG. 1, 1a, or 1b.

FIG. 9 is a view of an overlay pattern for use with the system for indicating an area of interest on an image as shown in FIG. 1, 1a, or 1b.

FIG. 10 is a view of an overlay pattern for use with the system for indicating an area of interest on an image as shown in FIG. 1, 1a, or 1b.

FIG. 11 is a view of an overlay pattern for use with the system for indicating an area of interest on an image as shown in FIG. 1, 1a, or 1b.

FIG. 12 is a view of an overlay pattern for use with the system for indicating an area of interest on an image as shown in FIG. 1, 1a, or 1b.

FIG. 13 is a view of an overlay pattern for use with the system for indicating an area of interest on an image as shown in FIG. 1, 1a, or 1b.

FIG. 14 is a view of an overlay pattern for use with the system for indicating an area of interest on an image as shown in FIG. 1, 1a, or 1b.

FIG. 15 is a view of an overlay pattern for use with the system for indicating an area of interest on an image as shown in FIG. 1, 1a, or 1b.

FIG. 16 is a view of an overlay pattern for use with

the system for indicating an area of interest on an image as shown in FIG. 1, 1a, or 1b.

FIG. 17 is a view of an overlay pattern for use with the system for indicating an area of interest on an image as shown in FIG. 1, 1a, or 1b.

FIG. 18 is a view of an overlay pattern for use with the system for indicating an area of interest on an image as shown in FIG. 1, 1a, or 1b.

FIG. 19 is a view of an overlay pattern for use with the system for indicating an area of interest on an image as shown in FIG. 1, 1a, or 1b.

FIG. 20 is a view of an overlay pattern for use with the system for indicating an area of interest on an image as shown in FIG. 1, 1a, or 1b.

FIG. 21 is a view of an overlay pattern for use with the system for indicating an area of interest on an image as shown in FIG. 1, 1a, or 1b.

FIG. 22 is a view of an overlay pattern for use with the system for indicating an area of interest on an image as shown in FIG. 1, 1a, or 1b.

FIG. 23 is a view of an overlay pattern for use with the system for indicating an area of interest on an image as shown in FIG. 1, 1a, or 1b.

FIG. 24 is a view of an overlay pattern for use with the system for indicating an area of interest on an image as shown in FIG. 1, 1a, or 1b.

FIG. 25 is a view of an overlay pattern for use with the system for indicating an area of interest on an image as shown in FIG. 1, 1a, or 1b.

#### 40 DETAILED DESCRIPTION OF THE INVENTION

**[0021]** The present invention provides a system 10 for indicating certain areas of interest in medical or surgical image data by applying an overlay pattern, such as a Cartesian grid, crosshairs, quadrants, etc., on the image. The overlay pattern allows a doctor to then refer or call attention to areas of interest in the image data by referencing the overlay pattern or a portion thereof. As will be discussed in detail below, the overlay may also include an key, which may include alphanumeric labels or coordinates, which may assist the doctor in indicating the area or portion of the overlay to which he/she is referring.

**[0022]** Referring to FIG. 1, the system 10 includes at least one source 12 of image data in communication with at least one processing unit 14 and at least one destination 16 for the image data. The at least one source 12 of image data connected to the processing unit 14 may include any device, system, or network that generates, ac-

quires, stores, monitors, modifies, or controls image data for use in generating medical images, such as still frame images or video. For example, the at least one source 12 may include an image acquisition device, such as endoscopic cameras, video endoscopes, room cameras, light cameras, and boom cameras. Likewise, the at least one source 12 may include any recording, storage, and/or archival device or system, such as traditional video cassette recorders or digital video recording devices (such as a linear tape deck, DVD (Digital Versatile Disc), or DVR (digital video recorder), image capture devices, a PACS (Picture Archiving and Communication System) computer, or an HIS (Hospital Information System). Finally, the at least one source 12 may include any other device from which image data may be received, such as a patient monitor or a central computer for controlling various devices, or may simply be auxiliary inputs for connecting external devices that may supply image data to the system.

**[0023]** Additionally, a source 12 may be a source of medical or surgical image data that receives the image data from yet another source. For example, a source may be a linear tape deck that is recording live video as it supplies the video to the computer. The linear tape deck, in turn, may receive the live video from an endoscopic camera presently being used on a patient, as is further described below. As another example, a source 12 may be a processor for routing images from multiple other sources to the processing unit (i.e., a screen splitter), such as a quad image processor. The source 12 connected to the processing unit may also be a CCU (camera control unit).

**[0024]** The at least one processing unit 14 may include any device, system, or network that can process images generated from image data. For example, the processing unit 14 may be a general processor, a computer, or a CCU, which may be integrated in a camera or may be a modular CCU external to the camera.

**[0025]** The at least one destination 16 for the image data supplied by the at least one source 12 may include any device, system, or network that displays images generated from the image data, or otherwise communicates the image data to viewers, or stores the image data. For example, the at least one destination may include any of various displays, such as, for example, a flat panel display, a plasma screen, or a computer monitor. Additionally, the at least one destination may include a recording device or a storage medium.

**[0026]** Further, the at least one destination 16 for the surgical image data may be located within the operating room, or it may be at a location remote from the operating room. One object of the invention is to assist all those viewing or analyzing surgical image data to identify areas of interest in the surgical image data. For example, an overlay pattern applied to surgical image data may be used by a surgeon performing the surgery to communicate with an assisting surgeon that is not present in the operating room, but who is able to view the surgical image

data with the overlay pattern on a destination 16, such as a monitor, at some other remote location. Further, the overlay pattern may be applied to surgical image data displayed on a monitor located in a lecture hall or classroom for teaching purposes.

**[0027]** Moreover, the destination 16 may be capable of displaying image data from more than one source. For example, the destination 16 may be a monitor with picture-in-picture (PIP) capabilities. In this embodiment, the user may choose to apply (or presets may set) an overlay pattern to all or some sets of image data displayed on the monitor. Similarly, if there are several destinations 16 for image data from several sources 12, then user may choose to apply (or presets may set) an overlay pattern to all or some sets of image data sent to the destinations 16.

**[0028]** As illustrated in FIG 1, the system 10 may also include at least one input 18 in communication with the at least one source 12 and/or the processing unit 14. The at least one input 18 may include any interface whereby a user to enable/disable and/or adjust the properties of the overlay pattern. In one embodiment, the input 18 may be a button or menu located on the source 12, such as an endoscopic camera, itself. Alternatively, the input 18 may be a user interface that may include physical buttons for a doctor to press, or may also include a touch-screen monitor.

**[0029]** In another embodiment, shown in FIG. 2, the input 18 may include one or more icons on a touch screen 20. In this embodiment, the system 10 may include software executing on the processing unit 14 that causes the touch screen 20 to simultaneously display several icons. The icons are sensitive to the touch of the user and will cause a command to be sent to the processing unit 14. By pressing certain source icons 22 or destination icons 24, the user can select a particular source and destination by pressing the touch screen 20 at the locations of the icon. The user can also manipulate or alter the images being displayed in the display window 26 on the touch screen in order to affect the images ultimately being communicated to the destinations. For example, the touch screen 20 may also include at least one icon 28 which allows the user to enable/disable the overlay pattern, adjust the properties of the overlay pattern, and select which image data to which the overlay pattern will be applied and to which destination 16 the combined image will be transmitted.

**[0030]** In some embodiments, the system 10 may also be configured to accept voice commands, allowing the user to vocally enable or disable the overlay pattern and adjust properties of the overlay pattern itself without having to touch the imaging device or user interface. In this embodiment, the at least one input 18 may include voice recognition software executing on said processing unit 14 for accepting voice commands, allowing the doctor to vocally enable or disable the overlay and adjust properties of the overlay itself without having to physically touch the source 12, processing unit 14 or input 18 themselves.

**[0031]** In some further embodiments, the input 18 may include accelerometer data (not shown) from the camera head or image motion vector detection. The overlay pattern may be automatically enabled or disabled or the properties of the overlay pattern may be adjusted in response to the input of this data.

**[0032]** The input 18 may also include preset data saved by the user that will act on the processing unit 14 to enable/disable the overlay pattern at certain times as preset by the user. The preset data may also include the preferred type of overlay pattern and/or the properties of the overlay pattern the user desires to be sent to the destination 16.

**[0033]** As shown in FIGS. 3 and 7-21, the overlay pattern 30 may be provided in any number of designs, which may be set by the user. For example, as shown in FIGS. 3-6, the overlay pattern 30 may be a grid. In addition, as shown in FIG. 7, the overlay pattern 30 may include a single crosshairs placed at the center of the image as displayed. In other embodiments, the overlay pattern may be one or more hash marks or crosshairs overlaid across a portion of the image, the entire image, or at the edges of the image. The overlay may also be separated into quadrants, with any number of circles, ovals hash marks or any combination thereof within the quadrants. The overlay may also be one or more circles, ovals or other shapes.

**[0034]** The desired overlay pattern 30 may be chosen by the user through an input 18, some examples of which are described above. For example, the source 12, such as an endoscopic camera, may include buttons for selecting and setting a desired overlay pattern 30. The user may also chose to apply the overlay pattern 30 to one, some, or all of the sources 12 of image data 34. Once the overlay pattern 30 is selected, the image data 34 from the one or more selected sources 12 may be combined with the overlay pattern 30 in the processing unit 14 and the combined image transmitted to the one or more selected destinations 18.

**[0035]** In one embodiment, the overlay pattern may be applied to live images, in real time. For example, as shown in FIG. 3, the combined image data 34 and overlay pattern 30 may be transmitted to a display 32. The display may be located in the operating room and/or it may be located somewhere remote from the operating room for viewing by other surgeons assisting in the surgery or by students observing the surgery for educational purposes.

**[0036]** Further, the overlay pattern 30 may be applied to image data 34 that has been recalled from an image archive, such as on a storage medium. The applied overlay pattern 30 may also be maintained on captured image data 34 that is subsequently saved to an archive and may be recalled later for viewing on a display.

**[0037]** The overlay pattern 30 may be applied to the image data at a "fixed" position, meaning that the overlay 30 will be applied at a fixed position with respect to the displayed image, i.e., centered on the image. However, the user may adjust the image data 34 separately with

respect to the overlay pattern 30. In operation, the user views the image data with the overlay pattern 30 on a display 32 and adjusts the image captured by the source 12 (i.e., a camera) until the particular area of interest is located at or near an identifiable region of the overlay pattern 30. Using the embodiment shown in FIG. 7, the doctor will adjust the field of view of the camera until the area of interest is centered at the crosshairs. This enables the doctor to unequivocally "point" to the area of interest, simply by adjusting the camera.

**[0038]** The overlay pattern may also include a key 36 for assisting the user in indicating and discussing areas or portions of the overlay pattern 30, and, in turn, indicating and discussing an area of interest on the underlying image data 34. In one example, the key 36 may include alphanumeric labels or coordinates. For example, as shown in FIG. 3 the rows and columns of a grid overlay may be labeled with letters and numbers-the vertical axis labeled with letters and the horizontal axis labeled with numbers (or vice versa) allowing reference to an area of the image with a simple letter-number combination (e.g. "C3" or "D2", etc.). In another embodiment, if the overlay pattern 30 comprises hash-marks as shown in FIG. 11, the hash marks may be labeled with coordinates. As shown in FIGS. 16 and 18, the quadrants or other defining shapes may be individually labeled with an alphanumeric key 36.

**[0039]** Certain properties of the overlay 30 and key 36 may be adjustable, including, but not limited to, the resolution (i.e., number of rows by number of columns, number of circles, etc.) of the overlay, the opacity of the overlay pattern 30 and/or key 36, the distribution of the opacity of the overlay pattern 30 and/or key 36, the color of the overlay 30 and/or key 36, the brightness of the overlay 30 and/or key 36, the thickness of the lines of the overlay pattern 30, the size of the font of the key 36, etc. The user may choose to enable the overlay pattern and set its properties prior to the start of the medical or surgical procedure, or the overlay may be enabled/disabled and the properties may be adjusted at any time during the medical or surgical procedure.

**[0040]** In one example, the overlay pattern 30 and key 36 can be applied to the image in varying levels of opacity. The overlay may also include an indicator 38, which may display certain properties of the overlay 30 as set by the user. For example, FIG. 3 illustrates the overlay 30 as a grid and key 36 applied at 100% opacity. FIG. 4 illustrates the overlay 30 and the key 36 both applied at 50% opacity. The properties of the overlay 30 can be constant or can vary across the display 32. For example, the overlay pattern 30 can be more opaque at the edges of the display 32 and gradually become more transparent toward the center of the display 32.

**[0041]** In a further embodiment, the adjustable properties of the overlay pattern and coordinates may be adjusted independently of one another. For example, as shown in FIG. 5, the overlay may be set to 50% opacity whereas the key 36 may be maintained at 100% opacity.

**[0042]** Various properties of the camera control unit (CCU) may also be changed so as to effect a change in the image data 34 at and/or around certain coordinates or a region of the overlay 30 identified by the user. For example, the brightness, contrast, color, or zoom of the image data 34 may be adjusted at and/or around the coordinates or region identified. The coordinates or region of the overlay 30 may be identified via an input 18, for example by button press on the source 12 or by touching an icon or the display window 26 of a touch screen 20. The system 10 may also be configured to include voice recognition of certain regions or coordinates of the overlay pattern 30 to change the properties of the CCU.

**[0043]** Moreover, the zoom level of the image data 34 may be adjusted independent of the overlay pattern 30. The resolution of the overlay pattern 30 will remain the same, while the image data 34 is zoomed in or out. For example, FIG. 6 illustrates a zoomed-in version of the image data 34 of FIG. 3, where the resolution of the grid overlay pattern remains constant (4 rows by 6 columns).

**[0044]** The user may set or adjust the properties of the overlay pattern 30 and/or the key 36 at the beginning of, or during, a surgical or medical procedure. For example, the user may select a grid overlay, choose the number of columns and rows, and set the color all at prior to commencing a surgical or medical procedure. The user may also establish presets to which the overlay 30 will default. In one embodiment shown in FIGS. 1-7, the resolution of the grid overlay is four rows by six columns. However, other grid overlay resolutions are contemplated, such as 4x4. The overlay can be of a varying number or a fixed number of columns, rows, quadrants, etc.

**[0045]** Additionally, the overlay pattern and/or resolution may be preset or chosen by the doctor in accordance with the aspect ratio of the display monitors. For example, the doctor may chose a standard definition (SD) display having a 4x3 aspect ratio and the overlay pattern would be chosen or adjusted accordingly. The doctor may also chose a high definition (HD) display having a 16x9 aspect ratio and the overlay pattern would be chose or adjusted accordingly. Overlay patterns incorporating ovals, such as the pattern shown in FIG. 15, are well suited for HD displays whereas overlay patterns incorporating circles, such as the pattern shown in FIG. 14, are well suited for SD displays.

**[0046]** In a further embodiment, the system 10 may automatically enable the overlay if a motion vector detector senses a still image for a certain period of time. Conversely, the system 10 may automatically disable the overlay if a motion vector detector senses a moving image for a certain period of time. Further, the system 10 may automatically "time out" after the overlay has been enabled for a preset period of time, or "time-out" if the image has been still for a certain period of time.

**[0047]** When the overlay is enabled or disabled, either by automatic sensing, "time-out", or by direct input from the user, the overlay could be programmed to either immediately appear at 100% opacity or immediately disap-

pear. Alternatively, the overlay could be programmed to gradually appear or disappear by gradual increase or decrease in opacity. These properties will be discussed further below.

**[0048]** In addition to the overlay pattern recited before, the overlay pattern may include a set of centric lines originating from a single point, such as from the center of the monitor screen, and optionally ending near the edges of the monitor screen, as shown in FIGS. 22, 24 and 25. Preferably, the centric lines are shown for every 15 degrees, 20 degrees, 30 degrees, 45 degrees, 60 degrees, 90 degrees, or other predetermined degrees. When the centric lines are shown for every 30 degrees, the circular overlay pattern is "clock" like. When the centric lines are shown for every 45 degrees, the circular overlay pattern is "compass" like. When the centric lines are shown for every 90 degrees, the circular overlay pattern is a "quadrant" like.

**[0049]** The overlay pattern may include a series of concentric shapes. Preferably, the concentric shapes are concentric circles, concentric ovals, or concentric polygons. More preferably, the concentric shapes are concentric circles (also called centric circles), as shown in FIGS. 22, 23 and 25. In one embodiment, as shown in FIGS. 22 and 25, the overlay pattern contains three concentric circles, at 25%, 50% and 100% of the monitor height.

**[0050]** The overlay pattern may be formed by superimposing the centric lines on the concentric shapes, as shown in FIGS. 22, 24 and 25. In one embodiment, the overlay pattern is formed by a wind rose going from 0 degree to 360 degrees with centric lines at every 20 degree or 30 degrees and two concentric circles at 25% and 50% of the monitor height. Preferably, the single originating point of the centric lines is also the center of the concentric shapes.

**[0051]** As stated before, the overlay pattern may include an optional key 36 for assisting the user in indicating and discussing areas or portions of the overlay pattern 30, and, in turn, indicating and discussing an area of interest on the underlying image data 34.

**[0052]** For the "clock" like overlay pattern as shown in FIG. 22, the centric lines may be labeled as 1, 2, 3, ..., 12, corresponding to the conventional positions of 1 o'clock, 2 o'clock, 3 o'clock, ... 12 o'clock. For the "compass" like overlay pattern, as shown in FIG. 24, the centric lines can be marked as N, NE, E, SE, S, SW, W, and NW, corresponding to a conventional compass. The "quadrant" like overlay pattern, as shown in FIG. 25, may be labeled as x-axis and y-axis, which may in turn be labeled with numbers as conventional coordinates.

**[0053]** The concentric circles can be labeled with an alphanumeric key, or other suitable number and/or letter characters. If there are a total of three concentric circles, they can be referred as inner, medium, and outer circles, or small, middle, and large circles.

**[0054]** The overlay patterns formed by superimposing the centric lines on the concentric circles are particular

useful for indicating areas of interest in some circumstances. For instance, the small circle of FIG. 22 is suitable for showing a small circular image, such as an image of 4 mm scope or a magnified laparoscopic image. Thus the small circle of FIG. 22 can be used for indicating the precise targeting area of an image object, leaving the other area of the imaged object outside the small circle. To further highlight the image area within the small circle, the small circle of the concentric circles can be made transparent, while the area outside the small circle gradually becomes opaque.

**[0055]** The designs of concentric shapes, centric lines, concentric shapes superimposed on centric lines, and the previously described designs, such as grid, crosshair, quadrant, hash mark, can be used interchangeably for the overlay pattern 30. Collectively, they form a plurality of designs for the overlay pattern 30.

**[0056]** As illustrated in FIG. 1a, the system 10 in accordance with the present invention may include a source 12, an image processing unit 14, and a destination 16. The source 12 is typically connected with the processing unit 14 by wires or cables to transmit image data 34. However, the source 12 may also wirelessly transmit signals to the processing unit 14. The process unit 14 includes a plurality of designs for the overlay pattern 30 to suit different display needs, and software executing on the image processing unit for combining the image data 34 from the source 12 with an overlay pattern 30 and further adjusting the properties of the overlay pattern, such as activation, deactivation, resolution, opacity, opacity distribution, color, brightness, thickness, and size. The software can also be configured to select the desired overlay pattern 30 in response to a user input 18. The user input 18 can be provided by a manual command, a voice command, or preset by a user prior to a surgical or medical procedure. For enabling the user input 18 via a voice command, the software is configured with voice recognition features. The plurality of the overlay pattern designs can be numbered for easy identification and selection.

**[0057]** As described above, the zoom level of the image data 34 may be adjusted independent of the overlay pattern 30, and the software executing on the image processing unit may be configured to enable this feature. Unlike the prior art references that use the overlay as part of a reference for measurement, which usually require the overlay pattern 30 and the image data 34 be zoomed in or out at the same level simultaneously, the present invention uses the overlay pattern as an aid to allow a doctor or other observers to identify an area of interest, which often requires keeping the overlay pattern 30 constant while zooming in or out of the areas of interest. Since size measurement of an imaged object is not required, the apparatus of the present invention does not include other components usually associated with the size measurement. As a result, the apparatus of the present invention is simple and cost effectiveness for its intended purpose.

**[0058]** By selecting and superimposing the overlay pattern 30 with optional key 36 on an image, the present invention eliminates the need of using a laser pointer, cursor, "circling," or other annotating or marking means by a person to identify areas of interest, as required by the prior art. Thus the present invention provides an effective and clear communication regarding certain areas of interest displayed on the live monitor.

**[0059]** As illustrated in FIG. 1b, the system 10 may comprise multiple sources of image data 34, 34', 34". The types of image data may include, but are not limited to, ultrasound, X-ray, magnetic resonance imaging, nuclear magnetic resonance imaging, magnetic resonance tomography, computed tomography, and surgical image data. The image data 34, 34', 34" may be in the form of video data, still frame data or combinations thereof. The image data 34, 34', 34" may be retrieved from a non-imaging source, such as an image archive, PC, or other source of image data. The image data 34, 34', 34" may also be streamed from a medical instrument that generates the image data 34, 34', 34".

**[0060]** To accommodate different types of image data 34, 34', 34", data type converters 42, 42', 42" may be utilized to convert the image data 34, 34', 34" into a format that is readable by the image processing unit 14 before the image data 34, 34', 34" is transmitted to the image processing unit 14. The formatted data may be saved in a storage device. The system 10 may include one data type converter for all the data conversions, or multiple data type converters for multiple sources of image data. In some embodiments, each source of image data is provided with one data type converter, which is specifically adapted to convert the particular type of image data. Each of the data type converters 42, 42', 42" may be a standalone unit. Alternatively, it may be part of the medical device or camera that generates the image data 34, 34', 34" or part of the image processing unit 14. In some embodiments, the communications among the image data 34, 34', 34", the data type converters 42, 42', 42", and the image processing unit 14 are bi-directional. The communications are typically performed via wires or cables. However, the image data 34, 34', 34" and the formatted image data may also be wirelessly transmitted.

**[0061]** An input multiplexer/combiner 44 may be used to facilitate input to the processing unit 14 from multiple imaging sources. In principle, any practical number of input sources of any configuration or having any capabilities may be input in this way. Alternatively, the processing unit 14 may accept input from only one image source or otherwise omit the multiplexer 44 without departing from the invention. In some embodiments, the multiplexer 44 may include a data type converter 42, 42', 42" for converting or formatting the data type of incoming image data, thereby eliminating the need to have other data type convertors in the system. The multiplexer 44 may be part of the image processing unit 14 as shown in Fig. 1b. Alternatively, it can be a standalone unit outside the image processing unit 14.

**[0062]** The process unit 14 includes a plurality of adjustable overlay patterns 30 to suit different display needs, and software (not shown) executing on the image processing unit for selecting the desired overlay pattern(s) in response to a user input and for combining the image data selected through the multiplexer/combiner 44 with the desired overlay pattern(s) to generate overlaid image data 50.

**[0063]** For enabling the user input, overlay pattern options 46 may be transmitted to a user interface 40 for a user to select at least one overlay pattern from the plurality of adjustable overlay patterns 30. The user may provide input by a manual command, a voice command, or preset by a user prior to a surgical or medical procedure. For enabling user input via a voice command, the software may be configured with voice recognition features. The plurality of the overlay pattern designs may be numbered for easy identification and selection. After that, the data containing the overlay pattern selection 48 by the user may be transmitted to the processing unit 14. The communications between the processing unit 14 and the user interface 40 may be conducted through wires/cables or wireless.

**[0064]** During the combining process of the image data and the overlay pattern, the image may be oriented so that an area of interest on the image is located near or at an identifiable region of the overlay pattern. In this way, a user may identify the area of interest on the image without having to use a laser pointer or cursor, or otherwise "circle" or annotate on the image. It would be apparent to those skilled in the art as to an identifiable region of each overlay pattern. For instance, for an overlay pattern of concentric circles, the identifiable region may be the smallest circle; for an overlay pattern of quadrants, the identifiable region may be the upper left quadrant; and for an overlay pattern of crosshairs, the identifiable region may be one of the crosshairs. Because the overlay patterns have distinctive shapes, alphanumeric labels and coordinates, the regions of the overlay patterns may be verbally identified by making reference to the shapes, alphanumeric labels, coordinates, etc. The software may also be configured to be able to adjust the properties of the overlay pattern and of the images independently. For instance, the image may be zoomed in while the overlay pattern is kept constant in order to create an enlarged, detailed view of the area of interest on the image.

**[0065]** The overlaid image data 50 may be transmitted to destination 16, which typically includes a display. The display may have picture-in-picture (PIP) capabilities which allow display of two images. For instance, the PIP display may simultaneously show an ultrasound image and a magnetic resonance image, either with or without an overlay pattern. Alternatively, the PIP display may simultaneously show one overlaid image and one image without an overlay, each of the images may have different zoom levels. The destination 16 may also include a storage device for saving the overlaid image data 50.

**[0066]** It should be understood that the foregoing is

illustrative and not limiting, and that obvious modifications may be made by those skilled in the art.

## 5 Claims

1. System for indicating an area of interest on an image, comprising:
  - a plurality of sources (12) of image data (34, 34', 34");
  - an image processing unit (14) in communication with said plurality of sources (12) of image data (34, 34', 34");
  - a plurality of overlay patterns (30);
  - a user interface (40) for selecting at least one overlay pattern from said plurality of overlay patterns (30);
  - software executing on said image processing unit (14) for combining said at least one overlay pattern with said image data (34, 34', 34") to generate overlaid image data (50); and
  - a destination (16) for receiving said overlaid image data (50), said destination (16) comprising a display (26, 32);

**characterized in that** said image processing unit (14) communicates with each source of said plurality of sources (12) of image data (34, 34', 34") through a respective data type converter of a plurality of data type converters (42, 42', 42") connected to said source and communicates through a multiplexer (44) receiving outputs from said plurality of data type converters,

each data type converter (42, 42', 42") converts said respective image data (34, 34', 34") from the respective source into formatted image data readable by said image processing unit (14), and said image data (34, 34', 34") is selected from a group comprising ultrasound, X-ray, magnetic resonance imaging, nuclear magnetic resonance imaging, magnetic resonance tomography and computed tomography.
2. System of claim 1, **characterized in that** said group from which said image data (34, 34', 34") is selected further includes surgical image data.
3. System of any of claims 1 to 2, **characterized in that** said at least one source of the plurality of sources (12) of image data (34, 34', 34") communicates with said image processing unit (14) via streaming.
4. System of any of claims 1 to 3, **characterized in that** said software is further configured to adjust said formatted image data until said area of interest on said formatted image data is located at or near a region of said at least one overlay pattern.

5. System of any of claims 1 to 4, **characterized in that** said at least one overlay pattern includes a key (36) for indicating one or more regions of said overlay pattern.
6. System of any of claims 1 to 5, **characterized in that** said plurality of overlay patterns (30) include a grid, crosshairs, quadrants, marks, a circle, an oval, concentric shapes, centric lines, and a combination thereof.
7. System of claim 6, **characterized in that** said plurality of overlay patterns (30) further include concentric shapes superimposed on a set of centric lines originated from a single point, said single point being the center of said concentric circles.
8. System of any of claims 6 or 7, **characterized in that** said concentric shapes are two concentric circles having the diameters at 25% and 50% of the height of said display (26, 32).
9. System of any of claims 6 to 8, **characterized in that** said centric lines are shown for every 15 degrees, 20 degrees, 30 degrees, 45 degrees, 60 degrees, or 90 degrees.
10. System of any of claims 1 to 9, **characterized in that** said software is configured to adjust at least one property of said at least one overlay pattern, said at least one property of said at least one overlay pattern being chosen from the group consisting of activation, deactivation, resolution, opacity, opacity distribution, color, brightness, thickness, and size.
11. System of claim 10, **characterized in that** the at least one property of said at least one overlay pattern is configured in response to a command by a user, in response to a passage of time, or in response to data input from a motion vector detector or an accelerometer.
12. System of any claims 10 or 11, **characterized in that** the software is configured such that the zoom level of the overlay pattern and the zoom level of the formatted image data may be adjusted independently.
13. System of any of claims 1 to 12, **characterized in that** said display (26, 32) is configured to present said formatted image data or said overlaid image data (50) as a picture-in-picture using different types of image source data.

#### Patentansprüche

1. System zum Anzeigen eines Bereichs von Interesse

auf einem Bild, aufweisend:

eine Vielzahl von Quellen (12) von Bilddaten (34, 34', 34");

eine Bildverarbeitungseinheit (14) in Verbindung mit der Vielzahl von Quellen (12) von Bilddaten (34, 34', 34");

eine Vielzahl von Überlagerungsmustern (30); eine Benutzerschnittstelle (40) zum Auswählen mindestens eines Überlagerungsmusters aus der Vielzahl von Überlagerungsmustern (30);

Software, die auf der Bildverarbeitungseinheit (14) ausgeführt wird, um das mindestens eine Überlagerungsmuster mit den Bilddaten (34, 34', 34") zu kombinieren, um überlagerte Bilddaten (50) zu erzeugen; und

ein Ziel (16) zum Empfangen der überlagerten Bilddaten (50), wobei das Ziel (16) eine Anzeige (26, 32) aufweist;

**dadurch gekennzeichnet, dass**

die Bildverarbeitungseinheit (14) mit jeder Quelle der Vielzahl von Quellen (12) von Bilddaten (34, 34', 34") über einen entsprechenden Datentypkonverter einer Vielzahl von mit der Quelle verbundenen Datentypkonvertern (42, 42', 42") kommuniziert und über einen Multiplexer (44) kommuniziert, der Ausgaben von der Vielzahl von Datentypkonvertern empfängt,

jeder Datentypkonverter (42, 42', 42") die jeweiligen Bilddaten (34, 34', 34") von der jeweiligen Quelle in formatierte Bilddaten umwandelt, die von der Bildverarbeitungseinheit (14) lesbar sind, und

die Bilddaten (34, 34', 34") ausgewählt sind aus einer Gruppe, die Ultraschall, Röntgen, Magnetresonanzbildgebung, Kernspintomographiebildgebung, Magnetresonanztomographie und Computertomographie aufweist.

2. System nach Anspruch 1, **dadurch gekennzeichnet, dass** die Gruppe, aus der die Bilddaten (34, 34', 34") ausgewählt sind, ferner chirurgische Bilddaten beinhaltet.

3. System nach einem der Ansprüche 1 bis 2, **dadurch gekennzeichnet, dass** die mindestens eine Quelle aus der Vielzahl von Quellen (12) von Bilddaten (34, 34', 34") mit der Bildverarbeitungseinheit (14) über Streaming kommuniziert.

4. System nach einem der Ansprüche 1 bis 3, **dadurch gekennzeichnet, dass** die Software ferner ausgebildet ist, um die formatierten Bilddaten anzupassen, bis sich der interessierende Bereich auf den formatierten Bilddaten in oder nahe einem Bereich des mindestens einen Überlagerungsmusters befindet.

5. System nach einem der Ansprüche 1 bis 4, **dadurch**

- gekennzeichnet, dass** das mindestens eine Überlagerungsmuster einen Hinweis (36) zum Hinweisen auf einen oder mehrere Bereiche des Überlagerungsmusters aufweist.
6. System nach einem der Ansprüche 1 bis 5, **dadurch gekennzeichnet, dass** die Vielzahl von Überlagerungsmustern (30) ein Gitter, ein Fadenkreuz, Quadranten, Markierungen, einen Kreis, ein Oval, konzentrische Formen, zentrische Linien und eine Kombination derselben aufweist.
7. System nach Anspruch 6, **dadurch gekennzeichnet, dass** die Vielzahl von Überlagerungsmustern (30) ferner konzentrische Formen aufweisen, die einer Gruppe von zentrischen Linien überlagert sind, die von einem einzigen Punkt ausgehen, wobei der einzelne Punkt das Zentrum der konzentrischen Kreise ist.
8. System nach einem der Ansprüche 6 oder 7, **dadurch gekennzeichnet, dass** die konzentrischen Formen zwei konzentrische Kreise sind, die die Durchmesser bei 25% und 50% der Höhe der Anzeige (26, 32) haben.
9. System nach einem der Ansprüche 6 bis 8, **dadurch gekennzeichnet, dass** die zentrischen Linien für alle 15 Grad, 20 Grad, 30 Grad, 45 Grad, 60 Grad oder 90 Grad dargestellt sind.
10. System nach einem der Ansprüche 1 bis 9, **dadurch gekennzeichnet, dass** die Software dafür ausgebildet ist, mindestens eine Eigenschaft des mindestens einen Überlagerungsmusters einzustellen, wobei die mindestens eine Eigenschaft des mindestens einen Überlagerungsmusters ausgewählt ist aus der Gruppe bestehend aus Aktivierung, Deaktivierung, Auflösung, Opazität, Opazitätsverteilung, Farbe, Helligkeit, Dicke und Größe.
11. System nach Anspruch 10, **dadurch gekennzeichnet, dass** die mindestens eine Eigenschaft des mindestens einen Überlagerungsmusters als Reaktion auf einen Befehl eines Benutzers, als Reaktion auf einen Zeitablauf oder als Reaktion auf eine Dateneingabe von einem Bewegungsvektordetektor oder einem Beschleunigungssensor konfiguriert ist.
12. System nach einem der Ansprüche 10 oder 11, **dadurch gekennzeichnet, dass** die Software so ausgebildet ist, dass die Zoomstufe des Überlagerungsmusters und die Zoomstufe der formatierten Bilddaten unabhängig voneinander einstellbar sind.
13. System nach einem der Ansprüche 1 bis 12, **dadurch gekennzeichnet, dass** die Anzeige (26, 32) dafür ausgebildet ist, die formatierten Bilddaten oder

die überlagerten Bilddaten (50) als Bild-in-Bild unter Verwendung verschiedener Arten von Bildquellendaten darzustellen.

5

## Revendications

1. Système destiné à indiquer une zone d'intérêt sur une image, comprenant :
- une pluralité de sources (12) de données d'image (34, 34', 34") ;
- une unité de traitement d'image (14) en communication avec ladite pluralité de sources (12) de données d'image (34, 34', 34") ;
- une pluralité de motifs de superposition (30) ;
- une interface utilisateur (40) destinée à choisir au moins un motif de superposition parmi ladite pluralité de motifs de superposition (30) ;
- un logiciel s'exécutant sur ladite unité de traitement d'image (14) pour combiner ledit au moins un motif de superposition avec lesdites données d'image (34, 34', 34") pour générer des données d'image superposées (50) ; et
- une destination (16) destinée à recevoir lesdites données d'image superposées (50), ladite destination (16) comprenant un écran (26, 32) ;
- caractérisé en ce que**
- ladite unité de traitement d'image (14) communique avec chaque source de ladite pluralité de sources (12) de données d'image (34, 34', 34") par le biais d'un convertisseur de type de données respectif d'une pluralité de convertisseurs de type de données (42, 42', 42") relié à ladite source et communique par le biais d'un multiplexeur (44) recevant des sorties de ladite pluralité de convertisseurs de type de données, chaque convertisseur de type de données (42, 42', 42") convertit lesdites données d'image respectives (34, 34', 34") issues de la source respective en données d'image formatées lisibles par ladite unité de traitement d'image (14), et lesdites données d'image (34, 34', 34") sont choisies dans un groupe comprenant les ultrasons, les rayons X, l'imagerie par résonance magnétique, l'imagerie par résonance magnétique nucléaire, la tomographie par résonance magnétique et la tomodensitométrie.
2. Système de la revendication 1, **caractérisé en ce que** ledit groupe à partir duquel lesdites données d'image (34, 34', 34") sont choisies comporte en outre des données d'image chirurgicales.
3. Système de l'une quelconque des revendications 1 à 2, **caractérisé en ce que** ladite au moins une source de la pluralité de sources (12) de données d'image (34, 34', 34") communique avec ladite unité de tra-

- tement d'image (14) par diffusion en continu.
4. Système de l'une quelconque des revendications 1 à 3, **caractérisé en ce que** ledit logiciel est également configuré pour ajuster lesdites données d'image formatées jusqu'à ce que ladite zone d'intérêt sur lesdites données d'image formatées soit située dans ou près d'une région dudit au moins un motif de superposition. 5
  5. Système de l'une quelconque des revendications 1 à 4, **caractérisé en ce que** ledit au moins un motif de superposition comporte une clé (36) destinée à indiquer une ou plusieurs régions dudit motif de superposition. 10 15
  6. Système de l'une quelconque des revendications 1 à 5, **caractérisé en ce que** ladite pluralité de motifs de superposition (30) comportent une grille, une mire, des quadrants, des marques, un cercle, un ovale, des formes concentriques, des lignes centriques, et une combinaison de ceux-ci. 20
  7. Système de la revendication 6, **caractérisé en ce que** ladite pluralité de motifs de superposition (30) comportent en outre des formes concentriques superposées sur un ensemble de lignes centriques issues d'un point unique, ledit point unique étant le centre desdits cercles concentriques. 25 30
  8. Système de l'une quelconque des revendications 6 ou 7, **caractérisé en ce que** lesdites formes concentriques sont deux cercles concentriques ayant les diamètres à 25 % et 50 % de la hauteur dudit écran (26, 32). 35
  9. Système de l'une quelconque des revendications 6 à 8, **caractérisé en ce que** lesdites lignes centriques sont montrées tous les 15 degrés, 20 degrés, 30 degrés, 45 degrés, 60 degrés, ou 90 degrés. 40
  10. Système de l'une quelconque des revendications 1 à 9, **caractérisé en ce que** ledit logiciel est configuré pour ajuster au moins une propriété dudit au moins un motif de superposition, ladite au moins une propriété dudit au moins un motif de superposition étant choisie dans le groupe constitué par une activation, une désactivation, une résolution, une opacité, une distribution d'opacité, une couleur, une luminosité, une épaisseur, et une taille. 45 50
  11. Système de la revendication 10, **caractérisé en ce que** l'au moins une propriété dudit au moins un motif de superposition est configurée en réponse à une commande d'un utilisateur, en réponse à un passage du temps, ou en réponse à des données entrées depuis un détecteur de vecteurs de mouvement ou un accéléromètre. 55
  12. Système de l'une quelconque des revendications 10 ou 11, **caractérisé en ce que** le logiciel est configuré de telle sorte que le niveau de zoom du motif de superposition et le niveau de zoom des données d'image formatées peuvent être ajustés indépendamment.
  13. Système de l'une quelconque des revendications 1 à 12, **caractérisé en ce que** ledit écran (26, 32) est configuré pour présenter lesdites données d'image formatées ou lesdites données d'image superposées (50) comme une image dans l'image en utilisant différents types de données d'image sources.

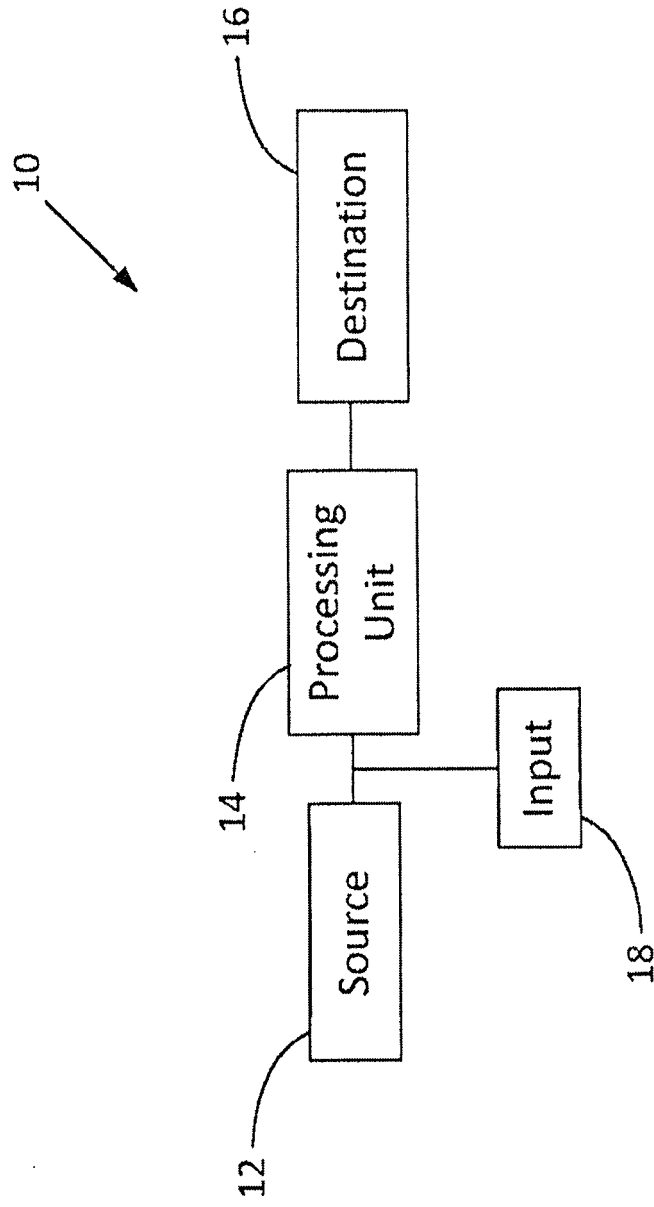

FIG. 1

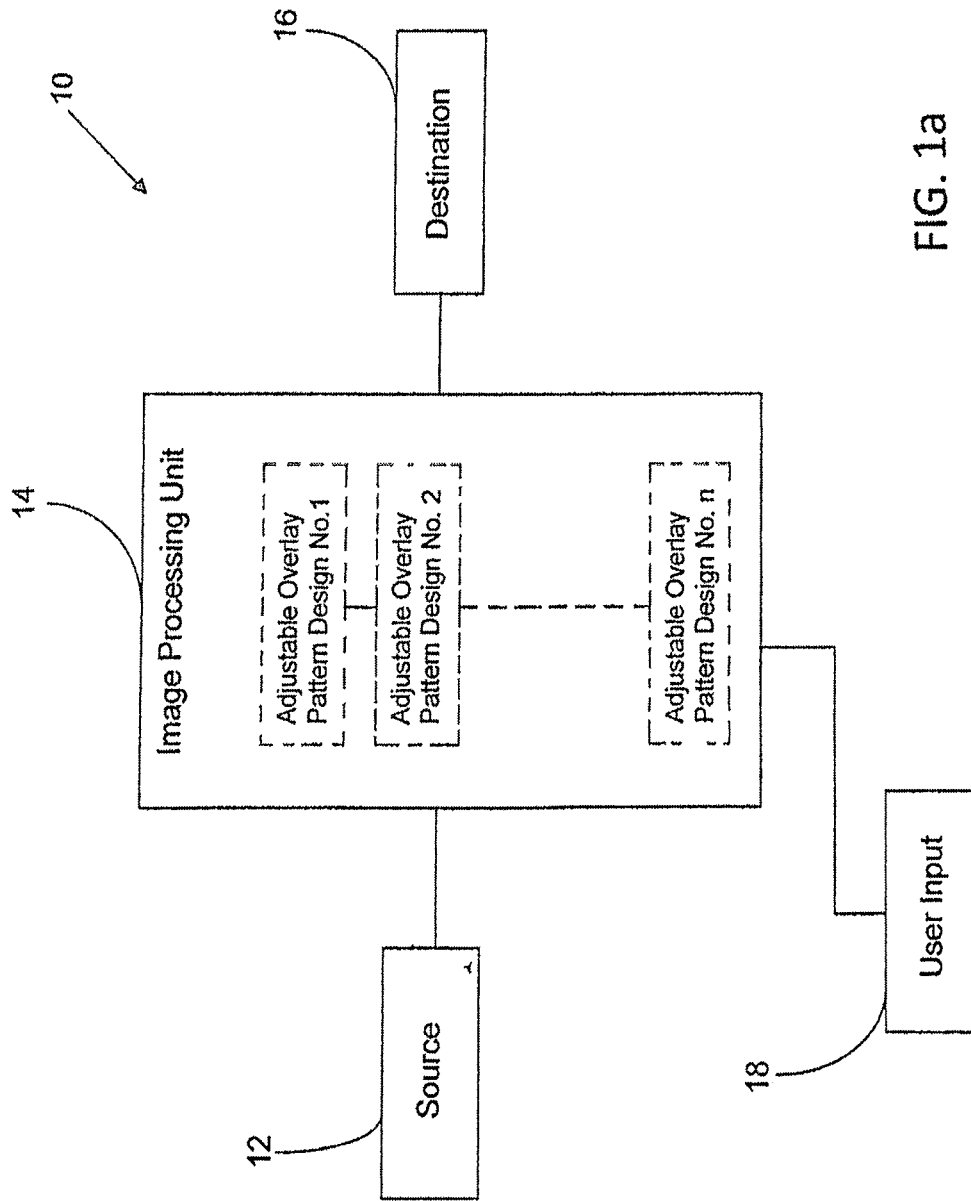

FIG. 1a

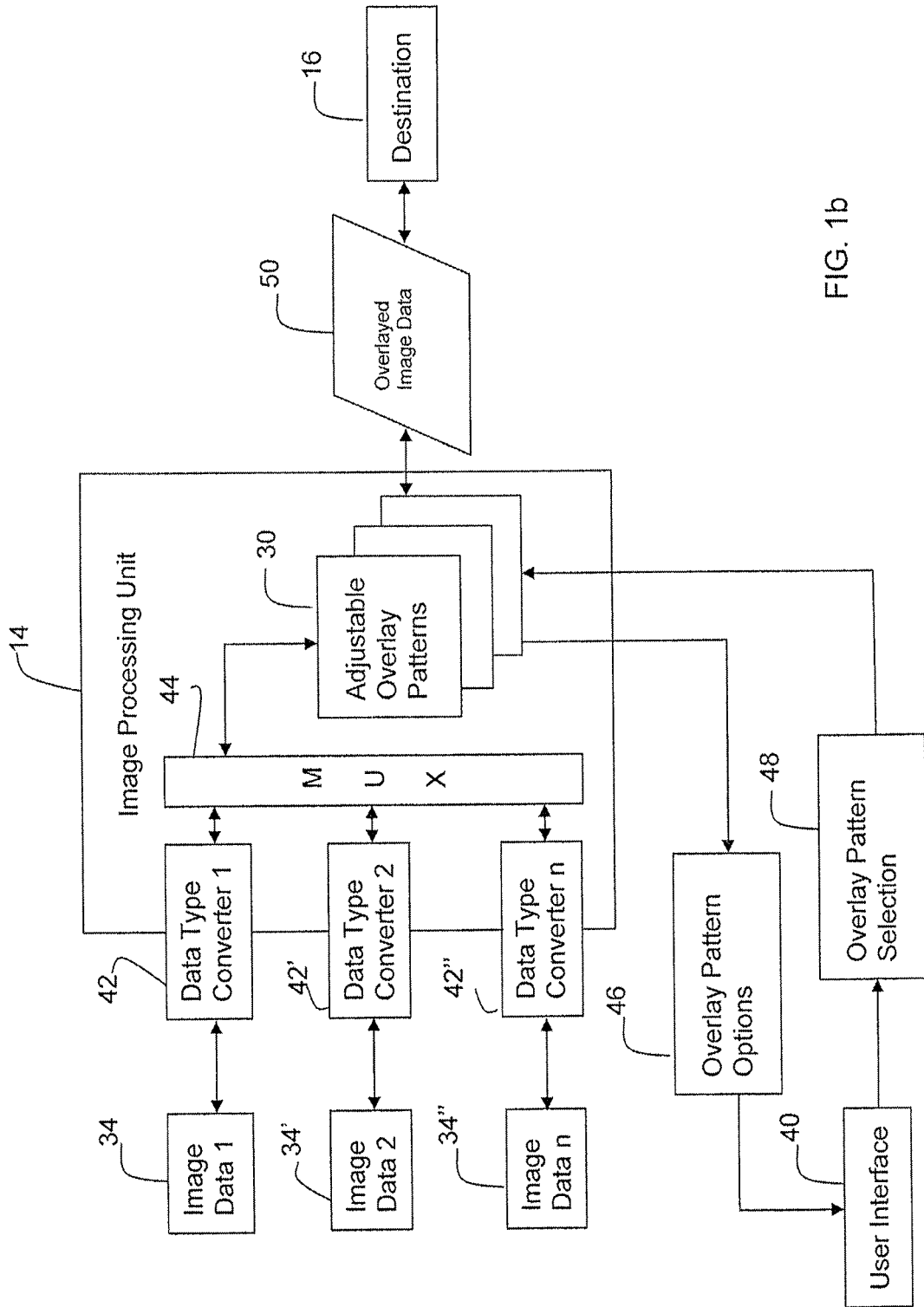

FIG. 1b

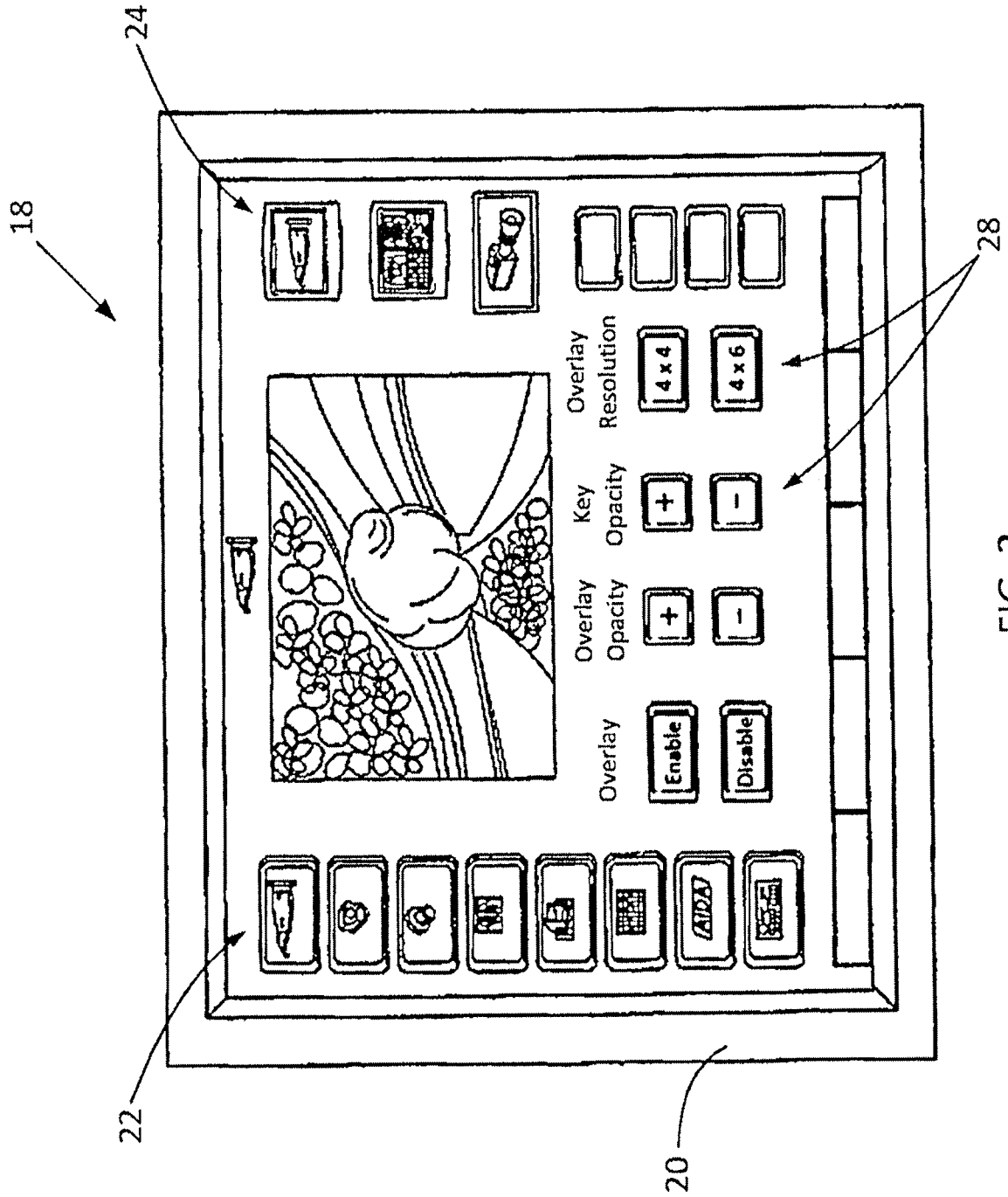
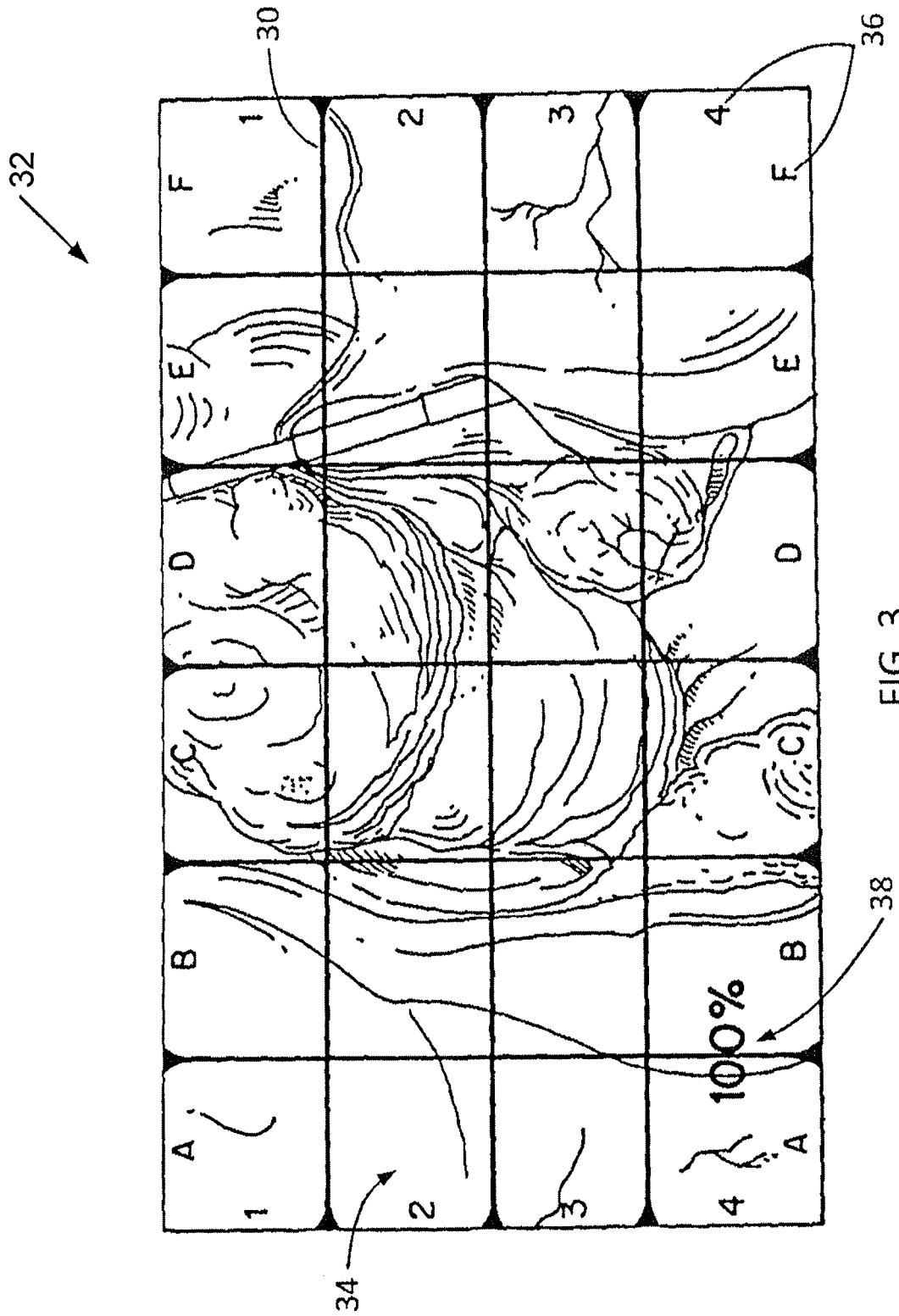

FIG. 2



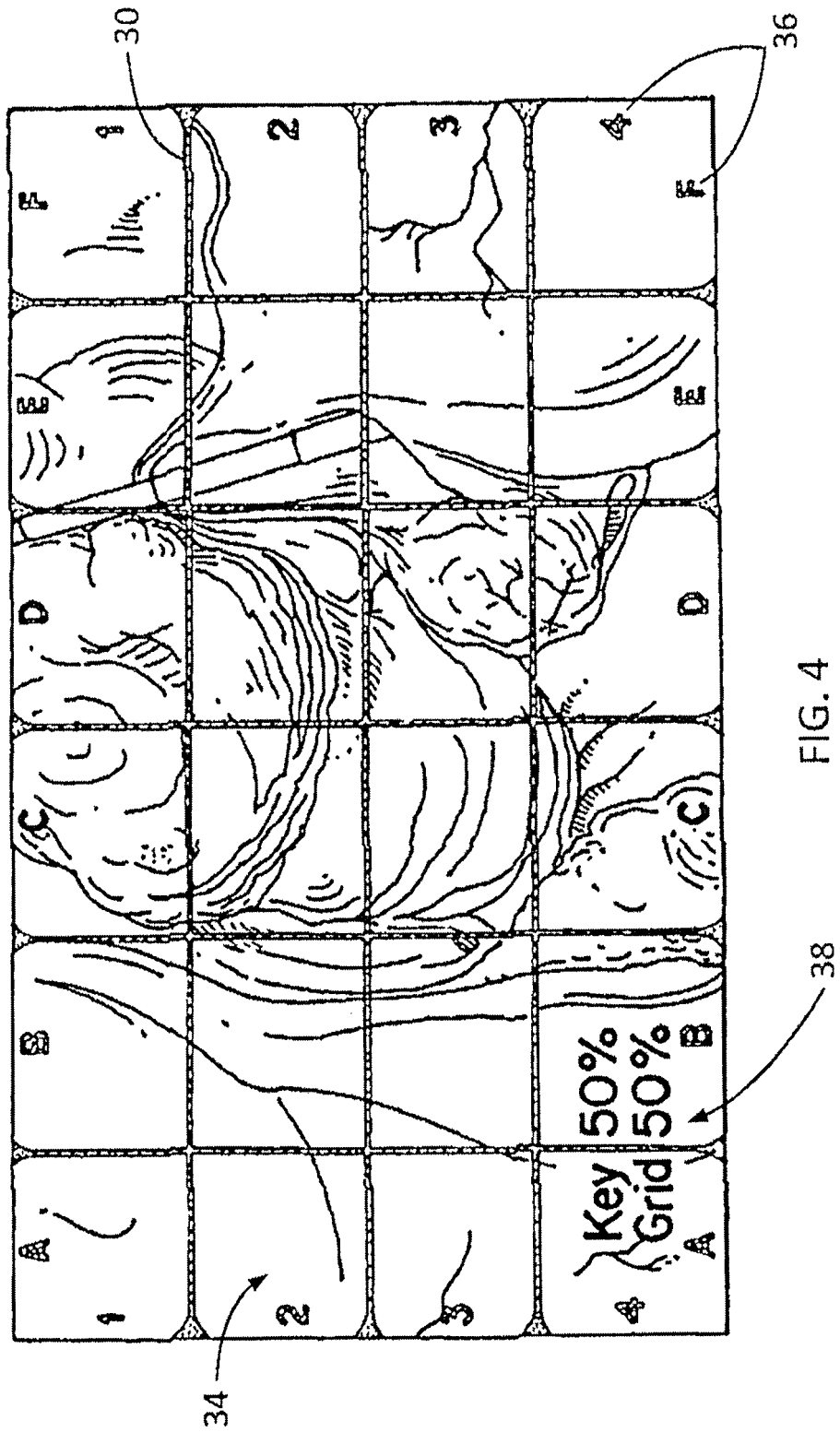

FIG. 4

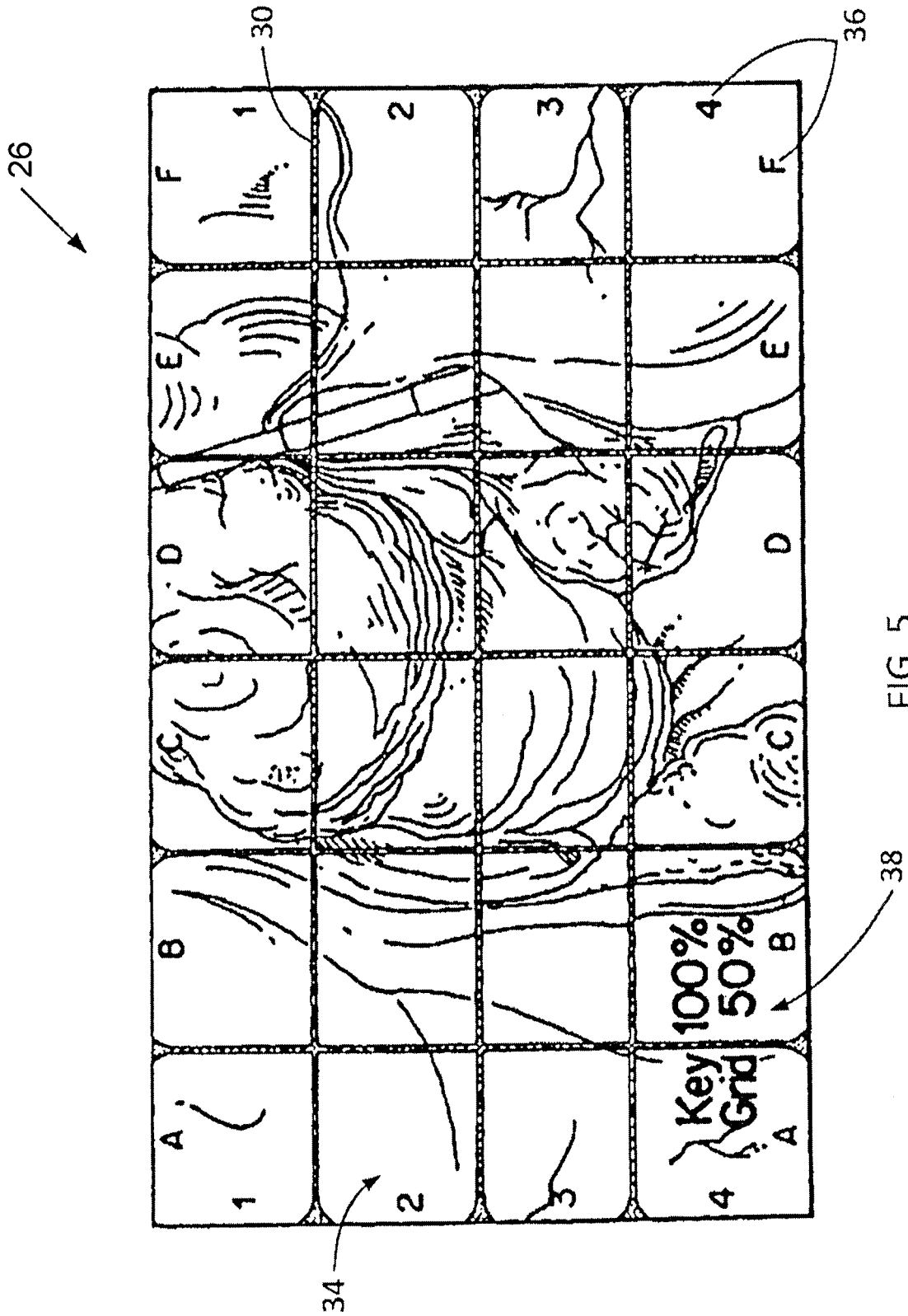

FIG. 5

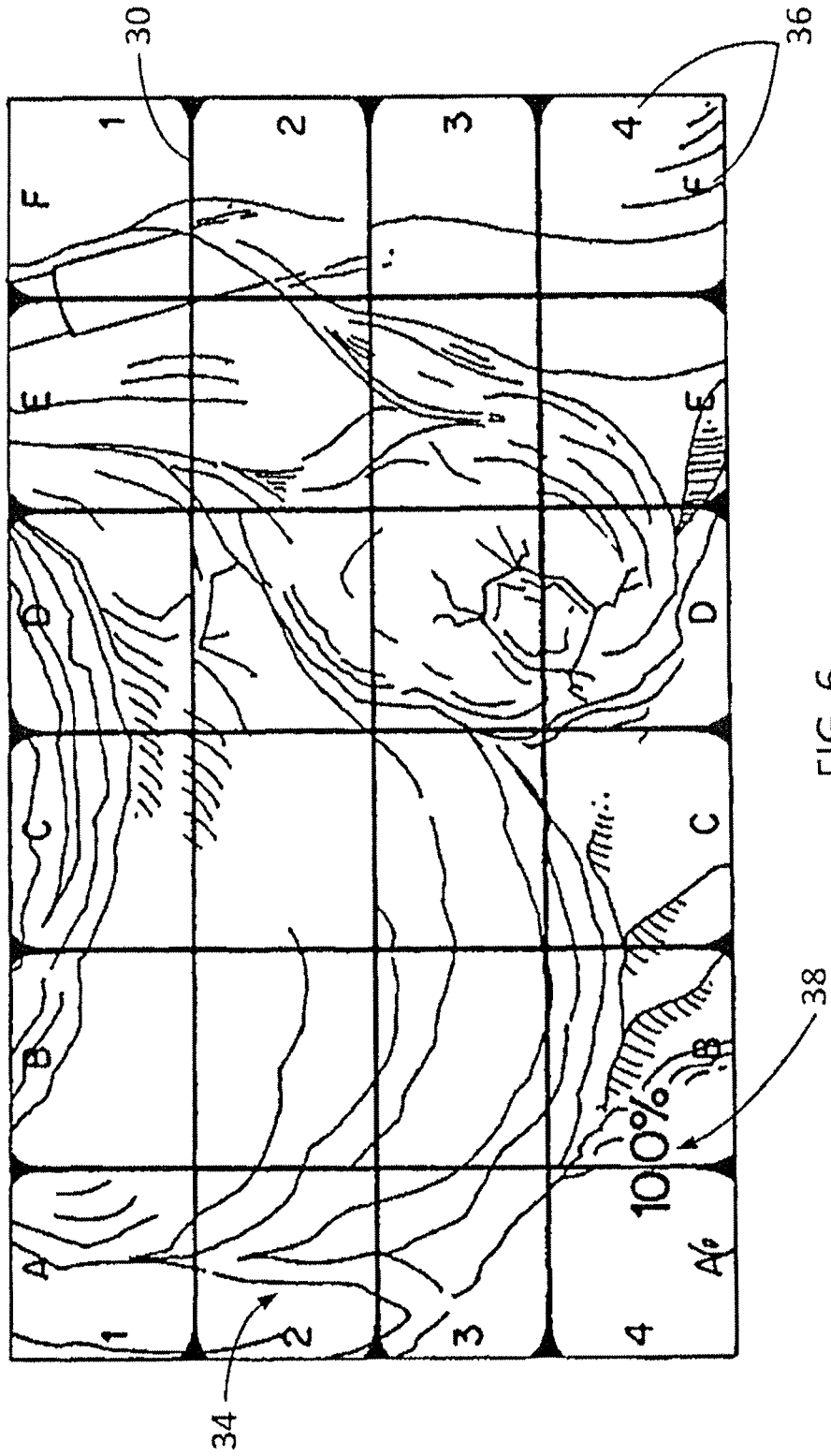

FIG. 6

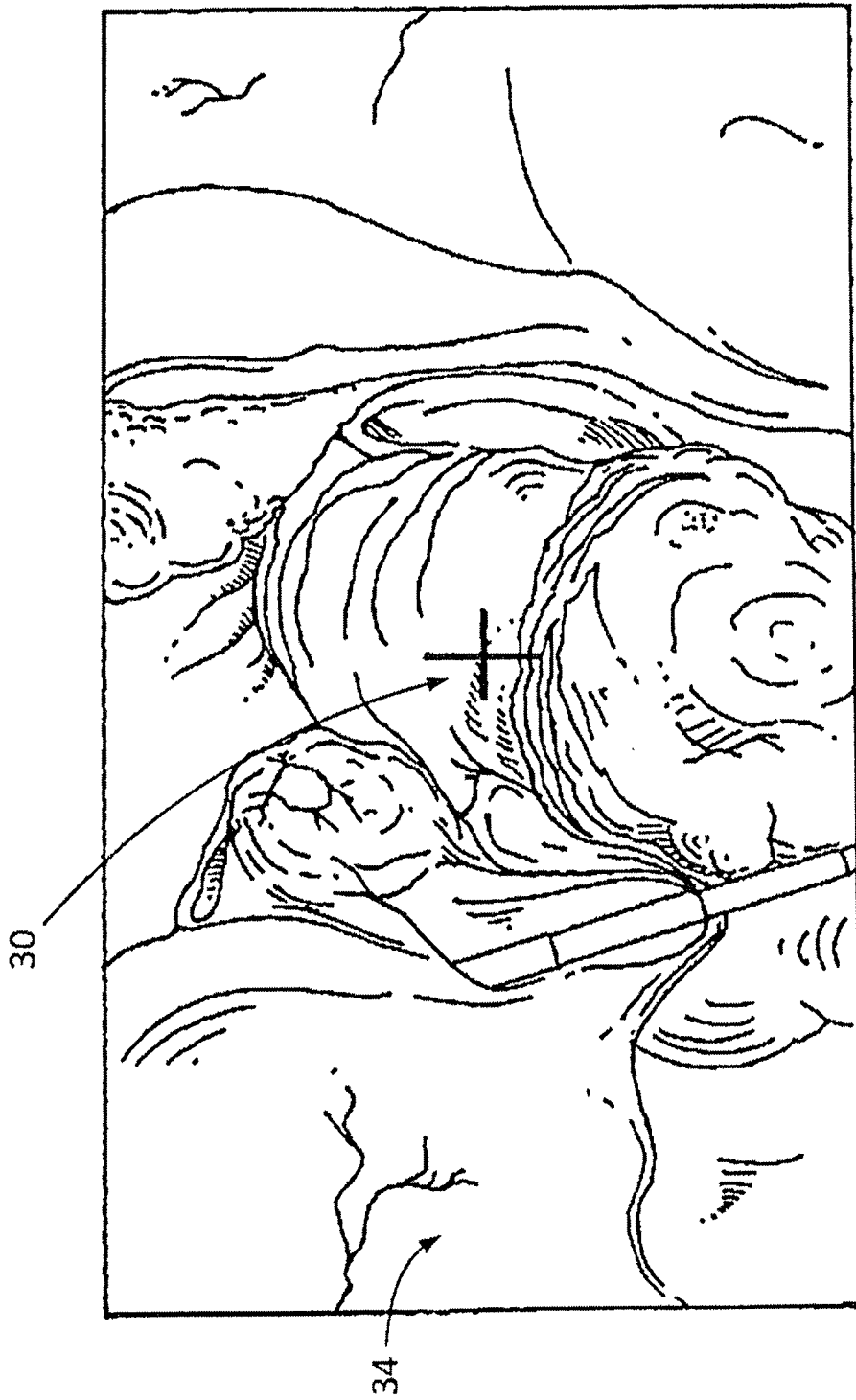

FIG. 7

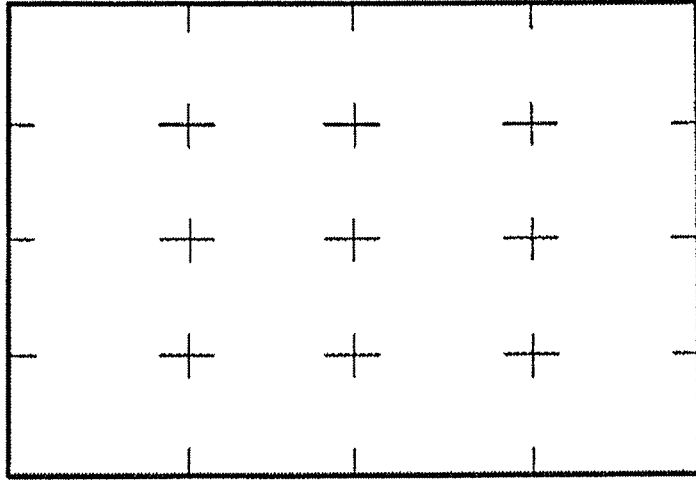

FIG. 8

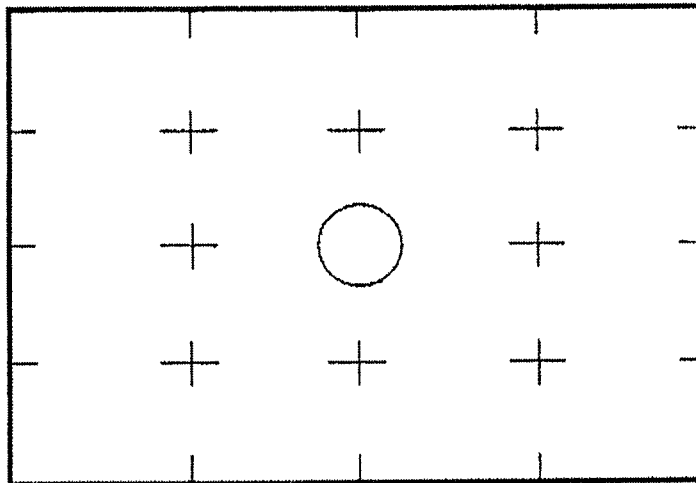

FIG. 9

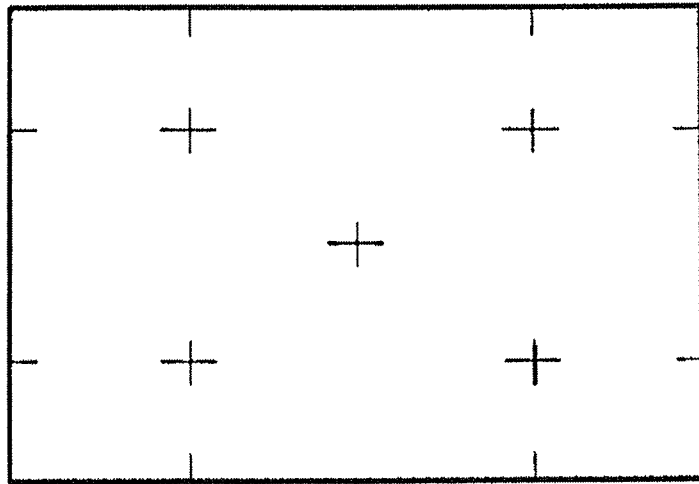

FIG. 10

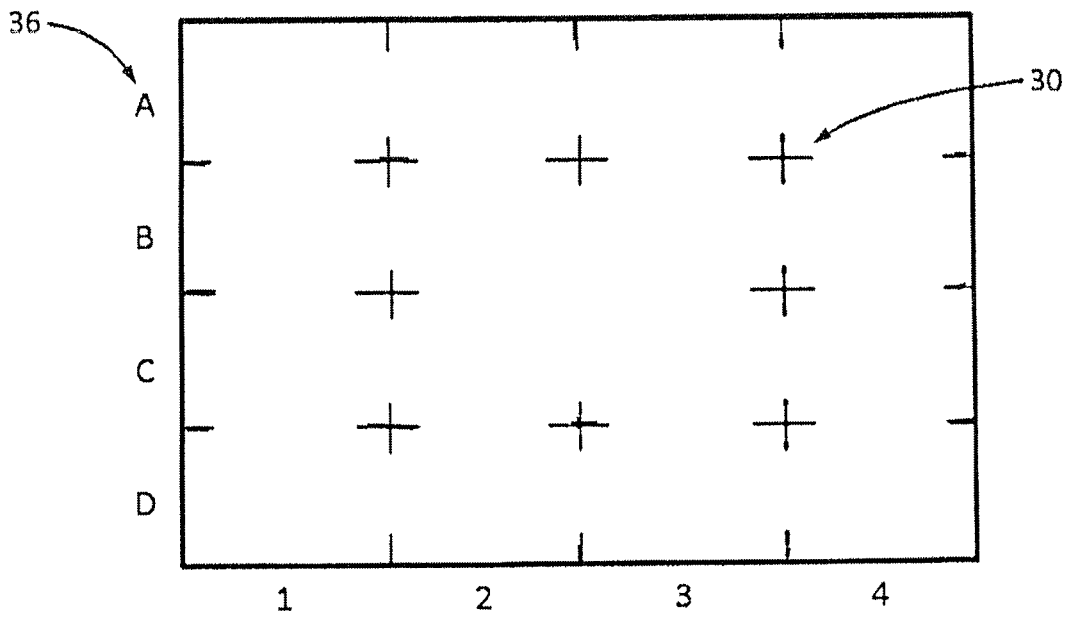

FIG. 11

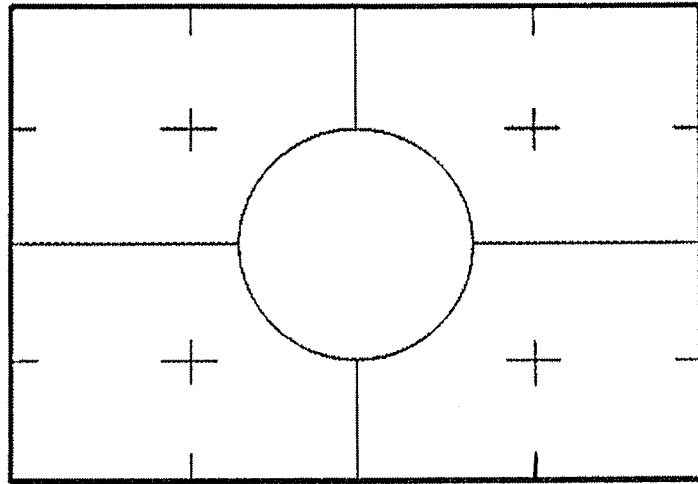

FIG. 12

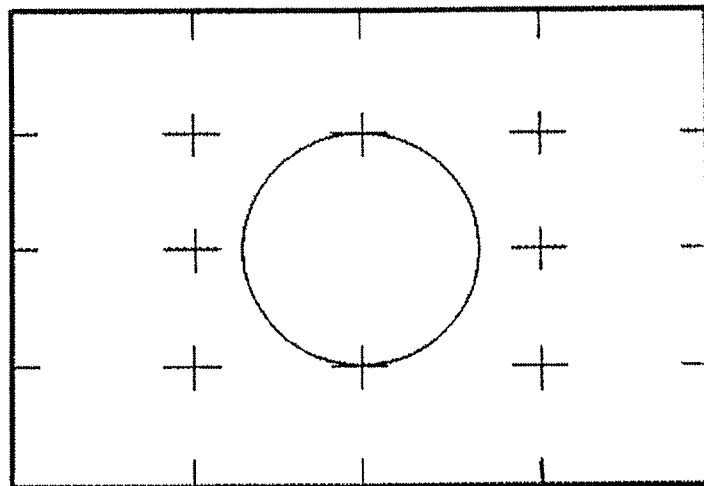

FIG. 13

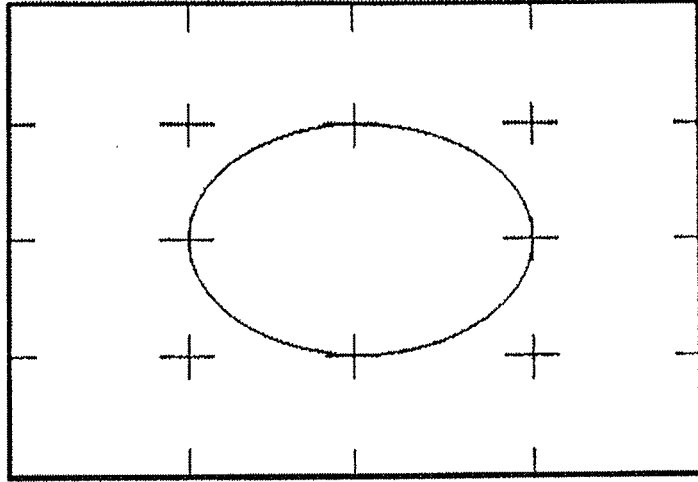

FIG. 14

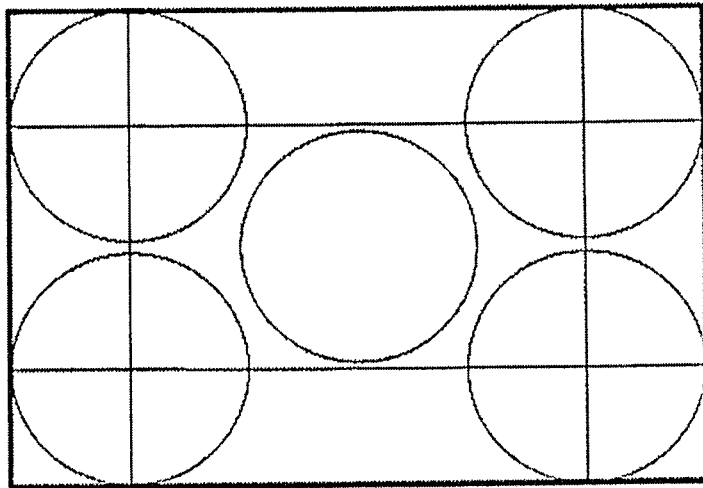

FIG. 15

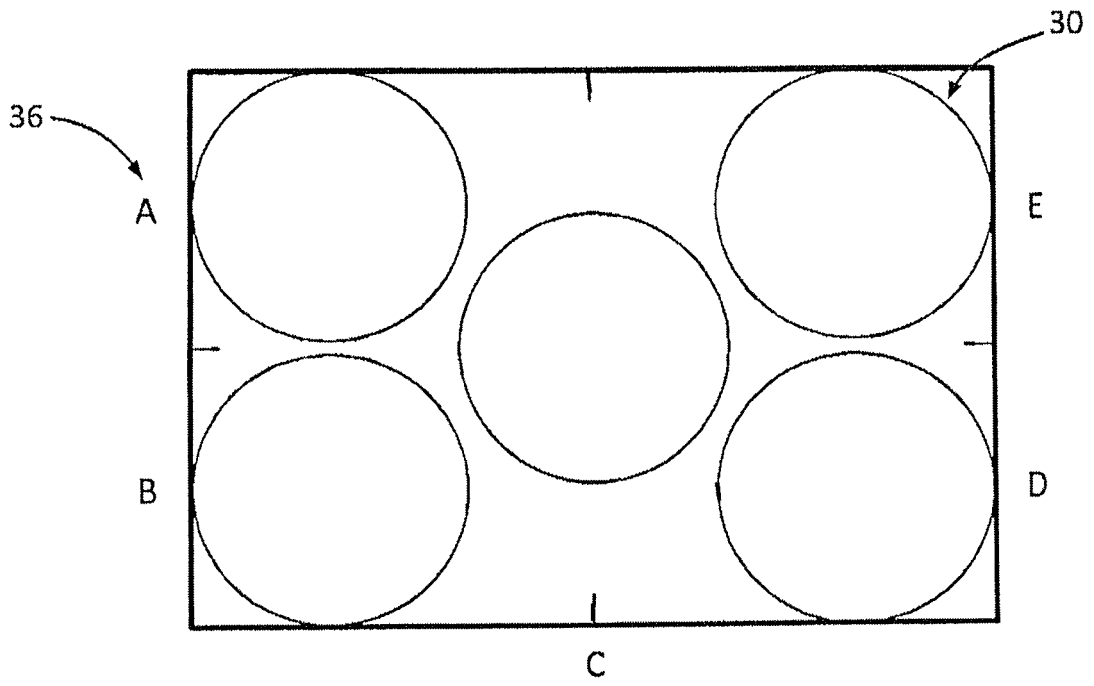

FIG. 16

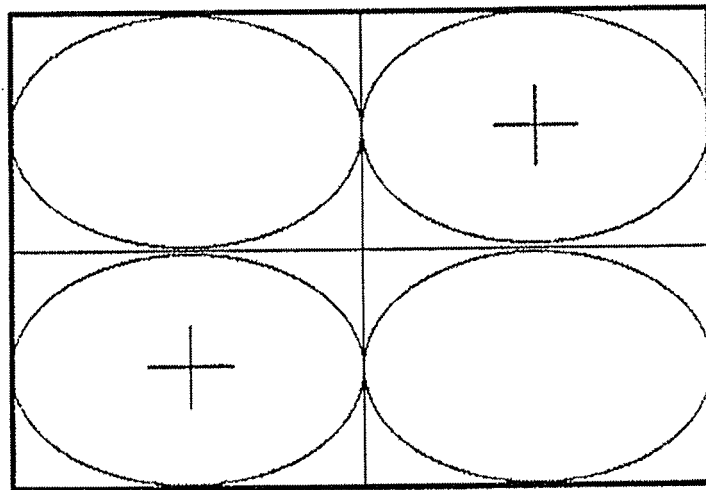

FIG. 17

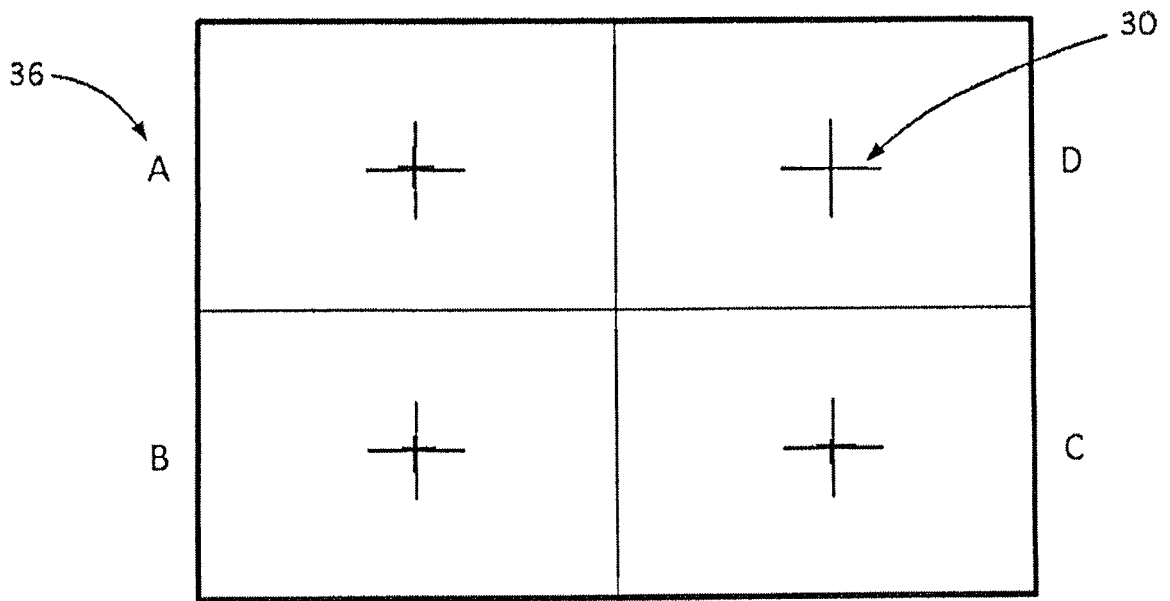

FIG. 18

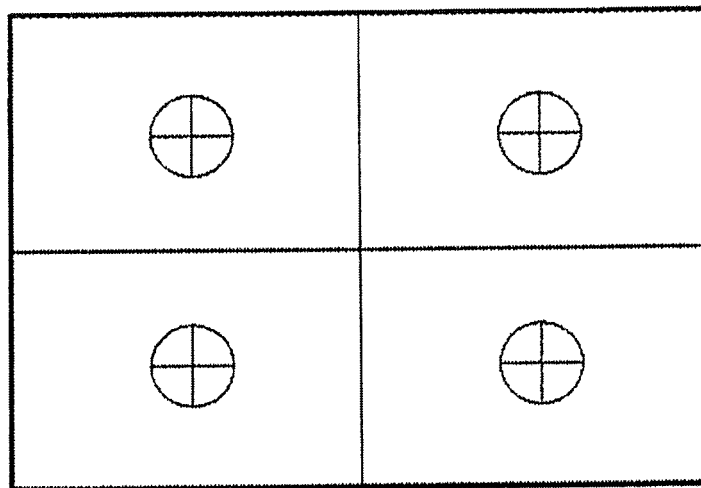

FIG. 19

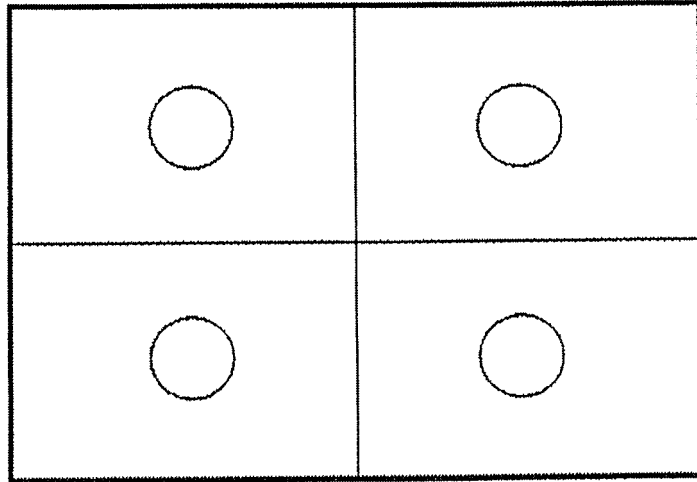

FIG. 20

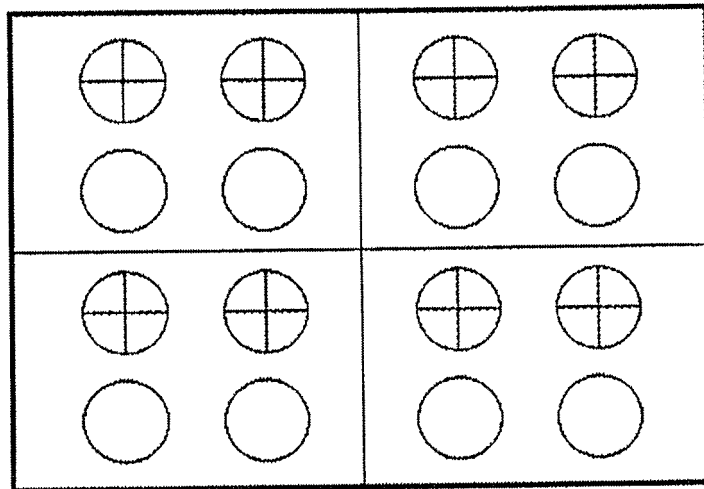

FIG. 21

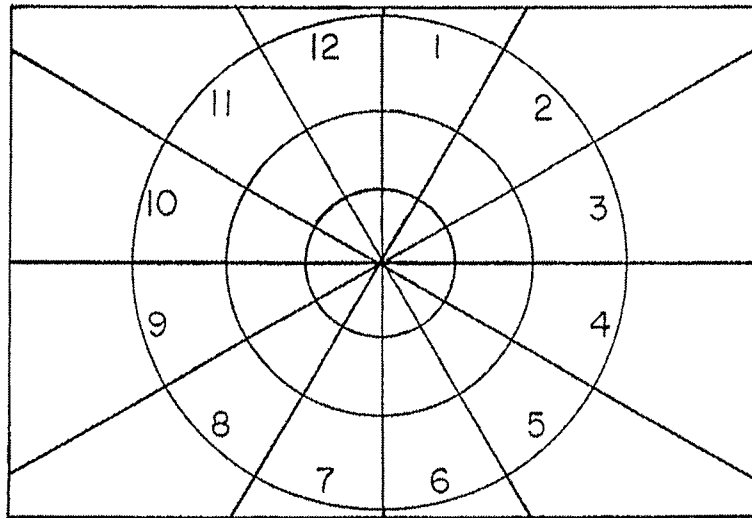

FIG. 22

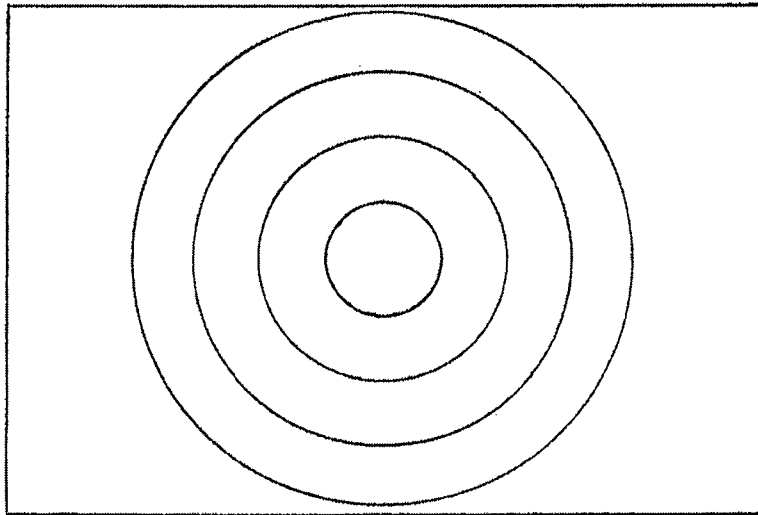

FIG. 23

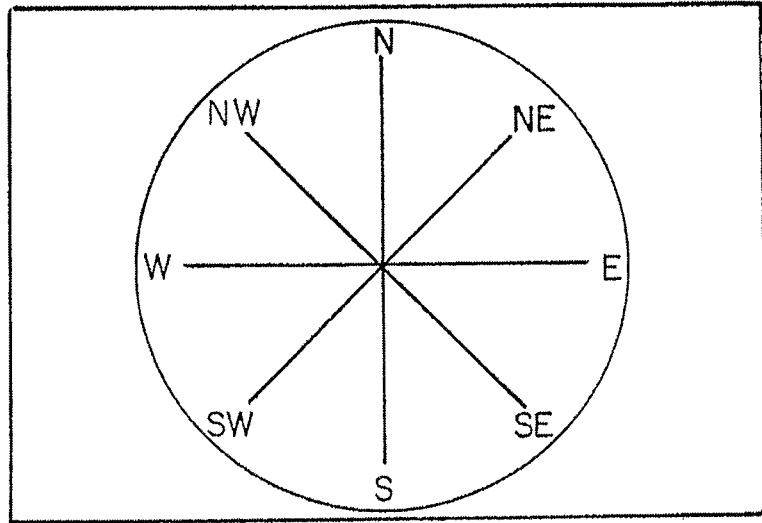

FIG. 24

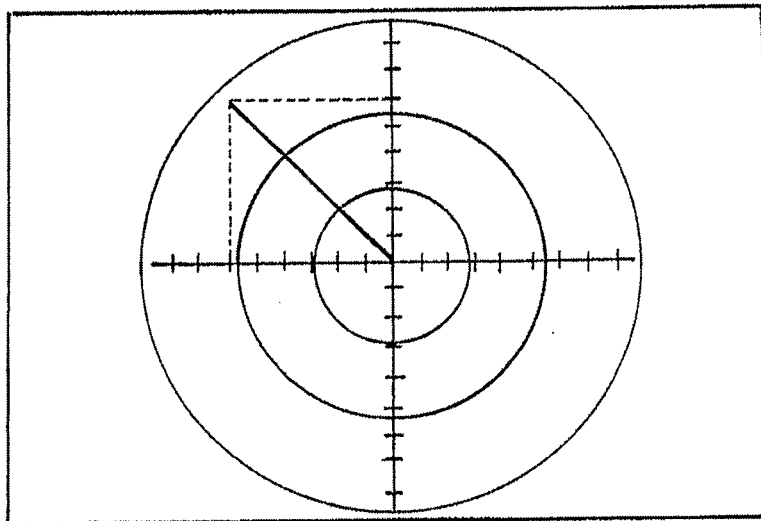

FIG. 25

**REFERENCES CITED IN THE DESCRIPTION**

*This list of references cited by the applicant is for the reader's convenience only. It does not form part of the European patent document. Even though great care has been taken in compiling the references, errors or omissions cannot be excluded and the EPO disclaims all liability in this regard.*

**Patent documents cited in the description**

- EP 2486847 A1 [0007]

专利名称(译)	多源医疗显示器		
公开(公告)号	<a href="#">EP2866162B1</a>	公开(公告)日	2018-12-05
申请号	EP2014188189	申请日	2014-10-08
[标]申请(专利权)人(译)	卡尔史托斯影像有限公司		
申请(专利权)人(译)	KARL STORZ IMAGING INC.		
当前申请(专利权)人(译)	KARL STORZ IMAGING , INC.		
[标]发明人	KING TIMOTHY PRESCHER THOMAS BARNHILL KIM		
发明人	KING, TIMOTHY PRESCHER, THOMAS BARNHILL, KIM		
IPC分类号	G06F19/00 A61B5/00 H04N7/18 H04L29/06		
CPC分类号	A61B5/7435 A61B5/748 G06F19/321 G16H30/40 G16H40/63 H04L65/605		
代理机构(译)	WITTE , WELLER & PARTNER专利律师MBB		
优先权	14/048913 2013-10-08 US		
其他公开文献	EP2866162A1		
外部链接	<a href="#">Espacenet</a>		

摘要(译)

一种用于指示图像上的感兴趣区域的系统，包括图像数据源，图像处理单元，用户界面和目的地，其可以是显示器。图像数据可以是超声，X射线，磁共振成像，核磁共振成像，磁共振断层造影，计算机断层扫描或手术图像数据。图像处理单元可以被配置为从源接收图像数据并将其与从多个覆盖图案中选择的期望覆盖图案组合，用于指示图像上的感兴趣区域，然后将其显示在显示器上。覆盖图案可以包括具有坐标或标签的键。可以独立地或自动地调整覆盖图案和图像数据的属性。

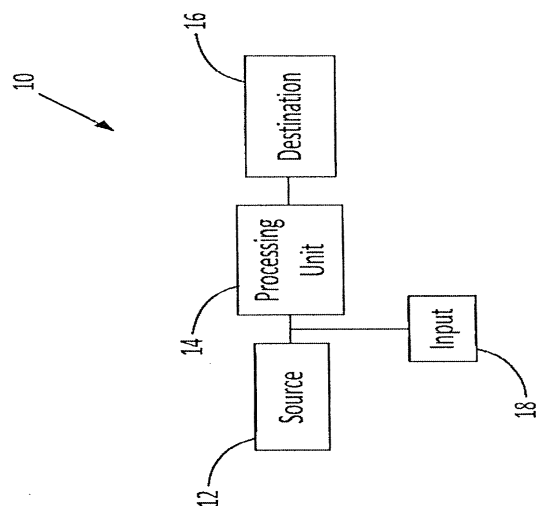

FIG. 1