



(11) **EP 2 501 283 B1**

(12) **EUROPEAN PATENT SPECIFICATION**

(45) Date of publication and mention of the grant of the patent:
21.09.2016 Bulletin 2016/38

(51) Int Cl.:
A61B 5/053 ^(2006.01) **A61N 1/04** ^(2006.01)
A61B 5/00 ^(2006.01) **G01R 35/00** ^(2006.01)
G01R 27/02 ^(2006.01)

(21) Application number: **10830958.4**

(86) International application number:
PCT/AU2010/001552

(22) Date of filing: **18.11.2010**

(87) International publication number:
WO 2011/060497 (26.05.2011 Gazette 2011/21)

(54) **SIGNAL DISTRIBUTION FOR PATIENT-ELECTRODE MEASUREMENTS**

SIGNALVERTEILUNG FÜR PATIENTENELEKTRODENMESSUNGEN

DISTRIBUTION DE SIGNAL POUR DES MESURES D'ÉLECTRODE DE PATIENT

(84) Designated Contracting States:
AL AT BE BG CH CY CZ DE DK EE ES FI FR GB GR HR HU IE IS IT LI LT LU LV MC MK MT NL NO PL PT RO RS SE SI SK SM TR

(56) References cited:
WO-A1-2008/119166 WO-A1-2008/119166
US-A1- 2002 194 419 US-A1- 2005 098 343
US-A1- 2008 183 098 US-B1- 6 569 160
US-B2- 6 724 200

(30) Priority: **18.11.2009 AU 2009905642**

(43) Date of publication of application:
26.09.2012 Bulletin 2012/39

(73) Proprietor: **Impedimed Limited**
Pinkenba, QLD 4008 (AU)

(72) Inventors:
• **FAN, Chung Shing**
Toronto, Ontario M5A 4J5 (CA)
• **IRONSTONE, Joel**
Toronto, Ontario M5E 1Z5 (CA)
• **SMITH, Kenneth Carless**
Toronto, Ontario M4L 6S9 (CA)

(74) Representative: **Appleyard Lees IP LLP**
15 Clare Road
Halifax HX1 2HY (GB)

- **Fernando Seoane ET AL: "Current Source for Wideband Electrical Bioimpedance Spectroscopy Based on a Single Operational Amplifier" In: "World Congress on Medical Physics and Biomedical Engineering 2006", 1 January 2007 (2007-01-01), Springer Berlin Heidelberg, Berlin, Heidelberg, XP055120064, ISBN: 978-3-54-036839-7 vol. 14, pages 707-710, DOI: 10.1007/978-3-540-36841-0_165, * the whole document * * ***
- **SEOANE F ET AL: "Current Source for Multifrequency Broadband Electrical Bioimpedance Spectroscopy Systems. A Novel Approach", CONFERENCE PROCEEDINGS. ANNUAL INTERNATIONAL CONFERENCE OF THE IEEE ENGINEERING IN MEDICINE AND BIOLOGY SOCIETY (IEEE CAT. NO. 06CH37748); 30 AUG.-3 SEPT. 2006; NEW YORK, NY, USA, IEEE, PISCATAWAY, NJ, USA, 30 August 2006 (2006-08-30), pages 5121-5125, XP031390619, ISBN: 978-1-4244-0032-4**

Note: Within nine months of the publication of the mention of the grant of the European patent in the European Patent Bulletin, any person may give notice to the European Patent Office of opposition to that patent, in accordance with the Implementing Regulations. Notice of opposition shall not be deemed to have been filed until the opposition fee has been paid. (Art. 99(1) European Patent Convention).

EP 2 501 283 B1

Description

Background of the Invention

5 **[0001]** The present invention relates to apparatus for electrically connecting measurement apparatus to a biological subject, and in particular, to a circuit for electrical impedance measurements, which in one example allows drive signal injection and signal amplitude and phase measurement.

Description of the Prior Art

10 **[0002]** The reference in this specification to any prior publication (or information derived from it), or to any matter which is known, is not, and should not be taken as an acknowledgment or admission or any form of suggestion that the prior publication (or information derived from it) or known matter forms part of the common general knowledge in the field of endeavour to which this specification relates.

15 **[0003]** One existing technique for determining biological indicators relating to a subject, such as cardiac function, body composition, and other health status indicators, such as the presence of oedema, involves the use of bioelectrical impedance. This process typically involves using a measuring device to measure the electrical impedance of a subject's body using a series of electrodes placed on the skin surface. Changes in electrical impedance measured at the body's surface are used to determine parameters, such as changes in fluid levels, associated with the cardiac cycle, oedema, or the like.

20 **[0004]** Impedance measuring apparatus is sometimes sensitive to external factors, including stray capacitances between the subject and the local environment and the measurement apparatus, variations in electrode/tissue interface impedances, also known as electrode impedances, as well as stray capacitances and inductive coupling between the leads used to connect the measuring device to the electrodes.

25 **[0005]** It will be appreciated that similar issue also arise when making other electrical measurements relating to biological subjects.

30 **[0006]** WO2009/059351 describes apparatus for use in performing impedance measurements on a subject. The apparatus includes a processing system for causing a first signal to be applied to the subject, determining an indication of a second signal measured across the subject, using the indication of the second signal to determine any imbalance and if an imbalance exists, determining a modified first signal in accordance with the imbalance and causing the modified first signal to be applied to the subject to thereby allow at least one impedance measurement to be performed.

35 **[0007]** The prior art "Current Source for Wideband Electrical Bioimpedance Spectroscopy Based on a single Operational Amplifier", by the authors F. Seoane et al., discloses an apparatus for electrically connecting measurement apparatus to a biological subject.

10 Summary of the Present Invention

[0008] The invention is defined by claim 1. An embodiment provides apparatus for electrically connecting measurement apparatus to a biological subject, the apparatus including a signal delivery circuit including:

a) a current buffer having:

- i) a current buffer input for receiving a signal from a signal source; and,
- ii) a current buffer output for supplying a current to an electrode attached to the biological subject; and,

b) a voltage buffer having:

- i) a voltage buffer input coupled to the current buffer output; and,
- ii) a voltage buffer output for providing a voltage signal indicative of a voltage at the electrode, to a sensor.

50 **[0009]** Typically the current buffer is a current conveyor.

[0010] Typically the voltage buffer is an amplifier connected as an output follower.

[0011] Typically the apparatus includes an offset control circuit coupled between the voltage buffer output and the current buffer input.

55 **[0012]** Typically the offset control circuit includes an integrator coupled between the voltage buffer output and the current buffer input.

[0013] Typically the offset control circuit is used to control a DC offset at the electrode.

[0014] Typically the signal delivery circuit includes a negative impedance circuit coupled between the voltage buffer

output and the current buffer output.

[0015] Typically the negative impedance circuit includes a negative impedance circuit amplifier and a compensation impedance.

5 **[0016]** Typically at least one of a gain of the negative impedance circuit amplifier and a value of the compensation impedance is selected to compensate for parasitic impedance losses.

[0017] Typically the negative impedance circuit includes:

- 10 a) a compensation impedance having a compensation impedance value, a first terminal and a second terminal, the first terminal coupled to the current buffer output; and,
b) a compensation amplifier having a compensation amplifier input, a compensation amplifier output and a gain, the compensation amplifier input coupled to the voltage buffer output, the compensation amplifier output coupled to the second terminal of the compensation impedance to provide a compensation current to flow through the impedance, and the gain and the compensation impedance values are selected based on the parasitic impedance value so that the compensation current has a magnitude substantially equal to the leakage current magnitude.

15 **[0018]** Typically the apparatus includes:

- 20 a) a plurality of signal delivery circuits, each signal delivery circuit being for supplying a current to a respective electrode attached to the biological subject;
b) at least one signal source; and,
c) at least one first multiplexer for selectively connecting the signal source to one of the plurality of signal delivery circuits to thereby apply a current to the biological circuit via the respective electrode.

25 **[0019]** Typically the apparatus includes:

- 30 a) a plurality of signal delivery circuits, each signal delivery circuit being for providing a voltage signal indicative of a voltage at the electrode, to a sensor;
b) at least one sensor; and,
c) at least one second multiplexer for selectively connecting the at least one sensor to one of the plurality of signal delivery circuits to thereby allow the sensor to sense the voltage signal indicative of a voltage at the respective electrode.

[0020] Typically the apparatus includes, first and second signal sources for generating respective first and second drive signals, the first and second signal sources being coupled to respective signal delivery circuits.

35 **[0021]** Typically the first and second signal sources are for generating at least one of:

- 40 a) complementary signals;
b) signals having a constant amplitude and phase; and,
c) signals having a controlled amplitude and phase.

[0022] Typically at least one signal source is coupled to ground.

[0023] Typically the apparatus includes:

- 45 a) at least one signal delivery circuit for supplying a current to a drive electrode attached to the biological subject; and,
b) at least one signal delivery circuit for providing a voltage signal indicative of a voltage at a sense electrode.

[0024] Typically the measurement apparatus includes at least one signal source and at least one sensor.

[0025] Typically the measurement apparatus is an impedance measurement apparatus.

50 **[0026]** A first example provides a current multiplexing system comprising:

- a) a plurality of current multiplexers having at least one input and a plurality of outputs;
b) a first and second alternating-current current source each current source having a constant magnitude and frequency, wherein the second current source is complimentary to the first current source, each of the first and second current sources is coupled to an input of a current multiplexer;
c) a plurality of current delivery circuits, each current delivery circuit having an input, a current output and a voltage output, wherein each current delivery circuit input is coupled to an output of a current multiplexer;
d) a plurality of electrodes, each of the plurality of electrodes being coupled to a current output of one of the plurality of current delivery circuits; and

EP 2 501 283 B1

- e) at least one voltage multiplexer having a plurality of inputs and at least one output;
- f) wherein each current delivery circuit comprises:

- i) a current conveyor, having an input and an output, the current conveyor input being coupled to the current delivery circuit input and the current conveyor output being coupled to the current delivery circuit current output;
- ii) a voltage buffer, having an input and an output, the voltage buffer input being coupled to the current delivery circuit current output and the voltage buffer output being coupled to the current delivery circuit voltage output;
- iii) an integrator coupled between the voltage buffer output and the current conveyor input; and,
- iv) a negative impedance circuit coupled between the voltage buffer output and the current conveyor output, the negative impedance comprising:

(1) a compensation impedance having a compensation impedance value, a first terminal and a second terminal, the first terminal coupled to the current conveyor output;

(2) a compensation amplifier having a compensation amplifier input, a compensation amplifier output and a gain, the compensation amplifier input coupled to the voltage buffer output, the compensation amplifier output coupled to the second terminal of the compensation impedance to provide a compensation current to flow through the impedance, and the gain and the compensation impedance values are selected based on the parasitic impedance value so that the compensation current has a magnitude substantially equal to the leakage current magnitude.

[0027] A second example provides apparatus for electrically connecting measurement apparatus to a biological subject, the apparatus including a signal delivery circuit including:

- a) a first buffer having:

- i) a first buffer input for receiving a signal from a signal source; and,
- ii) a first buffer output for supplying a drive signal to an electrode attached to the biological subject; and,

- b) a second buffer having:

- i) a second buffer input coupled to the first buffer output; and,
- ii) a second buffer output for providing a sensed signal indicative of a signal at the electrode, to a sensor.

[0028] Typically the first buffer is a current buffer, the drive signal being a drive current.

[0029] Typically the current buffer is a current conveyor.

[0030] Typically the second buffer is a voltage buffer the sensed signal being a voltage signal indicative of a voltage at the electrode.

[0031] Typically the second buffer is a current buffer the sensed signal being indicative of the drive current.

[0032] A third example provides apparatus for use in performing impedance measurements on a subject, wherein the apparatus includes:

- a) a signal source for applying a signal to a subject;
- b) a sensor for sensing signals from the subject;
- c) a processing system for controlling the signal source and receiving signals from the sensor; and,
- d) at least one signal delivery circuit, including:

- i) a first buffer having:

(1) a first buffer input for receiving a signal from a signal source; and,

(2) a first buffer output for supplying a drive signal to an electrode attached to the biological subject; and,

- ii) a second buffer having:

(1) a second buffer input coupled to the first buffer output; and,

(2) a second buffer output for providing a sensed signal indicative of a signal at the electrode, to a sensor.

[0033] Typically the apparatus includes:

EP 2 501 283 B1

- a) at least one signal delivery circuit for supplying a current to a drive electrode attached to the biological subject; and,
- b) at least one signal delivery circuit for providing a voltage signal indicative of a voltage at a sense electrode.

[0034] Typically the apparatus includes:

5

a) a first signal delivery circuit coupled to a drive electrode attached to the biological subject, the first signal delivery circuit including:

10

i) a first buffer having:

- (1) a first buffer input for receiving a signal from the signal source; and,
- (2) a first buffer output for supplying the drive signal to the drive electrode; and,

15

ii) a second buffer having:

- (1) a second buffer input coupled to the first buffer output; and,
- (2) a second buffer output for providing a sensed signal indicative of the drive signal at the drive electrode;

20

b) a second signal delivery circuit coupled to a sense electrode attached to the biological subject, the second signal delivery circuit including.

i) a first buffer having:

25

- (1) a first buffer input coupled to ground; and,
- (2) a first buffer output coupled to the sense electrode; and,

ii) a second buffer having:

30

- (1) a second buffer input coupled to the first buffer output; and,
- (2) a second buffer output for providing a sensed signal indicative of a sensed voltage at the sense electrode.

Brief Description of the Drawings

35

[0035] The skilled person in the art will understand that the drawings, described below, are for illustration purposes only. The drawings are not intended to limit the scope of the applicants' teachings in any way.

[0036] An example of the present invention will now be described with reference to the accompanying drawings, in which: -

40

Figure 1 is a schematic diagram of a current multiplexing system;

Figure 2 is a schematic diagram of a current multiplexing system according to various embodiments of applicants' teachings;

Figure 3 is a schematic diagram of the current multiplexing system of Figure 2 showing additional components;

Figure 4 is a schematic diagram of the current multiplexing system of Figure 2 showing the current delivery circuit in greater detail;

45

Figure 5 is a schematic diagram of the current multiplexing system of Figure 4 showing additional components;

Figure 6 is a schematic diagram of the negative impedance of Figure 5.

Figure 7 is a schematic diagram of the current multiplexing system of Figure 5 showing the DC bias control and negative impedance in greater detail;

50

Figure 8 is a schematic diagram of the negative impedance of Figure 7;

Figure 9 is a schematic diagram of an example of an impedance measuring device; and,

Figure 10 is a flowchart of an example of a process for performing impedance measuring.

Detailed Description of the Preferred Embodiments

55

[0037] Electronic testing equipment or measuring apparatus may be electrically connected with a test subject through electrodes. These electrodes may be used to, for example, deliver currents and measure voltages at various points of contact between the test subject and the electrodes. An example of such test equipment or measuring apparatus can include medical equipment, in which case the test subject can be a biological subject such as a human patient.

[0038] Regardless of the type of application, a signal source, such as a current source may be used to deliver a drive signal, such as a current, to the electrodes. Often a single current source may be used for multiple electrodes by switching the currents to the various electrodes as needed. Figure 1 illustrates a current multiplexing system 100. Current multiplexing system 100 comprises a current source 102 coupled to the input of multiplexer 104. Each of the outputs of multiplexer 104 can in turn be coupled to a plurality of electrodes 106. For clarity Figure 1, only illustrates a single electrode. Each of electrodes 106 can be coupled to a patient 108.

[0039] Current source 102 is used to deliver a current I to the input of multiplexer 104. Multiplexer 104 is then used to switch the input current to a particular output and thereby to a particular electrode 106. However, multiplexer 104 can cause a large parasitic impedance 110 to appear at each of the outputs. Consequently, some of the current outputted by multiplexer 104 is lost to parasitic impedance 110 as a leakage current (ΔI). Therefore, only a portion ($I - \Delta I$) of the current produced by current source 102 reaches the electrode 106. The amount of current lost is proportional to the impedance of the interface between electrode 106 and patient 108. Each individual patient may have a different impedance associated with their skin and/or tissue. Consequently, the proportion of the total current that is lost to parasitic impedance 110 may differ with each individual patient. Accordingly, the proportion of total current delivered to the patient may also differ with each individual patient. Thus, with current multiplexing system 100 it can be difficult to deliver a precise amount of current to a patient 108 via an electrode 106.

[0040] Reference is now made to Figure 2, which illustrates various embodiments of current multiplexing system 200, according to various embodiments of applicants' teachings. Current multiplexing system 200 comprises a current source 202, one or more multiplexers 204, a plurality of electrodes 206 coupled to patient 208, one or more voltage multiplexers 212, and a plurality of current delivery circuits 220. Node 214, which is the output of multiplexer 212, can be used to obtain voltage measurements.

[0041] Each output of each multiplexer 204 can be connected to a current delivery circuit similar to current delivery circuit 220, which in turn can be connected to the inputs of multiplexer 212. For clarity, Figure 2 only illustrates a single connection to the output of multiplexer 204 and a single connection to multiplexer 212. The actual number of multiplexers 204, current delivery circuits 220, and multiplexers 212 used depends on such factors as the number electrodes 206 that are coupled to the patient, the number of outputs available on each multiplexer 204, and the number of inputs available on multiplexer 212.

[0042] In various embodiments according to applicants' teachings, current delivery circuit 220 receives a current I at node 222 and outputs a substantially equal current at node 224. In addition, in various embodiments, current delivery circuit 220 produces a voltage at node 226 that is substantially equal to the voltage at node 224. As was explained above, node 226 is coupled to voltage multiplexer 212. However, it should be understood that voltage measurements can be taken directly at node 226, which is the voltage output of delivery circuit 220. The use of voltage multiplexer 212 is optional and can be used to reduce the number of nodes to which voltage measurement equipment is to be connected to.

[0043] As will be described in greater detail herein, in various embodiments, current multiplexing system 200 can utilize a single controlled constant current source 202 to deliver a current that is multiplexed to numerous electrical loads, such as electrodes 206. In some embodiments, constant current source 202 delivers an AC current with a constant amplitude and phase, which may for example be, but not limited to, a sinusoid of fixed frequency.

[0044] In some embodiments, current multiplexing system 200 can deliver a current to a load that is substantially equal to the current outputted by 202. In various embodiments, current multiplexing system 200 can be utilized to deliver a controllable constant current to numerous locations and loads with a small transmission loss. In addition, in various embodiments, current multiplexing system 200 can be used without a calibration step prior to use. Furthermore, in various embodiments, the loads to which current multiplexing system 200 connects need not be altered in any manner in order to utilize current multiplexing system 200. In some embodiments, current delivery circuit 200 can be utilized with any appropriate equipment including but not limited to measuring apparatus such as medical instrumentation, biometric instrumentation, electrocardiograph equipment, impedance measuring apparatus, and circuit testing equipment.

[0045] In various embodiments, current delivery circuit 220 can be integrated on a single integrated circuit. In some embodiments, a plurality of current delivery circuit, such as delivery circuit 220 can be integrated on a single integrated circuit and packaged in a single chip. In some embodiments, one or more current multiplexers, such as multiplexer 204, a plurality of delivery circuits and one or more voltage multiplexers, such as multiplexer 212, can be integrated on a single integrated circuit and packaged in a single chip.

[0046] Reference is now made to Figure 3, which illustrates two current delivery circuits 220a and 220b of the current multiplexing system 200 of Figure 2. As was mentioned above with reference to Figure 2, in various embodiments, current multiplexing system 200 comprises a plurality of current delivery circuits 220 and a plurality of electrodes. Figure 2 illustrates only a single current delivery circuit and a single electrode for reasons of clarity. However, as mentioned above, in various embodiments, current multiplexing system 200 comprises at least two current delivery circuits and at least two electrodes, where one electrode can be a current delivery electrode and the second electrode can be a current return electrode.

[0047] Figure 3 illustrates two current delivery circuits and two electrodes. It should be understood however that a

greater number could be used. Nonetheless, in some embodiments, two current delivery circuits and two electrodes are sufficient. For example, but not limited to, electrode 206a could be used as a current delivery electrode and electrode 206b could be used as a current return electrode. In such embodiments, one of electrodes 206a and 206b could be used as a positive voltage measurement electrode and the other could be used as a negative voltage measurement electrode. The voltage at each of nodes 214a and 214b, which are the outputs of multiplexers 212a and 212b respectively, could be measured to obtain a differential voltage measurement between electrodes 206a and 206b. This may be referred to as a two point measurement given that two electrodes are used (for both current injection/return and for voltage measurement) and therefore there are two points of contact between the current multiplexing system and the patient.

[0048] Figure 3, shows the input of multiplexer 204b connected to ground. In various other embodiments used for a two point measurement, the input of multiplexer can be, for example but not limited to, connected to a second current source (not shown) that is complimentary to current source 202. More specifically, the second current source could have the second amplitude and opposite phase such that when current source 202 "pushes" current into patient 208 through electrode 206a, the second current source "pulls" current from the patient through electrode 206b. As will be apparent to those skilled in the art, this can provide a virtual ground in the patient.

[0049] In various other embodiments, a greater number of electrodes could be used for current injection/return and voltage measurement. For example, but not limited to, a four point measurement could be used. A four point measurement can use four electrodes, where one electrode is used as a current injection electrode, a second electrode could be used as a current return electrode, a third electrode could be used as a positive voltage measurement electrode, and a fourth electrode could be used as a negative voltage measurement electrode.

[0050] Referring back to Figure 3, electrode 206a could be used as a current injection electrode and electrode 206b could be used as voltage measurement electrode. Thus, it will be appreciated that in this example, the current delivery circuit 220b is actually acting to deliver a sensed voltage signal. It will be appreciated from this that the circuit can be more generally referred to as a signal delivery circuit. In this example, the apparatus of Figure 3 can be combined with a current return electrode and a second voltage measurement electrode so a four point measurement system would result, for example to allow tetrapolar impedance measurements to be performed.

[0051] In various embodiments, an AC current such as sinusoidal waveform with no DC offset can be used and therefore in such embodiments the application of the terms current injection and current return to an electrode is arbitrary. More specifically, in such an embodiment, a given electrode will be conducting current in one direction half of the time and conducting it in the other direction for the other half. For similar reasons; the application of the terms positive and negative voltage measurement to an electrode can also be arbitrary.

[0052] In addition, when a four point measurement is used, a more accurate voltage measurement may be obtained. Specifically, substantially no current will be moving through the voltage measurement electrodes and therefore the impedance of the electrodes and the interface between the electrode and patient will not significantly distort the voltage measurement.

[0053] Reference is now made to Figure 4, which a block diagram illustrating a portion of the current multiplexing system 200 of Figure 2 in greater detail. Multiplexer 204 causes a large parasitic impedance to appear at its outputs such as at node 222. Electrode 206 is coupled to the current delivery circuit at node 224. Node 226, which is the output of current delivery circuit 220 can be used to measure the voltage that appears at electrode 206. Optionally, node 226 can be connected to the input of a multiplexer, which may be useful when there are many electrodes 206 and current delivery circuits 220 being used.

[0054] The current delivery circuit 220 comprises a current buffer 430 and a voltage buffer 440. Current buffer 430 introduces parasitic impedance 438 to appear at node 224. In some embodiments, current buffer 430 can be a current conveyor as shown in Figure 4. The input 432 of current buffer 430 is coupled to node 222. The output 434 of current buffer 430 is coupled to node 224. If a current conveyor is used as the current buffer then its other input 436 can be connected to ground.

[0055] In various embodiments according to applicants' teachings, current buffer 430 is designed so as to have a low input impedance at input 432. Consequently, the leakage current (ΔI_1) lost to parasitic impedance 410 is minimal. In addition, current buffer 430 is designed so as to present only a small parasitic impedance to node 224. As a result most of the current that is outputted through output 434 passes through electrode 206 and only a minimal amount of leakage current (ΔI_2) is lost to parasitic impedance 438. In addition, in various embodiments, current buffer 430 is designed to have a high output impedance, which maximizes the amount of current delivered to the patient electrode. The combination of the above features can be achieved for example by implementing current buffer 430 as a current conveyor. However, in some other embodiments other appropriate current buffers with similar features can also be used.

[0056] In some embodiments, voltage buffer 440 can be selected to have a high input impedance so that the voltage at node 224 can be reproduced at node 226 without affecting the voltage at node 224. This allows for standardized non-invasive voltage measurements to be made at node 226.

[0057] In various embodiments, current multiplexing system 200 can be used without a calibration step even when the loads are changed. For example, a calibration step is not required when a electrodes 206 is coupled to a new patient.

In addition, in various embodiments, current multiplexing system 200 can be used without modifying or otherwise manipulating the patient electrode interface.

[0058] In various embodiments, current delivery circuit 220 can be integrated on a single integrated circuit. In some embodiments, a plurality of current delivery circuit 220 can be integrated on a single integrated circuit and packaged in a single chip.

[0059] It should be understood that in various embodiments any appropriate scheme could be used to switch or multiplex various inputs to each current injection circuit 220. Regardless of the switching or multiplexing scheme utilized a resulting parasitic capacitance 410 will result. Current buffer 430 isolates the electrode patient interface from interfering effects caused by the switches and their parasitic elements. Similarly, voltage buffer 440 isolates electrode 206 (and thereby the patient electrode interface) from interfering effects that may otherwise be caused by components beyond the voltage buffer 440.

[0060] Accordingly, in one example, the apparatus can be used to supply a drive signal to an electrode attached to the biological subject, and sense a signal at the electrode. Whilst the above example has focussed on the delivery of a current and measurement of a voltage, this is not essential, and the drive signal could be a voltage signal, with a current signal being measured. Alternatively, the signal delivery circuit could be used to measure the drive signal applied to the subject, allowing this to be used for example in calculating impedance measurements or the like. This may be performed to ensure that the magnitude and phase of the drive signal which is used in impedance calculations is as accurate as possible.

[0061] Accordingly, in general terms, the apparatus includes a signal delivery circuit including first and second buffers. The first buffer includes a first buffer input for receiving a signal from a signal source and a first buffer output for supplying a drive signal to an electrode attached to the biological subject. Similarly, the second buffer includes a second buffer input coupled to the first buffer output and a second buffer output for providing a sensed signal indicative of a signal at the electrode, to a sensor.

[0062] In one example, the first buffer is a current buffer and the second buffer a voltage buffer, allowing a drive current to be applied to the subject, and to allow a voltage at the electrode to be sensed. However, in alternative examples, a voltage signal may be applied to the subject and a current flow through the subject measured.

[0063] The signal delivery circuit allows a drive signal to be applied to the subject via an electrode and then a signal measured at the electrode. In one example, the measured signal is indicative of a signal, such as a potential, across the biological subject, with a single electrode is used as both a drive a sense electrode. However, this is not essential, and in another example, first and second current delivery circuits can be coupled to drive and sense electrodes respectively.

[0064] Accordingly, in one example, the first signal delivery circuit can include a first buffer having a first buffer input for receiving a signal from the signal source and a first buffer output for supplying the drive signal to the drive electrode and a second buffer having a second buffer input coupled to the first buffer output and a second buffer output for providing a sensed signal indicative of the drive signal at the drive electrode. This allows the magnitude of the drive signal injected into the biological subject to be measured, allowing this value to be used in performing impedance determination or the like. In this example, if the drive signal is a current signal, the second buffer is typically an amplifier having inputs in parallel with a resistor positioned between the first buffer output and the electrode, thereby allowing the current injected into the subject to be measured.

[0065] In this example, the second signal delivery circuit can include a first buffer having a first buffer input coupled to ground and a first buffer output coupled to the sense electrode and a second buffer having a second buffer input coupled to the first buffer output and a second buffer output for providing a sensed signal indicative of a signal at the sense electrode.

[0066] Reference is now made to Figure 5, which is a schematic diagram of the current multiplexing system of Figure 4 showing additional components. In various embodiments, current delivery circuit 200 can also comprise a DC offset control circuit 550. In some embodiments, DC offset control circuit 550 is coupled in a feedback loop of the current buffer 430. More specifically, DC offset control circuit 550 is connected between node 226 and node 222. In various embodiments, DC offset control circuit 550 is used to control the DC offset or DC bias at node 224. However, DC offset control circuit 550 is coupled to node 222 so as not to disturb the electrode-patient interface which exists between electrode 206 and patient 208. This use of DC offset control circuit 550 can increase the accuracy of the measurements made using current multiplexing system 200.

[0067] In various embodiments, current delivery circuit 200 can also comprise a negative impedance circuit 570. Negative impedance circuit 570 can be used to compensate for parasitic impedance 438 introduced by current buffer 430 or other circuit elements at, for example, node 224. Negative impedance circuit 570 comprises an amplifier 571 and a compensation impedance 591. In various embodiments, voltage amplifier 571 has a gain value greater than 1. Negative impedance circuit 570 can be used to provide a current to node 224 that is substantially equal to the leakage current (ΔI_2) that is lost from node 224 through parasitic impedance 438. The operation of negative impedance circuit 570 will be discussed in greater detail below.

[0068] It should be understood that the use of DC offset control circuit 550 is optional. It should also be understood that the use of negative impedance circuit 570 is optional. It should be further understood that DC offset control circuit 550 and negative impedance circuit 570 can be used independently of each other. Therefore, various embodiments can utilize either of one DC offset control circuit 550 and negative impedance circuit 570, both DC offset control circuit 550 and negative impedance circuit 570, or neither.

[0069] It should further be understood that in various embodiments, DC offset control circuit 550 and negative impedance circuit 570 can be integrated as part of current delivery circuit 220. In various other embodiments, either or both of DC offset control circuit 550 and negative impedance circuit 570 can be separate circuits. For example, but not limited to, in some embodiments, multiplexers could be used to couple either of these circuit to a particular current delivery circuit.

[0070] Reference is now made to Figure 6, which is a schematic diagram of a circuit 600 comprising a transmission channel 601, a parasitic impedance 438 shunting the transmission line, and a negative impedance circuit 570. Transmission channel 601 can, for example, correspond to node 224. Negative impedance circuit 570 comprises a voltage amplifier 571 and compensation impedance 591. The input of the amplifier 571 is coupled to the signal-transmission channel 601 and the output is coupled to one terminal of the compensation impedance 591. The other terminal of the compensation impedance is coupled to the signal-transmission channel.

[0071] Signal-transmission channel 601 may be used to transmit a current to a load (not shown), which may be any suitable circuit or circuit component, such as for example an electrode. The presence of a signal on signal-transmission channel 601 causes a voltage to appear across parasitic impedance 438. This causes a leakage current $I_{leakage}$ to flow through the parasitic impedance 438. The magnitude of the current flowing through parasitic impedance 438 depends on the value of the impedance as well as the magnitude of the voltage appearing across its terminals.

[0072] Amplifier 571 amplifies the signal appearing on the signal-transmission channel 601. In various embodiments, amplifier 571 has a gain that is greater than 1. This causes a voltage to appear across compensation impedance 591 and a current I_{comp} to flow through compensation impedance 591.

[0073] In various embodiments, the gain of amplifier 571 and the value of the compensation impedance is selected such that the current that flows through parasitic impedance 438 is compensated for by the current that flows through compensation impedance 591. Specifically, given a signal voltage of V_{signal} , a parasitic impedance of Z_{para} , the leakage current can be said to be:

$$I_{leakage} = V_{signal} \times \left(\frac{1}{Z_{para}} \right) \quad \text{Equation (1)}$$

[0074] Similarly, given a compensation impedance of Z_{comp} and an amplifier gain of G, the compensation current flowing through the compensation current may be said to be:

$$I_{comp} = V_{signal} \times (G - 1) \times \left(\frac{1}{Z_{comp}} \right) \quad \text{Equation (2)}$$

[0075] Equating equation (1) and equation (2) yields the following:

$$I_{comp} = I_{leakage}$$

$$\left(\frac{G - 1}{Z_{comp}} \right) = \frac{1}{Z_{para}} \quad \text{Equation (3)}$$

[0076] Thus, by selecting G and Z_{comp} to satisfy equation (3) the compensation current will exactly match the leakage current. The compensation impedance 591 effectively serves as a negative impedance that cancels the effect of the parasitic impedance 438.

[0077] In various embodiments, the value of the parasitic impedance may not be known and therefore it may not be possible to select a gain for the amplifier by simply using equation (3) above. In such embodiments, the value of the gain can be estimated by using circuit 600 of FIG. 6. Specifically, circuit 600 is implemented by selecting a compensation impedance and range of values of gain. The circuit is operated at the various values of gain and the output is monitored. For those values of gain that exceed the required value the output would oscillate. Thus, the correct value of the gain

lies in a range of values that is bounded by (1) the lowest known value of the gain at which the output oscillates and (2) the highest known value of the gain at which the output does not oscillate. This process may be continued in an iterative manner until a suitable value of gain is selected. Once an appropriate value of gain is determined, the parasitic impedance may be estimated by using equation (3) given above.

[0078] In various embodiments, the parasitic impedance may be comprised of both capacitive and resistive elements. However, in some embodiments the effect of the capacitive loading can be significantly greater than the effect of the resistive loading. In such cases, various embodiments of applicants' teachings may be used to address the capacitive loading and not the resistive loading. Alternatively, applicants' teachings may be used to partially compensate for any portion of the parasitic impedance. Thus, in various embodiments, circuits according to applicants' teachings may be used to reduce and partially compensate for any leakage currents that may flow through any parasitic impedances coupled to a signal-transmission channel, but not necessarily to completely compensate for all the current that is lost due to leakage currents.

[0079] Alternatively, the parasitic impedance may be measured or estimated according to known techniques. The value of the parasitic impedance obtained from this may then be used to select initial values for the compensation impedance and the range of values of gain. The gain can then be fine tuned according to the above-described method.

[0080] Reference is now made to Figure 7, which is a schematic diagram of the current multiplexing system of Figure 5, showing the DC bias control and negative impedance in greater detail. In various embodiments, voltage buffer 440 comprises an operational amplifier 742 connected as an output follower. More specifically, non-inverting input 744 is coupled to node 224; while, inverting node 746 and output 748 are coupled to node 226.

[0081] In various embodiments, negative impedance circuit 570 comprises an operational amplifier 772 with non-inverting input 774, inverting input 776 and output 778. Resistor 780 is connected between node 226 and non-inverting input 774. Resistor 782 is coupled between inverting input 776 and ground. One terminal of resistor 784 is coupled to output 778 and the other terminal of resistor 784 is coupled to resistor 786. Capacitor 788 and resistor 790 are each coupled between non-inverting input 776 and the common terminal of resistors 784 and 786. Capacitor 792 and resistor 794 are coupled between node 224 and resistor 786. Negative impedance circuit will be discussed in greater detail below.

[0082] In some embodiments DC-offset control circuit 550 comprises an operational amplifier 752 connected as an integrator. Specifically, operational amplifier 752 has non-inverting input 754, inverting input 756 and output 758. Capacitor 760 is connected between inverting input 756 and output 758. Resistor 762 is connected between inverting input 756 and node 226. Resistor 764 is connected between the non-inverting input 754 and ground. Resistor 766 is connected between output 758 and node 222.

[0083] Reference is now made to Figure 8, which is a schematic diagram of negative impedance circuit 570 of Figure 7. For greater clarity Figure 8 illustrates negative impedance circuit 570 apart from the rest of current multiplexing system 200.

[0084] Negative impedance circuit 570 comprises an amplifier portion 571 having an operational amplifier 772 with a non-inverting input 774, an inverting input 776, an output node 778. Operational amplifier 772 also comprises power rails 895 and 896.

[0085] Referring again to the amplifier portion 571, amplifier portion 571 further comprises an input balancing portion 897, a gain control portion 898, and a stability control portion 899. Input balancing portion 897 comprises resistor 780, which is connected between node 226 and non-inverting input 774. Gain control portion 898 comprises resistor 782 and resistor 790. By adjusting the values of resistors 782 and 790, one is able to adjust the gain G of the overall amplifier portion 771. In various embodiments, the values of resistors 782 and 790 may be set to a value that is greater than 1. Stability control portion 899 comprises capacitor 788, resistor 784, and resistor 794. By adjusting the values of capacitor 788, resistor 784, and resistor 794 one is able to alter the stability of the overall amplifier circuit.

[0086] In various embodiments, negative impedance circuit 570 also comprises compensation impedance 591. Compensation impedance 591 is in turn comprised of resistor 794 and capacitor 792, both of which are connected between node 224 and stability control portion 899. Compensation impedance 591 is used to compensate for parasitic impedance 438 of Figure 7. By adjusting gain control portion 898 and compensation impedance 591, one may adjust the compensation current that is provided to the signal-transmission channel, and thereby match the compensation current magnitude to the magnitude of the leakage current. This may be done according to equation (3) given above.

[0087] Whilst the above examples have focussed on the use of a current source, this is not essential, and alternatively the system may use a voltage source, with the generated voltage being used to inject a drive signal in the form of a current into a subject, with the magnitude of the drive signal being measured using a sensor at node 214.

[0088] From this, it will be appreciated that the current delivery circuit 220 can be referred to more generally as a signal delivery circuit. Similarly, the current and voltage buffers can be first and second buffers for supplying a drive signal to an electrode attached to the biological subject, and for providing a signal indicative of a signal at the electrode.

[0089] As mentioned above, the signal delivery circuit can be used in a variety of different systems. In one example, the signal delivery circuit can be incorporated into apparatus suitable for performing an analysis of a subject's bioelectric impedance, an example of which will now be described with reference to Figure 9.

[0090] As shown the apparatus includes a measuring device 900 including a processing system 902, connected to one or more signal generators 917A, 917B, via respective first leads 923A, 923B, and to one or more sensors 918A, 918B, via respective second leads 925A, 925B.

5 **[0091]** In use, the signal generators 917A, 917B are coupled to two first electrodes 913A, 913B, via drive signal delivery circuits 919A, 919B, which therefore act as drive electrodes to allow signals to be applied to the subject S, whilst the one or more sensors 918A, 918B are coupled to the second electrodes 915A, 915B, via sensed signal delivery circuits 920A, 920B, which act as sense electrodes, allowing signals across the subject S to be sensed. It will be appreciated that the drive and sensed signal delivery circuits are similar to the delivery circuits described above in Figures 1 to 8.

10 **[0092]** In one example, a single signal generator 917 may be provided, coupled to the drive signal delivery circuits 919A, 919B and hence the drive electrodes 913A, 913B, via multiplexers 204a from the example of Figure 3. Similarly a single sensor 918 can be coupled to the sensed signal delivery circuits 920A, 920B and hence the sense electrodes 915A, 915B, via multiplexers, such as the multiplexers 212b from the example of Figure 3..

15 **[0093]** However, this is not essential, and alternatively first and second signal generators 917A, 917B and sensors 918A, 918B can be used, each being coupled to the corresponding electrodes 913A, 913B, 914A, 914B via respective signal delivery circuits. This is particularly useful if the arrangement is used to perform balancing, as will be described in more detail below.

20 **[0094]** Accordingly, this provides apparatus for use in performing impedance measurements on a subject which includes a signal source for applying a signal to a subject, a sensor for sensing signals from the subject, a processing system for controlling the signal source and receiving signals from the sensor and at least one signal delivery circuit, including a first buffer having: a first buffer input for receiving a signal from a signal source and a first buffer output for supplying a drive signal to an electrode attached to the biological subject and a second buffer having a second buffer input coupled to the first buffer output and a second buffer output for providing a sensed signal indicative of a signal at the electrode, to a sensor.

25 **[0095]** In one example, at least one signal delivery circuit is used for supplying a current to a drive electrode attached to the biological subject and at least one signal delivery circuit for providing a voltage signal indicative of a voltage at a sense electrode.

[0096] Additional features of the impedance measurement apparatus will now be described.

30 **[0097]** The signal generators 917A, 917B and the sensors 918A, 918B may be provided at any position between the processing system 902 and the electrodes 913A, 913B, 915A, 915B, and may be integrated into the measuring device 900. However, in one example, the signal generators 917A, 917B and the sensors 918A, 918B are integrated into an electrode system, or another unit provided near the subject S, with the leads 923A, 923B, 925A, 925B connecting the signal generators 917A, 917B and the sensors 918A, 918B to the processing system 902.

35 **[0098]** It will be appreciated that the above described system is a two channel device, used to perform a classical four-terminal impedance measurement, with each channel being designated by the suffixes A, B respectively. The use of a two channel device is for the purpose of example only, as will be described in more detail below.

40 **[0099]** An optional external interface 903 can be used to couple the measuring device 900, via wired, wireless or network connections, to one or more peripheral devices 904, such as an external database or computer system, barcode scanner, or the like. The processing system 902 will also typically include an I/O device 905, which may be of any suitable form such as a touch screen, a keypad and display, or the like.

45 **[0100]** In use, the processing system 902 is adapted to generate control signals, which cause the signal generators 917A, 917B to generate one or more alternating signals, such as voltage or current signals of an appropriate waveform, which can be applied to a subject S, via the first electrodes 913A, 913B. The sensors 918A, 918B then determine the voltage across or current through the subject S, using the second electrodes 915A, 915B and transfer appropriate signals to the processing system 902, for analysis. In the event that the apparatus includes multiplexers for coupling signal generators or sensors to respective signal delivery circuits, the processing system would also typically act to control the multiplexers allowing signals to be delivered to and measured across the subject as required.

50 **[0101]** Accordingly, it will be appreciated that the processing system 902 may be any form of processing system which is suitable for generating appropriate control signals and at least partially interpreting the measured signals to thereby determine the subject's bioelectrical impedance, and optionally determine other information such as relative fluid levels, or the presence, absence or degree of conditions, such as oedema, lymphoedema, measures of body composition, cardiac function, or the like.

55 **[0102]** The processing system 902 may therefore be a suitably programmed computer system, such as a laptop, desktop, PDA, smart phone or the like. Alternatively the processing system 902 may be formed from specialised hardware, such as an FPGA (field programmable gate array), or a combination of a programmed computer system and specialised hardware, or the like, as will be described in more detail below.

[0103] In use, the first electrodes 913A, 913B are positioned on the subject to allow one or more signals to be injected into the subject S. The location of the first electrodes will depend on the segment of the subject S under study. Thus, for example, the first electrodes 913A, 913B can be placed on the thoracic and neck region of the subject S to allow the

impedance of the chest cavity to be determined for use in cardiac function analysis. Alternatively, positioning electrodes on the wrist and ankles of a subject allows the impedance of limbs and/or the entire body to be determined, for use in oedema analysis, or the like.

5 [0104] Once the electrodes are positioned, one or more alternating signals are applied to the subject S, via the first leads 923A, 923B and the first electrodes 913A, 913B. The nature of the alternating signal will vary depending on the nature of the measuring device and the subsequent analysis being performed.

[0105] For example, the system can use Bioimpedance Analysis (BIA) in which a single low frequency signal (typically < 50 kHz) is injected into the subject S, with the measured impedance being used directly in the assessment of relative intracellular and extracellular fluid levels. In contrast Bioimpedance Spectroscopy (BIS) devices utilise frequencies ranging from very low frequencies (4 kHz) to higher frequencies (1000 kHz), and can use as many as 256 or more different frequencies within this range, to allow multiple impedance measurements to be made within this range.

10 [0106] Thus, the measuring device 900 may either apply an alternating signal at a single frequency, at a plurality of frequencies simultaneously, or a number of alternating signals at different frequencies sequentially, depending on the preferred implementation. The frequency or frequency range of the applied signals may also depend on the analysis being performed.

[0107] In one example, the applied signal is generated by a voltage generator, which applies an alternating voltage to the subject S, although alternatively current signals may be applied. In one example, the voltage source is typically symmetrically arranged, with each of the signal generators 917A, 917B being independently controllable, to allow the signal voltage across the subject to be varied.

20 [0108] A voltage difference and/or current is measured between the second electrodes 915A, 915B. In one example, the voltage is measured differentially, meaning that each sensor 918A, 918B is used to measure the voltage at each second electrode 915A, 915B and therefore need only measure half of the voltage as compared to a single ended system.

[0109] The acquired signal and the measured signal will be a superposition of voltages generated by the human body, such as the ECG (electrocardiogram), voltages generated by the applied signal, and other signals caused by environmental electromagnetic interference. Accordingly, filtering or other suitable analysis may be employed to remove unwanted components.

25 [0110] The acquired signal is typically demodulated to obtain the impedance of the system at the applied frequencies. One suitable method for demodulation of superposed frequencies is to use a Fast Fourier Transform (FFT) algorithm to transform the time domain data to the frequency domain. This is typically used when the applied current signal is a superposition of applied frequencies. Another technique not requiring windowing of the measured signal is a sliding window FFT.

30 [0111] In the event that the applied current signals are formed from a sweep of different frequencies, then it is more typical to use a signal processing technique such as multiplying the measured signal with a reference sine wave and cosine wave derived from the signal generator, or with measured sine and cosine waves, and integrating over a whole number of cycles. This process, known variously as quadrature demodulation or synchronous detection, rejects all uncorrelated or asynchronous signals and significantly reduces random noise.

35 [0112] Other suitable digital and analogue demodulation techniques will be known to persons skilled in the field.

[0113] In the case of BIS, impedance or admittance measurements are determined from the signals at each frequency by comparing the recorded voltage and the current through the subject. The demodulation algorithm can then produce amplitude and phase signals at each frequency.

40 [0114] As part of the above described process, the distance between the second electrodes 915A, 915B may be measured and recorded. Similarly, other parameters relating to the subject may be recorded, such as the height, weight, age, sex, health status, any interventions and the date and time on which they occurred. Other information, such as current medication, may also be recorded. This can then be used in performing further analysis of the impedance measurements, so as to allow determination of the presence, absence or degree of oedema, to assess body composition, or the like.

45 [0115] The accuracy of the measurement of impedance can be subject to a number of external factors. These can include, for example, the effect of capacitive coupling between the subject and the surrounding environment, the leads and the subject, the electrodes, or the like, which will vary based on factors such as lead construction, lead configuration, subject position, or the like. Additionally, there are typically variations in the impedance of the electrical connection between the electrode surface and the skin (known as the "electrode impedance"), which can depend on factors such as skin moisture levels, melatonin levels, or the like. A further source of error is the presence of inductive coupling between different electrical conductors within the leads, or between the leads themselves.

50 [0116] Such external factors can lead to inaccuracies in the measurement process and subsequent analysis and accordingly, it is desirable to be able to reduce the impact of external factors on the measurement process.

55 [0117] One form of inaccuracy that can arise is caused by the voltages across the subject being unsymmetrical, a situation referred to as an "imbalance". Such a situation results in a significant signal voltage at the subject's body centre, which in turn results in stray currents arising from parasitic capacitances between the subject's torso and the support

surface on which the subject is provided.

[0118] The presence of an imbalance, where the voltage across the subject is not symmetrical with respect to the effective centre of the subject, leads to a "common mode" signal, which is effectively a measure of the signal at the subject S that is unrelated to the subject's impedance.

5 **[0119]** To help reduce this effect, it is therefore desirable for signals to be applied to the subject S that they result in a symmetrical voltage about the subject's body centre. As a result, a reference voltage within the subject S, which is equal to a reference voltage of the measurement apparatus, will be close to the effective body centre of the subject, as considered relative to the electrode placement. As the measuring device reference voltage is typically ground, this results in the body centre of the subject S being as close to ground as possible, which minimises the overall signal magnitude
10 across the subject's torso, thereby minimising stray currents.

[0120] In one example, a symmetrical voltage about the sensing electrodes can be achieved by using a symmetrical voltage source, such as a differential bidirectional voltage drive scheme, which applies a symmetrical voltage to each of the drive electrodes 913A, 913B. However, this is not always effective if the contact impedances for the two drive electrodes 913A, 913B are unmatched, or if the impedance of the subject S varies along the length of the subject S,
15 which is typical in a practical environment.

[0121] In one example, the apparatus overcomes this by adjusting the differential voltage drive signals applied to each of the drive electrodes 913A, 913B, to compensate for the different electrode impedances, and thereby restore the desired symmetry of the voltages across the subject S. This process is referred to herein as *balancing* and in one example, helps reduce the magnitude of the common mode signal, and hence reduce current losses caused by parasitic
20 capacitances associated with the subject.

[0122] The degree of imbalance, and hence the amount of balancing required, can be determined by monitoring the signals at the sense electrodes 915A, 915B, and then using these signals to control the signal applied to the subject via the drive electrodes 913A, 913B. In particular, the degree of imbalance can be calculated by determining an additive voltage from the voltages detected at the sense electrodes 915A, 915B.

25 **[0123]** In one example process, the voltages sensed at each of the sense electrodes 915A, 915B are used to calculate a first voltage, which is achieved by combining or adding the measured voltages. Thus, the first voltage can be an additive voltage (commonly referred to as a common mode voltage or signal) which can be determined using a differential amplifier.

[0124] In this regard, a differential amplifier is typically used to combine two sensed voltage signals V_a , V_b , to determine a second voltage, which in one example is a voltage differential $V_a - V_b$ across the points of interest on the subject S. The voltage differential is used in conjunction with a measurement of the current flow through the subject to derive impedance
30 values.

[0125] However, differential amplifiers typically also provide a "common mode" signal $(V_a + V_b)/2$, which is a measure of the common mode signal.

35 **[0126]** Whilst differential amplifiers include a common mode rejection capability, this is generally of only finite effect and typically reduces in effectiveness at higher frequencies, so a large common mode signal will produce an error signal superimposed on the differential signal.

[0127] The error caused by common mode signals can be minimised by calibration of each sensing channel. In the ideal case where both inputs of a differential amplifier are perfectly matched in gain and phase characteristics and behave linearly with signal amplitude, the common mode error will be zero. In one example, the two sensing channels of the
40 differential amplifier are digitised before differential processing. It is therefore straightforward to apply calibration factors independently to each channel to allow the characteristics to be matched to a high degree of accuracy, thereby achieving a low common mode error.

[0128] Accordingly, by determining the common mode signal, the applied voltage signals can be adjusted, for example by adjusting the relative magnitude and/or phase of the applied signals, to thereby minimise the common mode signal
45 and substantially eliminate any imbalance.

[0129] An example of the operation of the apparatus of Figure 9 to perform this will now be described with reference to Figure 10.

[0130] At step 1000, a first signal is applied to the subject S, with a second signal measured across the subject S being determined at step 1010. This will typically be achieved using the techniques outlined above. Accordingly, the
50 processing system 902 will cause the signal generators 917A, 917B to generate the first signal, which is typically applied to the subject S via the first electrodes 913A, 913B. Similarly the second signal will be sensed by the sensors 918A, 918B, via the second electrodes 915A, 915B, with an indication of the second signal being provided to the processing system 902.

[0131] At step 1020, an imbalance is determined by the processing system 902 using the second signal sensed at the second electrodes 915A, 915B, which in one example represents a common mode signal.

55 **[0132]** At step 1030, the measuring device optionally adjusts the first signal applied to the subject S, so as to reduce the imbalance and hence the magnitude of the common mode signal. Thus, the magnitude of the signal applied at either one of the first electrodes 913A, 913B can be adjusted, for example by increasing or decreasing the relative signal

magnitudes and/or altering the relative signal phases, so as to balance the signal within the subject and centralise the position of the reference voltage within the subject relative to the electrode positioning.

[0133] At step 1040, the measuring device can then determine the signal applied to the subject and the voltages measured at the electrodes 913A, 913B, thereby allowing an impedance to be determined at step 1050.

[0134] As the position of the reference voltage within the subject S is impedance dependent, the imbalance will typically vary depending on the frequency of the applied signal. Accordingly, in one example, it is typical to determine the imbalance and adjust the applied signal at each applied frequency. However, this may depend on the preferred implementation.

[0135] An example of balancing procedure and operation of an impedance measuring device is described in more detail in the copending patent application number WO2009/059351, and this will not therefore be described in any further detail herein.

[0136] In various examples, applicants' teachings relate to a current delivery circuit. In various examples, the current delivery circuit comprises an input, a current output and a voltage output. In some examples, the current delivery circuit accepts a current at its input and produces a proportional output current at the current output. In various examples, current delivery circuit produces an output voltage signal at the voltage output that is proportional to an input voltage signal appearing at the current delivery circuit current output.

[0137] In various examples according to applicants' teachings, the current delivery circuit comprises a current buffer and a voltage buffer. The current buffer and voltage buffer each have an input and an output. The current delivery circuit input is coupled to the current buffer input. The current buffer output is coupled to the current delivery circuit current output. The voltage buffer input is coupled to the current delivery circuit current output. The voltage buffer output is coupled to the current delivery circuit voltage output.

[0138] In some examples, the output current is substantially equal to the input current. In various examples, the output voltage signal is substantially equal to the input voltage signal.

[0139] In some examples, the current buffer is a current conveyor. In various examples, the voltage buffer is a voltage follower.

[0140] In various examples, the current delivery circuit further comprises a parasitic impedance coupled to the current buffer output. In some examples, the current delivery circuit further comprises a negative impedance coupled between the voltage buffer output and the current buffer output for compensating for the parasitic impedance. In some examples, the negative impedance comprises: a compensation impedance having a compensation impedance value, a first terminal and a second terminal, the first terminal coupled to the voltage buffer input; a compensation amplifier having a compensation amplifier input, a compensation amplifier output and a gain, the compensation amplifier input coupled to the voltage buffer output, the compensation amplifier output coupled to the second terminal of the compensation impedance to provide a compensation current to flow through the impedance, and the gain and the compensation impedance values are selected based on the parasitic impedance value so that the compensation current has a magnitude substantially equal to the leakage current magnitude.

[0141] In various examples, current delivery circuit further comprises a DC offset control circuit coupled between the voltage buffer output and the current buffer input. In some examples according to applicants' teachings, the DC offset control comprises an integrator coupled between the voltage buffer output and the current buffer input.

[0142] In various examples, applicants' teachings relate to a current multiplexing circuit comprising one or more current multiplexers, each having an input and a plurality of outputs, and one or more current delivery circuits. In various examples, the outputs of the one or more current multiplexers are coupled to the input of each of the one or more current delivery circuits. In some examples, the current multiplexing circuit further comprises one or more voltage multiplexers. The voltage output of each of the one or more current delivery circuits is coupled to an input of the one or more voltage multiplexers.

[0143] In various examples, the circuit further comprises one or more current sources. In various examples, each current source is coupled to the input of the one or more current multiplexers.

[0144] In various examples, applicants' teachings relate to a current multiplexing system. In various examples, current multiplexing system comprises a first current delivery circuit and a second current delivery circuit. Current multiplexing system further comprises a first electrode coupled to the first current delivery circuit current output and a second electrode coupled to the second current delivery circuit current output.

[0145] In various examples, the voltage output of the first current delivery circuit is coupled to an input of a first voltage multiplexer and the voltage output of the second current delivery circuit is coupled to an input of a second voltage multiplexer. In various examples, the outputs of the first and second voltage multiplexers are adapted to provide first and second voltage measurement signals for allowing a differential voltage measurement.

[0146] In some examples, a first current source is coupled to the input of the first current delivery circuit. In some examples, the first current source is controllable to provide a constant alternating current. In some examples, the constant alternating current has a constant amplitude and constant phase. In various examples, the amplitude and phase are controllably variable.

[0147] In some examples, the input of the second current delivery circuit is coupled to ground. In various other examples,

the input of the second current delivery circuit is coupled to a second current source. In various examples the second current source is complimentary to the first current source. As used herein, the term complimentary current source refers to a current source providing a current of equal magnitude with a 180° phase shift.

[0148] In some examples, the current multiplexing system further comprises one or more current multiplexers. Each current multiplexer has a first output coupled to the first current delivery circuit and a second output coupled to the second current delivery circuit. In some examples, the input of at least one of the current multiplexers is coupled to a first current source. In some examples, the input of at least one of the current multiplexers is coupled to a second current source. In some examples, the input of at least one of the current multiplexers is coupled to ground.

[0149] In some examples, the current multiplexing system further comprises a third and fourth current delivery circuit as well as a third and fourth electrode. The third electrode is coupled to the third current delivery circuit current output. The fourth electrode is coupled to the fourth current delivery circuit current output.

[0150] In some examples, the third current delivery circuit voltage output is coupled a first voltage multiplexer and the fourth current delivery circuit voltage output is coupled a second voltage multiplexer. In various examples, the outputs of the first and second voltage multiplexers are adapted to provide first and second voltage measurement signals for allowing a differential voltage measurement.

[0151] In some examples, the third and fourth current delivery circuit inputs are coupled to ground.

[0152] In some examples of applicants' teachings, current multiplexing system comprises a current source, a current multiplexer, a current delivery circuit, an electrode, and a voltage multiplexer. The current source is coupled to an input of the current multiplexer. An output of the current multiplexer is coupled to the input of the current delivery circuits. A current output of the current delivery circuit is coupled to the electrode. A voltage output of the current delivery circuit is coupled to an input of the voltage multiplexer. In various examples the current multiplexing system further comprises an electrode coupled to the current output of the current delivery circuit.

[0153] Persons skilled in the art will appreciate that numerous variations and modifications will become apparent. All such variations and modifications which become apparent to persons skilled in the art, should be considered to fall within the scope that the invention broadly appearing before described.

[0154] Features from different examples above may be used interchangeably or in conjunction, where appropriate. Thus, for example, a range of different techniques are described for minimising errors and these can be used independently of each other, or in conjunction, depending on the particular implementation.

[0155] Furthermore, whilst the above examples have focussed on a biological subject such as a human, it will be appreciated that the measuring device and techniques described above can be used with any animal, including but not limited to, primates, livestock, performance animals, such as race horses, or the like.

[0156] The above described processes can be used for diagnosing the presence, absence or degree of a range of conditions and illnesses, including, but not limited to oedema, lymphoedema, body composition, or the like.

Claims

1. Apparatus (200) for electrically connecting a measurement apparatus to a biological subject (208), the apparatus including a signal delivery circuit (220) including:

a) a current buffer (430) having:

i) a current buffer input (432) for receiving a signal from a signal source (222); and,

ii) a current buffer output (434) for supplying a current to an electrode (206) attached to the biological subject (208); and, **characterised in that** the apparatus (200) further including:

b) a voltage buffer (440) having:

i) a voltage buffer input (224) coupled to the current buffer output (434); and,

ii) a voltage buffer output (226) for providing a voltage signal indicative of a voltage at the electrode (206).

2. Apparatus according to claim 1, wherein the current buffer is a current conveyor.

3. Apparatus according to claim 1 or claim 2, wherein the voltage buffer is an amplifier connected as an output follower.

4. Apparatus according to any one of the claims 1 to 3, wherein the apparatus includes an offset control circuit (550) coupled between the voltage buffer output (226) and the current buffer input (222), the offset control circuit (550) being used to control a DC offset at the electrode (206).

5. Apparatus according to claim 4, wherein the offset control circuit (550) includes an integrator coupled between the voltage buffer output (226) and the current buffer input (222).
6. Apparatus according to any one of the claims 1 to 5, wherein the signal delivery circuit (220) includes a negative impedance circuit (570) coupled between the voltage buffer output (226) and the current buffer output (434), wherein the negative impedance circuit (570) includes a negative impedance circuit amplifier (571) and a compensation impedance (591), and wherein at least one of a gain of the negative impedance circuit amplifier (571) and a value of the compensation impedance (591) is selected to compensate for parasitic impedance losses.
7. Apparatus according to claim 6, wherein the negative impedance circuit (570) includes:
- a) a compensation impedance (591) having a compensation impedance value, a first terminal and a second terminal, the first terminal coupled to the current buffer output (434); and,
 - b) a compensation amplifier (571) having a compensation amplifier input, a compensation amplifier output and a gain, the compensation amplifier (571) input coupled to the voltage buffer output (226), the compensation amplifier output coupled to the second terminal of the compensation impedance (591) to provide a compensation current to flow through the impedance (591), and the gain and the compensation impedance (591) values are selected based on the parasitic impedance value so that the compensation current has a magnitude substantially equal to the leakage current magnitude.
8. Apparatus according to any one of the claims 1 to 7, wherein the apparatus (200) includes:
- a) a plurality of signal delivery circuits (220), each signal delivery circuit (220) being for supplying a drive current to a respective electrode (206) attached to the biological subject (208);
 - b) at least one signal source (202); and,
 - c) at least one first multiplexer (204) for selectively connecting the signal source (202) to one of the plurality of signal delivery circuits (220) to thereby apply a drive current to the biological subject (208) via the respective electrode (206).
9. Apparatus according to any one of the claims 1 to 8, wherein the apparatus (200) includes:
- a) a plurality of signal delivery circuits (220), each signal delivery circuit (220) being for providing a voltage signal indicative of a voltage at the electrode (206), to a sensor;
 - b) at least one sensor; and,
 - c) at least one second multiplexer (212) for selectively connecting the at least one sensor to one of the plurality of signal delivery circuits (220) to thereby allow the sensor to sense the voltage signal indicative of a voltage at the respective electrode (206).
10. Apparatus according to any one of the claims 1 to 9, wherein the apparatus (200) includes first and second signal sources (202) for generating respective first and second drive signals, the first and second signal sources being coupled to respective signal delivery circuits (220), wherein the first and second signal sources (202) are for generating at least one of:
- a) complementary signals;
 - b) signals having a constant amplitude and phase; and,
 - c) signals having a controlled amplitude and phase.
11. Apparatus according to any one of the claims 1 to 10, wherein the apparatus (200) includes:
- a) at least one signal delivery circuit (220) for supplying a current to a drive electrode (206a) attached to the biological subject; and,
 - b) at least one signal delivery circuit (220) for providing a voltage signal indicative of a voltage at a sense electrode (206b).

Patentansprüche

1. Vorrichtung (200) zum elektrischen Anschließen einer Messvorrichtung an ein biologisches Subjekt (208), wobei

die Vorrichtung eine Signalabgabeschaltung (220) umfasst, die umfasst:

a) einen Strompuffer (430) aufweisend:

- i) einen Strompuffereingang (432) zum Aufnehmen eines Signals von einer Signalquelle (222); und
- ii) einen Strompufferausgang (434) zum Zuführen eines Stroms zu einer Elektrode (206), die an dem biologischen Subjekt (208) befestigt ist; und

dadurch gekennzeichnet, dass die Vorrichtung (200) ferner umfasst:

b) einen Spannungspuffer (440) aufweisend:

- i) einen Spannungspuffereingang (224), der an den Strompufferausgang (434) gekoppelt ist; und
- ii) einen Spannungspufferausgang (226) zum Bereitstellen eines Spannungssignals, das für eine Spannung an der Elektrode (206) indikativ ist.

2. Vorrichtung gemäß Anspruch 1, wobei der Strompuffer eine Stromzufuhrschaltung ist.
3. Vorrichtung gemäß Anspruch 1 oder Anspruch 2, wobei der Spannungspuffer ein als Ausgabefolger angeschlossener Verstärker ist.
4. Vorrichtung gemäß einem der Ansprüche 1 bis 3, wobei die Vorrichtung eine Offset-Steuerschaltung (550) umfasst, die zwischen den Spannungspufferausgang (226) und den Strompuffereingang (222) gekoppelt ist, wobei die Offset-Steuerschaltung (550) zum Steuern eines DC-Offsets an der Elektrode (206) verwendet wird.
5. Vorrichtung gemäß Anspruch 4, wobei die Offset-Steuerschaltung (550) einen Integrator umfasst, der zwischen den Spannungspufferausgang (226) und den Strompuffereingang (222) gekoppelt ist.
6. Vorrichtung gemäß einem der Ansprüche 1 bis 5, wobei die Signalabgabeschaltung (220) eine Schaltung mit negativer Impedanz (570) umfasst, die zwischen den Spannungspufferausgang (226) und den Strompufferausgang (434) gekoppelt ist, wobei die Schaltung mit negativer Impedanz (570) eine Verstärkerschaltung mit negativer Impedanz (571) und eine Kompensationsimpedanz (591) umfasst und wobei wenigstens eines von der Verstärkung der Verstärkerschaltung mit negativer Impedanz (571) und einem Wert der Kompensationsimpedanz (591) ausgewählt ist, um parasitäre Impedanzverluste zu kompensieren.
7. Vorrichtung gemäß Anspruch 6, wobei die Schaltung mit negativer Impedanz (570) umfasst:
 - a) eine Kompensationsimpedanz (591) mit einem Kompensationsimpedanzwert, einem ersten Ende und einem zweiten Ende, wobei das erste Ende an den Strompufferausgang (434) gekoppelt ist; und
 - b) einen Kompensationsverstärker (571) mit einem Kompensationsverstärker-Eingang, einem Kompensationsverstärker-Ausgang und einer Verstärkung, wobei der Kompensationsverstärker(571)-Eingang an den Spannungspufferausgang (226) gekoppelt ist, der Kompensationsverstärker-Ausgang an das zweite Ende der Kompensationsimpedanz (591) gekoppelt ist, um einen Kompensationsstrom bereitzustellen, der durch die Impedanz (591) fließt, und die Werte von Verstärkung und Kompensationsimpedanz (591) auf der Grundlage des parasitären Impedanzwerts ausgewählt sind, so dass der Kompensationsstrom eine Höhe aufweist, die im Wesentlichen gleich der Höhe des Leckstroms ist.
8. Vorrichtung gemäß einem der Ansprüche 1 bis 7, wobei die Vorrichtung (200) umfasst:
 - a) eine Vielzahl von Signalabgabeschaltungen (220), wobei jede Signalabgabeschaltung (220) zum Zuführen eines Treiberstroms zu einer entsprechenden Elektrode (206) ist, die an dem biologischen Subjekt (208) befestigt ist;
 - b) wenigstens eine Signalquelle (202); und
 - c) wenigstens einen ersten Multiplexer (204) zum selektiven Verbinden der Signalquelle (202) mit einer aus der Vielzahl von Signalabgabeschaltungen (220), um dadurch über die entsprechende Elektrode (206) einen Treiberstrom an das biologische Subjekt (208) anzulegen.
9. Vorrichtung gemäß einem der Ansprüche 1 bis 8, wobei die Vorrichtung (200) umfasst:

- a) eine Vielzahl von Signalabgabeschaltungen (220), wobei jede Signalabgabeschaltung (220) zum Bereitstellen eines Spannungssignals, das für eine Spannung an der Elektrode (206) indikativ ist, an einen Sensor ist;
b) wenigstens einen Sensor; und
c) wenigstens einen zweiten Multiplexer (212) zum selektiven Verbinden des wenigstens einen Sensors mit einer aus der Vielzahl von Signalabgabeschaltungen (220), um dadurch dem Sensor zu ermöglichen, das Spannungssignal, das für eine Spannung an der entsprechenden Elektrode (206) indikativ ist, abzufühlen.

10. Vorrichtung gemäß einem der Ansprüche 1 bis 9, wobei die Vorrichtung (200) erste und zweite Signalquellen (202) zum Erzeugen entsprechender erster und zweiter Treibersignale umfasst, wobei die ersten und zweiten Signalquellen mit entsprechenden Signalabgabeschaltungen (220) gekoppelt sind, wobei die ersten und zweiten Signalquellen (202) zum Erzeugen von wenigstens einem von:

- a) komplementären Signalen;
b) Signalen mit einer konstanten Amplitude und Phase; und
c) Signalen mit einer gesteuerten Amplitude und Phase sind.

11. Vorrichtung gemäß einem der Ansprüche 1 bis 10, wobei die Vorrichtung (200) umfasst:

- a) wenigstens eine Signalabgabeschaltung (220) zum Zuführen eines Stroms zu einer Treiberelektrode (206a), die an dem biologischen Subjekt befestigt ist; und
b) wenigstens eine Signalabgabeschaltung (220) zum Bereitstellen eines Spannungssignals, das für eine Spannung an einer Sensorelektrode (206b) indikativ ist.

Revendications

1. Appareil (200) pour relier électriquement un appareil de mesure à un sujet biologique (208), l'appareil comprenant un circuit de fourniture de signal (220) incluant :

a) un tampon de courant (430) ayant :

- i) une entrée de tampon de courant (432) pour recevoir un signal provenant d'une source de signal (222) ; et,
ii) une sortie de tampon de courant (434) pour fournir un courant à une électrode (206) fixée au sujet biologique (208); et,

caractérisé en ce que l'appareil (200) comprend en outre :

b) un tampon de tension (440) ayant :

- i) une entrée de tampon de tension (224) couplée à la sortie de tampon de courant (434); et,
ii) une sortie de tampon de tension (226) pour fournir un signal de tension indicatif d'une tension au niveau de l'électrode (206).

2. Appareil selon la revendication 1, dans lequel le tampon de courant est un transporteur de courant.

3. Appareil selon la revendication 1 ou la revendication 2, dans lequel le tampon de tension est un amplificateur monté en suiveur de sortie.

4. Appareil selon l'une quelconque des revendications 1 à 3, dans lequel l'appareil comprend un circuit de commande de décalage (550) couplé entre la sortie de tampon de tension (226) et l'entrée de tampon de courant (222), le circuit de commande de décalage (550) étant utilisé pour commander un décalage de courant continu au niveau de l'électrode (206).

5. Appareil selon la revendication 4, dans lequel le circuit de commande de décalage (550) comprend un intégrateur couplé entre la sortie de tampon de tension (226) et l'entrée de tampon de courant (222).

6. Appareil selon l'une quelconque des revendications 1 à 5, dans lequel le circuit de fourniture de signal (220) comprend

un circuit d'impédance négative (570) couplé entre la sortie de tampon de tension (226) et la sortie de tampon de courant (434), dans lequel le circuit d'impédance négative (570) comprend un amplificateur de circuit d'impédance négative (571) et une impédance de compensation (591), et dans lequel au moins l'un d'un gain de l'amplificateur de circuit d'impédance négative (571) et d'une valeur de l'impédance de compensation (591) est choisi pour compenser les pertes d'impédances parasites.

7. Appareil selon la revendication 6, dans lequel le circuit d'impédance négative (570) comprend :

- a) une impédance de compensation (591) ayant une valeur d'impédance de compensation, une première borne et une seconde borne, la première borne étant couplée à la sortie de tampon de courant (434); et,
- b) un amplificateur de compensation (571) ayant une entrée d'amplificateur de compensation, une sortie d'amplificateur de compensation et un gain, l'entrée d'amplificateur de compensation (571) étant couplée à la sortie de tampon de tension (226), la sortie d'amplificateur de compensation étant couplée à la seconde borne de l'impédance de compensation (591) pour fournir un courant de compensation pour circuler à travers l'impédance (591), et les valeurs du gain et de l'impédance de compensation (591) sont choisies en fonction de la valeur d'impédance parasite de telle sorte que le courant de compensation a une amplitude sensiblement égale à l'amplitude du courant de fuite.

8. Appareil selon l'une quelconque des revendications 1 à 7, dans lequel l'appareil (200) comprend :

- a) une pluralité de circuits de fourniture de signal (220), chaque circuit de fourniture de signal (220) étant destiné à fournir un courant d'attaque à une électrode respective (206) fixée au sujet biologique (208);
- b) au moins une source de signal (202); et,
- c) au moins un premier multiplexeur (204) pour relier sélectivement la source de signal (202) à l'un de la pluralité de circuits de fourniture de signal (220) afin d'appliquer ainsi un courant d'attaque au sujet biologique (208) par l'intermédiaire de l'électrode respective (206).

9. Appareil selon l'une quelconque des revendications 1 à 8, dans lequel l'appareil (200) comprend :

- a) une pluralité de circuits de fourniture de signal (220), chaque circuit de fourniture de signal (220) étant destiné à fournir un signal de tension indicatif d'une tension au niveau de l'électrode (206), à un capteur;
- b) au moins un capteur; et,
- c) au moins un second multiplexeur (212) pour relier de manière sélective ledit au moins un capteur à l'un de la pluralité de circuits de fourniture de signal (220) pour ainsi permettre au capteur de détecter le signal de tension indicatif d'une tension au niveau de l'électrode respective (206).

10. Appareil selon l'une quelconque des revendications 1 à 9, dans lequel l'appareil (200) comprend des première et seconde sources de signal (202) pour générer des premier et second signaux d'attaque respectifs, les première et seconde sources de signal étant couplées à des circuits de fourniture de signal respectifs (220), dans lequel les première et seconde sources de signal (202) sont destinées à générer au moins l'un parmi :

- a) des signaux complémentaires;
- b) des signaux ayant une amplitude et une phase constantes; et,
- c) des signaux ayant une amplitude et une phase commandées.

11. Appareil selon l'une quelconque des revendications 1 à 10, dans lequel l'appareil (200) comprend :

- a) au moins un circuit de fourniture de signal (220) pour fournir un courant à une électrode d'attaque (206a) fixée au sujet biologique; et,
- b) au moins un circuit de fourniture de signal (220) pour fournir un signal de tension indicatif d'une tension au niveau d'une électrode de détection (206b).

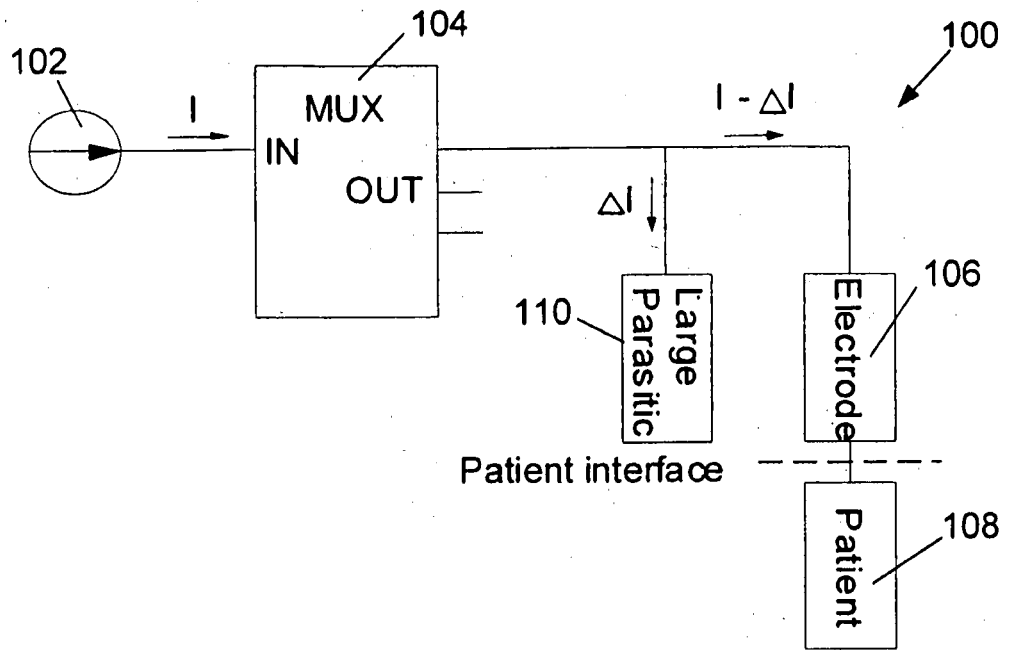

Fig. 1

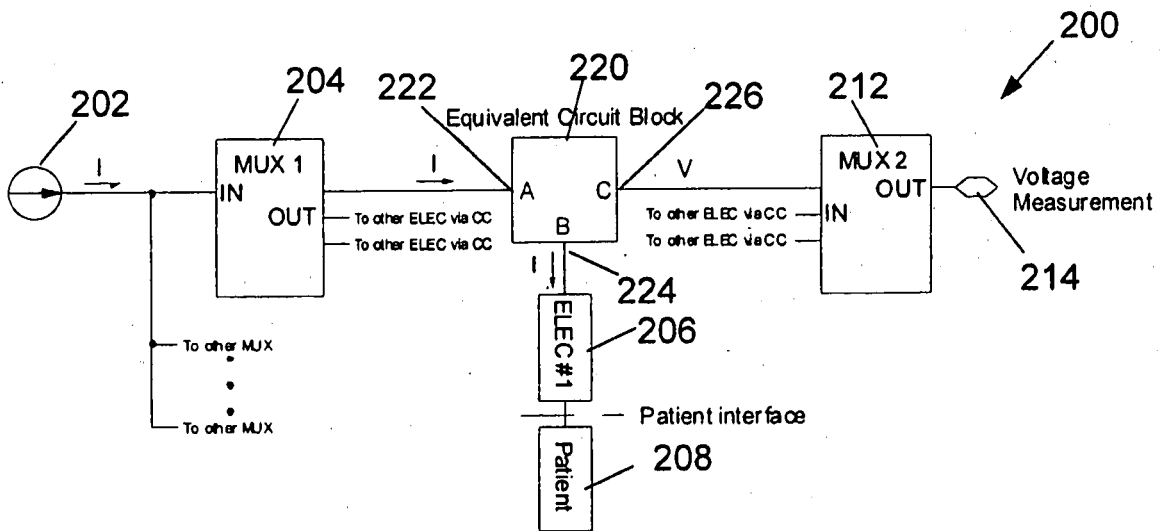

Fig. 2

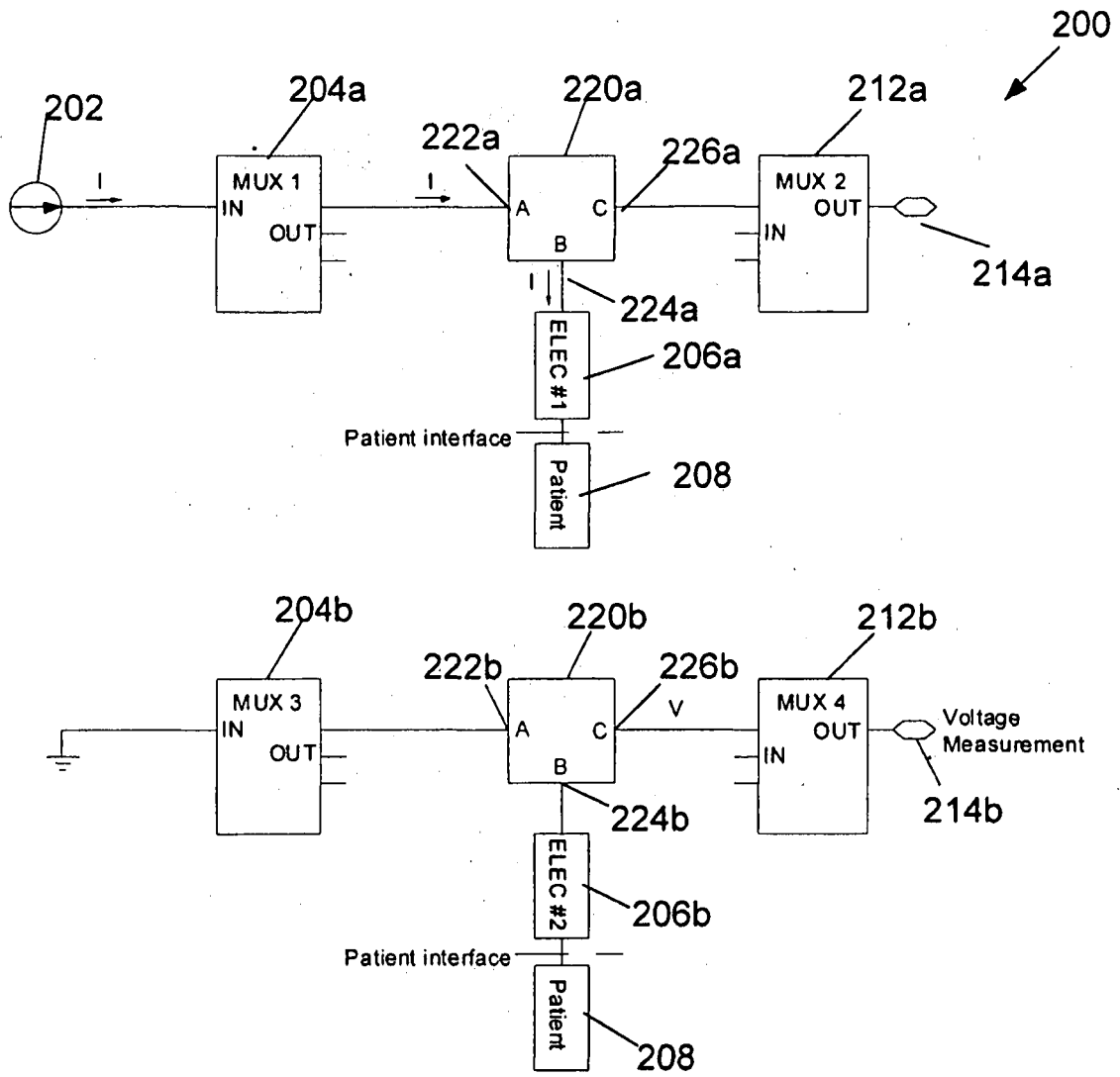

Fig. 3

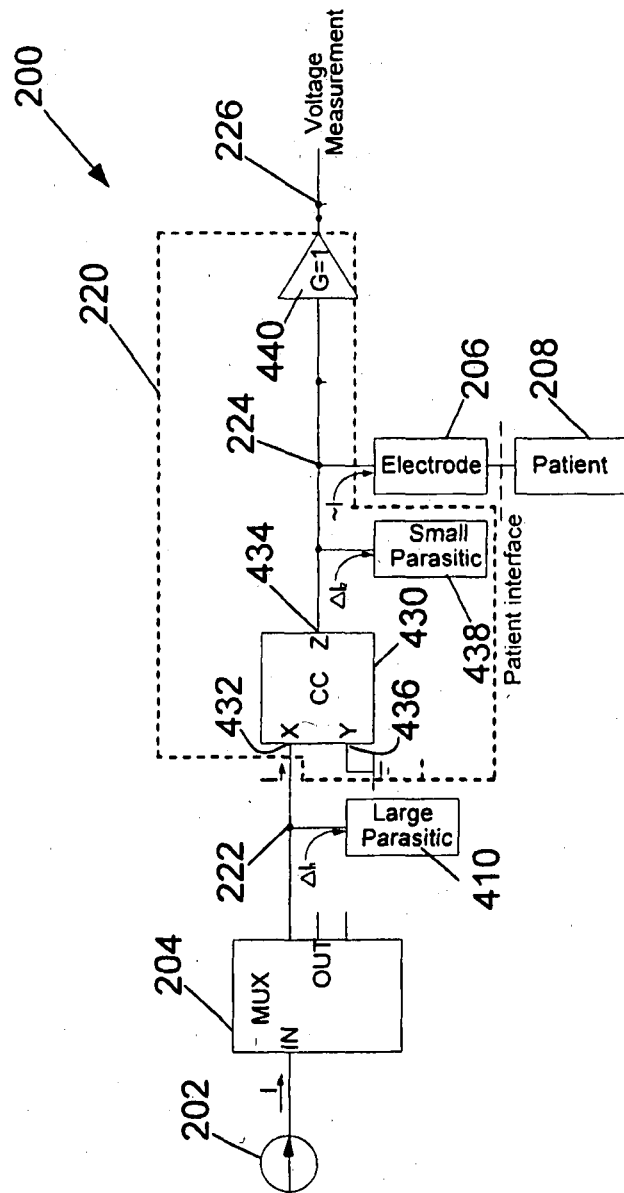

Fig. 4

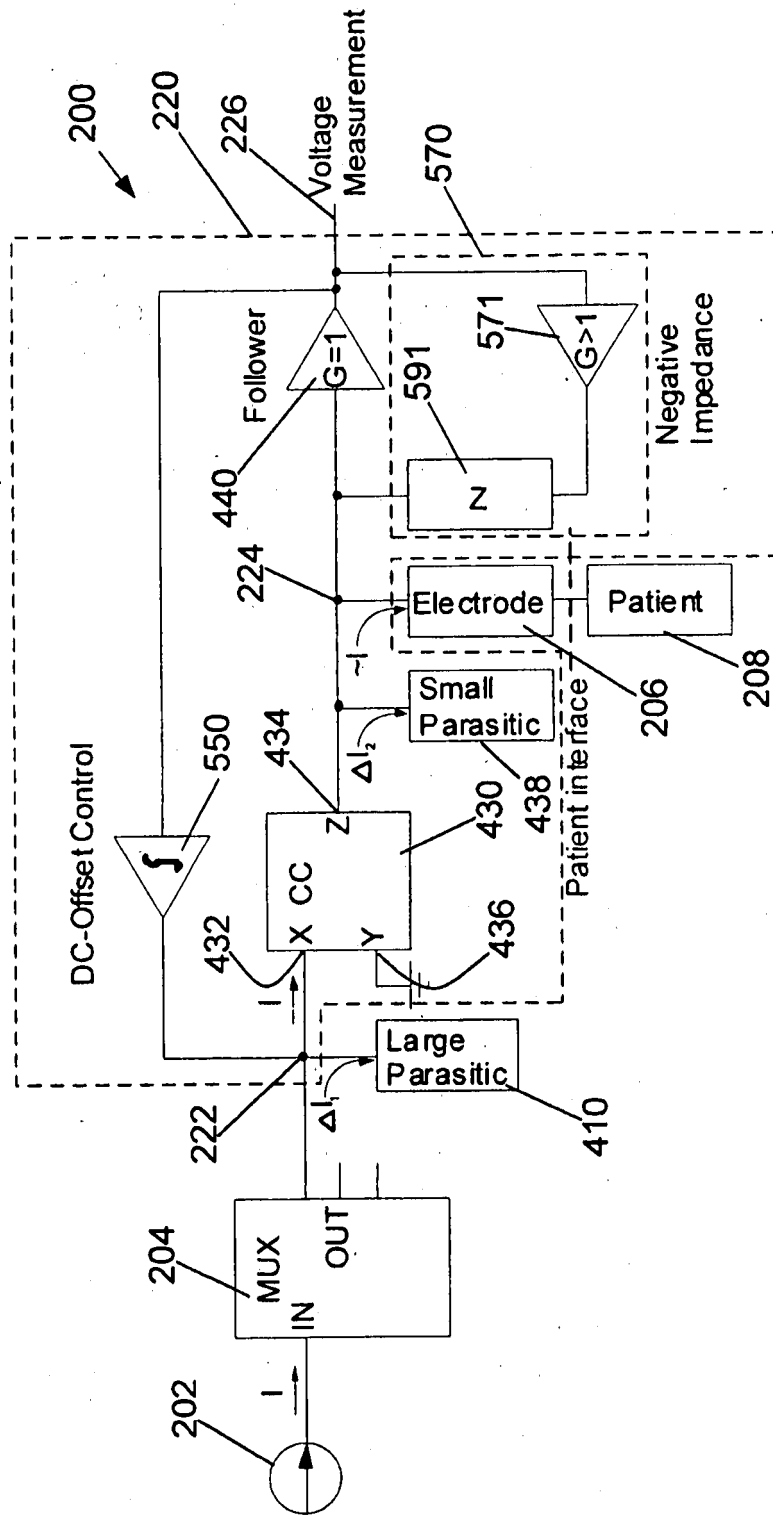

Fig. 5

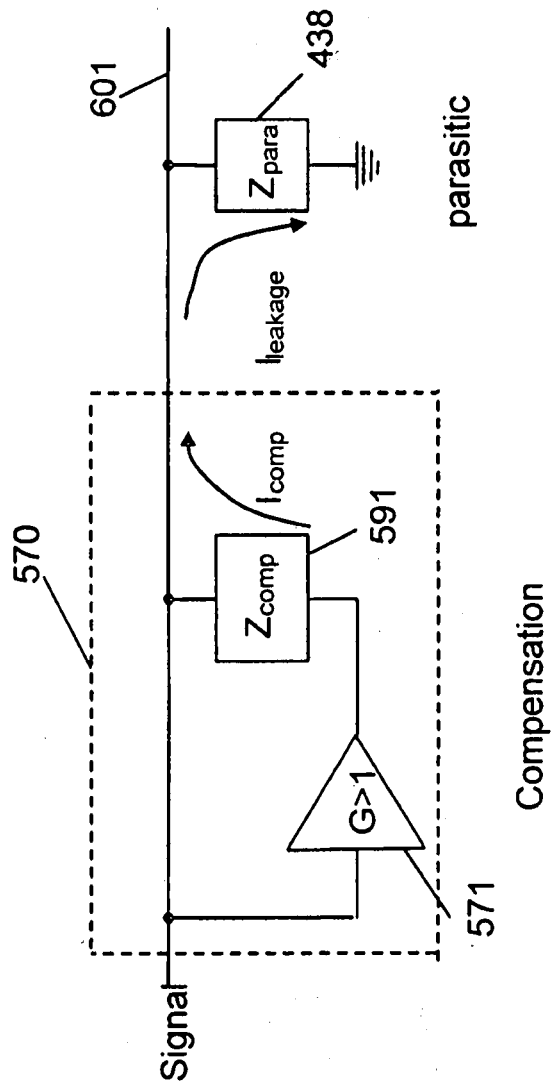

Fig. 6

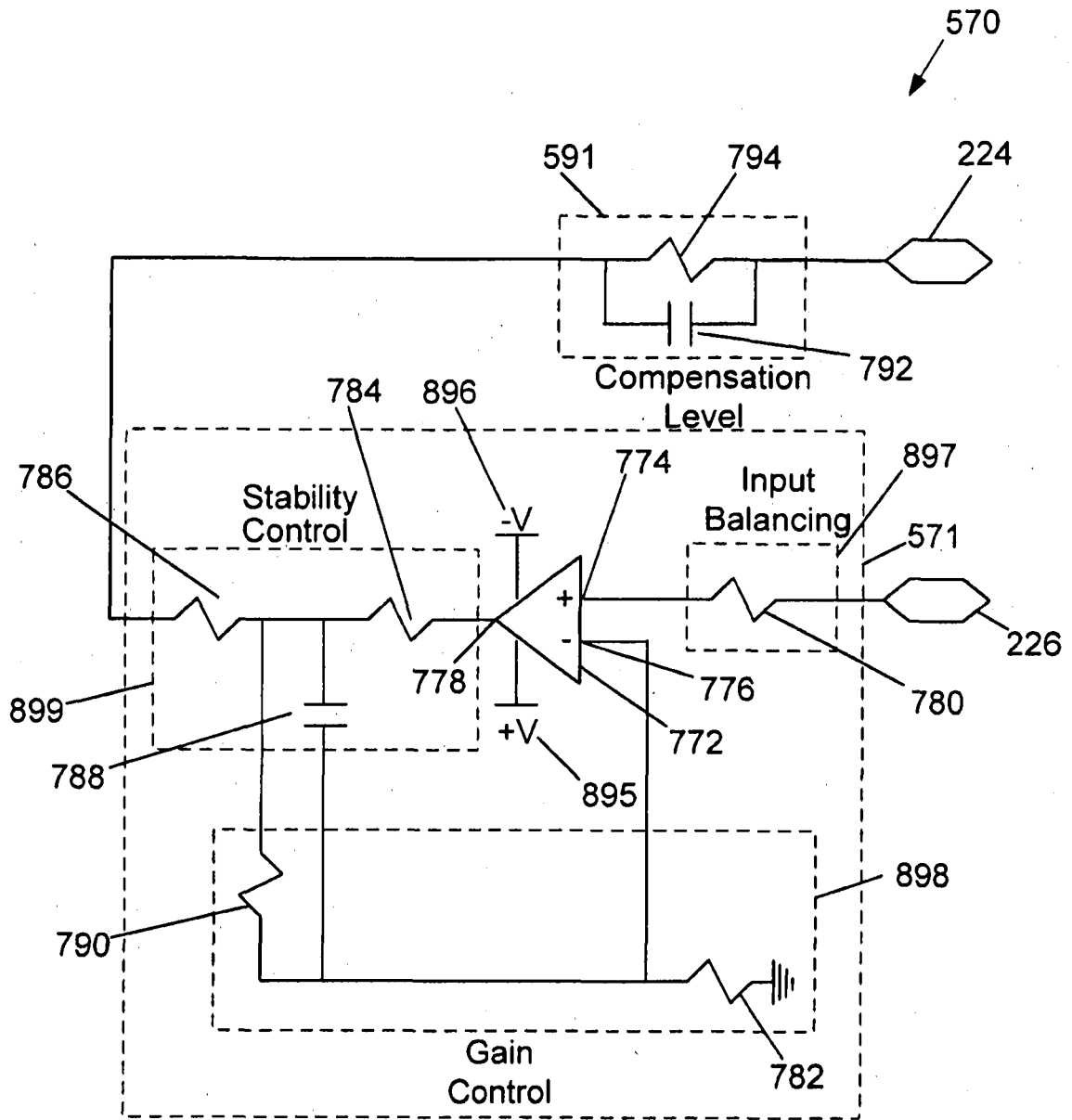

Fig. 8

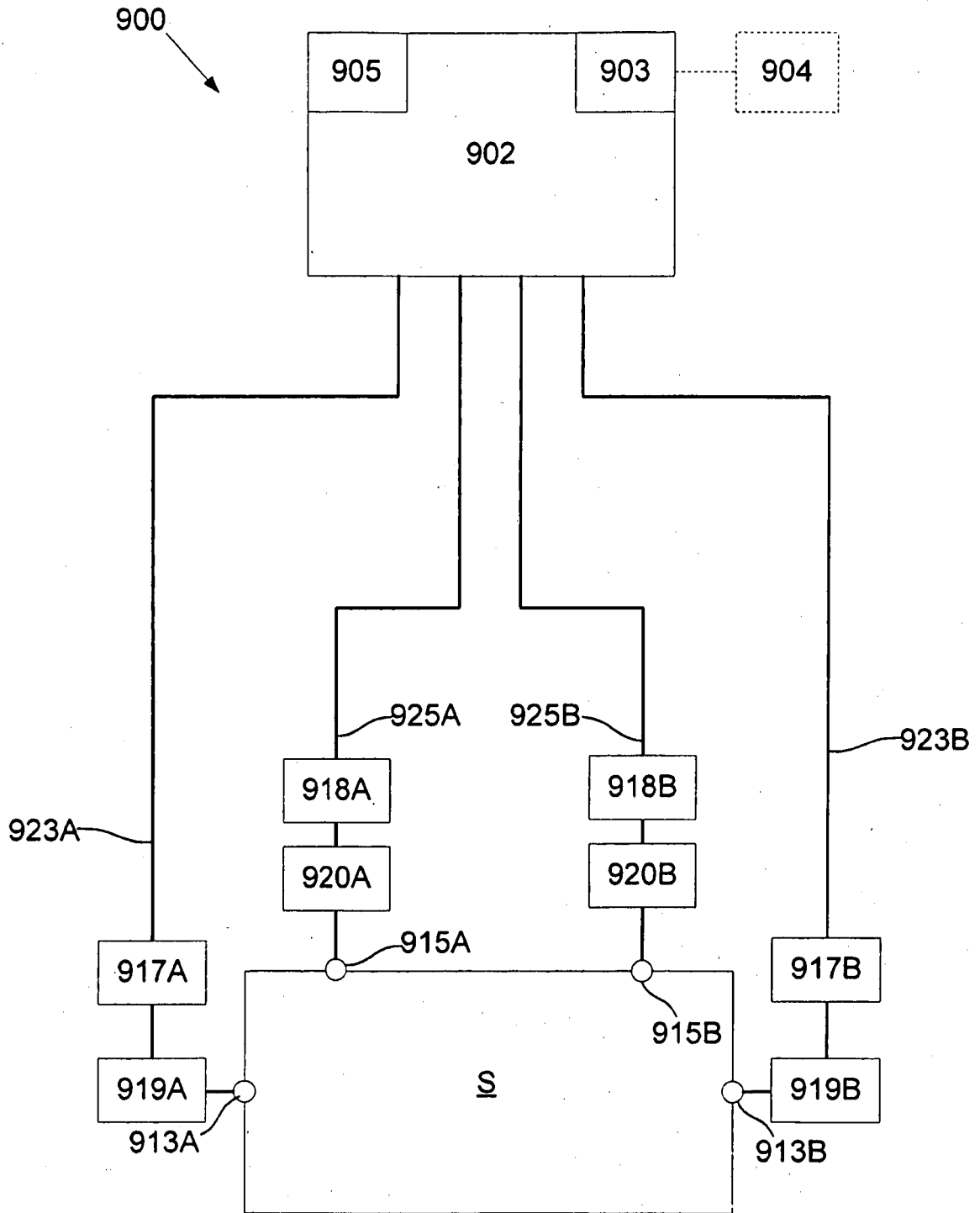

Fig. 9

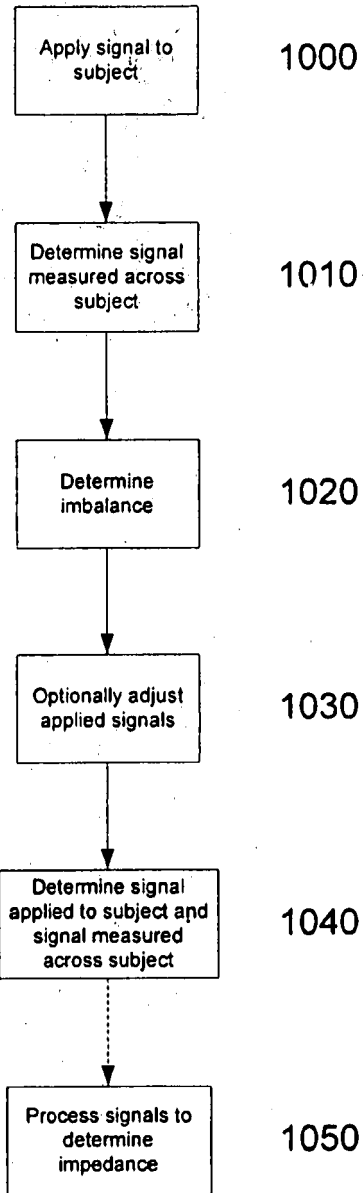

Fig. 10

REFERENCES CITED IN THE DESCRIPTION

This list of references cited by the applicant is for the reader's convenience only. It does not form part of the European patent document. Even though great care has been taken in compiling the references, errors or omissions cannot be excluded and the EPO disclaims all liability in this regard.

Patent documents cited in the description

- WO 2009059351 A [0006] [0135]

专利名称(译)	用于患者电极测量的信号分布		
公开(公告)号	EP2501283A4	公开(公告)日	2014-09-10
申请号	EP2010830958	申请日	2010-11-18
申请(专利权)人(译)	IMPEDIMED有限公司		
当前申请(专利权)人(译)	IMPEDIMED有限公司		
[标]发明人	FAN CHUNG SHING IRONSTONE JOEL SMITH KENNETH CARLESS		
发明人	FAN, CHUNG SHING IRONSTONE, JOEL SMITH, KENNETH CARLESS		
IPC分类号	A61B5/053 A61B5/00 A61N1/04 G01R27/02 G01R35/00		
CPC分类号	A61B5/053 A61B5/0537 A61B5/4869 A61B5/4875 A61B5/4878 A61B5/6843 A61B5/6885 A61B5/7203 G01R1/30 G01R27/02 G01R31/00 H03F3/50 H03F3/602 H03F2200/261		
优先权	2009905642 2009-11-18 AU		
其他公开文献	EP2501283A1 EP2501283B1		
外部链接	Espacenet		

摘要(译)

用于将测量装置电连接到生物体的装置，该装置包括信号传递电路，该信号传递电路包括电流缓冲器，该电流缓冲器具有用于接收来自信号源的信号的电流缓冲器输入端和用于向连接到电极的电极提供电流的电流缓冲器输出端。生物体，和电压缓冲器，其具有耦合到电流缓冲器输出的电压缓冲器输入和电压缓冲器输出，用于向传感器提供指示电极处的电压的电压信号。