

(19)



(11)

**EP 2 489 307 B1**

(12)

**EUROPEAN PATENT SPECIFICATION**

(45) Date of publication and mention of the grant of the patent:  
**03.10.2018 Bulletin 2018/40**

(51) Int Cl.:  
**A61B 5/18** (2006.01)      **A61B 5/00** (2006.01)  
**B60K 28/06** (2006.01)      **B60W 40/08** (2012.01)

(21) Application number: **10823446.9**

(86) International application number:  
**PCT/JP2010/068068**

(22) Date of filing: **14.10.2010**

(87) International publication number:  
**WO 2011/046178 (21.04.2011 Gazette 2011/16)**

(54) **BIOLOGICAL STATE ESTIMATION DEVICE AND COMPUTER PROGRAM**

VORRICHTUNG ZUR BESTIMMUNG EINES BIOLOGISCHEN STATUS UND COMPUTERPROGRAMM

DISPOSITIF D'ESTIMATION D'ÉTAT BIOLOGIQUE, ET PROGRAMME INFORMATIQUE

(84) Designated Contracting States:  
**AL AT BE BG CH CY CZ DE DK EE ES FI FR GB GR HR HU IE IS IT LI LT LU LV MC MK MT NL NO PL PT RO RS SE SI SK SM TR**

- **MAEDA, Shinichiro**  
**Hiroshima-shi**  
**Hiroshima 736-0084 (JP)**
- **OCHIAI, Naoki**  
**Hiroshima-shi**  
**Hiroshima 736-0084 (JP)**

(30) Priority: **14.10.2009 JP 2009237802**

(43) Date of publication of application:  
**22.08.2012 Bulletin 2012/34**

(74) Representative: **Hoffmann Eitle**  
**Patent- und Rechtsanwälte PartmbB**  
**Arabellastraße 30**  
**81925 München (DE)**

(73) Proprietor: **Delta Tooling Co., Ltd.**  
**Hiroshima-shi, Hiroshima 736-0084 (JP)**

- (72) Inventors:
- **FUJITA, Etsunori**  
**Hiroshima-shi**  
**Hiroshima 736-0084 (JP)**
  - **OGURA, Yumi**  
**Hiroshima-shi**  
**Hiroshima 736-0084 (JP)**

(56) References cited:

<b>WO-A1-00/44580</b>	<b>WO-A1-2005/092193</b>
<b>WO-A1-2008/143249</b>	<b>WO-A1-2008/143249</b>
<b>WO-A1-2009/104460</b>	<b>JP-A- 2009 022 610</b>
<b>US-A1- 2004 260 440</b>	<b>US-A1- 2006 122 474</b>

Note: Within nine months of the publication of the mention of the grant of the European patent in the European Patent Bulletin, any person may give notice to the European Patent Office of opposition to that patent, in accordance with the Implementing Regulations. Notice of opposition shall not be deemed to have been filed until the opposition fee has been paid. (Art. 99(1) European Patent Convention).

**EP 2 489 307 B1**

## Description

### Technical Field

**[0001]** The present invention relates to a technique for estimating a state of a biological body using a time-series waveform of a biological signal obtained from an upper body of a person.

### Background Art

**[0002]** Monitoring a biological body state of a driver during driving has attracted attention as a preventive measure against an accident or the like in recent years. The present applicant disclosed techniques of disposing a pressure sensor in a seat cushion section, obtaining and analyzing breath pulse waves, and determining a sleep prediction phenomenon in Patent Literatures 1 to 3.

**[0003]** Specifically, a maximum value and a minimum value of a time-series waveform of a pulse wave are obtained by a smoothing differentiation method of Savitzky and Golay, respectively. The maximum value and the minimum value are obtained for each 5 seconds so that their mean values are obtained. Using a square of a difference between the respective mean values of the maximum values and the minimum values obtained as a power value, the power value is plotted for each 5 seconds so that a time-series waveform of the power value is produced. In order to read a global change of the power value from this time-series waveform, a slope of the power value regarding a certain time window  $T_w$  (180 seconds) is obtained by least-square method. Next, the slope regarding the next time window  $T_w$  is similarly calculated in an overlapped time  $T_l$  (162 seconds) and the calculation results are plotted. A time-series waveform of the slope of the power value is obtained by repeating this calculation (movement calculation) sequentially. On the other hand, the maximum Lyapunov exponent is obtained by applying Chaos analysis to the time-series waveform of the pulse wave, a maximum value is obtained by a smoothing differentiation like the above, and a time-series waveform of a slope of the maximum Lyapunov exponent is obtained by conducting movement calculation.

**[0004]** Then, the time-series waveform of the slope of the power value and the time-series waveform of the slope of the maximum Lyapunov exponent take phases opposite to each other, and a waveform having a large amplitude at a low frequency in the time-series waveform of the slope of the power value is determined as a characteristic signal indicating a sleep prediction and a point at which the amplitude has become small thereafter is determined as a sleep-onset point.

**[0005]** Further, as Patent Literature 4, a system provided with an airbag (air pack) including a three-dimensional solid fabric inserted therein, where the air pack is disposed at a site corresponding to a waist portion of a person, an air pressure fluctuation in the air pack is meas-

ured, a biological signal of the person is detected from the time-series waveform of the air pressure fluctuation obtained, and the biological body state of the person is analyzed is disclosed. Further, in Non-Patent Literatures 1 and 2, trials for detecting a biological signal of a person by disposing an air pack sensor along a lumbar iliocostal muscle are reported. This air pressure fluctuation of the air pack is caused by fluctuation in a downward aorta with movement of a heart, and a state change closer to the movement of the heart than use of the breath pulse waves in Patent Literatures 1 and 2 can be captured.

**[0006]** Moreover, the present applicant also proposes the technique of applying absolute value processing to the time-series signal of the slope of the power value to calculate an integral value and obtaining a fatigue degree from the integral value as Patent Literature 5. Furthermore, the applicant proposes a technology in which a fatigue degree closer to sensory evaluation is acquired, to which mental fatigue is added, by considering a compensation action for fatigue by sympathetic nerve activities using time-series data of maximum Lyapunov exponent in addition to the method of mainly acquiring a physical fatigue degree by using time-series data of a power value as Patent Literature 6.

### Prior Art Literatures

### Patent Literature

#### **[0007]**

Patent Literature 1: Japanese Patent Application Laid-Open No. 2004-344612

Patent Literature 2: Japanese Patent Application Laid-Open No. 2004-344613

Patent Literature 3: WO2005/092193A1

Patent Literature 4: Japanese Patent Application Laid-Open No. 2007-90032

Patent Literature 5: WO2005/039415A1

Patent Literature 6: Japanese Patent Application Laid-Open No. 2009-295384

**[0008]** WO 00/44580 discloses an apparatus for determining a vigilance state of a subject such as a driver of a vehicle or the like. The apparatus includes means for monitoring one or more physiological variables such as EEG, EMG and EOG signals associated with the subject. The apparatus also includes means for deriving from the one or more variables data representing physiological states of the subject corresponding to the or each variable and means for determining from the data when the vigilance state of the subject is below a predetermined threshold. The apparatus may include means for intervening with the control of the vehicle in the event that the vigilance state of the driver is below the predetermined threshold.

**[0009]** WO 2008/143249 A1 discloses a seat structure, which makes the followability to respiratory movements

higher without obstructing the motions of the pelvis. The seat structure is constituted such that back cushioning member arranging frames and a seat cushioning member arranging frame are displaced according to the fluctuations of loads on back cushioning members and a seat cushioning member. In this constitution, according to the load fluctuations, not only the back cushioning members and the seat cushioning member move, but also the frame itself supporting them moves through the tension structure (i.e., the back cushioning members and the seat cushioning member) tensed on the frame. When the pelvis is laid at a sitting position for a deep breathing, therefore, the back cushioning member arranging frames are displaced to push the portions near the upper portions of the back cushioning members, so that the portions near the lower portions are pushed forward to fulfill the support of the sacrum.

#### Non-Patent Literatures

##### [0010]

Non-Patent Literature 1: "APPLICATION OF BIOLOGICAL WANDERING SIGNAL MEASURED BY NON-INVASIVE TYPE SENSOR TO FATIGUE AND SLEEP PREDICTION" by Naoki OCHIAI (and six others), 39th Japan Ergonomics Society Chugoku and Shikoku Branch convention, Collection of Literatures and Papers issued on November 25, 2006 from Japan Ergonomics Society Chugoku and Shikoku Branch Secretariat

Non-Patent Literature 2: "TRIAL PRODUCTION OF VEHICLE SEAT HAVING NON-INVASIVE BIOLOGICAL SIGNAL SENSING FUNCTION" by Shinichiro MAEDA (and four others), 39th Japan Ergonomics Society Chugoku and Shikoku Branch Convention, Collection of Literatures and Papers issued on November 25, 2006 from Japan Ergonomics Society Chugoku and Shikoku Branch Secretariat

#### Summary of Invention

[0011] As described above, in the techniques described in Patent Literatures 1 to 4 and Non-Patent Literatures 1 and 2, the time where the time-series waveform of the slope of the power value and the time-series waveform of the slope of the maximum Lyapunov exponent has taken phases opposite to each other and a waveform having a large amplitude at a low frequency has occurred in the time-series waveform of the slope of the power value is regarded as the sleep prediction phenomenon. According to this method, when a person sits on a seat, the sleep prediction phenomenon can be captured. Moreover, according to Patent Literatures 5 and 6, the fatigue degree of a person can be acquired.

[0012] However, skills are required to determine whether or not the sleep prediction phenomenon has oc-

curred from a change in the waveform, and it is difficult for general drivers to determine the sleep prediction phenomenon by examining the waveform change. Thus, the above Patent Literatures employ means for notification by operating some alarm device (a buzzer sound, vibration in a seatback and the like, for example) when the opposite phase of the time-series waveform occurs or the like. Moreover, the fatigue degree in Patent Literatures 5 and 6 is determined on the basis of a graph in which the fatigue degree steadily increases over time. Therefore, in this case, too, it is not easy for a driver to grasp a degree of his/her own fatigue by examining the graph if this graph is displayed on a monitor mounted on an automobile, for example. It might be different for those who are accustomed to determining the fatigue degree on the basis of this graph, but otherwise, the driver needs to be notified by an alarm of sound or the like at some inflection point such as time when the fatigue degree has reached a certain numerical value or more.

[0013] Moreover, the prior-art methods are all based on determination mainly of a state caused by metabolic change of a person. That is, the process during which a body is getting tired one-sidedly as time elapses is mainly examined. However, it is considered that, a contribution rate of mental fatigue is high in a tensed state, while physical fatigue governs the progress of fatigue in a relaxed state. However, in the prior-art methods, suppression of fatigue by activation of a brain function is not considered. In a general driving environment, the brain function is activated regardless of the degree of progress of fatigue. This activation of the brain function includes creativity, curiosity and the like, and they induce awakening. As in Patent Literature 6, the fatigue degree to which the mental fatigue is added is acquired, considering the compensation action for fatigue by the sympathetic nerve activities by using time-series data of the maximum Lyapunov exponent in addition to the method of acquiring the physical fatigue degree, but even in this case, only the process of fatigue increasing one-sidedly and the compensation action by the sympathetic nerve are outputted, and whether or not the brain function has been activated is not captured.

[0014] The present invention was made in view of the above and has an object to provide a biological body state estimation device, a biological body state estimation system, and a computer program which can capture not only the activities of autonomous nerves but also the activated state of the brain function and which enables easy visual understanding of a homeostatic function level of a person by examining display means, whereby the degree of progress of fatigue can be also grasped.

[0015] The present invention provides a biological body state estimation device according to Claim 1, and a computer program according to Claim 10. Optional features are set out in the dependent claims.

## Brief Description of Drawings

**[0016]**

FIG. 1 is a view showing a state where biological signal measuring means according to an embodiment of the present invention is incorporated in a seat;

FIG. 2 is a view showing the biological signal measuring means according to the embodiment in more detail;

FIGS. 3A to 3D are views showing an air-pack unit, FIG. 3A being a sectional view of the air-pack unit as viewed from the front, FIG. 3B being a side view thereof, FIG. 3C being a bottom view thereof, and FIG. 3D being a sectional view of FIG. 3A taken along a line A - A;

FIG. 4 is an exploded perspective view of the air-pack unit;

FIGS. 5A and 5B are views for describing a size of an air-pack unit used in a test example;

FIG. 6 is a diagram showing a configuration of a biological body state estimation device according to the embodiment;

FIG. 7 is a flowchart showing a process of state estimation by the biological body state estimation device;

FIGS. 8A to 8C are conceptual diagrams for explaining a mechanism of the state estimation;

FIG. 9 is a diagram for explaining a method for obtaining a frequency fluctuation time-series waveform, a base line of the frequency fluctuation time-series waveform, a frequency slope time-series waveform which is a slope time series of a frequency fluctuation, and an integral curve using a peak value of a pulse wave (heartbeat fluctuation) detected by the biological signal measuring means or a zero-crossing point;

FIG. 10 shows a waveform to which filtering means is applied and a waveform to which the filtering means is not applied in the biological body state estimation device according to the embodiment, FIG. 10A showing a measurement result obtained in an idling state of an automobile, and FIG. 10B showing a measurement result in a running state;

FIGS. 11A to 11E are diagrams showing examples of acquiring a homeostatic function level of a driver and displaying it by line graphs on display means by output means;

FIGS. 12A to 12E are views showing change examples of images outputted on the display means by separate screen output means;

FIG. 13 is an enlarged view showing an image outputted on the display means by the separate screen output means;

FIG. 14A is a diagram showing a part of original waveforms of an air pack signal and an electrocardiogram in sitting position and a supine position in a

test example 1, and FIG. 14B is a diagram showing a result of comparison between the heartbeat frequency time-series waveform calculated from the air pack signal and the electrocardiogram in a sitting position and a supine position;

FIGS. 15A to 15G are diagrams showing analysis results of the biological body state estimation device in a test example 2;

FIGS. 16A to 16G are diagrams showing analysis results of the biological body state estimation device in the test example 2;

FIGS. 17A to 17G are diagrams showing analysis results of the biological body state estimation device in the test example 2;

FIGS. 18A to 18G are diagrams showing analysis results of the biological body state estimation device in the test example 2;

FIGS. 19A to 19G are diagrams showing analysis results of the biological body state estimation device in the test example 2;

FIGS. 20A to 20G are diagrams showing analysis results of the biological body state estimation device in the test example 2;

FIGS. 21A to 21G are diagrams showing analysis results of the biological body state estimation device in the test example 2;

FIGS. 22A to 22G are diagrams showing analysis results of the biological body state estimation device in the test example 2;

FIGS. 23A to 23G are diagrams showing analysis results of the biological body state estimation device in the test example 2;

FIGS. 24A to 24G are diagrams showing analysis results of the biological body state estimation device in the test example 2;

FIGS. 25A to 25G are diagrams showing analysis results of the biological body state estimation device in the test example 2;

FIGS. 26A to 26G are diagrams showing analysis results of the biological body state estimation device in the test example 2;

FIGS. 27A to 27G are diagrams showing analysis results of the biological body state estimation device in the test example 2;

FIGS. 28A to 28G are diagrams showing analysis results of the biological body state estimation device in the test example 2;

FIGS. 29A to 29G are diagrams showing analysis results of the biological body state estimation device in the test example 2;

FIGS. 30A to 30G are diagrams showing analysis results of the biological body state estimation device in the test example 2;

FIGS. 31A to 31D are diagrams showing results of fatigue experiments of a subject A conducted in a round trip between Tokyo and Osaka in a test example 3;

FIGS. 32A to 32C are diagrams showing other dis-

play examples of graphs showing the homeostatic function level by plotting in a time series;

FIG. 33 is a view showing an example of the biological signal measuring means according to another embodiment;

FIG. 34 is a view showing another example of the biological signal measuring means according to another embodiment;

FIG. 35 is a view for explaining a process of incorporating the biological signal measuring means shown in FIGS. 33 or FIGS. 34 in a seat;

#### Description of Embodiments

**[0017]** A biological body state estimation device according to an embodiment of the present invention is a biological body state estimation device for estimating a state of a person using a biological signal obtained from an upper body of a person by using biological signal measuring means and includes homeostatic function level computing means that analyzes the biological signal, and acquires and sorts the homeostatic function level of a person at a predetermined point of time into a plurality of stages and output means that plots the homeostatic function level acquired by the homeostatic function level computing means in a time series by taking each stage of the homeostatic function level on the vertical axis and time on the lateral axis and displays a fluctuation degree of the homeostatic function level on display means as a graph.

**[0018]** It is preferred that the homeostatic function level computing means acquires and sorts the homeostatic function level into a range of 3 to 10 stages from a highly active state to a functional decline state, and the output means sorts and displays the level in a range of 3 to 10 stages on the vertical axis with the highly active state as the highest part and the functional decline state as the lowest part. It is preferred that the homeostatic function level computing means acquires and sorts the homeostatic function level into five stages from the highly active state to the functional decline state and the output means sorts and displays the level into five stages on the vertical axis with the highly active state as the highest part and the functional decline state as the lowest part.

**[0019]** It is preferred that determining means that determines a change in the state of a person from a graph displayed on the display means by the output means is further provided. The determining means preferably has abnormal state determining means that determines an abnormal state if a rapid decline over two stages or more of the homeostatic function level occurs a predetermined number of times or more on the graph displayed on the display means by the output means.

**[0020]** The homeostatic function level computing means preferably includes:

frequency computing means that acquires a frequency of a biological signal obtained by the biolog-

ical signal measuring means;

frequency slope time-series analyzing and computing means that conducts a movement calculation to acquire a slope of the frequency for each predetermined time window set with a predetermined overlapped time from the frequency of the biological signal obtained by the frequency computing means and acquires a time-series waveform of the slope of the frequency obtained for each time window;

differentiating means that differentiates the time-series waveform of the frequency slope acquired by the frequency slope time-series analyzing and computing means;

integrating means that integrates the time-series waveform of the frequency slope acquired by the frequency slope time-series analyzing and computing means;

rectangular wave calculating means that acquires a rectangular wave from increase/decrease of the time-series waveform of the frequency slope acquired by the frequency slope time-series analyzing and computing means;

describing function calculating means that acquires a describing function and a describing function amplitude value between the frequency slope time-series waveform in an arbitrarily set first time zone and the frequency slope time-series waveform in a second time zone after the first time zone;

absolute value processing means that applies absolute value processing to the time-series waveform of the respective frequency slopes acquired by the frequency slope time-series analyzing and computing means by using a time-series waveform of a frequency of a biological signal using a maximum value of the time-series waveform of the biological signal obtained by the frequency computing means and a time-series waveform of a frequency of a biological signal using a zero-crossing point where the sign of the time-series waveform of the biological signal is switched; and

homeostatic function stage calculating means that acquires the stage of the homeostatic function level by using at least one or more of the frequency slope acquired by the frequency slope time-series analyzing and computing means, the differential value acquired by the differentiating means, the integral value acquired by the integrating means, the sign of the rectangular wave acquired by the rectangular wave calculating means, the describing function amplitude value acquired by the describing function calculating means, and two absolute values of the frequency slope time-series waveform acquired by the absolute value processing means.

**[0021]** It is preferred that filtering means that filters the biological signal obtained by the biological signal measuring means in a predetermined frequency band before processing by the homeostatic function level computing

means is further provided, and the filtering means is configured to set a frequency band for filtering by acquiring a mean frequency of the biological signal under a static environment measured by the biological signal measuring means and using the mean frequency as a reference value.

**[0022]** The biological signal measuring means is preferably provided with an air pack brought into contact with the back part of a person and whose pressure fluctuates with fluctuation in aorta caused by movement of the heart, and the homeostatic function level computing means preferably uses the pressure fluctuation of the air pack as the biological signal to be analyzed. In the case of application to a vehicle, the air pack is preferably equipped to a seatback section of a vehicle seat, and an onboard monitor can be used as the display means.

**[0023]** Moreover, the computer program according to an embodiment of the present invention is a computer program incorporated in the biological body state estimation device that estimates the state of a person by using a biological signal obtained from the upper body of a person by the biological signal measuring means and includes a homeostatic function level computing step that analyzes the biological signal, and acquires and sorts the homeostatic function level of a person at a predetermined point of time into a plurality of stages and an output step that plots the homeostatic function level acquired by the homeostatic function level computing step in a time series with each stage of the homeostatic function level on the vertical axis and time on the lateral axis and displays it by the display means as a graph.

**[0024]** The graph displayed by the display means in the output step is preferably a line graph. It is preferred that the homeostatic function level computing step acquires and sorts the homeostatic function level into five stages from the highly active state to the functional decline state, and the output step sorts and displays the homeostatic function level in five stages with the highly active state as the highest part and the functional decline state as the lowest part on the vertical axis.

**[0025]** It is preferred that a determining step that determines a change in the state of a person from a graph displayed on the display means by the output step is further provided. The determining step preferably has an abnormal state determining step that determines an abnormal state if a decline over two stages or more of the homeostatic function level occurs a predetermined number of times or more on the graph displayed on the display means by the output step.

**[0026]** The homeostatic function level computing step preferably includes:

- a frequency computing step that acquires a frequency of a biological signal obtained by the biological signal measuring means;
- a frequency slope time-series analyzing and computing step that conducts a movement calculation to acquire a slope of the frequency for each predeter-

mined time window set with a predetermined overlapped time from the frequency of the biological signal obtained by the frequency computing step and acquires a time-series waveform of the slope of the frequency obtained for each time window;

a differentiating step that differentiates the time-series waveform of the frequency slope acquired by the frequency slope time-series analyzing and computing step;

an integrating step that integrates the time-series waveform of the frequency slope acquired by the frequency slope time-series analyzing and computing step;

a rectangular wave calculating step that acquires a rectangular wave from increase/decrease of the time-series waveform of the frequency slope acquired by the frequency slope time-series analyzing and computing step;

a describing function calculating step that acquires a describing function and a describing function amplitude value between the frequency slope time-series waveform in an arbitrarily set first time zone and the frequency slope time-series waveform in a second time zone after the first time zone;

an absolute value processing step that applies absolute value processing to the time-series waveform of the respective frequency slopes acquired by the frequency slope time-series analyzing and computing step by using a time-series waveform of a frequency of a biological signal using a maximum value of the time-series waveform of the biological signal obtained by the frequency computing step and a time-series waveform of a frequency of a biological signal using a zero-crossing point where the sign of the time-series waveform of the biological signal is switched; and

a homeostatic function stage calculating step that acquires the stage of the homeostatic function level by using at least one or more of the frequency slope acquired by the frequency slope time-series analyzing and computing step, the differential value acquired by the differentiating means, the integral value acquired by the integrating means, the sign of the rectangular wave acquired by the rectangular wave calculating means, the describing function amplitude value acquired by the describing function calculating step, and two absolute values of the frequency slope time-series waveform acquired by the absolute value processing step.

**[0027]** An embodiment of the present invention has a configuration in which the homeostatic function level is sorted into a plurality of stages and acquired by using a biological signal obtained from the upper body of a person and each stage of the homeostatic function level is plotted in a time series in accordance with a time axis and displayed by the display means as a graph. The highest part on the vertical axis of the graph is preferably displayed

as a highly active state and the lowest part as the functional decline state. Therefore, the state of fluctuation to maintain homeostasis by autonomous nerves and the state stimulated by the brain can be captured as a periodic function.

**[0028]** Moreover, if the homeostatic function level is displayed in a time series on a graph as above, when a person visually recognizes it, the decline state of the homeostatic function (progress of fatigue) can be easily grasped without requiring any skills. The act of looking at this graph which shows a change in the homeostatic function is an act to satisfy high-dimensional desire to know the state that cannot be subjectively or objectively grasped by himself/herself, and that activates the brain and can prevent the person from going to sleep. That is, the act of looking at the graph itself induces awakening. Therefore, the techniques described herein are highly effective in promoting activation of the brain and are expected to realize an awakening inducing effect higher than the prior-art methods of stimulating an auditory sense by a buzzer sound, of stimulating a tactile sense/pressure sense such as vibration of the seatback and the like.

**[0029]** Moreover, a biological signal for acquiring the homeostatic function level is detected by using a biological reaction of the upper body of a person, and thus, fluctuation in the aorta caused by movement of the heart can be captured. As a result, a homeostatic function which is a life sustaining function can be seen, and the state of a person can be grasped more accurately as compared with the technology for estimating the state of a person by using a digital pulse volume looking at adaptation capability to disturbance.

**[0030]** A cycle of the state change of a person is roughly divided into each state of awakening and sleep and a transitional state between those two states. A person changes from the highly active state to a fatigued state, that is, the function decline state via the transitional state to sleep or a so-called fatigue compensation period. After that, the person returns to the highly active state via the transitional state of a recovery period. In these transitional states, a sleep prediction signal and an awakening prediction signal occur. Also, a human body minimizes the change in energy consumed for metabolism by using circulation of blood in order to maintain homeostasis. The human body varies a frequency of heartbeat (heart rate) and a vessel diameter in order to change the circulation dynamic state of the blood. Therefore, transition of energy used for metabolism can be identified by detecting changes in the frequency fluctuation of the heartbeat and the vessel diameter. When the state of this transition is captured, the transition from the highly active state to the function decline state is captured, thus transition to sleep can be predicted. This state change is induced by the autonomous nerve system. An adaptation state to the external stimulation can be known by capturing this change through a reaction of the peripheral system, and quality and quantity of fatigue can be identified by cap-

turing the reaction of the central system, that is, the fluctuation of the aorta caused by the movement of the heart.

**[0031]** Moreover, the decline of the homeostatic function level over 2 stages or more in the process of the graph indicates a rapid change in the energy level. By using the graph as in an embodiment of the present invention, such rapid drop can be visually recognized, and a person can become aware of a rapid change in the physical condition and try to induce himself/herself into the highly active state or to actively take a rest. Moreover, it is more preferable to provide means for automatically determining an abnormal state (emergence of a sleep prediction signal) if such a rapid change as above occurs a predetermined number of times or more. If determined to be an abnormal state, stimulation by an auditory sense, pressure sense or the like can be used at the same time, such as emission of an alarm sound.

**[0032]** Hereinafter, embodiments of the present invention will be explained in detail with reference to the drawings. FIG. 1 is a view showing an exterior of an automobile seat 500 incorporating biological signal measuring means 1 obtaining a biological signal to be analyzed by a biological body state estimation device 60 according to this embodiment, that is, pressure fluctuation caused by fluctuation in aorta on the back part caused by movement of the heart. A biological body state estimation system is configured by the biological signal measuring means 1 and the biological body state estimation device 60. The biological signal measuring means 1 is used by being incorporated in a seatback section 510. Here, it is desirable that detection signals of pressure fluctuation obtained by the biological signal measuring means 1 contain less noise signals. Thus, the biological signal measuring means 1 of this embodiment has been designed to reduce noise signals contained in the sensor output signals themselves even under a vibration environment such as in a moving automobile and the like as described below.

**[0033]** The biological signal measuring means 1 is configured to include an air-pack unit 100 and an elastic member 20 made of expanded resin beads. The air-pack unit 100 is configured to include a receiving body 15 and two air packs 10 contained in the receiving body 15. Each of the air packs 10 is formed by connecting three small airbags 111 in the vertical direction, while air communication among these small airbags is prevented. Three-dimensional solid knitted fabrics 112 serving as resilience-imparting members are disposed within the respective small airbags 111.

**[0034]** In this embodiment, the air packs 10 are arranged on the right side and the left side. The arrangement of the air packs 10 on the right side and the left side makes contact with the back of a seated person bilaterally even, so that the person does not feel uncomfortable. Moreover, a sensor mounting tube 111a is provided on one of the small airbags 111 configuring one of the right and left air packs 10 and 10, and a sensor 111b which measures air pressure fluctuation is fixed inside thereof.

The sensor mounting tube 111a is sealed. The small airbag 111 preferably has a size within a range of the width of 40 to 100 mm and the length of 120 to 200 mm to sensitively respond to air pressure fluctuation due to a biological signal. A material for the small airbag 111 is not limited, but the small airbag may be formed of a sheet made of, for example, polyurethane elastomer (for example, Product Number "DUS605-CDR" produced by Sheedom Co., Ltd.). As the sensor 111b, one which can measure air pressure within the small airbag 111 can be used, and a capacitive microphone sensor, for example, can be used.

**[0035]** As the size of the entirety composed of three small airbags 111 connected in series, it is preferred that the width and the entire length fall within a range of 40 to 100 mm and a range of 400 to 600 mm, respectively, when they are used in the seatback section 510 of the automobile seat 500. If the length is short, a seated person feels uncomfortable only at a portion close to his/her waist in the seatback section 510, and thus, it is preferred that the length is set to 400 mm or more so that the airbags accommodate the entire back of the seated person as much as possible.

**[0036]** In this embodiment, the sensor 111b which detects air pressure fluctuation is provided in the central small airbag 111 constituting the air pack 10 arranged on the left side of the seated person. The position of this small airbag 111 corresponds to a region where fluctuation in the aorta (particularly the "downward aorta") caused by the movement of the heart on the back of the seated person can be detected. The region where the movement of the aorta on the back is detectable is not uniform due to the body frame of a seated person, but as a result of measuring 20 subjects of various build from a 158-cm-tall Japanese woman to a 185-cm-tall Japanese man, the pressure fluctuation by the movement of the aorta could be detected in all the subjects when an intersecting portion P (See FIG. 2 and FIG. 3) of the side edge of the small airbag 111 (having a width of 60 mm and a length of 160 mm) positioned closer to the center of the seatback section 510 and a lower edge thereof was set such that a length L from an upper face of a seat cushion section 520 along a surface of the seatback section 510 was 220 mm and a distance M from the center of the seatback section 510 was 80 mm. When the size of the small airbag 111 is set such that its width is in a range of 40 to 100 mm and its length is in a range of 120 to 200 mm, it is preferred that the position of the intersecting portion P is set such that the length from the upper face of the seat cushion section 520 along the surface of the seatback section 510 is in a range of 150 to 280 mm and the distance from the center of the seatback section 510 is in a range of 60 to 120 mm.

**[0037]** It is preferred that the above-described two air packs 10 are unitized such that they can be easily set at predetermined positions in the seatback section 510. Therefore, it is preferred that an air-pack unit 100 obtained by loading the air packs 10 into a receiving body

15 such as shown in FIG. 2 to FIG. 4 is configured. The receiving body 15 has bag-shaped air pack receiving portions 151 receiving the air pack 10 on both sides and, and it has a connecting portion 152 between two air pack receiving portions 151.

**[0038]** The air packs 10 are inserted into two air pack receiving portions 151, respectively. It is also preferred that a three-dimensional solid knitted fabric 40 with approximately the same size as the air pack 10 is inserted into the air pack receiving portion 151 so as to be positioned on a back face of the back surface side air pack 10 of the air pack 10 in a stacking state (see FIG. 3D). By arranging the three-dimensional solid knitted fabric 40, the air pack 10 is supported in a so-called floating manner by the three-dimensional solid knitted fabric 40, so that transmission of external vibrations from the seatback section 510 as pressure fluctuation in the air pack becomes difficult. That is, by arranging the three-dimensional solid knitted fabric 40, a spring-mass-damper system with a low spring constant is produced within the air pack from piles of the three-dimensional solid knitted fabric 40 and fluctuation of air pressure at an inputting time of high-frequency external vibrations with small amplitude. Then, the spring-mass-damper system serves as filters to low-frequency and high-frequency inputs (a low-pass filter and a high-pass filter) in the air pack 10 housing the three-dimensional solid knitted fabric 40 therein to damp the external vibrations.

**[0039]** The connecting portion 152 may be a member which can support two air packs 151 spaced from each other by a predetermined distance, and it is formed to have a width of about 60 to 120 mm. It is preferred that the connecting portion 152 is formed in a bag shape, so that a three-dimensional solid knitted fabric 45 is inserted therein (see FIG. 3D and FIG. 4). Thereby, vibrations inputted through the connecting portion 152 can also be removed effectively by inserting the three-dimensional solid knitted fabric 45 into the connecting portion 152, so that transmission of external vibrations to the air pack 10 provided with the sensor 111b can be suppressed.

**[0040]** Incidentally, as described above, the small airbag 111 can be formed of a sheet made of, for example, polyurethane elastomer (for example, Product Number "DUS605-CDR" produced by Sheedom Co., Ltd.), but it is preferred that the receiving body 15 are also made of the same material as that for the small airbag 111. The respective three-dimensional solid knitted fabrics loaded into the small airbags 111, the air pack receiving portion 151, and the connecting portion 152 are knitted fabrics having a solid three-dimensional structure having a pair of ground knitted fabrics arranged so as to be spaced from each other and many connecting strands reciprocating between the pair of ground knitted fabrics to connect both the ground knitted fabrics, as disclosed in Japanese Patent Application Laid-Open No. 2002-331603.

**[0041]** One of the ground knitted fabrics is formed of, for example, a flat knitted fabric texture (fine mesh) continuous both in a wale direction and in a course direction

from strands obtained by twisting monofilaments, while the other ground knitted fabric is formed of, for example, a knitted stitch structure having a honeycomb shape (hexagonal shape) meshes from strands obtained by twisting monofilaments. Of course, the knitted fabric texture is arbitrary, and a knitted fabric texture other than the fine mesh texture or the honeycomb shape can be adopted, and any combination of knitted fabric textures such as adoption of the fine mesh texture in both the ground knitted fabrics can be adopted in both the ground knitted fabrics. The connecting strands are knitted between the two ground knitted fabrics such that one of the ground knitted fabrics and the other are kept away from each other by a predetermined distance.

**[0042]** The elastic member made of expanded resin beads 20 is disposed between a skin member of the seatback section 510 and the receiving body 15 (air-pack unit 100) which has received the air packs 10 therein. It has a length corresponding to the entire length of two air packs 10 and it has a width corresponding to a length between top portions of two air packs 10. Therefore, it is preferred that members having such a size that a length is in a range of 400 to 600 mm and a width is in a range of about 250 to 350 mm are used. Thereby, since two air packs 10 are covered with these members, undulation feeling due to the two air packs 10 is reduced.

**[0043]** The elastic member made of expanded resin beads 20 is composed of an expanded bead body formed in a flat-plate shape and a covering material caused to adhere to an outer face of the expanded bead body. As the expanded bead body, an expanded formation body obtained by a bead method of resin containing at least one of polystyrene, polypropylene, and polyethylene is used. Incidentally, an expansion ratio is set arbitrarily and it is not limited. The covering material is caused to adhere to an outer face of the expanded bead body by adhesive, and it is a material having a high extension percentage and a high recovery rate, so that an elastic fiber nonwoven fabric whose extension percentage is at least 200% and whose recovery rate at 100% extension time is 80% is preferably used. For example, a nonwoven fabric where thermoplastic elastomer elastic fibers have been caused to adhere to one another in a melting manner, which is disclosed in Japanese Patent Application Laid-Open NO. 2007-92217, can be used. Specifically, Trade Name "Espansione" produced by KB SEIREN, LTD. can be used.

**[0044]** Also, as a covering material for covering an outer face of the elastic member made of expanded resin beads 20, for example, a nonwoven fabric made of thermoplastic polyester can be used. Specifically, a biaxial fabric (longitudinal: 20/inch, horizontal: 2.0/inch) formed from polyethylene naphthalate (PEN) fibers (1100 dtex) produced by TEIJIN LIMITED can be used.

**[0045]** As an expanded bead constituting the elastic member made of expanded resin beads 20, those having a thickness of approximately 5 to 6 mm can be used, and the expanded resin beads are formed by bonding an un-

woven cloth made of the above-described elastic fiber or an unwoven cloth made of thermoplastic polyester having a thickness of approximately 1 mm or less. In this embodiment, the above-described "Espansione" (product name) is bonded to the surface opposing the skin member 511 of the elastic member made of expanded resin beads 20 and the opposite surface thereof. As a result, transmission performance of the biological signal is improved.

**[0046]** In the embodiment, the seatback section 510 of the seat 500 configuring a human body supporting unit is provided with the skin member 511 and a cushion supporting member 512 disposed on a back surface side of the skin member 511, and the receiving body 15 (air-pack unit 100) holding the air packs 10 and the elastic members made of expanded resin beads 20 are assembled between the skin member 511 and the cushion supporting member 512. At this time, the receiving body 15 (air-pack unit 100) holding the air packs 10 is first disposed on the side of the cushion supporting member 512, and the elastic member made of expanded resin beads 20 is disposed on a surface side of the receiving body 15, these members are covered with the skin member 511. Incidentally, the cushion supporting member 512 can be formed by stretching a three-dimensional solid knitted fabric between rear end edges of a pair of right and left side frames of the seatback section 510 or can be formed of a synthetic resin plate. The skin member 511 can be provided by stretching, for example, a three-dimensional solid knitted fabric, an artificial leather, a leather, or a laminated body of these members between front edges of the pair of right and left side frames.

**[0047]** In this embodiment, thus, since the configuration where the elastic member made of expanded resin beads 20 which has predetermined sizes is disposed on the back surface side of the skin member 511 in a stacking state and the receiving body 15 (air-pack unit 100) holding the a pair of right and left air packs 10 is further disposed behind them is adopted, a person sitting on the seat is prevented from feeling undulation of the air packs 10 on his/her back, and sitting feeling is improved though the configuration having the air packs 10 for measuring biological signals is adopted. In the above-described explanation, only one sheet of the elastic member made of expanded resin beads 20 is used, but it is also possible to arrange a plurality of stacked sheets .

**[0048]** The above-described biological signal measuring means 1 incorporates the air-pack unit 100 in the seatback section 510 of the seat 500 but the air-pack unit 100 may be incorporated in a cushion for a seat attached later on the surface of the seatback section 510. Moreover, the three small airbags 111 forming the air pack 10 are connected in series but the number of the small airbags 111 may be 2 or 1. Moreover, the biological signal measuring means 1 can be configured only of the air pack 10 made of a single airbag, for example, as long as it can be used by being arranged at a position where fluctuation in the aorta on the back part can be captured.

Moreover, the above sizes are an appropriate example when three small airbags 111 connected in series are used, and it is needless to say that the size of the air pack 10 and the size of the air-pack unit 100 are not limited at all as long as the fluctuation of the aorta on the back part can be captured.

**[0049]** Subsequently, a configuration of the biological body state estimation device 60 will be described on the basis of FIG. 6. The biological body state estimation device 60 is configured to include homeostatic function level computing means (homeostatic function level computing step) 61 formed of a computer program set in a storage section such as a hard disk and output means (output step) 62. The computer program can be provided by being stored in a recording medium such as a flexible disk, a hard disk, a CD-ROM, a MO (magnetoptic disk), a DVD-ROM, a memory card and the like or can be also transmitted via a communication line.

**[0050]** The homeostatic function level computing means (homeostatic function level computing step) 61 is means for analyzing a state of a person from a time-series waveform of a pressure fluctuation signal (hereinafter referred to as an "air pack signal" depending on a case) caused by movement of the aorta on the back part detected by the biological signal measuring means 1 and sorting the homeostatic function level at a predetermined point of time into a plurality of stages and acquiring the homeostatic function level. The state of a person is roughly divided into a highly active state and a function decline state as described above and a steady state is included between the both, and a transitional state is present between each of these states. However, in this embodiment, the homeostatic function level is divided into five stages from the highly active state to the function decline state. That is, a state in which a person is the most active and does not feel fatigue while he/she is awake (highly active state) to a state in which the person feels fatigue (function decline state) are divided into five stages of the homeostatic function level. The level is divided into five stages in this embodiment, but this is not limiting. However, if the level is divided into two stages, a rapid decline over two stages or more in the homeostatic function level which detects an abnormal state (sleep prediction signal) cannot be indicated, while if the level is divided into 10 stages or more, the stages are too fine to be visually recognized, and thus, division into 3 to 10 stages is preferable. Division into five stages is more preferable. Details of how to acquire the homeostatic function level by the homeostatic function level computing means 61 will be described later.

**[0051]** The output means (output step) 62 displays a plot area having each stage of the homeostatic function level on the vertical axis and time on the lateral axis on display means 65. Then, the homeostatic function level acquired by the homeostatic function level computing means 61 is plotted on this plot area in a time series corresponding to calculated time and displayed as a line graph. By plotting the homeostatic function level in a time

series, a periodic function of the state of fluctuation to maintain homeostasis by autonomous nerves and activation by the brain is expressed.

**[0052]** The homeostatic function level on the vertical axis is, as illustrated in FIG. 11, displayed in division into five stages in this embodiment. Specifically, the highly active state (state in which a person is the most active and does not feel fatigue while awake) is displayed on the highest part, while the function decline state is displayed on the lowest part, and three stages of the homeostatic function stages are displayed between the both. Here, the center part (third from the top) is set as a steady state, the second from the top as a state between the highly active state and the steady state, and the second from the bottom is set as a state between the steady state and the function decline state, and images of the states are expressed by figures imitating faces of a person. For convenience of explanation, the highest part which is the most active state is referred to as the homeostatic function stage 1 (highly active state (state in good condition: expressed as "feeling good")), the homeostatic function stage 2 (relatively good state: expressed as "OK" or the like), the homeostatic function stage 3 (steady (ordinary) state), the homeostatic function stage 4 (slightly functional decline: expressed as "drive carefully" or the like), and the homeostatic function stage 5 (functionally declined state: expressed as "fatigued state" or the like) in the order downward.

**[0053]** FIGS. 11A to 11E show examples of the homeostatic function level of a driver expressed by line graphs on the display means 65 by the output means 62. These are graphs organizing test data of a plurality of subjects and indicating the tendencies. As the display means 65, an onboard monitor mounted at a position that can be easily seen from a driver's seat on an automobile is preferably used.

**[0054]** The example in FIG. 11A shows that, while the graph is basically drawn within a range of the homeostatic function stage 1 which is the most active state, the state changes to the homeostatic function stage 2 every 5 to 8 minutes and then, returns to the homeostatic function stage 1 repeatedly. If a person continues to maintain the homeostatic function stage 1 for a long time, the active state is maintained with a sense of tension. If a person is in a highly focused state due to tension or relaxed but highly focused, active and comfortable, a waveform fluctuates between the homeostatic function stage 1 and the homeostatic function stage 2 by means of the homeostatic function through action of the autonomous nerves. Between them, if the number of sessions of fluctuation is large, it indicates the relaxed state, while less fluctuation indicates the tensed state.

**[0055]** The example in FIG. 11B is a waveform in which the homeostatic function stage 1 changes into the homeostatic function stage 2 and fatigue gradually increases with fluctuation sequentially going back and forth through the homeostatic function stages such as from the homeostatic function stage 3, to the homeostatic function stage

2, the homeostatic function stage 3, the homeostatic function stage 4, the homeostatic function stage 3, and the homeostatic function stage 2. That is, the homeostatic function sequentially lowers with progress of the physical fatigue and a rest with sleep will be needed in the end. This is a case indicating a progress of usual fatigue without an extreme state change.

**[0056]** The example in FIG. 11C shows a case in which the fatigue progresses all at once such as from the homeostatic function stage 1 at the start of driving to the homeostatic function stage 2, the homeostatic function stage 3, and the homeostatic function stage 5. Since the fatigue progresses to the homeostatic function stage 5, the function to forcibly return the stage to the homeostatic stage 3 by the action (compensation action) of the sympathetic nerves, but after that, the state changes between the homeostatic function stage 5 and the homeostatic function stage 3 in an extremely short time. This indicates a looming state between sleepiness and a resting state, in which a human error can occur easily, and it is determined to be a state in which the driver should drive carefully.

**[0057]** The example in FIG. 11D indicates that the state returns from the homeostatic function stage 3 to the homeostatic function stage 1 by the sympathetic nerve compensation action after 15 minutes, but the state progresses from the homeostatic function stage 1 to the homeostatic stage 5 substantially one-sidedly with little fluctuation after 30 minutes. This indicates that maintenance of the homeostasis becomes increasingly difficult and it can be determined to be a state requiring rest at an early stage.

**[0058]** The example in FIG. 11E shows a graph drawn within a range of the homeostatic function stage 1, which is a highly active state with little fluctuation. This indicates a state in which a person's highly focused state continues due to over-tension, and fluctuation becomes less and the air pack does not detect fluctuation, that is, a state with over-tension caused by activation of the brain. However, a sharp protruding line occurs in which the homeostatic function level drops over two stages all at once in several to several tens of seconds (in this example, three stages from the homeostatic function stage 1 to the homeostatic function stage 4) around 25 minutes, 40 minutes, and 47 minutes in the graph in FIG. 11E and returns all at once. This sharp protruding line is a reaction to the continuation of the over-tension and leads to progress of fatigue in the over-tensed state. In this experiment, after the sharp protruding line occurs several times, micro-sleep occurs in the driver. Since this is considered to be a marked drop in the homeostatic function of a biological body, this sharp protruding line is defined to indicate sleep prediction which is a signal immediately before micro-sleep. For more accurate determination of the sleep prediction signal, not only the rapid drop of the homeostatic function level but also predominance of an absolute value acquired by the sign of a rectangular wave and the zero-crossing method is preferably considered as will be

described later. Thus, when such a protruding line occurs several times, this is determined to be a sleep prediction signal and a state requiring a rest as soon as possible.

**[0059]** As described above, according to this embodiment, the homeostatic function level can be visually and clearly captured. That is, if the driver visually captures the graph in FIG. 11A, for example, the driver understands that he/she is in a state in which smooth driving is possible, while if he/she visually captures the graph in FIG. 11C, he/she can understand that he/she is in a state in which he/she should have a rest relatively soon while paying attention to driving. If the protruding line as in FIG. 11E is visually recognized, since it is likely to be a sleep prediction signal, the driver can understand that he/she should have a rest relatively early. That is, the display by the graph on the display means 65 can stimulate and activate the brain of the driver, induce the driver to the awakening direction and promote a rest at an earlier stage when the driver looks at the display and grasps his/her own state, though only for a short time.

**[0060]** In this embodiment, when the driver looks at the graph displayed on the display means 65, the driver can easily grasp his/her own state, which promotes stimulation to the brain, and determining means (determining step) 63 for automatically determining whether a rest is needed or not or whether a sleep prediction signal has emerged can also be incorporated.

**[0061]** The determining means 63 monitors movement of a base line in the graph of the above-described homeostatic function stages. If the base line moves into a range of the homeostatic function stages 3 to 5 as in FIGS. 11C and 11D and enters a state in which recovery from fatigue is not found, an alarm by sound or vibration can be emitted. In this embodiment, the brain is activated and induced to the awakening direction by visually grasping the homeostatic function stage, but by including a so-called monitoring system by using the determining means 63, an alarm such as sound and vibration can be used at the same time. Particularly, by providing abnormal state determining means that if a sleep prediction signal as in FIG. 11E emerges three times, for example, it is determined to be an abnormal state, and a larger alarm sound or the like is emitted in the configuration, contribution can be made to more reliable suppression of drowsy driving.

**[0062]** Here, the above-described output means 62 displays the homeostatic function level of a person by a line graph in a time series, but the display means 65 can be configured to be provided with a separate screen output means 621 which outputs display different from the above-described line graph on a different screen. FIGS. 12A to 12E show images outputted to the display means 65 by this separate screen output means 621.

**[0063]** A screen displayed by the separate screen output means 621 displays, as a typical example shown in an enlarged manner in FIGS. 13, a first image portion 622 showing a state of a face of an androgynous person (the same face as that in an image diagram of the face

on the vertical axis on the line graph) in an image corresponding to the homeostatic function stages 1 to 5 and a second image portion 623 including time-series graphs in this embodiment. The first image portion 622 has a face image display portion 622a at the center, a heartbeat display portion 622b below that, a character display portion 622c above that, and a sleep prediction signal display portion 622d displayed on the right side. In the face image display portion 622a, the separate screen output means 621 displays an image of a face corresponding to one of the homeostatic function stages in accordance with the homeostatic function stage acquired by the homeostatic function level computing means 61. In the character display portion 622c, characters set by the separate screen output means 621 in accordance with each of the homeostatic function stages, that is, "feeling good", "OK", "ordinary state", "drive carefully", "fatigued state" and the like, for example, are displayed. The sleep prediction signal display portion 622d has five display lamps, and if the sleep prediction signal as shown in FIG. 11E occurs, the number of occurrences is indicated by lighting of the display lamps. As a result, a person can become aware of timing when a rest is required by looking at lighting of the display lamps.

**[0064]** On the second image portion 623, a graph of a time-series waveform of a signal of pressure fluctuation (air-pack signal) caused by movement of the aorta on the back part detected by the biological signal measuring means 1 is displayed on the upper display portion 623a, and a graph of a time-series waveform of a slope of the frequency is displayed on the lower display portion 623b.

**[0065]** Each of the first image portion 622 and the second image portion 623 displayed by the separate screen output means 621 is not limited to these displays, and when a driver visually recognizes particularly the face image display portion 622a, the character display portion 622c, and the sleep prediction signal display portion 622d of the first image portion 622, the driver can easily grasp the current situation. Since the display of the first image portion 622 only shows a state at a given moment, the driver can grasp a change in his/her state over time by looking at the screen and predict a future change in his/her state, thereby becoming strongly aware of necessity to rest. Therefore, a screen of a line graph as shown in FIGS. 11 is preferably displayed so that the driver can visually recognize it.

**[0066]** Whether the screen of the line graph in FIGS. 11 is displayed or the screen with the first image portion 622 and the second image portion 623 in FIGS. 12 is displayed at start can be arbitrarily set. This embodiment is set such that a screen with the first image portion 622 and the second image portion 623 shown in FIGS. 12 and FIG. 13 is displayed as an initial screen, and by pressing a "START" button, measurement is started, and computing by the homeostatic function level computing means 61 is started. It is set so that, pressing a "history" button will display the screen with the line graph in FIGS. 11. That is, a change at the moment is displayed by the

screen composed of the first image portion 622 and the second image portion 623 shown in FIGS. 12 and FIG. 13, and a change in a time series including a past history is displayed by a screen of the line graph shown in FIGS. 11. Moreover, in this embodiment, in order to display the screen with the line graph in FIGS. 11 during driving, each of the "START" button and the "history" button need to be operated, and that gives an advantage that activation of the brain is promoted by movement of fingers. Moreover, according to this embodiment, the screen with the line graph in FIGS. 11, the first image portion 622 (particularly the portion of the heartbeat) and the second image portion 623 in FIGS. 12, that is, three screens in total are visually recognized, but the driver trying to comprehensively grasp his/her own state from the three screens by looking at the three screens also leads to activation of the brain. If the number of screens is smaller than 3, the brain activation effect is lower, while if it is larger than 3, it is too complicated. It is needless to say that the "START" and "history" buttons are preferably provided close to a steering wheel so that the operation thereof does not disturb driving.

**[0067]** Subsequently, a specific computing method set in the homeostatic function level computing means (homeostatic function level computing step) 61 will be described. That is, the homeostatic function level computing means 61 includes frequency computing means (frequency computing step) 611, frequency slope time-series analyzing and computing means (frequency slope time-series analyzing and computing step) 612, frequency fluctuation time-series analyzing and computing means (frequency fluctuation time-series analyzing and computing step) 613, differentiating means (differentiating step) 614, integrating means (integrating step) 615, rectangular wave calculating means (rectangular wave calculating step) 616, describing function calculating means (describing function calculating step) 617, absolute value processing means (absolute value processing step) 618, and homeostatic function stage calculating means (homeostatic function stage calculating step) 619.

**[0068]** The frequency computing means 611 acquires a time-series waveform of a frequency in time-series data of an air pack signal obtained from the biological signal measuring means 1 (preferably an air-pack signal filter waveform of a predetermined frequency area subjected to filtering process as will be described later). There are two methods for obtaining this time-series waveform, the first one of which relates to HF used as an index of a parasympathetic nerve function, while the second one of which relates to LF/HF (LF is a frequency component at 0.05 to 0.20 Hz and HF is a frequency component at 0.20 to 0.35 Hz) used as an index of a sympathetic nerve function.

**[0069]** The first method is a method of acquiring a time-series waveform by using a maximum value (peak) through smoothing-differentiation of a time-series waveform of an air-pack signal (hereinafter referred to as a "peak detecting method"). The peak detecting method

is basically a time-series waveform corresponding to the function of HF and a time-series waveform on which a waveform corresponding to a compensating function of LF/HF might be superimposed. The maximum value is acquired by the smoothing-differentiation by Savitzky and Golay, for example. Subsequently, the maximum value is obtained for every 5 seconds, for example, and reciprocals of time intervals between the maximum values of the time-series waveforms (peak side top portion of the waveform) included in the 5 seconds are acquired as individual frequencies  $f$ , and a mean value of the individual frequencies  $f$  in the 5 seconds is employed as the value of a frequency  $F$  in the 5 seconds (Step [1] in FIG. 9). Then, the time-series waveform of the frequency is acquired by plotting the frequencies  $F$  obtained for every 5 seconds (Step [2] in FIG. 9).

**[0070]** The second method is a method of acquiring a time-series waveform by using a point where a positive value changes to a negative value (hereinafter referred to as "zero-crossing point") in a time-series waveform of the air pack signal (hereinafter referred to as a "zero-crossing method"). This zero-crossing method captures a basic component of the frequency of a pulse wave and corresponds to LF/HF. In this method, first, the zero-crossing point is acquired and then, that is obtained for every 5 seconds, for example, and reciprocals of time intervals between the zero-crossing points of time-series waveforms included in the 5 seconds are acquired as individual frequencies  $f$ , and a mean value of the individual frequencies  $f$  in the 5 seconds is adopted as the value of the frequency  $F$  for the five seconds (Step [1] in FIG. 9). Then, the time-series waveform of the frequency is acquired by plotting the frequencies  $F$  obtained for every 5 seconds (Step [2] in FIG. 9).

**[0071]** The frequency time-series analyzing slope and computing means (frequency slope time-series analyzing and computing step) 612 sets a time window having a predetermined time width from the time-series waveform of the frequency of the air-pack pulse wave obtained from the frequency computing means 611 using peak detecting method or zero-crossing method, and obtains the slope of the frequency of the air-pack pulse wave for each time window by least-square method to output a time series wave thereof. The frequency slope time-series waveform obtained by the frequency slope time-series analyzing and computing means 612 is outputted as the waveform indicating fluctuation of a biological body capturing balance of occurrence between the sympathetic nerve and parasympathetic nerve. Specifically, first, a slope of a frequency in a certain time window  $Tw1$  is obtained by least-square method to be plotted (Steps [3] and [5] in FIG. 9). Next, the next time window  $Tw2$  is set in an overlapped time  $TI$  (Step [6] in FIG. 9) and a slope of a frequency in this time window  $Tw2$  is similarly obtained by least-square method to be plotted. This calculation (movement calculation) is repeated sequentially to output a slope time-series waveform of the frequency of the air-pack pulse wave as a frequency slope time-series

waveform (Step [8] in FIG. 9). Incidentally, it is preferred that the time width of the time window  $Tw$  is set to 180 seconds, and it is preferred that the overlapped time  $TI$  is set to 162 seconds. These values were selected as values at which a characteristic signal emerged with the best sensitivity from sleep experiments performed while changing the time width of the time window  $Tw$  and the overlapped time  $TI$  variously, as shown in the above-described Patent Literature 3 (WO 2005/092193A1) of the present applicant.

**[0072]** The frequency fluctuation time-series analyzing and computing means (frequency fluctuation time-series analyzing and computing step) 613 sets a time window with a predetermined time width (preferably, 180 seconds) to the time-series waveform of the frequency of the air-pack pulse wave obtained by the frequency computing means 611 (Step [2] in FIG. 9) to obtain a mean value of the frequency (Steps [3] and [4] in FIG. 9). Next, movement calculation for obtaining a mean value of the frequency of the air-pack pulse wave for each predetermined time window (preferably, 180 seconds) set in the predetermined overlapped time (preferably, 162 seconds) is performed so that the mean value is plotted. Then, the time series change of the mean value of the frequency plotted for each time window is outputted as a frequency fluctuation time-series waveform (Step [7] in FIG. 9). Then, when the frequency slope time-series waveform and the frequency fluctuation time-series waveform are outputted at the same time, it is as shown at Step [9] in FIG. 9. The heartbeat can be acquired from the frequency fluctuation time-series waveform.

**[0073]** Here, the peak detecting method detects disturbance in a waveform of a biological signal or a state of a waveform, while the zero-crossing method detects a frequency component. That is, if they both match, it means proximity to a periodic function, while if they both differ from each other, it means that a plurality of components are superimposed on the waveform. The disturbance in the waveform indicates a state in which a high frequency component is superimposed on a low frequency component or a low frequency component is further superimposed on a low frequency component, the amplitude increases or decreases, which corresponds to sthenia or decline in the sympathetic nerve and relates to each state of over-tension/endurance, absent-mindedness, relaxation, looming, and activation. Therefore, by applying absolute value processing to the frequency slope time-series waveform obtained by the peak detecting method and the zero-crossing method, respectively, and comparing them, the state can be roughly determined on whether it is in an over-tensed state or in an endured state with enhanced sympathetic nerve, or in a relaxed state with predominance on the parasympathetic nerve. On the other hand, if a describing function is obtained from the frequency slope time-series waveform and if increase/decrease of the heartbeat or the like is obtained from the frequency fluctuation time-series waveform, a time-series waveform of the frequency ob-

tained by the zero-crossing method is preferable. That is because the object of calculating the describing function is to know whether the state is activity metabolism or a change in resting metabolism or to know a degree of activeness/function decline in each metabolism by examining a degree of a change in the waveform.

**[0074]** The differentiating means (differentiating step) 614 differentiates a time-series waveform of a frequency slope obtained by the frequency slope time-series analyzing and computing means 612 and examines a momentary fluctuation rate of the frequency slope time-series waveform.

**[0075]** The integrating means (integrating step) 615 integrates the time-series waveform of the frequency slope obtained by the frequency slope time-series analyzing and computing means 612 and examines accumulation of the frequency slope time-series waveform by elapsing of time.

**[0076]** The rectangular wave calculating means (rectangular wave calculating step) 616 acquires a peak of the time-series waveform of the frequency slope obtained by the frequency slope time-series analyzing and computing means 612, creates an envelope curve and draws a rectangular wave by obtaining an increasing/decreasing tendency from the slope of the envelope curve. That is, a rectangular wave is drawn such that a section with the slope of the envelope curve having an increasing tendency as positive and a section with a decreasing tendency as negative.

**[0077]** The describing function calculating means (describing function calculating step) 617 is means that applies fast Fourier transform to the frequency slope time-series waveform in the first time zone set arbitrarily and also applies fast Fourier transform to the frequency slope time-series waveform in the second time zone after the first time zone and obtains the describing function (equivalent transfer function) between the both by "fast Fourier transform in the second time zone ( $a_2 + i \cdot b_2 \dots$  ( $a_2$  is a real number part,  $b_2$  is an imaginary number part) / fast Fourier transform in the first time zone ( $a_1 + i \cdot b_1 \dots$  ( $a_1$  is a real number part,  $b_1$  is an imaginary number part)". That is, by obtaining the describing function between the both by having the frequency slope time-series waveform in the first time zone as an input function and the frequency slope time-series waveform in the second time zone as an output function, a basic state is offset, the state of a change remains, and a change in the homeostatic function of a person in the first time zone and the second time zone is captured. The first time zone and the second time zone are not limited as long as they are time widths from which a function of a frequency slope time-series waveform in each time zone can be obtained and can be set within a range of a half period to three periods (approximately 3 minutes to approximately 20 minutes, for example). It may be set statistically within a predetermined range or the time widths of the first time zone and the second time zone may be set for each individual.

**[0078]** The obtained described function is expressed

as " $(a_1 a_2 + b_1 b_2) / (a_1^2 + b_1^2) + i (a_1 b_2 - a_2 b_1) / (a_1^2 + b_1^2)$ ". It is set to " $(a_1 a_2 + b_1 b_2) / (a_1^2 + b_1^2) = A$ " and " $i (a_1 b_2 - a_2 b_1) / (a_1^2 + b_1^2) = B$ ", and a square root of " $A^2 + B^2$ " is acquired as a describing function amplitude value. By this describing function amplitude value, state changes in the two time zones are captured. The value can be set arbitrarily and may be set for each individual or may be statistically set to a predetermined value. That is, such setting can be made that the state is a resting state or a looming state or the state in which sympathetic nerve compensation action is operating or the like if the value is a predetermined value or within a range of values.

**[0079]** The absolute value processing means (absolute value processing step) 618 applies absolute value processing to the frequency slope time-series waveform obtained by the frequency slope time-series analyzing and computing means 612 and outputs the result. At this time, the absolute value processing means 618 applies the absolute value processing to the frequency slope time-series waveforms obtained by using both the peak detecting method and the zero-crossing method and outputs the results. Specifically, the frequency computing means 611 acquires the time-series waveform of the frequency of a biological signal using the peak detecting method and also acquires the time-series waveform of the frequency of the biological signal using the zero-crossing method. Then, the frequency slope time-series analyzing and computing means 612 acquires the frequency slope time-series waveform for each of the time series waveforms of the frequencies by the peak detecting method and the zero-crossing method, and the absolute value processing means 618 applies the absolute value processing to each of the frequency slope time-series waveforms (Step [10] in FIG. 9).

**[0080]** As described above, the peak detecting method detects disturbance in the waveform of the biological signal in which a high frequency component is added to a low frequency component, while the zero-crossing method detects a low frequency component of the biological signal having less disturbance in the waveform. That is, if they match each other, it means that less superimposed component is contained, while if they differ from each other, it means that more superimposed component is contained. Therefore, by comparing the two pieces of data obtained by the absolute value processing means 618, state determination can be made on whether the state is the over-tensed state or in the endured state in which the sympathetic nerve system is enhanced, the parasympathetic nerves predominate due to decline of the sympathetic nerves, the relaxed state is induced with predominance of the parasympathetic nerve without decline of the sympathetic nerve, a function decline state caused by decline of both the sympathetic/parasympathetic nerve or a state requiring a rest. That is, if the absolute value calculated by using the zero-crossing method is higher than the absolute value calculated by using the peak detecting method by the absolute value processing means 618, the state is enhanced sympa-

thetic nerve, while if not, the state can be determined to be a state with predominance on the parasympathetic nerve (See FIG. 8A).

**[0081]** The homeostatic function stage calculating means (homeostatic function stage calculating step) 619 acquires a stage of the homeostatic function level by using at least one or more of the frequency slope acquired by the frequency slope time-series analyzing and computing means 612, the differential value acquired by the differentiating means 614, the integral value acquired by the integrating means 615, the sign of the rectangular wave acquired by the rectangular wave calculating means 617, the describing function amplitude value acquired by the describing function calculating means 618, and two absolute values of the frequency slope time-series waveform acquired by the absolute value processing means 619. Applicability to which one of the above-described homeostatic function stages 1 to 5 is determined by these combinations. For example, if the frequency slope and the integral value are not less than the predetermined value, it is determined as the "homeostatic function stage 1" or if the differential value is not more than a predetermined value, the sign of the rectangular wave is "negative", the describing function amplitude value is not less than a predetermined value, and are the "peak predominates" in the two absolute values, it is determined to be the "homeostatic function stage 4". These combinations, threshold values in determination and the like are not limiting but can be determined through statistical processing of data of a plurality of subjects or can be set for each individual.

**[0082]** The state determination by the homeostatic function stage calculating means 619 is preferably made by combining the indexes as follows:

(1) The state is determined to be a homeostatic function stage 1:

- if the frequency slope time-series waveform by the zero-crossing method is positive, or
- if an integral waveform of the frequency slope time-series waveform by the zero-crossing method is positive

since, if these waveforms are positive, the sympathetic nerve activities of a person predominate, and it is suitable to be determined as a highly active state.

(2) The state is determined to be homeostatic function stage 2:

- if the frequency slope time-series waveform by the zero-crossing method is negative and if a ratio of the slope this time to the slope the previous time is a predetermined value or more and this ratio occurs a predetermined number of times or less, or
- if the integral waveform is within a range of a predetermined value,

since, even if the frequency slope time-series waveform is negative, if it is not less than a predetermined value or if the integral waveform is within a range of a predetermined value, a certain degree of active state is maintained.

(3) The state is determined to be homeostatic function stage 3:

- if the frequency slope time-series waveform by the zero-crossing method is negative, the ratio of the slope this time to the slope the previous time is a predetermined value or more and this ratio occurs a predetermined number of times or more, or
- if the integral waveform is within a range of a predetermined value (a range lower than that of the homeostatic function stage 2), or
- if the differential waveform is not more than a predetermined value,

since the balance between the sympathetic nerve and the parasympathetic nerve shows a good state within these ranges.

(4) The state is determined to be homeostatic function stage 4:

- if the differential waveform is not more than a predetermined value (value lower than that of the homeostatic function stage 3), or
- if the integral waveform is within a range of a predetermined value (value lower than that of the homeostatic function stage 3), or
- if the describing function amplitude value of the slope time-series waveform is not less than a predetermined value, the rectangular wave is negative, and the absolute value calculated by the peak detecting method becomes more predominant than the absolute value by the zero-crossing method,

since the parasympathetic nerve activities tend to gradually become predominant in these ranges.

(5) The state is determined to be homeostatic function stage 5:

- if the differential waveform is not more than a predetermined value (value lower than that of the homeostatic function stage 4), or
- if the integral waveform is not more than a predetermined value (value lower than the lower limit value in the case of the homeostatic function stage 4), or
- if the describing function amplitude value of the slope time-series waveform is not less than a predetermined value (value higher than that of the homeostatic function stage 4), the rectangular wave is negative, and the absolute value calculated by the peak detecting method is more

predominant than the absolute value by the zero-crossing method,

since the parasympathetic nerve activities become predominant and fatigue is felt due to functional decline in these ranges.

(6) The state is determined to be sleeping prediction:

- if the absolute value calculated by the zero-crossing method is more predominant than the absolute value calculated by the peak detecting method, the rectangular wave is positive, and the graph indicating the homeostatic function stage drops over 2 stages or more,

since it is large movement departing from the range of fluctuation and microsleep occurs after this phenomenon occurs.

**[0083]** Here, the conventional determination having been made by the applicant by using the frequency slope time-series waveform and the frequency fluctuation time-series waveform is made mainly on a state caused by a metabolic change of a person called a sleep prediction signal. That is, a process in which a human body is getting tired one-sidedly as time elapses is mainly examined. However, the display by the line graphs as in FIGS. 11A to 11E displayed by the homeostatic function stage calculating means 619 in this embodiment is made by combining a plurality of indexes, that is, the frequency slope, the differential value, the integral value, the sign of the rectangular wave, the describing function amplitude value, and the absolute value as described above. Thus, not only the state change of a person caused by the metabolic action but a recovering performance and an attenuation performance of the homeostatic function in each state are also suggested, and activation caused by the stimulation of the brain and the state change can be also examined. The mechanism is as follows:

**[0084]** First, in the sleep state, the metabolic energy is at the lowest level, while in the normal/motion state, the energy level is at a high level, and the resting state is located inbetween. The steady driving state in the relaxed state has an energy level close to the resting state. On the other hand, struggle against sleep, consideration/attention to the peripheral situation, dangerous driving and the like raises the heartbeat and brings the state close to the normal/motion state. Maintenance of homeostasis in each state is adjusted so that a fluctuation width determined by the physical/mental capabilities of an individual is not departed.

**[0085]** It is known that characteristics of the state change of a person can be extracted by low-dimensional chaos. The fluctuation of the homeostatic function in the sleep state fluctuates chaotically and it fluctuates at random or periodically (hereinafter this is called as non-chaotically) in the normal/active state. In the state indicating this non-chaotic fluctuation, adaptability to an environ-

mental change such as an external stress becomes poor. Under the situation in which a chaotic fluctuation is shown while a driver is driving a car, the driver cannot perceive external vibration easily and is easily subjected to an influence of fluctuation of respiration and heartbeat. That is, the chaotic fluctuation minimizes an energy consumption amount for maintaining homeostasis and suppresses progress of fatigue. The driver in this state is induced into the relaxed state, and over-tension of sympathetic nerve is alleviated. On the other hand, in the non-chaotic fluctuation state, the external vibration can easily transmit to the driver, influencing respiration and heartbeat, wasteful force is raised in the organs, and a resistant feeling of fatigue is generated. This feeling of fatigue increases the energy consumption amount, and the gradient of progress of fatigue becomes larger. Here, the person enters a state with enhanced sympathetic nerves.

**[0086]** The homeostatic function of a human body was considered by replacing it with a spring-mass-damper system. The spring system is a function for accumulating energy and converting it to a force, and this was supposed as the sympathetic nerve system. On the other hand, the damper system is a function for damping the energy, and this was supposed as the parasympathetic nerve system. The mass is supposed as a cardiocirculatory organ system which is a life-sustaining function. A biological body was controlled by two functions of the homeostatic function, that is, a central system in charge of homeostasis of the life-sustaining function and a periphery system relaxing stimulation from the external world. Since the characteristics of these two functions include non-linearity, they are expressed as the describing functions. An air-pack sensor placed on the back part mainly captures the state close to the central system. A signal captured by the air-pack sensor is fluctuation in aorta caused by movement of the heart.

**[0087]** A human being controls maintenance of homeostasis by the autonomous nerve system. The parasympathetic nerve does not cause large fluctuation. Therefore, predominance of the parasympathetic nerve is generated by function decline of the sympathetic nerve. That is, stability of the heartbeat is controlled by the balance of the sympathetic nerve to the parasympathetic nerve. An excessive rise of the heartbeat is suppressed by the parasympathetic nerve (as a result, vagovagal reflex occurs and infrequency pulse develops.). A human being has a natural state in which the sympathetic nerve and the parasympathetic nerve are balanced, a tensed state with enhanced sympathetic nerve, a fatigued state in which functions of both the sympathetic nerve and the parasympathetic nerve decline, and a relaxed state corresponding to a recovery period with predominance on the parasympathetic nerve, and combination of them produces flexibility to deal with a change and helps maintenance of homeostasis.

**[0088]** From the above, estimation of a human state is to find out a change in the autonomous nerve system as an inverse problem. First, it is determined whether the

human state is in a tensed state or a relaxed state from differential information of fluctuation of a biological body and degree of occurrence of fluctuation in the sympathetic nerve and the parasympathetic nerve (FIG. 8A). Then, it is determined whether the state is an active state, a resting state, a function decline state or a transitional state thereof by examining a characteristic change in the fluctuation waveform (FIG. 8B). Subsequently, the state after that is estimated from the combination of the past states (FIG. 8C). The combination of the past states is information on the state protrusion of the fluctuation waveform indicating enhanced sympathetic nerve and the number of occurrences thereof, the state of rapid progress of fatigue (rapid change in the homeostatic function), the number of the rapid changes, and a rectangular wave indicating the tendency of fluctuation in the frequency of heartbeat. They are helpful in estimation of a sleeping prediction phenomenon.

**[0089]** On the other hand, considering a process of fatigue according to contribution rates of mental fatigue and physical fatigue, natural progress of fatigue has been said to have three stages, that is, a stage in which fatigue is not felt, a stage in which the feeling of fatigue is compensated for by the compensating action of the sympathetic nerve and the feeling of fatigue is not felt, and a stage in which the feeling of fatigue is felt and a human error occurs.

**[0090]** However, it is considered that the contribution rate of mental fatigue is high in the tensed state, while the physical fatigue governs the progress of fatigue in the relaxed state. However, in the prior-art idea on the progress of fatigue does not consider suppression of fatigue by activation of the brain function. Under a general driving environment, the brain function is activated regardless of the progress degree of fatigue. This activation of the brain function includes creativity, curiosity and the like, and they induce awakening.

**[0091]** This is known from the fact, as shown in FIGS. 11A to 11E, that not only an increase/decrease by the biological fluctuation (metabolic action) but also a process in which the homeostatic function stage rapidly returns to the original stage occurs or a process in which the homeostatic function stage rarely progresses even if time elapses. That is, it is considered that the graph shows not only the state in which a human body is tired but also an enlarging process of an allowance for the fatigue. The enlargement of the allowance for the fatigue is based on an instruction from the brain, that is, activation caused by activation of the brain, and this graph can be considered to capture not only the state change of a person by the metabolic action but also a change in the state of the person caused by the brain action (particularly, the "state of mind"). Therefore, in the present embodiment, the estimation of the "state of a person (biological body)" includes not only inference of the state change caused by the metabolic action but also an inference of the progress of fatigue from the state of performance decline through the fluctuation state of the homeostatic function

and estimation of the state change by reactivation caused by activation of the brain.

**[0092]** The state estimation process by the biological body state estimation device 60 will be described on the basis of a flowchart in FIG. 7. First, an air-pack signal by movement of an aorta on the back part is obtained by the biological signal measuring means 1 (S101). The air-pack signal at S101 is not the signal itself of pressure fluctuation of the air pack but a signal after being subjected to predetermined filtering (analog filtering process to reduce a noise signal other than the biological signal). This air-pack signal can be also processed by the frequency computing means 611, but in order to improve accuracy, the filtering means is further applied to this air-pack signal (S102), and a signal waveform (air-pack signal digital filter waveform) of a frequency area required for analysis is obtained (S103). This further filtering means (hereinafter referred to as "digital filtering means") removes vibration (noise) inputted from a car-body floor during running of an automobile as much as possible. Thus, this digital filtering means is configured such that, under a static environment (the phrase "under a static environment" referred to in this description also means under a measuring environment in an idling state (a state in which vibration caused by irregularity on the road surface such as during running is not inputted) that can be considered to be a substantially static environment (that is, a static equivalent environment) in addition to the measuring environment in which the engine is not started and vibration is not inputted at all), a biological signal is measured by the biological signal measuring means 1 for several seconds to several tens of seconds, its mean frequency is obtained, and a frequency band (a lower-limit frequency and an upper-limit frequency) to be filtered is set with the mean frequency as a reference value. As a result, mixing of vibration waveform inputted through the car-body floor from the road surface during running becomes less, and an air-pack signal filter waveform obtained under the static environment to which the digital filtering means is applied and an air-pack signal digital filter waveform obtained during running form substantially the same waveform supposing that the homeostatic function stage of the person is the same.

**[0093]** A method of acquiring the mean frequency to be a reference in the digital filtering means is not limited, but in this embodiment, a waveform of the biological signal itself obtained by the biological signal measuring means 1 (that is, the pressure waveform) is differentiated (or preferably, second-order differentiation), full-wave rectification is applied to the differential waveform, and moreover, a low-pass filter is applied. The filtering frequency of the low-pass filter is set as appropriate within a range of 1 to 3 Hz which is a general frequency of the biological signal caused by movement of an aorta on the back part. A peak is acquired from the waveform subjected to the low-pass filter, and moreover, a mean frequency is acquired from a time interval of the peaks. The waveforms obtained by applying filtering by this method

are shown in FIGS. 10A and 10B. FIG. 10A shows comparison between the air-pack signal waveform and the air-pack signal digital filter waveform in the idling state under the static equivalent environment, while FIG. 10B shows comparison between the air-pack signal waveform and the air-pack signal digital filter waveform during driving (during running). From these figures, the air-pack signal waveform shows a vertically protruding disturbed waveform during driving (running), different from that in the idling state under the static equivalent environment, while the air-pack signal digital filter waveform is substantially the same waveform both in the static idling state and during driving (running). Therefore, to measure the biological signal in advance in the idling state (static equivalent environment) before running and performing filtering by using it as a reference is extremely preferable in obtaining a measurement result with high accuracy.

**[0094]** The air-pack signal filter waveform obtained at S103 is processed by the frequency computing means 611 and the time-series waveform of the frequency of the air-pack signal filter waveform is acquired by the zero-crossing method and the peak detecting method (S104). Subsequently, the frequency slope time-series waveform, its differential waveform (differential value), the integral waveform (integral value), the rectangular wave, and the describing function (describing function amplitude value) are acquired by using the time-series waveform of the frequency of the air-pack signal filter waveform by the zero-crossing method, and the waveforms obtained by applying the absolute value processing to the frequency slope time-series waveform of the zero-crossing method and the frequency slope time-series waveform by the peak detecting method are acquired (S105). Subsequently, the homeostatic function stage is determined by the homeostatic function stage calculating means 619 (S106), and the result is outputted to the display means 65 by the output means 62 (S107).

(Test example 1)

**[0095]** As a test for verifying effectiveness of a signal of pressure fluctuation caused by movement of an aorta of the back part (air pack signal) detected by the biological signal measuring means 1 provided with the air pack 10 according to this embodiment, comparison with electrocardiograms was made.

**[0096]** Subjects are four people in their 20's to 30's (two men and two women). Measurement items are electrocardiograms and a signal of pressure fluctuation (air pack signal) obtained from the air pack brought into contact with portions in a human body. The air pack signal was sampled from the cervical part, the upper arm, the radius, and the femora by using the automobile seat 500 of the above-described embodiment and a mattress for a bed. The experiment was conducted by measuring for 3 minutes in the sitting position and the supine position, respectively.

**[0097]** FIGS. 14 are comparison results of the electro-

cardiogram and the air pack signal of a 30-year-old female subject, and FIG. 14A shows a part of original waveforms of the air pack signal and the electrocardiogram. By comparing the original waveform of the electrocardiogram with the original waveform of the air pack signal, it can be observed that a peak value (R wave) of the electrocardiogram substantially matches the minimum value of the air pack signal. FIG. 14B shows a result of comparison of the heartbeat frequency time-series waveforms calculated from the air pack signal and the electrocardiogram. Regarding the heartbeat frequency, the waveforms match in the electrocardiogram, the back part, and the cervical part both in the sitting position and the supine position. The other three subjects showed similar results, and particularly the electrocardiogram and the back-part air pack signal stably matched. Moreover, in the state of the supine position, even if temporary disturbance was observed due to a body motion, high correlation with the electrocardiogram was shown, and the disturbance did not lead to collapse.

**[0098]** The back-part air pack signal is a biological signal obtained from the portion closest to the heart and has high correlation with the cardiogram, and thus, the air pack sensor provided on the back part is considered to capture fluctuation in the aorta caused by movement of the heart. Moreover, reversal of polarity of the original waveforms of the electrocardiogram and the air pack signal is considered to correspond to the relation of dilation of the arterial vessel in the systole when the heart contracts and contraction of the arterial vessel in the diastole when the heart is relaxed and dilated by inflow of blood. A large shift between the electrocardiogram and the air pack signal shown at A, B, and C parts in FIG. 14B is caused by a body motion. That is, the air pack signal can be considered to be able to sensitively capture a change by the body motion. A slight body motion of the subject on an automobile seat with high restrictive characteristic cannot be captured as the A, B, and C parts in FIG. 14B, but a body motion by a large driving operation (such that the body is largely arched out to the front and the like) can be captured as the A, B, and C parts in FIG. 14B. These body motions are generated when a person is in an unstable state different from the usual stated or in an abnormal state, and thus, once a signal can no longer be detected by the air pack sensor, it can be determined to be an abnormal state.

(Test example 2)

- Analysis example 1 -

(Test condition)

**[0099]** A male subject A in his 50's, a female subject B in her 40's, and a male subject B in his 40's were made to travel back and forth by car between Higashi-Hiroshima city, Hiroshima Prefecture and Kurobe city, Toyama Prefecture. They stayed in Kurobe city on the first night

and stayed in Kyoto city on the second night. They headed to Kurobe city from Higashi-Hiroshima city on the first day, from Kurobe city to Kyoto city on the second day, and on the third day travelled from Kyoto city to Osaka city, had a meeting and then, they headed to Higashi-Hiroshima city. The test was conducted while the three subjects took turns as appropriate in driving. The seat 500 in which the air pack 10 of this embodiment was incorporated in the seat back portion 510 was mounted on the driver's seat of the vehicle used for the test. The results are shown in FIG. 15 to 30. In the figures, A shows a frequency slope time-series waveform obtained from the frequency slope time-series analyzing and computing means 612 using the zero-crossing method (displayed by the "air-pack pulse wave frequency slope" in the figures) and a frequency fluctuation waveform obtained from the frequency fluctuation time-series analyzing and computing means 613 (displayed as the "air pack pulse wave frequency fluctuation" in the figures). B shows a change of a describing function (transmission function) obtained by the describing function calculating means 617 by using the frequency slope time-series waveform of A, and C shows a change of the rectangular wave obtained from the rectangular wave calculating means 616 by using the frequency slope time-series waveform of A. D shows a change (determination result) of the homeostatic function stage calculated by the homeostatic function stage calculating means 619 by using each data of A to C and F and the like. E shows a graph obtained by integrating an absolute value by the peak detecting method and an absolute value by the zero-crossing method obtained by the absolute value processing means 618, respectively. F shows a change in the time series of the absolute value by the peak detecting method and the absolute value by the zero-crossing method obtained by the absolute value processing means 618. G shows an integral waveform of the frequency slope time-series waveform.

(Consideration)

**[0100]** The determination result shown in D in each figure and the actual state of each subject will be mainly described.

(1) Male subject A, Kurobe area 1 (outward trip) (FIG. 15)

The subject felt a feeling of fatigue from the start of measurement to approximately 2000 seconds but maintained a relatively good state. Alleviation in the feeling of fatigue was caused by biological fluctuation, and the compensation action of the sympathetic nerve is not considered to take place. After that, a sleep prediction phenomenon occurred, and the fatigue progressed. Then, at some 3000 seconds, sleepiness occurred and gave up driving to someone else.

(2) Female subject B, Kurobe area 2 (outward trip)

(FIG. 16)

A good state continued from 1800 to 3000 seconds. During the other time, traffic jam (a slow driving car blocked a fast lane) irritated the subject during driving. Occurrence of sleepiness is found at some 4200 seconds.

(3) Male subject A, Kurobe area 3 (outward trip) (FIG. 17)

A good state continued for the first 600 seconds, but traffic jam occurred after that, and the subject entered the fatigued state. The fatigue during this period was mainly caused by a mental factor, and the first sleep prediction signal occurred at some 5100 seconds. After that, the compensating action of the sympathetic nerve functioned, and the second sleep prediction signal occurred at some 9600 seconds. Due to the fatigue caused by irritation caused by traffic jam, driving at night, and tension, the driver had supper at occurrence of the second sleep prediction signal.

(4) Male subject A, Kurobe area 4 (outward trip) (FIG. 18)

After the supper, the subject regained energy but that did not last long, and the sympathetic compensation action against sleepiness occurred at some 1200 seconds. After that, a good state with enhanced sympathetic nerve lasted till 2000 seconds. In the middle, the level of the sympathetic nerve lowered to a state with predominance on the parasympathetic, and the first sleep prediction signal occurred. At 2300 seconds and after, natural progress of fatigue was found with drop of tension.

(5) Female subject B, Kurobe area 5 (outward trip), (FIG. 19)

The sympathetic compensation action occurred at the start of measurement, and the subject was in the fatigued state with tension. A section in which the brain function was considered to be activated in the relaxed state was found from some 1000 to 1850 seconds, and after that, the fatigue tended to recover, and the highly active state was induced though with some feeling of fatigue. This is considered that the activation of the brain function induced the relaxed state and promoted recovery from fatigue.

(6) Male subject A, Kurobe area 6 (outward trip) (FIG. 20)

Sleeping in the seat next to the driver was effective, and a state in which a feeling of fatigue was not felt was found till some 1200 seconds. After that, wakefulness naturally lowered, but this is considered to have been caused in conjunction with drop in circadian rhythm.

(7) Male subject A, Kyoto area 1 (return trip) (FIG. 21)

From the start to 700 seconds, an influence of fatigue from the previous day was found. After that, the subject lost his way and thus had to think. The activation of the brain function is considered to be induced by the effect of this thinking. When the activation of the

brain function subsided, fatigue progressed as a counteraction.

(8) Male subject A, Kyoto area 2 (return trip) (FIG. 22) The feeling of fatigue after the meeting increased the biological fluctuation, and the subject fell into the fatigued state all at once. The male subject A felt hungry, but discovery of a bakery around 1100 seconds raised the degree of arousal all at once.

(9) Male subject A, Kyoto area 3 (return trip) (FIG. 23) The subject ate bread and that made him discursive, and the notice of "drive carefully" was displayed. After that, the feeling of fatigue was gently alleviated in the relaxed state. In the middle, the level of the sympathetic nerve lowered, and sleepiness occurred approximately twice. After that, biological fluctuation occurred, and the state got close to awakening again.

(10) Female subject A, Kyoto area 4 (return trip) (FIG. 24)

The feeling of fatigue was felt immediately after the start of driving, and enhancement of the sympathetic nerve was found. The tensed state continued and sleepiness occurred immediately before the subject finished driving.

(11) Male subject A, Kyoto area 5 (return trip) (FIG. 25)

Fatigue was felt from the beginning, and the subject tried to maintain homeostasis while fluctuating. The function decline was found, and the sympathetic compensation action occurred at approximately 2400 seconds. After that, sleepiness occurred but recovered by the sympathetic compensation action. After that, the tension relieved and entered the relaxed state, which is considered to have raised the feeling of fatigue.

(12) Male subject A, Kyoto area 6 (return trip) (FIG. 26)

After the rest, the subject resumed driving but he received a phone call on business during the rest. Immediately after the start of driving, the state quickly returned to that before the rest. After that, irritation seeming to be caused by the phone call continued. At 4600 seconds and after, rapid function decline and sleepiness occurred once each while the sympathetic nerve kept enhanced.

(13) Male subject A, Kyoto area 7 (return trip) (FIG. 27)

After the rest, the subject resumed driving. After the rest, tension and enhanced sympathetic nerve were relieved, and the feeling of fatigue occurred all at once. In order to solve the feeling of fatigue, the subject had an energy drink in the relaxed state and temporarily recovered but amplitude of the biological fluctuation became large after that, and the feeling of fatigue was alleviated. The energy drink is considered to promote recovery by biological fluctuation while inducing the subject to become relaxed.

(14) Male subject B, Higashi-Hiroshima area 1 (re-

turn trip) (FIG. 28)

No accumulation of fatigue. This subject dealt with a feeling of fatigue in a tensed state while dexterously using fluctuation. Sleepiness occurred after 2550 seconds. The function decline after that was caused by irritation due to a slow driving car blocking the lane.

(15) Male subject B, Higashi-Hiroshima area 2 (return trip) (FIG. 29)

Meal and rest solved the feeling of fatigue and recovered a good condition. Sleepiness and large fluctuation occurred as a counteraction to the tension, but the tensed state by the sympathetic compensation action recovered the state without feeling of fatigue.

(16) Male subject B, Higashi-Hiroshima area 3 (return trip) (FIG. 30)

At slightly after 1200 seconds, the feeling of fatigue suddenly appeared. It temporarily recovered due to the sympathetic compensation action but the recovery did not last long. At the end, expectation for arrival induced the tensed state, and the feeling of fatigue reduced.

[0101] From the above, the actual state of each of the subjects can be considered to match well with the state determined from the determination result shown in each figure D.

(Test example 3)

- Analysis example 2 -

(Test condition)

[0102] A cushion incorporating the air pack 10 of the above-described embodiment was attached to the seat back portion of a driver's seat of a large-sized truck, and an experiment on state estimation of a driver in long-distance driving at night was conducted. The experiment was conducted for a round trip on an express way for approximately 500 km between Tokyo and Osaka. The driver left Tokyo around 10 pm, took a rest for approximately 1 hour at a service station close to the middle point and then, resumed the experiment and headed for Osaka. After the driver arrived at Osaka around 5 am, he slept for approximately 6 to 8 hours and started the return trip experiment for Tokyo around 10 pm. In the return trip, too, as in the outward trip, the driver took a rest for approximately 1 hour at a service station close to the middle point. The subjects were four healthy men in their 30 to 40's. Biological signals used for the measurement were pressure waveforms sampled from the back parts.

(Consideration)

[0103] FIGS. 31A to 31D show results of the fatigue

experiment conducted in the round trip between Tokyo and Osaka of a subject A. The vertical axis indicates the homeostatic function stages 1 to 5 (from the normal (highly active state) to abnormal (function decline state) in the figures), and the lateral axis indicates the time axis. FIG. 31A shows the state of a change in the homeostatic function between Tokyo and Miai of the subject A on the outward trip. The center axis of fluctuation is located in the homeostatic function stage 2 or 3, and the fluctuation occurs on the basis of that. Moreover, the ratio of the homeostatic function stage 1 amounted to 52.5% of the entire route, and it can be observed that the subject was taking efforts in driving in the tensed state with predominance on the sympathetic nerve.

**[0104]** FIG. 31B shows a degree of progress of fatigue of the subject A on the return trip from Osaka to Ogasa. Similarly to FIG. 31A, in the subject A in FIG. 31B, fluctuation occurred on the basis of the homeostatic function stage 2 or 3. A difference is that the time zone staying in the homeostatic function stage 1 is shorter. The progress of fatigue certainly becomes quicker, and it seems that the fatigue cannot be fully relieved even after the long-time sleep.

**[0105]** FIG. 31C shows a degree of progress of fatigue of the subject A on the outward trip from Miai to Oasaka after a rest. In this process, the state substantially the same as that before the rest was shown. Therefore, the rest can be considered to be effective for relieving fatigue. FIG. 31D shows the state of a change in the homeostatic function of the subject A on the return trip from Ogasa to Tokyo after the rest. In this process, since a phenomenon different from that in the outward trip in FIG. 31C is shown, it is assumed that the rest is temporarily effective in relieving fatigue but does not have an improvement effect for the accumulated fatigue. From these four examples, it is suggested that activation of the homeostatic function can be expected by having a rest during the outward trip, even though the effect is temporary. Regarding the rest on the return trip, the improvement effect is not found due to accumulation of fatigue, but there seems to be a fatigue suppression effect. Similar results were obtained for the other three subjects.

**[0106]** Even if fatigue progresses as time elapses, when the graph obtained by plotting the homeostatic function level in a time series is within a range of fluctuation corresponding to biological fluctuation (in a range of one to two stages of the homeostatic function level with respect to the substantially center position of the fluctuation at that point), there is no problem. Thus, in order to facilitate visual grasping on whether or not the graph is within the range, the range of fluctuation is preferably made clear as shown in FIGS. 32A and 32B. In FIG. 32A, the range of the fluctuation with respect to the center is indicated by vertically extending arrows, while in FIG. 32B, the range is surrounded by an A line indicating the upper limit and a B line indicating the lower limit.

**[0107]** Moreover, as shown in FIG. 32C, in order to clearly display occurrence of the sleep prediction signal

in the time-series graph, the graph can be configured to display the stage of the "sleep prediction" under the homeostatic function stages 1 to 5. If the graph rapidly drops and it is determined to be sleep prediction by the abnormal state determining means of the determining means 63, the lower end of the graph at that time is displayed by being extended to the "sleep prediction" stage displayed on the lowermost stage. As a result, timing when the sleep prediction signal occurs can be visually and easily grasped.

**[0108]** As the biological signal measuring means, not only that using the above-described air pack 10 but also that shown in FIG. 33 can be used. Biological signal measuring means 200 shown in FIG. 33 includes three-dimensional solid knitted fabric 210, a three-dimensional solid knitted fabric support member 215, a film 216, plate-shaped expanded bodies 221 and 222, and a vibration sensor 230.

**[0109]** For the three-dimensional solid knitted fabric 210, that similar to the biological signal measuring means 1 shown in FIG. 1 and the like can be used. The three-dimensional solid knitted fabric 210 preferably has a load-deflection characteristic in the thickness direction within a range up to the load of 100 N when it is placed on a measurement plate and pressurized by a pressurizing plate having a diameter of 30 mm or a diameter of 98 mm and a spring constant approximated to the load-deflection characteristic of muscle of a human breech. Specifically, that with the spring constant within a range of 0.1 to 5 N/mm when being pressurized by a pressurizing plate with a diameter of 30 mm or the spring constant within a range of 1 to 10 N/mm when being pressurized by a pressurizing plate with a diameter of 98 mm is preferably used. By using that approximated to the load-deflection characteristic of the muscle of a human breech, the three-dimensional solid knitted fabric is balanced with the muscle, and when a biological signal is transmitted, the three-dimensional solid knitted fabric generates vibration similar to the human muscle, and the biological signal can be transmitted without large attenuation.

**[0110]** The plate-shaped expanded bodies 221 and 222 are preferably formed of an expanded bead body. As the expanded bead body, a foamed molding by a resin bead method containing at least any one of polystyrene, polypropylene, and polyethylene can be used, for example. The plate-shaped expanded bodies 221 and 222 made of an expanded bead body transmit a biological signal accompanied by slight amplitude as membrane oscillation (lateral wave) due to the characteristic of a spherical resin membrane formed by foams constituting individual micro beads. This membrane oscillation (lateral wave) is transmitted to the three-dimensional solid knitted fabric as string vibration, the membrane oscillation (lateral wave) and the string vibration are superimposed with each other, and the biological signal is detected by a vibration sensor 230, which will be described later, as amplified mechanical vibration by superimposition of the membrane oscillation (lateral wave) and the

string vibration. Therefore, detection of the biological signal is facilitated.

**[0111]** If the plate-shaped expanded bodies 221 and 222 are composed of expanded bead bodies, the expansion ratio is preferably within a range of 25 to 50 times and the thickness is preferably not more than a mean diameter of the bead. If the mean diameter of the bead with 30-times foaming is 4 to 6 mm, for example, the thickness of each of the plate-shaped expanded bodies 221 and 222 is subjected to slice cutting to approximately 3 to 5 mm. As a result, soft elasticity is given to the plate-shaped expanded bodies 221 and 222, which makes them resonate with vibration with small amplitude, and a lateral wave transmitting on the film can no longer be attenuated easily. The plate-shaped expanded bodies 221 and 222 may be arranged on the both sides of the three-dimensional solid knitted fabric 210 in a sandwiching manner as in this embodiment, but they can be also arranged only on one side or preferably only on the seat back side.

**[0112]** Here, the three-dimensional solid knitted fabric 210 having a strip shape within a range of width of 40 to 10 mm and a length of 100 to 300 mm is used. The knitting with this size can easily cause pre-compression (state in which tension is generated in connecting yarns) in the three-dimensional solid knitted fabric 210, and an equilibrium state can be easily made between a person and the three-dimensional solid knitted fabric 210. In this embodiment, in order to reduce a sense of discomfort felt by a person when the back part is in contact, two sheets are symmetrically disposed while sandwiching the portion corresponding to the spine. In order to arrange the three-dimensional solid knitted fabric 210 easily at a predetermined position, the three-dimensional solid knitted fabric 210 is preferably configured to be supported by a three-dimensional solid knitted fabric support member 215. The three-dimensional solid knitted fabric support member 215 is molded into a plate shape, and two vertically long arrangement through holes 215a and 215a are formed at symmetrical positions while sandwiching the portion corresponding to the spine. The three-dimensional solid knitted fabric support member 215 is preferably formed of an expanded bead body formed having a plate shape similarly to the above-described plate-shaped expanded bodies 221 and 222. Preferable ranges of an expansion ratio and thickness when the three-dimensional solid knitted fabric support member 215 is formed of an expanded bead body are the same as that of the plate-shaped expanded bodies 221 and 222. However, in order to generate the membrane oscillation (lateral wave) more distinctively by a biological signal, the thicknesses of the plate-shaped expanded bodies 221 and 222 laminated above and below the three-dimensional solid knitted fabrics 210 and 210 are preferably smaller than the thickness of the three-dimensional solid knitted fabric support member 215.

**[0113]** While the two pieces of three-dimensional solid knitted fabrics 210 and 210 are inserted into the arrange-

ment through holes 215a and 215a formed in the three-dimensional solid knitted fabric support member 215, films 216 and 216 are laminated on the front side and the back side of the three-dimensional solid knitted fabrics 210 and 210. The formation positions of the arrangement through holes 215a and 215a (that is, the disposed positions of the three-dimensional solid knitted fabrics 210 and 210) are preferably positions corresponding to regions where fluctuation caused by movement with stroke of atrium and aorta (particularly, the "descending aorta") and movement of an aorta valve (cardiac fluctuation wave) can be detected. As a result, the three-dimensional solid knitted fabrics 210 and 210 are sandwiched by the plate-shaped expanded bodies 221 and 222 on the upper and lower faces and the peripheral edge portion is surrounded by the three-dimensional solid knitted fabric support member 215, so that the plate-shaped expanded bodies 221 and 222 and the three-dimensional solid knitted fabric support member 215 perform the function of a resonant-vibration box (resonant box).

**[0114]** Moreover, the three-dimensional solid knitted fabrics 210 and 210 are preferably thicker than the three-dimensional solid knitted fabric support member 215 in use. That is, if the three-dimensional solid knitted fabrics 210 and 210 are arranged in the arrangement through holes 215a and 215a, they should have a thickness relationship such that the front surface and the back surface of the three-dimensional solid knitted fabrics 210 and 210 protrude from the arrangement through holes 215a and 215a. As a result, when the peripheral edge portions of the films 216 and 216 are bonded to the peripheral edge portions of the arrangement through holes 215a and 215a, the three-dimensional solid knitted fabrics 210 and 210 are pressed in the thickness direction. Thus, a tension caused by a reaction force of the films 216 and 216 is generated, and solid vibration (membrane oscillation (lateral wave)) can easily occur in the films 216 and 216. On the other hand, pre-compression occurs also in the three-dimensional solid knitted fabrics 210 and 210, tension caused by a reaction force is generated also in the connecting yarn holding the thickness form of the three-dimensional solid knitted fabric, and string vibration can easily occur. The films 216 and 216 are preferably provided on the both the front side and the back side of the three-dimensional solid knitted fabrics 210 and 210, but they may be configured to be provided at least on one of them. As the films 216 and 216, a plastic film made of polyurethane elastomer (for example, Product Number "DUS605-CDR" produced by Sheedom Co., Ltd.) and the like can be used, for example.

**[0115]** The vibration sensor 230 is disposed by being fixed to either one of the three-dimensional solid knitted fabric 210 before the above-described films 216 and 216 are laminated. The three-dimensional solid knitted fabric 210 is composed of a pair of ground knitted fabrics and the connecting yarn, but since the string vibration of each connecting yarn is transmitted to the films 216 and 216 and the plate-shaped expanded bodies 221 and 222

through a joint with the ground knitted fabric, a sensing portion 230a of the vibration sensor 230 is preferably fixed to the surface of the three-dimensional solid knitted fabric 210 (the surface of the ground knitted fabric). As the vibration sensor 230, a microphone sensor or particularly a capacitive microphone sensor is preferably used. In this embodiment, since a sealing property of a site where the microphone sensor is disposed (that is, the arrangement through hole 215a in which the three-dimensional solid knitted fabric 210 is disposed) does not have to be considered, lead wires of the microphone sensor can be wired easily. A vibration of a body surface generated by a biological signal via a muscle of a person is transmitted not only to the three-dimensional solid knitted fabric 210 but also to the plate-shaped expanded bodies 221, 222 and the film 216, so that it is amplified due to overlapping of vibrations (string vibration and membrane oscillation (lateral wave)) of these members while attenuation is prevented. Therefore, the vibration sensor 230 is not limited to fixation to the three-dimensional solid knitted fabric 210 and the sensing portion 230a thereof may be fixed to the plate-shaped expanded bodies 221, 222 and the film 216 configuring a vibration transmission route.

**[0116]** The biological signal measuring means 200 is not limited to that shown in FIG. 33 but a film 217 having the size that can cover both of the two three-dimensional solid knitted fabrics 210 and 210 may be used at least for one of the front side and the back side of the three-dimensional solid knitted fabrics 210 and 210 as illustrated in FIG. 34A, for example. Moreover, as shown in FIG. 34B, a lumber support 218 obtained such that the substantially rectangular three-dimensional solid knitted fabric is bent toward the center part from the both end edges and the overlapped center parts are sewn together may be arranged. The lumber support 218 is fixed to the three-dimensional solid knitted fabric support member 215 by using a planar faster or the like. By providing the lumber support 218 as above, contribution can be made to improve a stroke feeling in a narrow space.

**[0117]** The above-described biological signal measuring means 200 is arranged inside a skin 1200 covering a seatback frame 1100 of an automobile seat 1000, for example, as shown in FIG. 35. In order to facilitate an arrangement work, it is preferable that the three-dimensional solid knitted fabric 210, the three-dimensional solid knitted fabric supporting member 215, the film 216, the plate-shaped expanded bodies 221, 222, the vibration sensor 230 and the like configuring the biological signal measuring means 200 are unitized in advance.

**[0118]** According to the above-described biological signal measuring means 200, membrane oscillation (lateral wave) occurs in the plate-shaped expanded bodies 221, 222 and the film 216 having the load-deflection characteristic similar to the load-deflection characteristic of a muscle and a string vibration occurs in the three-dimensional solid knitted fabric 210 having the load-deflection characteristic

of a muscle of a person by a biological signal. Then, the string vibration of the three-dimensional knitted fabric 210 affects the membrane oscillation (lateral wave) of the film 216 and the like again, and the vibration and oscillation serve in a superimposed state. As a result, vibration inputted from the body surface with occurrence of a biological signal is directly detected by the vibration sensor 230 as a solid vibration amplified by superimposition of the string vibration and the membrane oscillation (lateral wave) without attenuation.

**[0119]** In the case of the biological signal measuring means 1 which detects air pressure fluctuation within the air pack 10, shown in FIG. 1 and the like, since a volume and pressure are inversely proportional to each other, it is difficult to detect pressure fluctuation unless the volume of a sealing bag is made small. On the other hand, according to the biological signal measuring means 200 shown in FIGS. 33 to 35, since an amplified solid vibration transmitted to the mechanical amplifying device (the three-dimensional solid knitted fabric 210, the plate-shaped expanded bodies 221, 222, the film 216 or the film 217) is detected, as described above, instead of the air pressure fluctuation, the volume (cubic volume) is hardly limited from the viewpoint of detection sensitivity, so that a vibration with small amplitude as a cardiac oscillation wave can be detected with a high sensitivity. Therefore, the biological signal measuring means 200 can accommodate persons having various physical builds. Accordingly, the biological signal measuring means 200 shown in FIGS. 33 to 35 can detect a biological signal with a high sensitivity even under such an environment where the means is utilized by persons having various physical builds and various external vibrations are inputted like an vehicle seat.

#### Industrial Applicability

**[0120]** The present invention can be applied to estimation of a state of a person by arranging a biological signal measuring means on bedding such as a bed, capturing oscillation of an aorta on the back part, and analyzing the result by the above-described biological body state estimation device. As a result, a health state of a lying person (particularly, patients and those requiring care) can be easily grasped from a screen displayed on a monitor of the display means. Similarly, the present invention can be also applied to state estimation by arranging the biological signal measuring means on chairs disposed at home, office chairs and the like. As a result, health states in a daily life can be easily grasped.

#### Reference Signs List

##### **[0121]**

- 1: biological signal measuring means
- 10: air pack
- 15: receiving body

100: air-pack unit  
 20: elastic member made of expanded resin beads  
 40, 45: three-dimensional solid knitted fabric  
 500: seat  
 510: seatback section 5  
 511: skin member  
 512: cushion supporting member  
 520: seat cushion section  
 60: biological body state estimation device  
 61: homeostatic function level computing means 10  
 611: frequency computing means (frequency computing step)  
 612: frequency slope time-series analyzing and computing means (frequency slope time-series analyzing and computing step) 15  
 613: frequency fluctuation time-series analyzing and computing means (frequency fluctuation time-series analyzing and computing step)  
 614: differentiating means (differentiating step)  
 615: integrating means (integrating step) 20  
 616: rectangular wave calculating means (rectangular wave calculating step)  
 617: describing function calculating means (describing function calculating step)  
 618: absolute value processing means (absolute value processing step) 25  
 619: homeostatic function stage calculating means (homeostatic function stage calculating step)  
 62: output means  
 63: determining means 30  
 65: display means

## Claims

1. A biological body state estimation device (60) for estimating a degree of progress of fatigue of a person when driving, using a biological signal obtained from an upper body of a person by using a biological signal measuring means (10, 11b), the biological body state estimation device (60) comprising: 35
- a) computing means (61) arranged to analyze the biological signal, calculate, using the biological signal, values of a function that is indicative of a level of fatigue of the person, and sort each of the calculated values at a respective predetermined point of time into one of a plurality of stages of the function; and 45
- b) output means (62) arranged to plot the calculated values in a time series by taking each stage of the function on the vertical axis and time on the lateral axis and display a fluctuation degree of the function values on display means (65) as a graph; 50
- 55

wherein the computing means (61) includes:

a1) frequency computing means (611) arranged to acquire a frequency of the biological signal obtained by the biological signal measuring means (10, 11b);

**characterised in that** the computing means (61) includes:

a2) frequency slope time-series analyzing and computing means (612) arranged to conduct a movement calculation to acquire a slope of the frequency for each predetermined time window set with a predetermined overlapped time from the frequency of the biological signal obtained by the frequency computing means (611) and acquire a time-series waveform of the slope of the frequency obtained for each time window;

a3) differentiating means (614) arranged to differentiate the time-series waveform of the frequency slope acquired by the frequency slope time-series analyzing and computing means (612);

a4) integrating means (615) arranged to integrate the time-series waveform of the frequency slope acquired by the frequency slope time-series analyzing and computing means (612);

a5) rectangular wave calculating means (616) arranged to acquire a rectangular wave from increase/decrease of the time-series waveform of the frequency slope acquired by the frequency slope time-series analyzing and computing means (612);

a6) describing function calculating means (617) arranged to acquire a describing function and a describing function amplitude value between the frequency slope time-series waveform in an arbitrarily set first time zone and the frequency slope time-series waveform in a second time zone after the first time zone;

a7) absolute value processing means (618) arranged to apply absolute value processing to the time-series waveform of the respective frequency slopes acquired by the frequency slope time-series analyzing and computing means (612) by using a time-series waveform of a frequency of a biological signal using a maximum value of the time-series waveform of the biological signal obtained by the frequency computing means (611) and a time-series waveform of a frequency of a biological signal using a zero-crossing point where the sign of the time-series waveform of the biological signal is switched; and

a8) calculating means (619) arranged to acquire the stage of the function by using at least one or more of the frequency slope acquired by the frequency slope time-series analyzing and computing means (611), the differential value acquired by the differentiating means (614), the integral value acquired by the integrating means

- (615), the sign of the rectangular wave acquired by the rectangular wave calculating means (616), the describing function amplitude value acquired by the describing function calculating means (617), and two absolute values of the frequency slope time-series waveform acquired by the absolute value processing means (618).
2. The biological body state estimation device (60) according to claim 1, wherein
- a9) the computing means (61) is arranged to acquire and sort the function values into a range of 3 to 10 stages from a highly active state to a functional decline state; and
- b9) the output means (62) is arranged to sort and display the function values in a range of 3 to 10 stages on the vertical axis with the highly active state as the highest part and the functional decline state as the lowest part.
3. The biological body state estimation device (60) according to claim 2, wherein
- a10) the computing means (61) is arranged to acquire and sort the function values into five stages from the highly active state to the functional decline state; and
- b10) the output means (62) is arranged to sort and display the function values into five stages on the vertical axis with the highly active state as the highest part and the functional decline state as the lowest part.
4. The biological body state estimation device (60) according to any one of claims 1 to 3, further comprising:
- c) determining means (63) arranged to determine a change in the state of a person from a graph displayed on the display means (65) by the output means (62).
5. The biological body state estimation device (60) according to claim 4, wherein
- c1) the determining means (63) has abnormal state determining means (63) arranged to determine an abnormal state if a rapid decline over two stages or more of the function occurs a predetermined number of times or more on the graph displayed on the display means (65) by the output means (62).
6. The biological body state estimation device (60) according to any one of claims 1 to 5, further comprising:
- d) filtering means arranged to filter the biological signal obtained by the biological signal measuring means (10, 11b) in a predetermined frequency band before being processed by the computing means (61), wherein
- d1) the filtering means is configured to set a frequency band for filtering by acquiring a mean frequency of the biological signal under a static environment measured by the biological signal measuring means (10, 11b) and using the mean frequency as a reference value.
7. The biological body state estimation device (60) according to any one of claims 1 to 6, wherein
- e) the biological signal measuring means (10, 11b) is provided with an air pack (10) to be brought into contact with the back part of a person, and whose pressure is arranged to fluctuate with fluctuation in aorta caused by movement of the heart; and
- a11) the computing means (61) is arranged to use the pressure fluctuation of the air pack (10) as the biological signal to be analyzed.
8. The biological body state estimation device (60) according to claim 7, wherein the air pack (10) is equipped to a seatback section (510) of an vehicle seat (500).
9. The biological body state estimation device (60) according to any one of claims 1 to 8, wherein the display means (65) is an onboard monitor.
10. A computer program incorporated in a biological body state estimation device (60) according to claim 1 that estimates a degree of progress of fatigue of a person when driving, by using a biological signal obtained from the upper body of the person by a biological signal measuring means (10, 11b), comprising instructions, which when the program is executed by the biological body state estimation device, cause the device to carry out the following steps:
- a) a computing step (61) that analyzes the biological signal, calculates, using the biological signal, values of a function that is indicative of a level of fatigue of the person, and sorts each of the calculated values at a respective predetermined point of time into one of a plurality of stages of the function; and
- b) an output step (62) that plots the calculated values in a time series with each stage of the function on the vertical axis and time on the lateral axis and displays it by the display means (65) as a graph;
- wherein the computing step (61) includes:
- a1) a frequency computing step (611) that acquires a frequency of a biological signal obtained

by the biological signal measuring means (10, 11b);

**characterised in that** the computing step further includes:

a2) a frequency slope time-series analyzing and computing step (612) that conducts a movement calculation to acquire a slope of the frequency for each predetermined time window set with a predetermined overlapped time from the frequency of the biological signal obtained by the frequency computing step (611) and acquires a time-series waveform of the slope of the frequency obtained for each time window;

a3) a differentiating step (614) that differentiates the time-series waveform of the frequency slope acquired by the frequency slope time-series analyzing and computing step (612);

a4) an integrating step (615) that integrates the time-series waveform of the frequency slope acquired by the frequency slope time-series analyzing and computing step (612);

a5) a rectangular wave calculating step (616) that acquires a rectangular wave from increase/decrease of the time-series waveform of the frequency slope acquired by the frequency slope time-series analyzing and computing step (612);

a6) a describing function calculating step (617) that acquires a describing function and a describing function amplitude value between the frequency slope time-series waveform in an arbitrarily set first time zone and the frequency slope time-series waveform in a second time zone after the first time zone;

a7) an absolute value processing step (618) that applies absolute value processing to the time-series waveform of the respective frequency slopes acquired by the frequency slope time-series analyzing and computing step (612) by using a time-series waveform of a frequency of a biological signal using a maximum value of the time-series waveform of the biological signal obtained by the frequency computing step (611) and a time-series waveform of a frequency of a biological signal using a zero-crossing point where the sign of the time-series waveform of the biological signal is switched; and

a8) a calculating step (619) that acquires the stage of the function by using at least one or more of the frequency slope acquired by the frequency slope time-series analyzing and computing step (611), the differential value acquired by the differentiating means (614), the integral value acquired by the integrating means (615), the sign of the rectangular wave acquired by the rectangular wave calculating means (616), the describing function amplitude value acquired by the describing function calculating step (617),

and two absolute values of the frequency slope time-series waveform acquired by the absolute value processing step (618).

5 **11.** The computer program according to claim 10, wherein the graph displayed by the display means (65) by the output step (62) is a line graph.

10 **12.** The computer program according to claim 10 or 11, wherein

a9) the computing step (61) acquires and sorts the values of the function into five stages from the highly active state to the functional decline state; and

b9) the output step (62) sorts and displays the function values in five stages with the highly active state as the highest part and the functional decline state as the lowest part on the vertical axis.

15 **13.** The computer program according to any one of claims 10 to 12, further comprising instructions, which when the program is executed by the biological body state estimation device, cause the device to carry out the following step: c) a determining step (63) that determines a change in the state of a person from a graph displayed on the display means (65) by the output step (62).

20 **14.** The computer program according to claim 13, wherein  
c1) the determining step (63) has an abnormal state determining step (63) that determines an abnormal state if a decline over two stages or more of the function occurs a predetermined number of times or more on the graph displayed on the display means (65) by the output step (62).

#### 40 Patentansprüche

45 **1.** Vorrichtung (60) zur Ermittlung eines biologischen Körperzustands zur Ermittlung eines Fortschrittsgrads der Ermüdung einer Person beim Fahren unter Verwendung eines biologischen Signals, das von einem Oberkörper einer Person unter Verwendung eines biologischen Signalmessmittels (10, 11b) erhalten wird, wobei die Vorrichtung (60) zur Ermittlung eines biologischen Körperzustands Folgendes umfasst:

a) ein Rechenmittel (61), das dazu ausgelegt ist, das biologische Signal zu analysieren, unter Verwendung des biologischen Signals Werte einer Funktion zu berechnen, die ein Maß für die Ermüdung der Person anzeigen und jeden der berechneten Werte zu einem jeweiligen vorbe-

stimmten Zeitpunkt in eine von einer Vielzahl von Stufen der Funktion zu sortieren; und  
 b) ein Ausgabemittel (62), das dazu ausgelegt ist, die berechneten Werte in einer Zeitreihe aufzutragen, indem jede Stufe der Funktion auf der vertikalen Achse und Zeit auf der Querachse übernommen wird und ein Schwankungsgrad der Funktionswerte auf dem Anzeigemittel (65) als eine Grafik angezeigt wird;

wobei das Rechenmittel (61) Folgendes einschließt:

a1) ein Frequenzrechenmittel (611), das dazu ausgelegt ist, eine Frequenz des biologischen Signals zu erfassen, das von dem biologischen Signalmessmittel (10, 11b) erhalten wird; **dadurch gekennzeichnet, dass** das Rechenmittel (61) Folgendes einschließt:

a2) ein Zeitreihenanalyse- und Rechenmittel (612) der Frequenzsteigung, das dazu ausgelegt ist, eine Bewegungsberechnung zum Erfassen einer Steigung der Frequenz für jedes vorbestimmte Zeitfenster auszuführen, das mit einer vorbestimmten Überlappungszeit von der Frequenz des durch das Frequenzrechenmittel (611) erhaltenen biologischen Signals festgelegt ist und eine Zeitreihenwellenform der Steigung der Frequenz zu erfassen, die für jedes Zeitfenster erhalten wird;

a3) ein Differenzierungsmittel (614), das dazu ausgelegt ist, die Zeitreihenwellenform der Frequenzsteigung zu differenzieren, die durch das Zeitreihenanalyse- und Rechenmittel (612) der Frequenzsteigung erfasst wird;

a4) ein Integrationsmittel (615), das dazu ausgelegt ist, die Zeitreihenwellenform der Frequenzsteigung zu integrieren, die durch das Zeitreihenanalyse- und Rechenmittel (612) der Frequenzsteigung erfasst wird;

a5) ein Rechteckwellenberechnungsmittel (616), das dazu ausgelegt ist, eine Rechteckwelle aus einer Zunahme/Abnahme der Zeitreihenwellenform der Frequenzsteigung, die durch das Zeitreihenanalyse- und Rechenmittel (612) der Frequenzsteigung erfasst wird, zu erfassen;

a6) ein Beschreibungsfunktionsberechnungsmittel (617), das dazu ausgelegt ist, eine Beschreibungsfunktion und einen Beschreibungsfunktionsamplitudenwert zwischen der Zeitreihenwellenform der Frequenzsteigung in einer willkürlich festgelegten ersten Zeitzone und der Zeitreihenwellenform der Frequenzsteigung in einer zweiten Zeitzone nach der ersten Zeitzone zu erfassen;

a7) ein Absolutwertverarbeitungsmittel (618), das dazu ausgelegt ist, eine Absolutwertverarbeitung an die Zeitreihenwellenform der jeweiligen Frequenzsteigungen anzulegen, die durch

das Zeitreihenanalyse- und Rechenmittel (612) der Frequenzsteigung unter Verwendung einer Zeitreihenwellenform einer Frequenz eines biologischen Signals unter Verwendung eines Maximalwerts der Zeitreihenwellenform des biologischen Signals, das von dem Frequenzrechenmittel (611) erhalten wird und einer Zeitreihenwellenform einer Frequenz eines biologischen Signals unter Verwendung eines Nulldurchgangspunkts, an dem das Vorzeichen der Zeitreihenwellenform des biologischen Signals umgeschaltet wird, erfasst werden; und  
 a8) ein Berechnungsmittel (619), das dazu ausgelegt ist, die Stufe der Funktion unter Verwendung mindestens einer oder mehrerer der von dem Zeitreihenanalyse- und Rechenmittel (611) der Frequenzsteigung erfassten Frequenzsteigungen, des Differenzwerts, der durch das Differenzierungsmittel (614) erfasst wird, des integralen Werts, der von dem Integrationsmittel (615) erfasst wird, des Vorzeichens der Rechteckwelle, das durch das Rechteckwellenberechnungsmittel (616) erfasst wird, des Beschreibungsfunktionsamplitudenwerts, der durch das Beschreibungsfunktionsberechnungsmittel (617) erfasst wird und zwei absoluten Werten der Zeitreihenwellenform der Frequenzsteigung, die durch das Absolutwertverarbeitungsmittel (618) erfasst werden, zu erfassen.

2. Vorrichtung (60) zur Ermittlung eines biologischen Körperzustands nach Anspruch 1, wobei

a9) das Rechenmittel (61) dazu ausgelegt ist, die Funktionswerte zu erfassen und in einen Bereich von 3 bis 10 Stufen von einem hochaktiven Zustand zu einem funktionalen Abnahmestadium zu sortieren; und

b9) das Ausgabemittel (62) dazu ausgelegt ist, die Funktionswerte in einen Bereich von 3 bis 10 Stufen auf der vertikalen Achse mit dem hochaktiven Zustand als dem höchsten Teil und dem funktionalen Abnahmestadium als dem niedrigsten Teil zu sortieren und anzuzeigen.

3. Vorrichtung (60) zur Ermittlung eines biologischen Körperzustands nach Anspruch 2, wobei

a10) das Rechenmittel (61) dazu ausgelegt ist, die Funktionswerte zu erfassen und in fünf Stufen vom hochaktiven Zustand zum funktionalen Abnahmestadium zu sortieren; und

b10) das Ausgabemittel (62) dazu ausgelegt ist, die Funktionswerte in fünf Stufen auf der vertikalen Achse mit dem hochaktiven Zustand als dem höchsten Teil und dem funktionalen Abnahmestadium als dem niedrigsten Teil zu sortieren und anzuzeigen.

4. Vorrichtung (60) zur Ermittlung eines biologischen Körperzustands nach einem der Ansprüche 1 bis 3, weiter umfassend:  
 c) ein Bestimmungsmittel (63), das dazu ausgelegt ist, eine Änderung des Zustands einer Person anhand einer Grafik zu bestimmen, die auf dem Anzeigemittel (65) durch das Ausgabemittel (62) angezeigt wird. 5
5. Vorrichtung (60) zur Ermittlung eines biologischen Körperzustands nach Anspruch 4, wobei  
 c1) das Bestimmungsmittel (63) ein Mittel (63) zur Bestimmung eines abnormalen Zustands aufweist, das dazu ausgelegt ist, einen abnormalen Zustand zu bestimmen, wenn eine schnelle Abnahme über zwei Stufen oder mehr der Funktion in der auf dem Anzeigemittel (65) durch das Ausgabemittel (62) angezeigten Grafik eine vorbestimmte Anzahl von Malen oder mehr auftritt. 10 15 20
6. Vorrichtung (60) zur Ermittlung eines biologischen Körperzustands nach einem der Ansprüche 1 bis 5, weiter umfassend:  
 d) ein Filtermittel, das dazu ausgelegt ist, das von dem biologischen Signalmessmittel (10, 11b) erhaltene biologische Signal in einem vorbestimmten Frequenzband zu filtern, bevor es von dem Rechenmittel (61) verarbeitet wird, wobei  
 d1) das Filtermittel dazu konfiguriert ist, ein Frequenzband zum Filtern durch Erfassen einer mittleren Frequenz des biologischen Signals in einer statischen Umgebung, gemessen durch das biologische Signalmessmittel (10, 11b), und Verwenden der mittleren Frequenz als Referenzwert festzulegen. 25 30 35
7. Vorrichtung (60) zur Ermittlung eines biologischen Körperzustands nach einem der Ansprüche 1 bis 6, wobei  
 e) das biologische Signalmessmittel (10, 11b) mit einer Luftpackung (10) versehen ist, die mit der Rückseite einer Person in Kontakt gebracht werden soll und deren Druck dazu ausgelegt ist, mit Schwankung in der Aorta zu schwanken, die durch die Bewegung des Herzens verursacht wird; und  
 a11) das Rechenmittel (61) dazu ausgelegt ist, die Druckschwankung der Luftpackung (10) als das zu analysierende biologische Signal zu verwenden. 40 45 50
8. Vorrichtung (60) zur Ermittlung eines biologischen Körperzustands nach Anspruch 7, wobei die Luftpackung (10) an einem Rückenlehnenabschnitt (510) eines Fahrzeugsitzes (500) vorgesehen ist. 55
9. Vorrichtung (60) zur Ermittlung eines biologischen Körperzustands nach einem der Ansprüche 1 bis 8, wobei das Anzeigemittel (65) ein fahrzeugeigener Monitor ist.
10. Computerprogramm, das in einer Vorrichtung (60) zur Ermittlung eines biologischen Körperzustands nach Anspruch 1 enthalten ist, das einen Grad des Fortschritts der Ermüdung einer Person beim Fahren durch Verwenden eines biologischen Signals ermittelt, das von dem Oberkörper der Person durch ein biologisches Signalmessmittel (10, 11b) erhalten wird, umfassend Anweisungen, die, wenn das Programm von der Vorrichtung zur Ermittlung eines biologischen Körperzustands ausgeführt wird, die Vorrichtung veranlassen, die folgenden Schritte auszuführen:  
 a) einen Berechnungsschritt (61), der das biologische Signal analysiert, unter Verwendung des biologischen Signals Werte einer Funktion berechnet, die ein Maß für einen Grad der Ermüdung der Person anzeigen, und jeden der berechneten Werte zu einem jeweiligen vorbestimmten Zeitpunkt in eine aus einer Vielzahl von Stufen der Funktion sortiert; und  
 b) einen Ausgabeschritt (62), der die berechneten Werte in einer Zeitreihe mit jeder Stufe der Funktion auf der vertikalen Achse und Zeit auf der Querachse aufträgt und sie durch das Anzeigemittel (65) als eine Grafik anzeigt;  
 wobei der Berechnungsschritt (61) einschließt:  
 a1) einen Frequenzrechenschritt (611), der eine Frequenz eines biologischen Signals erfasst, das von dem biologischen Signalmessmittel (10, 11b) erhalten wird; **dadurch gekennzeichnet, dass** der Rechenschritt weiter Folgendes einschließt:  
 a2) einen Zeitreihenanalyse- und Rechenschritt (612) der Frequenzsteigung, der eine Bewegungsberechnung durchführt, um eine Steigung der Frequenz für jedes vorbestimmte Zeitfenster, das mit einer vorbestimmten Überlappungszeit von der Frequenz des durch den Frequenzrechenschritt (611) erhaltenen biologischen Signals eingestellt ist, zu erfassen und eine Zeitreihenwellenform der Steigung der Frequenz erfasst, die für jedes Zeitfenster erhalten wird;  
 a3) einen Differenzierungsschritt (614), der die Zeitreihenwellenform der Frequenzsteigung differenziert, die durch den Zeitreihenanalyse- und Rechenschritt (612) der Frequenzsteigung erfasst wird;  
 a4) einen Integrationsschritt (615), der die Zeitreihenwellenform der Frequenzsteigung integriert, die durch den Zeitreihenanalyse- und Re-

chenschritt (612) der Frequenzsteigung erfasst wird;

a5) einen Rechteckwellenberechnungsschritt (616), der eine Rechteckwelle aus der Zunahme/Abnahme der Zeitreihenwellenform der Frequenzsteigung erfasst, die durch den Zeitreihenanalyse- und Rechenschritt (612) der Frequenzsteigung erfasst wird;

a6) einen Beschreibungsfunktionsberechnungsschritt (617), der eine Beschreibungsfunktion und einen Beschreibungsfunktionsamplitudenwert zwischen der Zeitreihenwellenform der Frequenzsteigung in einer willkürlich festgelegten ersten Zeitzone und der Zeitreihenwellenform der Frequenzsteigung in einer zweiten Zeitzone nach der ersten Zeitzone erfasst;

a7) einen Absolutwertverarbeitungsschritt (618), der eine Absolutwertverarbeitung auf die Zeitreihenwellenform der jeweiligen Frequenzsteigungen anwendet, die durch den Zeitreihenanalyse- und Rechenschritt (612) der Frequenzsteigung durch Verwenden einer Zeitreihenwellenform einer Frequenz eines biologischen Signals unter Verwendung eines Maximalwerts der Zeitreihenwellenform des biologischen Signals erfasst werden, das durch den Frequenzberechnungsschritt (611) und eine Zeitreihenwellenform einer Frequenz eines biologischen Signals unter Verwendung eines Nulldurchgangspunkts erhalten wird, an dem das Vorzeichen der Zeitreihenwellenform des biologischen Signals umgeschaltet wird; und

a8) einen Berechnungsschritt (619), der die Stufe der Funktion unter Verwendung von mindestens einer oder mehreren der durch den Zeitreihenanalyse- und Berechnungsschritt (611) der Frequenzsteigung erfassten Frequenzsteigung, des Differenzwerts, der von dem Differenziermittel (614) erfasst wird, des Integralwerts, der von dem Integrationsmittel (615) erfasst wird, des Vorzeichens der Rechteckwelle, das durch das Rechteckwellenrechenmittel (616) erfasst wird, des Beschreibungsfunktionsamplitudenwerts, der durch den Beschreibungsfunktionsberechnungsschritt (617) erfasst wird und zwei Absolutwerten der Zeitreihenform der Frequenzsteigung, die durch den Absolutwertverarbeitungsschritt (618) erfasst werden, erfasst.

11. Computerprogramm nach Anspruch 10, wobei die Grafik, die durch das Anzeigemittel (65) durch den Ausgabeschritt (62) angezeigt wird, eine Liniengrafik ist.

12. Computerprogramm nach Anspruch 10 oder 11, wobei

a9) der Rechenschritt (61) die Funktionswerte

erfasst und in fünf Stufen vom hochaktiven Zustand zum funktionalen Abnahmestadium sortiert; und

b9) der Ausgabeschritt (62) die Funktionswerte in fünf Stufen mit dem hochaktiven Zustand als dem höchsten Teil und dem funktionalen Abnahmestadium als dem niedrigsten Teil auf der vertikalen Achse sortiert und anzeigt.

13. Computerprogramm nach einem der Ansprüche 10 bis 12, weiter umfassend Anweisungen, die, wenn das Programm von der Vorrichtung zur Ermittlung des biologischen Körperzustands ausgeführt wird, bewirken, dass die Vorrichtung den folgenden Schritt ausführt:

c) einen Bestimmungsschritt (63), der eine Änderung des Zustands einer Person aus einer Grafik bestimmt, die auf dem Anzeigemittel (65) durch den Ausgabeschritt (62) angezeigt wird.

14. Computerprogramm nach Anspruch 13, wobei c1) der Bestimmungsschritt (63) einen Schritt (63) zur Bestimmung eines abnormalen Zustands aufweist, der einen abnormalen Zustand bestimmt, wenn eine Abnahme über zwei Stufen oder mehr der Funktion in der auf dem Anzeigemittel (65) durch den Ausgabeschritt (62) angezeigten Grafik eine vorbestimmte Anzahl von Malen oder mehr auftritt.

## Revendications

1. Dispositif d'estimation d'état biologique corporel (60) pour estimer un degré d'évolution de fatigue d'une personne lorsqu'elle conduit, en utilisant un signal biologique obtenu à partir d'un corps supérieur d'une personne en utilisant un moyen de mesure de signal biologique (10, 11b), le dispositif d'estimation d'état biologique corporel (60) comprenant :

a) un moyen de calcul (61) agencé pour analyser le signal biologique, calculer, en utilisant le signal biologique, des valeurs d'une fonction qui est indicative d'un niveau de fatigue de la personne, et pour trier chacune des valeurs calculées à un moment prédéterminé respectif dans l'un d'une pluralité de stades de la fonction ; et b) un moyen d'émission (62) agencé pour tracer les valeurs calculées en série temporelle en prenant chaque stade de la fonction sur l'axe vertical et le temps sur l'axe latéral et afficher un degré de fluctuation des valeurs de fonction sur un moyen d'affichage (65) sous forme de graphique ;

dans lequel le moyen de calcul (61) inclut :

a1) un moyen de calcul de fréquence (611)

agencé pour acquérir une fréquence du signal biologique obtenu par le moyen de mesure de signal biologique (10, 11b) ;

**caractérisé en ce que** le moyen de calcul (61) inclut :

a2) un moyen d'analyse et de calcul en série temporelle de pente de fréquence (612) agencé pour effectuer un calcul de mouvement pour acquérir une pente de la fréquence pour chaque fenêtre temporelle prédéterminée fixée avec un temps de recoupement prédéterminé à partir de la fréquence du signal biologique obtenue par le moyen de calcul de fréquence (611) et acquérir une forme d'onde en série temporelle de la pente de la fréquence obtenue pour chaque fenêtre temporelle ;

a3) un moyen de différenciation (614) agencé pour différencier la forme d'onde en série temporelle de la pente de fréquence acquise par le moyen d'analyse et de calcul en série temporelle de la pente de fréquence (612) ;

a4) un moyen d'intégration (615) agencé pour intégrer la forme d'onde en série temporelle de la pente de fréquence acquise par le moyen d'analyse et de calcul en série temporelle de pente de fréquence (612) ;

a5) un moyen de calcul d'onde rectangulaire (616) agencé pour acquérir une onde rectangulaire à partir d'une augmentation/diminution de la forme d'onde en série temporelle de la pente de fréquence acquise par le moyen d'analyse et de calcul en série temporelle de pente de fréquence (612) ;

a6) un moyen de calcul d'une fonction descriptive (617) agencé pour acquérir une fonction descriptive et une valeur d'amplitude de fonction descriptive entre la forme d'onde en série temporelle de pente de fréquence dans une première zone temporelle fixée arbitrairement et la forme d'onde en série temporelle de pente de fréquence dans une seconde zone temporelle après la première zone temporelle ;

a7) un moyen de traitement de valeur absolue (618) agencé pour appliquer un traitement de valeur absolue à la forme d'onde en série temporelle des pentes de fréquence respectives acquises par le moyen d'analyse et de calcul en série temporelle de pente de fréquence (612) en utilisant une forme d'onde en série temporelle d'une fréquence d'un signal biologique en utilisant une valeur maximale de la forme d'onde en série temporelle du signal biologique obtenue par le moyen de calcul de fréquence (611) et une forme d'onde en série temporelle d'une fréquence d'un signal biologique en utilisant un point de passage par zéro où le signe de la forme d'onde en série temporelle du signal biologique est inversé ; et

a8) un moyen de calcul (619) agencé pour acquérir le stade de la fonction en utilisant au moins un ou plusieurs parmi la pente de fréquence acquise par le moyen d'analyse et de calcul en série temporelle de la pente de fréquence (611), la valeur différentielle acquise par le moyen de différenciation (614), la valeur intégrale acquise par le moyen d'intégration (615), le signe de l'onde rectangulaire acquise par le moyen de calcul d'onde rectangulaire (616), la valeur d'amplitude de fonction descriptive acquise par le moyen de calcul de fonction descriptive (617), et deux valeurs absolues de la forme d'onde en série temporelle de la pente de fréquence acquises par le moyen de traitement de valeur absolue (618).

2. Dispositif d'estimation d'état biologique corporel (60) selon la revendication 1, dans lequel

a9) le moyen de calcul (61) est agencé pour acquérir et trier les valeurs de fonction en une plage de 3 à 10 stades depuis un stade hautement actif à un stade de déclin fonctionnel ; et

b9) le moyen d'émission (62) est agencé pour trier et afficher les valeurs de fonction en une plage de 3 à 10 stades sur l'axe vertical avec l'état hautement actif en tant que partie la plus élevée et l'état de déclin fonctionnel en tant que partie la plus basse.

3. Dispositif d'estimation d'état biologique corporel (60) selon la revendication 2, dans lequel

a10) le moyen de calcul (61) est agencé pour acquérir et trier les valeurs de fonction en cinq stades depuis le stade hautement actif jusqu'au stade de déclin fonctionnel ; et

b10) le moyen d'émission (62) est agencé pour trier et afficher les valeurs de fonction en cinq stades sur l'axe vertical avec l'état hautement actif en tant que partie la plus élevée et l'état de déclin fonctionnel en tant que partie la plus basse.

4. Dispositif d'estimation d'état biologique corporel (60) selon l'une quelconque des revendications 1 à 3, comprenant en outre :

c) un moyen de détermination (63) agencé pour déterminer un changement de l'état d'une personne à partir d'un graphique affiché sur le moyen d'affichage (65) par le moyen d'émission (62).

5. Dispositif d'estimation d'état biologique corporel (60) selon la revendication 4, dans lequel

c1) le moyen de détermination (63) a un moyen de détermination d'état anormal (63) agencé pour déterminer un état anormal si un déclin rapide sur deux

- stades ou plus de la fonction se produit un nombre de fois prédéterminé ou plus sur le graphique affiché sur le moyen d'affichage (65) par le moyen d'émission (62).
- 5
6. Dispositif d'estimation d'état biologique corporel (60) selon l'une quelconque des revendications 1 à 5, comprenant en outre :
- 10
- d) un moyen de filtrage agencé pour filtrer le signal biologique obtenu par le moyen de mesure de signal biologique (10, 11b) dans une bande de fréquence prédéterminée avant d'être traité par le moyen de calcul (61), dans lequel d1) le moyen de filtrage est configuré pour fixer une bande de fréquence pour un filtrage par l'acquisition d'une fréquence moyenne du signal biologique dans un environnement statique mesuré par le moyen de mesure de signal biologique (10, 11b) et en utilisant la fréquence moyenne comme valeur de référence.
- 15
- 20
7. Dispositif d'estimation d'état biologique corporel (60) selon l'une quelconque des revendications 1 à 6, dans lequel
- 25
- e) le moyen de mesure de signal biologique (10, 11b) est fourni avec un dispositif à poche d'air (10) à mettre en contact avec la partie arrière d'une personne, et dont la pression est agencée pour fluctuer avec la fluctuation dans l'aorte provoquée par un mouvement du coeur ; et a11) le moyen de calcul (61) est agencé pour utiliser la fluctuation de pression du dispositif à poche d'air (10) en tant que signal biologique à analyser.
- 30
- 35
8. Dispositif d'estimation d'état biologique corporel (60) selon la revendication 7, dans lequel le dispositif à poche d'air (10) est équipé sur une section de dossier de siège (510) sur un siège de véhicule (500).
- 40
9. Dispositif d'estimation d'état biologique corporel (60) selon l'une quelconque des revendications 1 à 8, dans lequel le moyen d'affichage (65) en un moniteur embarqué.
- 45
10. Programme informatique incorporé dans un dispositif d'estimation d'état biologique corporel (60) selon la revendication 1 qui estime un degré d'évolution de fatigue d'une personne lorsqu'elle conduit, en utilisant un signal biologique obtenu à partir du corps supérieur de la personne par un moyen de mesure de signal biologique (10, 11b), comprenant des instructions qui, lorsque le programme est exécuté par le dispositif d'estimation d'état biologique corporel, entraînent la réalisation par le dispositif des étapes suivantes :
- 50
- 55
- a) une étape de calcul (61) qui analyse le signal biologique, calcule, en utilisant le signal biologique, des valeurs d'une fonction qui est indicative d'un niveau de fatigue de la personne, et trie chacune des valeurs calculées à un moment prédéterminé respectif dans l'un d'une pluralité de stades de la fonction ; et
- b) une étape d'émission (62) qui trace les valeurs calculées en série temporelle avec chaque stade de la fonction sur l'axe vertical et le temps sur l'axe latéral et l'affiche par le moyen d'affichage (65) sous forme de graphique ;
- dans lequel l'étape de calcul (61) inclut :
- a1) une étape de calcul de fréquence (611) qui acquiert une fréquence d'un signal biologique obtenu par le moyen de mesure de signal biologique (10, 11b) ;
- caractérisé en ce que** l'étape de calcul inclut en outre :
- a2) une étape d'analyse et de calcul en série temporelle de pente de fréquence (612) qui effectue un calcul de mouvement pour acquérir une pente de la fréquence pour chaque fenêtre temporelle prédéterminée fixée avec un temps de recoupement prédéterminé à partir de la fréquence du signal biologique obtenue par l'étape de calcul de fréquence (611) et acquiert une forme d'onde en série temporelle de la pente de la fréquence obtenue pour chaque fenêtre temporelle ;
- a3) une étape de différenciation (614) qui différencie la forme d'onde en série temporelle de la pente de fréquence acquise par l'étape d'analyse et de calcul en série temporelle de pente de fréquence (612) ;
- a4) une étape d'intégration (615) qui intègre la forme d'onde en série temporelle de la pente de fréquence acquise par l'étape d'analyse et de calcul en série temporelle de pente de fréquence (612) ;
- a5) une étape de calcul d'onde rectangulaire (616) qui acquiert une onde rectangulaire à partir d'une augmentation/diminution de la forme d'onde en série temporelle de la pente de fréquence acquise par l'étape d'analyse et de calcul en série temporelle de pente de fréquence (612) ;
- a6) une étape de calcul de fonction descriptive (617) qui acquiert une fonction descriptive et une valeur d'amplitude de fonction descriptive entre la forme d'onde en série temporelle de pente de fréquence dans une première zone temporelle fixée arbitrairement et la forme d'onde en série temporelle de pente de fréquence dans une seconde zone temporelle après la première zone temporelle ;

- a7) une étape de traitement de valeur absolue (618) qui applique un traitement de valeur absolue à la forme d'onde en série temporelle des pentes de fréquence respectives acquises par l'étape d'analyse et de calcul en série temporelle de pente de fréquence (612) en utilisant une forme d'onde en série temporelle d'une fréquence d'un signal biologique en utilisant une valeur maximale de la forme d'onde en série temporelle du signal biologique obtenue par l'étape de calcul de fréquence (611) et une forme d'onde en série temporelle d'une fréquence d'un signal biologique en utilisant un point de passage par zéro où le signe de la forme d'onde en série temporelle du signal biologique est inversé ; et a8) une étape de calcul (619) qui acquiert le stade de la fonction en utilisant au moins un ou plusieurs parmi la pente de fréquence acquise par l'étape d'analyse et de calcul en série temporelle de pente de fréquence (611), la valeur différentielle acquise par le moyen de différenciation (614), la valeur intégrale acquise par le moyen d'intégration (615), le signe de l'onde rectangulaire acquise par le moyen de calcul d'onde rectangulaire (616), la valeur d'amplitude de fonction descriptive acquise par l'étape de calcul de fonction descriptive (617), et deux valeurs absolues de la forme d'onde en série temporelle de pente de fréquence acquises par l'étape de traitement de valeur absolue (618).
11. Programme informatique selon la revendication 10, dans lequel le graphique affiché par le moyen d'affichage (65) par l'étape d'émission (62) est un graphique linéaire.
12. Programme informatique selon la revendication 10 ou 11, dans lequel
- a9) l'étape de calcul (61) acquiert et trie les valeurs de la fonction en cinq stades depuis le stade hautement actif jusqu'au stade de déclin fonctionnel ; et
- b9) l'étape d'émission (62) tri et affiche les valeurs de fonction en cinq stades avec l'état hautement actif en tant que partie la plus élevée et l'état de déclin fonctionnel en tant que partie la plus basse sur l'axe vertical.
13. Programme informatique selon l'une quelconque des revendications 10 à 12, comprenant en outre des instructions qui, lorsque le programme est exécuté par le dispositif d'estimation d'état biologique corporel, entraînent la réalisation par le dispositif de l'étape suivante :
- c) une étape de détermination (63) qui détermine un changement de l'état d'une personne à partir d'un graphique affiché sur le moyen d'affichage (65) par
- l'étape d'émission (62).
14. Programme informatique selon la revendication 13, dans lequel
- c1) l'étape de détermination (63) a une étape de détermination d'état anormal (63) qui détermine un état anormal si un déclin sur deux stades ou plus de la fonction se produit un nombre de fois prédéterminé ou plus sur le graphique affiché sur le moyen d'affichage (65) par l'étape d'émission (62).

FIG. 1

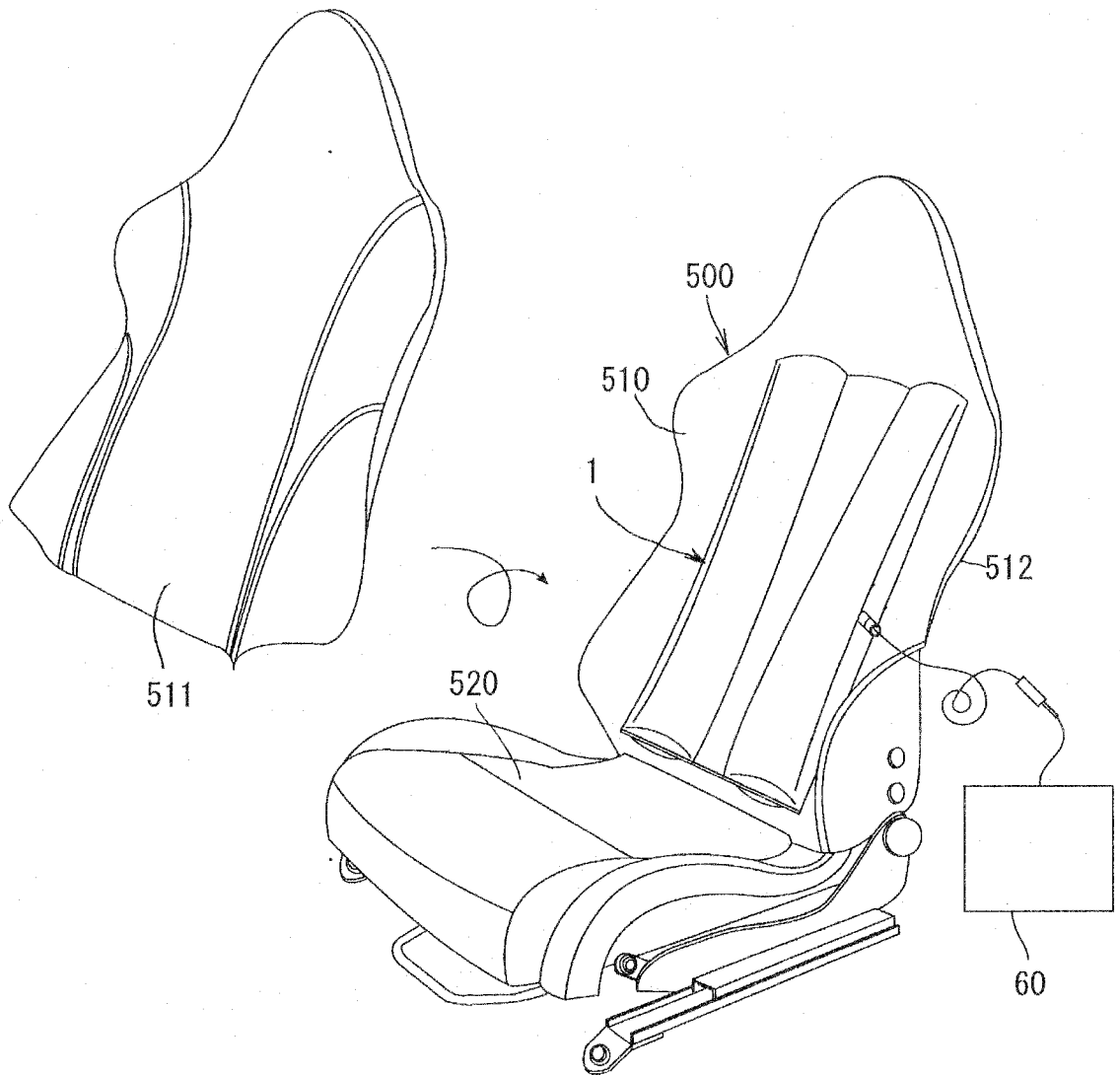

FIG. 2

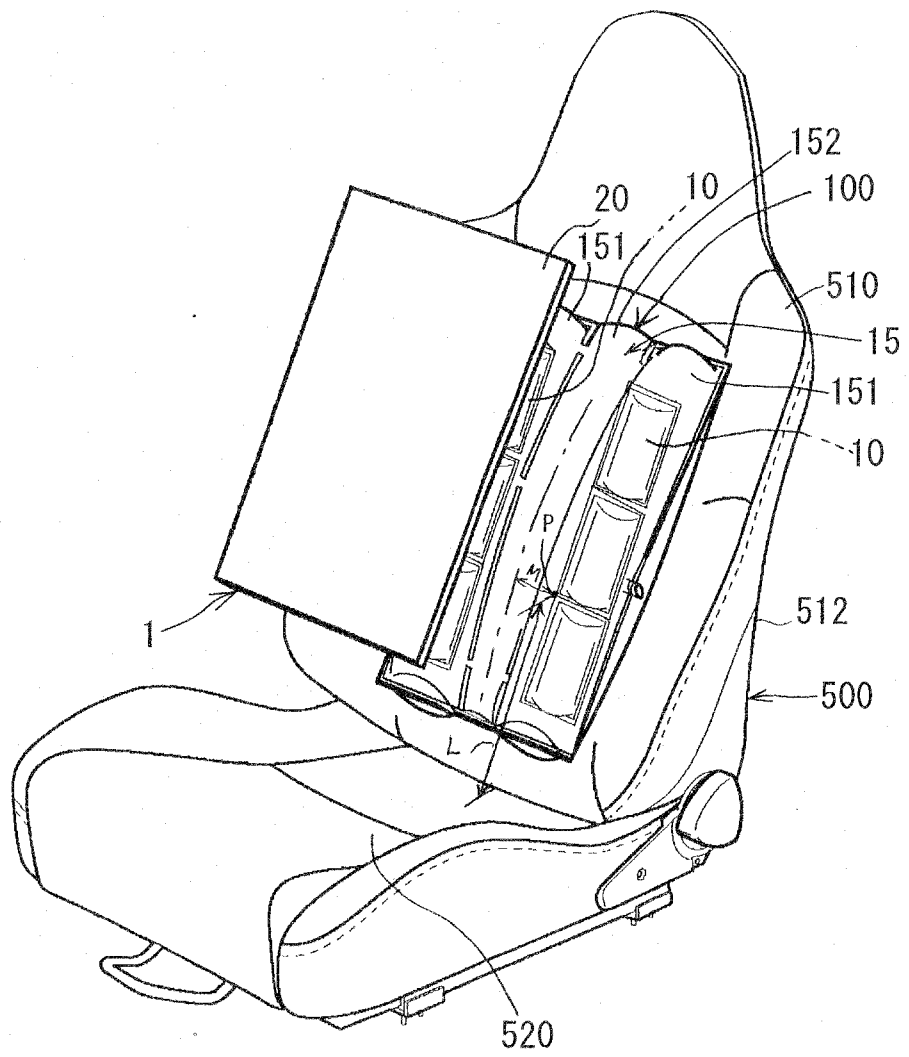

FIG. 3A

FIG. 3B

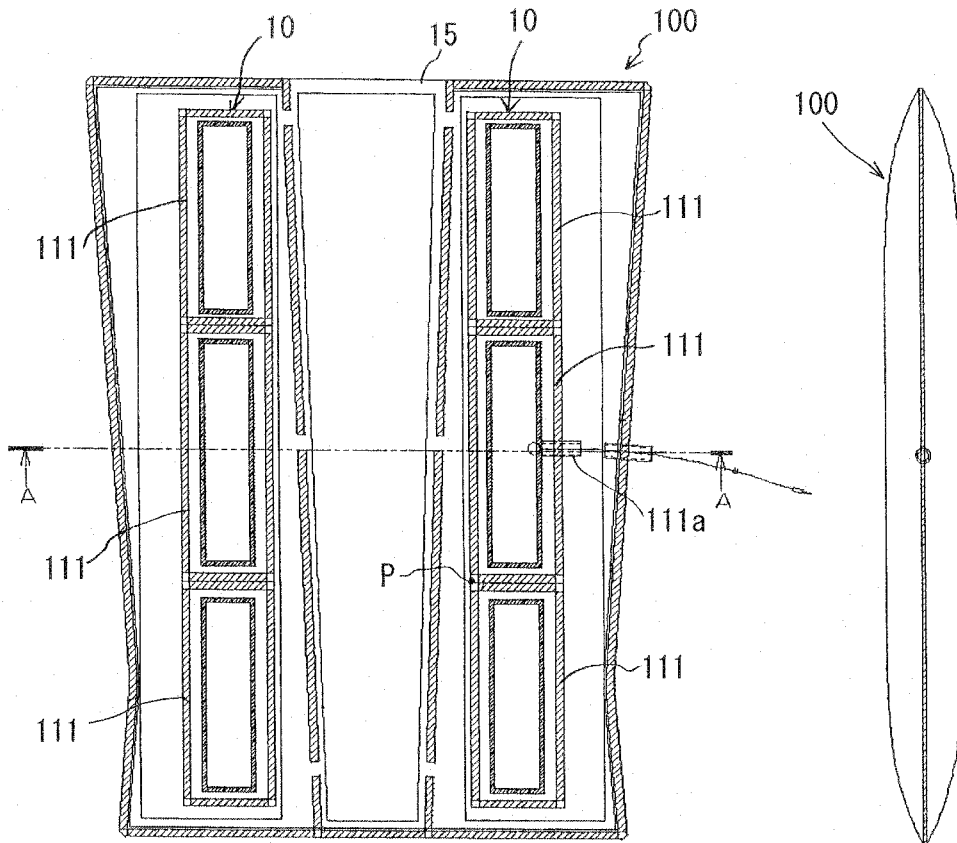

FIG. 3C

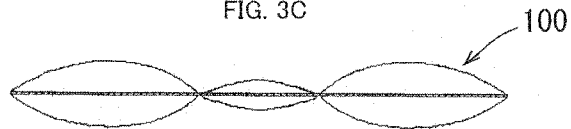

FIG. 3D

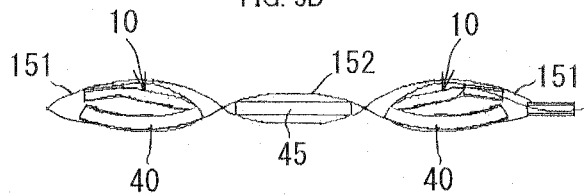

FIG. 4

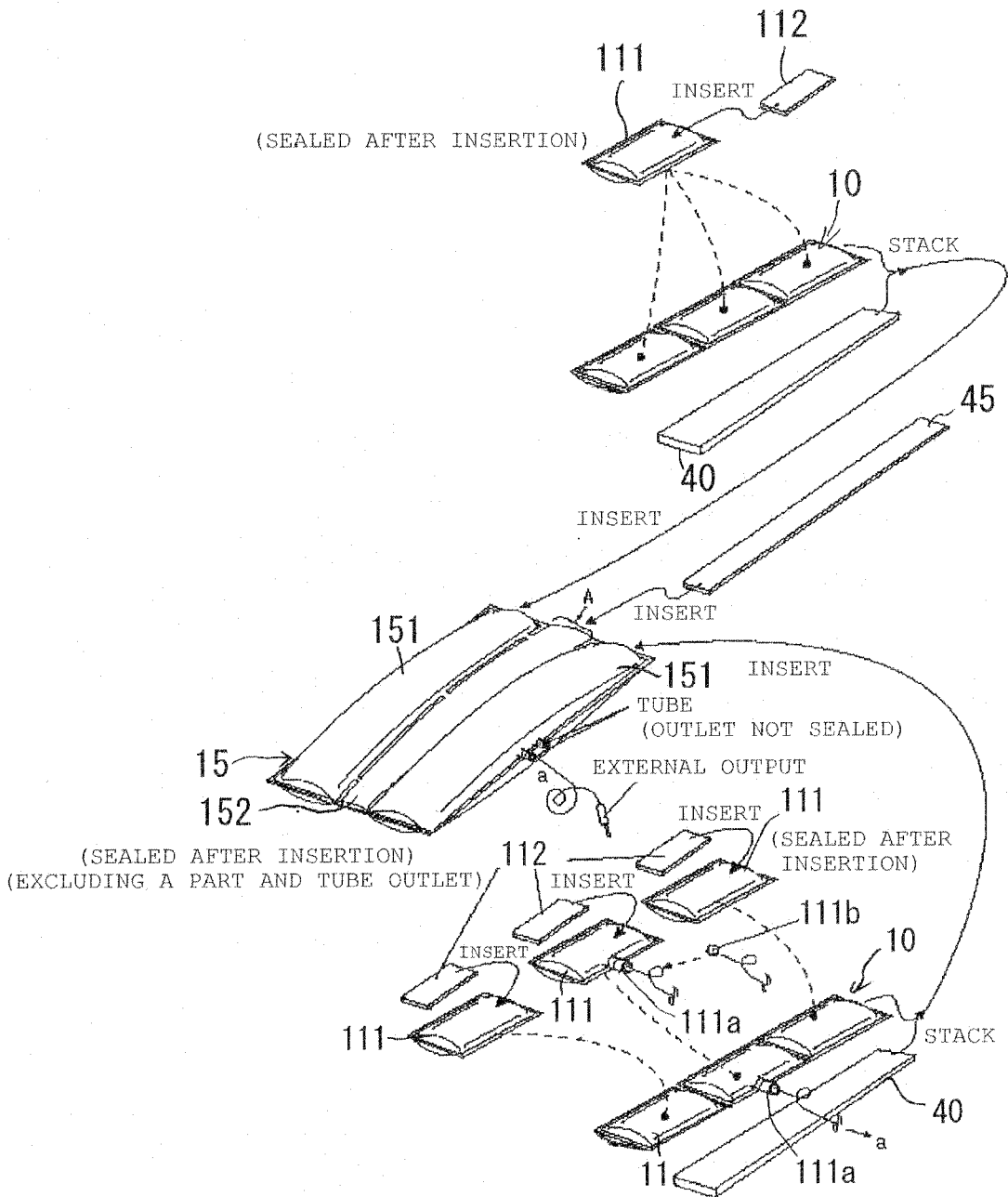

FIG. 5A

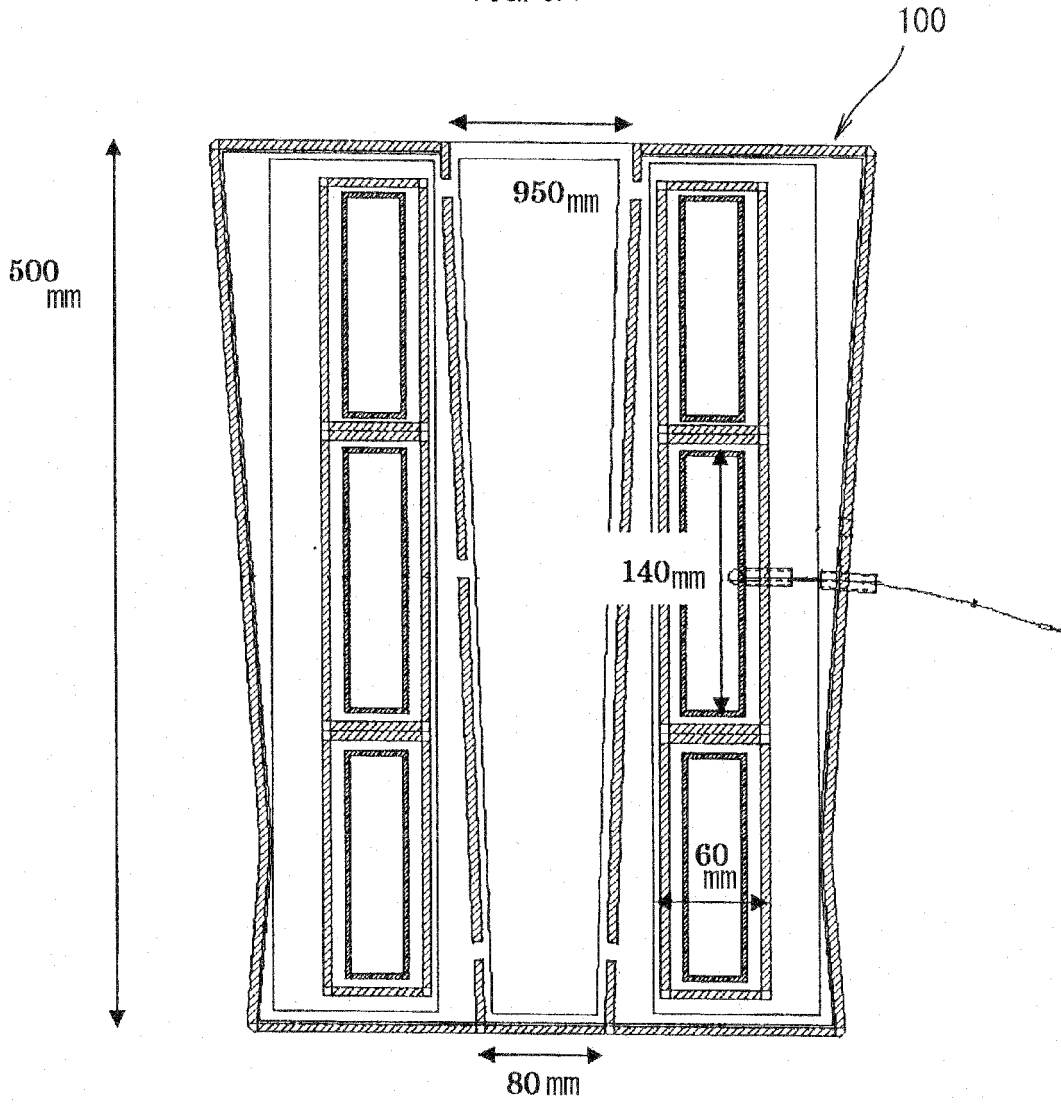

FIG. 5B

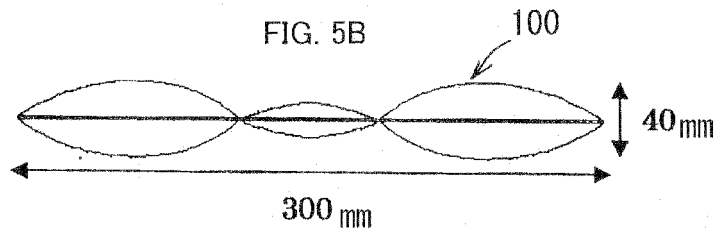

FIG. 6

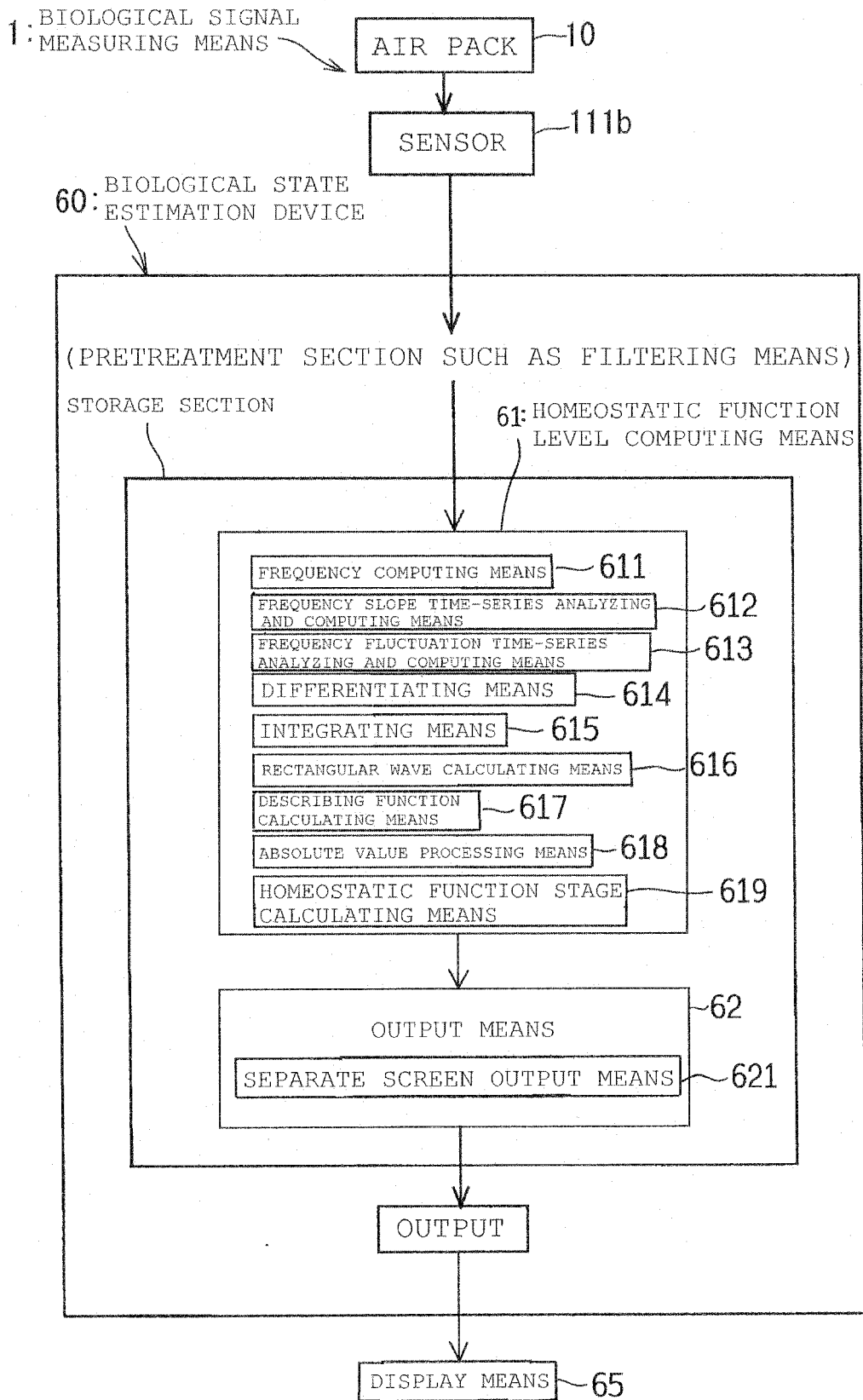
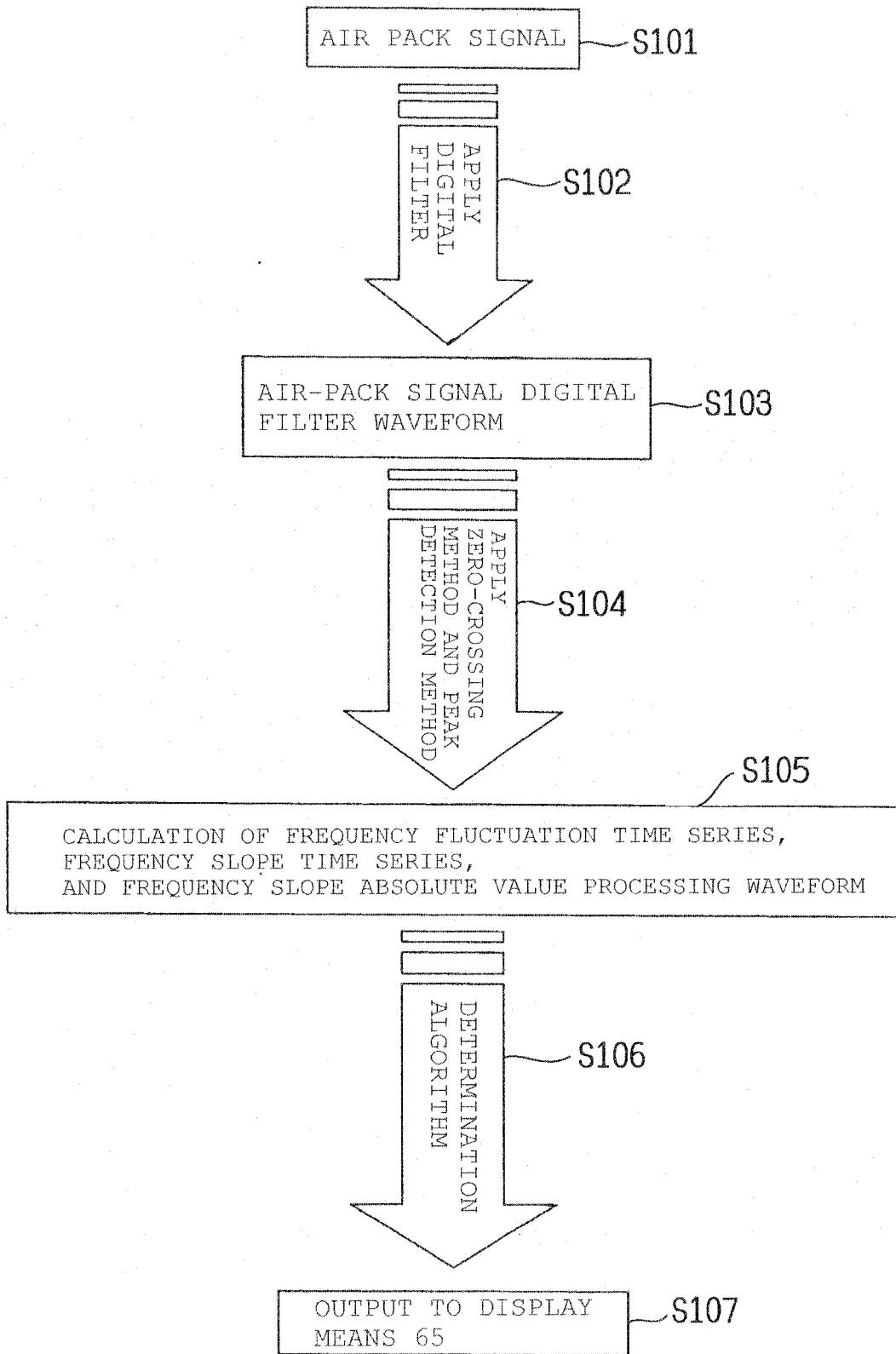

FIG. 7



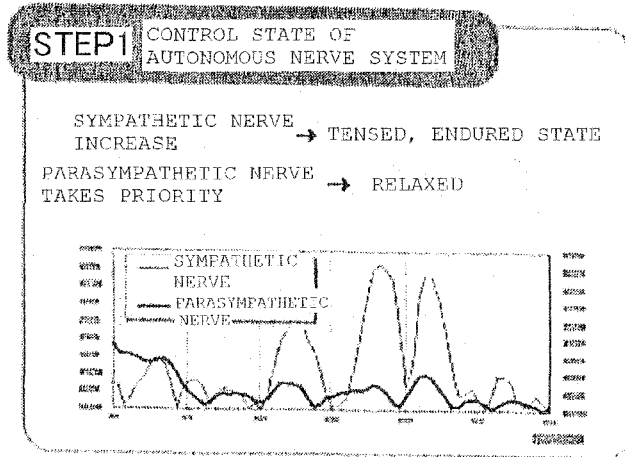

FIG. 8A

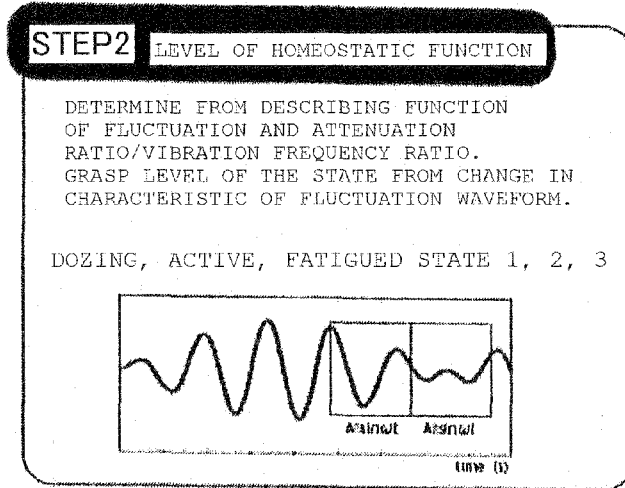

FIG. 8B

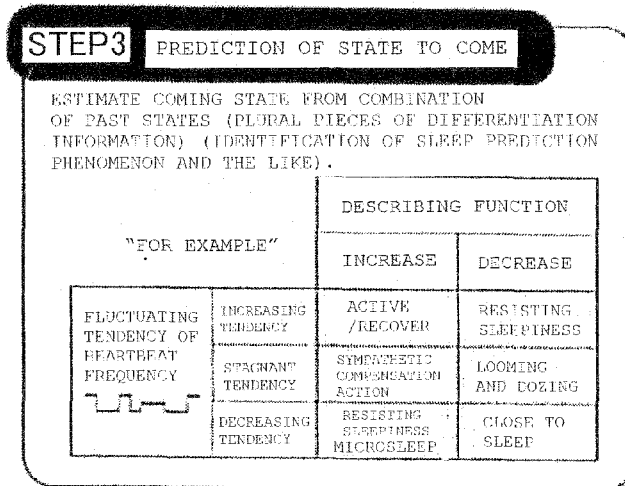

FIG. 8C

LEVEL HOMEOSTATIC OF FUNCTION

FIG. 9

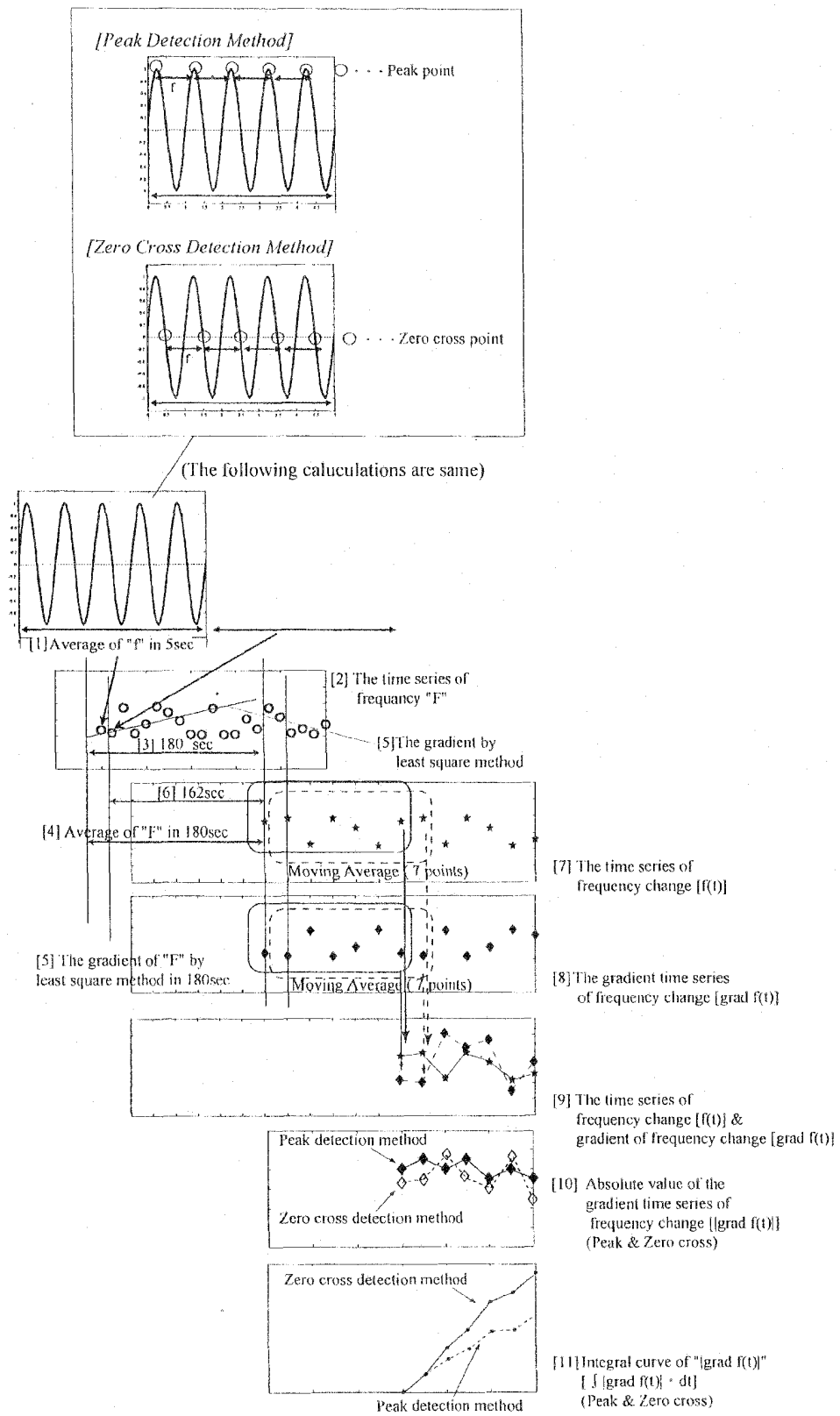
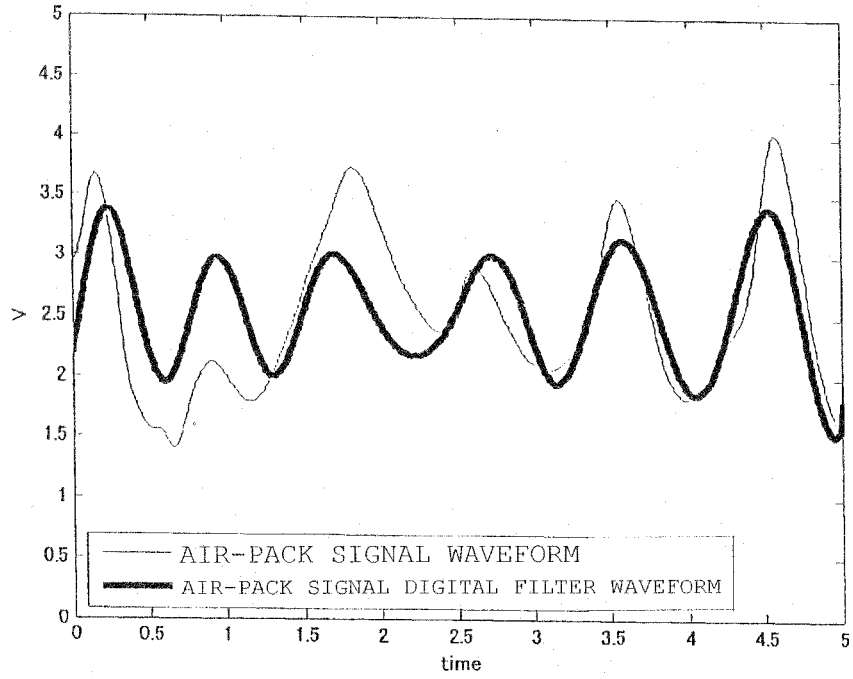
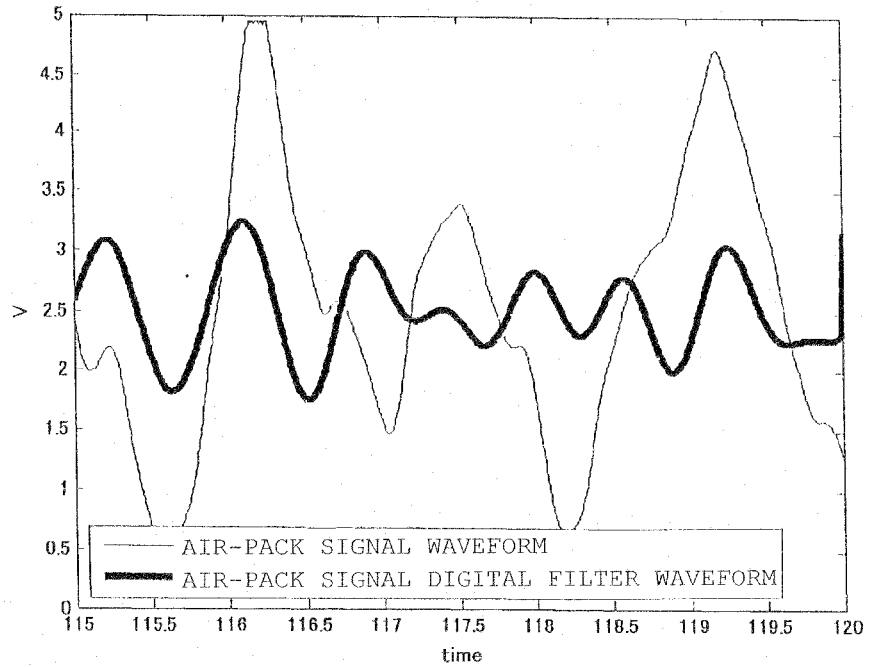

FIG. 10A



COMPARISON UNDER STATIC EQUIVALENT ENVIRONMENT (IDLING STATE)

FIG. 10B



COMPARISON DURING DRIVING

FIG. 11A

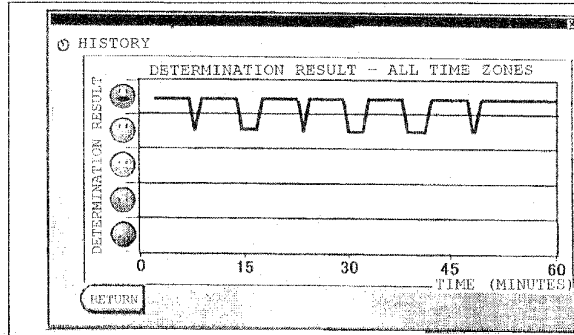

CASE 1  
ACTIVE STATE

FIG. 11B

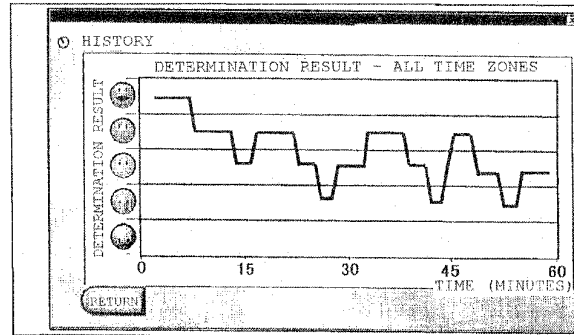

CASE 2  
STATE  
IN WHICH  
PROGRESS  
OF FATIGUE  
IS FOUND

FIG. 11C

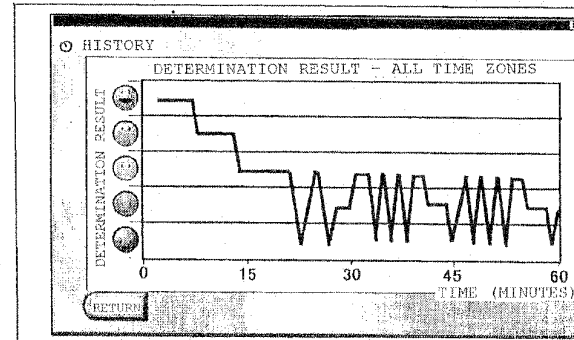

CASE 3  
LOOMING  
STATE  
FREQUENT  
AND HUMAN  
ERRORS CAN  
EASILY  
OCCUR, CARE  
SHOULD BE  
TAKEN IN  
DRIVING

FIG. 11D

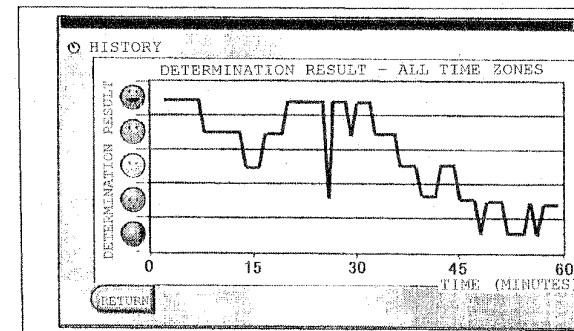

CASE 4  
LESS  
FLUCTUATION,  
HOMEOSTASIS  
CANNOT BE  
MAINTAINED  
EASILY,  
AND REST IS  
REQUIRED

FIG. 11E

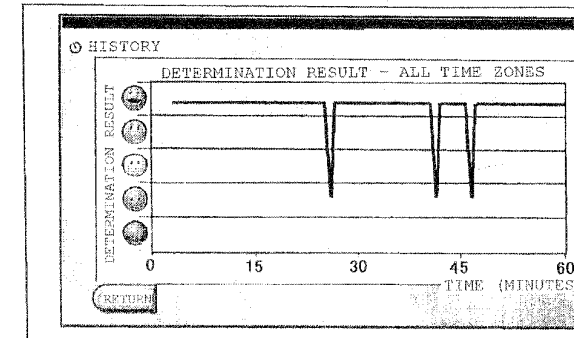

CASE 5  
OCCURRENCE OF  
MICROSLEEP IS  
PREDICTED

FIG. 12A

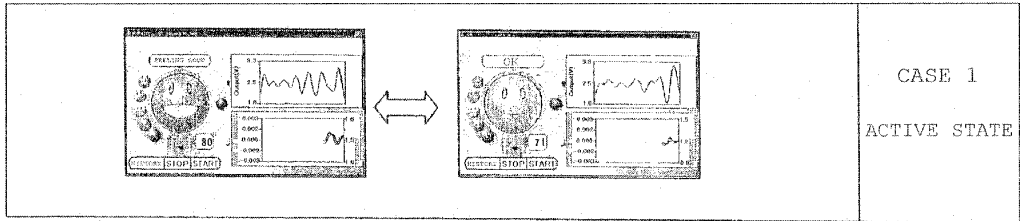

CASE 1  
ACTIVE STATE

FIG. 12B

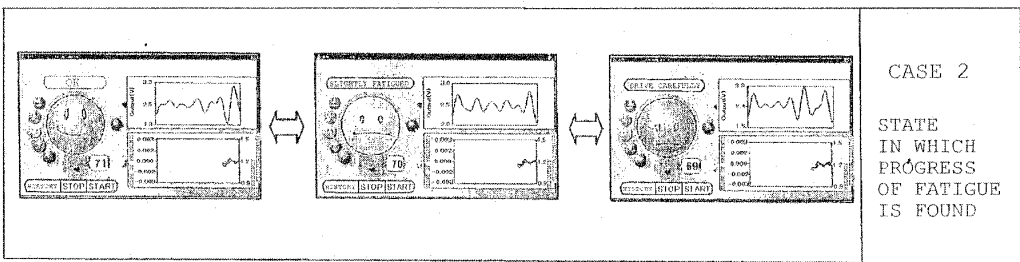

CASE 2  
STATE  
IN WHICH  
PROGRESS  
OF FATIGUE  
IS FOUND

FIG. 12C

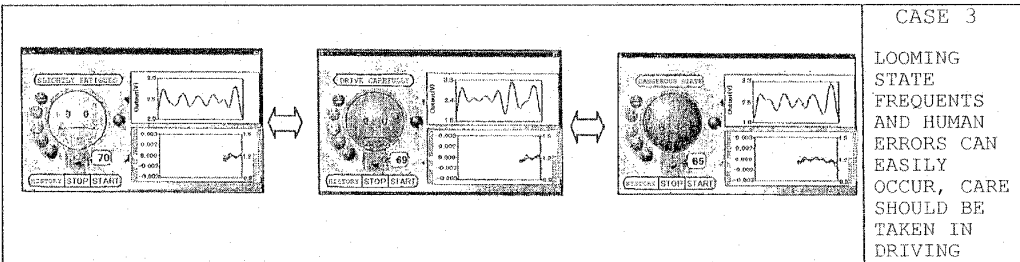

CASE 3  
LOOMING  
STATE  
FREQUENTS  
AND HUMAN  
ERRORS CAN  
EASILY  
OCCUR, CARE  
SHOULD BE  
TAKEN IN  
DRIVING

FIG. 12D

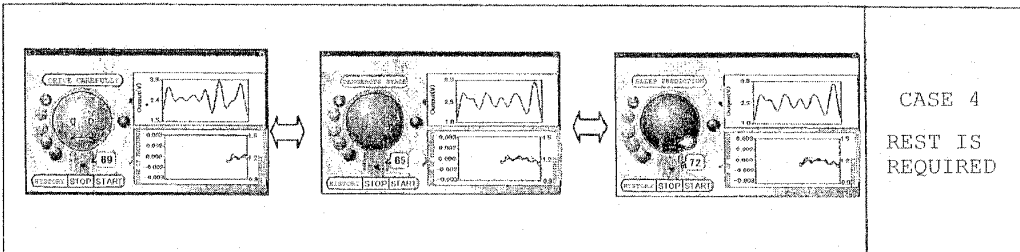

CASE 4  
REST IS  
REQUIRED

FIG. 12E

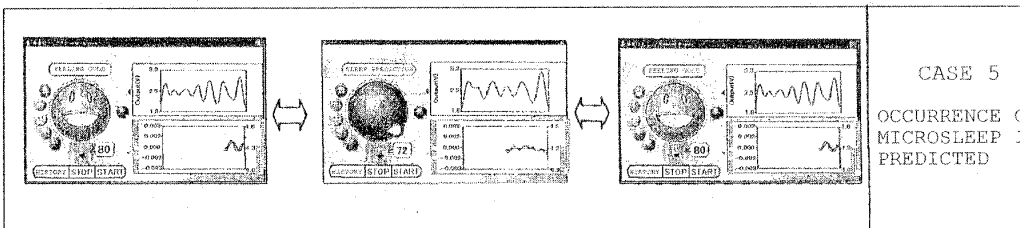

CASE 5  
OCCURRENCE OF  
MICROSLEEP IS  
PREDICTED

FIG. 13

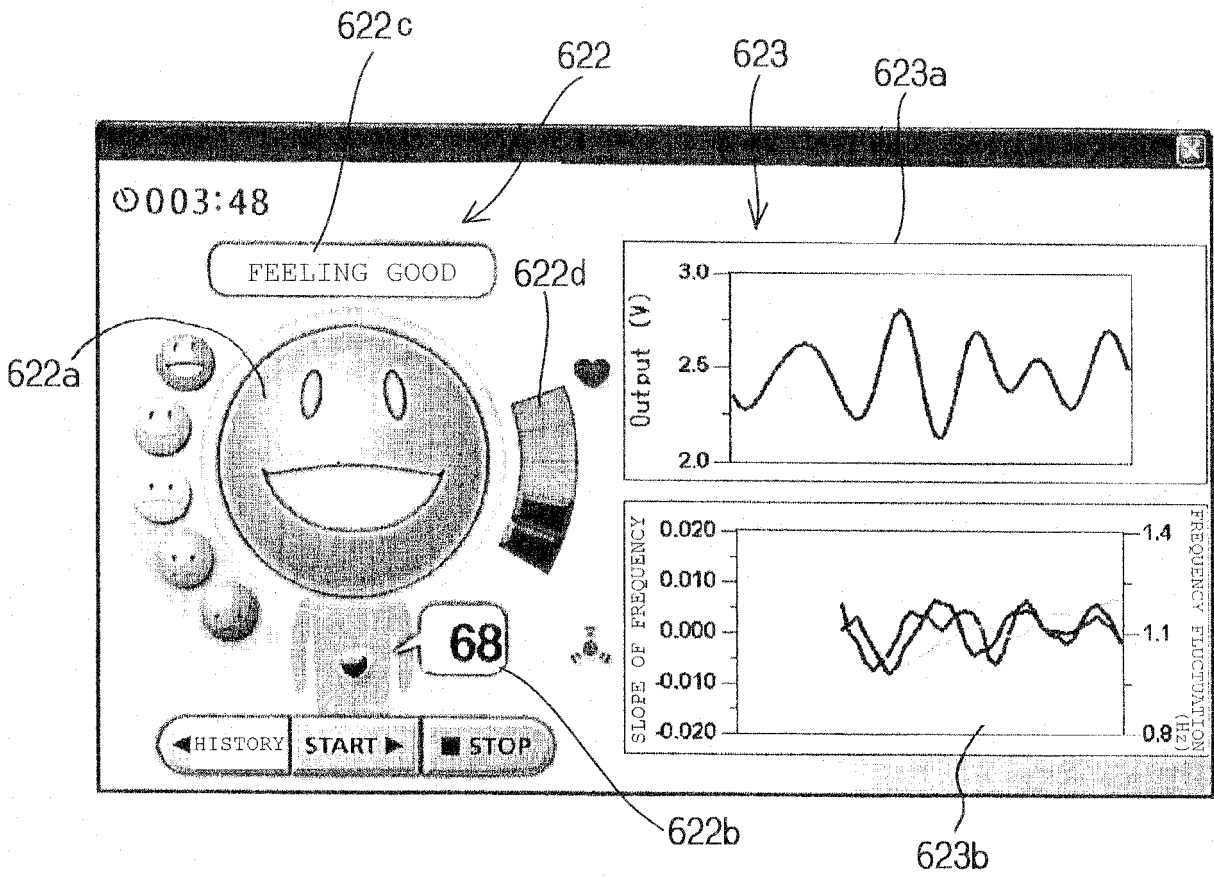

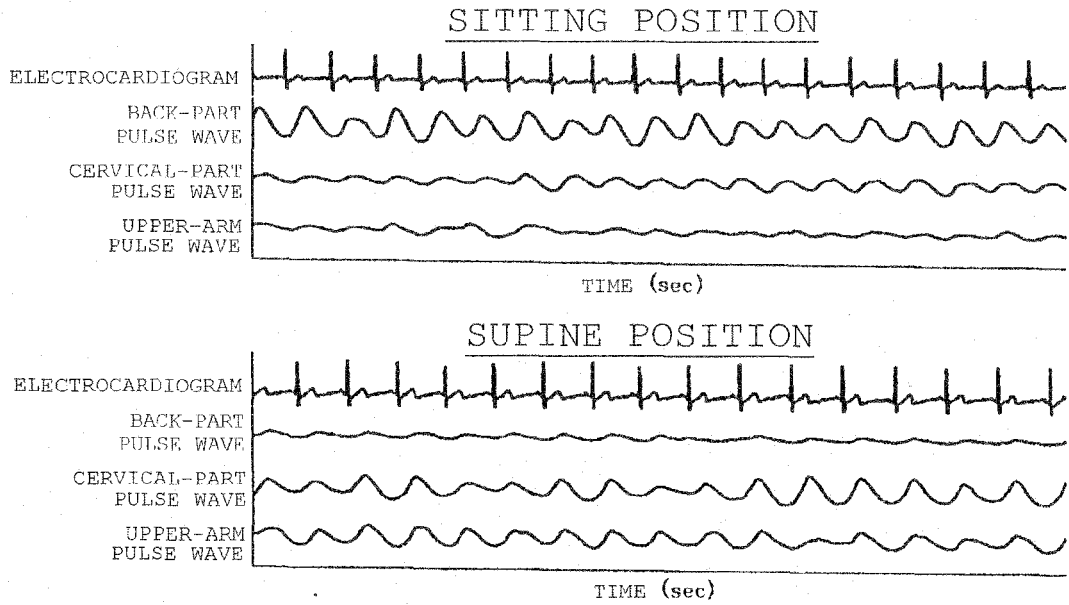

FIG. 14A ORIGINAL WAVEFORMS OF ELECTROCARDIOGRAM AND PULSE WAVE

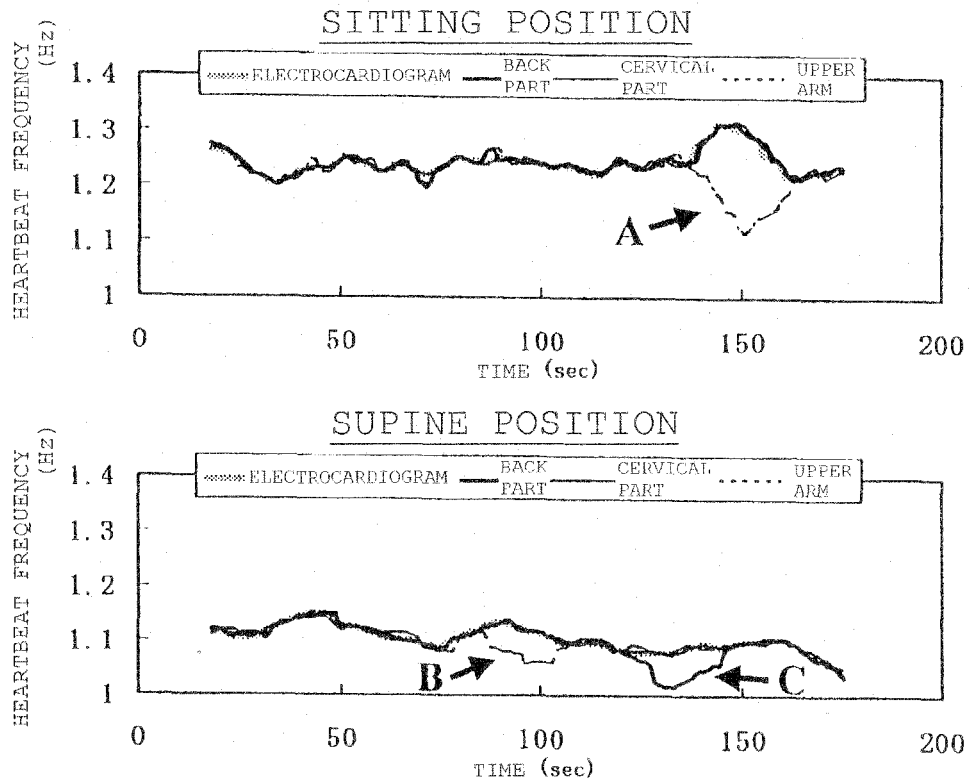

FIG. 14B COMPARISON OF HEARTBEAT FREQUENCY TIME-SERIES WAVEFORM

FIG. 15A

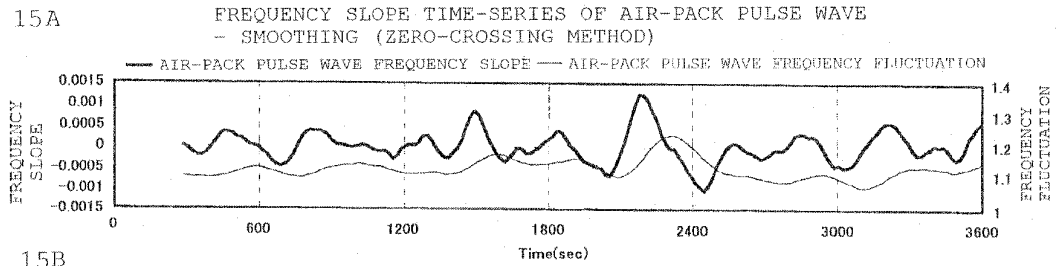

FIG. 15B

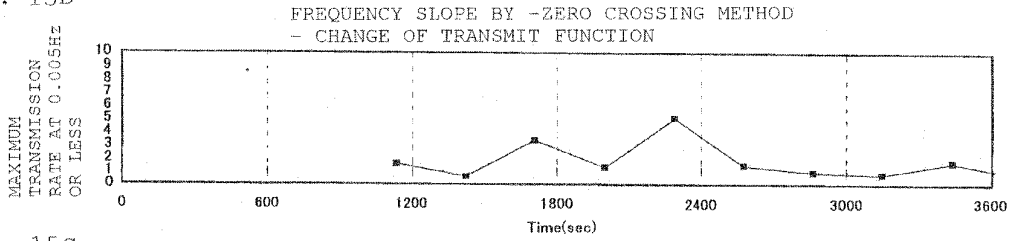

FIG. 15C

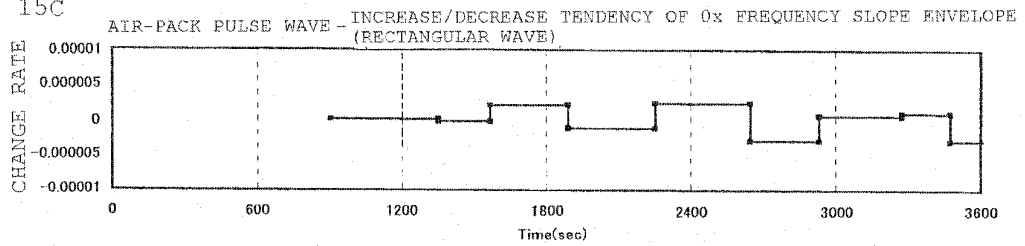

FIG. 15D

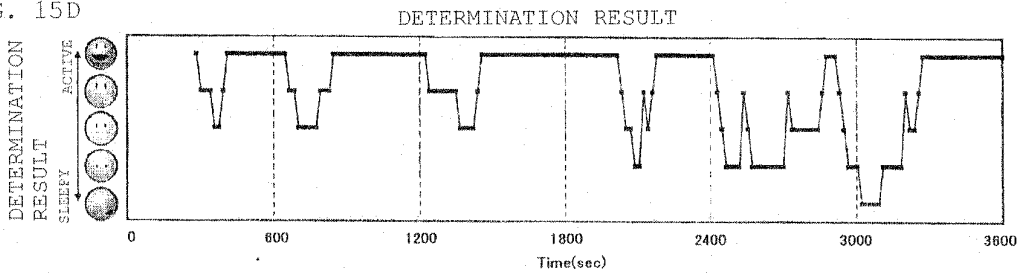

FIG. 15E

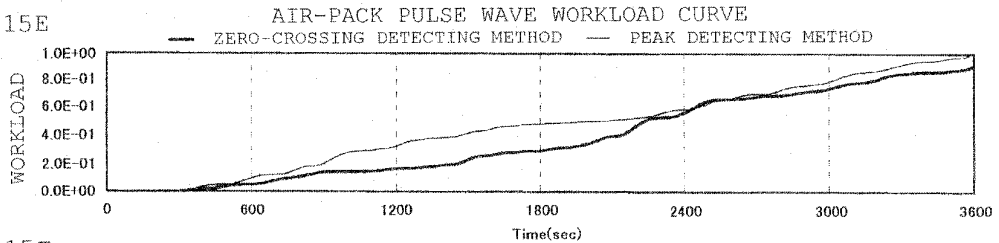

FIG. 15F

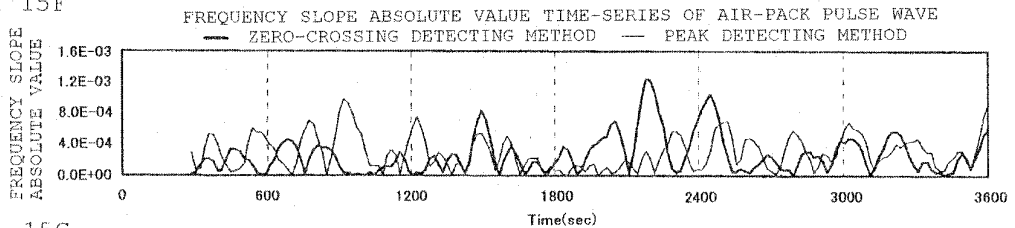

FIG. 15G

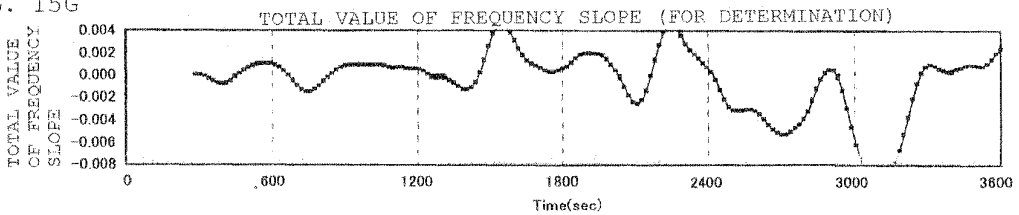

FIG. 16A

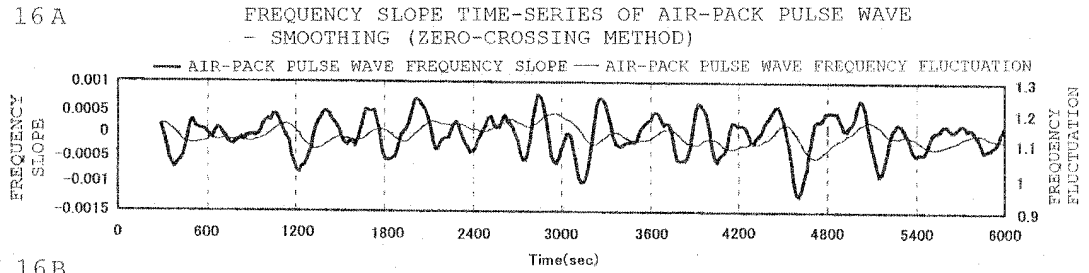

FIG. 16B

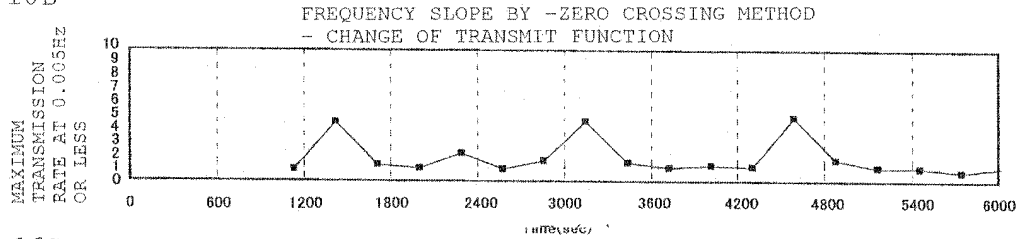

FIG. 16C

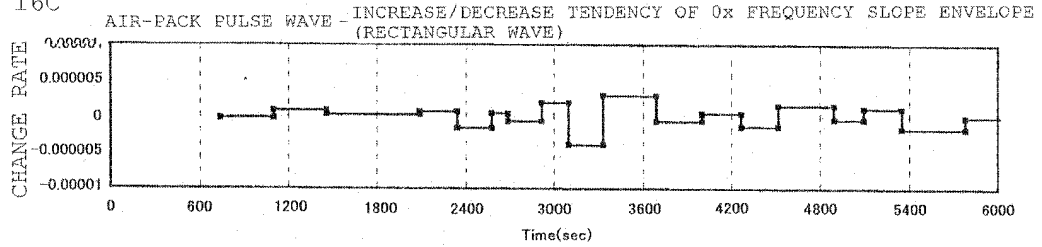

FIG. 16D

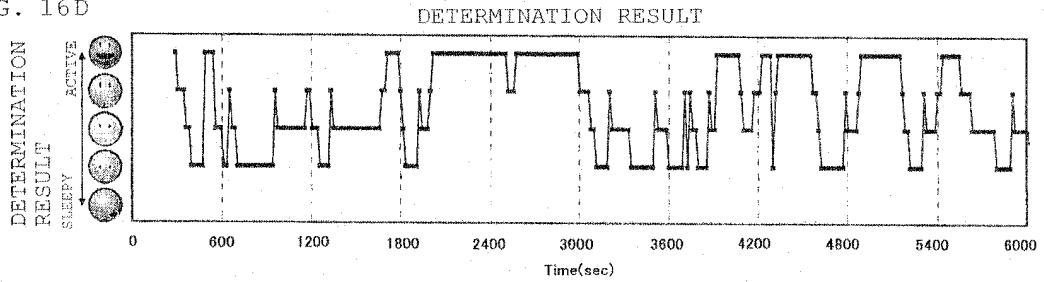

FIG. 16E

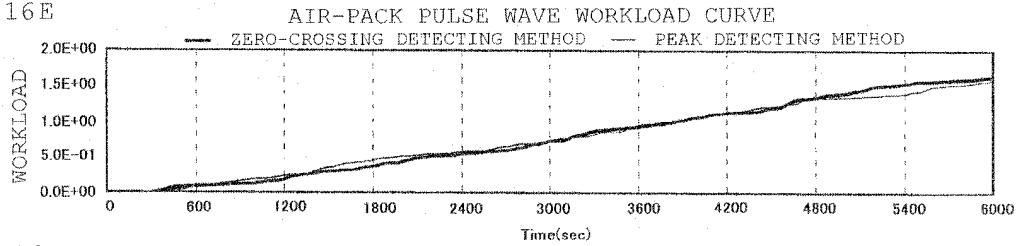

FIG. 16F

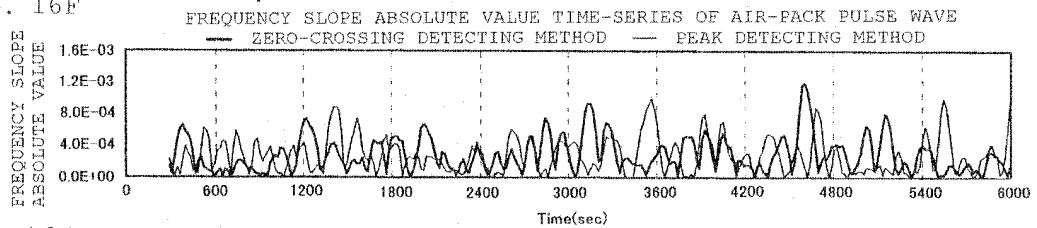

FIG. 16G

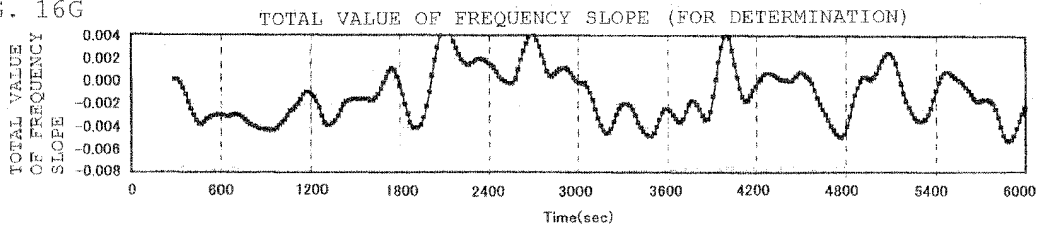

FIG. 17A

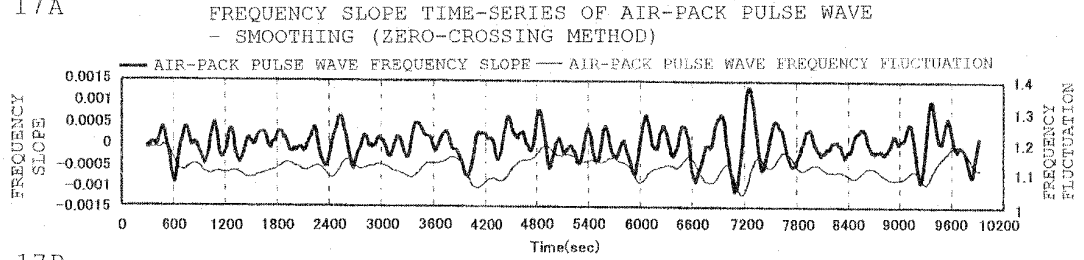

FIG. 17B

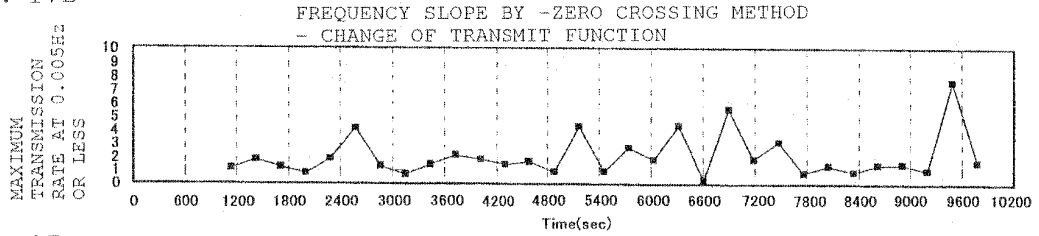

FIG. 17C

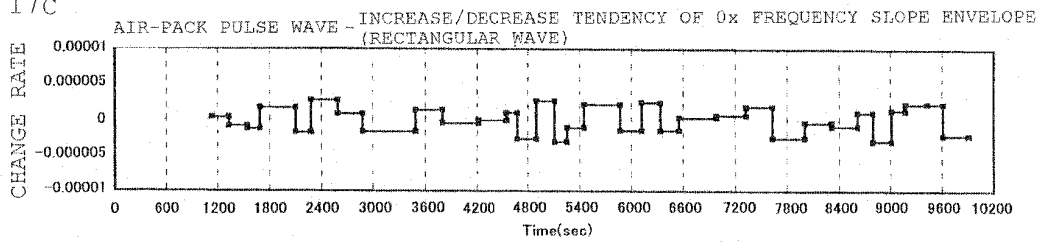

FIG. 17D

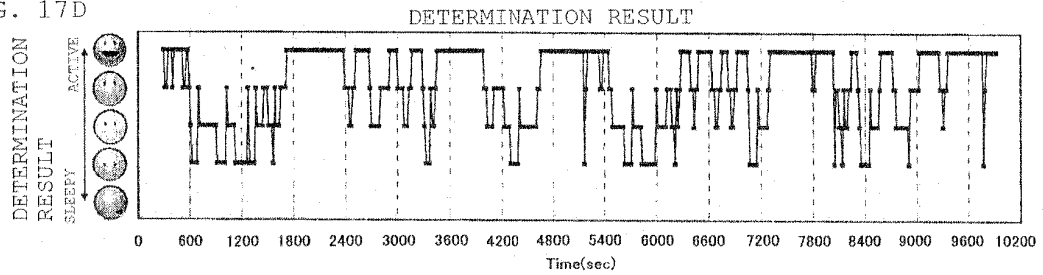

FIG. 17E

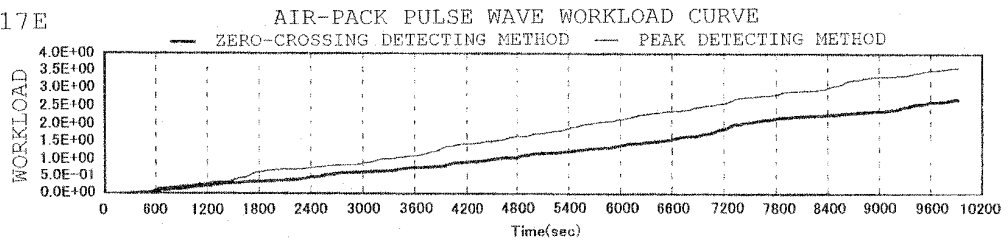

FIG. 17F

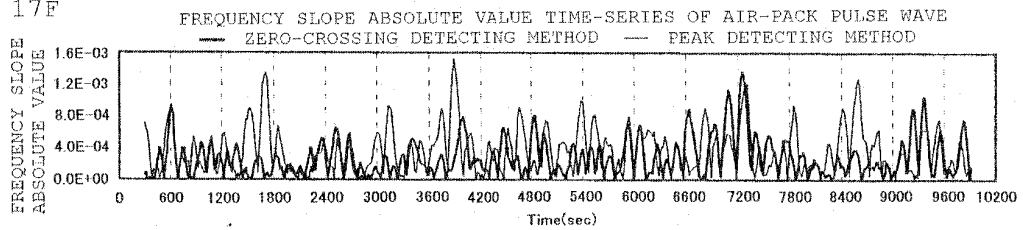

FIG. 17G

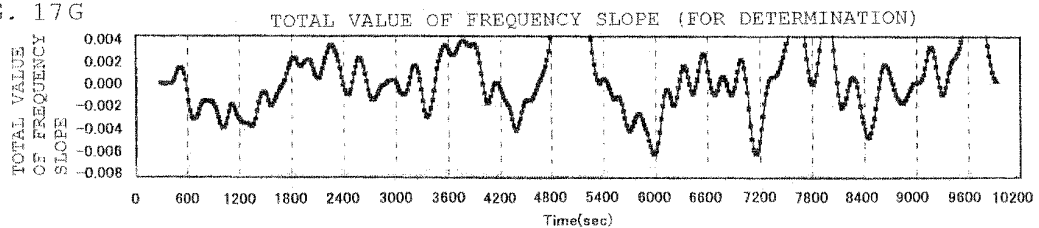

FIG. 18A

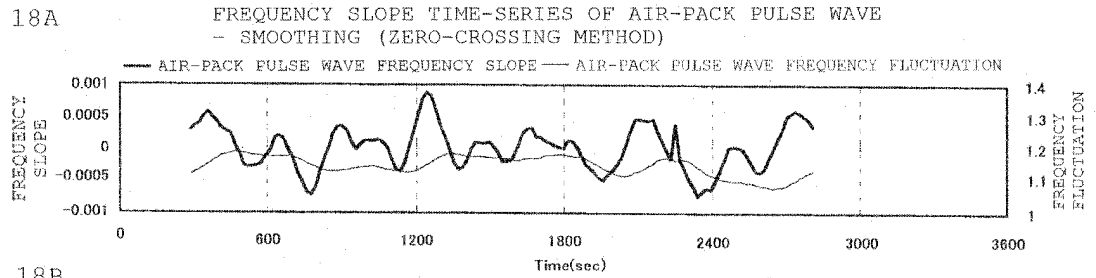

FIG. 18B

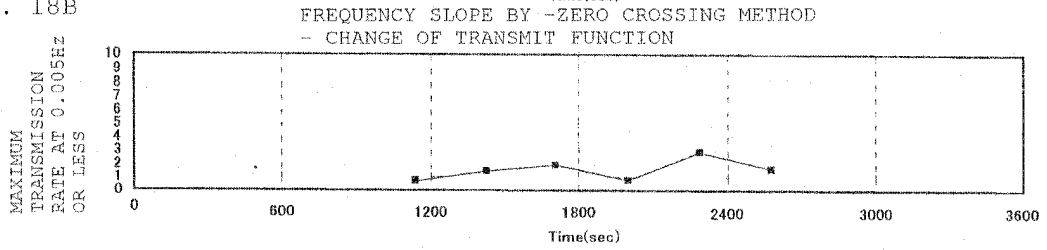

FIG. 18C

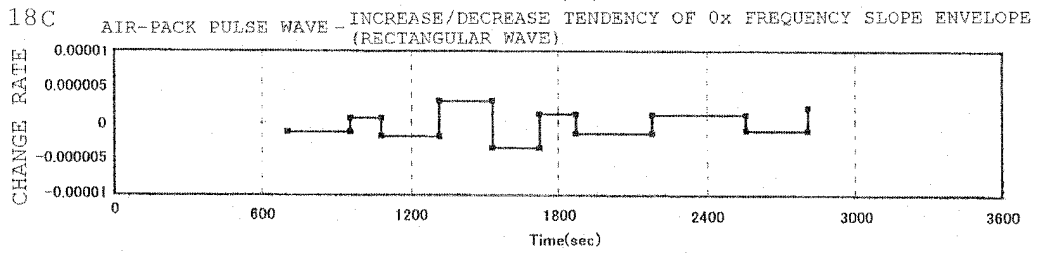

FIG. 18D

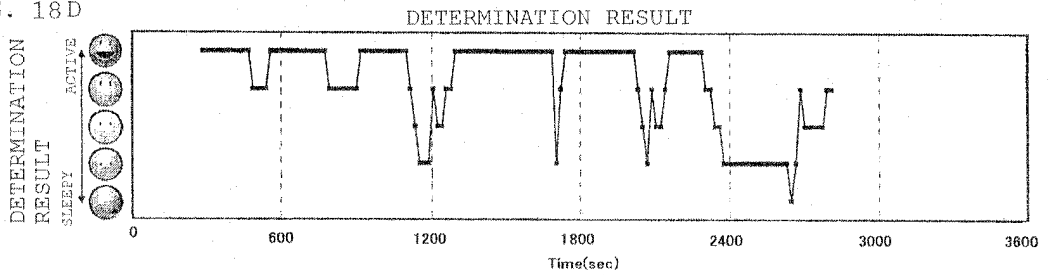

FIG. 18E

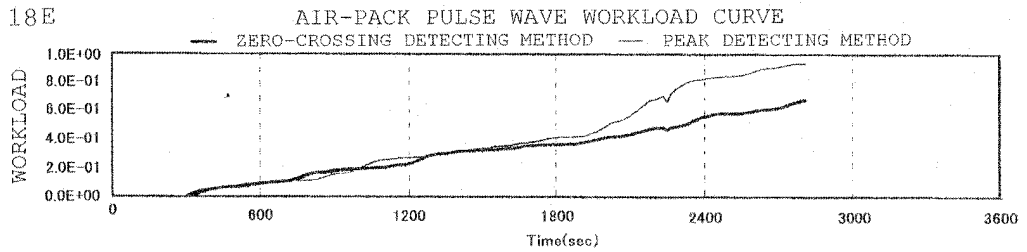

FIG. 18F

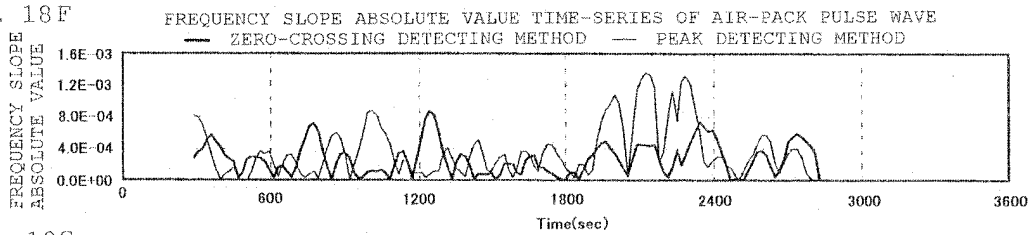

FIG. 18G

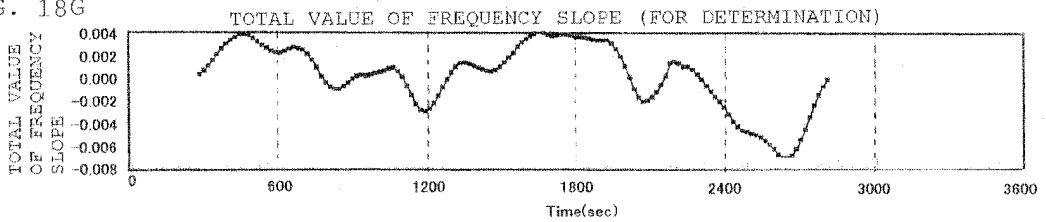

FIG. 19A

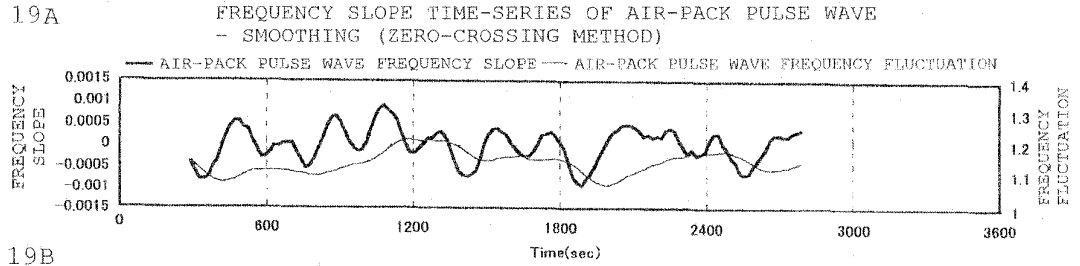

FIG. 19B

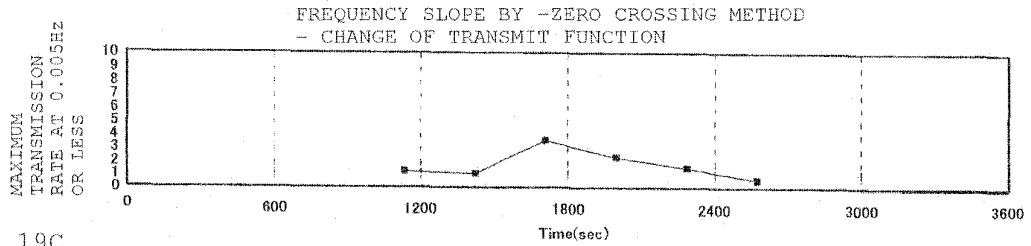

FIG. 19C

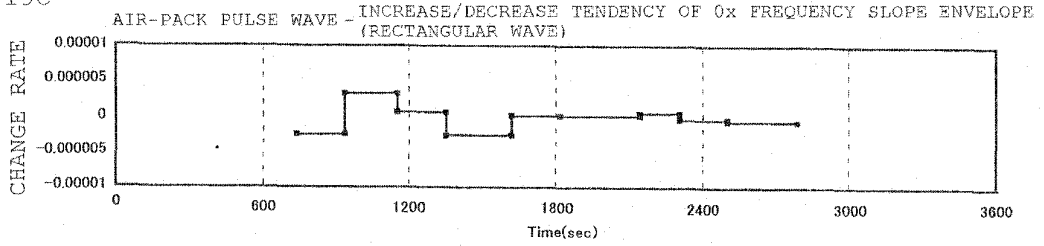

FIG. 19D

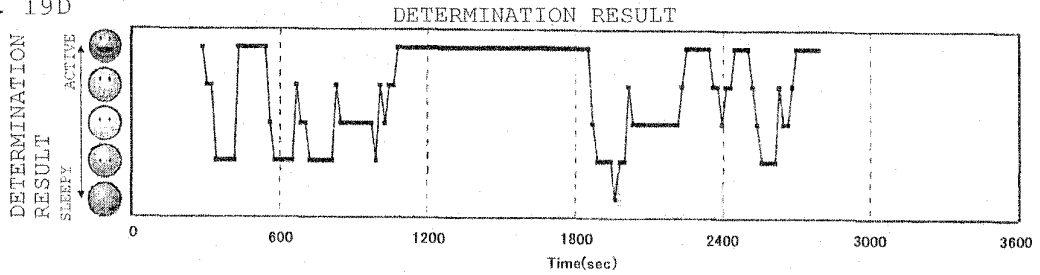

FIG. 19E

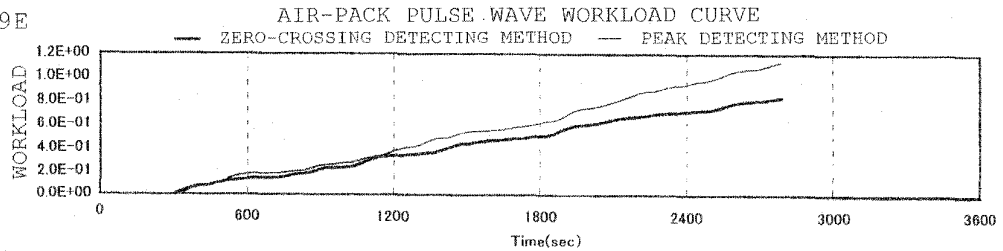

FIG. 19F

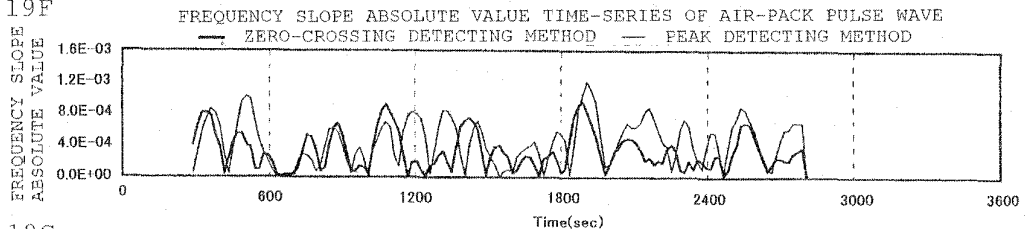

FIG. 19G

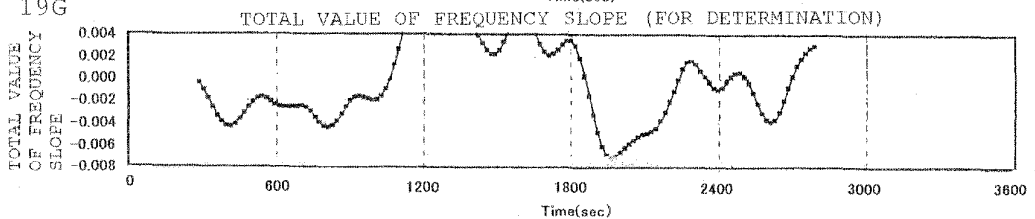

FIG. 20A

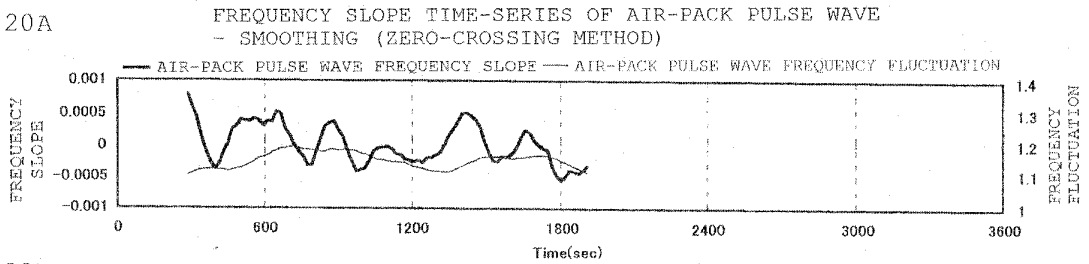

FIG. 20B

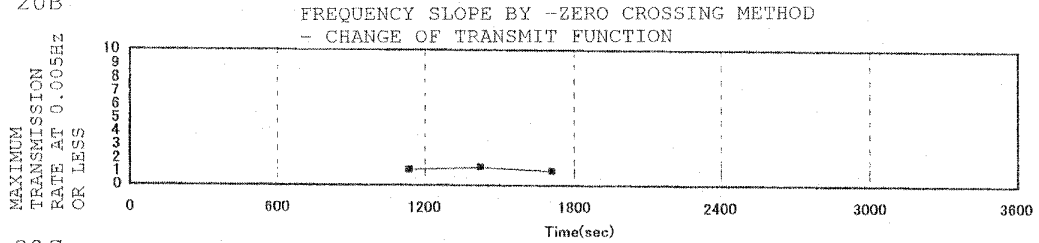

FIG. 20C

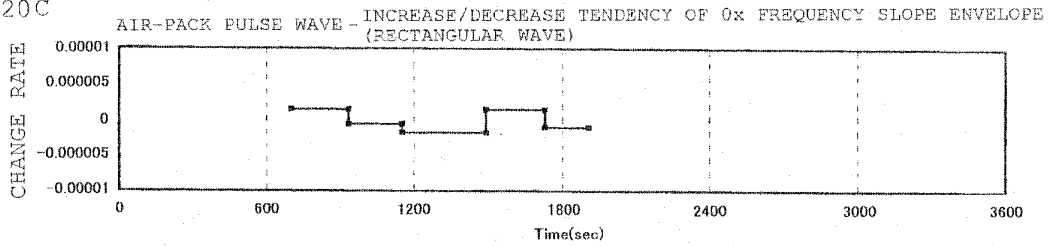

FIG. 20D

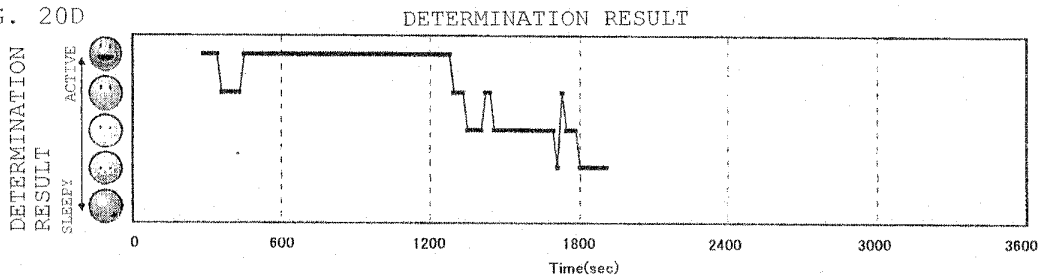

FIG. 20E

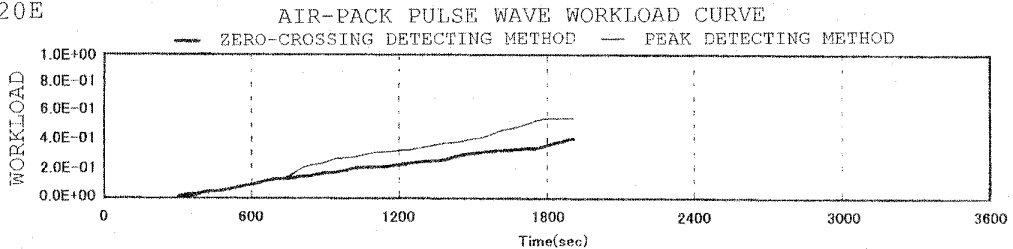

FIG. 20F

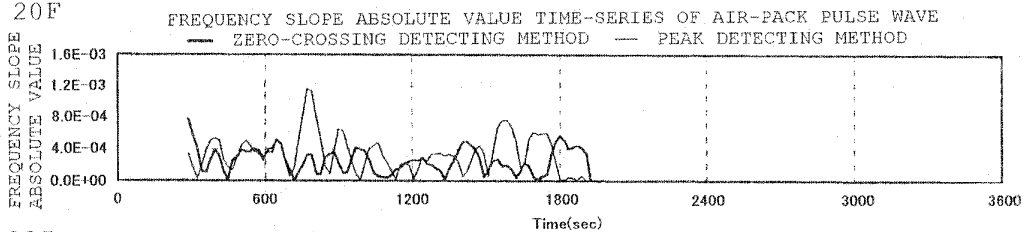

FIG. 20G

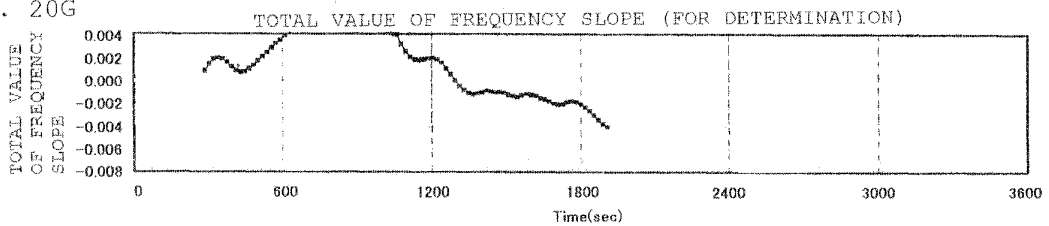

FIG. 21A

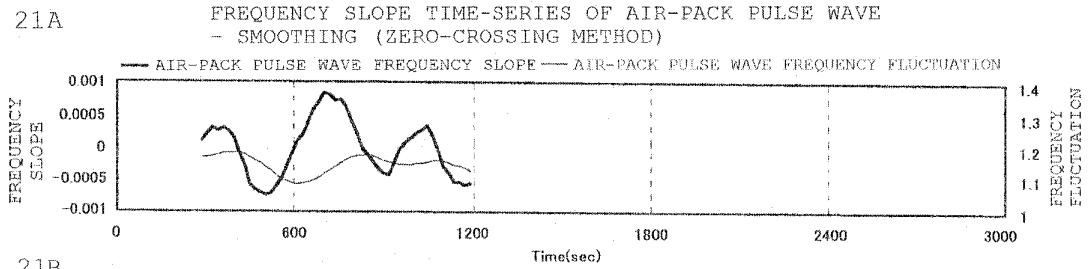

FIG. 21B

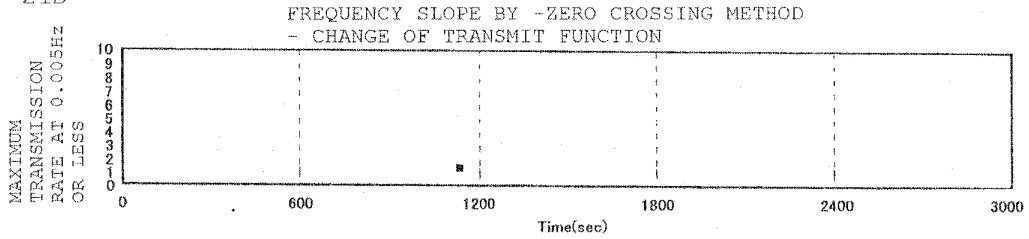

FIG. 21C

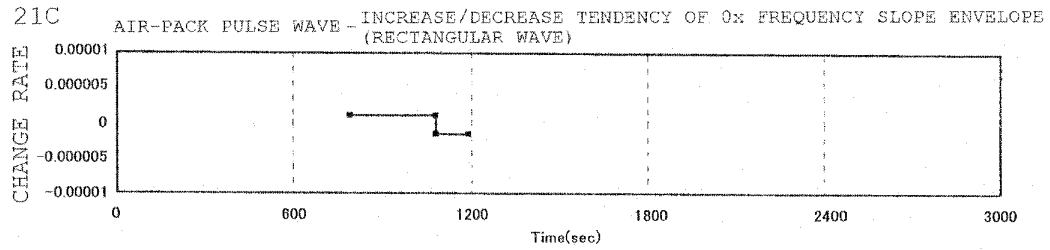

FIG. 21D

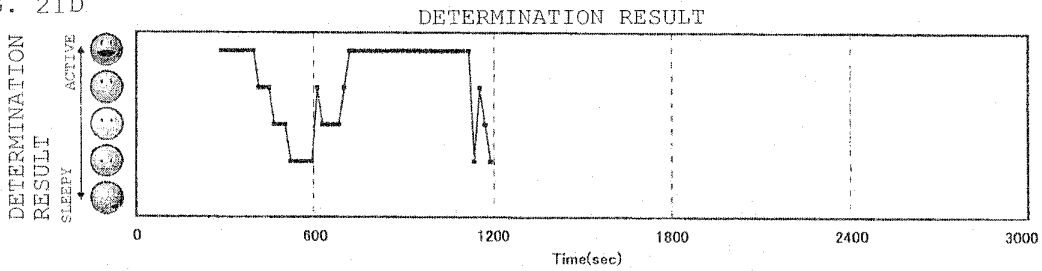

FIG. 21E

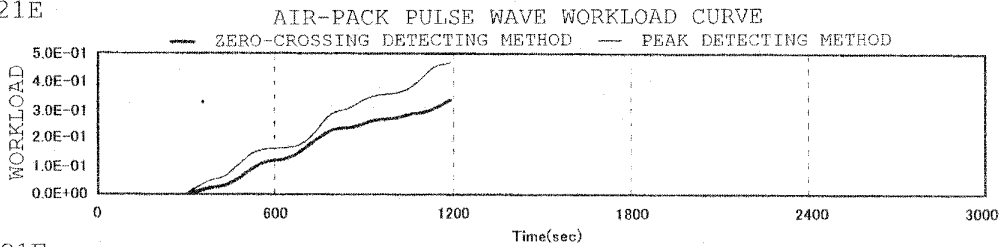

FIG. 21F

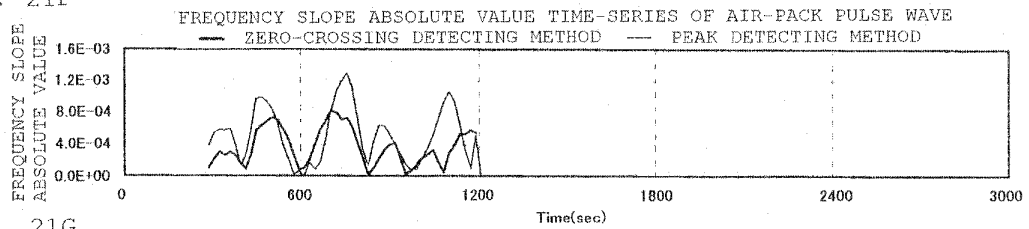

FIG. 21G

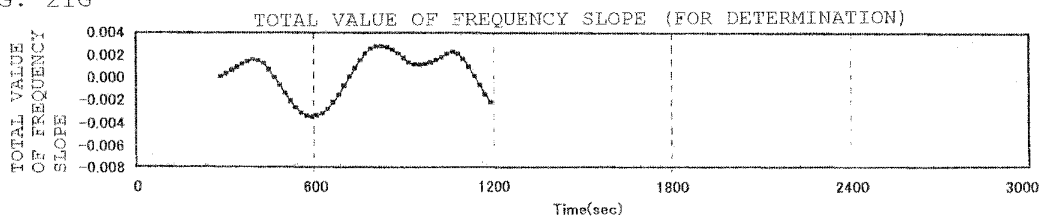

FIG. 22A

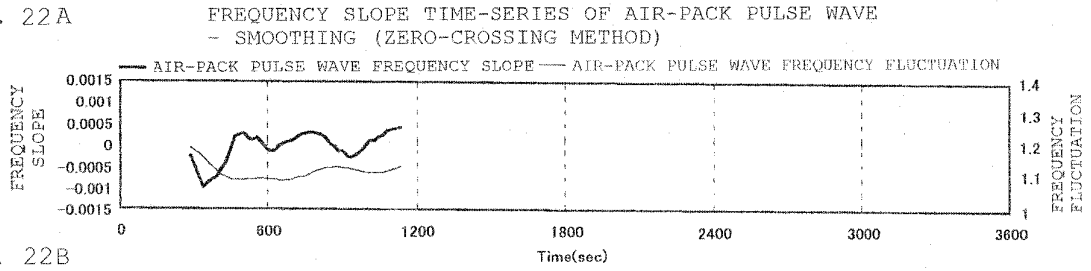

FIG. 22B

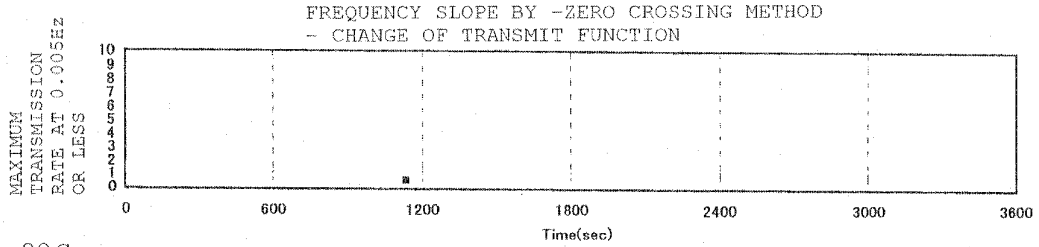

FIG. 22C

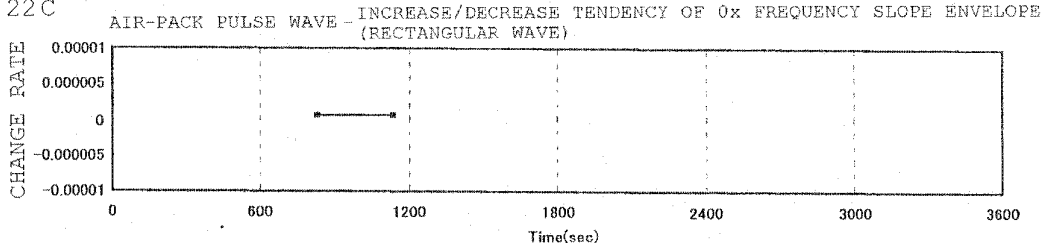

FIG. 22D

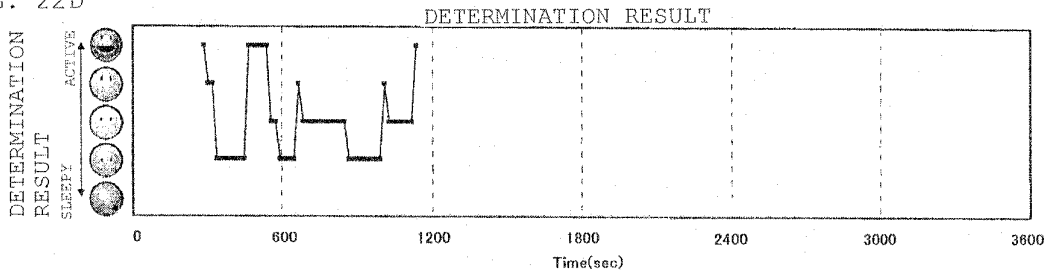

FIG. 22E

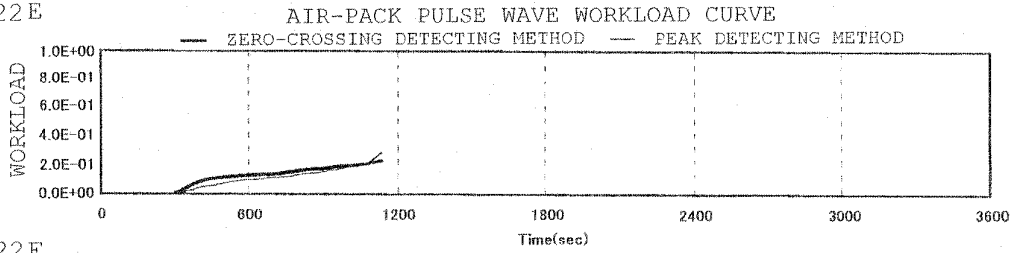

FIG. 22F

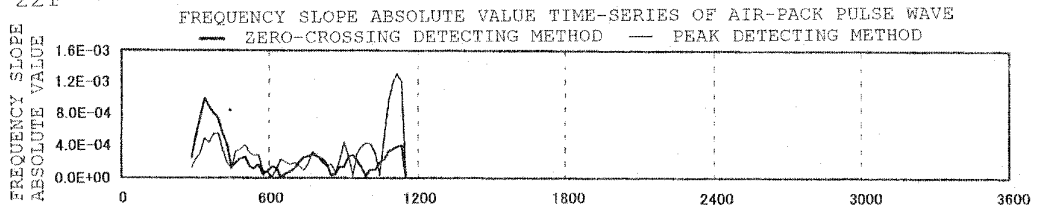

FIG. 22G

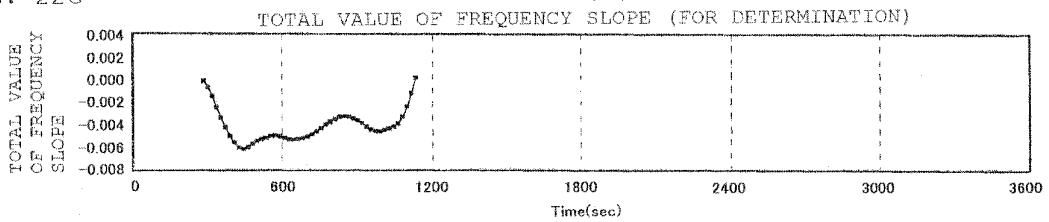

FIG. 23A

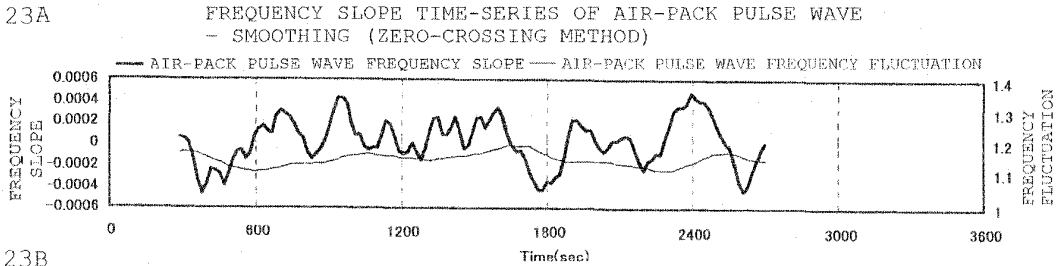

FIG. 23B

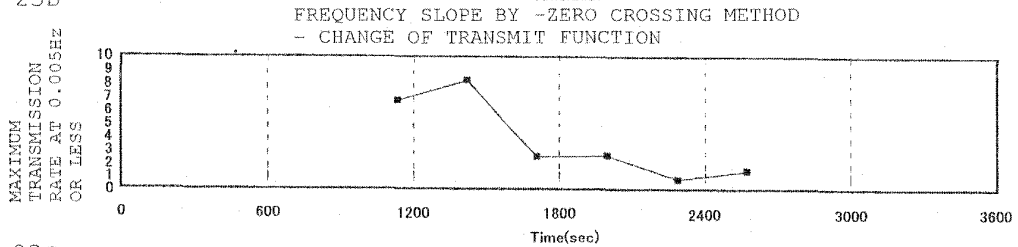

FIG. 23C

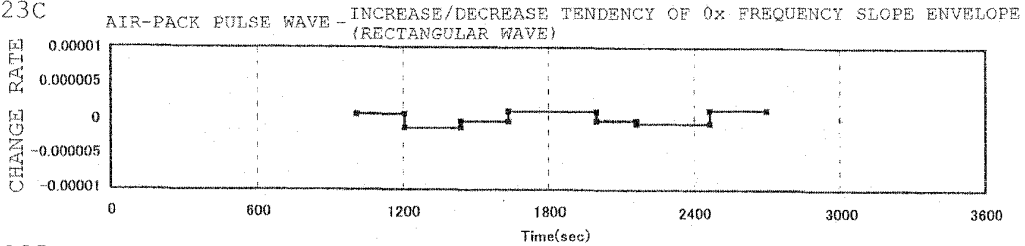

FIG. 23D

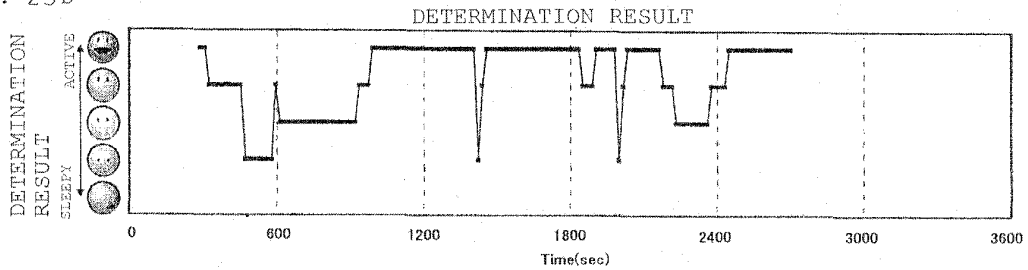

FIG. 23E

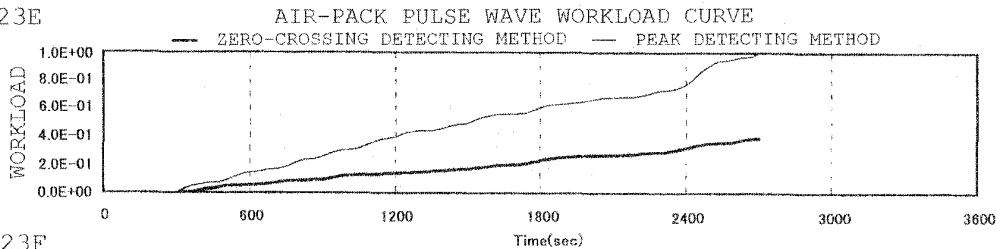

FIG. 23F

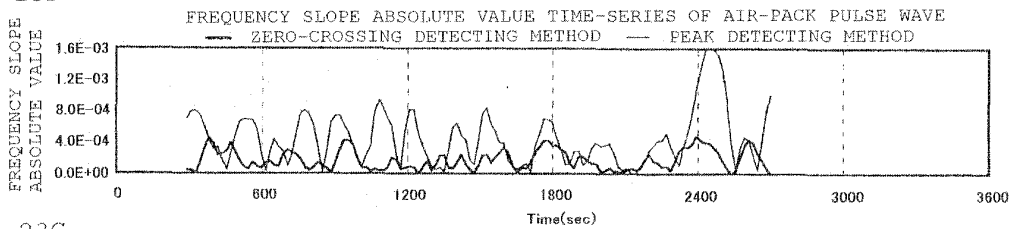

FIG. 23G

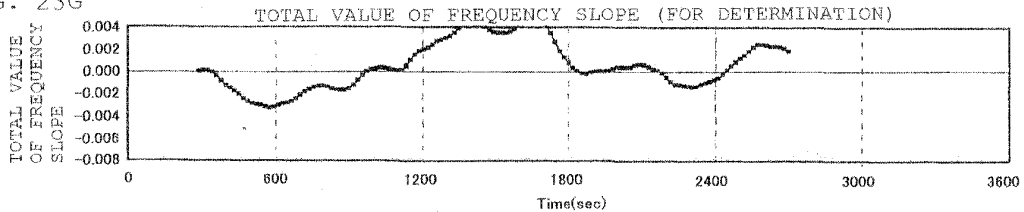

FIG. 24A

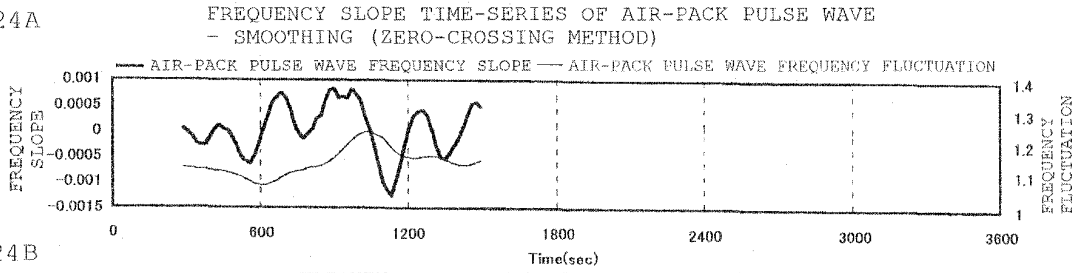

FIG. 24B

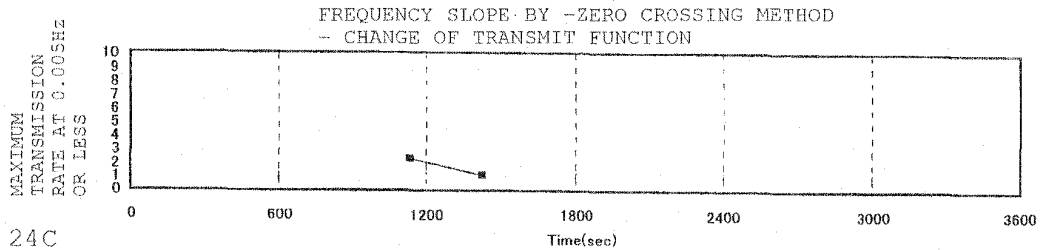

FIG. 24C

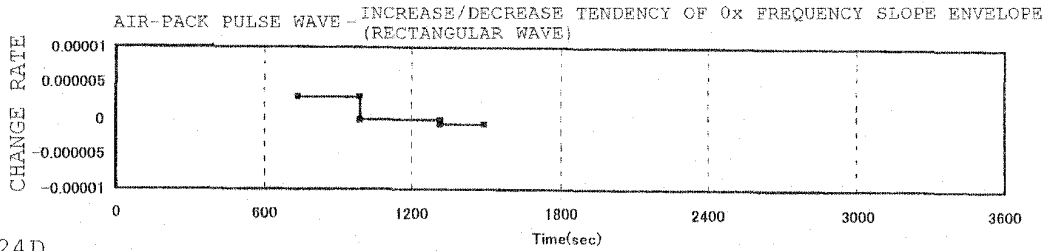

FIG. 24D

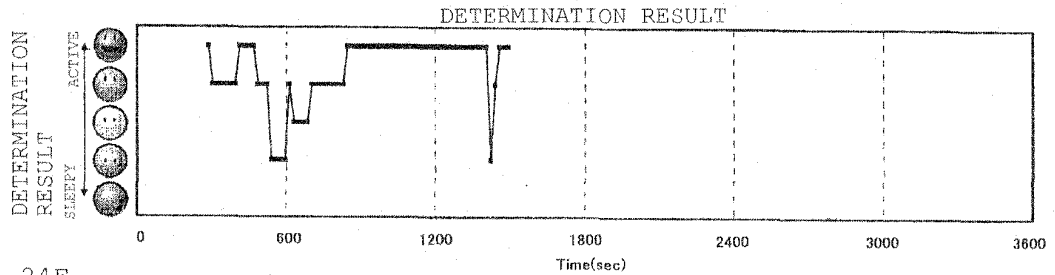

FIG. 24E

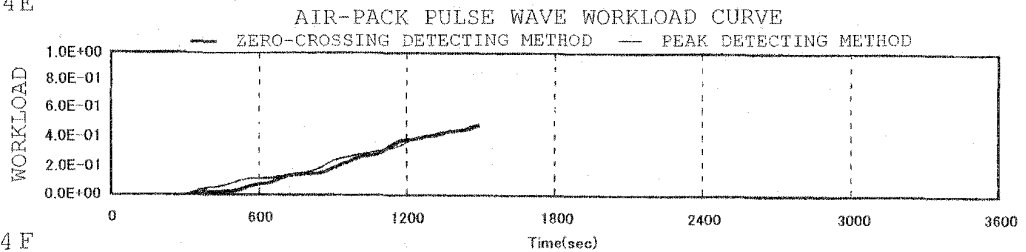

FIG. 24F

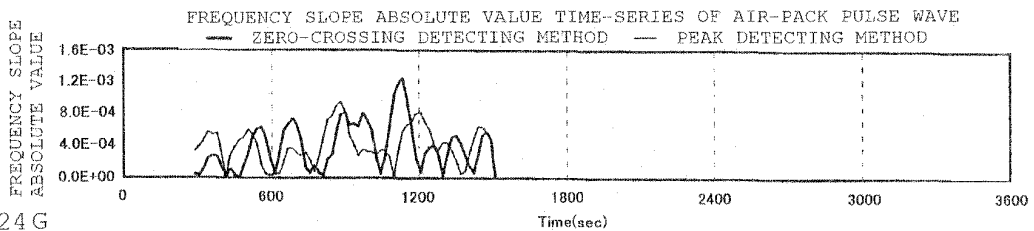

FIG. 24G

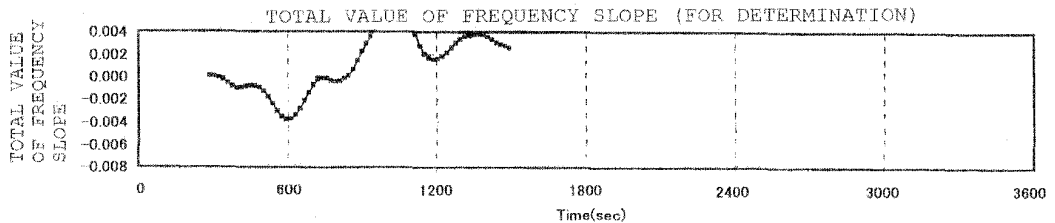

FIG. 25A

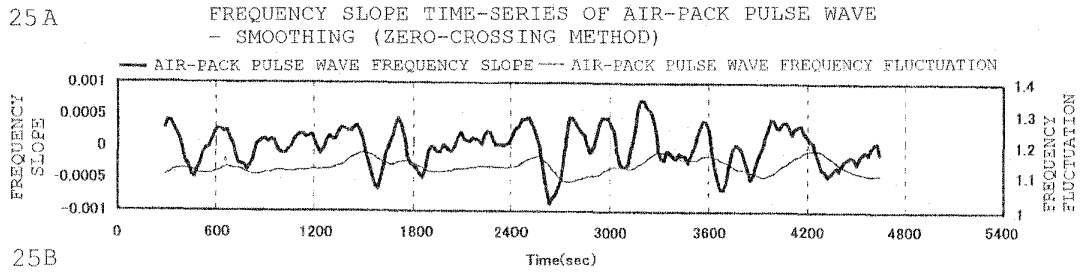

FIG. 25B

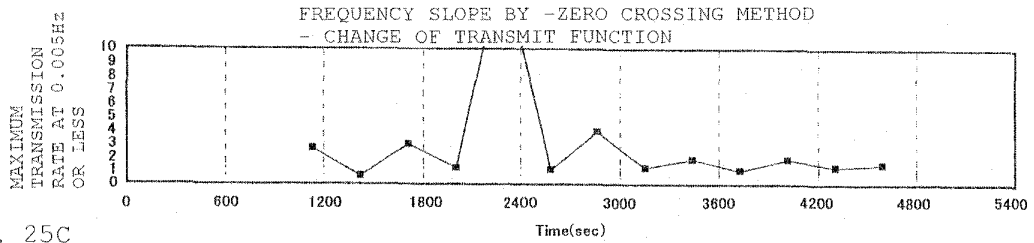

FIG. 25C

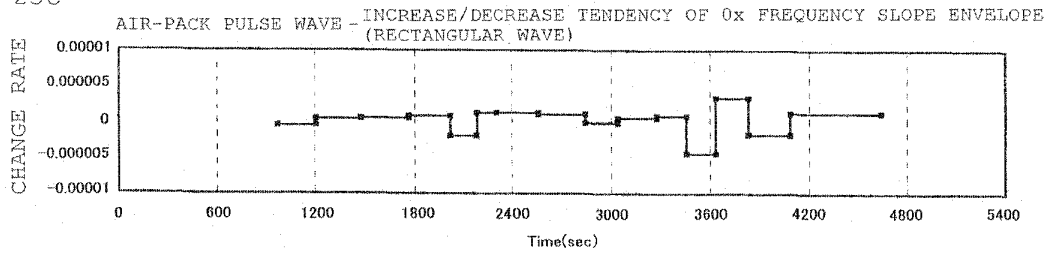

FIG. 25D

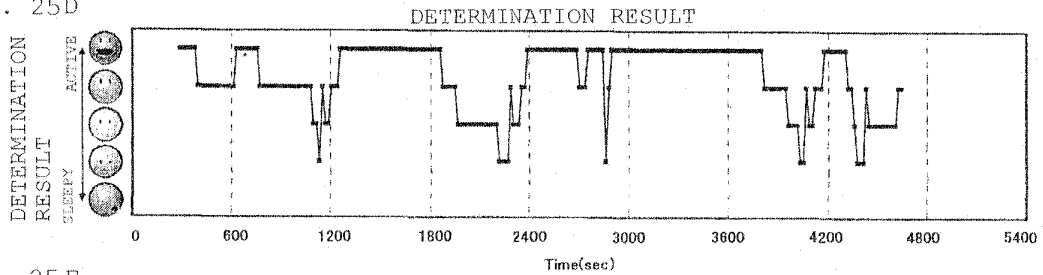

FIG. 25E

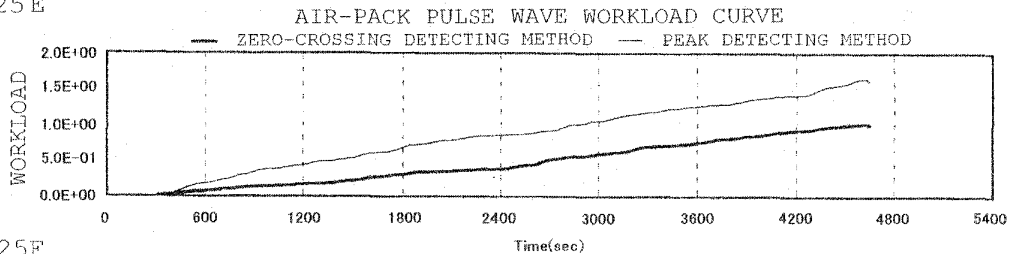

FIG. 25F

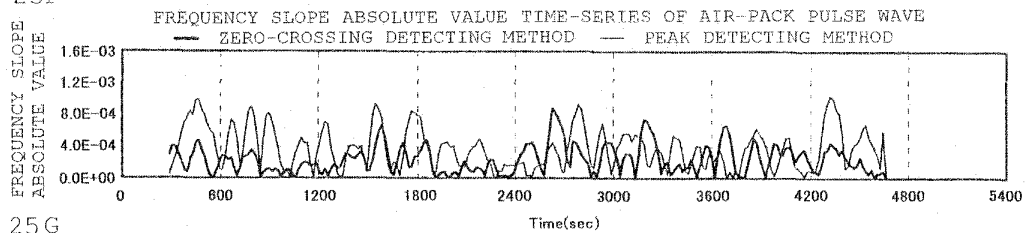

FIG. 25G

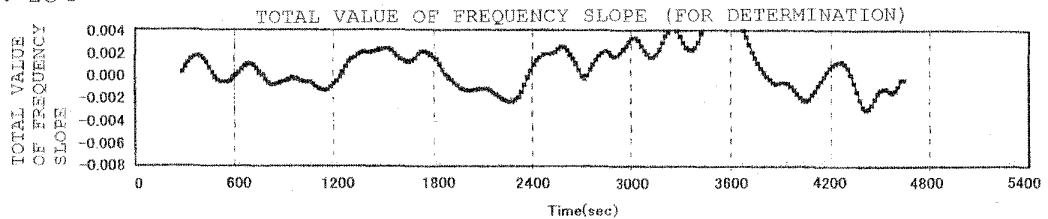

FIG. 26A

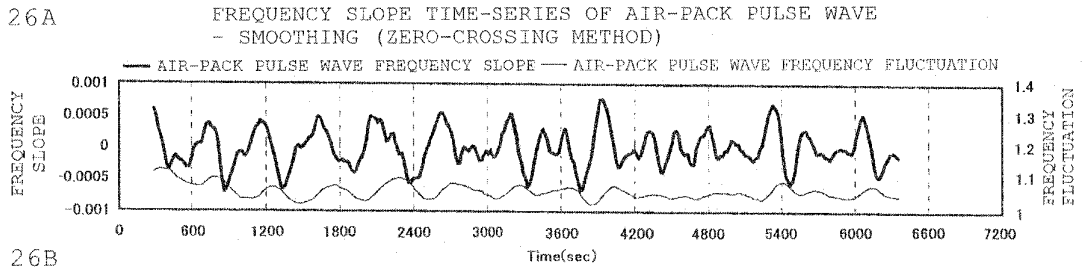

FIG. 26B

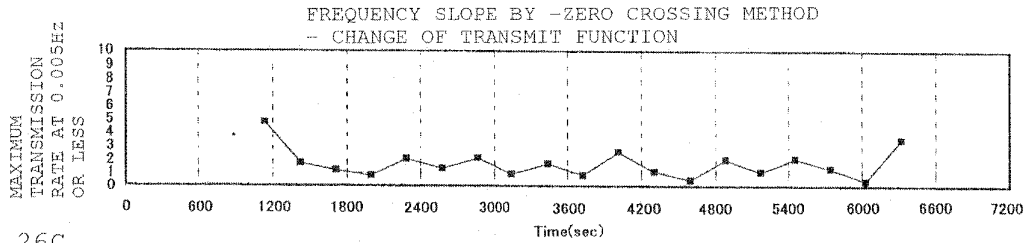

FIG. 26C

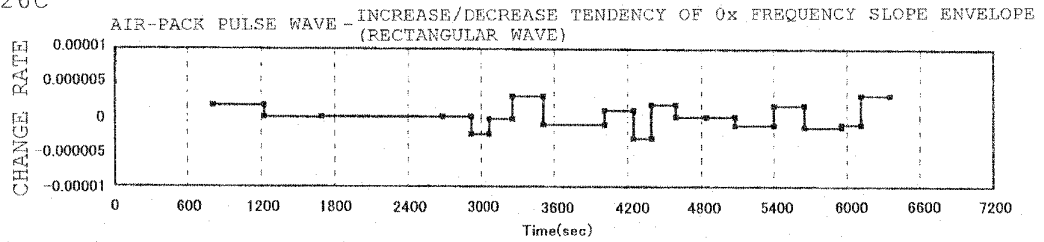

FIG. 26D

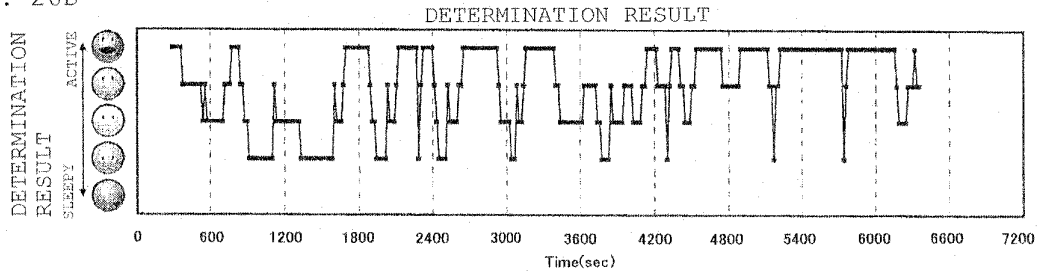

FIG. 26E

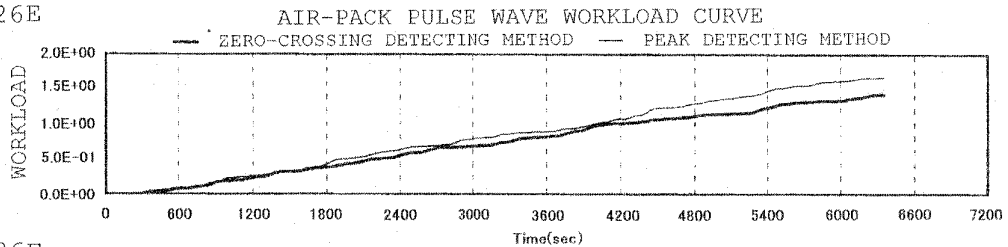

FIG. 26F

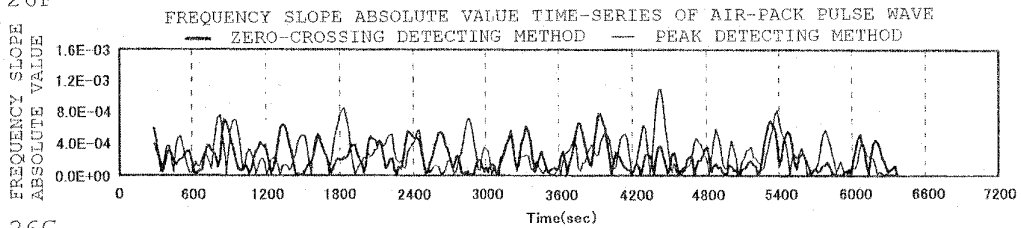

FIG. 26G

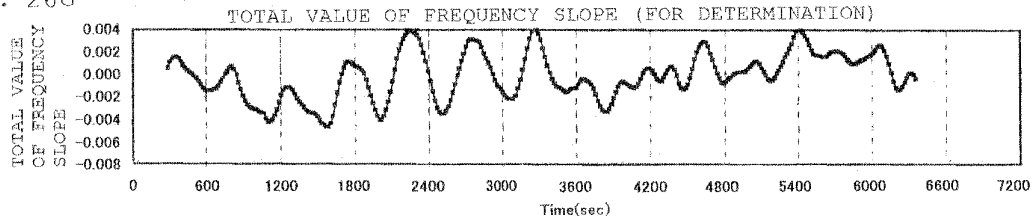

FIG. 27A

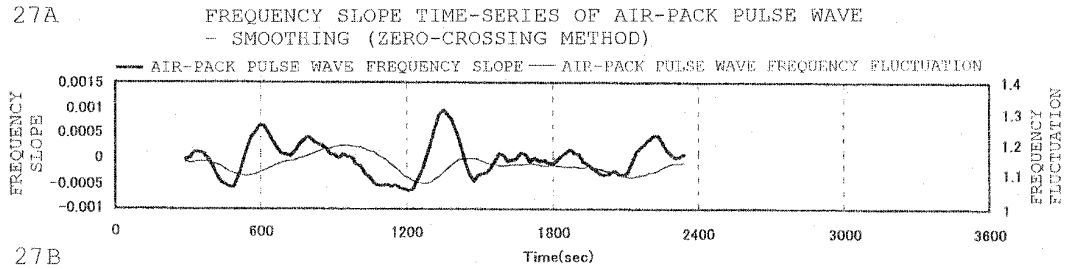

FIG. 27B

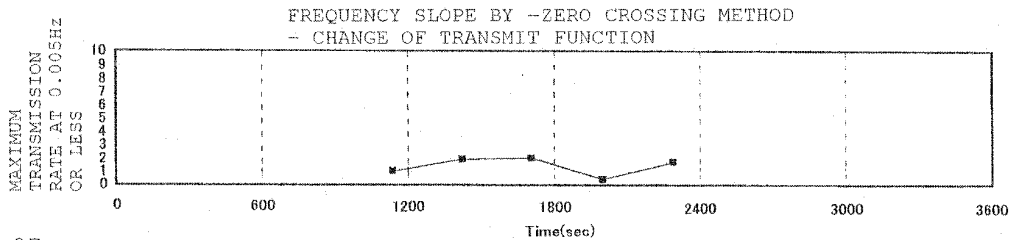

FIG. 27C

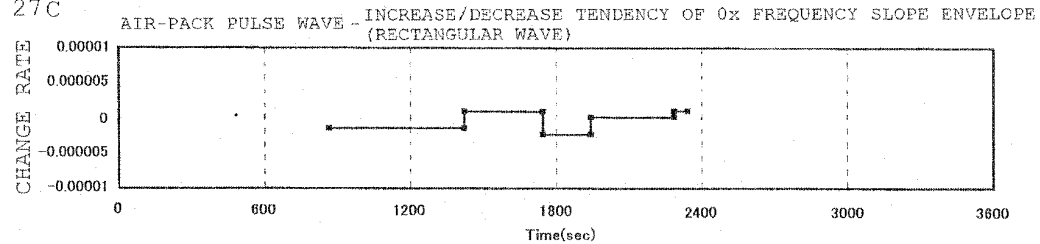

FIG. 27D

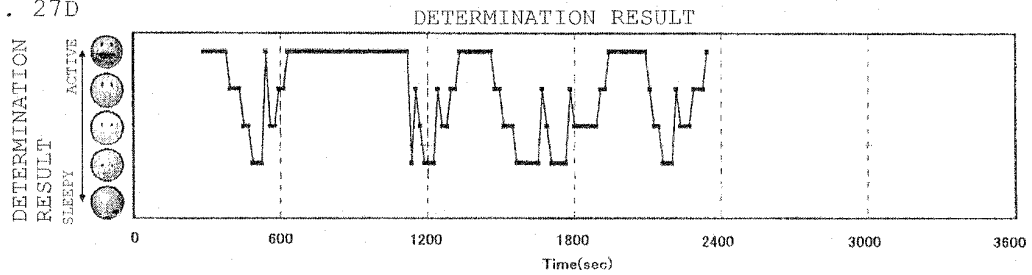

FIG. 27E

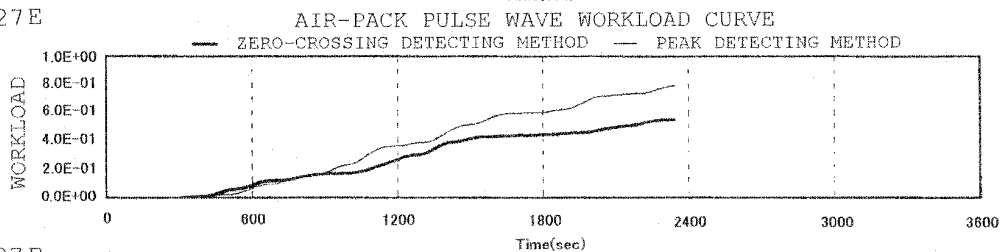

FIG. 27F

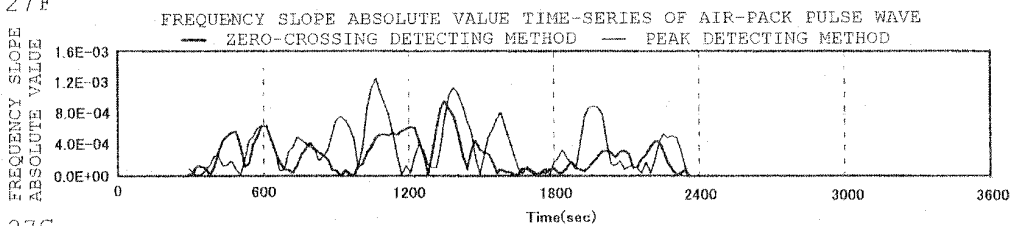

FIG. 27G

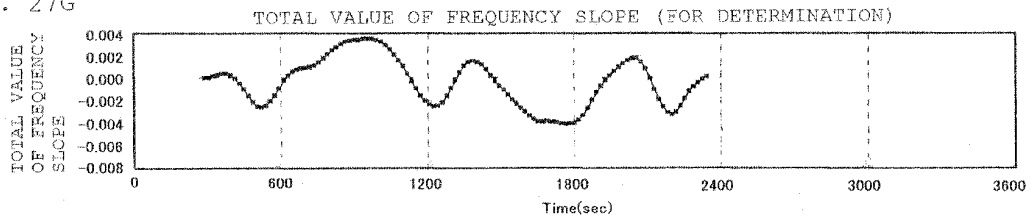

FIG. 28A

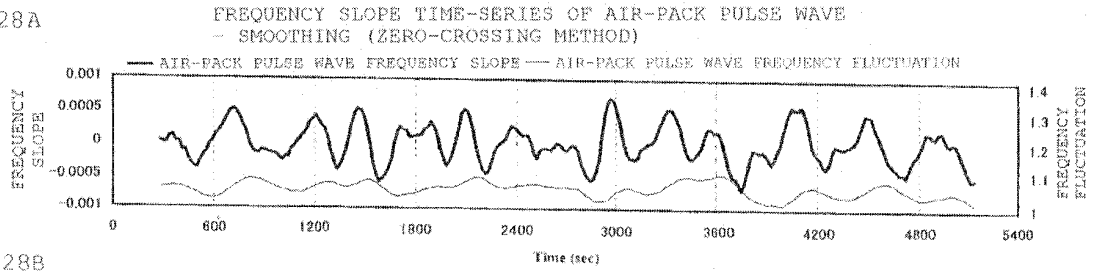

FIG. 28B

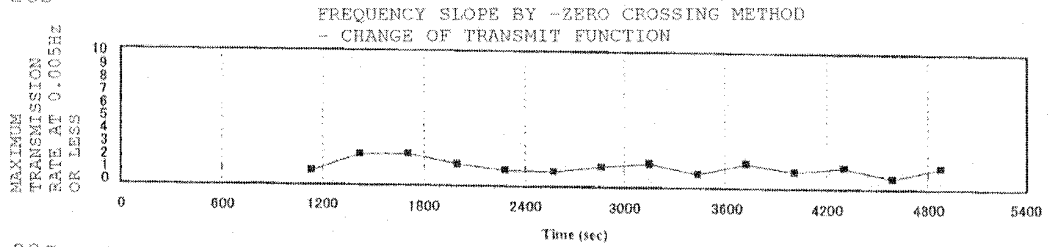

FIG. 28C

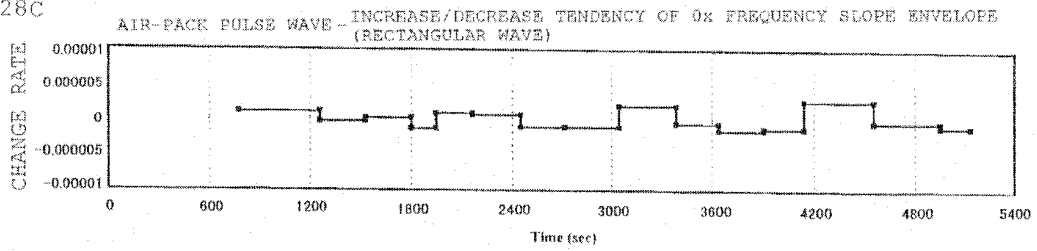

FIG. 28D

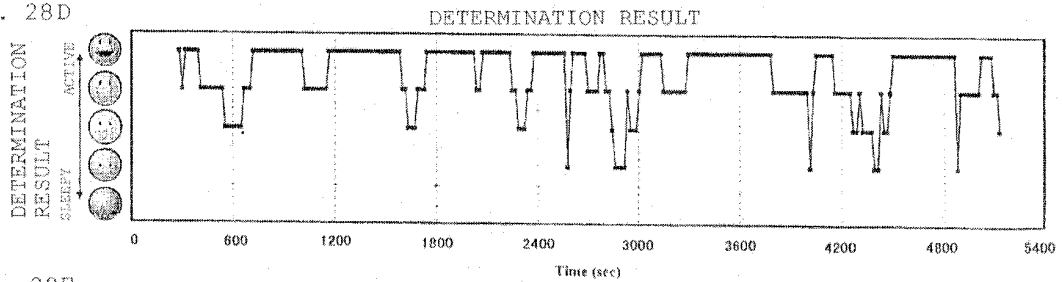

FIG. 28E

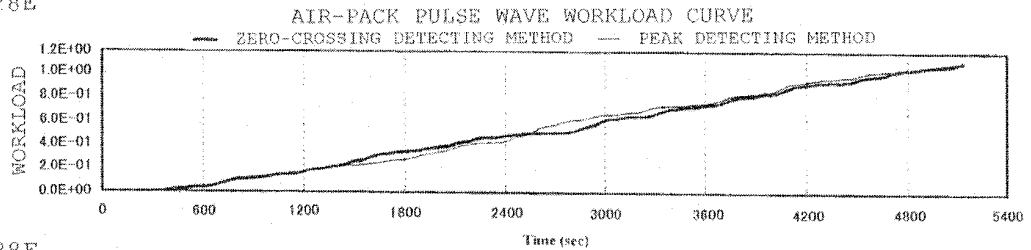

FIG. 28F

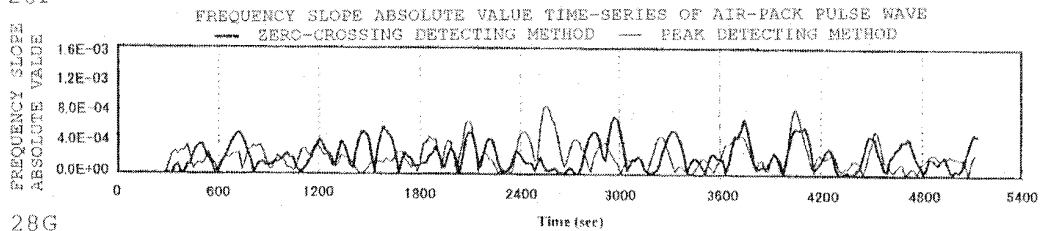

FIG. 28G

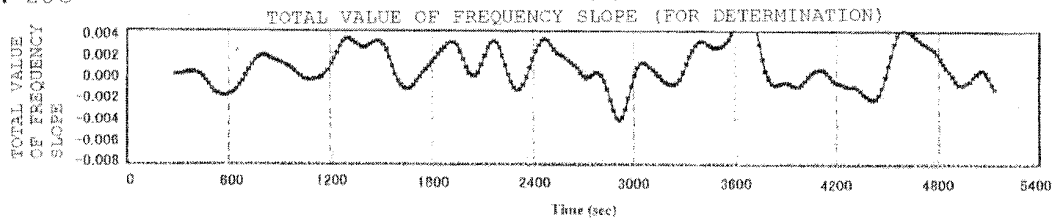

FIG. 29A

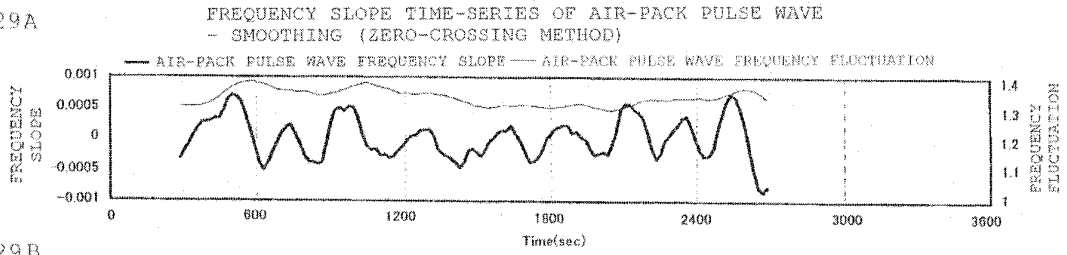

FIG. 29B

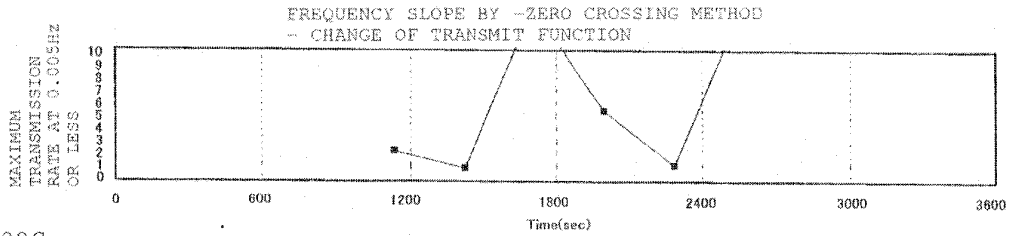

FIG. 29C

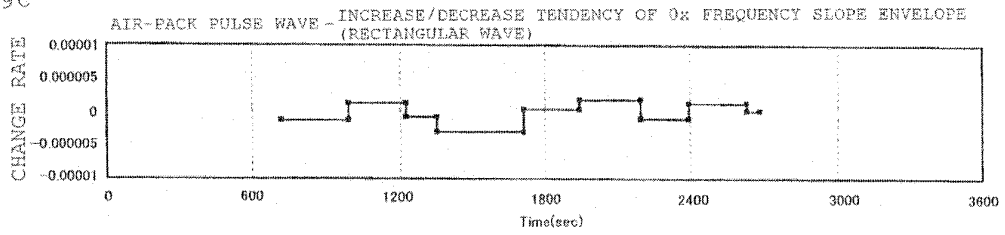

FIG. 29D

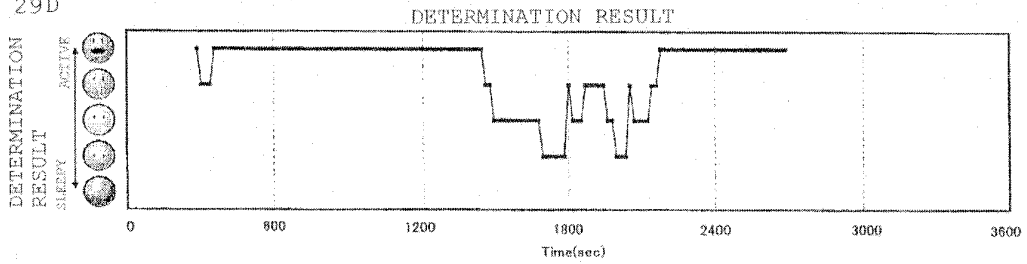

FIG. 29E

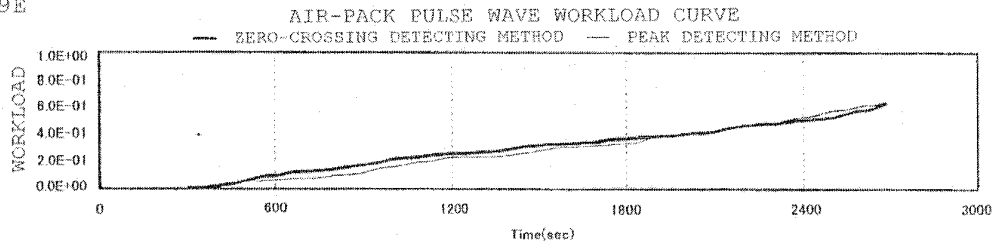

FIG. 29F

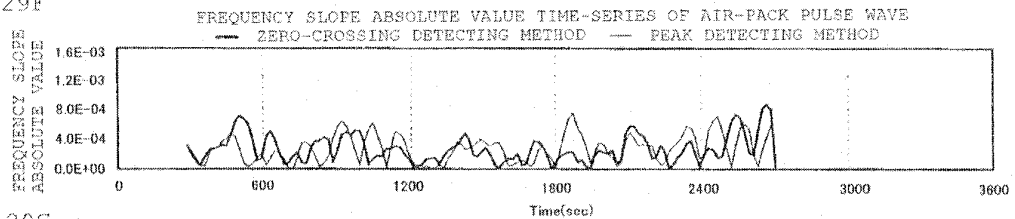

FIG. 29G

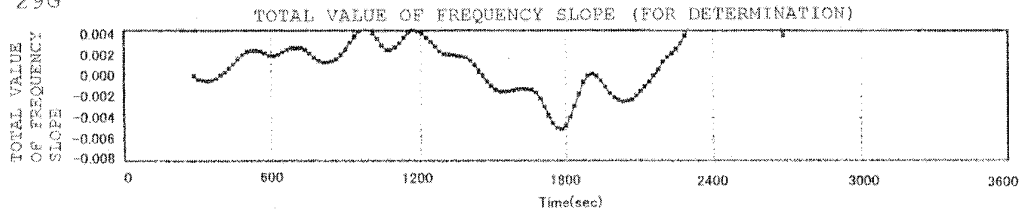

FIG. 30A

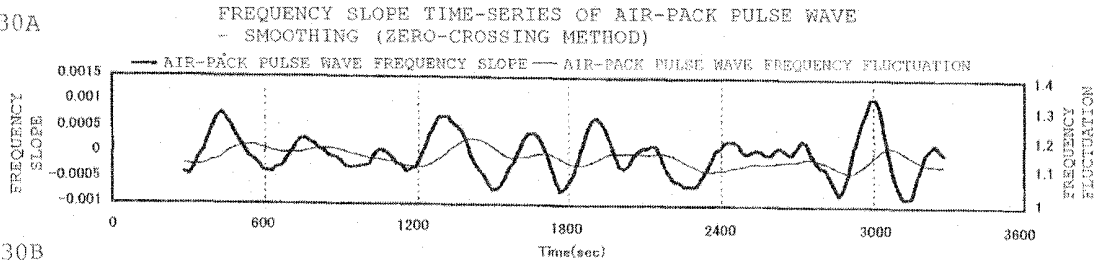

FIG. 30B

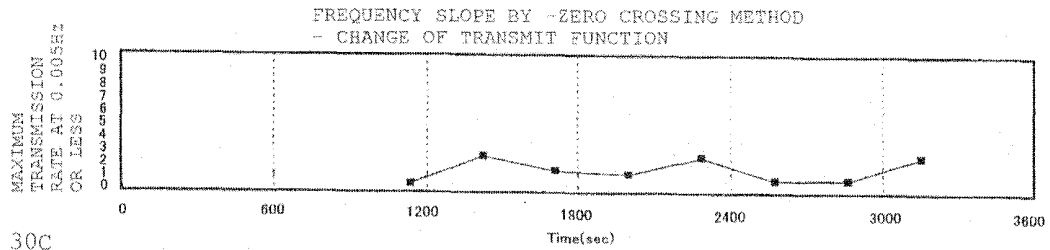

FIG. 30C

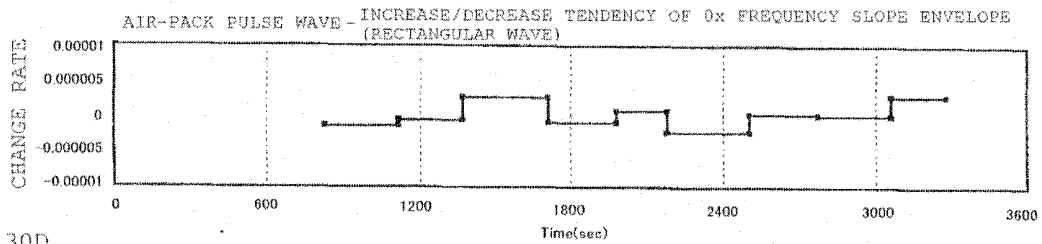

FIG. 30D

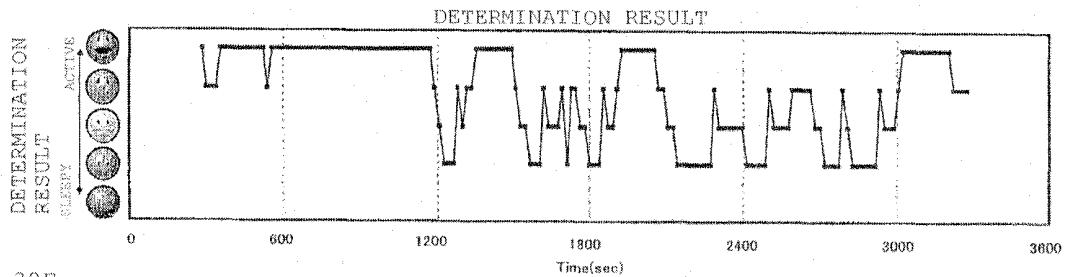

FIG. 30E

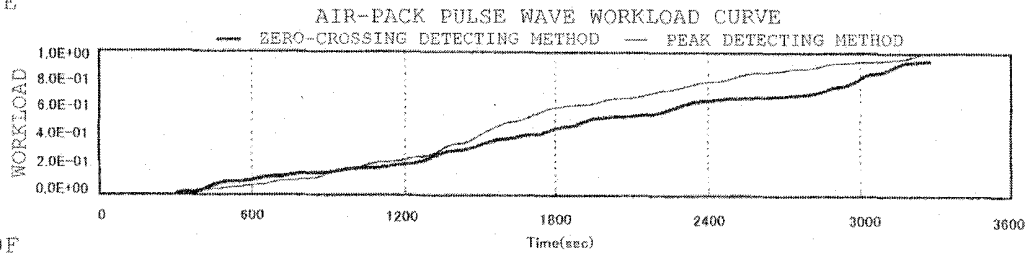

FIG. 30F

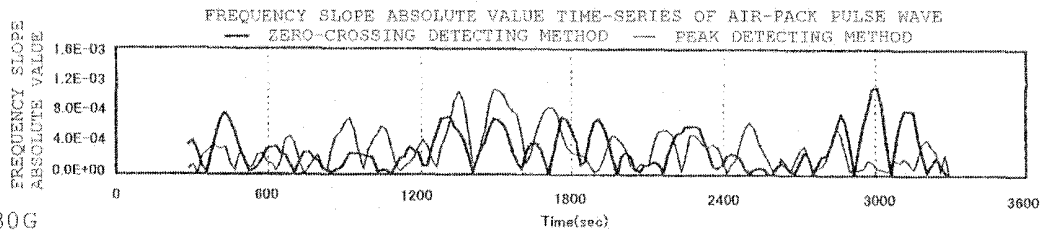
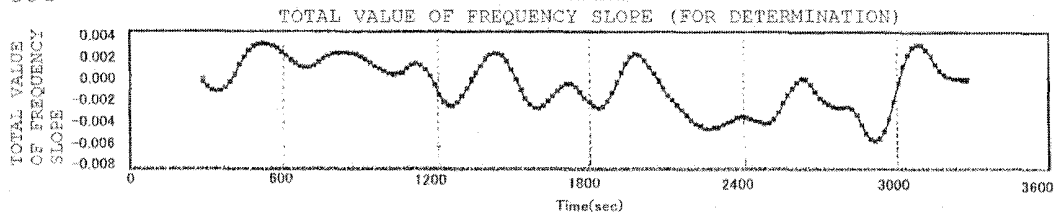

FIG. 30G



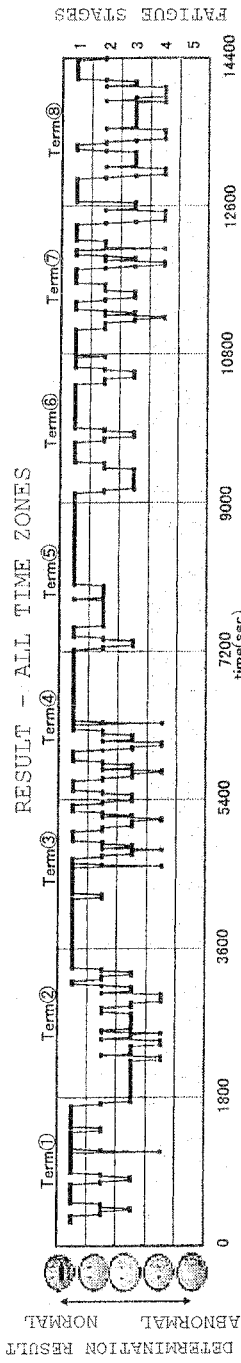

FIG. 31A

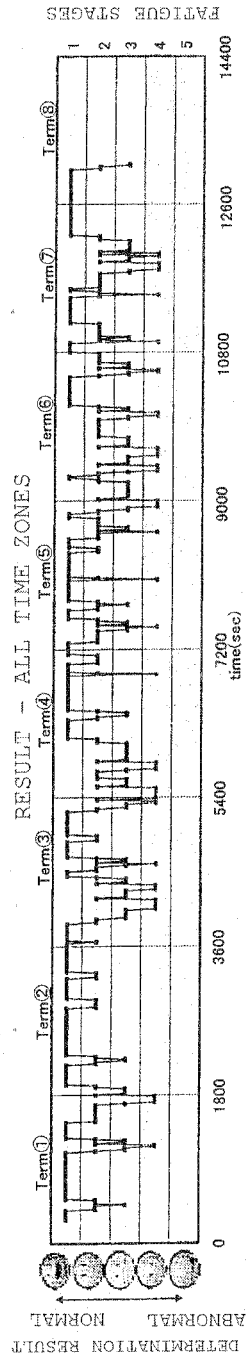

FIG. 31B

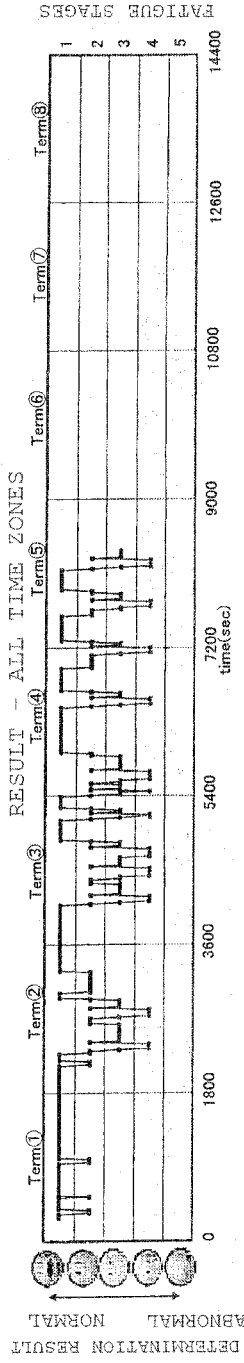

FIG. 31C

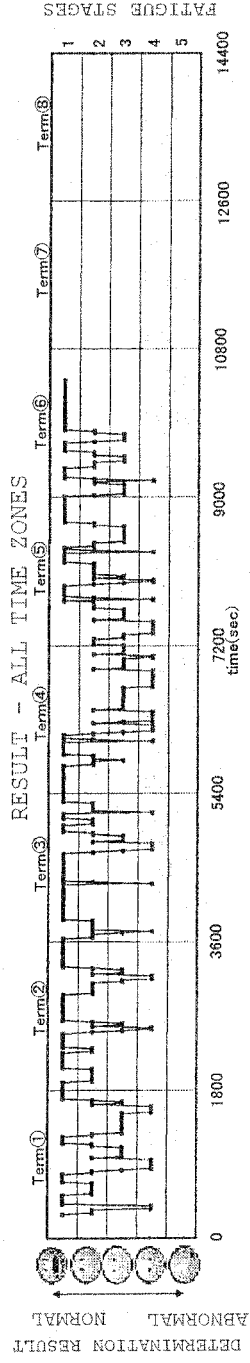

FIG. 31D

FIG. 32A

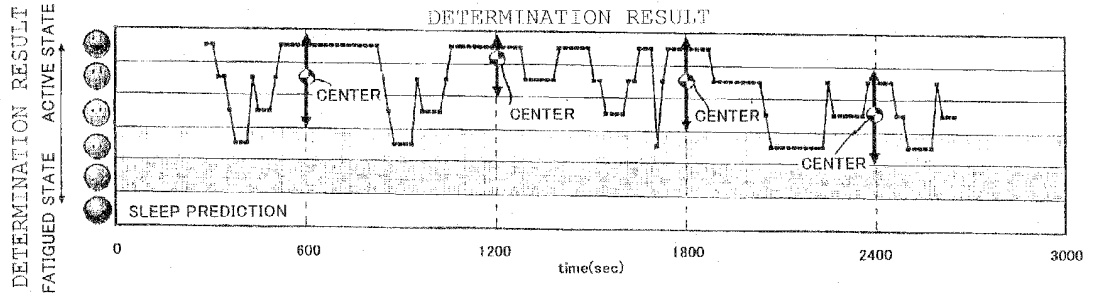

FIG. 32B

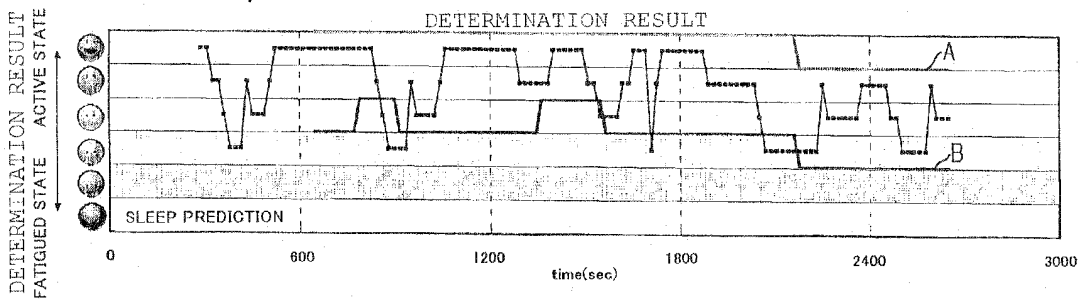

FIG. 32C

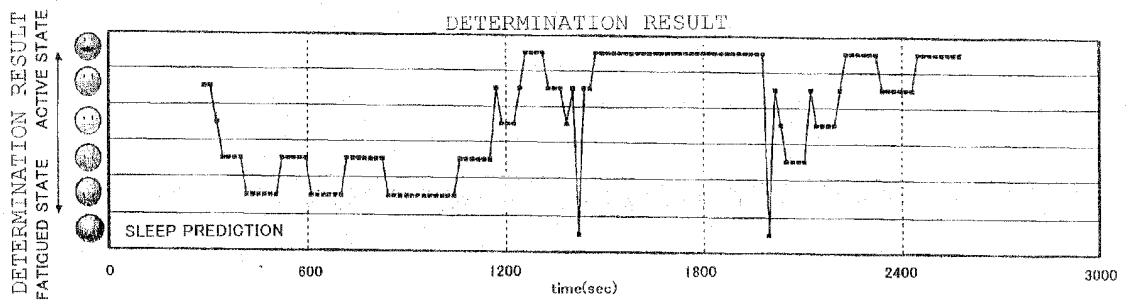

FIG. 33

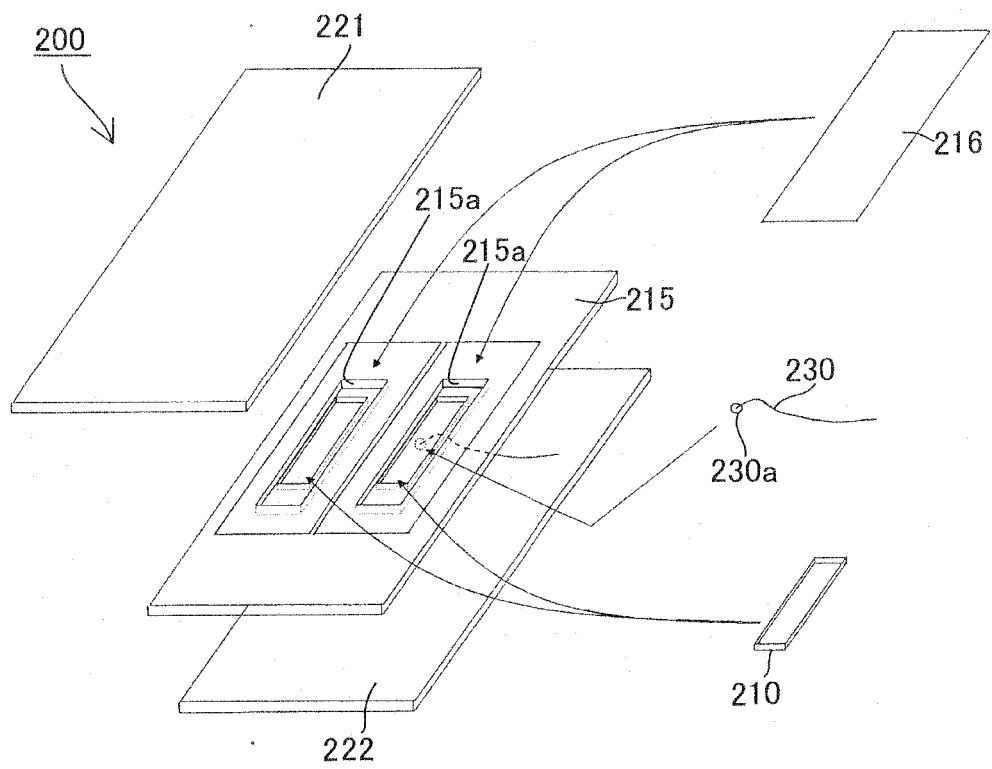

FIG. 34A

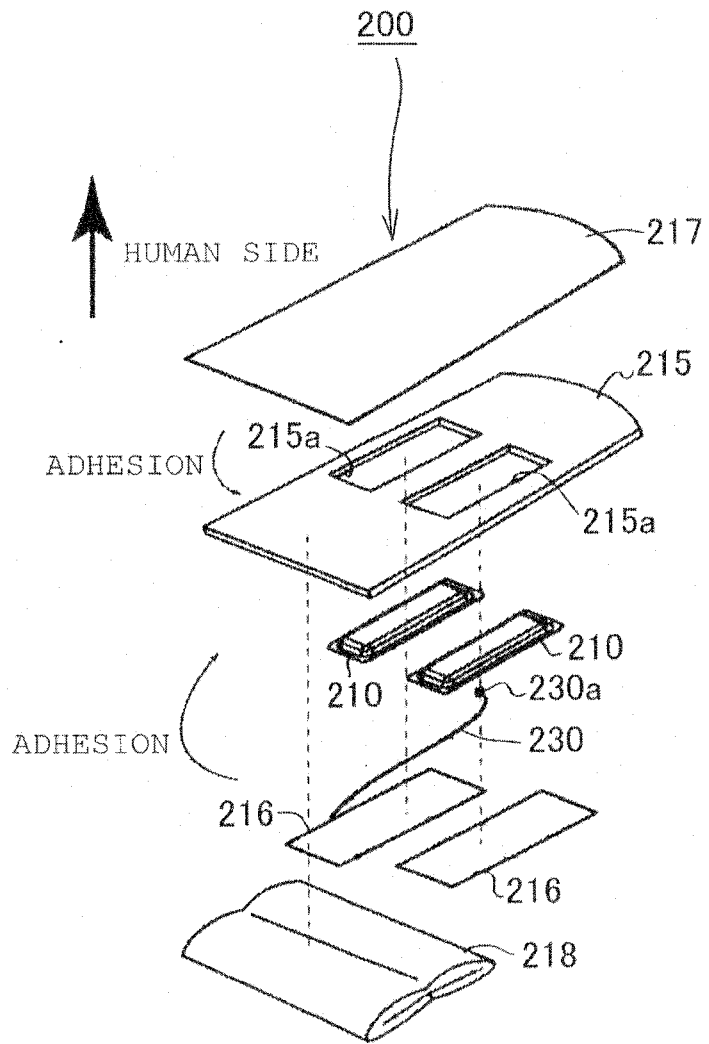

FIG. 34B

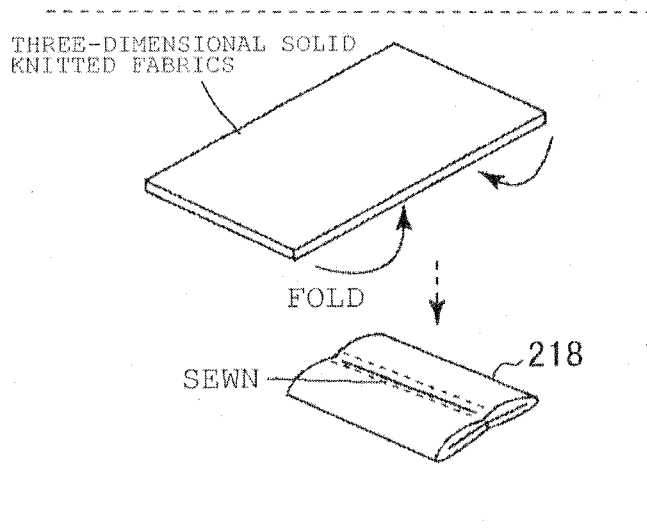
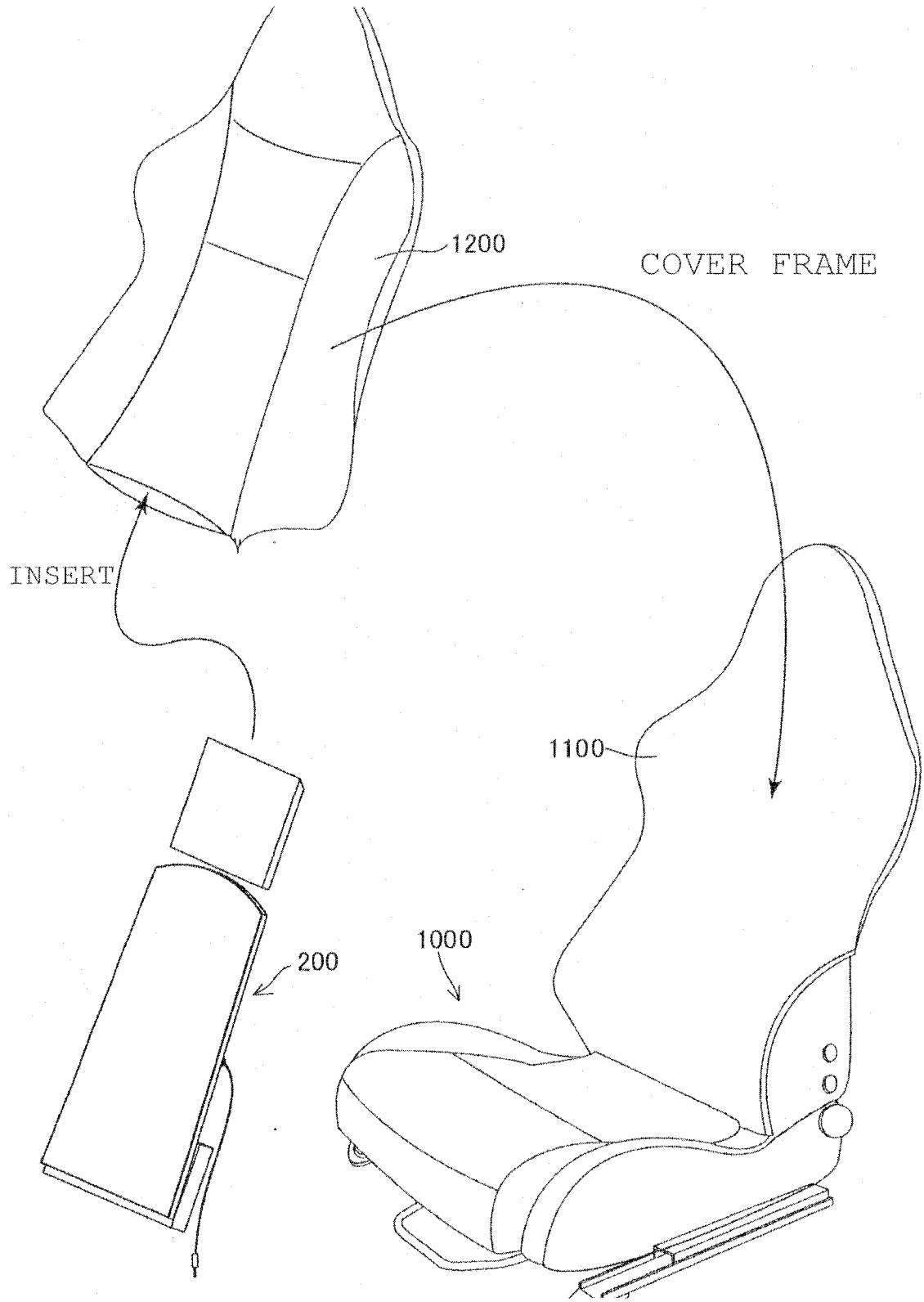

FIG. 35



**REFERENCES CITED IN THE DESCRIPTION**

*This list of references cited by the applicant is for the reader's convenience only. It does not form part of the European patent document. Even though great care has been taken in compiling the references, errors or omissions cannot be excluded and the EPO disclaims all liability in this regard.*

**Patent documents cited in the description**

- JP 2004344612 A [0007]
- JP 2004344613 A [0007]
- WO 2005092193 A1 [0007] [0071]
- JP 2007090032 A [0007]
- WO 2005039415 A1 [0007]
- JP 2009295384 A [0007]
- WO 0044580 A [0008]
- WO 2008143249 A1 [0009]
- JP 2002331603 A [0040]
- JP 2007092217 A [0043]

**Non-patent literature cited in the description**

- APPLICATION OF BIOLOGICAL WANDERING SIGNAL MEASURED BY NON-INVASIVE TYPE SENSOR TO FATIGUE AND SLEEP PREDICTION. **NAOKI OCHIAI**. 39th Japan Ergonomics Society Chugoku and Shikoku Branch convention, Collection of Literatures and Papers. Japan Ergonomics Society Chugoku and Shikoku Branch Secretariat, 25 November 2006 [0010]
- TRIAL PRODUCTION OF VEHICLE SEAT HAVING NON-INVASIVE BIOLOGICAL SIGNAL SENSING FUNCTION. **SHINICHIRO MAEDA**. 39th Japan Ergonomics Society Chugoku and Shikoku Branch Convention, Collection of Literatures and Papers. Japan Ergonomics Society Chugoku and Shikoku Branch Secretariat, 25 November 2006 [0010]

专利名称(译)	生物状态估计装置和计算机程序		
公开(公告)号	<a href="#">EP2489307B1</a>	公开(公告)日	2018-10-03
申请号	EP2010823446	申请日	2010-10-14
[标]申请(专利权)人(译)	株式会社三角工具加工		
申请(专利权)人(译)	DELTA TOOLING CO., LTD.		
当前申请(专利权)人(译)	DELTA TOOLING CO., LTD.		
[标]发明人	FUJITA ETSUNORI OGURA YUMI MAEDA SHINICHIRO OCHIAI NAOKI		
发明人	FUJITA, ETSUNORI OGURA, YUMI MAEDA, SHINICHIRO OCHIAI, NAOKI		
IPC分类号	A61B5/18 A61B5/00 B60K28/06 B60W40/08		
CPC分类号	A61B5/18 A61B5/4035 A61B5/4809 A61B5/6893 A61B5/7239 A61B5/7242 A61B5/742 A61B5/744 B60W2040/0872		
优先权	2009237802 2009-10-14 JP		
其他公开文献	EP2489307A1 EP2489307A4		
外部链接	<a href="#">Espacenet</a>		

摘要(译)

本发明提供一种生物体状态估计装置，其不仅可以捕获自主神经的活动，还可以捕获脑功能的激活状态。生物体状态估计装置被配置为使得通过使用从人的上半身获得的生物信号在多个阶段中对稳态功能水平进行分类和获取，并且以时间序列绘制稳态功能水平的每个阶段。根据横轴表示的时间轴，通过显示装置显示为图表。优选的是，图表的纵轴上的最高部分显示为高活性状态，最低部分显示为功能下降状态。结果，作为维持体内平衡，疲劳感的进展和由大脑的激活刺激的状态的自主神经引起的波动状态可以被捕获为周期性功能。此外，还可以捕获睡眠预测现象。

FIG. 1

