



(11) **EP 1 383 417 B1**

(12) **EUROPEAN PATENT SPECIFICATION**

(45) Date of publication and mention of the grant of the patent:
02.12.2009 Bulletin 2009/49

(21) Application number: **02717315.2**

(22) Date of filing: **09.01.2002**

(51) Int Cl.:
A61B 5/00 (2006.01) G01N 21/65 (2006.01)

(86) International application number:
PCT/US2002/000649

(87) International publication number:
WO 2002/060321 (08.08.2002 Gazette 2002/32)

(54) **ANALYSIS OF RAMAN SPECTRUM SIGNALS FROM SELECTED REGIONS OF THE EYE**
ANALYSE VON RAMAN-SPEKTRALSIGNALLEN VON AUSGEWÄHLTEN AUGENBEREICHEN
ANALYSE DES SIGNAUX DU SPECTRE DE RAMAN DANS DES ZONES SELECTIONNEES DE L'OEIL

(84) Designated Contracting States:
AT BE CH CY DE DK ES FI FR GB GR IE IT LI LU MC NL PT SE TR

(30) Priority: **09.01.2001 US 756897**

(43) Date of publication of application:
28.01.2004 Bulletin 2004/05

(73) Proprietors:
• **Childrens Hospital of Los Angeles Research Institute**
Los Angeles, CA 90027 (US)
• **CALIFORNIA INSTITUTE OF TECHNOLOGY**
Pasadena,
California 91125 (US)

(72) Inventors:
• **LAMBERT, James, L.**
Sunland, CA 91040 (US)
• **BORCHERT, Mark, S.**
La Canada, CA 91011 (US)

(74) Representative: **Harrison Goddard Foote**
Belgrave Hall
Belgrave Street
Leeds
LS2 8DD (GB)

(56) References cited:
EP-A- 0 722 692 WO-A-00/02479

EP 1 383 417 B1

Note: Within nine months of the publication of the mention of the grant of the European patent in the European Patent Bulletin, any person may give notice to the European Patent Office of opposition to that patent, in accordance with the Implementing Regulations. Notice of opposition shall not be deemed to have been filed until the opposition fee has been paid. (Art. 99(1) European Patent Convention).

Description**Field of the Invention**

5 [0001] The present invention concerns methods and apparatus for assessing blood brain dynamics of a subject via non-invasive spectrographic analysis of certain regions of the eye, such as the aqueous humor in the anterior chamber of the eye.

Background of the Invention

10 [0002] Non-invasive measurement of physiological and foreign substances, including blood glucose, by optical spectroscopy techniques has remained an elusive target for at least two decades. Blood, tissue, and most excreted fluids contain numerous substances which confound many spectral signatures. On the other hand, the aqueous humor (AH), which fills the anterior chamber of the eye (between the lens and cornea), contains relatively few molecules capable of interfering with the spectroscopic detection of glucose. These are primarily lactate, ascorbate, and urea. This fact, along with its optically accessible location behind the cornea, makes the AH an attractive choice as a site on which to attempt non-invasive analysis of many substances present in a biological subject, including glucose.

15 [0003] Pohjola (Acta Ophthalmologica Suppl. 88, 1-80 (1996)) showed that the ratio of aqueous glucose to plasma glucose in normal euglycemic individuals is related to age and ranges from 0.6 to 0.9. He further showed in seven humans with steady-state hyperglycemia that similar ratios applied. There is little, if any, data regarding the equilibration time of aqueous humor glucose with changes in plasma glucose in humans. Some recent research suggest that the glucose content of the AH compared with that in the capillary blood in man is about 0.75 regardless of the glycemic state of the person. See e.g., Schrader et al., The glucose contents of the aqueous humour compared with capillary blood in man, Invest. Ophthalmol. Vis. Sci. (Suppl.) 44:404 (2000).

20 [0004] Numerous investigators over the years have suggested that the ratio of aqueous glucose to plasma glucose in the normoglycemic rabbit ranges from 0.42 to 1.01 (S. Pohjola, *supra*; D. Reddy and V. Kinsey, Arch. Ophthalmol. 63, 715-720 (1960); M. Reim et al., Ophthalmologica 154, 39-50 (1967); W. March et al., Diabetes Care 5, 259 (1982)). It is uncertain whether this variability is normal or could be attributed to differences in glucose measurement techniques, collection techniques, sample storage, and anesthesia. It is believed that the relationship of aqueous glucose to rising, or falling, plasma glucose has not been previously studied in rabbits.

25 [0005] Coté has reviewed the relative strengths and weaknesses of optical glucose sensing techniques (J. Clin. Engineering 22, 253 (199.7)). Raman spectroscopy is potentially attractive because it can distinguish glucose in water solutions containing various levels of other optically active metabolites (S. Wang et al., Applied Optics 32, 925 (1993)). Raman spectroscopy measures the shift in the wavelength of incident light as it is scattered by molecules. Any given molecule typically causes a characteristic shift in the spectrum of scattered light, which is dependent upon its intermolecular and intramolecular bonds. This is in contradistinction to fluorescence, which is caused by changes in electron energy states, and does not shift relative to the wavelength of incident light.

30 [0006] Wicksted et al. (Appl. Spectroscop. 49, 987 (1995)) suggest that the Raman signature for glucose can be identified in aqueous humor samples, and Goetz et al. (IEEE Trans. Biomed. Eng. 42, 728 (1995)) have demonstrated that higher than physiologic levels of glucose can be measured with Raman spectroscopy in water solutions. J. Lambert et al. (LEOS Newsletter 12, 19-22 (1998)) suggest that measurement of glucose at physiologic levels is possible in water solutions containing other analytes normally found in the aqueous humor. In certain situations, when solutions containing fluorescent substances are studied, however, the fluorescence signal may overwhelm the relatively weak Raman-shifted signal. This is a potential problem if Raman spectroscopy is applied to certain regions in the eye, such as the conjunctiva or vitreous or aqueous humor (and/or depending upon what the Raman signal is attempting to identify or measurer), which can contain proteins that fluoresce.

35 [0007] U.S. Patent No. 5,243,983 to Tarr et al. proposes a non-invasive blood glucose measurement system using stimulated Raman spectroscopy. Stimulated Raman spectroscopy can require the use of both a pump and a probe laser beam. In operation, the probe laser beam is used to measure the stimulated Raman light at a single wavelength after transmission across the anterior chamber of the eye. Commercially, this may be undesirable, since an optical component contacting the eye is used to direct the beam across the anterior chamber. In addition, use of a single wavelength may limit the ability to measure glucose at physiologic levels within tissue containing many other Raman scattering chemicals.

40 [0008] Others have also proposed various glucose measurement devices. For example, U.S. Patent No. 5,433,197 to Stark suggests a non-invasive glucose measurement apparatus that employs broadband, infrared light stimulation. In addition, U.S. Patent No. 5,553,617 to Barkenhagen proposes a non-invasive method for measuring body chemistry from the eye of a subject by measuring a spectral response such as a Raman scattering response. While the latter reference alleges that it may be used for medical applications (such as the determination of sugar in diabetics), specific details on how this might be accurately carried out are not provided. Another example is found in U.S. Patent No. 5,710,30

to Essenpreis, which proposes a method for measuring the concentration of glucose in a biological sample such as the eye (see Figure 4 therein) with interferometric measurement procedures. Still another example is proposed in U.S. Patent No. 5,666,956 to Buchert et al., wherein it is proposed that an instrument for the non-invasive measurement of a body analyte can be based on naturally emitted infrared radiation.

5 [0009] WO-A-00/02479 describes methods and systems that employ Raman spectroscopy to detect glucose levels and the like. This reference also states that the integrity of the blood brain barrier can be monitored using Raman spectroscopy, although the document does not disclose the use of resonance Raman spectroscopy.

10 [0010] In spite of the foregoing efforts, a commercially viable, non-invasive monitor which can successfully employ a non-invasive optical analysis of certain regions of the eye, including the aqueous humor of the eye, has not yet been developed. Difficulties in developing such a device include: (a) determining reliable correlations of the typical millimolar quantities of selected substances or chemicals; (b) obtaining accurate measurements of selected substances; and (c) inhibiting damaging effects to the eye which may be caused by excessive exposure to light in an instrument that is used to generate the analysis signal spectrum in the AH. Accordingly, there is a continued need for improved systems, methods, and devices for the non-invasive *in vivo* analysis of foreign and natural physiologic substances in a biological subject via optical analysis of certain regions of the eye.

Summary of the Invention

20 [0011] According to a first aspect of the present invention, there is provided an in-vivo non-invasive method for determining the level of an analyte of interest in a biological subject, the method comprising the steps of:

- (a) generating an excitation laser beam;
- (b) focusing the excitation laser beam into the eye of the subject so that a selected region of the eye is illuminated;
- (c) detecting a Raman spectrum from the illuminated region of the eye;
- 25 (d) comparing the Raman spectrum from the detecting step to predetermined spectrums corresponding to different analytes of different concentrations;
- (e) identifying the presence of an analyte of interest based on the detecting and comparing steps; and
- (f) determining the amount of the analyte of interest in the cerebral spinal fluid from the Raman spectrum.

30 [0012] According to a second aspect of the present invention, there is provided an apparatus for the non-invasive *in vivo* determination of the level of an analyte of interest in a subject, said apparatus comprising:

- (a) a laser source (10, 40) for generating an excitation laser beam;
- (b) an optical system (22, 23, 24) operatively associated with the laser for focusing the excitation laser beam into a selected region of the eye;
- 35 (c) a detector (32, 41) operatively associated with the optical system and configured to detect a Raman spectrum from the selected illuminated region of the eye; and
- (d) a processor (35) with computer program code for comparing the detected Raman spectrum to the reference spectrums associated with the analyte, for identifying the presence of the analyte of interest, and for determining the amount of the analyte in the cerebral spinal fluid based on a correlation thereto from the Raman spectrum.

45 [0013] The present disclosure further relates to methods and systems for monitoring or evaluating the blood aqueous barrier and, thus, the blood brain barrier dynamics of the subject. The present disclosure also relates to methods which can detect the presence or absence of one or more selected substances or analytes of interest in the body by optically analyzing certain regions of the eye, including at least one of the AH, the vitreous humor ("VH"), and one or more blood vessels in the conjunctiva. In certain embodiments, the analysis can provide information regarding the presence of and/or quantify a detected substance in the body such as in the cerebral spinal or intracranial fluid of the subject (indirectly, through a correlation with the presence or quantification of the substance in the blood vessel in the conjunctiva, or the AH or the vitreous humor).

50 [0014] Embodiments of the disclosure employ Raman spectroscopy to non-invasively obtain, *in vivo*, at least one signature spectroscopic signal to identify and/or measure the level or concentration of a substance or substances of interest in the subject (either in the blood and/or brain) based on the signal.

55 [0015] In certain embodiments, the present invention can be used to monitor or evaluate the blood brain barrier dynamics, which may be intentionally altered (such as through the administration of chemicals or exposure to certain environmental conditions such as increased pressure) during such evaluation. By intentionally breaking down the blood brain barrier, medicines which are normally inhibited from crossing the barrier may be allowed to more readily cross and enter into the brain. To monitor such a change in the operation or dynamics of the blood brain barrier, non-specific markers can be introduced or injected into the subject. The non-specific marker is selected based on its molecular size

and/or its normal reluctance to cross the blood brain barrier. The blood brain barrier can then be intentionally altered (broken down or opened) so that the non-specific marker is able to cross therethrough. An optical reading of a selected region of the eye can be taken, and the present invention can assess whether the marker is present (either at all or in an increased amount over a pre-alteration state) in the blood aqueous barrier. Further, in some embodiments, the concentration of the marker in the eye can be determined (such as in the AH or vitreous humor) in the blood aqueous compartment. If the marker is identified as being present, this indicates that the blood brain barrier has been altered. Once the blood brain barrier is altered, a desired treatment regimen can be administered to the subject (such as drug used for chemotherapy) to treat tumors or other conditions in the eyes or brain. In some embodiments, as an alternative to the use of non-specific markers, the present invention can monitor the presence or concentration of the treatment drug itself in the blood aqueous compartment in the eye. Examples of suitable markers include large molecule natural and synthetic substances that do not normally cross the blood brain barrier, including, but not limited to, antibiotics including antifungal agents and/or erythromycin, and conjugated substances such as conjugated bilirubin.

[0016] Typically, the treatment drug is configured such that it is inhibited from crossing the blood brain barrier. Thus, in certain applications, in order to deliver a sufficient quantity of the drug to the brain, the amount of drug, which is systemically delivered, can be undesirably toxic to the patient away from the targeted treatment region in the brain. The present invention can now assess or assure either that the barrier is sufficiently altered to allow the drug to pass more efficiently therethrough and/or quantify or assess that a sufficient amount of the treatment drug is getting into the brain so that the systemic amount can be more closely regulated and reduced. After the desired treatment (or dose) is indicated as delivered to the brain, the blood brain barrier can be restored such that it is substantially in its pre-altered state. The return to the pre-altered state can be confirmed by taking another optical reading to confirm that the marker is in a reduced concentration in the blood aqueous compartment in the eye.

[0017] By identifying and/or quantifying the amount of the non-specific marker present in the aqueous humor (and, thus in the blood aqueous barrier), an estimate or determination of the concentration in the brain is established. Typically, the concentration in the blood aqueous humor can be presumed to be similar to that in the blood brain compartment. Further, the two concentrations can be correlated so that a quantitative value of the amount in the cerebral spinal or intracranial fluid is determined based on that found in the blood aqueous compartment so that a titrated dose of the treatment drug in the brain may be able to be determined. The correlation relationship or ratio may vary within certain population segments. In certain embodiments, the correlation relationship can be determined based on data collected across a representative population (by age, size, weight, gender, race, disease or physiological impairment or abnormality, or national origin). Thus, the amount of the selected treatment drug actually getting into the brain can be correlated to the systemic dose delivered to the patient to that the dose or level in the spinal fluid is sufficiently high for treatment of the tumor or other condition but the systemic dose is sized to provide reduced toxicity to the subject (by avoiding administering unnecessary quantities to the subject).

[0018] In certain embodiments, the present invention can provide methods, similar to that discussed for intentionally altering the dynamics of the blood brain barrier, which use a non-specific marker with a new drug to evaluate the impact that a new drug or therapy regimen has on the blood brain barrier for safety or other considerations.

[0019] In other embodiments, the optical detection of an analyte, agent, or drug itself, in certain regions of the eye, without the use of a marker, may be sufficient to indicate the drug's impact on the blood brain barrier.

[0020] In other embodiments, the environmental conditions surrounding the patient or subject, can be altered and the dynamics of the blood brain barrier monitored. For example, subjects which are exposed to different elevations, gravity conditions, or to increased intracranial pressure, may exhibit different or altered blood brain barrier characteristics, either transiently, or more chronically, than persons not so exposed. These subjects may include astronauts, pilots, divers, trauma victims, and the like. Evaluating the blood brain barrier dynamics can identify whether larger molecules or pathogens are able to cross the blood brain barrier, which may, under normal circumstances, be inhibited or prevented from entering the brain. In certain embodiments, the present invention can be used to assess which constituents in the blood cross into the intracranial fluid via the blood brain barrier.

[0021] As generally described above, in one embodiment, a patient can undergo a treatment regimen to deliberately or intentionally alter the blood brain barrier dynamics so that an identified treatment agent(s) is allowed to cross the barrier. For example, an osmotic agent such as a drug (for example, MANATOL) can be delivered to a subject being treated for cancer to force the blood brain barrier to open (preferably for a limited-time treatment window) to successfully allow a selected chemotherapeutic agent (such as a cytotoxic agent) to be able to more readily cross the blood brain barrier into the brain. Non-invasive monitoring of the tumor dose according to the present invention, can allow monitoring of the barrier dynamics and may, in some embodiments, be able to assess when an adequate, but not excessive, tumor dose is delivered to the brain. The blood brain barrier can be reestablished after the appropriate tumor dosing is delivered. This monitoring of the blood brain barrier dynamics during a treatment regimen may now inhibit or reduce systemic damage in the subject associated with the cytotoxic treatment.

[0022] In other embodiments, the present invention provides systems and methods for detecting the presence of a predetermined substance or identifying the presence of an unknown substance in the body of a subject. The substances

which can be measured or identified are numerous and can be (a) natural physiologic analytes or chemicals, such as glucose, amino acids, peptides, antibodies, blood (typically using light outside the red spectrum), and/or (b) foreign substances such as medicaments, drugs, or poisons (whether legal or illegal, and whether prescription or over the counter). For example, the present invention can be used to assess the presence of targeted illegal substances, such as alcohol or illegal narcotics such as cocaine, pcp, marijuana, or to identify what toxin or poison a subject has ingested out of a number of household or environmental toxins and/or poisons such as herbicides, pesticides, household cleaning products, petroleum products or other common household chemicals including benzene, ethylene glycol. The methods and systems of the instant invention may even be used to identify the presence of poisonous plants, insect toxins, and reptile or snake venom. The present invention may be configured to identify whether an unknown substance in a subject is one or more of toxins/agents associated with the most prevalent poison-related emergency room visits. For example, ethylene glycol, methanol, and acetaminophen.

[0023] In certain embodiments, the present invention can be used to quantify the amount of a substance in the subject. Typically this embodiment may be particularly suitable for those substances ingested or existing in relatively large quantities or those present in sufficient quantity in the selected region of the eye so as to be detectable *in vivo*, or so that the substance or analyte is present in physiological levels (in the blood or blood aqueous compartment) of above about 0.001% or above about 0.01-10 μ molars, depending on the Raman active characteristics of the analyte of interest. For example, for certain substances having molecules that generate resonant Raman spectra and, the signal strength can be greatly enhanced for certain excitation wavelengths that, in turn, may reduce the amount of the analyte that is detectable over non-resonant Raman spectra at that wavelength.

[0024] In addition, in certain embodiments, the devices and methods of the present invention may be used to detect increased or decreased levels of physiologic analytes such as caused by system impairments or reactions associated with dehydration, allergic reactions, or physiologic analytes associated with bacterial infections such as spinal meningitis, or to identify whether proteins or antibodies are present in elevated levels to identify a systemic response or a localized infection or disease in the eye or an immune system response, in the subject. Certain particular embodiments of the invention may also be used to treat the eye.

[0025] In certain embodiments, the systems and methods of the present invention may be able to detect or identify toxins released or emitted from foods contaminated with food poisoning bacteria such as *E coli*, salmonella (either *in vivo* or *in vitro*). Further, in some embodiments, the methods and systems of the present invention may be used to identify the presence of mad cow disease by analyzing certain regions of the eye (either *in vitro* or *in vivo*) such as by obtaining a Raman spectrum of a desired region of the eye analyzing the spectrum to detect the presence of small peptides or other markers associated with the disease. Other diseases may be able to be identified *in vivo* by the presence of a systemic reaction (such as an increased constituent level of a natural physiologic substance) in the subject. It is anticipated that such a method may be potentially used to assess whether the subject has contracted Lyme disease associated with deer tick bites or Rocky Mountain spotted fever.

[0026] In some embodiments, the invention can identify the presence of one or a plurality of household or environmental poisons in the subject in a relatively fast "triage" assessment to allow clinicians to determine the appropriate treatment in a timely manner. This can be particularly important for pediatric applications where the substance ingested may be difficult to ascertain for young children, and a relatively quick identification of a particular toxin or toxins ingested may allow more reliable or faster treatment decisions to be established.

[0027] One embodiment of the invention is directed to an *in vivo* method for monitoring the blood brain barrier dynamics of a subject, comprising the step of monitoring the dynamics of the blood brain barrier by non-invasively obtaining the Raman spectrum of a selected region in the eye of the subject. The method may also include the step administering a non-specific marker to the subject selected for its normal reluctance to cross the blood brain barrier under the normal condition. The monitoring step can comprise detecting the presence of the non-specific marker in the selected region of the eye of the subject.

[0028] In certain embodiments, the method can include the steps of: altering the dynamics of the blood brain barrier of the subject from a normal condition; and administering a quantity of a selected therapeutic agent to a subject for treatment of condition in the brain or neurological system after the altering step. It can also include the step of substantially returning the blood brain barrier to its normal state after a sufficient quantity of the therapeutic agent has been delivered to the brain. Similarly, the monitoring step can be performed before the therapeutic drug is administered to the subject and subsequently to confirm that the blood brain barrier is substantially returned to its normal condition. The method may also include the step of assessing the dose amount of the therapeutic agent delivered to the brain.

[0029] Certain embodiments of the present invention are directed to an *in vivo* non-invasive method for determining the level of an analyte of interest in a biological subject. Raman spectroscopy can be used to obtain the signature of the substance in the eye (such as in the AH, VH, or blood vessel in the conjunctiva) and, in some embodiments, to measure the concentration of a natural physiologic or foreign substance, such as glucose and/or proteins, or drugs, alcohol, environmental or household toxins, in the subject. The method can include the steps of: (a) generating an excitation laser beam (*e.g.*, at a wavelength of from about 400 to 900 nanometers); (b) focusing the excitation laser beam into the

eye of the subject so that a selected region of the eye is illuminated; (c) detecting (preferably confocally detecting) a Raman spectrum from the illuminated region of the eye; (d) comparing the Raman spectrum from the detecting step to predetermined spectrums corresponding to different analytes of different concentrations; and (e) identifying the presence of an analyte of interest based on the detecting and comparing steps.

5 **[0030]** This disclosure also provides a method as disclosed above and including an additional step (f) to determine the blood or brain level of an analyte of interest for the subject from the Raman spectrum. However, the additional step (f) for determining the blood level of an analyte does not fall within the scope of the present invention as claimed. The blood or brain level may be indirectly computed based on the concentration or amount of the analyte in the blood aqueous compartment (or can be directly measured in the blood itself for the conjunctiva vessel measurement). For the
10 indirect measurement, that value can be correlated (or adjusted/corrected) to provide an assessment of the amount of the substance in the cerebral spinal fluid or blood. The correlation may be such that the amount of the substance directly measured in the AH is substantially similar to that in the cerebral spinal fluid. Alternatively, data correlating the relationship can be established and an empirical or statistical model established.

15 **[0031]** Although not required, in some embodiments, the detecting step can be followed by the step of subtracting a confounding fluorescence spectrum from the Raman spectrum to produce a difference spectrum; and determining the blood level of the analyte of interest for the subject from that difference spectrum, preferably using linear or nonlinear multivariate analysis such as partial least squares or artificial neural network algorithms. This technique may be particularly suitable where fluorescence is problematic for optical measurements taken directly of the blood level (*i.e.*, by focusing at the blood vessels in the conjunctiva or at the vitreous humor).

20 **[0032]** In certain embodiments, a low energy excitation wave can be used to generate the Raman signal spectrum. "Low energy", as used herein, means power which is on the order of about 10-400mJ or less, and typically between about 70-330mJ. The energy exposure will depend on the power and pulse length of the excitation pulse. Longer wavelength pulses (*i.e.*, above 700) may be used, typically with energy levels closer to the higher end of the scale, while lower wavelengths (400-700) may be used with lower energy exposure levels. In one embodiment, a wavelength of
25 about 633nm can be used for a pulse of about 5-10 seconds corresponding to about a 2-5mW power exposure level (and between a 10-20 or 25-50 mJ energy exposure to the patient's eye (or eyes)) for each measurement or monitoring signal obtained. In other embodiments, an optical excitation pulse may have a 785nm wavelength, a pulse length of about 20 ms-5s and a power rating of about 14-16 mW. In one embodiment, a 5sec, 16mW pulse can be used to obtain the *in vivo* reading of a cancer agent in the selected region of the eye (typically the AH). In yet other embodiments, for
30 detecting and/or quantifying the presence of substances comprising particular molecules, an excitation wavelength can be selected that substantially corresponds to the absorption spectrum wavelength (for predetermined molecules that generate resonant Raman) with a reduced power requirement of between about 1-5mW and an exposure time of about 10 seconds or less.

35 **[0033]** In some embodiments, the excitation beam can be transmitted such that it presents a reduced energy/density exposure rating to the tissue of the eye by shaping the beam to increase the cone angle or span of the excitation beam as it enters the eye to expose more of the area of the retina and reduce the energy/area rating of the excitation pulse to provide improved margins of safety (placing the energy/area rating sufficiently below the threshold of damage). In other embodiments, the transmission path numerical aperture is substantially matched to the return path numerical aperture (of the spectrometer).

40 **[0034]** This disclosure also relates to an apparatus for the non-invasive *in vivo* determination of the blood level of an analyte of interest in a subject. However, the above apparatus for determination of the blood level of an analyte is not part of the claimed invention. The apparatus includes a laser source for generating an excitation laser beam (*e.g.*, at a wavelength of from about 400 to 900 nanometers) and an optical system (*e.g.*, a confocal optical system) operatively associated with the laser for focusing the excitation laser beam into a selected region of the eye, including one or more
45 blood vessels in the conjunctiva of the eye, the vitreous humor, or the anterior chamber of an eye (or eyes) of the subject so that the aqueous humor in the desired region of the eye is sufficiently illuminated. The apparatus also includes a detector operatively associated with the optical system and configured to detect a Raman spectrum from the selected illuminated region of the eye and a processor with computer program code for identifying the presence of one or more selected substances or analytes of interest. The computer code may also include code for determining the *in vivo* level
50 of the analyte of interest in the selected region of the eye and to establish a measure of the analyte in the blood or cerebral spinal fluid to be established based on a correlation thereto for the subject from the Raman spectrum.

[0035] Focusing the optical analysis on the blood vessels in the conjunctiva can allow for a direct measurement of the substance in the blood, while the measurements taken from other portions of the eye can be correlated to provide a quantification of the substance in the blood and/or in the cerebral spinal fluid (*i.e.*, indirect measurements). The correlation's can be established based on empirical models or actual measurements taken *in vitro* or *in vivo* on a representative
55 animal or human population as is well known to those of skill in the art.

[0036] In certain embodiments, the apparatus can be configured as a low energy unit to inhibit the exposure of the tissue during the operation of the apparatus. The excitation wavelength at the low power may be less than 700nm, such

as about 406nm or 633 nm.

5 [0037] Numerous additional features may be incorporated into the apparatus. The device may include a visual display screen for presenting visual indicia to the user, which can be individually adjusted and focused to the particular visual acuity of the subject (similar to vision screening focusing procedures). The apparatus may include a visual display screen for visually displaying the results of the test to the subject (such as through the same aperture or adjacent active matrix screen) as which the test is conducted. It may include a visual fixation target or device, also visible through the test aperture, which controls movement of the eye and simultaneously insures that focusing of the laser beam is properly directed into the anterior chamber of the eye. The processor may contain empirical models of actual testing experience to either determine the blood level or concentration of the analyte of interest or to identify the presence of selected substances. The apparatus may employ a laser of fixed wavelength, a tunable laser (which can sample a plurality of Raman scattered light (at different wavelengths) concurrently), a plurality of fixed wavelength lasers, or other light source means some of which can include means for sliding the Raman spectrum passed a plurality of different wavelength detectors to obviate the need for a full grating based Raman spectrometer (by taking a plurality of samples). The apparatus may include a wireless or remote communication line operably associated with the processor for transmitting the blood level of the analyte of interest to a remote location (such as for emergency home calls to an ER room).

10 [0038] Other devices may be particularly configured to detect the presence of a selected substance and thus, configured to detect the ensemble profile of the spectrum or a peak or peaks of interest. A compact, inexpensive device can include a fixed wavelength diode laser excitation source (configured to operate so as to generate a resonant Raman spectrum for a molecule of interest), and a filter, a lens, and detector.

20 [0039] This disclosure also relates to an *in vivo* method for administering drug or chemical therapy to a subject (such as for treatment of a cancerous tumor in the brain). The method includes the steps of: (a) administering a dose of a selected therapeutic agent to a subject; (b) altering the dynamics of the blood brain barrier from its normal state; (c) monitoring the dynamics of the blood brain barrier by non-invasively obtaining the Raman spectrum of a selected region in the eye (such as the vitreous or aqueous humor) and determining the quantity of the agent therein. The method may also include one or more of (d) estimating the dose of the therapeutic agent delivered to the brain (indirectly, based on the amount detected in the selected region of the eye) (e) repeating said monitoring step a plurality of times during the administering step; and (f) returning the blood brain barrier to its normal state after a sufficient quantity of agent has been delivered to the brain.

25 [0040] In one embodiment, the altering step can be carried out by introducing a chemical to the subject to temporarily open the blood brain barrier to allow larger molecules to pass therethrough. Further, the method can include the step of administering a non-specific marker which is reluctant to or does not normally pass through the blood brain barrier (i.e., is typically inhibited from passing therethrough). The optical analysis can monitor any increase (or the presence) of the non-specific marker in the selected region of the eye to confirm that the blood brain barrier dynamics has been altered.

30 [0041] In another embodiment, the altering step may be carried out by increasing the intracranial pressure of the subject.

35 [0042] This disclosure also relates to a method of non-invasively monitoring the blood brain barrier. The method comprises the steps of: (a) generating an excitation beam at a wavelength of from 400 to 900 nanometers; (b) focusing the excitation beam of said generating step into the anterior chamber of an eye of the subject so that aqueous humor in the anterior chamber is illuminated; (c) detecting a Raman spectrum corresponding to the illuminated aqueous humor; and (d) monitoring the AH to predict the behavior of the blood brain barrier dynamics during exposure to selected conditions based on the detecting step (based on the AH Raman spectrum analysis' indication of the presence or concentration of selected substances therein). It is anticipated that the correlation between the blood-aqueous and blood brain barrier is such that the presence and/or concentration in one can be extrapolated to that in the other.

40 [0043] Other embodiments focus the excitation beam such that it has an increased or wider cone angle to spread the light across more area of the retina. Still other embodiments are configured to focus to one or more blood vessels on the conjunctiva or to focus deeper to the vitreous humor.

45 [0044] In certain embodiments, the monitoring step can be used to assess whether the dynamics thereof alter sufficiently to allow selected analytes, which would normally be inhibited from traveling through the blood brain barrier, to pass into the intracranial spinal fluid through the blood brain barrier. In other embodiments, the monitoring step can be carried out when a person is under or exposed to extreme conditions such as when diving, flying, or mountain climbing, or when suffering from a traumatic head or brain injury, or high stress, and the like.

50 [0045] The method can also include the steps of comparing the Raman spectrum from the detecting step to reference spectrums corresponding to at least one selected analyte of interest; and identifying the presence of the least one analyte of interest in the subject based on the detecting and comparing steps in the selected region of the eye. The method may also be able to estimate the dose or affirm the presence of the analyte in the subject's cerebral spinal fluid.

55 [0046] This disclosure also relates to a method for identifying an alteration in the blood brain barrier of a biological subject, comprising the steps of: (a) non-invasively obtaining a first *in vivo* Raman spectrum of the aqueous humor of the subject; (b) non-invasively obtaining a second *in vivo* Raman spectrum of the aqueous humor of the subject; and

(c) identifying an alteration in the blood brain barrier by comparing the first and second Raman spectrums.

[0047] This disclosure also relates to a method for identifying an alteration in the blood brain barrier of a biological subject, comprising the steps of: (a) non-invasively obtaining a first *in vivo* Raman spectrum of the aqueous humor of the subject; (b) obtaining a reference spectrum of an *in vitro* sample representing the aqueous humor and comprising at least one selected analyte; and (c) comparing the *in vivo* Raman spectrum to the reference spectrum to identify an abnormality in the blood brain barrier by detecting the presence of at least one selected analyte in the AH thereby indicating its presence in the intracranial fluid of the subject.

[0048] The at least one selected analyte can be one which typically does not cross the blood brain barrier so that its presence is indicative of an abnormality or impairment or successful intentional alteration of the blood brain barrier dynamics.

[0049] Each of the embodiments of the invention may include computer program products and computational and look-up table associated therewith to identify the presence of the selected substance or substances of interest (and/or calculate the amount or concentration thereof) and to operate or control (regulate) the power of the excitation pulse emitted from the laser, and the illumination and detection of the scattered light. For example, in certain embodiments, the present invention can include a computer program product for determining the identity of an unknown substance in a subject. The product can comprise computer-readable program code comprising: (a) computer readable program code for defining at least one signature reference spectrum for at least one selected substance of interest; (b) computer readable program code for analyzing an *in vivo* obtained Raman spectrum of the aqueous humor of the subject; and (c) computer readable program code for based evaluating whether the *in vivo* Raman spectrum corresponds to at least one of the at least one signature reference spectrums by comparing selected characteristics between the reference spectrum and the *in vivo* spectrum.

[0050] In various embodiments, the computer readable program code for defining the different reference spectrums can be for a particular one or a plurality of different selected substances. Examples of the selected substance(s) include, but are not limited to: drugs or analytes of interest including, but not limited to, alcohol, a substance banned for athletes in competition, a plurality of illegal narcotic substances, a plurality of household products or common poisons for humans or animals which are potentially poisonous to a subject when ingested, a chemotherapy agent, an antifungal agent, antibiotics, naturally occurring *in vivo* analytes, and the like. A master look-up reference data base providing Raman spectrum data for one or a large quantity of different poisons or substances can be generated and stored at a central database or at local or regional offices, clinics or the like. The computer program can include means for remotely accessing the data such as via the use of an intranet or internet.

[0051] The present invention will now be described further and includes other features and analytes that can be included in the methods and apparatus described herein.

Brief Description of the Drawing

[0052]

Figure 1 is a graph which illustrates the broad spectrum of water in the aqueous humor, which, in some situations, can obscure the underlying peaks of interest in the Raman spectrum. The raw spectrum of rabbit aqueous humor is shown taken at 2 slightly different wavelengths (top). The difference spectrum (bottom) achieved by subtracting 1 raw spectrum from the other reveals a resultant bipolar Raman signature. Linear and/or nonlinear multivariate analysis can then be applied.

Figure 2 is a graph plotting Raman predicted glucose as a function of actual glucose concentration. The glucose concentration in aqueous humor from 16 rabbits was estimated with Raman spectroscopy and compared to the actual glucose concentration measured with a commercial glucometer. The graph shows the Raman predicted glucose concentration after subtracting fluorescence and applying a linear partial least square algorithm followed by nonlinear back propagation with an artificial neural network. This resulted in a high degree of correlation ($r^2=0.98$) of predicted with actual glucose concentration. Applying the partial least squares algorithm alone resulted in lesser correlation ($r^2=0.90$).

Figure 3 is a graph plotting blood glucose as a function of time. Blood glucose steadily rises at variable rates in rabbits after administration of xylazine anesthesia. One animal (rabbit D, filled diamonds) had little change in blood glucose for unknown reasons.

Figure 4 is a graph plotting aqueous humor glucose as a function of blood glucose. Best-fit second-order polynomial curves demonstrate the relationship between aqueous humor glucose and plasma glucose while plasma glucose is rising in 9 animals. Aqueous glucose measurements from the first paracentesis of an eye correlate well with simultaneous plasma glucose (dark curve). When plasma glucose exceeds 200 mg/dL the relationship is nearly linear (dashed line). Aqueous humor glucose exceeds plasma glucose when plasma glucose is less than 200 mg/dL. The relationship of aqueous humor glucose with plasma glucose is different when the aqueous humor sample is

obtained as a second paracentesis (light curve) suggesting that the initial paracentesis disrupts normal glucose homeostasis.

Figure 5 schematically illustrates a first embodiment of an apparatus of the invention.

Figure 6 schematically illustrates a second embodiment of an apparatus of the invention.

5 **Figure 7a** schematically illustrates the method of sliding Raman spectra features through a particular detector window by changing excitation frequency.

Figure 7b schematically illustrates an apparatus of the invention that utilizes the method illustrated in **Figure 7a**.

Figure 8 illustrates a visual fixation display that can be utilized in an apparatus of the invention.

Figure 9 illustrates a visible readout display that can be utilized in an apparatus of the invention.

10 **Figure 10a** is a schematic illustration of one embodiment of a light generation or light pulse system according to the present invention.

Figure 10b is a schematic illustration of one embodiment of a detection system according to the present invention.

Figure 10c is a schematic of one embodiment of a system with a closed loop feedback control system according to the present invention.

15 **Figure 10d** is a schematic of an alternate closed loop feedback system according to embodiments of the present invention.

Figure 11 is a block diagram of a method for determining the presence or the blood level concentration of a selected analyte according to certain embodiments of the present invention. This figure does not fall within the scope of the present invention as claimed.

20 **Figure 12** is a block diagram of a method for identifying the presence of at least one selected substance in a selected region of the eye of a subject to evaluate the quantity of same in the cerebral spinal or intracranial fluid (it being assumed that the mechanics of the blood aqueous barrier can be representative to the blood brain barrier, the same having passed through the blood brain barrier) according to certain embodiments of the present invention.

Figure 13 is a block diagram of a method for monitoring or treating a patient by administering a therapeutic agent during a chemotherapy session patient according to embodiments of the present invention.

25 **Figure 14** is a block diagram of a method of monitoring the blood brain barrier dynamics of a subject during exposure to selected conditions according to embodiments of the present invention.

Figure 15 is a block diagram of a method for detecting an alteration of the function of the blood brain barrier according to certain embodiments of the present invention.

30 **Figure 16** is a block diagram of a method for identifying an abnormality in the blood brain barrier of a subject according to embodiments of the present invention.

Figure 17 is a flow chart of a method according to one embodiment of the present invention.

Figure 18 is a schematic illustration of an apparatus configured to illuminate and obtain the Raman spectrum from the vitreous humor of the eye according to embodiments of the invention.

35 **Figure 19** is a schematic illustration of an apparatus configured to illuminate and obtain the Raman spectrum of one or more blood vessels in the conjunctiva of the eye according to embodiments of the invention.

Figures 20A-20C illustrate optical power density calculations performed using a canonical model of the adult eye of a human. **Figure 20A** is a model of the human eye. **Figure 20B** is a schematic of a portion of the eye illustrating the angles and equations associated with power density. **Figure 20C** is a graph of the power for exposed retinal area and the power density (assuming a 30mW input) are shown as a function of the angle of incidence.

40 **Figures 21A-21C** are graphs of the Raman spectrum of artificial and actual aqueous humor samples. **Figure 21A** corresponds to an ensemble spectrum of artificial aqueous humor samples in a model (artificial or test) anterior chamber. **Figure 21B** corresponds to an *in vitro* ensemble spectrum of actual aqueous humor in a model anterior chamber. **Figure 21C** corresponds to *in vivo* ensemble spectrum of aqueous humor.

45 **Figure 22A** is a drawing of the chemical structure of a chemotherapeutic agent known as FENRETINIDE. **Figure 22B** illustrates the agent in ethanol in different concentrations (shown in decreasing concentration from left to right) of 100 μ M (micro-molars), 10 μ M, 1 μ M, and 0.1 μ M.

Figure 23 is a graph of the absorption spectrum (absorption versus wavelength) of a solution of 10 μ M of FENRETINIDE illustrating the peak at 365nm.

50 **Figure 24** is graph of the Raman spectrum of intensity versus wavelength shift of a non-resonant Raman spectroscopy (using an excitation wavelength of 785 nm) of FENRETINIDE (dissolved in ethanol). There are two distinct lines, one for ethanol and one for FENRETINIDE that shows key peaks of FENRETINIDE as distinct from those of ethanol.

Figure 25A is a graph of the absorption spectrum (absorption versus wavelength) of a solution of 10mM of FENRETINIDE. **Figure 25A** is inset within **Figure 25B**.

55 **Figure 25B** is a graph of pre-resonant spectra (excitation wavelengths above the resonant wavelength) of a 10mM FENRETINIDE corresponding to the substance with the absorption spectrum shown in **Figure 25A**.

Figure 26 is a graph of intensity versus wavelength shift of the resonant Raman (RR) spectra of FENRETINIDE at three different concentrations (mixed in ETOH), 10.0 μ M, 1.0 μ M, and 0.1 μ M. The peaks from the solvent (S), ethanol,

are diminished at the higher FENRETINIDE concentrations due to the absorption of excitation light by the FENRETINIDE itself.

Figure 27 is a drawing of the chemical conjugated structure of AMPHOTERICIN, an exemplary antifungal agent.

Figure 28 is a graph of the absorption spectrum of AMPHOTERICIN B.

Figure 29 is a graph of the RR spectrum of (generated at an excitation wavelength of 406.7nm) of Amphotericin at three different concentrations (mixed in MeOH), 5.0 $\mu\text{g/ml}$, 0.5 $\mu\text{g/ml}$, and 0.05 $\mu\text{g/ml}$.

Figure 30 is a schematic of a compact, inexpensive detector suitable for detecting the presence of a particular substance.

Detailed Description of Embodiments of the Invention

[0053] The present invention will now be described more fully hereinafter with reference to the accompanying figures, in which embodiments of the invention are shown. This invention may, however, be embodied in many different forms and should not be construed as limited to the embodiments set forth herein. Like numbers refer to like elements throughout. In the figures, layers, components, or features may be exaggerated for clarity.

[0054] The term "glucose" as used herein preferably refers to D-glucose. The term "subject" as used herein refers to both human subjects and animal subjects having circulatory systems including domestic large and small animals such as dogs, cats, rabbits, horses, cows, pigs, and the like. Animal subjects may be used in the present invention for veterinary purposes. The present invention may be particularly suitable for human subjects. The optical analysis may be performed on selected regions of the eye, including the blood vessels in the conjunctiva (*i.e.*, one or more of the conjunctiva blood vessels located on the surface of the eye), the vitreous humor (the "VH") or the aqueous humor (the "AH").

[0055] The present disclosure relates to the determination of (a) the blood levels or (b) the brain fluid level, meaning the intracranial or cerebral spinal fluid levels, of selected substances or analytes of interest such as may be predicted by the presence and/or concentration of the substance or analyte in the selected region of the eye of a subject (typically, the AH or the conjunctiva vessel(s)). However, the determination of (a) the blood levels or (b) the brain fluid level of selected substances or analytes of interest is not within the scope of the invention as claimed.

[0056] In certain embodiments, the present invention recognizes that the mechanics of the blood aqueous barrier and the blood brain barrier are substantially the same such that, if the substance of analyte passes through the blood aqueous barrier, it can be presumed to also pass through the blood brain barrier. The correlation of the amount that passes through the blood brain barrier may be substantially equivalent to that detected in the eye or may be at a lesser or greater concentration. However, the blood concentration of other Raman-active molecules, analytes, or substances which do not typically pass through the blood brain barrier may also be determined by these techniques. Similarly, the amount or presence of the selected substance or molecule, etc., in the eye itself can be determined by these techniques (such as to treat localized in the eye or non-systemic diseases such as cancers of the eye).

[0057] As used herein, the term "analyte" is used interchangeably with "substance" to identify a selected target chemical, molecule or molecules, either in its blood-absorbed or partially absorbed, uptaken, or constituent form, or in an *ex vivo* formulation, where applicable. As such, the substance or analyte can include a chemical compound or composition, whether synthetic or natural, as well as a constituent thereof or molecule of interest. In some embodiments, the analyte or substance can be one that is emitted by the body (sometimes in an elevated amount) in response to a disease or physiologic reaction to a product or toxin and may also be a byproduct of the body's reaction to a substance. As such, as noted in the summary of the invention above, the substances which can be measured or identified according to the present invention are numerous and can include (a) natural physiologic substances, analytes or chemicals, such as glucose, amino acids, peptides, blood, or other components of or in blood, or in the eye and/or (b) foreign or synthetic or artificial substances such as medicaments, drugs, or poisons (whether legal or illegal, and whether prescription or over the counter) which may be present in the subject. For example, the present disclosure can be used to: (a) identify or assess the presence (or absence) of and/or the blood level or concentration of or (b) the movement through or alteration of the blood-brain barrier of a selected or desired substance. However, such use of the disclosure does not fall within the scope of the claimed invention. The substances include lactate, urea, benzene, ascorbate alcohol, ethanol, methanol, ethylene glycol, steroids, nicotine, or illegal narcotics such as cocaine, other opiate-based drugs, or prevalent or pervasive designer drugs, or metabolites, or household, organic, or environmental toxins and/or poisons such as herbicides, pesticides, household cleaning products, petroleum products, therapeutic agents such as chemotherapeutic agents, antifungal or other antibiotic agents or other chemicals.

[0058] In certain embodiments, the present invention may be particularly suitable for identifying the presence or amount of substances, which present in the selected region of the eye in sufficient quantities to allow Raman based detection. For example, in certain embodiments, the present invention may be able to detect a substance that is present in an amount of at least about 0.01-10 μmolar s. In other embodiments, the present invention can detect a substance that is present in at least about 1-100 or 10-100 μmolar s. The lower quantities may be more reliably detectable if the substance is a Raman active molecule with enhanced signal strength obtained by using an excitation wavelength that approaches

the substance or molecule of interests absorption spectrum or RR excitation wavelength. In some embodiments, the targeted analyte may be present in the selected or targeted region of the eye in an amount of at least about 1 milli-molar or in a physiological concentration level of about at least 0.001%. The present invention may also be able to identify the presence of, or a physiologic reaction to, substances associated with poisonous plants, insect or arachnid poison, and reptile or snake venom, in the subject.

[0059] In addition, in certain embodiments, the devices and methods of the present invention may be used (to analyze either *in vitro* or *in vivo*) to detect increased or decreased levels of physiologic analytes in the blood or to detect certain disease processes of known conditions and/or to treat conditions of the eye. For example, by identifying increased or decreased levels of certain substances in the body or the presence in the subject of certain peptides or toxins associated with a particular condition, such as those caused by system impairments or reactions associated with dehydration, allergic reactions, toxins from bacterial infections such as spinal meningitis, or elevated or decreased levels of antibodies to identify an immune system response, or even hormones evoked in response to a pregnancy.

[0060] In certain embodiments, the methods and devices of the present invention can be configured to (a) identify the presence of and (b) quantitatively determine the cerebral spinal or intracranial concentration level of one or more selected substances in the subject. Additionally, the methods and devices of the present disclosure can be configured to (a) identify the presence of and/or (b) quantitatively estimate or determine the blood concentration level of one or more selected substances in the subject, however such methods and devices do not fall within the scope of the claimed invention. The quantitative assessment can include determining how much of the selected substance is crossing the blood brain barrier (based on a correlation to the amount present in the selected region of the eye, typically the AH). In other embodiments, the methods and devices of the invention can be used to dynamically monitor changes in the operation of the blood brain barrier (which may be altered intentionally for some embodiments of the invention).

[0061] In any event, generally stated, in operation, a laser excitation light signal is focused to and transmitted into a selected region in the eye. Typically, this will be the AH, but, in some embodiments, can also include either the blood vessel(s) in the conjunctiva or the vitreous humor. Illumination of the blood vessel(s) in the conjunctiva of the eye will not require as great a penetration depth as either the AH or the vitreous humor, while the vitreous humor will require the excitation light pulse to have an increased penetration depth over that of the AH and the conjunctiva to reach the vitreous humor in the eye.

[0062] In any event, after the selected region of the eye is illuminated, a corresponding Raman spectroscopic signal is obtained. Each selected substance can generate a "signature" spectrographic signal with different signature peaks at different frequencies. Higher concentrations will yield stronger signals. The subject's spectroscopic signal can then be digitally compared to a plurality of reference signals stored in computer memory. The reference signals correspond to one or more selected substances which can be predetermined from an *in vitro* analysis of the substance as it exists in a corresponding sample. For example, for the AH measurement, a representative eye AH can be a representative target phantom such as in artificial AH's, or test vials with known concentrations of the substance in a known solvent, such as a water based or saline solution.

[0063] In certain embodiments, the actual signal of the subject can then be compared to the stored "signature" profiles or signals of Raman data corresponding to predetermined substances or analytes to identify the presence of one or a plurality of the selected substances and/or to estimate or quantitatively determine the concentration of that substance (s) in the subject. Thus, the present invention is able to assess, non-invasively, at physiologic levels (typically in the millimolar range, but the levels can also be in the micromolar range for certain substances), the presence of selected substances in the body of the subject. In other embodiments, a relative assessment (two or more measurements of the subject analyzed for differences or changes) may be performed, alone, or with the use of base or reference spectra. The relative assessment can include obtaining at least two different Raman spectrum signals of the subject, over time, and comparing any shift in peaks, and, thus, physiological changes, in the subject at particular frequencies.

[0064] As shown in **Figure 5**, in one embodiment of the present invention, the system 5 can be described as having a light (excitation or illumination) signal generation portion 8 and a detection portion 9 (**Figure 10b**) with a laser 10 and an optical system 15x, along with a fixation target 25. The optical system 15x can be broken into an input portion 15xi (relays the light to the subject's eye) and an output portion 15xo (relays the reflected light from the subject). As shown in **Figure 10a**, the light signal generation portion 8 includes the laser 10, a signal processor 35s, the input optical system 15xi which is configured to direct the light signal into a selected region in the eye 12 of the subject (whether the conjunctiva vessel(s), the AH, or the vitreous humor). The light generation portion 8 shown also includes a fixation target 25 used to help focus the subject's eye to the light transmission path. The target 25 may be configured to extend adjacently above, below or about the perimeter of a light exit/entrance aperture, preferably proximate to the aperture to allow the eye to focus directly at or into the aperture during operation or data acquisition.

[0065] As shown in **Figure 10b**, the system 5 also includes the detection portion 9 which receives the light as it exits the selected region of the eye and detects the Raman spectrum associated therewith. The detection portion 9 can include the output optical system 15xo (which may share some of the optical components used in the input optical system 15xi), and a spectrometer 32s with a detector 32, and a signal processor 35s. The signal processor 35s is typically the same

in the transmission and detection portions **8, 9** of the system **5**.

[0066] A schematic diagram of one embodiment of the system **5** is shown in **Figure 5**. In certain embodiments, in operation, a tunable, narrow-band laser beam from laser **10** is focused into the anterior chamber **11** of the eye **12** through an objective or ocular lens **13** via lens **15** and filter **16**, beam splitter **17**, and filter **20**. In certain embodiments, a non-fluorescing objective lens with suitable numerical aperture (*e.g.* 0.2-0.5) can be used such that Raman scattering from the selected region (*i.e.*, the aqueous humor) is maximized while scattering from adjacent structures (*e.g.*, lens, cornea, and iris) is reduced. The objective lens can be configured with respect to the eye so that it has adequate working distance to permit focusing of the laser into the selected region of the eye (for the AH, the middle of the anterior chamber of the eye) without direct contact with or touching of the cornea. An integrated fixation target projected from display screen **25** can be projected via lens **26** through the same objective lens as the laser, but is focused on the retina of the eye. Focusing this fixation target on the retina simultaneously can control direction and focusing of the laser light into the desired region of the eye (such as, in some embodiments, to the anterior chamber and the AH).

[0067] As shown in **Figure 5**, in certain embodiments, the light collected by the objective lens is directed through holographic notch filters **20, 21** to remove the undesired portion of the reflected scattered light, such as the Raleigh scattered light. The Raman scattered light passes through these filters with minimal attenuation and is focused through a confocal pinhole aperture **22** by lenses **23, 24**. The pinhole and the focal point in the eye are confocal such that light from adjacent structures in the eye can be filtered at this aperture. The pinhole **22** also serves as the entrance aperture to the spectrometer. The spectrometer shown is an imaging spectrograph with a grating **30**, lens **31** and a CCD detector array **32**.

[0068] A signal processor **35s**, or controller which can be provided in a computer **35**, controls the laser **10**, the fixation target and readout display **25**, and receives data from the CCD detector **32**. The architecture of the spectrometer shown in the figures is merely one example of devices that are suitable for this application. Many types of spectrographs can be utilized including Fourier transform spectrographs, spectrographs using liquid crystal tunable filters or other tunable elements. Information can be transmitted to a remote source such as a computer, database, remote physician or the like via modem or other connection through a suitable communication link **36** via a wireless link or a computer network such including an intranet or a global computer network link such as an internet link (such as the world wide web), etc.

[0069] In certain embodiments, the CCD detector **32** in the spectrometer is of a red-shifted, back-thinned, thick epitaxial design such that its sensitivity is optimal in the 700-1100 nanometer spectral region. Other types of suitably sensitive detectors and spectral ranges may be suitable as well.

[0070] As noted above, a signal processor **32s** such as a digital signal processor in a general purpose or special purpose computer processes the output of the detector **32**. The signal processor or computer or other controller can control the laser beam frequency and the power or intensity of the laser pulse from the laser source **10**.

[0071] In some embodiments, the signal processor **32s**, computer, or controller can switch the frequency of the laser to permit subtraction of fluorescence as described previously. The signal processor or computer can also direct information to a digital display imaged onto the retina. The patient can then read the results of the analysis on this display. For certain embodiments, the results can be displayed on the exterior of the device so that a clinician or police officer (the latter being particularly directed for narcotics or blood alcohol evaluations) can easily read same. Further, the data or results can be date and time coded and digitally stored and printed as a medical or police record.

[0072] As shown in **Figure 6**, fibers **40, 41** may be used to deliver the laser beam and collect the Raman scattered light. In certain embodiments, the confocal aperture is a circular aperture **42** placed on the end of a multimode fiber. As with the pinhole aperture shown in **Figure 5**, the end of the fiber can be placed so that it is confocal with the objective lens' focal point in the anterior chamber of the eye. A single mode fiber can be used to direct the laser beam into the anterior chamber of the eye. This single mode fiber can help facilitate a diffraction limited spot size at the focal point of the objective.

[0073] A fiber delivery and collection system like that depicted in **Figure 6** can be connected to alternative detection systems, one of which is shown in **Figures 7a-b**. This alternative detection system can allow for subtraction of the fluorescence spectrum as well as selected sampling of the frequencies most important for calculation of glucose concentration. Such an alternative detection system may decrease the size and cost of the instrument. The system depicted in **Figure 7** uses one or more fixed frequency or tunable lasers to illuminate the aqueous humor of the eye using the optical delivery system shown in **Figure 6**.

[0074] **Figure 7a** illustrates that each spectral feature **50a, 50b, 50c** of the Raman scattered light is related to the excitation wavelength by a fixed offset, usually expressed in wavenumbers. Changing the excitation wavelength causes the Raman spectra to shift in wavelength, as depicted by the different feature or portion of the signal, captured in detector range window Δ_λ **51** (a relatively narrow band of the signal such as about 10nm) based on Raman spectra **52** for excitation frequency $L_{\lambda 1}$ as compared to Raman spectra **53** for excitation frequency $L_{\lambda 2}$.

[0075] An apparatus that takes advantage of the foregoing is schematically illustrated in **Figure 7b**. Like components to **Figures 5** and **6** are assigned like numbers. Laser drivers and/or tuning electronics **60** are operatively associated with a tunable laser or a plurality of fixed wavelength lasers **61, 62, 63**. A series of one or more bandpass filter/detector

elements **65, 66, 67** operatively associated with amplifiers and an analog to digital converter 68 is used to sample the spectrum of the collected light. The center wavelength and bandwidth of each filter may be chosen to correspond with a different Raman spectral peak of aqueous humor important for quantification of the selected substance (such as alcohol, an illegal narcotic or banned substance, a poison, or glucose). If this laser is tunable over about a nanometer or so, subtraction of the fluorescent components of the acquired spectrum may be possible as discussed earlier. Using a laser with a wider tuning range can allow the Raman shifted spectra to be scanned or slid across a smaller number of bandpass filter/detectors. Since semiconductor lasers with extremely wide tuning ranges are not commercially readily available, one may instead use a set of narrowly tunable lasers each with a different center wavelength as the laser means in conjunction with a series of bandpass filter/detectors for this purpose. Other suitable light sources can also be used.

[0076] Advantageously, the systems described herein may be configured so that optical components need not and do not contact the cornea of the eye during use, which many patients find objectionable (*e.g.*, by providing a suitable monocular eye cup for contacting the orbit around the eye).

[0077] The apparatus of the invention can be implemented as a spectrometer base unit attached by a fiberoptic cable to an ocular probe, or as a single integrated unit including foreoptics, spectrometer, detector, computer and display. The apparatus can be configured as a relatively lightweight and portable device. In some embodiments, the optics and laser source can all be configured to be held in a housing which can be mounted on the user as a headset, or on a portable platform device similar to vision screening or vision correction devices used during vision exams.

[0078] As noted above, a visual fixation target such as a mirror, LED, or display such as an active liquid crystal matrix display or the like can be built into the optical apparatus such that it is held in the housing in visual communication with the patient or user during operation to facilitate focusing of the excitation light into the anterior chamber and maintain stability of the eye (so that it is properly aligned with the eye of the subject). In the embodiment of **Figures 5-7**, a display screen such as a liquid crystal display is employed. As shown in **Figure 8**, a blinking fixation target in the form of an hourglass **70** can be displayed, focused on the retina, during acquisition of the spectra by the apparatus. Other fixation target forms can also be used such as text, letters, numbers, or other recognizable shapes or objects. This can help optimize the Raman signal from the aqueous humor and reduce light exposure to other structures of the eye. The fixation target can be active during the time that the laser beam is active and illuminating the subject's eye.

[0079] As shown in **Figure 9**, in some embodiments, a visible indication of the results of the test in the form of alphanumeric indicia **71** (or other suitable form, such as a graphical display) can be displayed on the same screen immediately after the acquisition step (or to a remote or externally visible screen for other embodiments). The indicia of **Figure 9** provides a readout for all of the principal Raman-active compounds of the aqueous humor, but the display can be of a targeted compound of interest (filtered from the overall spectra) corresponding to one or more, of a desired concentration level of a selected substance (such as alcohol) as desired.

[0080] In some embodiments, a motion sensor can be incorporated into the device so that the test can be aborted upon movement of the eye away from the focal point or so that a clinician is alerted as to the movement. For example, upon transmission of the laser pulse to the selected region in the eye, a sensor can be concurrently operated and used to detect movement of the retina away from the target focal point.

[0081] The excitation laser light source can be any suitable laser beam source which can generate a suitable laser beam signal at a desired frequency output. A distributed feedback laser can be used to reduce instrument size. Tunable or multiple fixed frequency lasers can be combined with bandpass filters (Puppels et al., Applied Spectroscopy 47, 1256-67 (1993)) that can generate pulses for Raman scattering at wavelengths that provide optimum information for multivariate analysis (this can reduce the cost and size of the instrument compared to the use of holographic filters or gratings).

[0082] The laser beam can be pulsed from the generator or from the optical system to provide the desired length and power or energy to the tissue in the eye. The power of the excitation laser beam pulse should be sufficiently low to avoid tissue toxicity, but sufficiently high to provide a measurable Raman signal from the aqueous humor. In general, the laser beam pulse will be at a wavelength of from 400 to 900 nanometers. In some embodiments, the laser wavelength can be a wavelength of 780 to 860 nanometers to reduce fluorescence, increase tissue penetration, and reduce phototoxicity to the eye. In other embodiments, the wavelength can be generated at a lower wavelength, such as between 400-700 nanometers, so as to increase the signal to noise ratio of the signal and/or to decrease the power level of the signal in the eye.

[0083] The duration of the pulse can be from 1 to 60 seconds in length, and typically is from about 5-20 seconds long.

[0084] The total energy of the laser pulse transmitted to the eye will typically be between 70-500 milliJoules, with instantaneous power preferably not exceeding about 30-50 milliWatts. The optical components of the apparatus used to carry out the method are preferably configured so that energy on the retina of the eye (as well as other areas susceptible to tissue toxicity, such as the lens and cornea) transmitted from the excitation laser beam pulse is not greater than 3000 mW/cm², more preferably not greater than 1000-2000 mW/cm², and even more preferably, below about 500 mW/cm².

[0085] In certain embodiments, a low energy excitation wave can be used to generate the Raman signal spectrum.

"Low energy", as used herein, means power which is on the order of about 10-400mJ or less, and typically between about 70-330 mJ. The energy exposure will depend on the power and pulse length of the excitation pulse. Longer wavelength pulses (i.e., above 700 nm) may be used, typically with energy closer to the higher end of the scale, while lower wavelengths (400-700nm) may be able to employ lower energy exposure levels. In one embodiment, a wavelength of about 633nm can be used for a pulse of about 5-10 seconds corresponding to about a 2mW power exposure level and between a 10-20 mJ energy exposure to the patient's eye for each measurement or monitoring signal obtained. In other embodiments, an optical excitation pulse may have a 785nm wavelength (or other suitable wavelength), and a pulse length of about 20 ms and a power rating of about 15mW. In another embodiment, a 5sec, 16mW pulse (having a energy exposure level of about 75mJ) can be used to obtain the *in vivo* reading of a substance such as a cancer treatment agent in the selected region of the eye (typically the AH). In particular embodiments, an excitation light having a wavelength of about 406.7 nm can be employed. The 400 nm excitation wavelength level or range may be particular suitable where a resonant Raman signal may be generated by a selected substance or molecule.

[0086] For multiple measurements, the devices may be able to be configured to focus on a different eye, alternating the eye to which the light is transmitted, to reduce the amount of exposure to any one eye.

[0087] **Figure 30** illustrates yet another embodiment of a device suitable for obtaining a Raman spectra of the eye of a subject. This device is compact, portable, and inexpensive, typically requiring only a diode laser, a filter, lens, and detector. The device can be directed to operate at a fixed excitation wavelength. As shown, the device includes a relatively inexpensive diode laser **10L**, an optically formed notch filter **21**, a detector **32**, and a beam splitter **17**. In certain embodiments, the diode laser **10L** has a fixed operational wavelength. Typically the device is configured to detect a pre-determined substance and, as such, the excitation wavelength of the laser is pre-selected to correspond to a wavelength that substantially corresponds to or approaches the RR (resonance Raman) wavelength for the predetermined substance of interest (but is above 400nm). Stated differently, a resonant or strongly pre-resonant excitation wavelength is one that; in operation, amplifies the detected Raman signal at least about 100 times over non-resonant or weakly resonant excitation wavelengths.

[0088] The above design may be particularly suitable to detect substances with a molecule of interest that is resonant or pre-resonant in the 400-1000 nm range. Some molecules, notably ethanol, are not resonant over this range, but have a peak that is relatively strong at high physiological concentrations in which it is used (such as recreational intake). The same instrument design therefore can be used to test for ethanol since the blood concentration is very high (.01-0.4%) (such as to test for drivers that may be impaired). Of course, this rationale applies to other analytes or substances that may be present in increased blood concentrations. Also, if a molecule is not going to be resonant or strongly pre-resonant, then the excitation wavelength can be chosen to avoid or reduce fluorescence - usually by employing an excitation wavelength in the range of about 600-900 nm.

[0089] Typically, the excitation wavelength is above 400nm and corresponds to a portion of the absorption spectrum. Absorption is non-negative since it is defined as the -log (% transmission). The excitation wavelength can be chosen to increase or maximize the signal to noise ratio. This can be done by making the signal-bigger, by inducing resonant Raman by selecting an excitation close to the absorption band of the molecule (but above 400nm) or by reducing the noise - *i.e.* reducing fluorescence by operating at a longer wavelength (*e.g.*, 785 nm) for substances that cannot be made Raman resonant or strongly pre-resonant in the 400-1000 nm range. The signal enhancement for resonance is sufficiently increased that one should attempt to induce it when possible. However, it is noted that, in practice, many molecules may not be resonant or strongly pre-resonant in the 400-1000 nm wavelength range.

[0090] The excitation range is chosen to be above 400 nm because wavelengths below 400 nm may induce the formation of cataracts. Silicon CCD detectors are typically used in Raman spectrometers. The long wavelength cut-off for these detectors is slightly over 1000nm. Therefore, to allow for Raman shifted light, the device can be configured to operate with an excitation wavelength range from about 400-900 nm depending on the application.

[0091] The device can be configured to provide an exposure time (expose the eye to the light) of about 10-15 seconds or less with an associated power of about 1-5mW, and typically about 1-2mW.

[0092] As shown in **Figure 30**, the device can be configured with a sine wave generator **10S** operably associated with the diode laser **10L** and the detector **32** to modulate the signal and improve SNR. A mixer **10M** can be used to integrate the sine wave generator **10S** and the detector **32** with the low pass filter **10F** as is well known to those of skill in the art.

[0093] In certain embodiments, the device can be configured so that, in operation, the sine wave generator **10S** modulates the laser light. Generally stated, the detected light is Raman scattered off the sample and is modulated in a similar fashion. The detector measures this intensity and converts it into an electrical current. The detector also picks up noise from the ambient light and other sources. The mixer **10M** multiplies this detected signal by a reference sine wave, producing a signal. The low pass filter rejects the high frequency terms and passes the low frequency term of the Raman scattered light. Thus above-described operation may be described as coherent signal detection and is a detection technique commonly exploited by lock-in amplifiers. As is known to those of skill in the art, other designs may also be used such as without modulation of the laser beam and/or post-processing module.

[0094] In certain embodiments, the device can be configured with improved signal to noise ratio of the overall instrument

by post-processing the detector **32** signal by using coherent detection, similar to methods employed by a lock-in amplifier as is well known to those of skill in the art.

[0095] **Figures 26** and **29** illustrate a RR spectrum generated at 406.7 nm excitation wavelength for two different substances of interest, the peaks having increased intensity over spectrums generated at non-resonant or weakly resonant wavelengths. **Figure 26** illustrates the RR spectrum of a chemotherapeutic agent and **Figure 29** illustrates the RR spectrum of an anti-fungal agent. However, even for non-resonance wavelengths that approach the peak absorption wavelength of the compound, the Raman signal intensity may increase sufficiently to serve as an acceptable operable excitation wavelength. The particular excitation wavelength will depend on the drug or analyte of interest and can be selected so that, in operation, it can amplify the detected intensity of the Raman spectrum signal substantially, such as by about 100 times to 1,000 or greater (even up to about 100,000 times in certain circumstances) over that of signals generated with excitation signals that depart greater than 200nm, away from the peak wavelength in the absorption spectrum. As such, in certain embodiments, the excitation wavelength may be chosen so that it is about 100nm or less above the peak absorption wavelength in the absorption spectrum.

[0096] The device can be configured to detect a single peak of interest in the RR spectrum (at a predetermined wavelength shift of interest), such as the peak at 1576/cm or 1171/cm in **Figure 26** or the peak at 1152/cm or 1554/cm in **Figure 29**. Of course, as noted above in other embodiments, the device can be configured to detect multiple peaks or at multiple wavelengths (adding notch filters or a tunable laser, and the like, as is well known to those of skill in the art).

[0097] In certain embodiments, the chemical or analyte concentration in the blood can be measured within a 90-99% accuracy level as determined by extracting the aqueous humor, putting it in a test tube and measuring the Raman spectrum. The band of interest is typically in the 200-3200 cm^{-1} band. Although the present disclosure includes the measuring of the chemical or analyte concentration in the blood, such measuring of chemical or analyte concentrations in the blood does not fall within scope of the claimed invention.

[0098] Any suitable detector **32** can be used to detect a Raman spectrum from illuminated aqueous humor. In certain embodiments, a CCD detector or CCD camera can be used to detect reflective light as they may exhibit increased sensitivity over other types of detectors. The CCD detector preferably is configured to have high quantum efficiency in the near infrared range. The high quantum efficiency may be achieved by any suitable means, such as employing a back thinned detector, but one sufficiently thick to reduce etalon effect.

[0099] The devices of the invention can be operatively associated with a patient's medical equipment such as an insulin pump (for D-glucose) or to a dialysis machine (for urea) by wireless or wired electrical or fiber optic lines, radio frequency transmitters and receivers or the like to provide information on the appropriate analyte that can then be used to control that equipment. For example, the reading can be used to automatically activate or increase or decrease the output of the equipment such as the insulin pump in response to blood glucose levels, or to regulate the dialysis machine.

[0100] In telemedicine applications, the instrument of the invention can be conveniently operatively associated with a remote read-out terminal through a communication link such as a telephone, cable, computer, modem, intranet, internet connection or other communication line with any suitable relay or interconnection means (such as an electrical or fiber optic lines, radio frequency transmitters and receivers, etc.) to provide information on the blood or intracranial (blood-brain fluid) analyte to a remote physician or medical provider (e.g., through a telephone, cable, or wireless connection to a direct security (for in-home parole) or medical monitoring agency or to a selected destination on the intranet, internet, or world wide web).

[0101] **Figure 11** illustrates method steps for obtaining spectrographic readings of the selected region of the eye of a subject according to certain embodiments of the present invention. As shown, an excitation or illumination light pulse is transmitted to the selected region of the eye of the subject (**Block 100**). In certain embodiments, this can be carried out by positioning a mask-like device over the eyes of the subject (similar to that used in eye exams) so that (a) the housing of the device aligns over the eye socket(s) to seal the eye(s) from ambient lighting, (b) the excitation pulse light is efficiently directed into the eye (without scattering into the environment), (c) and the light reflected from the eye (such as the AH) can be captured, but no physical contact with the cornea of the eye itself is required. For example, a monocular eye cup (or binocular eye cups) can be used to contact the orbit around the eye and yet space the optical components from contacting the cornea. The scattered light from the illumination light pulse is then detected (**Block 120**).

[0102] During the transmission and detection steps, the eye can be focused to a desired location or target spot (**Block 105**) to help direct the excitation light out of and into the eye in a repeatable and reliable manner (to define a consistent transmission path so that the reflected light is attributed to proper and reliable illumination of the VH, AH, or conjunctiva vessel(s)). In so doing, a manual or autofocus technique can be used. For manual focusing, various methods can be used to allow the user to adjust the focus. For example, a pinwheel can be turned clockwise or counterclockwise to focus on an object or text or other visual fixation target to be displayed in the device (typically the object or text is displayed in a miniaturized display (such as an active matrix display) positioned about the opening through which the light is transmitted proximate the light transmission path). For example, LED's or active matrix displays can be used to generate text or a blinking or continuous light, which attracts the visual attention of the subject and which the subject watches or reads during the transmission and detecting steps.

[0103] Similarly, for autofocusing, the subject can look to the visual fixation target mounted in the device in visual communication with the eye. The presentation of the object can be automatically stepped through a visual protocol which can magnify or adjust the visual presentation until the subject can read or recognize the object. When this happens, the reading or recognition indicates that the focus is sufficient, and the reading can be taken (i.e., the transmission and detection of light). Autofocusing systems with corrected optic systems are well known to those of skill in the art. For example, optic systems similar to those used to assess vision and determine a suitable lens correction for a subject during vision examinations can be incorporated into the devices according to embodiments of the present invention. Although a contact lens may remain in place during the reading, it is preferred that glasses or other objects which may physically interfere with the mounting of the device over the eyes, be removed during the test.

[0104] The power or beam strength of the light pulse can be monitored so that fluctuation in the power or strength of the light beam which is transmitted to the user can be adjusted so that the current and/or heat is regulated to be substantially constant (constant current or heat) or numerically corrected for, typically in the signal processor **35s (Block 110)**. A Raman spectrum of the targeted region of the eye can then be generated based on the detected and corrected light spectroscopic signal (**Block 130**). Typically, well-known statistical correlation or normalization techniques are used to generate the Raman spectrum from the scattered light data received at the detector. See e.g., Standard Practices for Infrared, Multivariate, Quantitative Analysis, ASTM E 1655-97; Beebe et al., An Introduction to Multivariate Calibration and Analysis, Anal. Chem. 59, 1007A-10017A (1987); Draper et al., Applied Regression Analysis (2d ed., John Wiley and Sons, 1981); Malinowski et al., Factor Analysis in Chemistry (2d ed., John Wiley and Sons, 1991); Mark, H., Principles and Practice of Spectroscopic Calibration (John Wiley and Sons, 1991); Martens et al., Multivariate Calibration (John Wiley and Sons, 1989); and McClure, G., Ed., Computerized Quantitative Infrared Analysis, ASTM STP 934, ASTM (Philadelphia, 1987). The contents of these references are hereby incorporated by reference as if recited in full herein.

[0105] Thus, any number of suitable computational analysis may be used including linear (e.g., algebraic or least squares/partial least squares) or nonlinear (e.g., artificial neural networks) multivariate analysis techniques, such as, multiple linear regression (MLR), classical least-squares (CLS, K-matrix), inverse-least-squares (ILS, P-matrix), principal component regression (PCR, PCA, factor analysis), and partial least-squares in latent variables (PbS). See Schulze et al., Artificial neural network and classical least squares methods for neurotransmitter mixture analysis, Jnl. Neuroscience Methods 56(2); 155-167 (Feb. 1995); and Wang et al., Analysis of metabolites in aqueous solutions by using laser Raman spectroscopy, Applied Optics, 32(6); 925-9 (Feb. 1993). See also Brown, C.W., Classical and Inverse Least-Squares Methods in Quantitative Spectral Analysis, Spectrosc., 1; 23-37 (1986); Brown, et al., "Matrix Representations and Criteria for Selecting Analytical Wavelengths for Multicomponent Spectroscopic Analysis", Anal. Chem. 54; 1472-1479 (1982); Carey et al., Multicomponent Analysis using an Array of Piezoelectric Crystal Sensors, Anal. Chem., 59; 1529-1534 (1987); Haaland, D.M. Classical versus Inverse Least-Squares Methods in Quantitative Spectral Analyses, Spectrosc. 2; 56-57 (1987); Haaland et al. Application of New Least-squares Methods for the Quantitative Infrared Analysis of Multicomponent Samples, Appl. Spec., 36; 665-673 (1982); Haaland et al., Improved Sensitivity of Infrared Spectroscopy by the Application of Least Squares Methods, Appl. Spec. 34; 539-548 (1980); Haaland et al. Multivariate Least-Squares Methods Applied to the Quantitative Spectral Analysis of Multicomponent Samples, Appl. Spec., 39; 73-84 (1985); Kargacin et al. Ion Intensity and Image Resolution in Secondary Ion Mass Spectrometry, Anal. Chem. 58; 2300-2306 (1986); Kisner et al. Multiple Analytical Frequencies and Standards for the Least-Squares Spectrometric Analysis of Serum Lipids, Anal. Chem., 55; 1703-1707 (1983); Kisner et al., Simultaneous Determination of Triglycerides, Phospholipids, and Cholesteryl Esters by Infrared Spectrometry, Anal. Chem., 54; 1479-1485 (1982); Lam, R.B. On the Relationship of Least Squares to Cross-correlation Quantitative Spectral Analysis, Appl. Spec., 37; 567-569 (1983); Maris et al., Nonlinear Multicomponent Analysis by Infrared Spectrophotometry, Anal. Chem., 55; 1694-1703 (1983); McClure, G.L. et al. Application of Computerized Quantitative Infrared Spectroscopy to the Determination of the Principal Lipids Found in Blood Serum, Computerized Quantitative Infrared Analysis, ASTM STP 934, G.L; McClure, Ed. American Society for Testing and . Materials, Philadelphia, 13; 1-154 (1987); Otto, M. et al. Spectrophotometric Multicomponent Analysis Applied to Trace Metal Determinations, Anal. Chem., 57; 63-69 (1985); Antoon et al. Factor Analysis Applied to Fourier Transform Infrared Spectra, Appl. Spec., 33; 351-357 (1979); Are et al, On the Effect of Calibration and the Accuracy of NIR Spectroscopy with High Levels of Noise in the Reference Value, Appl. Spec. 45; 109-115 (1991); Bulmer et al. Factor Analysis as a Complement to Band Resolution Techniques. I. The Method and its Application to Self-Association of Acetic Acid, J. Phys. Chem. 77; 256-262 (1973); Culler et al. Factor Analysis Applied to a Silane Coupling Agent on E-Glass Fibber System", Appl. Spec., 38; 495-500 (1984); Dale et al., Principal Component Analysis of diffuse Near-Infrared Reflectance Data From Paper Currency, Appl. Spec., 43; 1399-1405 (1989); Gillette et al., Noise Reduction via Factor Analysis in FT-IR Spectra, Appl. Spec., 36; 535-539 (1982); Kargacin et al. Ion Intensity and Image Resolution in Secondary Ion Mass Spectrometry, Anal. Chem., 58; 2300-2306 (1986); Lindberg et al., Partial Least Squares Method for Spectrofluorimetric Analysis of Mixtures of Humic Acid and Ligninsulfonate, Anal. Chem., 55; 643-648 (1983); Lukco et al., The Use of GC AES Multielement Simulated Distillation for Petroleum Product Fingerprinting, J. Chrom. Sci. 1993, March; Malinowski et al. Factor Analysis in Chemistry, 2nd edition, John Wiley and Sons, New York, 1991; Malinowski, E.R., Theory of the Distribution of Error Eigenvalues Resulting from Principal Component Analysis with Applications to

Spectroscopic Data, J. Chemo., 1; 33-40 (1987); Malinowski, E.R., Statistical F-Tests for Abstract Factor Analysis and Target Testing, J. Chemo., 1; 49-60 (1987); Malinowski, E.R. Theory of Error in Factor Analysis, Anal. Chem., 49; 606,612 (1977); Malinowski, E.R., Determination of the Number of Factors and the Experimental Error in a Data Matrix, Anal. Chem., 49; 612-617 (1977); Naes et al., Selection of Samples for Calibration in Near-Infrared Spectroscopy. Part 1: General Principles Illustrated by Example, Appl. Spec. 43; 328-335 (1989); Rao et al., Factor Analysis and Least-Squares Curve-Fitting of Infrared Spectra: An Application to the Study of Phase Transitions in Organic Molecules, Appl. Spec., 38; 795-803 (1984); Schostack et al., Preferred Set Selection by Iterative Key Set Factor Analysis, Chemo. and Intel. Lab. Sys., 6; 21-29 (1989); Vaughan et al., Determination of Ni by ICP-MS: Correction of Oxide and Hydroxide Interferences Using Principal Components Analysis, Appl. Spec., 44; 1685-1689 (1990); Carey et al., Multicomponent Analysis using an Array of Piezoelectric Crystal Sensors, Anal. Chem., 59; 1529-1534 (1987); Donahue et al., Analysis of Deoxyribonucleotides with Principal Component and Partial Least-Squares Regression of UV Spectra after Fourier Processing, Appl. Spec., 44; 407-413 (1990); Geladi et al., Partial Least-Squares Regression: A Tutorial, Anal. Chim. Acta, 185; 1-17 (1986); Haaland et al., Partial Least-Squares Methods for Spectral Analysis 1. Relation to Other Quantitative Calibration Methods and the Extraction of Qualitative Information, Anal. Chem., 60; 1193-1202 (1988); Haaland et al., Partial Least-Squares Methods for Spectral Analysis 2. Application to Simulated and Glass Spectral Data, Anal. Chem., 60; 1202-1208 (1988); Hanna et al., A Comparison of Methods Used for the Reconstruction of GCIFT-17R Chromatograms, J. Chrom. Sci., 17; 423-427 (1979); Kelly et al., Prediction of Gasoline Octane Numbers from Near-infrared Spectral Features in the range 660-1215 nm, Anal. Chem., 61; 313-320 (1989); Lindberg et al., Partial Least-Squares Method for Spectrofluorimetric Analysis of Mixtures of Humic Acid and Ligninsulfonate, Anal. Chem., 55; 643-648 (1983); and Otto et al., Spectrophotometric Multicomponent Analysis Applied to Trace Metal Determinations, Anal. Chem., 57; 63-69 (1985).

[0106] Figure 10C illustrates that the device 5 may include a closed loop feedback system 5f for monitoring and regulating the strength or intensity of the light excitation beam output to the eye of the subject. The feedback system 5f may employ a beam splitter positioned to bleed off a portion of the beam at a location which is proximate to the aperture (the beam outlet port) and substantially continuously detect the beam power, intensity, or energy associated therewith to monitor the power of the excitation beam as it is transmitted out of the device. Other embodiments can include dynamically monitoring the current or power load of the laser 10 to adjust for temperature or other operational drift or power fluctuation during operation. The signal processor 35s can then adjust the input to the laser as needed and/or store the excitation beam data so that the Raman spectrum can be adjusted to reflect the actual beam energy or power transmitted to the user.

[0107] Figure 10D illustrates one operational embodiment of a device with power regulation according to the present invention. As shown, the laser 10 is operably associated with a power supply 10p. The laser 10 directs the light through a fiber optic cable 40 which includes or is coupled to a fiber optic splitter 40s which directs or bleeds a small portion of the light away from the primary light transmission path (and into the eye of the patient). A substantial portion of the light remains in the primary light transmission path and is directed into the Raman probe head 15probe which can, in operation, be positioned adjacent the eye 12 of the patient. The Raman spectrometer 32 can be positioned in communication with the Raman probe so as to be able to detect the light upon its return (in the return path).

[0108] As shown, the splitter 40s may split about 1% of the excitation light away from the primary beam to a detection path 115 and into a photodetector 116 (or other suitable sensor). The photodetector 116 is in electrical communication with an A/D (analog to digital) converter 118, which converts the corresponding electrical signal so that it can be digitally input into the processor 35. Thus, the voltage or current from the photodetector 116 is measured and digitized (preferably in a substantially continuous or continuous manner during operation of the device) and the information transmitted to the processor 35 (typically a computer). The computer or processor 35 can then measure the laser power and computationally determine a new adjusted current (or voltage) to adjust the laser 10 output to the desired or target output value such that it is able to be held to within about 95% of the target output strength. In certain embodiments, the output signal strength can be held substantially constant such as within at least about 98-99%. The computer output can be converted back into analog form via a D/A converter 119 which is used to regulate the voltage power supply 10p which, in turn, regulates the input to the laser 10.

[0109] The optical system 15xi may also be configured to transmit the excitation beam such that it presents a wider cone to focus to the retina in a manner which is able to cover a larger area of the selected region in the eye to thereby operate with a lower energy/area ratio (such as, for at least some AH applications, configuring the optical system such that the numerical apertures of the input optic system 15xi is substantially matched to the output optic system 15xo (or spectrometer). In certain embodiments, a numerical aperture of about 0.2-0.5 can be used. The graph in Figure 20C shows a sample power density and exposed retinal area for a numerical aperture of 0.25 and a 10X objective (Point A) and a larger numerical aperture of about a 0.4 (23.6 degrees for a 20X objective) at Point B.

[0110] Figures 20A-20C illustrate optical power density calculations performed using a canonical model of the adult eye of a human (Figure 20A). Typically, optical toxicity power limitations for the eye are established by regulatory agencies.

[0111] **Figure 20A** shows a diagram of the adult eye exposed to light through an eyepiece with a corresponding objective and numerical aperture. Marginal rays from this eyepiece are shown focusing through the cornea and into the aqueous humor within the anterior chamber. The confocal optical configuration of the instrument allows it to sample Raman scattered light in the region near the focal spot (and substantially isolated to that region). Thus, in certain embodiments, the optic design can be such that scattering from the cornea or the intraocular lens can be reduced and can be confocally blocked from the instrument's fiber-optic entrance aperture within the optical probehead (**Figure 10d, 15** probe).

[0112] **Figure 20A** also shows the nodepoint (N) originally derived by Gullstrand. Gullstrand used special instrumentation to observe Purkinje reflections from both sides of the cornea and lens to develop a simple eye model which lumped the power of the cornea and the intraocular lens into a single equivalent lens with node point (N). Based on the knowledge of the position of node point (N) relative to the retina, one can calculate sizes of objects on the retinal surface. This information can be used to compute the surface area of the retina exposed by the numerical aperture (NA) (such as NA=0.25 or NA=0.4 according to certain embodiments of the design of the device and the associated eyepiece).

[0113] In this model, rays passing through (N) can be treated as if they are unrefracted as they travel through the eye and onto the retina. One can construct rays that pass through (N) but are also collinear with the eyepieces marginal rays as shown. A pair of collinear rays entering the lens equivalent model should focus on the retina. Going through this exercise with both pairs of marginal rays of the eyepiece shows that one can treat the incident beam as a point source which emanates from (N) at an angle θ_i , the same angle as the marginal rays make with the optical axis.

[0114] As shown in **Figure 20B**, simple calculus can be employed to derive an expression for the surface area of a sphere over a solid angle delineated by θ_c , the angle of a ray from normal that extends to the margins of the surface area exposed on the sphere. The expression for surface area is given by equation 1.

$$A = 2\pi R^2 (1 - \cos \theta_c) \quad \text{Equation 1}$$

[0115] θ_i is given (calculated as \sin^{-1} of NA of the eyepiece) and not θ_c , an expression can be derived which relates these as a function of the radius of the globe and the relative position of N given by x_0 . As shown by equation 2 in **Figure 20B**, trigonometry can be used to derive this relationship. For any θ_i , equation 2 can be solved numerically for θ_c , using the Newton-Rapson method.

$$R \sin \theta_c = (R \cos \theta_c + x_0) \tan \theta_i \quad \text{Equation 2}$$

[0116] **Figure 20C** is a graph which plots exposed retinal surface area (right vertical axis) and power density assuming a 30 mW illumination (on the left vertical axis) on the retina as a function of various eyepiece designs defined by the angle of incidence " θ_i ". The line indicated at the angle of incidence just below 15 degrees (Point A) corresponds to the numerical aperture 0.25 used for obtaining certain of the experimental data shown or described herein. The angle of incidence associated with a numerical aperture of 0.4 is at about 23.6 degrees (larger exposed retina area and lower power density), shown at Point B, used to obtain the data illustrated in **Figures 21A-C**. This angle can also be expressed in terms of NA or "f"- number (the focal length divided of the fully illuminated diameter of the limiting aperture). The numerical aperture of the entire system places an upper bound on the effective numerical aperture. For example, the numerical aperture of the embodiment of the device 5 of the spectrometer used to determine certain of the described results is f/1.8 (NA=0.267). However, the fiber optic cable between the spectrometer and the probe head, limits the numerical aperture to f/2.0 (NA=0.24). Thus using an objective at a higher f number than the fiber is counterproductive since Raman scattered light at the outer angles is not captured by the fiber. Using the instrument with the same incident power but with an objective with an f number smaller than f/2 will generally result in higher power densities on the retina with no increase in Raman signal gain. This is because maximum collection efficiency is achieved at a particular by matching the f number of the eyepiece to that of the system. The present invention can provide designs which can be considered close to optimal, by configuring the system with an f number which is approximately equal to the eyepiece numerical aperture. Using 30 mW of illumination, one embodiment can provide a lens configuration which exposes about 0.58 cm² of the retina to a power density of about 51.5 mW/ cm².

[0117] **Figure 18** illustrates that the illumination target in the eye can be the vitreous humor, a substantially clear gel-like region positioned beyond the aqueous humor. The devices described herein can be configured to operate similarly to that for the AH target, *i.e.*, by transmitting the excitation beam to a deeper depth into the eye and into the VH (through the lens and/or the portion of the eye accessible when the eye is open), illuminating same and then detecting the

transmitted light returned therefrom. The energy levels are preferably as noted above for the AH. As the Raman signal from VH may exhibit increased fluorescence, signal correction (subtraction, differentiation, etc.) may be used to obtain/detect the desired signal data.

5 **[0118]** **Figure 19** illustrates that the illumination target in the eye can be one or more blood vessels located on the conjunctiva at the outer surface of the eye. Using the conjunctiva vessel(s) can allow a direct blood level measurement to be obtained as this embodiment can focus to the blood flowing in the vessel (*i.e.*, the blood itself to directly determine the targeted blood level measurement). Although the present disclosure includes the use of conjunctiva vessel(s) to allow direct blood level measurement, direct blood level measurement does not fall within the scope of the claims of the present invention. In operation, the excitation beam is focused to at least one blood vessel on the externally accessible surface of the eye to illuminate the blood flowing in the blood vessel (because the blood vessel is located on the outer surface of the eye, there is no need to illuminate through skin). The targeted blood vessel can be any of the blood vessels located on or adjacent the conjunctiva of the eye (typically these are visually apparent), such as the long ciliary arteries or veins. One suitable target location may be one of the blood vessels located outside the iris away from the pupil. The detected Raman spectrum signal can be analyzed and a direct blood level measurement of the analyte of interest obtained. In certain embodiments, at least two readings can be taken to obtain data samples at different points of time to watch the spectra change. For example, one can attempt to include data associated with the vessel at a point in time when the blood cells are absent in the illuminated region in the vessel. Further, the Raman signal can be processed (discarded or filtered) to remove the data corresponding to red blood cells to enhance the desired signal of the analyte of interest (such as glucose). In some embodiments, the beam can be altered to disregard the Raman signal of the blood portion and to pursue the Raman signal of plasma (such as by shuttering the beam to discard the blood portion or to delay upon detection of signal associated with blood).

10
15
20
25 **[0119]** In certain embodiments, the fluorescence spectrum for the aqueous humor can be subtracted from the Raman spectrum by stimulating the aqueous humor with a second excitation laser light pulse at a wavelength slightly different from that of the first pulse (*e.g.*, up to two nanometers from the first pulse), and then subtracting one spectrum from the other in a processor in accordance with conventional techniques. Such techniques are known. *See, e.g.*, Funfschilling and Williams, *Applied Spectroscopy* 30, 443 (1976); Baraga et al., *Applied Spectroscopy* 46,187 (1992); Wicksted et al., *Applied Spectroscopy* 49, 987 (1995)). In the alternative, the fluorescence spectrum can be subtracted out through the use of software or other processing techniques. Thus, the term "subtraction" as used herein is intended to include techniques such as filtering as well as taking the derivatives of the signal. While not essential, other potentially interfering spectra or signals such as Raman scattering from the lens, iris, or cornea can also be filtered or subtracted through a hardware and/or software processor: Water is typically not an issue for Raman spectroscopy, but a water spectrum can be subtracted if desired.

30
35 **[0120]** For the difference spectrum adjustment embodiments, the blood level of the selected substance (or the cerebral spinal fluid level) for the subject can be determined from the difference spectrum by correlating the difference spectrum to predetermined spectrum or data representing the concentration of a particular substance. The computational analysis can use the differential spectrum or the non-differential spectrum depending on the desired application (typically associated with the degree of fluorescence of the selected region of the eye to determine the Raman spectrum and identify the presence of any selected spectroscopic profile or "signatures" having peaks in a spatial region of the spectrum, which, in turn, allows for the identification of the presence or concentration of a selected substance in the selected region of the eye. The correlation can be based on an empirically based-model, formula, or matrix of test data garnered from an actual subject or from *in vitro* samples. The data can be correlated and the end results computed in a hardware and/or software processor. The model can be obtained through linear (*e.g.*, partial least squares) or nonlinear (*e.g.*, artificial neural networks) multivariate analysis.

40
45 **[0121]** In some embodiments, it may be important that a reference set or reference standards of known substances and concentrations be predetermined and stored for computational reference. For example, a training set of Raman spectra can be used. The training set can include samples from (or representative of) the selected region of the eye such as the aqueous humor with a broad range of concentration of the Raman scattering metabolites. In the training set, the principal Raman-scattering metabolites (or "Raman active compounds") should be provided such that they (for at least the AH this may include glucose, lactate, urea, ascorbate, and any exogenous compounds or drugs present) preferably do not vary co-linearly with one another among the samples in the training set. For direct blood measurements (*i.e.*, the conjunctiva vessels measurements), the Raman active compounds will be those typically present in the blood. The model can be produced with spectra samples obtained from one or more prior subjects, with spectra samples obtained from the subject from whom the current blood level of the analyte of interest is being determined (in which case that subject would be required to provide a blood sample for determination of the blood concentration of the analyte of interest), or from test vials or artificial AH's with known concentrations of selected metabolites and/or the substance of interest. Thus, for an AH-based measurement, a training set can be used, with vials having a plurality of constituents, those normally present in the eye (including lactate, urea, and ascorbate) and in the substance of interest.

50
55 **[0122]** In some embodiments, to provide an atypical training sample, an artificial cover (such as a contact lens) may

be intentionally positioned over the aqueous humor being used to generate a sample in a training set. This cover or lens can operate to cause the actual AH to have abnormal levels of lactic acid (a lactic acid build up) as it is inhibited from normal operation.

5 [0123] Typically, the training set uses at least 10, and more preferably 20, 25, 30 or more Raman spectra samples (and samples of the corresponding blood levels of each of the selected analytes of interest) with substantial intersample variability in the levels of the major Raman scattering metabolites (e.g., glucose, ascorbate, lactate, urea, and any drugs, analytes, or exogenous compounds present). The concentration of the analyte of interest (in either the blood or aqueous humor) preferably varies by at least a factor of 2, 5, 10 or 20 or more from the sample with the lowest concentration to the sample with the highest concentration. This may include providing concentrations of constituents less than and 10 greatly above their normal levels such as 0.5 times to 15 times the normal levels (for the AH this can include urea, ascorbate, lactate, and, can also include glucose or other substances of interest, in saline). The mixtures can be prepared such that they provide a statistically uniform distribution with no bias/co-linearity (*i.e.*, 100 different mixtures of four random substances in the test tube). It is anticipated that the calibration curve can be biased to cluster a training set biased within the normal or low range (*i.e.*, to be skewed, depending on the application).

15 [0124] The concentration ratios or correlations may require development of the model using subjects with multiple different diseases (*e.g.*, renal failure, diabetes, seizures, mitochondrial myopathies, sickle cell disease, heart failure, blood clots, etc.) and/or other parameters such as gender, age, weight, national origin, etc. For human applications, the model may even be determined with spectra samples obtained from animals, particularly primates. The sample of the selected region in the eye may be a natural sample (human or animal), or may be a man-made or surrogate aqueous humor sample created to mimic natural samples, where the blood level is calculated from *a priori* knowledge of the relationship between blood levels and aqueous humor levels for the analyte(s) of interest (for the blood level measurements). Similarly, for the cerebral spinal or intracranial fluid, the aqueous humor sample may be a natural sample (human or animal), or may be a man-made or surrogate aqueous humor sample created to mimic natural samples, where the level is calculated from *a priori* knowledge of the relationship between cerebral spinal or intracranial levels and aqueous 20 humor levels for the analyte(s) of interest.

25 [0125] For example, when the analyte of interest is glucose, the training set of samples for the empirical model can comprise at least 20, 25 or 30 aqueous humor spectra samples. The samples can include varying levels of constituents which correspond to measured blood glucose levels, where the principal Raman active compounds in the aqueous humor samples (glucose, ascorbate, lactate, urea, and preferably any exogenous compounds such as drugs) vary 30 substantially non-collinearly among the samples. The physiological levels of the blood and/or corresponding aqueous humor glucose concentration in the test samples can range from 0 or 50 mg/dL to 800 or 1,000 mg/dL, typically including at least a 100, 200, 300 or 400 mg/dL difference in concentration between the sample with the lowest concentration and the sample with the highest concentration.

35 [0126] Turning now to Figure 12, one embodiment of the invention illustrated therein is particularly suited for the non-invasive detection, identification and/or measurement of poison in the blood. A plurality of reference standard spectroscopic spectrum signals are generated (**Block 150**). The reference signals can be converted into data defining peaks and frequencies and features of interest and the standards can correspond to *in vitro* samples of a plurality of different selected substances, and in some embodiments, each presented at different concentration levels (**Block 155**). The data associated with the reference standards can be programmed into a computer or signal processor and made available 40 for subsequent use. As noted above, the reference standards can correspond to a plurality of different Raman spectrum data corresponding to a plurality of different drugs, or typical or common poisonous substances. For example, Raman signatures of the most prevalent chemicals associated with pediatric poison control calls or emergency room visits can be analyzed in various concentrations to define an associated Raman signature. These can include common over-the-counter household drugs or medicinal supplies such as the drugs identified by brand names acetaminophen, ibuprofen, 45 isopropyl alcohol, methanol, ethylene glycol and the like, or prescription drugs such as blood pressure medicines (such as HYTRIN), steroids, antibiotics, birth control pills, and the like, as well as household cleaning chemicals, pesticides, herbicides, and petroleum products.

50 [0127] An *in situ* Raman spectroscopic reading can be obtained of the subject (**Block 160**). The subject may have been exposed to an unknown poison or substance. In some embodiments, the term "unknown poison or substance" can also include an unknown quantity of a known substance. For example, a guardian acknowledges that a TYLENOL bottle was found empty next to a young child, but it is unknown how many pills may have been in the bottle. The present invention may be able to determine whether a toxic amount was consumed.

55 [0128] In any event, the presence (or absence) of at least one selected substance in the subject can be identified (**Block 170**). The amount of the identified substance in the selected region of the eye of the subject may also be determined. Based on the amount in the eye, an amount (a) in the blood and/or (b) in the cerebral spinal fluid or intracranial fluid can be established (anticipating that the amount in the AH can be correlated to either the amount in the blood or the amount in the cerebral spinal or intracranial fluid), thus allowing the presence and concentration to be indirectly established or estimated based on the detected presence and/or concentration in the selected region of the eye (such

as the AH) (**Block 180**). However, establishing the amount of the identified substance in the blood does not fall within the scope of the claims. Physiological differences among different population segments may require determination of different correlation factors for each population segment (segmented by selected parameters of interest such as by age, gender, national origin, etc.)

5 **[0129]** In one embodiment, a Raman spectra/spectrum poison control substance identification database can be generated and the *in situ* reading then compared thereto so that a screening and assessment of the identity of which poison or poisons that the subject has been exposed can be readily identified by matching the *in situ* reading to one or more of the pre-determined and digitally stored Raman spectra. The database of selected substances may be held on a central database which can be remotely located or located at regional or selected locations (via the internet, intranet, or other communication means) and the localized reading can be uplinked to the larger database for a more comprehensive screening. Alternatively, the signal processor or computer associated with the Raman excitation/detection device or system may be configured with data corresponding to the most common types of substances and if a localized scan fails to match the *in situ* reading, a more comprehensive computational screening can be performed off line or at the remote or larger database location.

10 **[0130]** As shown in **Figure 13**, another embodiment of the present invention is directed to an *in vivo* method for monitoring the administration of a targeted therapy such as a drug, chemical, gene, or other therapy, given to a subject for treatment of a condition in the brain (such as various cancers or neurologic conditions). For example, the present invention may be used during a treatment session using delivery of a cytotoxic agent to treat a cancerous tumor in the brain (or to other patients for specialized drug treatments targeted to the brain such as for treating neurological impairments in the brain). The method includes administering a dose of a selected treatment agent (typically chemotherapy) to a subject (**Block 200**). The dynamics of the blood brain barrier are deliberately or intentionally altered from the normal state (**Block 210**). The dynamics or function/operation of the blood brain barrier are monitored by non-invasively obtaining the Raman spectrum of the aqueous humor (**Block 220**). A physiologically suitable non-specific marker, selected for its normal reluctance to cross the blood brain barrier, can be administered to the subject (**Block 225**), and the monitoring step can be carried out by identifying its presence in the elected region of the eye (typically in the AH, but the vitreous humor or "VH" may also be suitable in certain embodiments). The non-specific marker can be synthetic or natural as noted (such as an antibiotic or conjugated bilirubin or other suitable analyte).

25 **[0131]** The dose of the (chemotherapeutic) agent delivered to the brain can be estimated by determining the concentration in the AH (**Block 230**). The monitoring step can optionally be repeated a plurality of times during the administering step (**Block 235**). The blood brain barrier can be returned substantially to its normal state after a sufficient quantity of (chemotherapeutic) agent has been delivered to the brain (**Block 240**). The altering step can be carried out by administering a chemical which can be flushed from the system or the dosing terminated to allow the normal function to return. In some embodiments, the non-specific marker can be the therapeutic agent itself.

30 **[0132]** In one embodiment, the altering step is carried out by introducing an osmotic agent or chemical (such as a drug identified by a trade name of MANATOL) to the subject to temporarily open the blood brain barrier to allow larger molecules to pass therethrough. In another embodiment, the altering step can be carried out by increasing the intracranial pressure of the subject (such as by positioning the subject in a pressurized chamber).

35 **[0133]** Another embodiment is shown in **Figure 14**. This embodiment is directed to a method of non-invasively monitoring the operation/function of the blood brain barrier (which can include detecting any change from a normal state). The method comprises the steps of: (a) generating an excitation beam at a wavelength of from 400 to 900 nanometers (**Block 250**); (b) focusing the excitation beam of said generating step into the anterior chamber of an eye of the subject so that aqueous humor in the anterior chamber is illuminated (**Block 260**); (c) detecting, a Raman spectrum corresponding to the illuminated aqueous humor (**Block 270**); and (d) monitoring the blood brain barrier dynamics based on the detecting step (**Block 280**). The detected Raman spectrum can indicate when or if a particular drug or analyte penetrates the blood brain barrier (increases in quantity or becomes detectable) when it normally travels in the vessels and/or either does not penetrate the barrier or exists in a stable or predictable amount in the eye (such as in the AH, VH, or vessel in the eye). The method may also include the step of exposing the subject to selected conditions during the focusing and detecting steps (**Block 275**).

40 **[0134]** In certain embodiments, the monitoring step can be used to assess whether the dynamics thereof alter sufficiently to allow selected analytes, which would normally be inhibited from traveling through the blood brain barrier, to pass into the intracranial spinal fluid through the blood brain barrier. This can be useful for clinical trials or assessments of new drugs or treatment therapies. In other embodiments, the monitoring step can be carried out when a person is under or exposed to extreme conditions such as when diving, flying, or mountain climbing, or when suffering from a traumatic head or brain injury, high stress, or the like.

45 **[0135]** The method can also include the steps of comparing the Raman spectrum from the detecting step to reference spectrums corresponding to at least one selected analyte of interest, and indirectly identifying the presence of the least one analyte of interest in the subject's cerebral spinal fluid based on the detecting and comparing steps.

50 **[0136]** **Figure 15** illustrates yet another embodiment of the present invention. This method for identifying an alteration

in the blood brain barrier of a biological subject comprises the steps of: (a) non-invasively obtaining a first *in vivo* Raman spectrum of the aqueous humor of the subject (**Block 300**); (b) non-invasively obtaining a second *in vivo* Raman spectrum of the aqueous humor of the subject (**Block 310**); (c) comparing the first and second readings (**Block 320**); and (d) detecting an alteration in the blood brain barrier (or the penetration or a particular drug or analyte) by comparing the first and second Raman spectrums (**Block 330**).

[0137] In another embodiment, shown in **Figure.16**, a method for identifying an alteration in the blood brain barrier of a biological subject comprises the steps of: (a) non-invasively obtaining a first *in vivo* Raman spectrum of the AH of the subject (**Block 350**); (b) obtaining a reference spectrum of an *in vitro* sample representing the aqueous humor and comprising at least one selected analyte (**Block 360**); and (c) comparing the *in vivo* Raman spectrum to the reference spectrum to identify an abnormality in the blood brain barrier (**Block 370**). The abnormality may be indicated by detecting in the AH the presence of at least one selected analyte (typically one which is normally inhibited from passing through the blood brain barrier because of its molecular size or permeability and, as such, is not normally present in the intracranial fluid) thereby its presence in the AH also indicates its presence in the intracranial fluid of the subject.

[0138] The at least one selected analyte can be one which typically does not cross the blood brain barrier so that a determination of its presence in the sample is indicative of an abnormality or impairment or successful intentional alteration of the blood brain barrier dynamics. In one embodiment, the at least one selected analyte can be a bacteria.

[0139] **Figure 17** illustrates an additional embodiment of the present invention. In this embodiment, a reference library of the profiles of the chemical peaks (chemical peak profiles can also include the chemical valleys or line shapes) of the Raman spectra signals of a plurality of substances can be established or generated (**Block 400**). This can include providing the chemical peak profiles for each of the plurality of the substances at different concentrations. A Raman spectrum signal can be obtained *in vivo* of the AH (or VH) of the eye of a subject (**Block 410**). The chemical peak profile of the *in vivo* obtained Raman signal can be determined (**Block 420**). Next, the profile of the *in vivo* data is compared to the reference library to see if there is a statistical correlation (or best fit match) between one or more of the library profiles with the *in vivo* obtained profile (**Block 430**). If the answer is yes, then a list of one or more substances can be generated with a percent correlation of the likelihood of the match (**Block 440**). The method may also rule out potential suspects (**Block 441**). The list is likely to include one or more substances, as many will contain chemicals with overlapping peaks, but the presence or absence of other peaks can help statistically fit the data to identify the closest matches. If there is no match, or the correlation percentage is below a certain threshold (such as below 20-50%), then the test can be identified as inconclusive (**Block 450**). The method may also allow a physician to query whether a suspect drug or substance is indicated, which may for example, consider whether a particular "suspect" substance which is believed to be the ingested or consumed poison may be in the subject. In turn, the method can respond to the inquiry to exclude the substance as a suspect with an identified statistical percentage (*i.e.*, 95% confidence level that substance is not methanol) or to otherwise note the probability of this as the poison (*i.e.*, 5% probability that the substance is methanol).

[0140] As will be appreciated by one of skill in the art, the present invention may be embodied as a device, method, or system comprising a digital processing system, and/or computer program product. Accordingly, the present invention may take the form of an entirely hardware embodiment or an embodiment combining software and hardware aspects. Furthermore, the present invention may include a computer program product on a computer-usable storage medium having computer-usable program code means embodied in the medium. Any suitable computer readable medium may be utilized including hard disks, CD-ROMs, optical storage devices, or magnetic storage devices.

[0141] The computer-usable or computer-readable medium may be or include, for example, but not limited to, an electronic, magnetic, optical, electromagnetic, infrared, or semiconductor system, apparatus, device, or propagation medium. More specific examples (a non-exhaustive list) of the computer-readable medium would include the following: an electrical connection having one or more wires, a portable computer diskette, a random access memory (RAM), a read-only memory (ROM), an erasable programmable read-only memory (EPROM or Flash memory), an optical fiber, and a portable compact disc read-only memory (CD-ROM), a CD ROM, a DVD (digital video disk), or other electronic storage medium. Note that the computer-usable or computer-readable medium could even be paper or another suitable medium upon which the program is printed, as the program can be electronically captured, via, for instance, optical scanning of the paper or other medium, then compiled, interpreted or otherwise processed in a suitable manner if necessary, and then stored in a computer memory.

[0142] Computer program code for carrying out operations of the present invention may be written in an object oriented programming language such as Java®, Smalltalk or C++. However, the computer program code for carrying out operations of the present invention may also be written in conventional procedural programming languages, such as the "C" or FORTRAN programming language or even assembly language. The program code may execute entirely on the user's computer, partly on the user's computer, as a stand-alone software package, partly on the user's computer and partly on a remote computer or entirely on the remote computer. In the latter scenario, the remote computer may be connected to the user's computer through a local area network (LAN) or a wide area network (WAN), or the connection may be made to an external computer (for example, through the Internet using an Internet Service Provider).

[0143] The present invention is described herein with reference to flowchart illustrations and/or block diagrams of

methods, apparatus (systems) and computer program products according to embodiments of the invention. It will be understood that each block of the flowchart illustrations and/or block diagrams, and combinations of blocks in the flowchart illustrations and/or block diagrams, can be implemented by computer program instructions. These computer program instructions may be provided to a processor of a general purpose computer, special purpose computer, embedded processor or other programmable data processing apparatus to produce a machine, such that the instructions, which execute via the processor of the computer or other programmable data processing apparatus, create means for implementing the functions specified in the flowchart and/or block diagram block or blocks.

[0144] These computer program instructions may also be stored in a computer-readable memory that can direct a computer or other programmable data processing apparatus to function in a particular manner, such that the instructions stored in the computer-readable memory produce an article of manufacture or output a test result including instruction means which implement the function specified in the flowchart and/or block diagram block or blocks.

[0145] The computer program instructions may also be loaded onto a computer or other programmable data processing apparatus to cause a series of operational steps to be performed on the computer or other programmable apparatus to produce a computer implemented process such that the instructions which execute on the computer or other programmable apparatus provide steps for implementing the functions specified in the flowchart and/or block diagram block or blocks.

[0146] As is seen in **Figures 10a, b, c, Figures 5 and 6**, the system **5** includes a signal processor or controller **32s**. The signal processor or controller can be a general purpose microprocessor, a digital signal processor or a specific purpose processor. The signal processor can be an electronic device, a software or program-implemented device running on a general-purpose computer, or combinations of such. The present invention should not be construed as limited to the particular configurations illustrated in the figures but is intended to encompass other configurations capable of carrying out the operations and/or functions described herein.

[0147] The signal processor **32s** can be any commercially available or custom microprocessor. The computer **32** or signal processor or controller may include a data processing system with I/O data port(s) or other such devices that also communicate with the processor. The I/O data port can be used to transfer information between the data processing system or signal processor **32s** and another computer system or a network (e.g., the Internet) or to other devices controlled by the processor. These components may be conventional components such as those used in many conventional data processing systems which may be configured in accordance with the present invention to operate as described herein.

[0148] The devices or the present invention may include memory devices containing the software and data used to implement the functionality of the data processing system or signal processor **32s**. The memory can include both programmable and read-only memory. Typical programmable memory includes, but is not limited to static RAM (SRAM), dynamic RAM (DRAM), flash RAM, EEPROM or other such programmable memory devices whose contents may be modified. The read only memory may be of a type which may not be modified after its initial programming, such as ROM or PROM but may also be programmable in certain embodiments of the present invention.

[0149] The memory may contain several categories of software and data used in the data processing system or system processor: the operating system; the input/output (I/O) device drivers; and the image (and/or in the case of dual stimulus, the auditory) data. As will be appreciated by those of skill in the art, the operating system may be, any operating system suitable for use with a data processing system, such as OS/2, AIX or OS/390 from International Business Machines Corporation, Armonk, NY, WindowsCE, WindowsNT, Windows95, Windows98 or Windows2000 from Microsoft Corporation, Redmond, WA, PalmOS from Palm, Inc., MacOS from Apple Computer, UNIX or Linux, proprietary operating systems or dedicated operating systems, for example, for embedded data processing systems.

[0150] The I/O device drivers typically include software routines accessed through the operating system to communicate with devices such as the input devices, the display **25 (Figure 7)**, the I/O data port(s), and certain components of the memory. The data can be static and dynamic data used by the operating system, 110 device drivers, the detector, and other software programs that may reside in the memory.

[0151] While the present invention is described, for example, with reference to particular divisions of programs, functions and memories, the present invention should not be construed as limited to such logical divisions. Thus, the present invention should not be construed as limited thereto as it is intended to encompass any configuration capable of carrying out the operations described herein.

[0152] The present invention is explained in greater detail in the following nonlimiting Examples, in which " μ L" means microliters; "dL" means deciliters, "mW" means milliWatts, "nm" means nanometers, "Kg" means kilograms, "J" means Joules, " cm^2 " means square centimeters, and temperatures are given in degrees Centigrade.

EXAMPLE 1

Measurement of aqueous humor glucose *in vitro* with Raman Spectroscopy

5 [0153] Aqueous humor was obtained from sixteen New Zealand white rabbits within one minute of sacrifice by other investigators. These animals had experienced experimental myocardial infarction 48 hours prior to euthanasia. They were sacrificed by rapid exsanguination under ketamine and xylazine anesthesia. Aqueous humor samples were kept frozen until glucose levels could be measured and Raman spectroscopy performed. Glucose concentration was measured with a commercial glucometer (Glucometer Elite, Bayer, Elkhart, Indiana, USA) and confirmed against concentration standards. Each measurement was repeated, and the average measurement was considered actual glucose concentration.

10 [0154] Samples were placed in conical quartz cuvettes designed to hold a volume of 80 μ L and permit direct optical access to the solution by the spectrometer without traversing glass walls or coverslips.

15 [0155] Raman spectroscopy was performed with a f/1.8 holographic imaging spectrograph (Kaiser Optical Systems, Ann Arbor, Michigan, USA) attached to an Olympus BX60 microscope with 10X objective. Data were collected using a Princeton Instruments (Trenton, New Jersey, USA) camera with a 1024 x 256 CCD array (EEV, United Kingdom) cooled to -80°C with liquid nitrogen. Illumination of the sample through the microscope objective was achieved with a Ti:Sapphire laser (Spectra Physics 3900S, Mountain View, California, USA) pumped by an argon laser (Spectra Physics 2010E). Spectrographic data was integrated while the sample was illuminated at a wavelength of 785.0 nm (30 mW) for 10 seconds. This illumination was then repeated at a wavelength of 787.2 nm.

20 [0156] The integrated spectra at the two slightly different wavelengths were then subtracted from one another. This effectively eliminates the broadband fluorescence, which does not shift relative to the excitation wavelength. It leaves the Raman-shifted spectra appearing as a bipolar pattern (**Figure 1**).

25 [0157] Multivariate analysis of the spectra was accomplished using Holograms (Princeton Instruments, Trenton, NJ) and Grams (Galactic Industries, Salem; New Hampshire USA) software packages. Thirty-two aqueous humor samples (from sixteen rabbits) were evaluated using a "round robin" approach to iteratively group all but one of the samples into a training set. Hence, the system trains on all but one of the samples, estimates the glucose level in that sample, then rotates the test sample into the training set. This cycle is repeated until all samples have served as an unknown test sample.

30 [0158] A back propagation neural network (D. Rumelhart et al., Nature 323, 533 (1986)) was employed to determine if a nonlinear regression method would better predict the glucose concentration from the Raman spectra of aqueous humor. Such a model may compensate for as yet unknown interactions between analytes in aqueous humor. A two-layer back propagation neural network (NeuralWare, Inc., Pittsburgh, Pennsylvania, USA) was employed using a sigmoidal function as the nonlinear element. Factors derived from the partial least squares algorithm served as the inputs to the neural network. Raw spectral data could have been used but would have required a prohibitively large training set. As in the linear regression performed earlier, round robin training and testing was utilized. During training, the neural network's weights were adjusted to minimize the total squared error between the actual glucose concentration and the predicted glucose concentrations. Each sample was tested using a neural network trained on the remaining 31 samples.

EXAMPLE 2

Correlation of Aqueous Humor Glucose with Rising Blood Glucose

40 [0159] Nine female New Zealand white rabbits were used for this part of the study. They were anesthetized with ketamine (50 mg/kg) and xylazine (7.5 mg/kg) given as a single intramuscular injection. Xylazine blocks release of insulin from the pancreas and causes blood glucose to rise (K Chalabi et al., Ophthalmic Res. 19, 289 (1987); J. Arnbjerg et al., Ophthalmic Res. 22, 265 (1990)).

45 [0160] Blood samples were taken from the central ear arteries at various times following the injection of anesthetic once the animals were adequately anesthetized. Whole blood was immediately measured for glucose concentration with a commercial glucometer (Glucometer Elite, Bayer). In most instances two measurements were made. The average measurements are reported. If the measurements differed by more than 20%, a third measurement was made. If one measurement differed by more than 20% from the mean, it was discarded. In instances when blood glucose concentration appeared stable, occasionally only one measurement was made.

50 [0161] At various times after induction of anesthesia, samples of aqueous humor were taken. This was done by paracentesis with a 25-gauge needle through clear cornea near the limbus after administration of proparacaine eye drops. Aqueous humor glucose concentration was measured with the glucometer in a manner similar to the blood.

55 [0162] In rabbits, there is massive breakdown of the blood-aqueous barrier after a single paracentesis of the anterior chamber of the eye (W. Unger et al., Exp. Eye Res. 20, 255 (1975)). The aqueous humor becomes too viscous for repeat paracentesis for at least 30 minutes. Consequently, the results are reported for the first paracentesis of an eye. In a few

instances, however, a second paracentesis was made an hour later to assess how the breakdown of the blood-aqueous barrier may have affected the correlation of aqueous glucose with plasma glucose.

[0163] Average blood glucose concentrations for each animal were plotted against time after anesthetic injection. Since it was not possible to obtain blood samples simultaneous with aqueous humor samples, a best-fit second-order polynomial was calculated for each animal. This was used to calculate the blood glucose concentration at the time that the aqueous humor sample was taken. Aqueous humor glucose concentration was then plotted against the calculated simultaneous blood glucose concentration for all animals. DeltaGraph software (Delta Point, Inc., Monterey, California USA) was used for all statistical calculations.

EXAMPLE 3

Results for Measurement of Aqueous Humor Glucose *In Vitro* with Raman Spectroscopy

[0164] The raw spectra of rabbit aqueous humor show broad fluorescence peaks that obscure the underlying Raman signature (Figure 1). When the spectra from the two slightly different wavelengths are subtracted, one from the other, the Raman shifted spectra become apparent as bipolar peaks.

[0165] Actual aqueous humor glucose concentration, measured by the glucometer, ranged from 37 to 323 mg/dL in the thirty-two samples. Multivariate analysis of the raw spectra from these samples with the partial least squares algorithm revealed fair correlation ($r^2 = 0.76$) between the predicted aqueous humor glucose concentration and the actual concentration. Multivariate analysis of the subtracted spectra from these samples with the partial least squares algorithm resulted in improved correlation ($r^2 = 0.90$) between the predicted aqueous humor glucose concentration and the actual concentration. When back propagation with an artificial neural network is further applied to the data, correlation is excellent ($r^2 = 0.98$) (Figure 2).

EXAMPLE 4

Results for Correlation of Aqueous Humor Glucose with Risine Blood Glucose

[0166] The rate of rise of blood glucose after xylazine injection is highly variable from animal to animal (Figure 3). In fact, in one rabbit there was little change in the blood glucose concentration over time.

[0167] If only samples taken in the first fifteen minutes after anesthetic injection are considered, aqueous humor glucose concentration is higher than blood glucose concentration (207 ± 28 mg/dL for aqueous humor, 135 ± 27 mg/dL for blood). When calculated blood glucose rises above 200 mg/dL, simultaneous aqueous humor glucose parallels blood glucose nearly linearly [aqueous humor glucose = 1.18 (blood glucose) - 72.7 ; $r^2 = 0.88$] (Figure 4).

[0168] The number of aqueous humor samples from second paracenteses was insufficient to draw conclusions about their significance. They did not appear, however, to correlate well with aqueous humor glucose levels from initial paracenteses (Figure 4).

[0169] These data indicate that the baseline ratio of aqueous humor glucose to blood glucose in rabbits is approximately 1.5. (It may actually be higher than this as a true baseline was not obtained, and the blood glucose levels were likely elevated by the time the first samples were obtained, even in the first 15 minutes after injection.) This is much higher than in humans and higher than in previous reports on rabbits. All previous reports on rabbits, however, were prior to recognition of the hyperglycemic effect of xylazine anesthesia, yet many of them used xylazine anesthesia. In addition, most previous reports assumed that the rabbits were at steady-state euglycemia, without actually confirming that this was the case. These facts may account for some of the highly variable results in previous reports.

[0170] These data also demonstrate that aqueous humor glucose in the rabbit responds almost immediately once blood glucose exceeds 200mg/dL. The relationship of aqueous humor glucose to blood glucose is nearly linear while blood glucose is rising above 200mg/dL. Below that level, aqueous humor glucose appears stable. What happens to aqueous humor glucose when blood glucose is clamped at a hyperglycemic level, or when blood glucose concentration drops, has yet to be determined. Nonetheless, equilibration of aqueous humor glucose with blood glucose probably occurs within minutes in rabbits. If rapid equilibration of aqueous humor glucose also occurs in humans, it could serve as an excellent substrate for non-invasive glucose monitoring.

[0171] Previous investigators have found no breakdown in the blood-aqueous barrier of albino rabbits exposed to infrared radiation with energy densities up to 106 J/cm (D. Reddy, *supra*; G. Peyman et al., *Exp. Eye Res.* 42, 249 (1986); T. Kurnik et al., *Inv. Ophthalmol. Vis. Sci.* 30, 717 (1989)). Infrared energy densities as low as 44 J/cm² may be sufficient to breakdown the blood-aqueous barrier in pigmented rabbits, however. This is still substantially higher than the energy density that would need be applied with the Raman technique disclosed herein.

[0172] Figures 21A-C illustrate experimental results obtained for (a) the spectrum for an artificial *in vitro* AH in a model anterior chamber (Figure 21A); (b) the spectrum for an actual *in vitro* measured (extracted real AH) in a model

anterior chamber (**Figure 21B**); and (c) the spectrum for an actual *in vivo* AH measurements (**Figure 21C**). A 20X objective with a numerical aperture of about 0.4 was used to obtain the data. The "ensemble" spectra (of the constituents of the AH) correspond well between the three figures. As may be expected, the *in vivo* and *in vitro* intensity of the Raman spectra was less than the *in vitro* artificial sample, but the spectra peaks corresponded well between the measurements (the device able to detect the physiological levels). The *in vitro* measurements of the AH were obtained using extracted rabbit eyes placed under a contact lens.

EXAMPLE 5

Measurement of Integrity of Blood-Aqueous and Blood-Brain Barriers

[0173] The blood-brain and blood-aqueous barriers block passage of large molecules into the cerebrospinal fluid or aqueous humor. Many drugs and disease processes result in disruption of both the blood-aqueous barrier and the blood-brain barrier. In the case of such drugs or disease processes, disruption of the blood-brain barrier can be inferred from breakdown of the blood-aqueous barrier. Breakdown of the blood-aqueous barrier can be measured by measuring the protein content of the aqueous humor or by measuring the concentration of other substances (*e.g.*, drugs) within the aqueous humor. Such substances may be quantifiable by Raman spectroscopy and the protein can be calculated from the fluorescence spectrum since the fluorescence spectrum is largely generated by protein. Consequently, the devices disclosed herein for measuring glucose and other Raman scattering metabolites in the eye can be used for measuring the integrity of the blood-aqueous and blood-brain barriers.

[0174] Raman scattering molecules of different sizes that do not normally cross the blood-aqueous or blood-brain barrier could be administered to a patient intravenously. The presence of these molecules is then identified and/or quantified by Raman spectroscopy of the anterior chamber of the eye. This can be used to determine the size of molecules which pass through the blood aqueous barrier. The signature of the Raman spectroscopy signal can then digitally be compared to reference signals (without requiring the use of a difference methodology which would subtract the amount of fluorescence to reveal the Raman spectra of these substances) with the device disclosed herein would reflect the passage of natural proteins through the blood-aqueous and blood brain barriers.

[0175] Therapeutic drugs can also be measured to determine their effectiveness in crossing the blood-aqueous or blood-brain barrier or to determine if a drug has undesirable passed therethrough.

EXAMPLE 6

Monitoring the Blood Brain Barrier during a Treatment Session

[0176] A patient undergoing treatment for a cancer located in the brain or on the other side of the blood brain barrier is administered a non-specific marker which is configured such that it does not normally cross the blood brain barrier (or is reluctant to do so) and which is relatively easily detectable when in the AH by the use of Raman spectroscopic analysis. The blood brain barrier can be altered by administering an osmotic agent such as a chemical substance (such as a drug identified by the trade name "MANATOL" or a similar substance) which acts to physiologically alter the blood brain barrier. In so doing, the blood-aqueous barrier is also altered. In turn, the non-specific marker travels to the AH. An optical measurement can be obtained to confirm that the non-specific marker is indeed in the AH (in a sufficient or elevated quantity to indicate that the blood-aqueous barrier has been altered). The present invention, recognizing that the mechanics of the blood= aqueous barrier and the blood-brain barrier are similar, then presumes that the blood brain barrier has also been altered sufficiently (scale correlation factors may be applied to assure that the blood brain barrier is opened/alterd a sufficient amount).

[0177] A therapeutic drug (which may be a chemotherapy or cytotoxic drug) can then be administered (injected or otherwise delivered) to the subject. Administering the therapeutic drug after the barrier has been altered can help ensure that the therapeutic - drug is not introduced until the blood-brain barrier is altered sufficiently and can allow an elevated amount of the therapeutic drug to pass through the blood-brain barrier over a non-altered state. This can facilitate that more of the drug goes where it is targeted and can reduce the amount in the system of the subject which can often be exposed to undesirable amounts of cytotoxic drugs in conventional treatments in order to ensure that a sufficient amount actually reaches the tumor.

[0178] Thus, the present invention now allows one to intentionally break down the barrier and non-invasively confirm the alteration before delivering medicines, which do not normally readily cross the blood brain barrier, to tumors and the like positioned in the blood aqueous or blood brain barrier. Correlations of the amount of the drug administered to the subject, to the amount of the marker administered and detected in the AH, may be established to allow an estimate of the amount of the drug in the spinal fluid or in the blood. Thus, the present invention may also be able to titrate the dose so that the levels in the spinal fluid are sufficiently high but not toxic to the patient in non-targeted regions of the body.

EXAMPLE 7

Measurement of Brain Alcohol Level

5 [0179] A portable device can be used to hold the optical generation and measurement system. The device can be readily carried by police enforcement agencies and conveniently used when a suspect is evaluated for potential DUI infractions. Thus, the device can be positioned over the eye(s) of the subject and the subject can be instructed to read or identify the text or object encoded or displayed as the fixation target in the headset over the eye or eyes. When the subject verbally affirms the proper identification of the fixation target, the device can be operated to obtain a reading. 10 The device may include an auto or manual focus to correct the vision in the device and to allow the subject to focus to the target as needed. Almost instantaneously, the police officer can have quantitative results of the brain alcohol or blood alcohol level of the suspect. The amount or concentration of the alcohol determined to be in the AH (or conjunctiva vessel) can be correlated to either a blood alcohol and/or brain alcohol level. Many states presently regulate blood alcohol levels; however, it is anticipated that an impairment can be assessed also based on either or both blood or brain alcohol levels. As such, the device may generate a plurality of numbers, such as the concentration in the eye, and, the indirectly measured or correlated concentration in the blood and/or brain. If above the legal limit, which can be programmed for each state or locality, a documentary arrest record can be generated with a date and time stamp encoded onto the measurement record which can be automatically generated and electronically stored or printed.

20 [0180] In some embodiments, the Raman spectrum of the subject may include many wavelengths and the determination of the concentration or presence of alcohol may include determining the significant peaks associated with alcohol and subtracting the AH constituents from the signal. It is anticipated that the method and devices will be able to identify blood alcohol and brain alcohol levels between about 0.001-1%, and typically between 0.01-0.8% (noting that concentrations above 1% may be lethal) and that medical assistance may be indicated for certain levels.

25 EXAMPLE 8

Non-invasive *In Vivo* Identification of the presence of Illegal Narcotics

30 [0181] A portable device can be used to hold the optical generation and measurement system. The device can be readily carried by state or federal police enforcement agencies (or hospitals including medical examiners for autopsy) and conveniently used when a suspect is evaluated for potential illegal possession of drugs. In operation, the device can be configured as a headset with the display and light transmission path positioned in front of the eye(s) of the subject. The subject can be instructed to read or identify the text or object encoded or displayed in the device as the fixation target in the headset over the eye or eyes. The device may include an auto or manual focus to correct the vision in the device and to allow the subject to focus to the target as needed. When the subject verbally affirms the proper identification of the fixation target, the device can be operated to obtain a reading. Almost instantaneously, the police officer can have quantitative results of whether the suspect has inhaled, ingested, injected, or otherwise consumed an illegal narcotic. It is anticipated that concentrations in the range of between about 0.001-1% (in the AH) or higher in the conjunctiva vessel (*i.e.*, in the blood volume) may be quantified. Drugs present in small quantities (such as the picomolar range) may be 40 able to be identified (or the bodies' reaction thereto identified thereby identifying the drug) but may not be able to be reliably quantified.

[0182] It is noted that illegal narcotics may vary jurisdiction to jurisdiction and the device can be programmed according to the laws of the jurisdiction of use. Examples of illegal narcotics include opiate-based drugs such as cocaine in several forms such as crack, powder, and the like, and other drugs such as LSD, pcp, angel dust, marijuana, and others. It is anticipated that the most commonly used or street available illegal drugs or abused prescription drugs can be analyzed to predetermine the Raman signature as discussed above and these reference signature standards for these substances stored for reference to the *in situ* reading obtained on the suspect.

45 [0183] In certain embodiments, the device and method can include assessing both, the brain alcohol (or blood alcohol) level of the suspect, and the presence of an illegal narcotic with one reading. Further, the present invention can be used to develop legal limits for other non-alcohol products so as to ascertain whether an individual is impaired for improved safety on the roadways.

50 [0184] If an illegal narcotic is identified or if the alcohol level is above the legal limit, (the legal limit can be programmed for each state or locality), a documentary arrest record can be generated with a date and time stamp encoded onto the measurement record which can be automatically generated and electronically stored or printed.

55

EXAMPLE 9**Determination and/or Identification of Drug or Steroid Use**

5 [0185] In lieu of conventional urine tests, the present invention can be used to screen potential employees for drug use, or to assure employees are drug or alcohol free prior to allowing them to operate equipment (such as airplanes, trains, buses, subways, or other mass transit systems or heavy equipment and the like). This convenient and non-invasive screening may be a suitable testing system to help assure that the operators entrusted with the lives of others are not operating in an impaired state.

10 [0186] The present invention can also be used to screen athletes for banned substances prior to competitions or at periodic or audit intervals, and/or to screen parolees for violation of parole. Indeed, the readings can be obtained locally and then electronically relayed to a remote monitoring station where the results can be analyzed and proper authorities alerted of a positive test.

EXAMPLE 10**Identification of Ingested Poison(s)**

20 [0187] Similar to Example 8, an *in situ* reading can be taken on an initial evaluation of a poison suspect, either by a paramedic at a home or in route to a hospital, or by a clinician, such as at an Emergency Room, to allow a relatively fast triage assessment of whether one or more poisons are present in the body. One reading may be able to identify one or more of several different signature peaks associated with several different poisons. The poisons may be common household products such as different medications, or a pesticide/herbicide, a cleaning agent, or antifreeze. By preevaluating the Raman signature of a plurality of common substances and electronically storing the data associated therewith

25 in an electronic poison control reference library, the method and devices of the present invention can deconvolute the *in situ* obtained Raman spectrum signal to build or match a signal pattern with the Raman reference standards. Based upon the substances with signatures, which substantially match the *in situ* Raman signal, probable or possible substances can be identified (or to exclude other suspect substances). Knowing which of the chemicals or substances have the profile signature closest to the *in situ* obtained signature, the Raman signal(s) allows for the identification of which poisons

30 may be in the body. The match can be based on a computational comparison of peaks or a graphical comparison. For example, the match can be carried out by matching the peaks or line shape profile across the spectrum of interest via best-fit curves or statistical correlation methods can identify products which align or match that of the data from the subject. A list of substances with associated probability ratings can be provided to the clinician.

35 [0188] In addition, a quantitative determination of the amount of the identified substance or substances in the body may be able to be made depending on the strength of the signal (stronger signals typically indicate higher concentrations).

[0189] In one embodiment, the Raman signature of a selected metabolite can be reviewed to see if the level is carcinogenic in the subjects. For example, antifreeze (ethylene glycol) can be toxic to the liver. If it is identified that the either ethylene glycol was ingested or that the liver is emitting toxins or products, a treatment such as alcohol can be administered to offset the toxicity of the poison. Similarly, for other embodiments, the substance or drug itself may not

40 be detectable in minute quantities in the body (typically in the pico or micro molar range). However, it may be possible to detect either a constituent of the substance of interest, or a physiologic reaction to the substance, to see if it is in an elevated level in the body (due to the body breaking down or reacting to the substance).

EXAMPLE 11**Identifying a pre-determined substance using resonant or strongly pre-resonant Raman spectra and/or double bond peaks in the Raman spectrum**

45 [0190] In certain embodiments, the excitation wavelength of the substance of interest is selected so that it amplifies the detectable Raman response signal or spectra. The excitation wavelength is selected so that it lies within or proximate to the absorption spectrum of the selected substance. The RR spectra is (typically generated by a wavelength that resides within the absorption spectrum (and above 400nm). Non-resonant excitation wavelengths approaching the absorption spectrum can also be used to generate-spectra with-increased signal strength (such as signal strengths having 100-1000 or more signal intensity strength relative to excitation wavelengths that substantially depart from the

50 wavelengths associated with the RR spectra. One or more peaks of interest in the RR or Raman spectra can be monitored to identify the presence and/or quantity of the substance in the subject. In particular embodiments, a chemical shift peak associated with a double carbon bond may be monitored.

55 [0191] **Figures 22A** illustrates the chemical structure of chemotherapeutic agent known as FENRETINIDE (4-HPR),

and shows conjugated chain structure portion of the structure that permits resonance enhancement. Note that even at 10-micromolar concentration the solution has a yellow color. This can be important because, the concentration may be such that the drug can block the penetration of the excitation light and limits the Raman scattering (e.g., see **Figure 26**). Typically, at lower concentrations this is not a problem.

[0192] **Figure 23** is a graph of the absorption spectrum of E, illustrating that the absorption peaks at 365nm. Exciting the molecule at 406.7nm enhances the signal such that most of Raman shifted scattered light is not absorbed by the molecule itself, and so that undesirable excitation or exposure wavelengths are avoided (such as those below <400nm).

[0193] **Figure 24** is graph of the Raman spectrum of intensity verses wavelength shift of a non-resonant Raman spectroscopy (using an excitation wavelength of 785 nm) of FENRETINIDE (concentration 10mM, dissolved in ethanol). The spectrum shows key peaks of FENRETINIDE as distinct from those of ethanol (ETOH Peak at 881cm⁻¹). Particular peaks of interest for the FENRETINIDE one or more of which may be monitored (or the entire profile) include the peak at 1171 cm⁻¹ (corresponding to the carbon-carbon bond) in the molecular structure and the peak at 1576 cm⁻¹ (corresponding to the carbon to carbon (double bond)) in the molecular structure.

[0194] **Figure 25A** is a graph of the absorption spectrum (absorption versus wavelength) of a solution of 10mM of FENRETTNIDE. **Figure 25A** is inset within **Figure 25B** that is a graph of pre-resonant (excitation wavelengths above the resonant wavelength) spectra of a 10mM FENRETTNIDE corresponding to the substance with the absorption spectrum shown in **Figure 25A**. As shown, the intensity is normalized to the ETOH signal-(arbitrary-units), but the data need not be adjusted in this manner. Three different excitation wavelengths are shown, the signal strength increasing for a decreasing wavelength. That is, the spectra corresponding to the 514nm excitation wavelength has a larger signal intensity than the spectra corresponding to either the 633 nm or 785 nm wavelengths. As shown, the intensity values of the peaks at 1576 cm⁻¹ and 1171 cm⁻¹ are increased relative to the peaks at these positions in the Raman spectra for the 785nm or 633nm excitation wavelengths. Accordingly, **Figure 25B** demonstrates that Raman sensitivity increases as the excitation wavelength approaches the absorption spectrum of a particular molecule or substance (shown for illustrative purposes as FENRETINIDE, even at pre-resonance wavelengths). This may be useful in that devices can be configured to operate above resonance wavelengths (outside the absorption spectrum or curve) although approaching absorption spectrum values and may be particularly suitable for detection of the peaks, due to carbon double bonds that occur even for chemicals that do not resonate or for which resonant Raman spectroscopy would be difficult.

[0195] **Figure 26** is a graph of resonant Raman (RR) spectra of FENRETINIDE generated at an excitation wavelength of about 406.7nm. The peaks for E at 1171/cm and 1576/cm can be detected at concentrations as low as 0.1 micromoles. The peaks (S) from the solvent, ethanol, are diminished at the higher fenretinide concentrations due to the absorption of excitation light by the fenretinide itself.

[0196] **Figure 27** is a drawing of the chemical conjugated structure of AMPHOTERICIN B (C₄₇, H₇₃, NO₁₇), an exemplary antifungal agent This agent is a broad-spectrum antifungal agent used to treat potentially fatal fungal infections of the CNS. It has a molecular weight of 924.1.

[0197] **Figure 28** is a graph of the absorption spectrum of AMPHOTERICIN B at a concentration of 5 µg/ml.

[0198] **Figure 29** is a graph of the RR spectrum of (generated at an excitation wavelength of 406.7nm) of Amphotericin at three different concentrations (mixed in MeOH), 5.0 µg/ml, 0.5 µg/ml, and 0.05 µg/ml. Characteristic peaks of amphotericin can be detected by Resonant Raman (RR) spectroscopy (406 nm) at concentrations as low as 0.05 micrograms/ml (and potentially much lower). The therapeutic level of amphotericin is about 0.5-5.0 micrograms/ml.

[0199] The foregoing is illustrative of the present invention, and is not to be construed as limiting thereof. The invention is defined by the following claims.

Claims

1. An in-vivo non-invasive method for determining the level of an analyte of interest in a biological subject, the method comprising the steps of:

- (a) generating an excitation laser beam;
- (b) focusing the excitation laser beam into the eye of the subject so that a selected region of the eye is illuminated;
- (c) detecting a Raman spectrum from the illuminated region of the eye;
- (d) comparing the Raman spectrum from the detecting step to predetermined spectrums corresponding to different analytes of different concentrations;
- (e) identifying the presence of an analyte of interest based on the detecting and comparing steps; and
- (f) determining the amount of the analyte of interest in the cerebral spinal fluid from the Raman spectrum.

2. A method as claimed in claim 1 further comprising computing the amount of the analyte in the cerebral spinal fluid based on the concentration or amount of the analyte in a blood aqueous compartment.

EP 1 383 417 B1

3. A method as claimed in claim 1 or 2 wherein said laser beam is generated at a wavelength of from 400-900 nm.
4. A method as claimed in claim 1, 2 or 3 wherein said Raman spectrum is detected confocally.
- 5 5. A method as claimed in any one of claims 1 to 4 wherein the Raman spectrum is detected from the anterior chamber of the eye, the vitreous humor, or blood vessel in the conjunctiva of the eye.
6. A method as claimed in any preceding claim further comprising measuring the concentration of glucose and/or proteins, drugs, alcohol, or environmental or household toxins in the subject.
- 10 7. A method as claimed in any preceding claim further comprising selecting an excitation wavelength that substantially corresponds to the absorption spectrum wavelength.
8. A method as claimed in any preceding claim wherein the Raman spectrum is a first *in vivo* Raman spectrum obtained in the aqueous humor of the subject, the method further comprising:
- 15 non-invasively obtaining a second *in vivo* Raman spectrum of the aqueous humor of the subject; and identifying an alteration in the blood brain barrier by comparing the first and second Raman spectra.
9. A method as claimed in any preceding claim wherein determining the brain level of an analyte of interest for the subject from the Raman spectrum includes determining a brain alcohol level.
10. An apparatus for the non-invasive *in vivo* determination of the level of an analyte of interest in a subject, said apparatus comprising:
- 25 (a) a laser source (10, 40) for generating an excitation laser beam;
(b) an optical system (22, 23, 24) operatively associated with the laser for focusing the excitation laser beam into a selected region of the eye;
(c) a detector (32, 41) operatively associated with the optical system and configured to detect a Raman spectrum from the selected illuminated region of the eye; and
30 (d) a processor (35) with computer program code for comparing the detected Raman spectrum to the reference spectrums associated with the analyte, for identifying the presence of the analyte of interest, and for determining the amount of the analyte in the cerebral spinal fluid based on a correlation thereto from the Raman spectrum.
11. An apparatus as claimed in claim 10 wherein the correlation is based on empirical models and/or on actual measurements taken *in vivo* or *in vitro* on a representative animal or human population.
12. An apparatus as claimed in claim 10 or 11 wherein the excitation wavelength of the laser beam is at a wavelength of from 400 to 900 nm.
- 40 13. An apparatus as claimed in claim 10, 11 or 12 wherein the optical system (22, 23, 24) is a confocal optical system.
14. An apparatus as claimed in any one of claims 10 to 13 wherein the laser is configured to focus the excitation laser beam into one or more blood vessels in the conjunctiva, the vitreous humor, or the anterior chamber of the eye.
- 45 15. An apparatus as claimed in any one of claims 10 to 14 further comprising a visual display screen for presenting visual indicia to the subject that can be individually adjusted and focused to the particular visual acuity of the subject.
16. An apparatus as claimed in any one of claims 10 to 15 further comprising a visual fixation target that controls movement of the eye and ensures that focusing of the laser is directed into the anterior chamber of the eye.
- 50 17. An apparatus as claimed in any one of claims 10 to 16 wherein the processor includes empirical models of actual testing experience to determine the blood level or concentration of the analyte of interest or to identify the presence of selected substances.
- 55 18. An apparatus as claimed in any one of claims 10 to 17 wherein the Raman spectrum is a first *in vivo* Raman spectrum obtained in the aqueous humor of the subject, and the detector (32, 41) is further configured to non-invasively obtain a second *in vivo* Raman spectrum of the aqueous humor of the subject, and the processor (35) is further configured

to identify an alteration in the blood brain barrier by comparing the first and second Raman spectra.

19. An apparatus as claimed in any one of claims 10 to 18 wherein determining the brain level of an analyte of interest for the subject from the Raman spectrum includes determining a brain alcohol level.

5

Patentansprüche

- 10 1. Nicht-invasives *in vivo*-Verfahren zur Bestimmung des Gehalts eines interessierenden Analyten in einem biologischen Subjekt, wobei das Verfahren folgende Schritte umfasst:
- 15 (a) Erzeugen eines Anregungs-Laserstrahls;
 (b) Fokussieren des Anregungs-Laserstrahls in das Auge des Subjekts, so dass ein ausgewählter Bereich des Auges beleuchtet wird;
 15 (c) Erfassen eines Raman-Spektrums von dem beleuchteten Bereich des Auges;
 (d) Vergleichen des Raman-Spektrums aus dem Erfassungsschritt mit vorbestimmten Spektren, welche verschiedenen Analyten in verschiedenen Konzentrationen entsprechen;
 (e) Ermitteln des Vorhandenseins eines interessierenden Analyten auf der Grundlage des Erfassungs- und des Vergleichsschritts; und
 20 (f) Bestimmen der Menge des interessierenden Analyten im Liquor ausgehend von dem Raman-Spektrum.
2. Verfahren nach Anspruch 1, welches ferner die Berechnung der Menge des Analyten im Liquor auf der Grundlage der Konzentration oder Menge des Analyten in einer wasserhaltigen Blutkammer umfasst.
- 25 3. Verfahren nach Anspruch 1 oder 2, wobei der genannte Laserstrahl mit einer Wellenlänge von 400-900 nm erzeugt wird.
4. Verfahren nach Anspruch 1, 2 oder 3, wobei das genannte Raman-Spektrum konfokal erfasst wird.
- 30 5. Verfahren nach einem beliebigen der Ansprüche 1 bis 4, wobei das Raman-Spektrum ausgehend von der vorderen Augenkammer, dem Kammerwasser oder Blutgefäß in der Bindehaut des Auges erfasst wird.
6. Verfahren nach einem beliebigen der vorangehenden Ansprüche, welches ferner das Messen der Konzentration von Glukose und/oder Proteinen, Pharmaka, Alkohol oder Umwelt- oder Haushaltsgiften in dem Subjekt umfasst.
- 35 7. Verfahren nach einem beliebigen der vorangehenden Ansprüche, welches ferner das Auswählen einer Anregungs-Wellenlänge umfasst, welche im Wesentlichen der Wellenlänge des Absorptionsspektrums entspricht.
8. Verfahren nach einem beliebigen der vorangehenden Ansprüche, wobei das Raman-Spektrum ein erstes im Kammerwasser des Subjekts erhaltenes *in vivo*-Raman-Spektrum ist, wobei das Verfahren ferner Folgendes umfasst:
- 40 nicht-invasives Erhalten eines zweiten *in vivo*-Raman-Spektrums des Kammerwassers des Subjekts; und
 Ermitteln einer Veränderung in der Blut-Gehirn-Schranke durch Vergleichen des ersten und des zweiten Raman-Spektrums.
- 45 9. Verfahren nach einem beliebigen der vorangehenden Ansprüche, wobei das Ermitteln des Gehalts eines interessierenden Analyten im Gehirn bei dem Subjekt ausgehend von dem Raman-Spektrum das Ermitteln eines Alkoholgehalts im Gehirn beinhaltet.
- 50 10. Vorrichtung zur nicht-invasiven *in vivo*-Bestimmung des Gehalts eines interessierenden Analyten in einem Subjekt, wobei die genannte Vorrichtung Folgendes umfasst:
- (a) eine Laserquelle (10, 40) zum Erzeugen eines Anregungs-Laserstrahls,
 (b) ein optisches System (22, 23, 24), welches wirkend mit dem Laser verbunden ist, um den Anregungs-Laserstrahl in einen ausgewählten Bereich des Auges zu fokussieren;
 55 (c) einen Detektor (32, 41), welcher wirkend mit dem optischen System verbunden und konfiguriert ist, um ein Raman-Spektrum von dem ausgewählten beleuchteten Bereich des Auges zu erfassen; und
 (d) einen Prozessor (35) mit Computerprogrammcode zum Vergleichen des erfassten Raman-Spektrums mit

EP 1 383 417 B1

den zu dem Analyten gehörigen Referenzspektren, um das Vorhandensein des interessierenden Analyten zu ermitteln und um die Menge des Analyten im Liquor auf der Grundlage einer Korrelation zu diesen ausgehend von dem Raman-Spektrum zu bestimmen.

- 5 11. Vorrichtung nach Anspruch 10, wobei die Korrelation auf empirischen Modellen und/oder auf *in vivo* oder *in vitro* bei einem repräsentativen Tier- oder Menschenbestand vorgenommenen tatsächlichen Messungen basiert.
12. Vorrichtung nach Anspruch 10 oder 11, wobei die Anregungs-Wellenlänge des Laserstrahls 400 bis 900 nm beträgt.
- 10 13. Vorrichtung nach Anspruch 10, 11 oder 12, wobei das optische System (22, 23, 24) ein konfokales optisches System ist.
14. Vorrichtung nach einem beliebigen der Ansprüche 10 bis 13, wobei der Laser konfiguriert ist, um den Anregungs-Laserstrahl in ein oder mehrere Blutgefäße in der Bindehaut, dem Kammerwasser oder der vorderen Augenkammer zu fokussieren.
- 15 15. Vorrichtung nach einem beliebigen der Ansprüche 10 bis 14, welche ferner einen visuellen Anzeigebildschirm umfasst, um dem Subjekt visuelle Markierungen zu zeigen, welcher individuell auf die dem Subjekt eigene Sehschärfe eingestellt und fokussiert werden kann.
- 20 16. Vorrichtung nach einem beliebigen der Ansprüche 10 bis 15, welche ferner ein visuelles Fixierungsziel umfasst, welches die Bewegung des Auges steuert und sicherstellt, dass die Fokussierung des Lasers in die vordere Augenkammer gerichtet ist.
- 25 17. Vorrichtung nach einem beliebigen der Ansprüche 10 bis 16, wobei der Prozessor empirische Modelle tatsächlicher Versuchserfahrung beinhaltet, um den Gehalt im Blut oder die Konzentration des interessierenden Analyten zu bestimmen oder das Vorhandensein ausgewählter Substanzen zu ermitteln.
- 30 18. Vorrichtung nach einem beliebigen der Ansprüche 10 bis 17, wobei das Raman-Spektrum ein erstes im Kammerwasser des Subjekts erhaltenes *in vivo*-Raman-Spektrum ist und der Detektor (32, 41) ferner konfiguriert ist, um ein zweites *in vivo*-Raman-Spektrum des Kammerwassers des Subjekts nicht-invasiv zu erhalten, und der Prozessor (35) ferner konfiguriert ist, um durch Vergleichen des ersten und des zweiten Raman-Spektrums eine Veränderung in der Blut-Gehirn-Schranke zu ermitteln.
- 35 19. Vorrichtung nach einem beliebigen der Ansprüche 10 bis 18, wobei das Ermitteln des Gehalts im Gehirn eines interessierenden Analyten bei dem Subjekt ausgehend von dem Raman-Spektrum das Ermitteln eines Alkoholgehalts im Gehirn beinhaltet.

40 **Revendications**

1. Procédé non invasif *in vivo* pour déterminer le taux d'un analyte d'intérêt dans un sujet biologique, le procédé comprenant les étapes de :
- 45 (a) génération d'un faisceau laser d'excitation ;
(b) focalisation du faisceau laser d'excitation dans l'oeil du sujet de telle sorte qu'une région sélectionnée de l'oeil est éclairée ;
(c) détection d'un spectre Raman à partir de la région éclairée de l'oeil ;
(d) comparaison du spectre Raman provenant de l'étape de détection à des spectres prédéterminés correspondant aux différents analytes de différentes concentrations ;
- 50 (e) identification de la présence d'un analyte d'intérêt sur la base des étapes de détection et de comparaison ; et
(f) détermination de la quantité de l'analyte d'intérêt dans le liquide céphalo-rachidien à partir du spectre Raman.
2. Procédé selon la revendication 1, comprenant en outre le calcul de la quantité de l'analyte dans le liquide céphalo-rachidien sur la base de la concentration ou de la quantité de l'analyte dans un compartiment aqueux sanguin.
- 55 3. Procédé selon l'une des revendications 1 ou 2, dans lequel ledit faisceau laser est généré à une longueur d'onde de 400-900 nm.

EP 1 383 417 B1

4. Procédé selon l'une des revendications 1, 2 ou 3, dans lequel ledit spectre Raman est détecté de manière confocale.
5. Procédé selon l'une quelconque des revendications 1 à 4, dans lequel le spectre Raman est détecté à partir de la chambre antérieure de l'oeil, de l'humeur vitrée ou d'un vaisseau sanguin dans la conjonctive de l'oeil.
- 5 6. Procédé selon l'une quelconque des revendications précédentes, comprenant en outre la mesure de la concentration de glucose et/ou de protéines, de médicaments, d'alcool ou de toxines environnementales ou domestiques dans le sujet.
- 10 7. Procédé selon l'une quelconque des revendications précédentes, comprenant en outre la sélection d'une longueur d'onde d'excitation qui correspond sensiblement à la longueur d'onde de spectre d'absorption.
8. Procédé selon l'une quelconque des revendications précédentes, dans lequel le spectre Raman est un premier spectre Raman *in vivo* obtenu dans l'humeur aqueuse du sujet, le procédé comprenant en outre :
- 15 - l'obtention de manière non invasive d'un second spectre Raman *in vivo* de l'humeur aqueuse du sujet ; et
- l'identification d'une modification dans la barrière hémato-encéphalique par comparaison des premier et second spectres Raman.
- 20 9. Procédé selon l'une quelconque des revendications précédentes, dans lequel la détermination du taux d'un analyte d'intérêt dans le cerveau pour le sujet à partir du spectre Raman comprend la détermination d'un taux d'alcool dans le cerveau.
- 25 10. Appareil pour la détermination *in vivo* non invasive du taux d'un analyte d'intérêt dans un sujet, ledit appareil comprenant :
- (a) une source laser (10, 40) pour générer un faisceau laser d'excitation ;
(b) un système optique (22, 23, 24) associé de façon fonctionnelle avec le laser pour focaliser le faisceau laser d'excitation dans une région sélectionnée de l'oeil ;
30 (c) un détecteur (32, 41) associé de façon fonctionnelle avec le système optique et configuré pour détecter un spectre Raman à partir de la région éclairée sélectionnée de l'oeil ; et
(d) un processeur (35) avec un code de programme d'ordinateur pour comparer le spectre Raman détecté aux spectres de référence associés à l'analyte, pour identifier la présence de l'analyte d'intérêt, et pour déterminer la quantité de l'analyte dans le liquide céphalo-rachidien sur la base d'une corrélation à celui-ci à partir du
35 spectre Raman.
11. Appareil selon la revendication 10, dans lequel la corrélation est basée sur des modèles empiriques et/ou sur des mesures réelles prises *in vivo* ou *in vitro* sur une population animale ou humaine représentative.
- 40 12. Appareil selon l'une des revendications 10 ou 11, dans lequel la longueur d'onde d'excitation du faisceau laser est à une longueur d'onde de 400 à 900 nm.
13. Appareil selon l'une des revendications 10, 11 ou 12, dans lequel le système optique (22, 23, 24) est un système optique confocal.
- 45 14. Appareil selon l'une quelconque des revendications 10 à 13, dans lequel le laser est configuré pour focaliser le faisceau laser d'excitation dans un ou plusieurs vaisseaux sanguins dans la conjonctive, l'humeur vitrée ou la chambre antérieure de l'oeil.
- 50 15. Appareil selon l'une quelconque des revendications 10 à 14, comprenant en outre un écran d'affichage visuel pour présenter des indices visuels au sujet qui peuvent être individuellement ajustés et focalisés sur l'acuité visuelle particulière du sujet.
- 55 16. Appareil selon l'une quelconque des revendications 10 à 15, comprenant en outre une cible de fixation visuelle qui contrôle un mouvement de l'oeil et assure que la focalisation du laser est dirigée dans la chambre antérieure de l'oeil.
17. Appareil selon l'une quelconque des revendications 10 à 16, dans lequel le processeur comprend des modèles empiriques d'expérience d'essai réel pour déterminer le taux ou la concentration dans le sang de l'analyte d'intérêt

EP 1 383 417 B1

ou pour identifier la présence de substances sélectionnées.

5 **18.** Appareil selon l'une quelconque des revendications 10 à 17, dans lequel le spectre Raman est un premier spectre Raman *in vivo* obtenu dans l'humeur aqueuse du sujet, et le détecteur (32, 41) est encore configuré pour obtenir de façon non invasive un second spectre Raman *in vivo* de l'humeur aqueuse du sujet, et le processeur (35) est encore configuré pour identifier une modification dans la barrière hémato-encéphalique par comparaison des premier et second spectres Raman.

10 **19.** Appareil selon l'une quelconque des revendications 10 à 18, dans lequel la détermination du taux d'un analyte d'intérêt dans le cerveau pour le sujet à partir du spectre Raman comprend la détermination d'un taux d'alcool dans le cerveau.

15

20

25

30

35

40

45

50

55

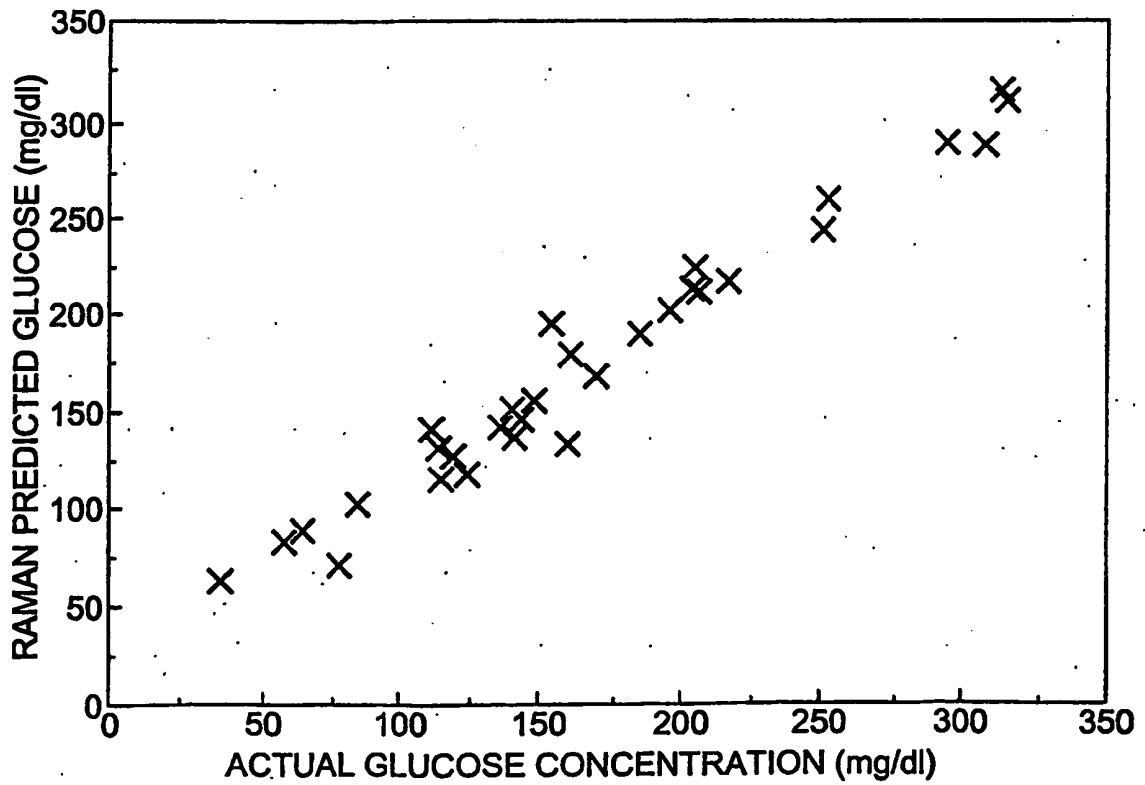
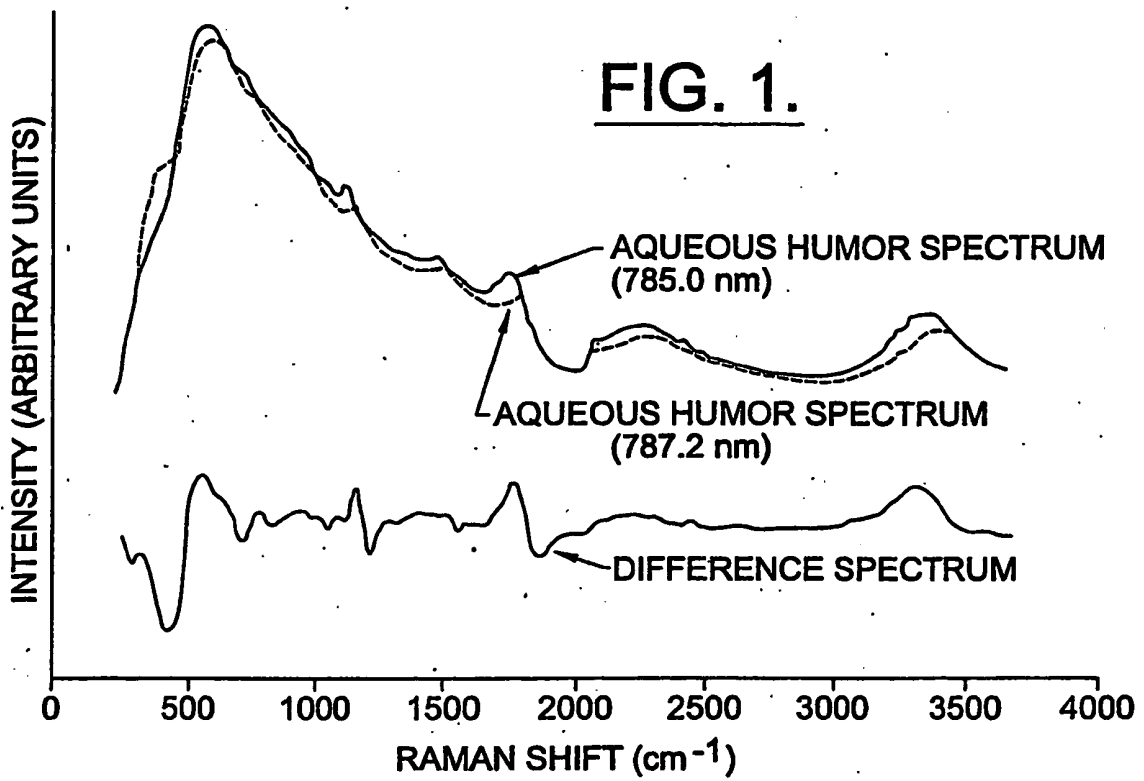

FIG. 2.

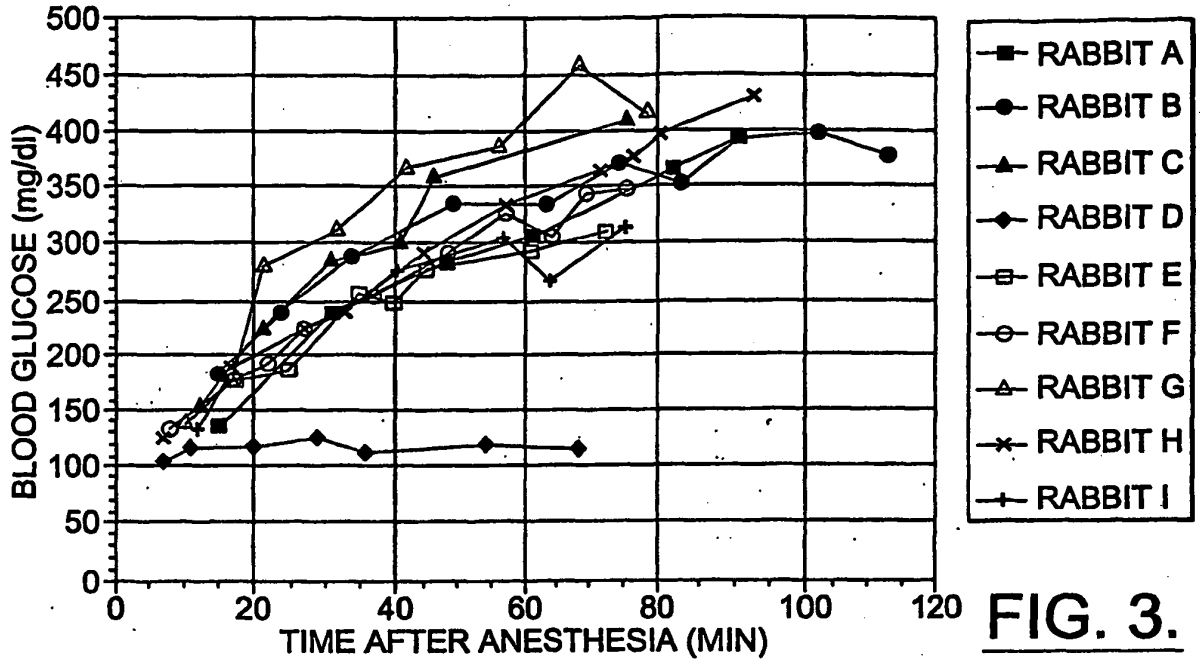

FIG. 3.

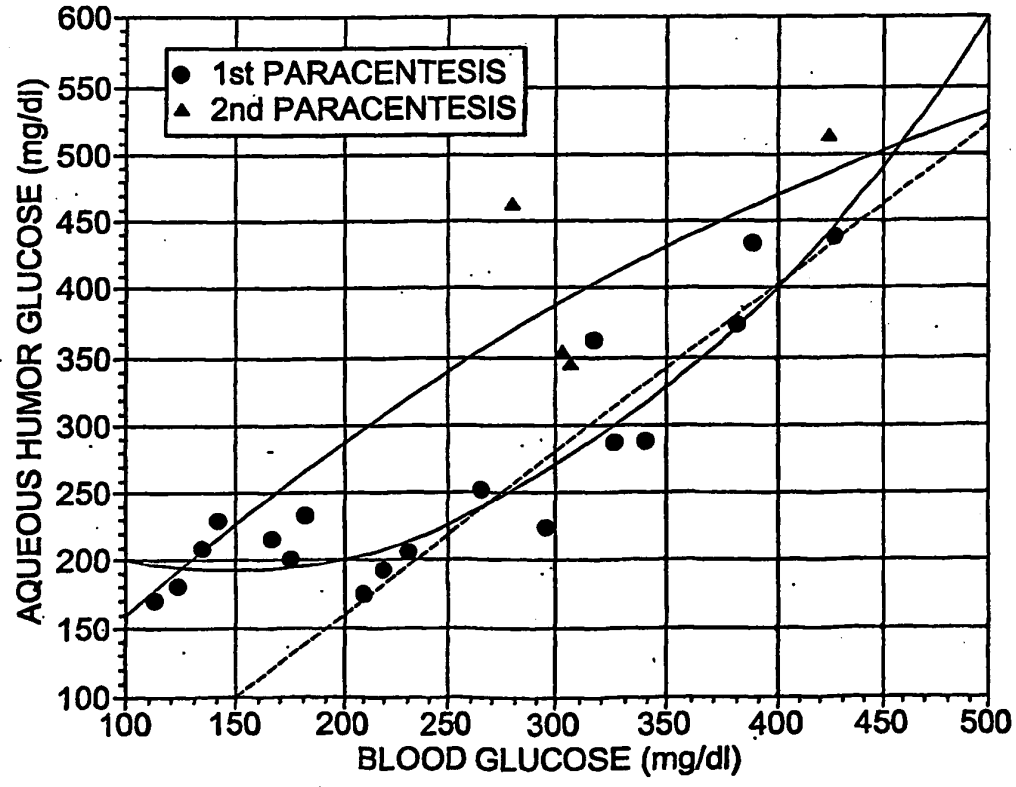

FIG. 4.

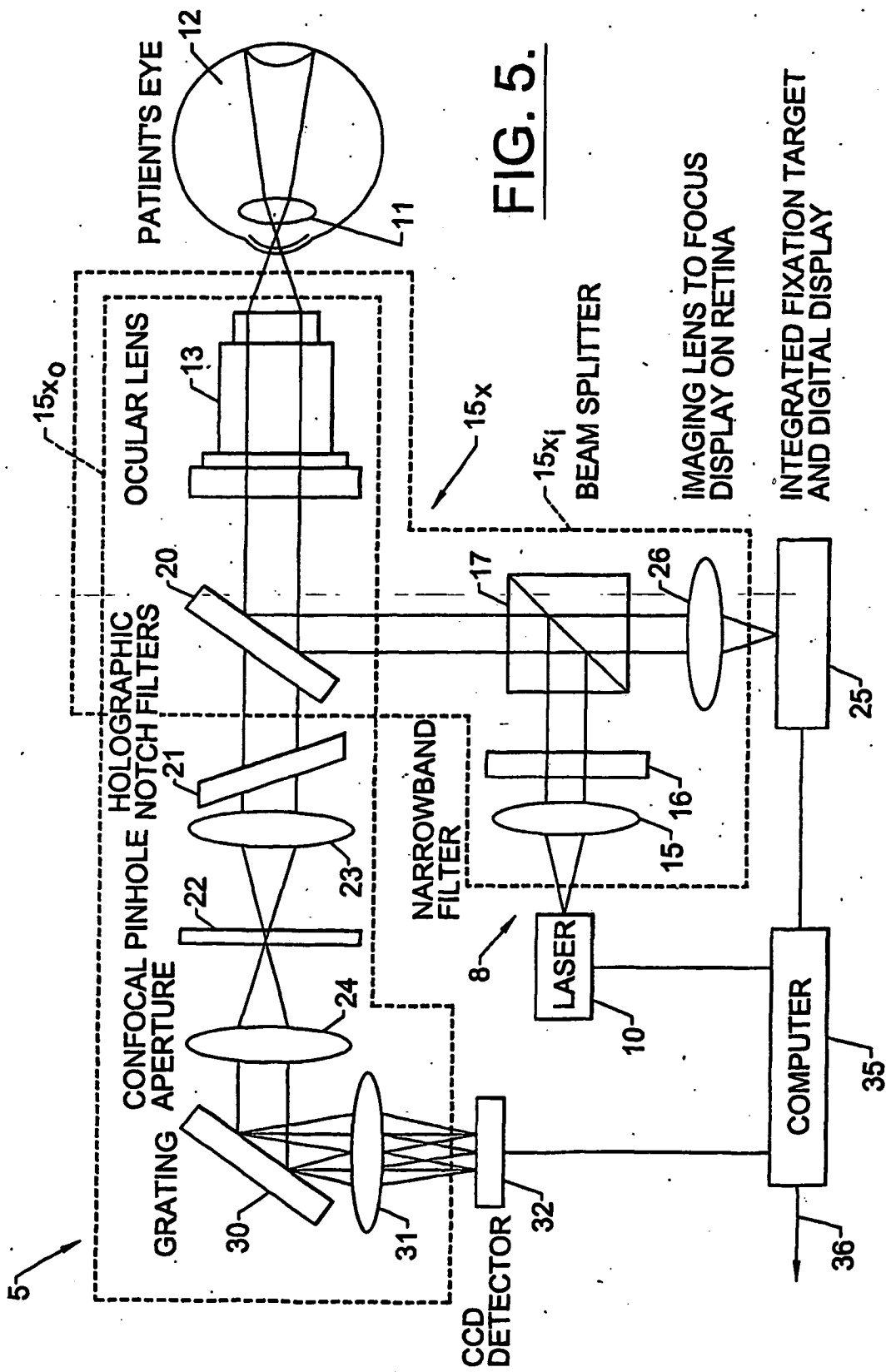

FIG. 5.

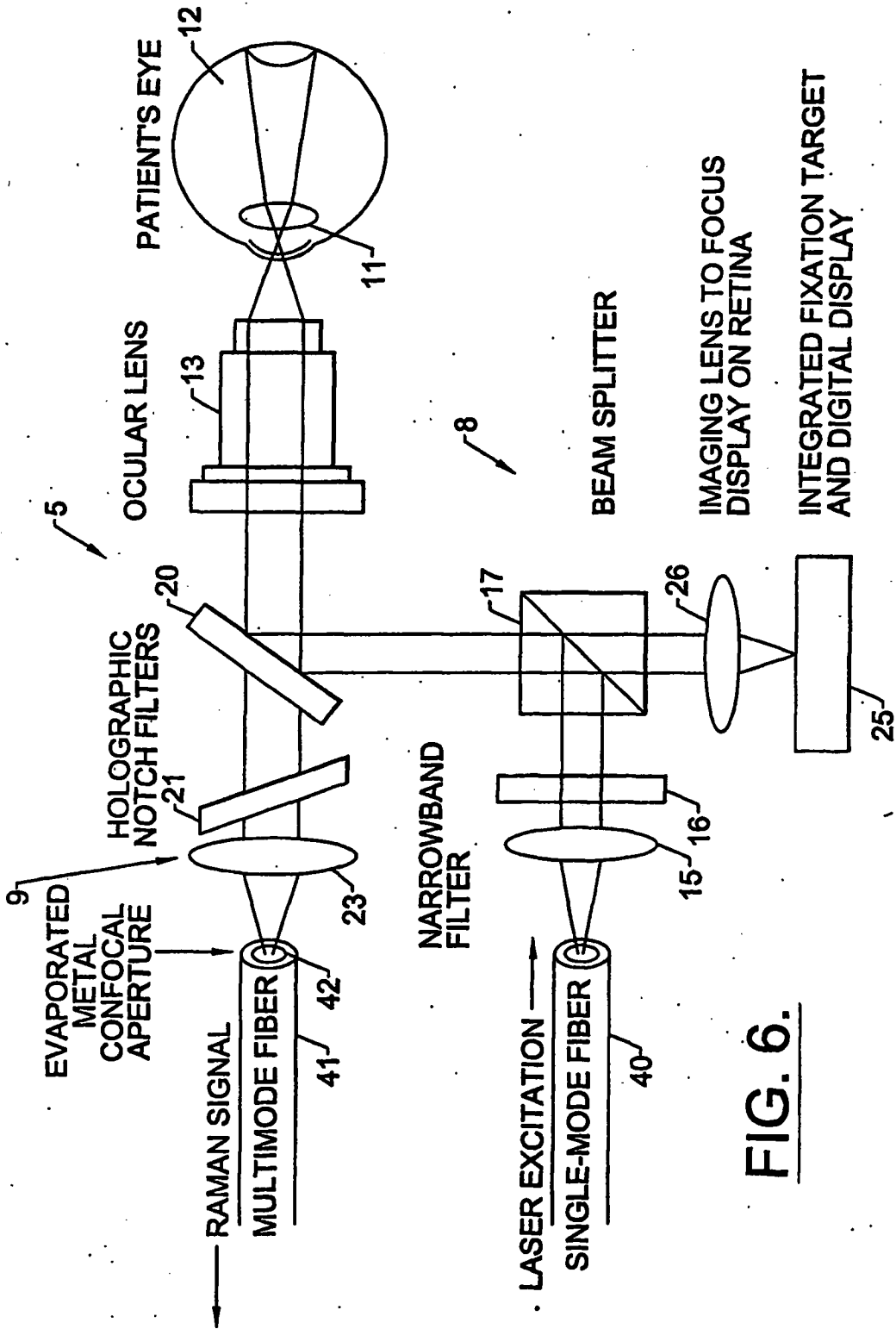

FIG. 6.

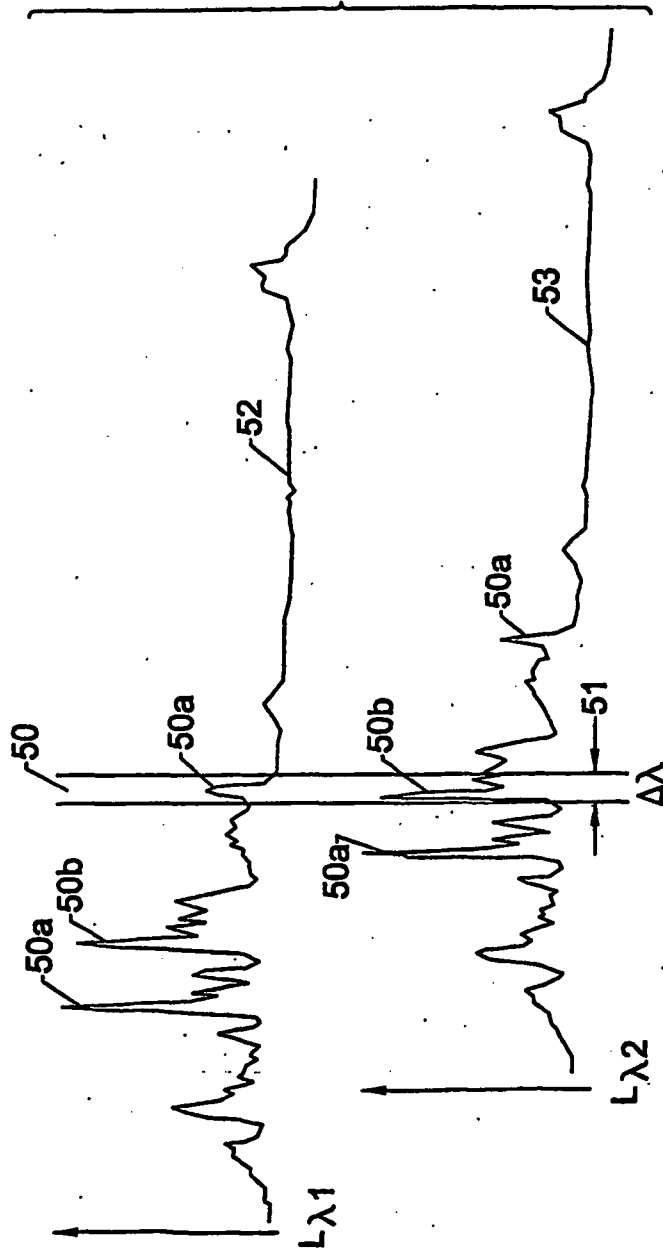

FIG. 7a.

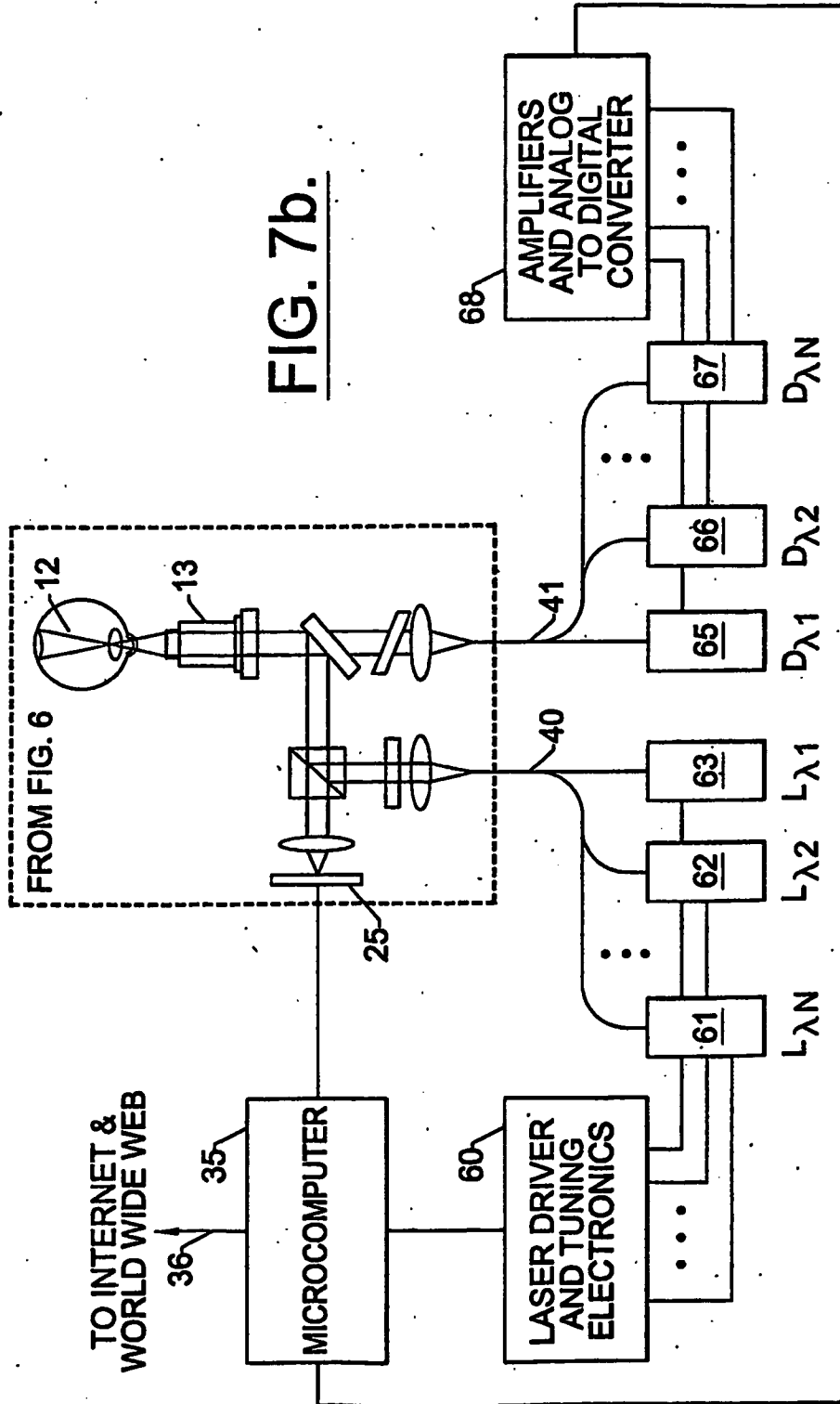

FIG. 7b.

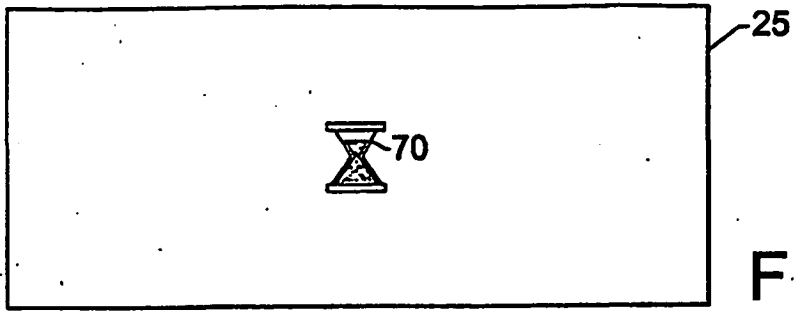

FIG. 8.

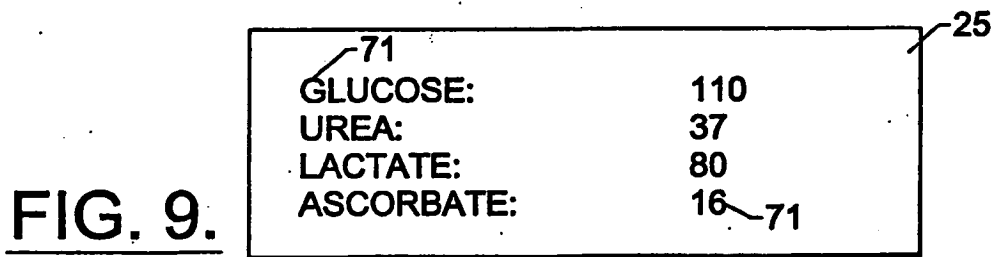

FIG. 9.

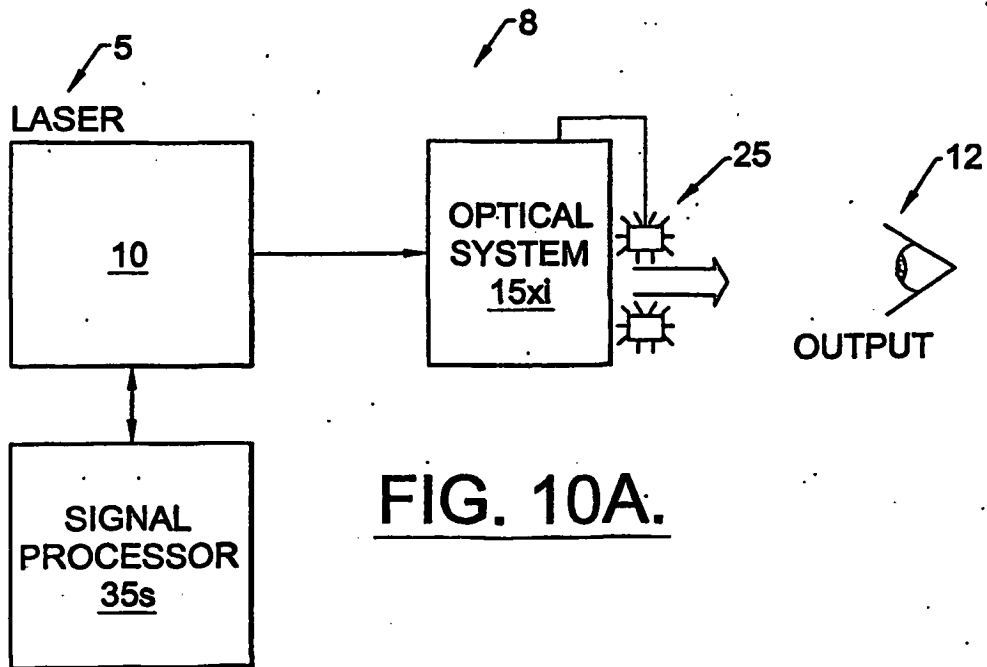

FIG. 10A.

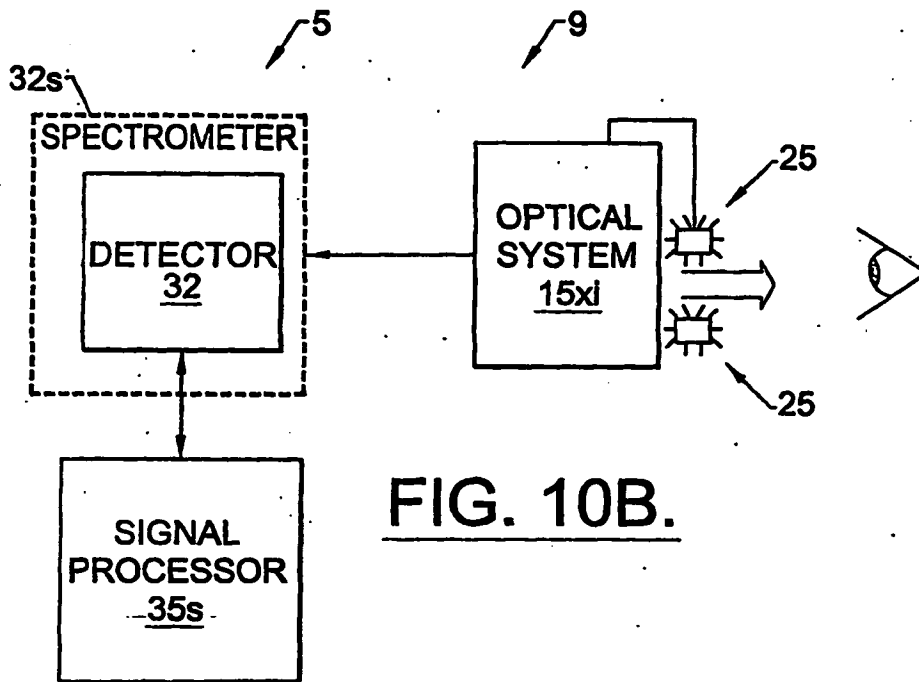

FIG. 10B.

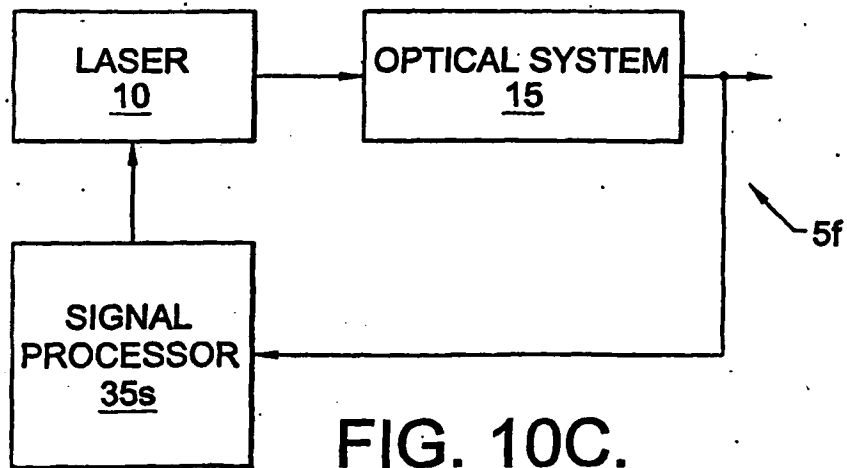
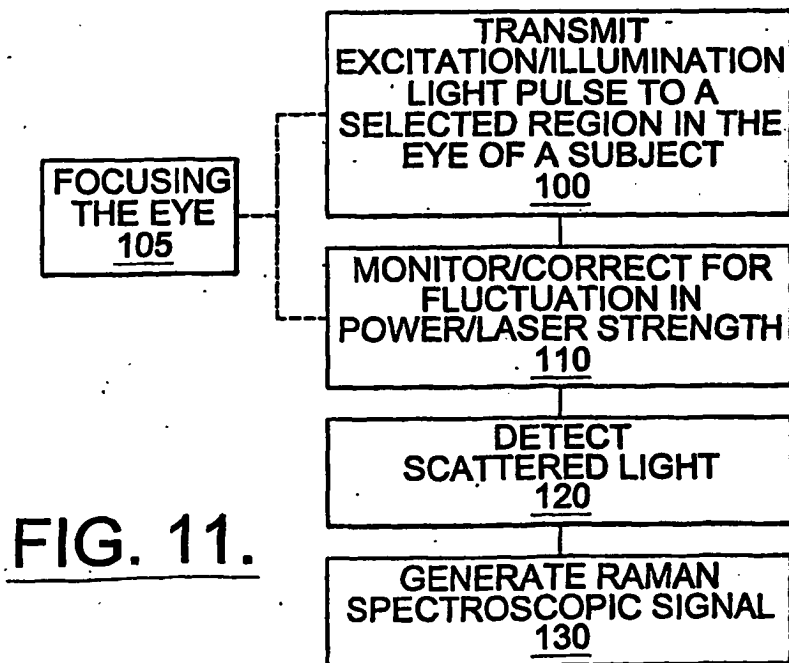
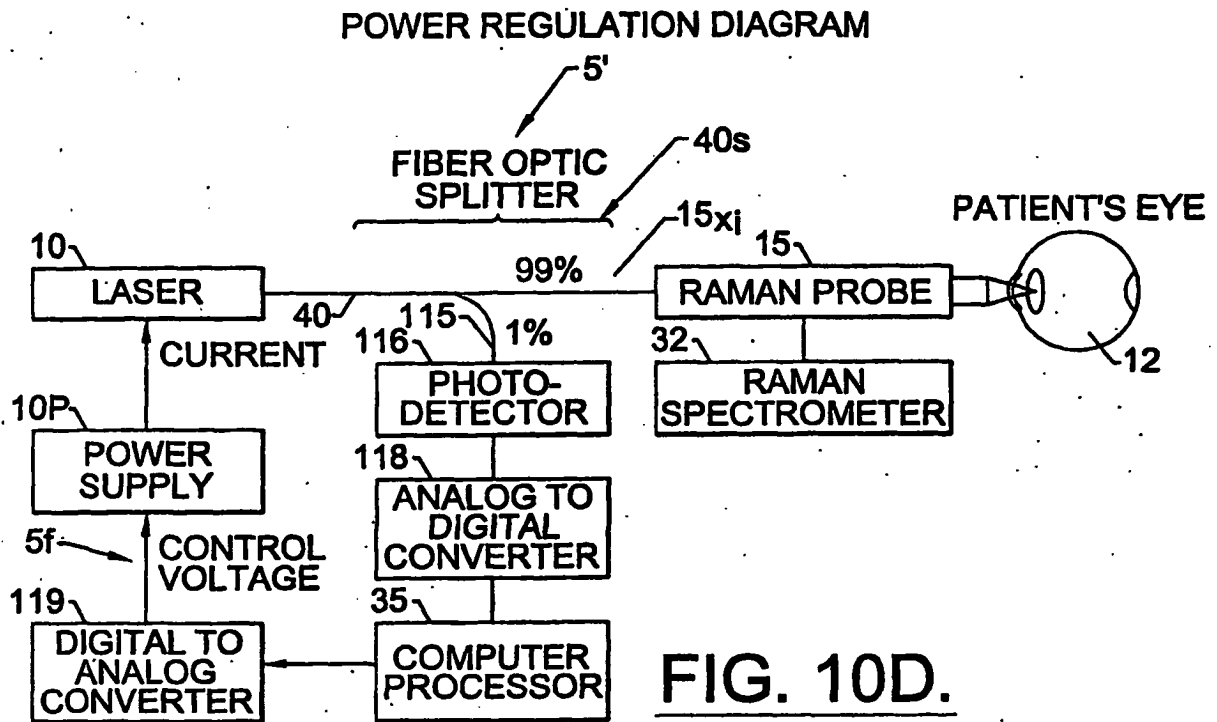

FIG. 10C.



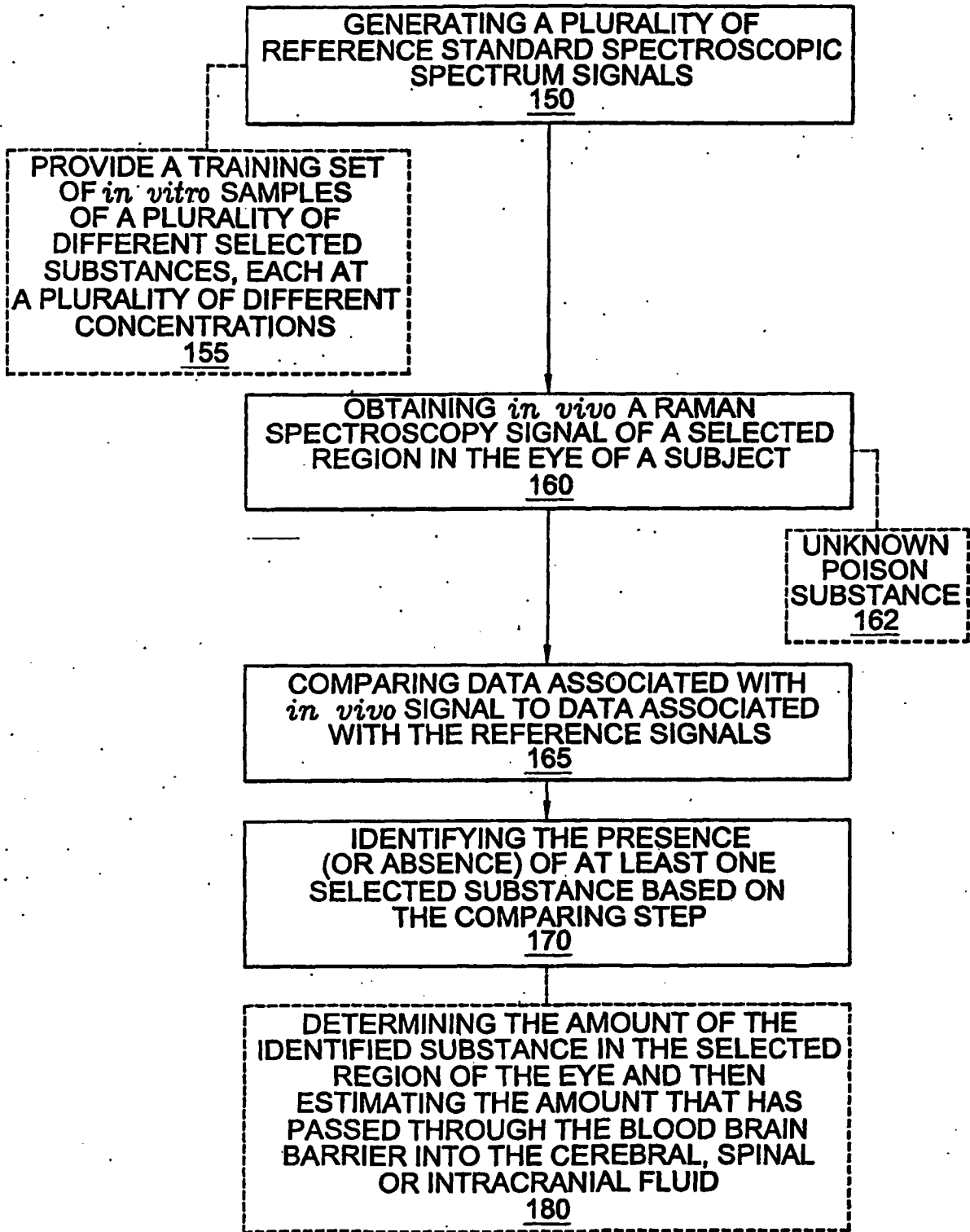

FIG. 12.

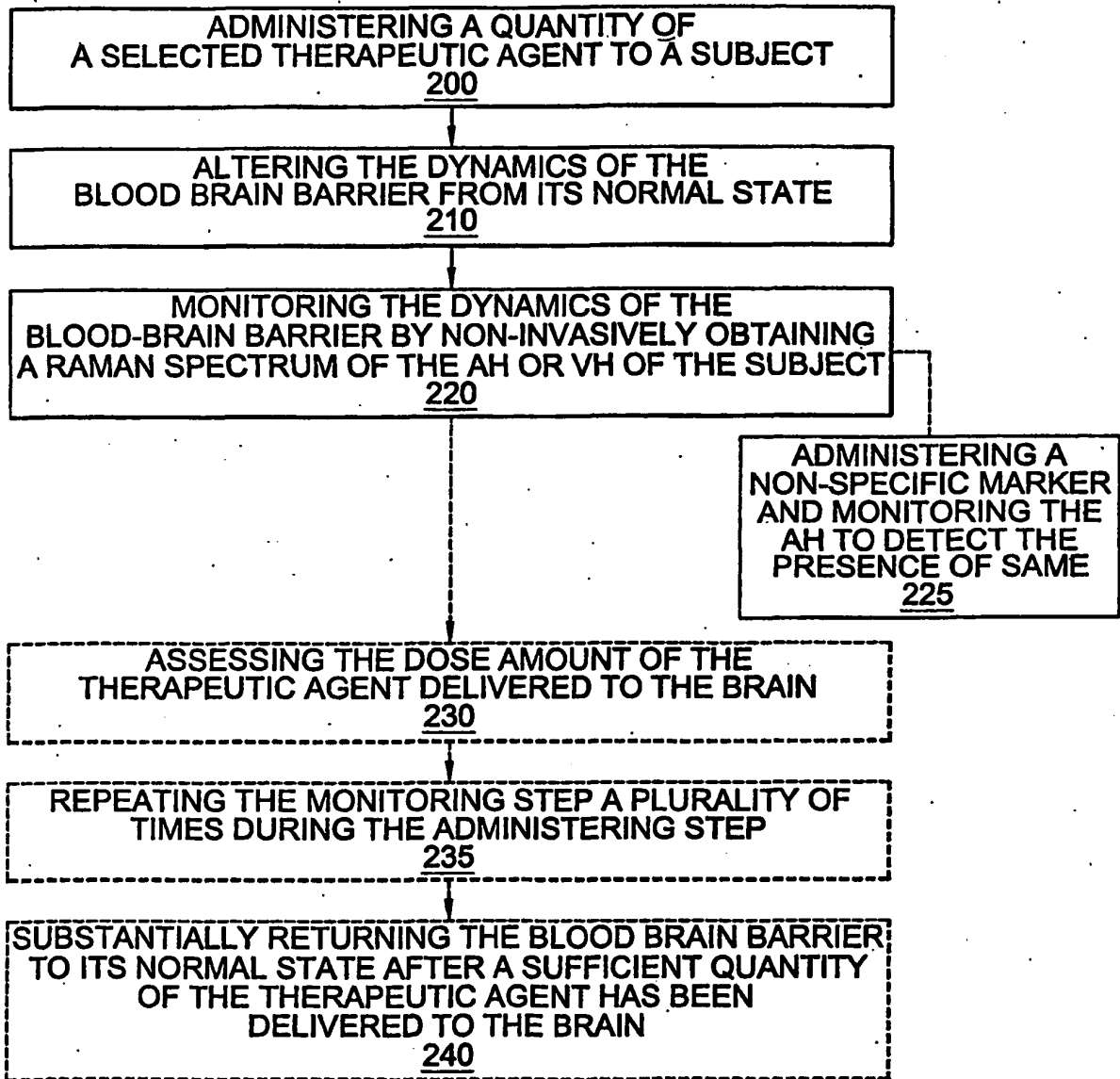

FIG. 13.

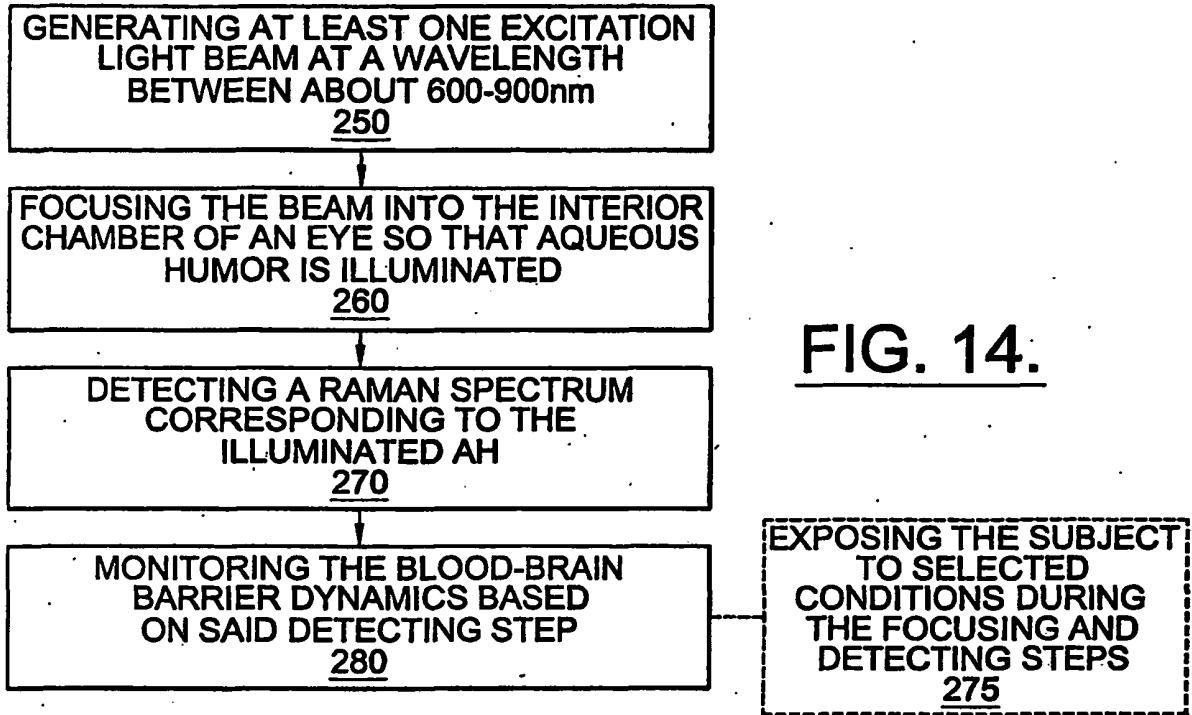

FIG. 14.

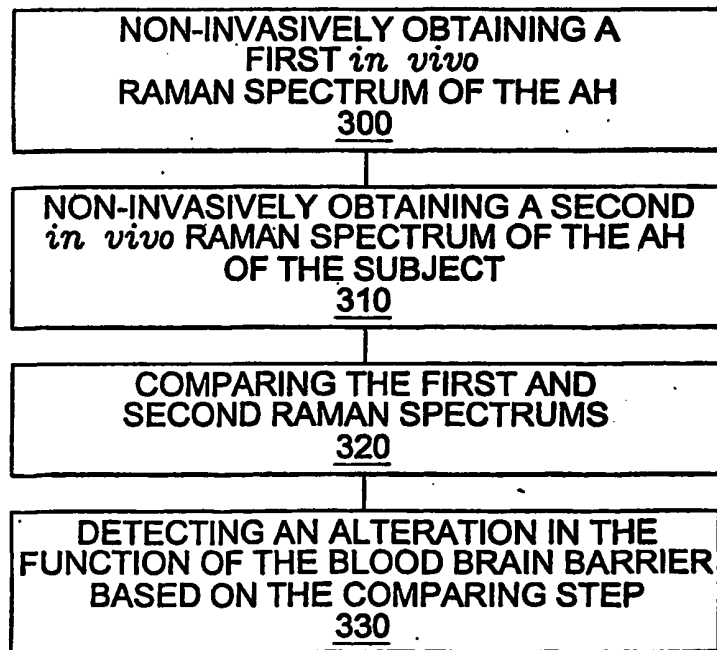

FIG. 15.

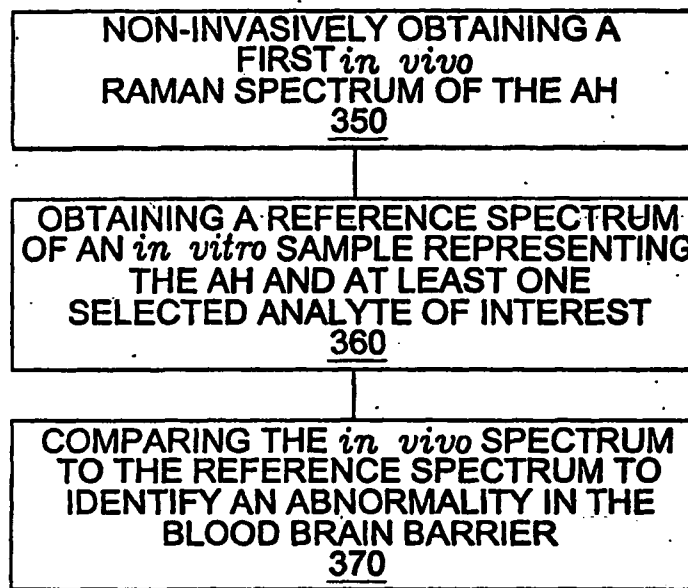

FIG. 16.

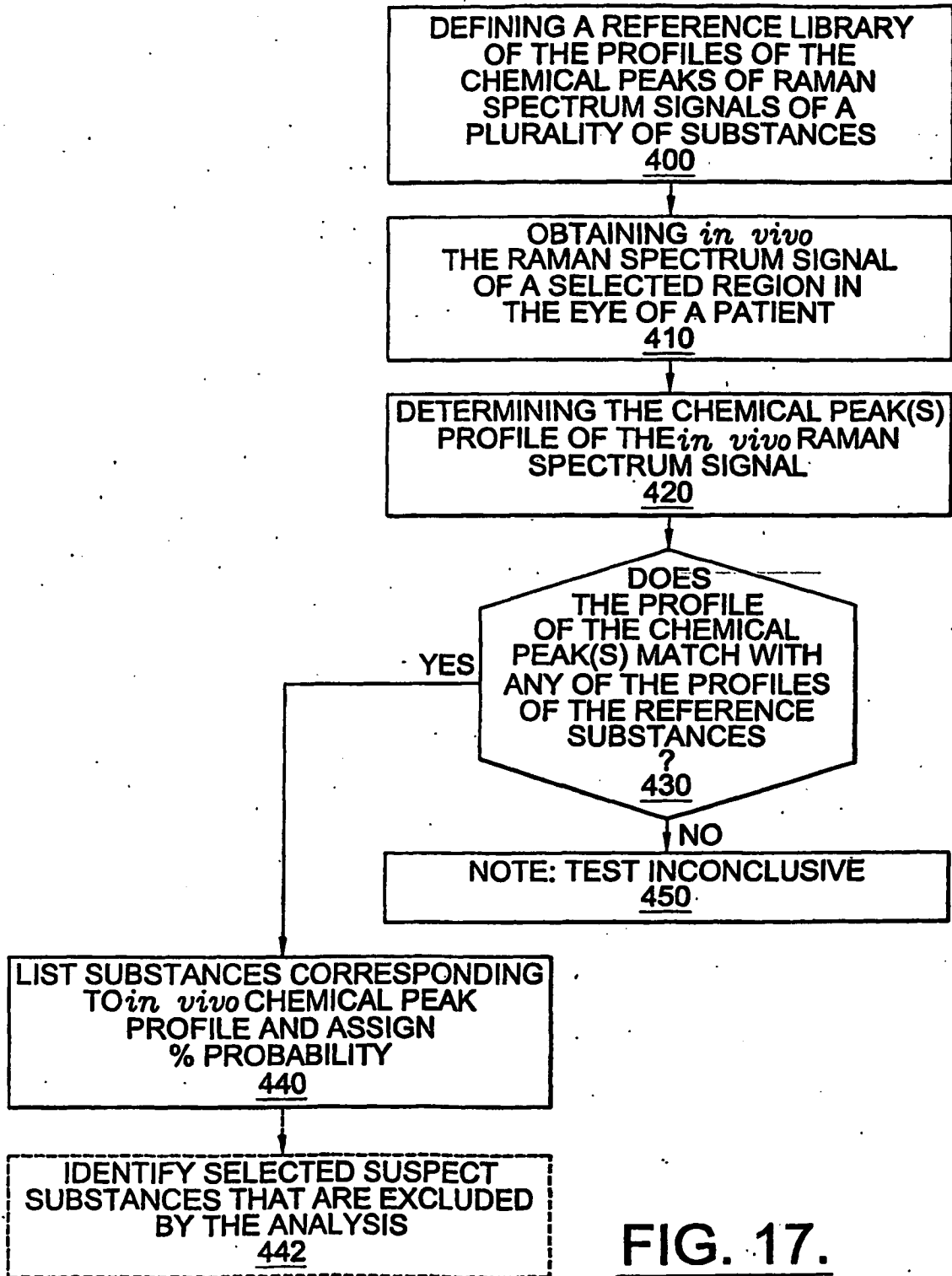
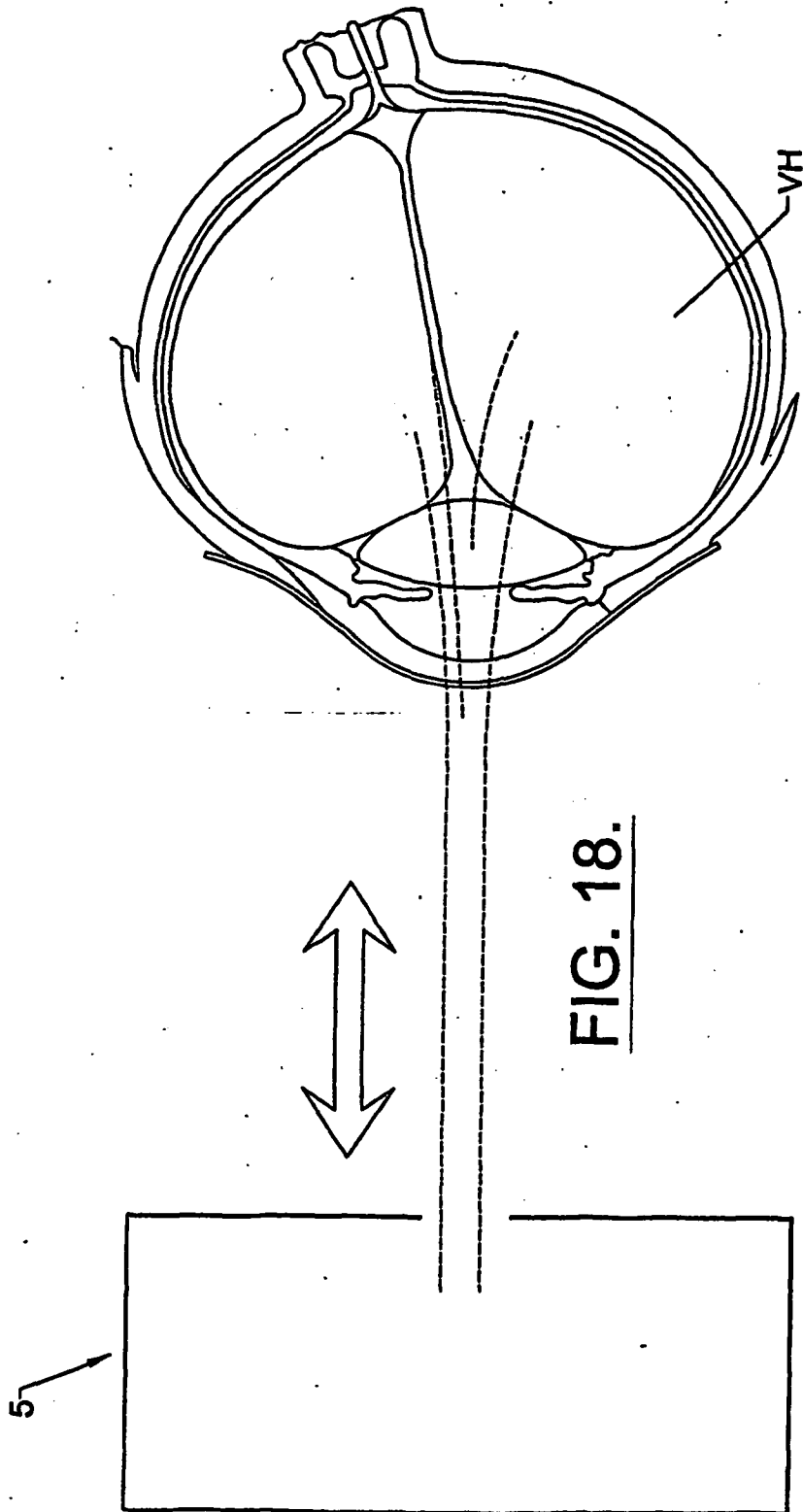

FIG. 17.



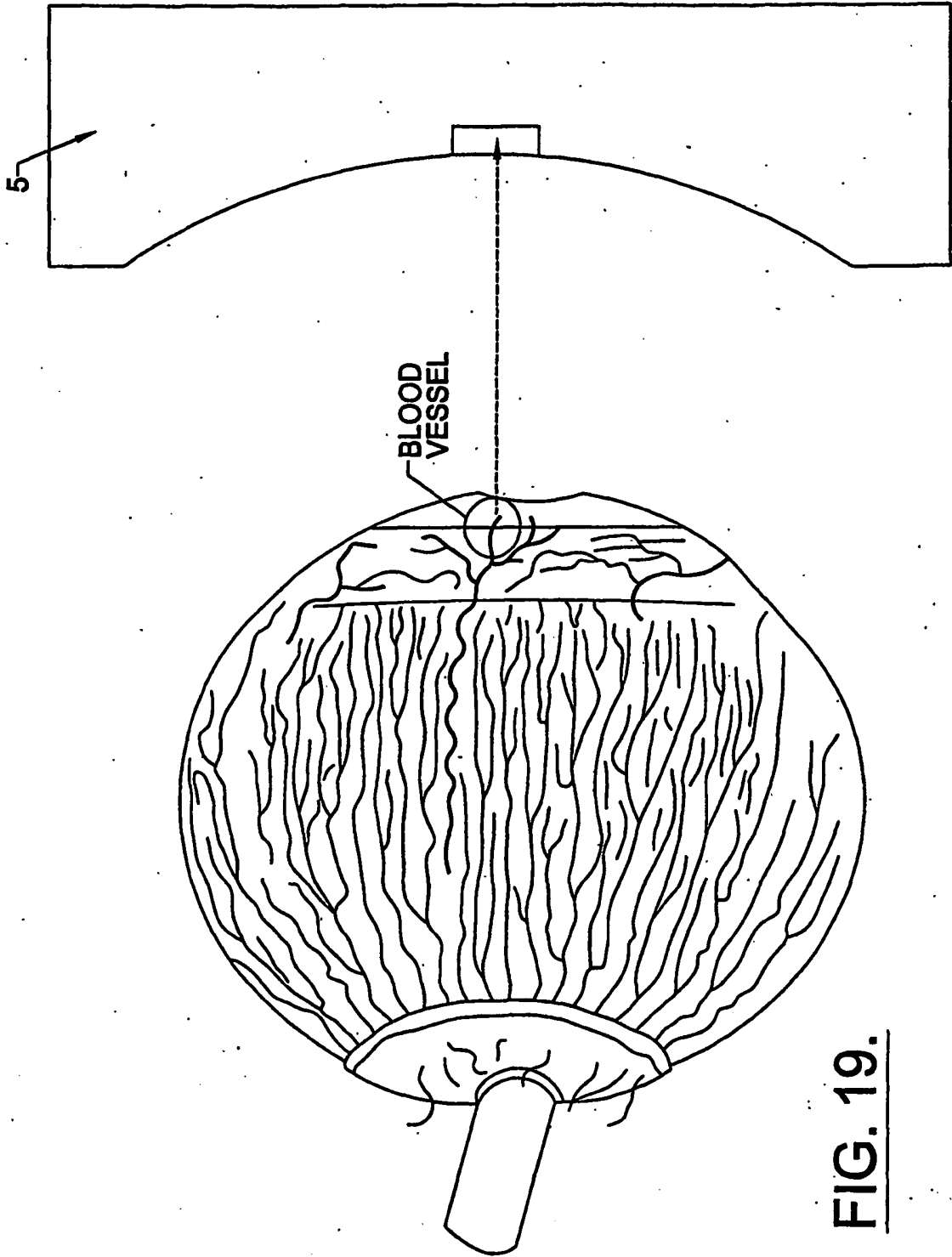
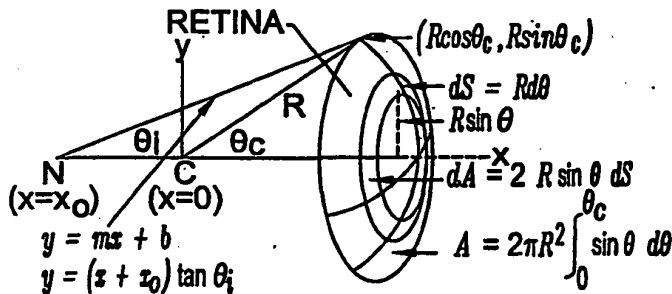
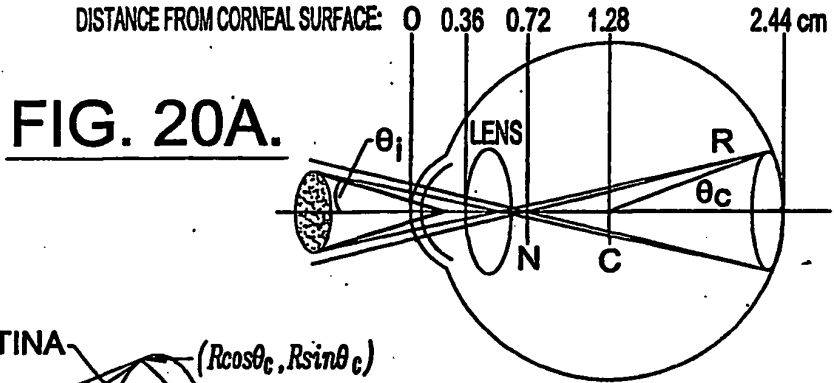

FIG. 19.

Optical power density calculations are performed using a canonical model of the adult eye (20A), a ray-tracing technique is used to calculate the area of retina exposed, A , by treating the incident light as if it emanated from node point N . Equation 1 is an expression of A as a function of θ_c and the radius of the globe R (20B). Equation 2 is derived in order to express θ_c in terms of the angle of incidence θ_i . Equation 2 must be solved numerically for θ_c . Substituting θ_c into Equation 1 is used to determine A . Power density is easily calculated for a given input power once A is determined. Solutions for both the exposed retinal area and the power density (assuming 30 mW input) are shown as a function of the angle of incidence (20C).



(2) $R \sin \theta_c = (R \cos \theta_c + x_0) \tan \theta_i$

(1) $A = 2\pi R^2 (1 - \cos \theta_c)$

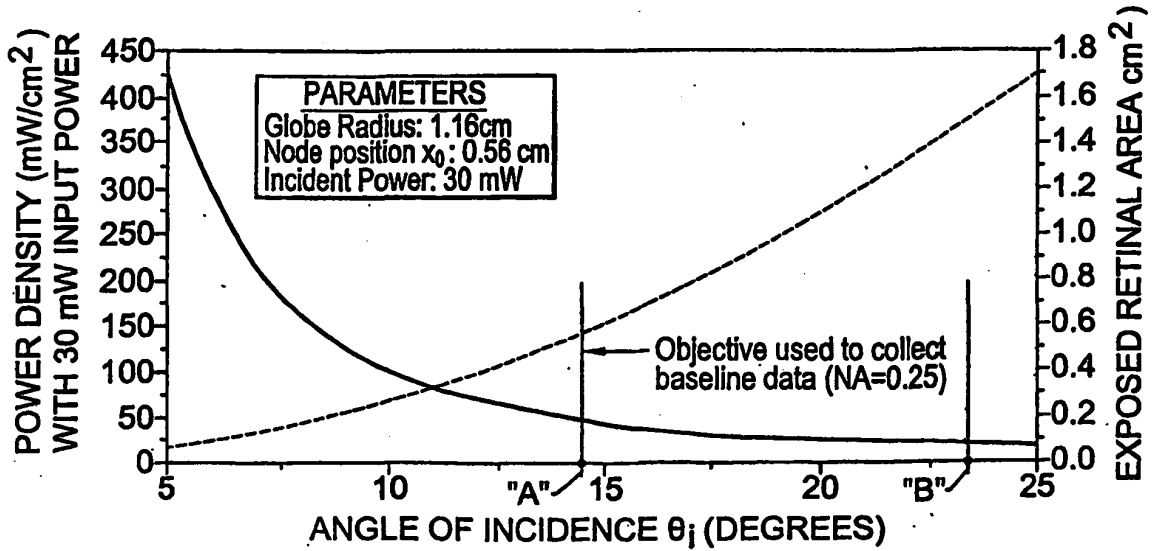

ENSEMBLE SPECTRUM OF ARTIFICIAL AQUEOUS
HUMOR SAMPLES IN A MODEL ANTERIOR CHAMBER

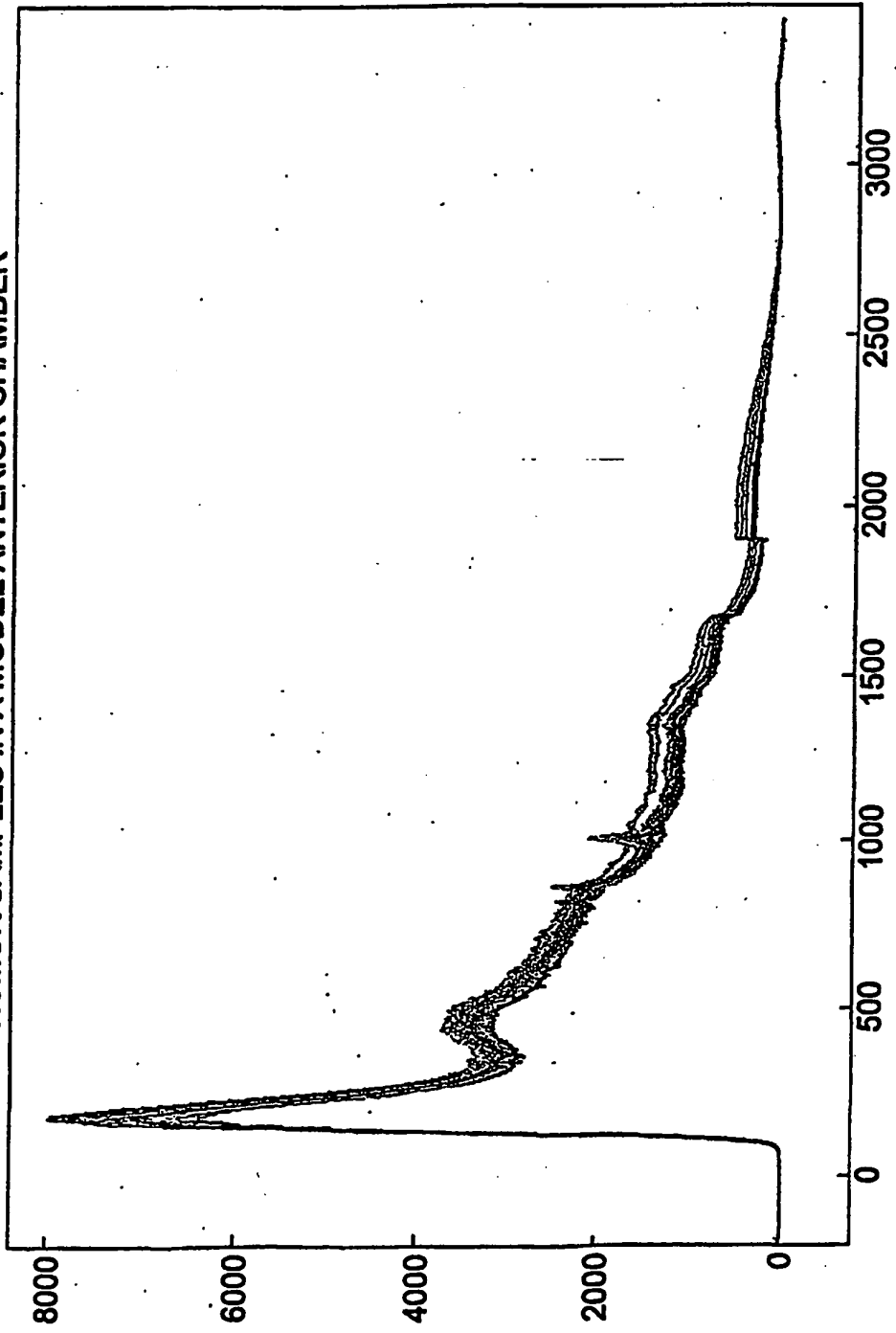

FIG. 21A.

In Vitro ENSEMBLE SPECTRUM OF AQUEOUS HUMOR IN A
MODEL ANTERIOR CHAMBER

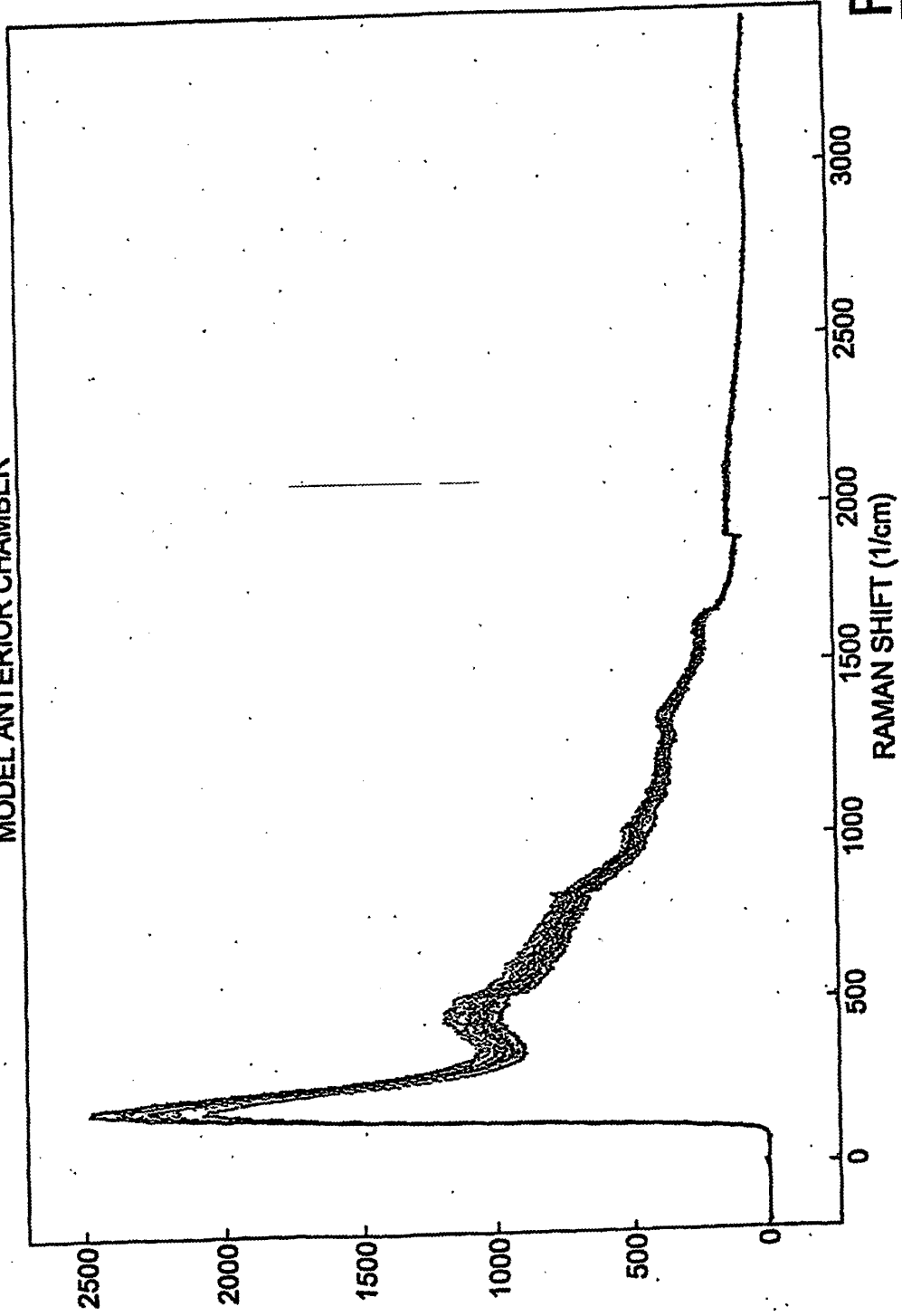

FIG. 21B.

In Vivo ENSEMBLE SPECTRUM OF AQUEOUS HUMOR

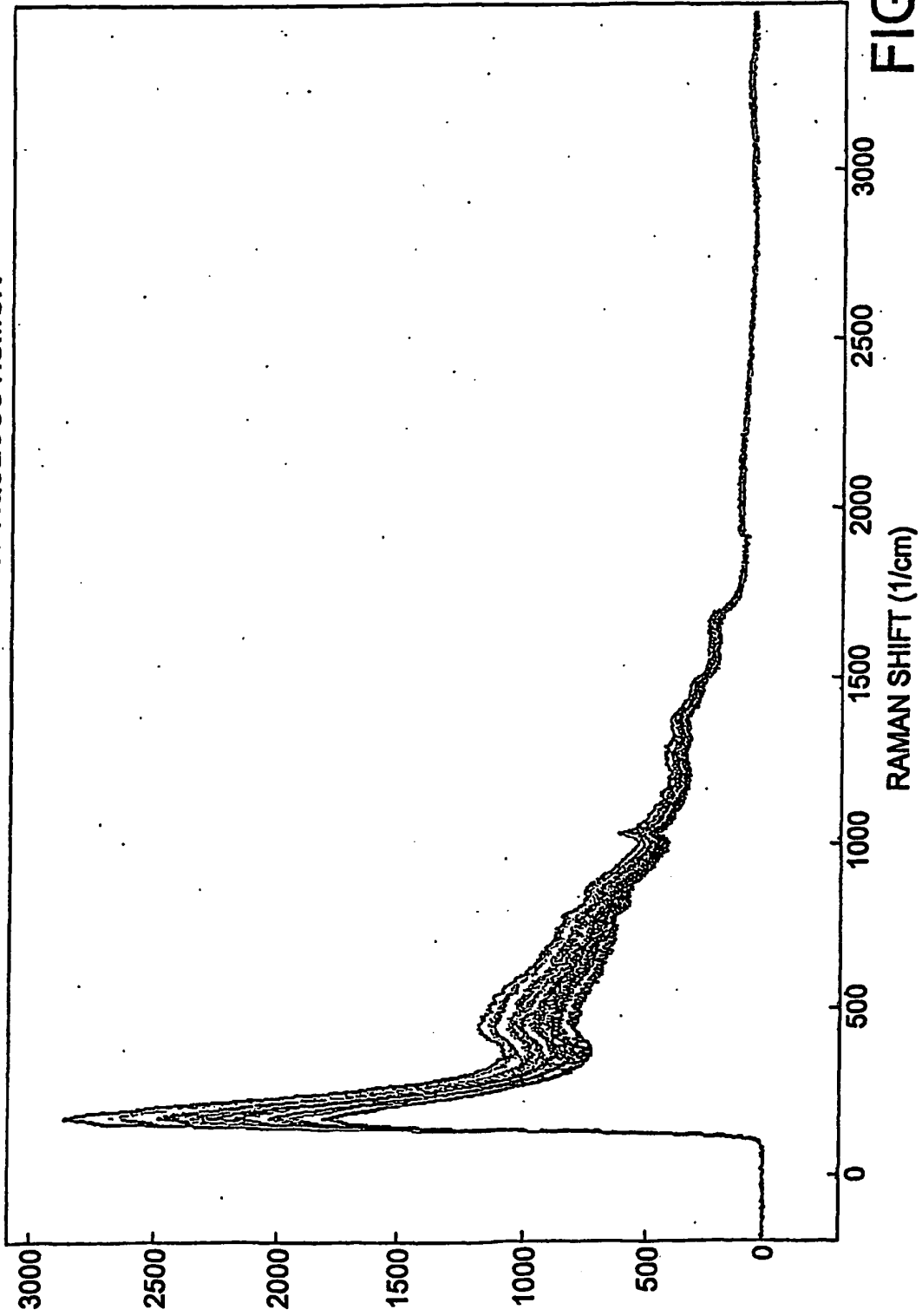
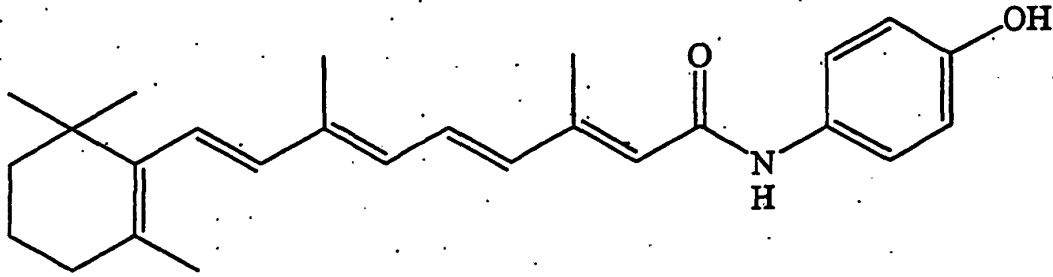

FIG. 21C.

Fenretinide in Ehtanol

Fig. 22A



N-(4-hydroxyphenyl)retinamide (4-HPR)

Fig. 22B

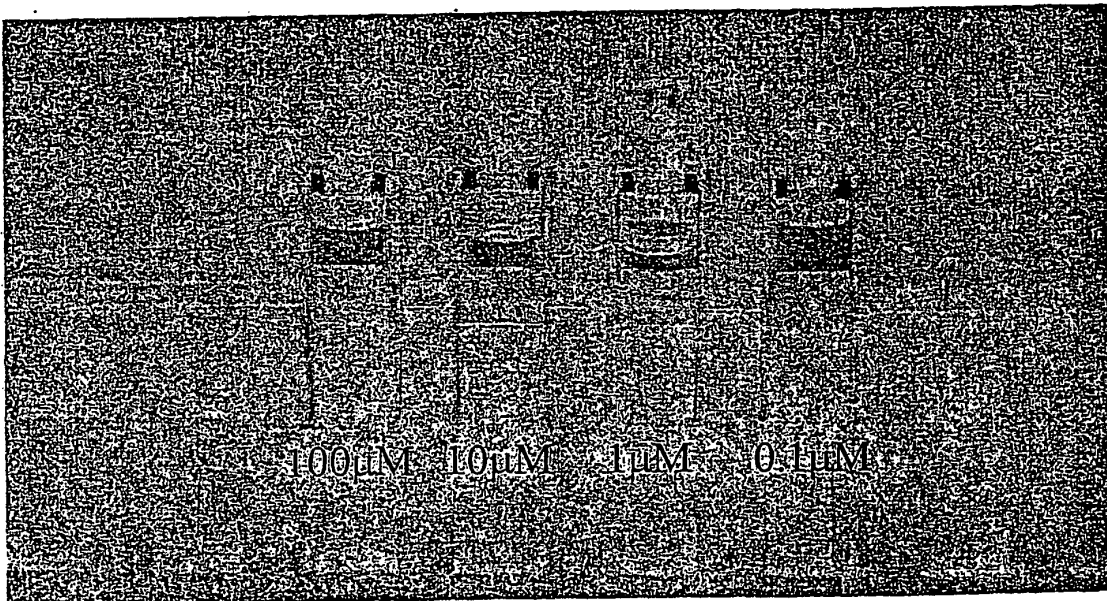

Absorption Spectrum of 10 μ M Fenretinide Fig.23

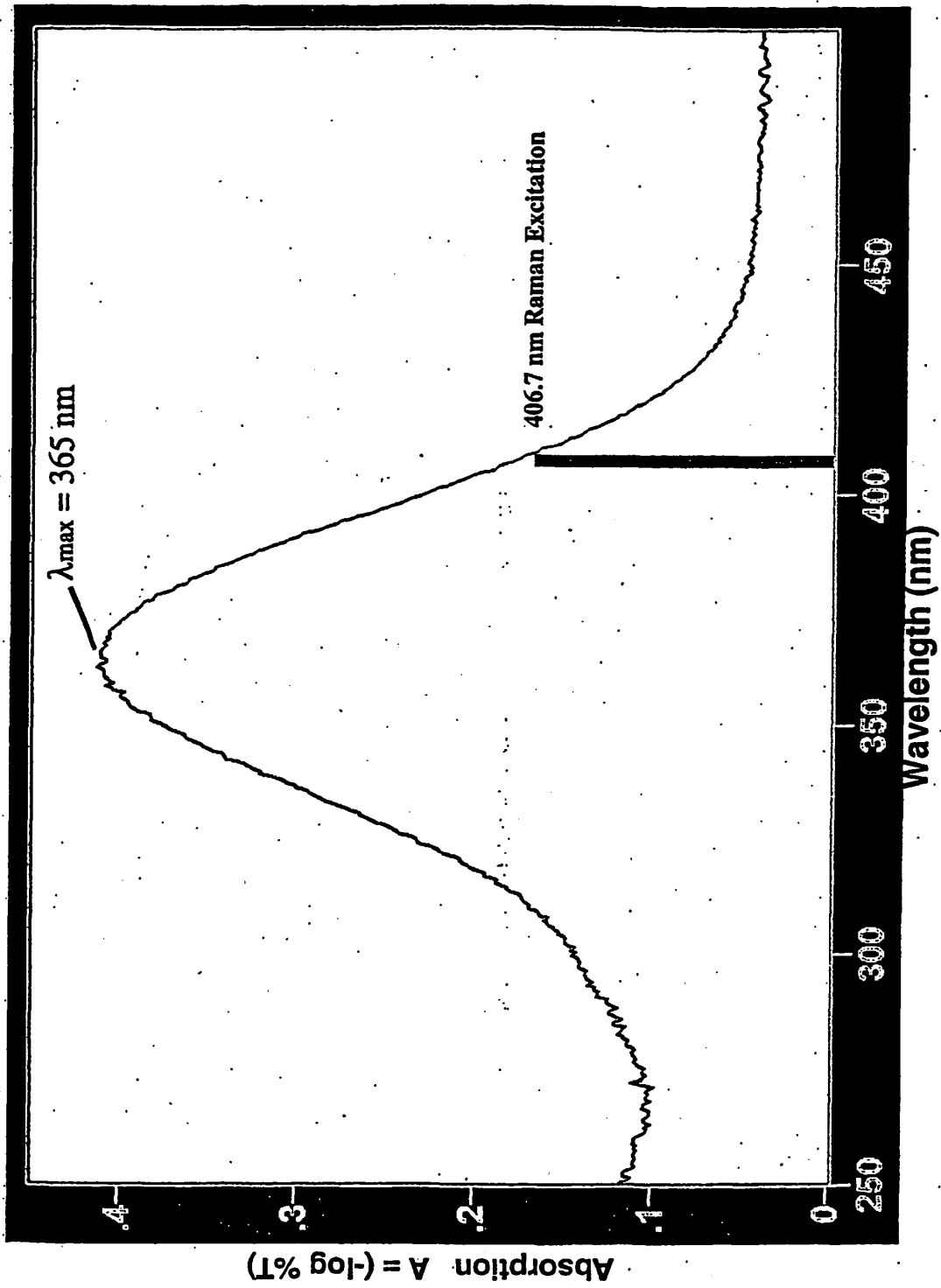

785 nm Raman Spectrum of 10 mM Fenretinide

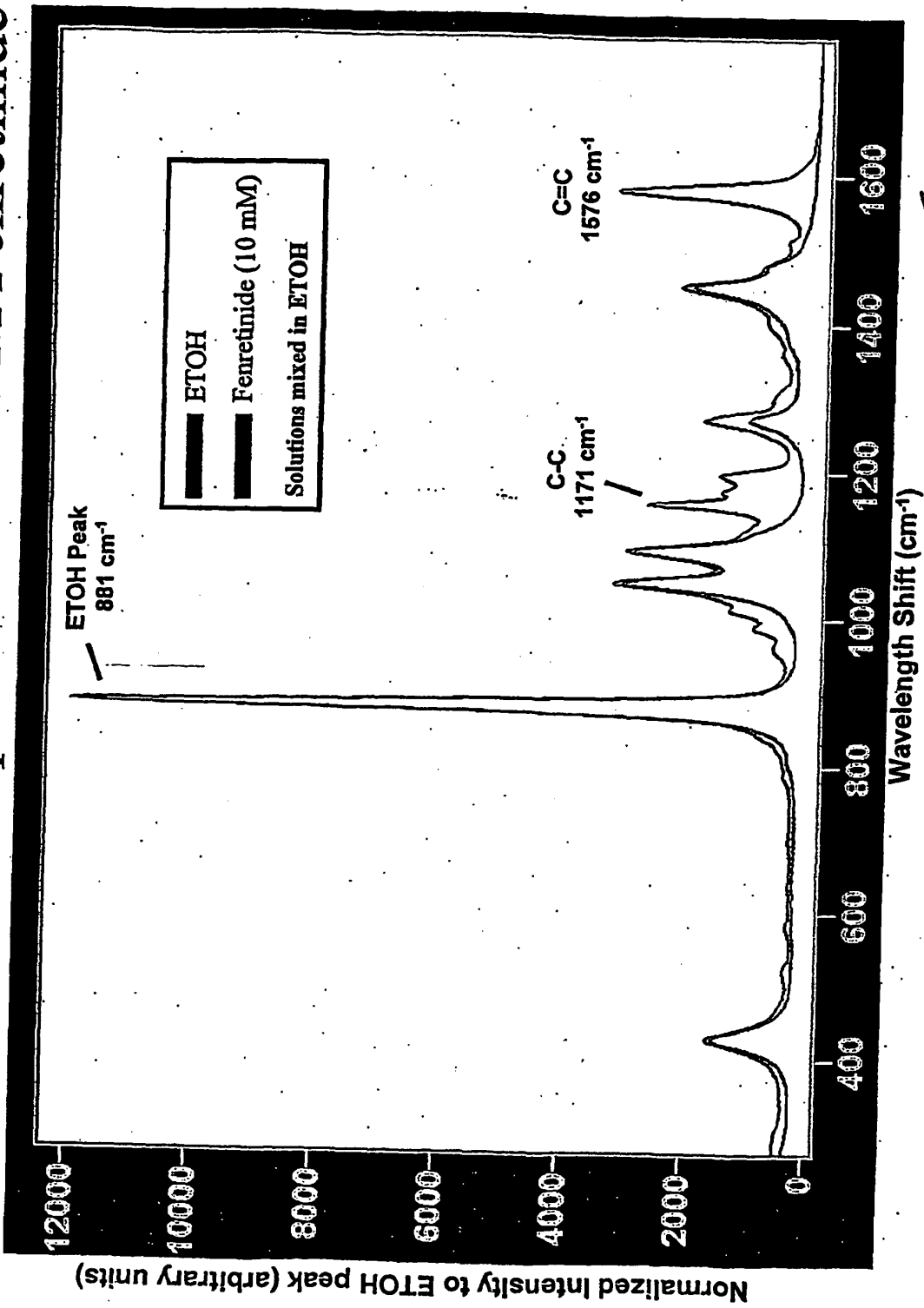

Fig. 24

Pre-resonant 10 mM Fenretinide Spectra

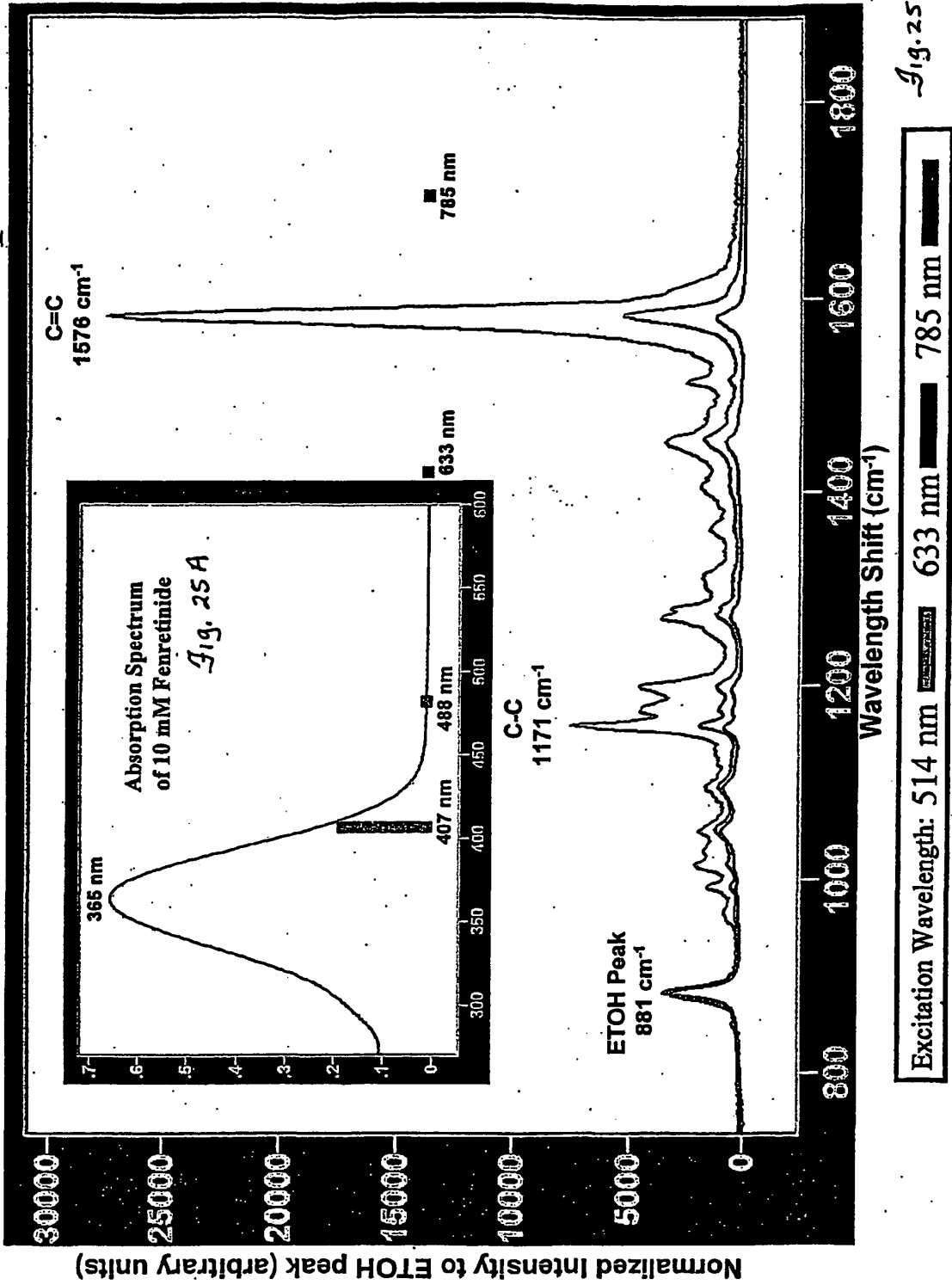

Fig. 25B

RR Spectra of Fenretinide at 406.7 nm

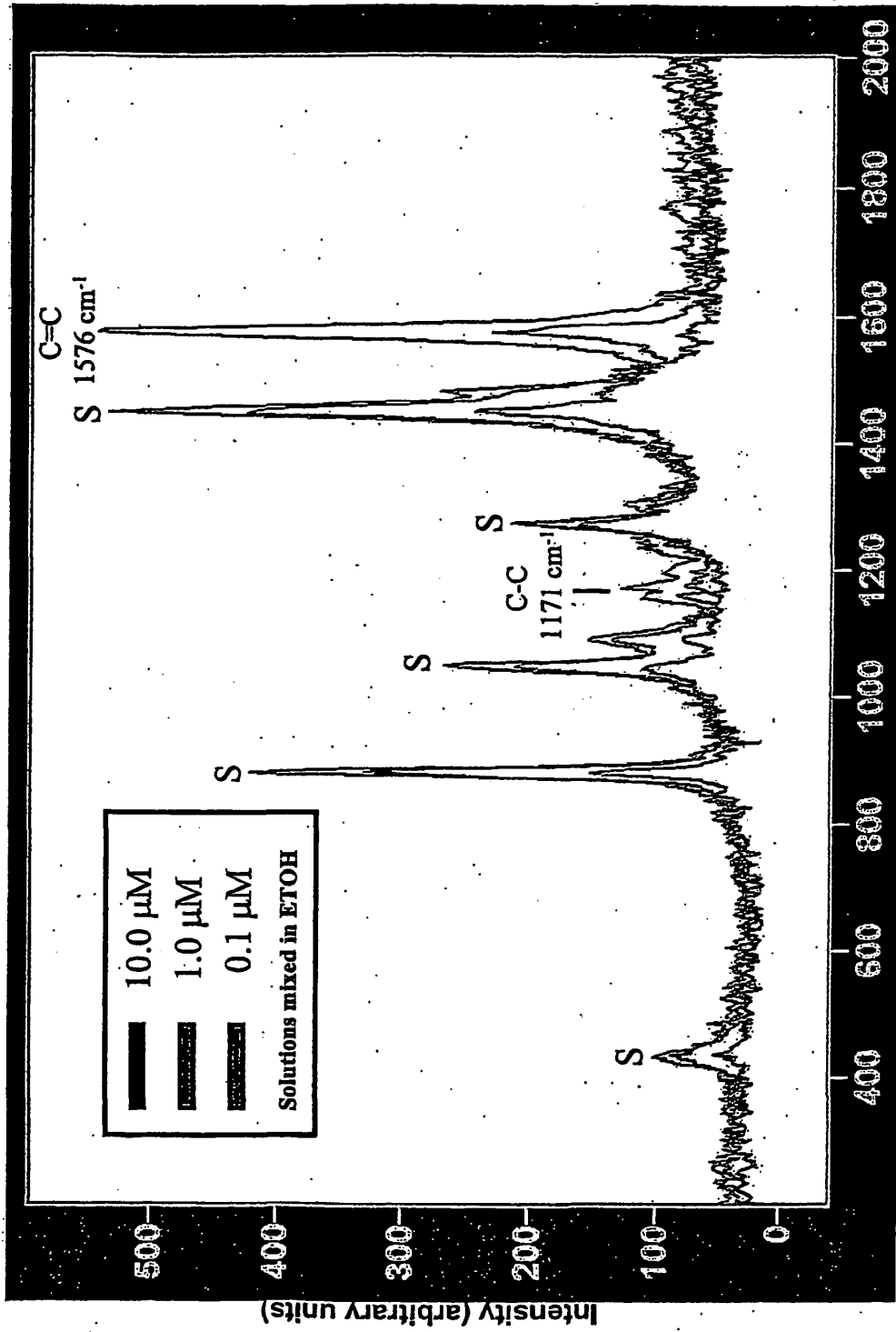
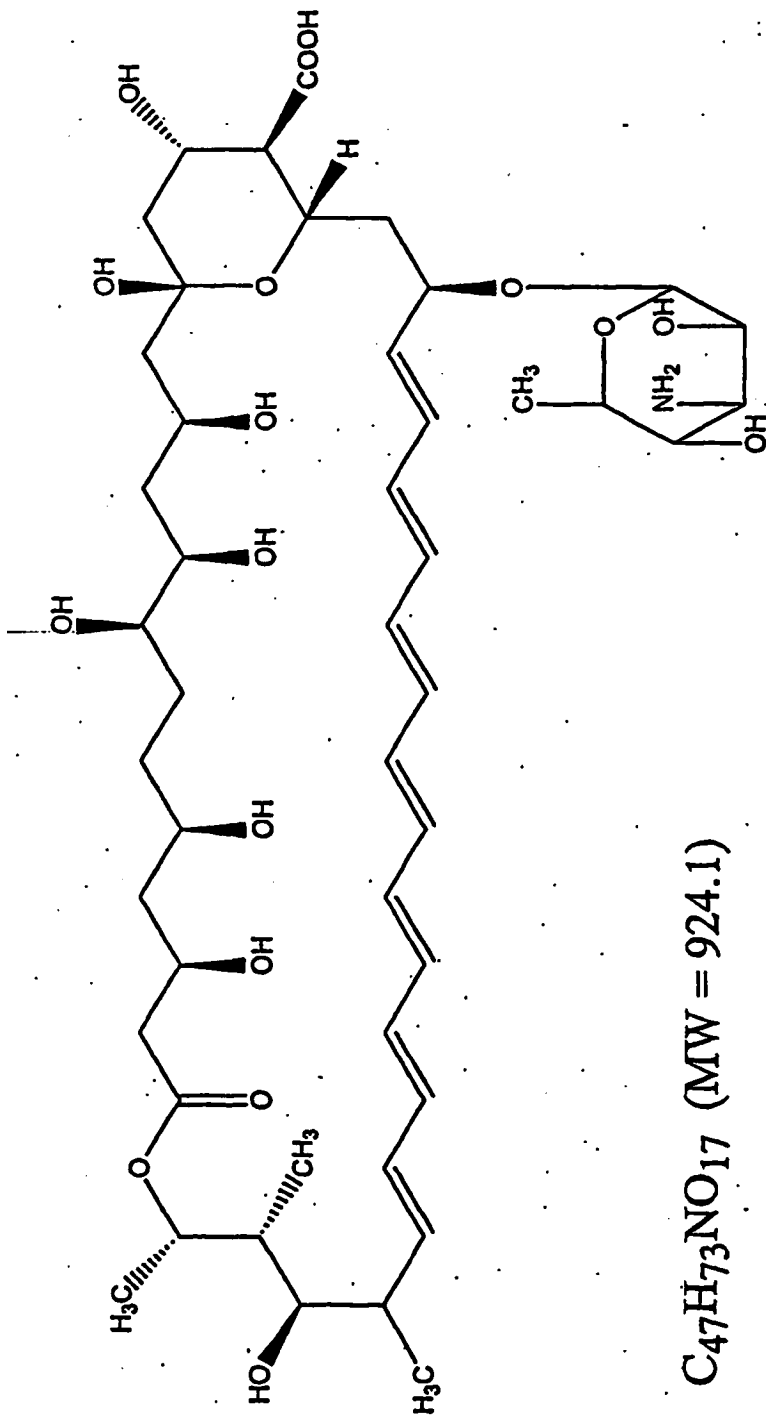

Fig. 26



C₄₇H₇₃NO₁₇ (MW = 924.1)

Fig. 27

Fig. 28

Absorption Spectrum of Amphotericin (5 $\mu\text{g/ml}$)

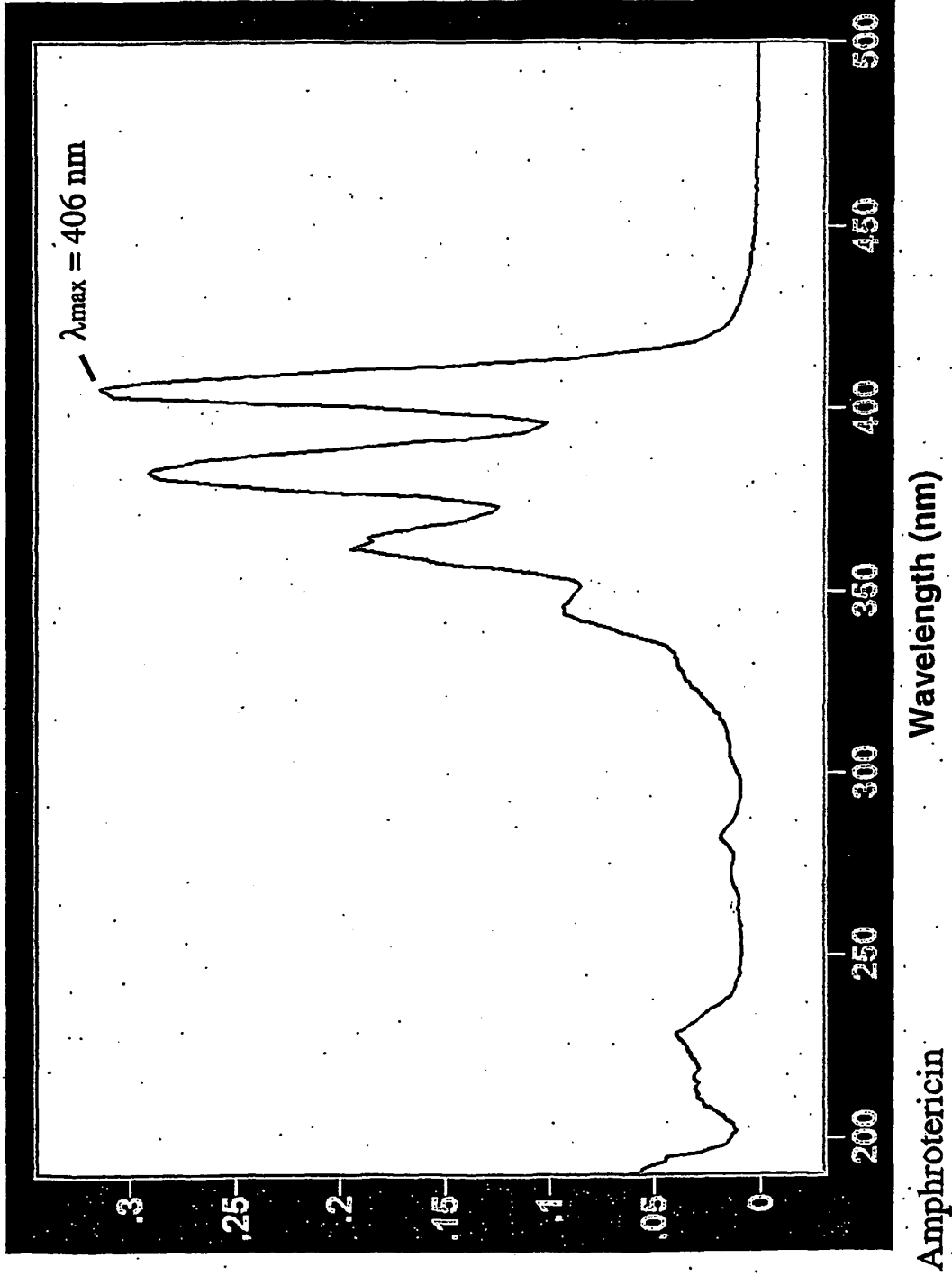

Resonant Raman Spectrum of Amphotericin

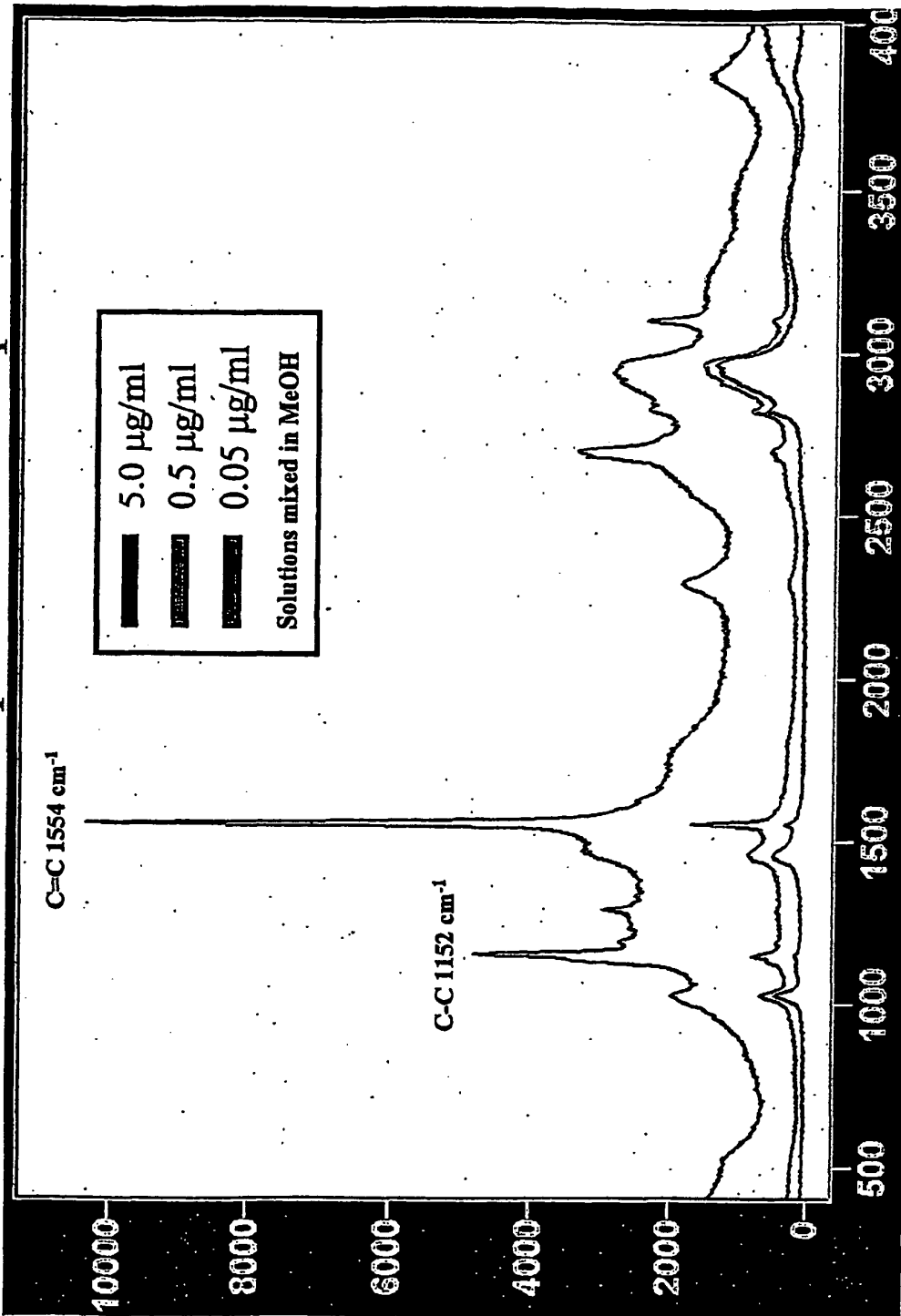

Fig. 29

Raman Shift (cm⁻¹)

Instrument Parameters: 406.7 nm, 1.3 mW power, 20X objective, 10 sec exp., Renishaw Extended Scan

Fig.30

Compact/ Inexpensive Instrument Design

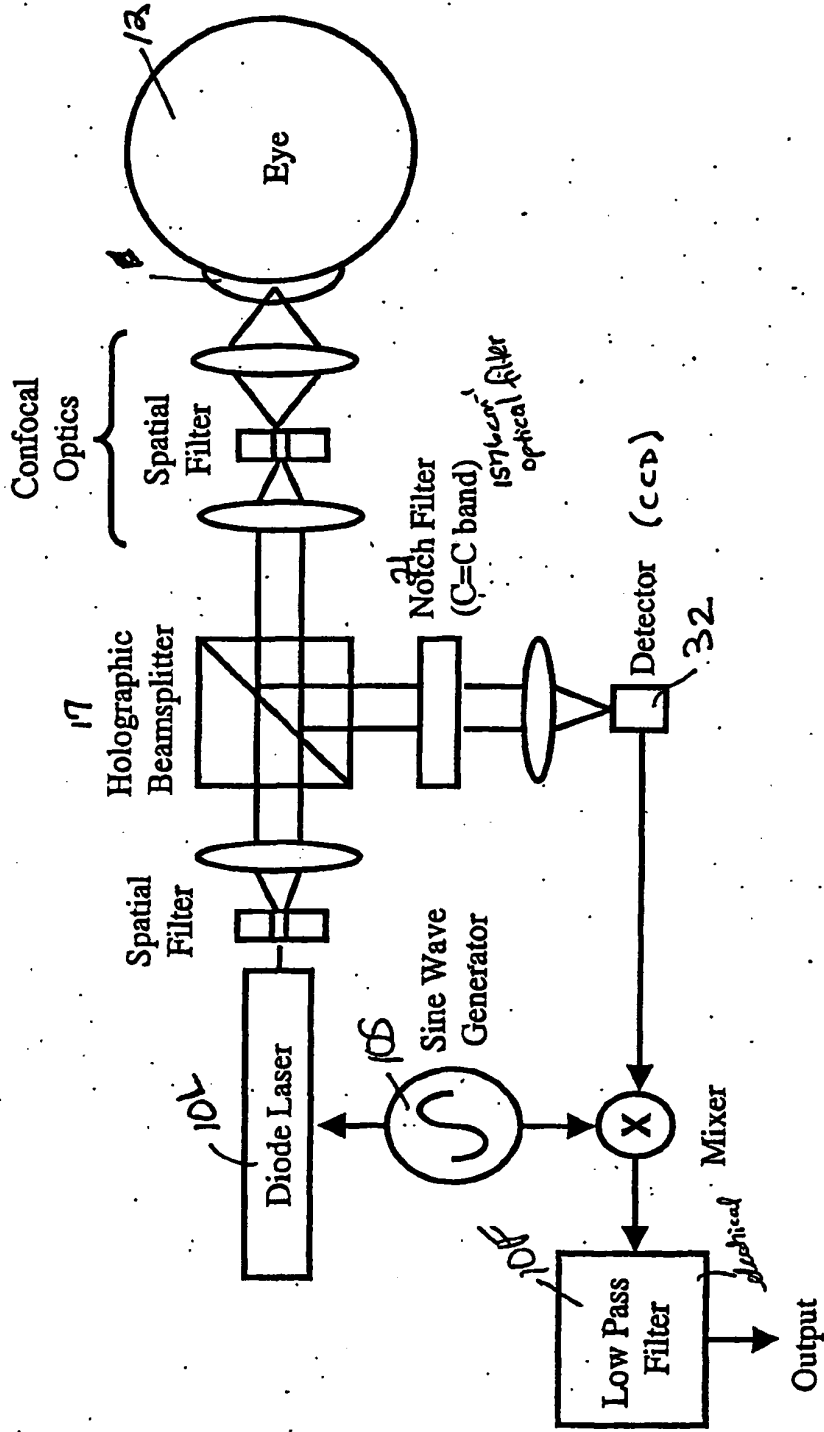

lock-in amplifier

REFERENCES CITED IN THE DESCRIPTION

This list of references cited by the applicant is for the reader's convenience only. It does not form part of the European patent document. Even though great care has been taken in compiling the references, errors or omissions cannot be excluded and the EPO disclaims all liability in this regard.

Patent documents cited in the description

- US 5243983 A, Tarr [0007]
- US 5433197 A, Stark [0008]
- US 5553617 A, Barkenhagen [0008]
- US 571030 A, Essenpreis [0008]
- US 5666956 A, Buchert [0008]
- WO 0002479 A [0009]

Non-patent literature cited in the description

- **Pohjola.** *Acta Ophthalmologica*, 1996, 1-80 [0003]
- **Schrader et al.** The glucose contents of the aqueous humour compared with capillary blood in man. *Invest. Ophthalmol. Vis. Sci.*, 2000, vol. 44, 404 [0003]
- **D. Reddy ; V. Kinsey.** *Arch. Ophthalmol.*, 1960, vol. 63, 715-720 [0004]
- **M. Reim et al.** *Ophthalmologica*, 1967, vol. 154, 39-50 [0004]
- **W. March et al.** *Diabetes Care*, 1982, vol. 5, 259 [0004]
- *J. Clin. Engineering*, 1997, vol. 22, 253 [0005]
- **S. Wang et al.** *Applied Optics*, 1993, vol. 32, 925 [0005]
- **Wicksted et al.** *Appl. Spectroscop.*, 1995, vol. 49, 987 [0006]
- **Goetz et al.** *IEEE Trans. Biomed. Eng.*, 1995, vol. 42, 728 [0006]
- **J. Lambert et al.** *LEOS Newsletter*, 1998, vol. 12, 19-22 [0006]
- **Puppels et al.** *Applied Spectroscopy*, 1993, vol. 47, 1256-67 [0081]
- Standard Practices for Infrared, Multivariate, Quantitative Analysis. *ASTM E*, 1655-97 [0104]
- **Beebe et al.** An Introduction to Multivariate Calibration and Analysis. *Anal. Chem.*, 1987, vol. 59, 1007A-10017A [0104]
- **Draper et al.** *Applied Regression Analysis*. John Wiley and Sons, 1981 [0104]
- **Maliowski et al.** *Factor Analysis in Chemistry*. John Wiley and Sons, 1991 [0104]
- **Mark, H.** *Principles and Practice of Spectroscopic Calibration*. John Wiley and Sons, 1991 [0104]
- **Martens et al.** *Multivariate Calibration*. John Wiley and Sons, 1989 [0104]
- Computerized Quantitative Infrared Analysis, ASTM STP. ASTM, 1987, vol. 934 [0104]
- **Schulze et al.** Artificial neural network and classical least squares methods for neurotransmitter mixture analysis. *Jnl. Neuroscience Methods*, February 1995, vol. 56 (2), 155-167 [0105]
- **Wang et al.** Analysis of metabolites in aqueous solutions by using laser Raman spectroscopy. *Applied Optics*, February 1993, vol. 32 (6), 925-9 [0105]
- **Brown, C.W.** Classical and Inverse Least-Squares Methods in Quantitative Spectral Analysis. *Spectrosc.*, 1986, vol. 1, 23-37 [0105]
- **Brown et al.** Matrix Representations and Criteria for Selecting Analytical Wavelengths for Multicomponent Spectroscopic Analysis. *Anal. Chem.*, 1982, vol. 54, 1472-1479 [0105]
- **Carey et al.** Multicomponent Analysis using an Array of Piezoelectric Crystal Sensors. *Anal. Chem.*, 1987, vol. 59, 1529-1534 [0105]
- **Haaland, D.M.** Classical versus Inverse Least-Squares Methods in Quantitative Spectral Analyses. *Spectrosc.*, 1987, vol. 2, 56-57 [0105]
- **Haaland et al.** Application of New Least-squares Methods for the Quantitative Infrared Analysis of Multicomponent Samples. *Appl. Spec.*, 1982, vol. 36, 665-673 [0105]
- **Haaland et al.** Improved Sensitivity of Infrared Spectroscopy by the Application of Least Squares Methods. *Appl. Spec.*, 1980, vol. 34, 539-548 [0105]
- **Haaland et al.** Multivariate Least-Squares Methods Applied to the Quantitative Spectral Analysis of Multicomponent Samples. *Appl. Spec.*, 1985, vol. 39, 73-84 [0105]
- **Kargacin et al.** Ion Intensity and Image Resolution in Secondary Ion Mass Spectrometry. *Anal. Chem.*, 1986, vol. 58, 2300-2306 [0105]
- **Kisner et al.** Multiple Analytical Frequencies and Standards for the Least-Squares Spectrometric Analysis of Serum Lipids. *Anal. Chem.*, 1983, vol. 55, 1703-1707 [0105]
- **Kisner et al.** Simultaneous Determination of Triglycerides, Phospholipids, and Cholesteryl Esters by Infrared Spectrometry. *Anal. Chem.*, 1982, vol. 54, 1479-1485 [0105]
- **Lam, R.B.** On the Relationship of Least Squares to Cross-correlation Quantitative Spectral Analysis, *Appl. Spec.*, 1983, vol. 37, 567-569 [0105]

- **Maris et al.** Nonlinear Multicomponent Analysis by Infrared Spectrophotometry. *Anal. Chem.*, 1983, vol. 55, 1694-1703 [0105]
- Application of Computerized Quantitative Infrared Spectroscopy to the Determination of the Principal Lipids Found in Blood Serum. **McClure, G.L. et al.** Computerized Quantitative Infrared Analysis, ASTM STP 934, G.L. American Society for Testing and . Materials, 1987, vol. 13, 1-154 [0105]
- **Otto, M. et al.** Spectrophotometric Multicomponent Analysis Applied to Trace Metal Determinations. *Anal. Chem.*, 1985, vol. 57, 63-69 [0105]
- **Antoon et al.** Factor Analysis Applied to Fourier Transform Infrared Spectra. *Appl. Spec.*, 1979, vol. 33, 351-357 [0105]
- **Are et al.** On the Effect of Calibration and the Accuracy of NIR Spectroscopy with High Levels of Noise in the Reference Value. *Appl. Spec.*, 1991, vol. 45, 109-115 [0105]
- **Bulmer et al.** Factor Analysis as a Complement to Band Resolution Techniques. I. The Method and its Application to Self-Association of Acetic Acid. *J. Phys. Chem.*, 1973, vol. 77, 256-262 [0105]
- **Culler et al.** Factor Analysis Applied to a Silane Coupling Agent on E-Glass Fibber System. *Appl. Spec.*, 1984, vol. 38, 495-500 [0105]
- **Dale et al.** Principal Component Analysis of diffuse Near-Infrared Reflectance Data From Paper Currency. *Appl. Spec.*, 1989, vol. 43, 1399-1405 [0105]
- **Gillette et al.** Noise Reduction via Factor Analysis in FT-Ir Spectra. *Appl. Spec.*, 1982, vol. 36, 535-539 [0105]
- **Lindberg et al.** Partial Least Squares Method for Spectrofluorimetric Analysis of Mixtures of Humic Acid and Ligninsulfonate. *Anal. Chem.*, 1983, vol. 55, 643-648 [0105]
- **Lukco et al.** The Use of GC AES Multielement Simulated Distillation for Petroleum Product Fingerprinting. *J. Chrom. Sci.*, March 1993 [0105]
- **Malinowski et al.** Factor Analysis in Chemistry. John Wiley and Sons, 1991 [0105]
- **Malinowski, E.R.** Theory of the Distribution of Error Eigenvalues Resulting from Principal Component Analysis with Applications to Spectroscopic Data. *J. Chemo.*, 1987, vol. 1, 33-40 [0105]
- **Malinowski, E.R.** Statistical F-Tests for Abstract Factor Analysis and Target Testing. *J. Chemo.*, 1987, vol. 1, 49-60 [0105]
- **Malinowski, E.R.** Theory of Error in Factor Analysis. *Anal. Chem.*, 1977, vol. 49, 606, 612 [0105]
- **Malinowski, E.R.** Determination of the Number of Factors and the Experimental Error in a Date Matrix. *Anal. Chem.*, 1977, vol. 49, 612-617 [0105]
- **Naes et al.** Selection of Samples for Calibration in Near-Infrared Spectroscopy. Part 1: General Principles Illustrated by Example. *Appl. Spec.*, 1989, vol. 43, 328-335 [0105]
- **Rao et al.** Factor Analysis and Least-Squares Curve-Fitting of Infrared Spectra: An Application to the Study of Phase Transitions in Organic Molecules. *Appl. Spec.*, 1984, vol. 38, 795-803 [0105]
- **Schostack et al.** Preferred Set Selection by Iterative Key Set Factor Analysis. *Chemo. and Intel. Lab. Sys.*, 1989, vol. 6, 21-29 [0105]
- **Vaughan et al.** Determination of Ni by ICP-MS: Correction of Oxide and Hydroxide Interferences Using Principal Components Analysis. *Appl. Spec.*, 1990, vol. 44, 1685-1689 [0105]
- **Donahue et al.** Analysis of Deoxvribonucleotides with Principal Component and Partial Least-Squares Regression of UV Spectra after Fourier Processing. *Appl. Spec.*, 1990, vol. 44, 407-413 [0105]
- **Geladi et al.** Partial Least-Squares Regression: A Tutorial. *Anal. Chim. Acra*, 1986, vol. 185, 1-17 [0105]
- **Haaland et al.** Partial Least-Squares Methods for Spectral Analysis 1. Relation to Other Quantitative Calibration Methods and the Extraction of Qualitative Information. *Anal. Chem.*, 1988, vol. 60, 1193-1202 [0105]
- **Haaland et al.** Partial Least-Squares Methods for Spectral Analysis 2. Application to Simulated and Glass Spectral Data. *Anal. Chem.*, 1988, vol. 60, 1202-1208 [0105]
- **Hanna et al.** A Comparison of Methods Used for the Reconstruction of GCIFT-17R Chromatograms. *J. Chrom. Sci.*, 1979, vol. 17, 423-427 [0105]
- **Kelly et al.** Prediction of Gasoline Octane Numbers from Near-infrared Spectral Features in the range 660-121 5nm. *Anal. Chem.*, 1989, vol. 61, 313-320 [0105]
- **Lindberg et al.** Partial Least-Squares Method for Spectrofluorimetric Analysis of Mixtures of Humic Acid and Ligninsulfonate. *Anal. Chem.*, 1983, vol. 55, 643-648 [0105]
- **Otto et al.** Spectrophotometric Multicomponent Analysis Applied to Trace Metal Determinations. *Anal. Chem.*, 1985, vol. 57, 63-69 [0105]
- **Funfschilling ; Williams.** *Applied Spectroscopy*, 1976, vol. 30, 443 [0119]
- **Baraga et al.** *Applied Spectroscopy*, 1992, vol. 46, 187 [0119]
- **Wicksted et al.** *Applied Spectroscopy*, 1995, vol. 49, 987 [0119]
- **D. Rumelhart et al.** *Nature*, 1986, vol. 323, 533 [0158]
- **K Chalabi et al.** *Ophthalmic Res.*, 1987, vol. 19, 289 [0159]
- **J. Arnbjerg et al.** *Ophthalmic Res.*, 1990, vol. 22, 265 [0159]
- **W. Unger et al.** *Exp. Eye Res.*, 1975, vol. 20, 255 [0162]
- **G. Peyman et al.** *Exp. Eye Res.*, 1986, vol. 42, 249 [0171]

- **T. Kurnik et al.** *Inv. Ophthalmol. Vis. Sci.*, 1989, vol. 30, 717 [0171]

专利名称(译)	分析来自眼睛的选定区域的拉曼光谱信号		
公开(公告)号	EP1383417B1	公开(公告)日	2009-12-02
申请号	EP2002717315	申请日	2002-01-09
[标]申请(专利权)人(译)	新浪娱乐讯RES INST儿童医院 加州理工学院		
申请(专利权)人(译)	LOS ANGELES研究所儿童医院 加州理工大学		
当前申请(专利权)人(译)	LOS ANGELES研究所儿童医院 加州理工大学		
[标]发明人	LAMBERT JAMES L BORCHERT MARK S		
发明人	LAMBERT, JAMES, L. BORCHERT, MARK, S.		
IPC分类号	A61B5/00 G01N21/65		
CPC分类号	A61B5/1455 A61B5/14532 A61B5/14546 A61B5/4064 A61B5/411 G01J3/027 G01N21/65 G01N2021/656		
代理机构(译)	HARRISON GODDARD FOOTE		
优先权	09/756897 2001-01-09 US		
其他公开文献	EP1383417A2		
外部链接	Espacenet		

摘要(译)

用于分析血脑屏障的非侵入性方法包括获得眼睛的选定部分的拉曼光谱并监测拉曼光谱以确定血脑屏障的动态变化。此外，用于确定感兴趣分析物（例如葡萄糖，药物，酒精，毒物等）的脑或血液水平的非侵入性方法包括：产生激发激光束（例如，在600至900的波长下）。纳米）；将激发激光束聚焦到受试者眼睛的前房中，以便照射眼睛中的房水，玻璃体液或一个或多个结膜血管；检测（优选地共焦检测）来自眼睛的被照射部分的拉曼光谱；然后从拉曼光谱确定受试者感兴趣的分析物的血液水平或脑水平（颅内或脑脊液液位）。

$$A = 2R^2(1 - \cos\theta)$$

Equation 1