



(11) **EP 2 651 286 B1**

(12) **EUROPEAN PATENT SPECIFICATION**

(45) Date of publication and mention of the grant of the patent:  
**07.03.2018 Bulletin 2018/10**

(51) Int Cl.:  
**A61B 5/00 (2006.01) A61B 5/145 (2006.01)**

(21) Application number: **11849806.2**

(86) International application number:  
**PCT/IB2011/054964**

(22) Date of filing: **07.11.2011**

(87) International publication number:  
**WO 2012/080858 (21.06.2012 Gazette 2012/25)**

(54) **SYSTEM FOR MONITORING NUTRITIONAL UPTAKE AS A FUNCTION OF MICROFLORA INTESTINAL GAS LEVELS**

SYSTEM ZUR ÜBERWACHUNG DER NÄHRSTOFFAUFNAHME ALS FUNKTION DES MIKROFLORA-DARMGAS-SPIEGELS

SYSTÈME POUR SURVEILLER L'ASSIMILATION NUTRITIONNELLE COMME FONCTION DES NIVEAUX DE GAZ INTESTINAUX DE LA MICROFLORE

(84) Designated Contracting States:  
**AL AT BE BG CH CY CZ DE DK EE ES FI FR GB GR HR HU IE IS IT LI LT LU LV MC MK MT NL NO PL PT RO RS SE SI SK SM TR**

- **ABRAHAM, Jose, K.**  
**Neenah, WI 54956 (US)**
- **RANGANATHAN, Sridhar**  
**Suwanee, GA 30024 (US)**

(30) Priority: **14.12.2010 US 422730 P**  
**26.09.2011 US 201113245412**

(74) Representative: **Davies, Christopher Robert Dehns**  
**St Bride's House**  
**10 Salisbury Square**  
**London EC4Y 8JD (GB)**

(43) Date of publication of application:  
**23.10.2013 Bulletin 2013/43**

(73) Proprietor: **Kimberly-Clark Worldwide, Inc.**  
**Neenah, Wisconsin 54956 (US)**

(56) References cited:  
**US-A- 6 033 367 US-A1- 2005 008 652**  
**US-A1- 2008 015 523 US-A1- 2009 288 606**  
**US-A1- 2010 030 133**

(72) Inventors:

- **MACDONALD, John, Gavin**  
**Decatur, GA 30033 (US)**
- **KOH, CholWon**  
**Seoul 156-725 (KR)**
- **SA, InYoung**  
**Yongin**  
**Gyeong-Gi 446-902 (KR)**

- **HOMANN H-H ET AL: "Control of postoperative enteral feeding by hydrogen breath test", CLINICAL NUTRITION, CHURCHILL LIVINGSTONE, LONDON, GB, vol. 10, 1 January 1991 (1991-01-01), page 37, XP022962586, ISSN: 0261-5614, DOI: 10.1016/0261-5614(91)90229-6 [retrieved on 1991-01-01]**

**EP 2 651 286 B1**

Note: Within nine months of the publication of the mention of the grant of the European patent in the European Patent Bulletin, any person may give notice to the European Patent Office of opposition to that patent, in accordance with the Implementing Regulations. Notice of opposition shall not be deemed to have been filed until the opposition fee has been paid. (Art. 99(1) European Patent Convention).

**Description****FIELD OF THE INVENTION**

[0001] The present disclosure generally relates to a system for monitoring the absorption and digestion of nutrients, and more particularly to a system for continuous, real-time monitoring and regulation of feeding of an individual as a function of microflora intestinal gas levels generated in the individual's digestive tract.

**BACKGROUND OF THE INVENTION**

[0002] It is important for many patients, particularly critically ill patients, to receive proper nutrition and to begin feeding as soon as possible. Proper nutrition can lead to shorter recovery times and better mortality and morbidity outcomes. Medical devices that are designed to support artificial feeding in patients include various enteral feeding systems. Enteral feeding systems typically supply nutrition to a patient's digestive tract, specifically the stomach, small intestine or jejunum by inserting a tube down a patient's nose or through the stomach wall. Conversely, parental nutrition is supplied intravenously, circumventing the usual digestion process. Enteral nutrition is typically recommended over parenteral nutrition because, if possible, it is important to use the method closest to natural feeding to keep the gut from shutting down.

[0003] Once artificial feeding has begun, it is important to assess how well the patient is tolerating the artificial feeding, as well as to determine if the patient is getting adequate nutrition. Many artificially fed patients can become malnourished due to improper amounts of nutrient being provided to the patient. This problem is enhanced in situations where the care giver slows down the feeding rate to prevent vomiting and diarrhea.

[0004] Current clinical methods used to monitor the nutritional uptake and status of artificially fed patients include daily blood tests to determine, for instance, albumin, prealbumin, electrolyte, creatine, and blood sugar levels, and 72 hour fecal fat content tests. In addition, bowel movements, urine assessment, and, if the patient is awake, strength and alertness can be observed. These methods involve long time gaps and do not offer real-time information concerning the patient's nutritional uptake to the care giver.

[0005] Thus, there is a need for a real-time nutritional uptake monitoring system and method to provide information that a patient is receiving sufficient nutrition. A system and method for informing a care giver whether too little, an ideal amount, or too much is being fed to the patient would be particularly useful.

[0006] Monitoring nutritional uptake can also be important in the specific feeding of infants. Parents and other care takers can have a more difficult time determining when an infant child is hungry or is need of feeding. In addition, weight gain and overall health status is the primary method of assessing proper nutrient delivery for

breast feed infants. Thus, there is similarly a need for a specific system and method of real-time nutritional uptake monitoring to provide information that an infant is receiving sufficient nutrition. Document Homann et al "Control of postoperative enteral feeding by hydrogen breath test", Clinical Nutrition, vol. 10, 1 January 1991 is a report on a medical experiment that took breath samples from patients three times a day during postoperative feeding and analysed the concentration of hydrogen gas in these samples.

**SUMMARY OF THE INVENTION**

[0007] The present invention relates to a system for monitoring artificial feeding of a patient, the system comprising: a feeding device configured to deliver a volume of nutrient to a patient at an initial feeding rate; a gas sensor able to detect microflora intestinal gas configured to monitor an amount of microflora intestinal gas associated with the patient; and a controller configured to adjust the volume of nutrient delivered to the patient based at least in part on the amount of microflora intestinal gas associated with the patient.

**BRIEF DESCRIPTION OF THE DRAWINGS**

[0008] A full and enabling disclosure of the present invention, including the best mode thereof to one skilled in the art, is set forth more particularly in the remainder of the specification, including reference to the accompanying figures, in which:

FIG. 1 provides a graphical representation of hydrogen concentration versus feeding overtime;

FIG. 2 provides a flow chart of an exemplary method according to an exemplary embodiment of the present disclosure;

FIG. 3 provides a flow chart of an exemplary method for intermittent feeding according to an exemplary embodiment of the present disclosure;

FIG. 4 provides a graphical representation of hydrogen concentration versus feeding over time;

FIG. 5 provides a flow chart of an exemplary method for continuous feeding according to an exemplary embodiment of the present disclosure;

FIG. 6 provides a block diagram of an exemplary system for monitoring nutritional uptake of an artificially fed patient according to an exemplary embodiment of the present disclosure;

FIG. 7 depicts an exemplary system for monitoring nutritional uptake of an artificially fed patient according to an exemplary embodiment of the present disclosure;

FIG. 8 depicts an exemplary system for monitoring nutritional uptake of an artificially fed patient according to an exemplary embodiment of the present disclosure; and

FIG. 9 depicts a block diagram of an exemplary sys-

tem for monitoring nutritional uptake of an infant according to an exemplary embodiment of the present disclosure not part of the present invention.

Repeat use of reference characters in the present specification and drawings is intended to represent the same or analogous features or elements of the present invention. It is also understood that while hydrogen gas is exemplified by way of the figures, the present invention is not limited to only the concentrations of hydrogen gas but can account for all concentrations of microflora intestinal gas levels.

#### **DETAILED DESCRIPTION OF THE INVENTION**

**[0009]** While the specification concludes with the claims particularly pointing out and distinctly claiming the invention, it is believed that the present invention will be better understood from the following description.

**[0010]** All percentages, parts and ratios are based upon the total weight of the compositions of the present invention, unless otherwise specified. All such weights as they pertain to listed ingredients are based on the active level and, therefore; do not include solvents or by-products that may be included in commercially available materials, unless otherwise specified. The term "weight percent" may be denoted as "wt.%" herein. Except where specific examples of actual measured values are presented, numerical values referred to herein should be considered to be qualified by the word "about".

**[0011]** As used herein, "comprising" means that other steps and other ingredients which do not affect the end result can be added. This term encompasses the terms "consisting of" and "consisting essentially of". The compositions and methods/processes of the present invention can comprise, consist of, and consist essentially of the essential elements and limitations of the invention described herein, as well as any of the additional or optional ingredients, components, steps, or limitations described herein.

**[0012]** As used herein, the term "microflora intestinal gas" refers to gases such as carbon dioxide, oxygen, nitrogen, hydrogen, ammonia, acetone and methane produced by the microflora present in the intestine as the microflora break down carbohydrates for absorption through the intestine wall. Since a patient may produce any of these gases, the method of the present invention directs the monitoring for artificial feeding towards the concentrations of gases delivered by the intestinal walls.

**[0013]** One exemplary embodiment of the present disclosure not part of the present invention is directed to a method of monitoring artificial feeding of a patient. The method includes delivering a volume of nutrient to the patient with a feeding device, such as an enteral feeding device, at an initial feeding rate. The method further includes monitoring an amount of microflora intestinal gas associated with the patient with a gas sensor able to detect such microflora intestinal gases; and adjusting the

volume of nutrient delivered to the patient based at least in part on the amount of microflora intestinal gas associated with the patient. For instance, in a particular embodiment, adjusting the volume of nutrient delivered to the patient comprises adjusting the initial feeding rate of the feeding device based at least in part on the amount of microflora intestinal gas associated with the patient.

**[0014]** In a particular aspect of this exemplary embodiment, the feeding device can be coupled to a control loop configured to regulate the volume of nutrient delivered by the feeding device based at least in part on the amount of microflora intestinal gas detected by the gas sensor able to detect microflora intestinal gas.

**[0015]** In another particular aspect of this exemplary embodiment, the method includes monitoring an amount of microflora intestinal gas associated with the patient before delivering a volume of nutrient to the patient to determine a baseline value of microflora intestinal gas for the patient. The method can further include determining the relative change in microflora intestinal gas associated with the patient from the baseline value after delivering a volume of nutrient to the patient and adjusting the volume of nutrient delivered to the patient based at least in part on the relative change in microflora intestinal gas from the baseline value.

**[0016]** While the majority of people produce hydrogen gas when digesting food, there are a small percentage of people who do not, i.e. the "non-hydrogen producers". This is due, in part, to the microbial make up of their gut flora. However, all people produce and exhale methane gas. A system that monitors the concentration levels of methane exhaled, or more preferably both hydrogen and methane gases exhaled, would allow a universal monitoring device that could be used for all people. The breath analysis unit as shown in FIG. 2 is a good example of an embodiment that measure both hydrogen and methane breath gases simultaneously. Based on the levels of methane gas present, one could determine if a person was receiving enough nutrition, receiving too much nutrition or receiving just the right amount of nutrition.

**[0017]** For example, normal methane gas levels before eating (fasting/malnourished) would exhibit a methane range of from about 5 to about 15 ppm. After eating, a normal methane range would be from about 20 to about 60 ppm. If a person is overfed, (danger of vomiting or diarrhea or pulmonary aspiration) methane levels would be from about 60ppm or above. For people who produce both hydrogen and methane, the nutritional digestion process could also be monitored via the sum of both gases which shows a linear dose-effect relationship "Breath hydrogen and methane expiration in men and women after oat extract consumption," Behall, K.M., Scholfield, D.J., van der Sluijs, A.M.C., Hallfrisch, J., 128 J. Nutrition 79-84 (1998). In still another particular aspect of this exemplary embodiment, delivering a volume of nutrient to the patient with the feeding device includes intermittently delivering the nutrient to the patient. Adjusting the volume of nutrient delivered to the patient can include providing

nutrient to the patient with the feeding device when the amount of microflora intestinal gas associated with the patient is less than a first threshold value. When detecting levels of hydrogen gas, for example, nutrients can be provided to a patient intermittently when the levels are less than the threshold value in the range of about 5 ppm to about 25 ppm, such as about 10 ppm to about 20 ppm, such as about 20 ppm, or any other hydrogen gas concentration therebetween) and stopping delivery of nutrient to the patient when the amount of hydrogen gas associated with the patient is greater than a second threshold value (such as greater than a threshold value in the range of about 65 ppm to about 85 ppm, such as about 75 ppm to about 80 ppm, such as about 80 ppm, or any other hydrogen gas concentration therebetween). When detecting levels of methane gas, for example, nutrients can be provided to a patient intermittently when the levels are less than a first threshold value (such as less than threshold value in the range of about 3 ppm to about 20 ppm, such as about 5 ppm to about 15 ppm, such as about 15 ppm, or any other methane gas concentration therebetween) and stopping delivery of nutrient to the patient when the amount of hydrogen gas associated with the patient is greater than a second threshold value (such as greater than a threshold value in the range of about 55 ppm to about 65 ppm, such as about 60 ppm, or any other hydrogen gas concentration therebetween).

**[0018]** In still a further aspect of this exemplary embodiment, delivering a volume of nutrient to the patient with the feeding device includes continuously delivering the nutrient to the patient. Adjusting the volume of nutrient delivered to the patient can include increasing the initial feeding rate if the detected amount of microflora intestinal gas is less than a first threshold value. When detecting levels of hydrogen gas, for example, nutrients can be provided to a patient continuously when the levels are in the range of about 5 ppm to about 25 ppm, such as about 10 ppm to about 20 ppm, such as about 20 ppm, or any other hydrogen gas concentration therebetween), maintaining the initial feeding rate substantially constant if the detected amount of hydrogen is greater than the first threshold value and less than a second threshold value (such as a threshold value in the range of about 65 ppm to about 85 ppm, such as about 75 ppm to about 80 ppm, such as about 80 ppm, or any other hydrogen gas concentration therebetween), and decreasing the initial feeding rate if the detected amount of hydrogen gas is greater than the second threshold value. When detecting levels of methane gas, for example, nutrients can be provided to a patient continuously when the levels are less than a first threshold value (such as a threshold value in the range of about 3 ppm to about 20 ppm, such as about 5 ppm to about 15 ppm, such as about 15 ppm, or any other methane gas concentration therebetween), maintaining the initial feeding rate substantially constant if the detected amount of hydrogen/methane is greater than the first threshold value and less than a second threshold value (such as a threshold value in the range of about

55 ppm to about 65 ppm, such as about 60 ppm, or any other methane gas concentration therebetween), and decreasing the initial feeding rate if the detected amount of methane gas is greater than the second threshold value.

**[0019]** In further particular aspects of this exemplary embodiment, monitoring an amount of microflora intestinal gas associated with the patient can include monitoring a concentration of microflora intestinal gas in the patient's breath, such as monitoring a concentration of microflora intestinal gas in the exhaled breath of the patient. Alternatively, monitoring an amount of microflora intestinal gas associated with the patient can include monitoring a concentration of microflora intestinal gas in the patient's digestive tract, such as in the patient's stomach or small intestine.

**[0020]** Another exemplary embodiment of the present disclosure is directed to a system for monitoring artificial feeding of a patient. The system includes a feeding device, such as an enteral feeding device, configured to deliver nutrient to a patient at an initial feeding rate; a gas sensor able to detect microflora intestinal gas configured to monitor an amount of microflora intestinal gas associated with the patient; and a controller configured to adjust the volume of nutrient delivered to the patient based at least in part on the amount of microflora intestinal gas associated with the patient.

**[0021]** In a particular aspect of this exemplary embodiment, the microflora intestinal gas sensor includes a sensor configured to monitor the exhaled breath of the patient. For instance, the sensor can be a stand-alone breathalyzer sensor device or can be included on a ventilator tube used by the patient.

**[0022]** In another particular aspect of this exemplary embodiment, the feeding device includes an enteral feeding tube having a distal end inserted into the digestive tract of the patient and an outside end coupled to a nutrient source. In one implementation, the microflora intestinal gas sensor can be located at the distal end of the feeding tube such that the microflora intestinal gas sensor monitors an amount of microflora intestinal gas in the stomach of the patient or in the small intestine of the patient. In another implementation, the microflora intestinal gas sensor can be located at or near the outside end of the enteral feeding tube.

**[0023]** In still another particular aspect of this exemplary embodiment, the system can include an alert system configured to alert a care giver based at least in part on the amount of microflora intestinal gas detected by the microflora intestinal gas sensor. For instance, the alert system can provide an alert to a care giver if the amount of microflora intestinal gas associated with the patient is less than or greater than a particular threshold value. The alert can be an audible, visual, vibratory, wireless, or other suitable alert.

**[0024]** A further exemplary embodiment of the present disclosure not part of the present invention is directed to a system for specifically monitoring nutritional uptake of an infant. The system can include a microflora intestinal

gas sensor configured to monitor an amount of microflora intestinal gas associated with the exhaled breath of the infant and an electronic circuit coupled to the microflora intestinal sensor. The electronic circuit can be configured to provide an alert, such as an audible, visual, vibratory, or wireless alert, to a care giver based at least in part on the amount of microflora intestinal gas detected by the microflora intestinal gas sensor. For instance, the electronic circuit can be configured to provide an alert when the amount of microflora intestinal gas detected by the microflora intestinal gas sensor is less than a threshold value. In a particular implementation of this exemplary embodiment, the microflora intestinal gas sensor can be incorporated into or can be located on an oral infant device such as a pacifier, bottle or the like device used by the infant. Due to ease, the present invention prefers the use of a pacifier. However, the ease of use for the present invention, does not limit the present method to a pacifier when an infant is involved. Other devices include, but are also not limited to, bottles, thermometers, teething rings, and the like that may be used to detect the amount of microflora intestinal gases of an infant.

**[0025]** Still a further exemplary embodiment of the present disclosure not part of the present invention is directed to a method for monitoring nutritional uptake for an infant. The method includes monitoring an amount of microflora intestinal gas level in the exhaled breath of the infant using a microflora intestinal sensor; comparing the amount of microflora intestinal gas with a threshold value; and providing an alert if the amount of microflora intestinal gas is less than the threshold value.

**[0026]** The present disclosure is generally directed to methods and systems for real-time monitoring of nutritional uptake as a function of microflora intestinal gas generated in the digestive tract. While the present disclosure generally discusses the monitoring and regulation of nutritional uptake in artificially fed patients, those of ordinary skill in the art, using the disclosures provided herein, should understand that the methods and systems of the present disclosure are applicable to any situation where the nutritional uptake of a person needs to be monitored. For instance, the systems and methods of the present disclosure can be used to monitor nutritional uptake of an infant.

**[0027]** A connection exists between microflora intestinal gas concentration in the small intestine, stomach, and breath and the absorption of nutrients in the human body. "Who should request a breath hydrogen test" Li, D-Y, Barnes, T., Thompson, R.E., Cuffari, C., *Journal of Applied Research*, 4(2), 266 (2004); "Hydrogen breath testing in adults," Lindberg, D.A., *Gastroenterology Nursing*, 32(1), 19-24 (2009); "Antibiotic efficacy in small intestinal bacterial overgrowth." Attar, A., Flourie, B., Rambaud, J-C., Frachisseur, C., Ruszniewski, P., Bouhnik, Y., *Gastroenterology*, 117(4), 794-797 (1999).

**[0028]** Hydrogen gas and methane gas is produced by the microflora present in the intestine as the microflora break down carbohydrates for absorption through the in-

testine wall. In addition, it has been shown that an increase in the concentration of hydrogen gas correlates to an increase in blood glucose when being fed a specific dose of carbohydrate. "Breath hydrogen and methane excretion patterns in normal man and in clinical practice," Tadesse, K., Smith, D., Eastwood, M.A., *65 Quarterly Journal of Experimental Physiology*, 85-97 (1980); "Use of breath hydrogen in the study of carbohydrate absorption," Bond, J.H., Levitt, M.D., *Digestive Diseases*, 22(4), 379-382 (1997); "Breath hydrogen and methane expiration in men and women after oat extract consumption," Behall, K.M., Scholfield, D.J., van der Sluijs, A.M.C., Hallfrisch, J., *128 J. Nutrition* 79-84 (1998). Because of the correlation between microflora intestinal gas concentration and nutritional uptake, target ranges for microflora intestinal gas in the breath and/or digestive tract can be developed to inform a care giver that a patient is malnourished, being fed at the correct rate, or being fed too much and is in danger of vomiting or diarrhea.

**[0029]** A microflora intestinal gas sensor can be used to monitor the concentration of microflora intestinal gas in a patient's exhaled breath or in the patient's digestive tract. In fact, the present invention utilizes a microflora intestinal gas sensor for monitoring a concentration of microflora intestinal gas from areas that may expel microflora intestinal gas from the body. Such areas may be selected from the patient's breath, the patient's digestive tract, or the combinations thereof. Signals received from the microflora intestinal gas sensor can be compared to threshold values to alert a caregiver that the volume of nutrient being provided to the patient needs to be increased, decreased, or maintained substantially constant. In addition, the signals received from the microflora intestinal sensor can be used as part of a feedback control loop to control a feeding system to increase, decrease, or maintain the feeding rate as appropriate. In this manner, the methods and systems of the present disclosure can be used to provide real-time monitoring and regulation of nutritional uptake in, for instance, artificially fed patients, infants, and other suitable individuals.

#### Microflora intestinal gas sensors

**[0030]** Gas sensors suitable for providing real-time monitoring and regulation of nutritional uptake of the present invention may be any device suitable for detecting expelled microflora intestinal gases. Without being limited by theory, sensors such as the Optical nose (O-nose), developed by Pranalytica, for example is capable of measuring gases such as NO, NO<sub>2</sub>, NH<sub>3</sub>, SO<sub>2</sub> and CH<sub>4</sub>. Accordingly, this optical device could be designed for the detection microflora intestinal gas concentrations from the expired breath. Additionally, City Technology offers various industrial as well as medical grade hydrogen sensors that may also be suitable to carry out the present invention. Further, a sensors system has been developed by Costello et al to monitor various VoCs in exhaled breath as shown in FIG. 6. The sensors are

based on electrochemical gas sensors such as hydrogen, CO, H<sub>2</sub>S, ethanol, and ammonia. Finally, Argonne National Lab has developed palladium nanobeads for a fast as well as sensitive hydrogen detection particularly for fuel cell applications. This nanosensor shows high selectivity and could detect H<sub>2</sub> in presence of oxygen, humidity and other gases. These and other similarly functioning devices capable of detecting the microflora intestinal gas concentration levels may be used and/or designed to carry out the methods of the present invention.

**[0031]** Microflora present in the intestine is able to produce gases such as carbon dioxide, oxygen, nitrogen, hydrogen, ammonia, acetone and methane as the microflora break down carbohydrates for absorption through the intestine wall. Methods of the present invention are able to detect the levels of such gases in order to aid in monitoring nutritional uptake. Specifically, methods of the present invention may comprise monitoring the levels of microflora intestinal gases produced by a patient. Methods of the present invention may further comprise the monitoring of microflora intestinal concentrations. Illustrations included herein, show, for example, concentrations of hydrogen gas. Again, it is understood that while the illustrations of the present specification show hydrogen gas concentration, the same figures could be depicted for all microflora intestinal gas concentrations.

**[0032]** Exemplary regulation of nutritional uptake based on hydrogen gas concentration is illustrated in FIG. 1. FIG. 1 depicts two hydrogen concentration thresholds X1 and X2. Thresholds X1 and X2 are determined such that hydrogen gas concentrations of less than threshold X1 indicate that the patient is malnourished and hydrogen gas concentrations of greater than threshold X2 indicate that the patient is being overfed. Hydrogen gas concentrations greater than X1 and less than X2 indicate that the patient is receiving an ideal amount of nutrition.

**[0033]** FIG. 1 illustrates two hypothetical curves 20, 30 of hydrogen gas concentration over time. Curve 20 is associated with continuous artificial feeding of a patient over time. Curve 30 is associated with intermittent artificial feeding of a patient over time. As illustrated in FIG. 1, with proper monitoring provided by the systems and methods of the present disclosure, the hydrogen gas concentration associated with curves 20 and 30 can be maintained between X1 and X2 such that the patient is receiving an ideal amount of nutrition. Should the curves 20, 30 ever fall below threshold X1 or exceed threshold X2, the systems and methods of the present disclosure could alert a care giver that the patient is not receiving the proper amount of nutrition. In addition, the volume of nutrient provided to the patient can be adjusted such that the proper amount of nutrient is provided to the patient.

**[0034]** For example, FIG. 2 illustrates an exemplary method 200 for monitoring nutritional uptake based on hydrogen gas concentration according to an exemplary embodiment of the present disclosure not part of the present invention. The method 200 can be used to cali-

brate an artificial feeding system or to determine whether the initial feeding rate of nutrient provided by the artificial feeding system is sufficient to provide adequate nutrition to the patient.

**[0035]** As shown in FIG. 2 at 210, a baseline value of hydrogen gas associated with the patient is determined before any nutrient is delivered to the patient by the artificial feeding system. The baseline value of hydrogen gas can be determined using a hydrogen gas sensor as will be discussed in more detail below.

**[0036]** At 220, a volume of nutrient is delivered to the patient with the artificial feeding system at an initial feeding rate. As used herein, the term feeding rate is intended to refer to the rate nutrient is delivered to the patient with an artificial feeding system.

**[0037]** At 230, the hydrogen gas concentration associated with the patient is again monitored with the hydrogen gas sensor. Step 230 can be performed after sufficient passage of time, such as 15 minutes, to allow for adequate absorption of nutrients into the patient. At 240, the relative change in hydrogen gas concentration from the baseline value is determined, for instance, by subtracting the baseline value of hydrogen gas from the monitored hydrogen gas concentration.

**[0038]** At 250, the relative change in hydrogen gas concentration is compared to a threshold value. For instance, in a particular embodiment, the relative change in hydrogen gas can be compared to a first threshold value. The first threshold value can be set such that a relative change in hydrogen gas that falls below the first threshold value indicates that the patient is not receiving adequate nutrition. If the relative change in hydrogen gas concentration exceeds the first threshold value, the artificial feeding system is providing sufficient nutrition to the patient and no increase to the volume of nutrient being delivered to the patient is necessary.

**[0039]** As shown at 260, if the relative change in hydrogen gas concentration is less than the first threshold value, the patient is not receiving an adequate amount of nutrients from the feeding system and an alert, such as an audible, visual, vibratory, or wireless alert, is provided to a the care giver indicating to the care giver that the patient is not receiving adequate nutrition. At 270, the volume of nutrient delivered to the patient is increased, for instance, by increasing the initial feeding rate of the feeding device. The volume of nutrient can be manually increased by the care giver upon receiving the alert or can be increased automatically by a control loop that adjusts the feeding rate of the artificial feeding system based on the hydrogen gas levels associated with the patient. In this way, the method 200 adjusts the volume of nutrient delivered to the patient based on the amount of hydrogen gas associated with the patient and provides for regulation of the amount of nutrient delivered to the patient based on hydrogen gas concentration levels.

**[0040]** In a variation or in addition to the exemplary method illustrated in FIG. 2, the relative change in hy-

drogen gas can be compared to a second threshold value. The second threshold value can be set such that a relative change in hydrogen gas that exceeds the second threshold value indicates that the patient is receiving too much nutrition. If the relative change in hydrogen gas concentration is greater than the second threshold value, the patient is receiving too much nutrient and is in danger of vomiting and/or diarrhea. An alert, such as an audible, visual, vibratory, or wireless alert, can be provided to a the care giver indicating to the care giver that the patient is receiving too much nutrition. The volume of nutrient delivered to the patient can then be decreased, for instance, by decreasing the initial feeding rate of the feeding device.

**[0041]** FIG. 3 illustrates another exemplary method 300 not part of the present invention associated with monitoring nutritional uptake based on hydrogen gas concentration associated with a patient. The method 300 can be used to monitor and regulate the intermittent feeding of the patient with an artificial feeding system. In particular, the method 300 can be used to determine the start and stop times for intermittent feeding of the patient with the artificial feeding system.

**[0042]** At 310, a volume of nutrient is delivered to the patient at an initial feeding rate. The volume of nutrient can be delivered by an enteral feeding system. At 320, the hydrogen gas concentration associated with the patient is monitored using a hydrogen gas sensor. For instance, a hydrogen gas sensor can be used to monitor the amount of hydrogen gas in the patient's exhaled breath or in the patient's digestive tract.

**[0043]** At 330, the hydrogen gas concentration is compared to a first threshold value, such as first threshold value T1 illustrated in FIG. 4. The first threshold value can be, for instance, in the range of about 5 ppm to about 25 ppm, such as about 10 ppm to about 20 ppm, such as about 20 ppm, or any other hydrogen gas concentration therebetween. If the hydrogen gas concentration is less than first threshold value, the patient is in need of additional nutrition. Accordingly, referring back to FIG. 3, an alert can be provided to the care giver from an alert system as shown at 340. In addition, the volume of nutrient delivered to the patient from the feeding system can be increased as shown 350 to accommodate the patient's need for additional nutrition. A care giver can manually increase the volume of nutrient delivered to the patient, or a control loop can automatically adjust feeding system parameters to increase the volume of nutrition delivered to the patient. After increasing the volume of nutrient delivered to the patient, the method 300 returns to 320 and continuously monitors the hydrogen gas associated with the patient to determine if the patient is receiving too little, an ideal amount, or too much nutrition.

**[0044]** At 360, the hydrogen gas concentration is compared to a second threshold, such as threshold T2 illustrated in FIG. 4. Second threshold, for instance, can be in the range of about 65 ppm to about 85 ppm, such as about 75 ppm to about 80 ppm, such as about 80 ppm,

or any other hydrogen gas concentration therebetween. If the hydrogen gas concentration is less than the second threshold value, but greater than the first threshold, the patient is receiving an ideal amount of nutrition. Thus, no adjustments to the feeding system are necessary and the method 300 continues to monitor hydrogen gas concentrations associated with the patient.

**[0045]** If the hydrogen gas concentration exceeds the second threshold value, the patient is receiving too much nutrition and is in danger of vomiting or diarrhea. An alert can be provided to the care giver from an alert system as shown at 370. To prevent overfeeding, the method 300 will stop delivering nutrient to the patient and will continue to monitor hydrogen gas associated with the patient as shown at 380. When the hydrogen gas levels fall below the first threshold, the method 300 will begin delivering nutrient to the patient again to prevent the patient from becoming malnourished.

**[0046]** FIG. 4 provides a graphical illustrated of hydrogen gas concentration levels associated with a patient that is being intermittently fed according to the method 300 of FIG. 300. As illustrated, the hydrogen gas level associated with the patient increases past threshold T1 as the artificial feeding system delivers a volume of nutrient to the patient. As the patient is fed, the hydrogen gas levels may approach threshold T2. If the hydrogen gas level associated with the patient exceeds threshold T2, the artificial feeding system stops delivering nutrient to the patient. This causes the hydrogen gas levels associated with the patient to decrease until the hydrogen gas levels drop below threshold T1. The artificial feeding system then again delivers nutrient to the patient, causing an increase in hydrogen gas concentration associated with the patient.

**[0047]** FIG. 5 illustrates another exemplary method 500 not part of the present invention associated with monitoring nutritional uptake based on hydrogen gas concentration associated with a patient. The method 500 can be used to monitor and regulate the continuous feeding of the patient with an artificial feeding system. The method 500 is similar to the method 300 of FIG. 3, except the method 500 adjusts the feeding rates of the artificial feeding system as opposed to the start and stop times associated with the delivery of nutrition to the patient. This ensures that nutrient is continuously delivered to the patient at an ideal feeding rate to prevent malnourishment and overfeeding.

**[0048]** For instance, at 510 a volume of nutrient is delivered to the patient at an initial feeding rate. The volume of nutrient can be delivered by an enteral feeding system.

**[0049]** At 520, the hydrogen gas concentration associated with the patient is monitored using a hydrogen gas sensor. For instance, a hydrogen gas sensor can be used to monitor the amount of hydrogen gas in the patient's exhaled breath or in the patient's digestive tract.

**[0050]** At 530, the hydrogen gas concentration is compared to a first threshold value, such as a threshold value in the range of about 5 ppm to about 25 ppm, such as

about 10 ppm to about 20 ppm, such as about 20 ppm, or any other hydrogen gas concentration therebetween. If the hydrogen gas concentration is less than first threshold value, the patient is in need of additional nutrition. Accordingly, an alert can be provided to the care giver from an alert system as shown at 540. In addition, the initial feeding rate of the feeding system can be increased to accommodate the patient's need for additional nutrition as shown at 550. A care giver can manually increase the initial feeding rate, or a control loop can automatically adjust feeding system parameters to increase the initial feeding rate delivered to the patient. After increasing the initial feeding rate delivered to the patient, the method 500 returns to 520 and continuously monitors the hydrogen gas associated with the patient to determine if the patient is receiving too little, an ideal amount, or too much nutrition.

**[0051]** At 560, the hydrogen gas concentration is compared to a second threshold, such as a threshold value in the range of about 65 ppm to about 85 ppm, such as about 75 ppm to about 80 ppm, such as about 80 ppm, or any other hydrogen gas concentration therebetween. If the hydrogen gas concentration is less than the second threshold value, but greater than the first threshold, the patient is receiving an ideal amount of nutrition. Thus, no adjustments to the feeding system are necessary and the method 500 continues to monitor hydrogen gas concentrations associated with the patient.

**[0052]** If the hydrogen gas concentration exceeds the second threshold value, the patient is receiving too much nutrition and is in danger of vomiting or diarrhea. An alert can be provided to the care giver from an alert system as shown at 570. At 580 to prevent overfeeding, the method 500 will decrease the initial feeding rate and will continue to monitor hydrogen gas associated with the patient. When the hydrogen gas level fall below the first threshold, the method 500 will increase the initial feeding rate to prevent the patient from becoming malnourished.

**[0053]** With reference to FIG. 6, an exemplary system 100 for carrying out the methods disclosed above will now be discussed in detail. As illustrated in FIG. 6, the system 100 includes a controller 110, a hydrogen gas sensor 120, a feeding system 130, a user interface 140, and an alert system 150. Feeding system 130 can be any system used to deliver nutrient to a patient, such as an enteral feeding system. For instance, in a particular embodiment, feeding system 130 can include an enteral feeding tube 135 (illustrated in FIG. 7 and FIG. 8) having a distal end inserted into the digestive tract of a patient and a nutrient source. The enteral feeding tube can be inserted into the patient either through the stomach wall of the patient or down the patient's nose or throat. Nutrient is delivered to the patient through enteral feeding tube 135 from the nutrient source at an initial feeding rate controlled by controller 110.

**[0054]** Controller 110 is configured to control feeding system 130 based on signals received from hydrogen gas sensor 120 to ensure that feeding system 130 deliv-

ers a proper amount of nutrition to a patient. Controller 110 can be any suitable control device, and can include, for instance, a microcontroller or other control circuitry. User interface 140 can be coupled to controller 110. User interface 140 can be adapted to receive instructions through various peripheral devices from a user. For instance, a user can input commands or other data into user interface 140 through a keyboard, touch-screen, mouse, or other suitable input device. User interface 140 can display data and other information associated with system 100 to a user through a visual display, media element, or other suitable output device.

**[0055]** Controller 110 is coupled to an alert system 150. Controller 110 is configured to control alert system 150 to provide an alert to a care giver based on hydrogen gas levels associated with the patient. For instance, if controller 110 determines that the hydrogen gas level associated with a patient is less than a threshold value, the controller 110 can control alert system 150 to provide an alert to a care giver indicating that the care giver is in need of additional nutrition. The alert can be a visual alert, audible alert, vibratory alert, wireless alert, or other suitable alert.

**[0056]** Hydrogen gas sensor 120 is configured to monitor hydrogen gas levels associated with the patient. Hydrogen gas sensor 120 can be any device that can monitor the hydrogen gas levels generated in a patient's digestive tract as a result of nutritional uptake of the patient.

**[0057]** In a particular embodiment, the hydrogen gas sensor 120 is configured to monitor hydrogen gas in the patient's exhaled breath. The hydrogen gas sensor 120 can be a breathalyzer sensor such as the HBT Sleuth sensor manufactured by Bedford Scientific Ltd. Other suitable sensors include gas chromatography mass spectroscopy (GC-MS) and direct mass spectroscopy sensors that analyze the chemical composition of a collected gas sample. The hydrogen sensor 120 can be a stand-alone breathalyzer sensor that a patient breathes into periodically or can be incorporated as part of a ventilator tube for a patient that is using a ventilator system.

**[0058]** The very small size of certain hydrogen gas sensors can make them suitable for incorporation into an enteral feeding system for monitoring hydrogen gas in a patient's digestive tract. In this regard, the hydrogen gas sensor 120 can be included as part of an enteral feeding system that delivers nutrition to a patient's digestive tract.

**[0059]** For instance, as illustrated in FIG. 7, the hydrogen gas sensor 120 can be included on the distal end of enteral feeding tube 135. As illustrated in FIG. 7, the hydrogen gas sensor 120 is located in the stomach 182 of patient 180. Alternatively, the hydrogen gas sensor 120 could be located in the small intestine 184 of patient 180. The hydrogen gas sensor 120 monitors hydrogen gas levels contained in stomach 182 or small intestine 184 and communicates signals associated with the hydrogen gas levels to controller 110 over communications link 125. Communications link 125 can be a hardwired communication link, such as an optical communication link

125 or other suitable hardwired communication link. Alternatively, hydrogen gas sensor 120 can be configured to communicate wirelessly with controller 120.

**[0060]** Various hydrogen sensors are suitable for use as hydrogen gas sensor 120 located at the distal end of enteral feeding tube 135. For instance, hydrogen gas sensor 120 can be an Optical nose (O-nose) sensor developed by Pranalytica; one of various medical grade sensors manufactured by City Technology, including the model 3HYT, 3MHYT, 4HYT, 7HYE, 7HYT, EZT3HYE, or EZT3HYT sensors; or palladium nanobeads manufactured by Argonne National Laboratories.

**[0061]** Other nanosensors, such as, for example, ZnO nanorod hydrogen sensors developed at University of Florida (Lupan O et al., 2009; "Selective hydrogen gas nanosensors using individual ZnO nanowire with fast response at room temperature," Sensors and Actuators B Chemical); titanium nanotubes developed at Penn State (Varghese O.K., et al., 2003; "Hydrogen sensing using titania nanotubes," Sensors and Actuators, B93, pp 338-344); and/or the nanoflowers (Shafiei M et al., 2010, "Pt/MoO<sub>3</sub> nano-flower SiC Schottky diode based hydrogen gas sensors," Prof of IEEE Sensors Conf. 2010, 354-357) could be used as hydrogen gas sensor 120. Oriented graphite nanostructure carbon films that have been employed as a chemiresistive sensor for ultra-sensitive gas sensor applications may also be suitable for hydrogen gas sensor 120 (Rivera I F et al., 2010; "Graphene based ultra-sensitive gas sensors;" Prof of IEEE Sensors Conf. 2010, 1543-37; Moafi A et al., 2010; "Oriented graphitic carbon films for hydrogen gas sensors," Prof of IEEE Sensors Conf. 2010, 378-381).

**[0062]** As illustrated in FIG. 8, hydrogen gas sensor 120 can alternatively be located on the outside end of enteral feeding tube 120, such as proximate a nutrient source for feeding system 130. The hydrogen gas sensor 120 monitors hydrogen gas levels contained in the digestive tract of the patient and communicates signals associated with the hydrogen gas levels to controller 110 over communications link 125.

**[0063]** Referring to FIG. 9, an exemplary system 400 for monitoring nutritional uptake of an infant is disclosed. The system includes electronic circuitry, such as controller 410 and alert system 430, and a hydrogen gas sensor 420 located as part of an oral infant device such as a pacifier, bottle or the like device. The hydrogen gas sensor 420 is configured to monitor an amount of hydrogen gas associated with the exhaled breath of the infant. The controller 410 monitors signals received from the hydrogen gas sensor 420 and controls alert system 430 to provide an alert based on the hydrogen gas level detected by the hydrogen gas sensor 420. The alert can be an audible alert, visual alert, vibratory alert, wireless alert, or other suitable alert.

**[0064]** For instance, in a particular embodiment, the hydrogen gas sensor 420 can monitor the amount of hydrogen gas in the exhaled breath of the infant. The controller 410 can receive signals from the hydrogen gas

sensor 420 and compare the detected the amount of hydrogen gas with a threshold value. The controller 420 can control the alert system to provide an alert 430 if the amount of hydrogen gas is less than the threshold value.

5 The alert can indicate to a parent or other care giver that the infant is need of additional nutrition and that it is time for feeding.

**[0065]** The exemplary system 400 can be used for instance, by a mother who is breast feeding an infant. A mother that is breast feeding an infant may be unsure whether the infant has received adequate nutrition. To determine if the infant has received adequate nutrition, the mother can monitor the exhaled breath of the infant using a hydrogen gas sensor 420, such as a hydrogen gas sensor incorporated as part of an oral infant device such as a pacifier, bottle or the like device used by the infant. The hydrogen gas levels can be compared to a threshold value and if the hydrogen gas levels associated with the infant are less than a threshold value, the system 400 can provide an alert through alert system 430 to the mother or other care giver indicating that the baby has not received sufficient nutrition. The mother can then continue breast feeding the infant until the infant has received adequate nutrition.

25

### Example

#### 1. Sensitivity of hydrogen gas sensor

30 **[0066]** A hydrogen gas sensor was purchased from Bedfont Scientific Inc., Rochester, Kent UK). The system was calibrated using background air (0ppm hydrogen) and with a sample cylinder containing 100ppm hydrogen gas (Microdirect Inc., Auburn ME). The gas stream was allowed to gently blow into the intake of the measure during a reading phase. The sensor measured 100ppm hydrogen.

35

#### 2. Monitoring breath hydrogen gas during the day/evening in a human subject

40

**[0067]** A healthy male subject (53yr old) measured his breath hydrogen during the day and evening hours to determine the changes due to feeding. The subject gently inhaled breath, held it for 20 seconds and then gently exhaled through his mouth into the sensor. The results are shown below:

45

5:30am - Breath hydrogen measured after fasting since 10pm the night before; 15ppm  
 Breakfast at 6:30am  
 7am - Breath hydrogen measured; 48ppm  
 11:30am - Breath hydrogen measured; 20ppm  
 Lunch at 11:40am  
 12noon - Breath hydrogen measured; 45ppm  
 1pm - Breath hydrogen measured; 55ppm  
 6pm - Breath hydrogen measured; 15ppm  
 Dinner at 7pm

55

8pm - Breath hydrogen measured; 64ppm

**[0068]** The above results show that breath hydrogen does correlate well to the nutritional uptake of the subject and also to when the subject is feeling hungry.

3. Experiment to model feeding tube with sensor at distal end inside stomach.

**[0069]** The Perspex model of the stomach and small intestine was used. To the distal end of an enteral feeding tube was attached the hydrogen gas sensor (taped) and this adapted tube was inserted into the stomach via a hole in the stomach wall. A cylinder of 100ppm hydrogen gas in air was then attached to the bottom of the small intestine tube of the model and a steady stream of gas introduced into the model. A hydrogen gas concentration was then measured by the sensor. The reading was 100ppm.

4. Experiment using an enteral feeding tube with hydrogen sensor at the outside of the tube (skin surface at the stomach).

**[0070]** The hydrogen sensor was mounted on the outside end of the enteral feeding tube where the tube end is on the outside of the stomach on the skin surface. Hydrogen gas at 100ppm was introduced into the stomach and small intestine via the small intestine tube. The hydrogen gas concentration of the gas exiting the tube was measured by the sensor and was found to be 100ppm.

**[0071]** These and other modifications and variations to the present invention may be practiced by those of ordinary skill in the art, without departing from the scope of the present invention, which is more particularly set forth in the appended claims. In addition, it should be understood that aspects of the various embodiments may be interchanged both in whole or in part. Furthermore, those of ordinary skill in the art will appreciate that the foregoing description is by way of example only, and is not intended to limit the invention so further described in such appended claims.

## Claims

1. A system for monitoring artificial feeding of a patient (180), the system comprising:

a feeding device (130) configured to deliver a volume of nutrient to a patient (180) at an initial feeding rate;

a microflora intestinal gas sensor (120) configured to monitor an amount of microflora intestinal gas associated with the patient; and  
a controller (110) configured to adjust the volume of nutrient delivered to the patient (180)

based at least in part on the amount of microflora intestinal gas associated with the patient.

2. The system of claim 1, wherein said feeding device (130) comprises an enteral feeding device having a distal end inserted in said patient and an outside end coupled to a nutrient source.

3. The system of claim 1, wherein said microflora intestinal gas sensor (120) comprises a sensor configured to monitor the exhaled breath of the patient (180).

4. The system of claim 2, wherein said microflora intestinal gas sensor (120) is located at the distal end of said enteral feeding tube (135).

5. The system of claim 1, wherein said microflora intestinal gas sensor (120) monitors an amount of microflora intestinal gas in areas selected from the stomach (182), the small intestine (184), of the patient (180).

6. The system of claim 2, wherein said microflora intestinal gas sensor (120) is located at the outside end of said enteral feeding tube (135).

7. The system of claim 1, wherein said system further comprises an alert system (150) configured to provide an alert to a caregiver based at least in part on the amount of microflora intestinal gas detected by said microflora intestinal gas sensor (120).

## Patentansprüche

1. System zur Überwachung der künstlichen Ernährung eines Patienten (180), wobei das System umfasst:

eine Ernährungsvorrichtung (130), ausgelegt zur Abgabe eines Nährstoffvolumens an einen Patienten (180) bei einer anfänglichen Ernährungsrate;

einen Gassensor (120) für die Darmmikroflora, ausgelegt zur Überwachung einer zu dem Patienten zugehörigen Gasmenge der Darmmikroflora; und

eine Steuerungsvorrichtung (110), ausgelegt zur Einstellung des an den Patienten (180) abgegebenen Nährstoffvolumens, basierend mindestens zum Teil auf der zu dem Patienten zugehörigen Gasmenge der Darmmikroflora.

2. System nach Anspruch 1, wobei die Ernährungsvorrichtung (130) eine enterale Ernährungsvorrichtung mit einem in den Patienten eingesetzten distalen Ende und einem an eine Nährstoffquelle gekoppeltes

Außenende umfasst.

3. System nach Anspruch 1, wobei der Gassensor (120) für die Darmmikroflora einen Sensor umfasst, der zur Überwachung der Ausatmung des Patienten (180) ausgelegt ist. 5
4. System nach Anspruch 2, wobei der Gassensor (120) für die Darmmikroflora sich beim distalen Ende des enteralen Ernährungstubus (135) befindet. 10
5. System nach Anspruch 1, wobei der Gassensor (120) für die Darmmikroflora eine Gasmenge der Darmmikroflora in Gebieten, ausgewählt aus dem Magen (182), dem Dünndarm (184) des Patienten (180), überwacht. 15
6. System nach Anspruch 2, wobei der Gassensor (120) für die Darmmikroflora sich beim Außenende des enteralen Ernährungstubus (135) befindet. 20
7. System nach Anspruch 1, wobei das System weiter ein Alarmsystem (150) umfasst, ausgelegt zur Bereitstellung eines Alarms für einen Pfleger, basierend mindestens zum Teil auf der von dem Gassensor (120) für die Darmmikroflora erfassten Gasmenge der Darmmikroflora. 25

## Revendications 30

1. Système de surveillance de l'alimentation artificielle d'un patient (180), le système comprenant :
  - un dispositif d'alimentation (130) configuré pour délivrer un volume de nutriment à un patient (180) à un débit d'alimentation initial ; 35
  - un capteur de gaz intestinaux de microflore (120) configuré pour surveiller une quantité de gaz intestinaux de microflore associée au patient ; et 40
  - un dispositif de commande (110) configuré pour ajuster le volume de nutriment délivré au patient (180) sur la base au moins en partie de la quantité de gaz intestinaux de microflore associée au patient. 45
2. Système selon la revendication 1, dans lequel ledit dispositif d'alimentation (130) comprend un dispositif d'alimentation entérale ayant une extrémité distale insérée dans ledit patient et une extrémité extérieure couplée à une source de nutriment. 50
3. Système selon la revendication 1, dans lequel ledit capteur de gaz intestinaux de microflore (120) comprend un capteur configuré pour surveiller la respiration exhalée du patient (180). 55

4. Système selon la revendication 2, dans lequel ledit capteur de gaz intestinaux de microflore (120) est situé à l'extrémité distale dudit tube d'alimentation entérale (135).
5. Système selon la revendication 1, dans lequel ledit capteur de gaz intestinaux de microflore (120) surveille une quantité de gaz intestinaux de microflore dans des zones choisies dans l'estomac (182), de l'intestin grêle (184) du patient (180).
6. Système selon la revendication 2, dans lequel ledit capteur de gaz intestinaux de microflore (120) est situé à l'extrémité extérieure dudit tube d'alimentation entérale (135).
7. Système selon la revendication 1, dans lequel ledit système comprend en outre un système d'alerte (150) configuré pour fournir une alerte à un soignant sur la base au moins en partie de la quantité de gaz intestinaux de microflore détectée par ledit capteur de gaz intestinaux de microflore (120).

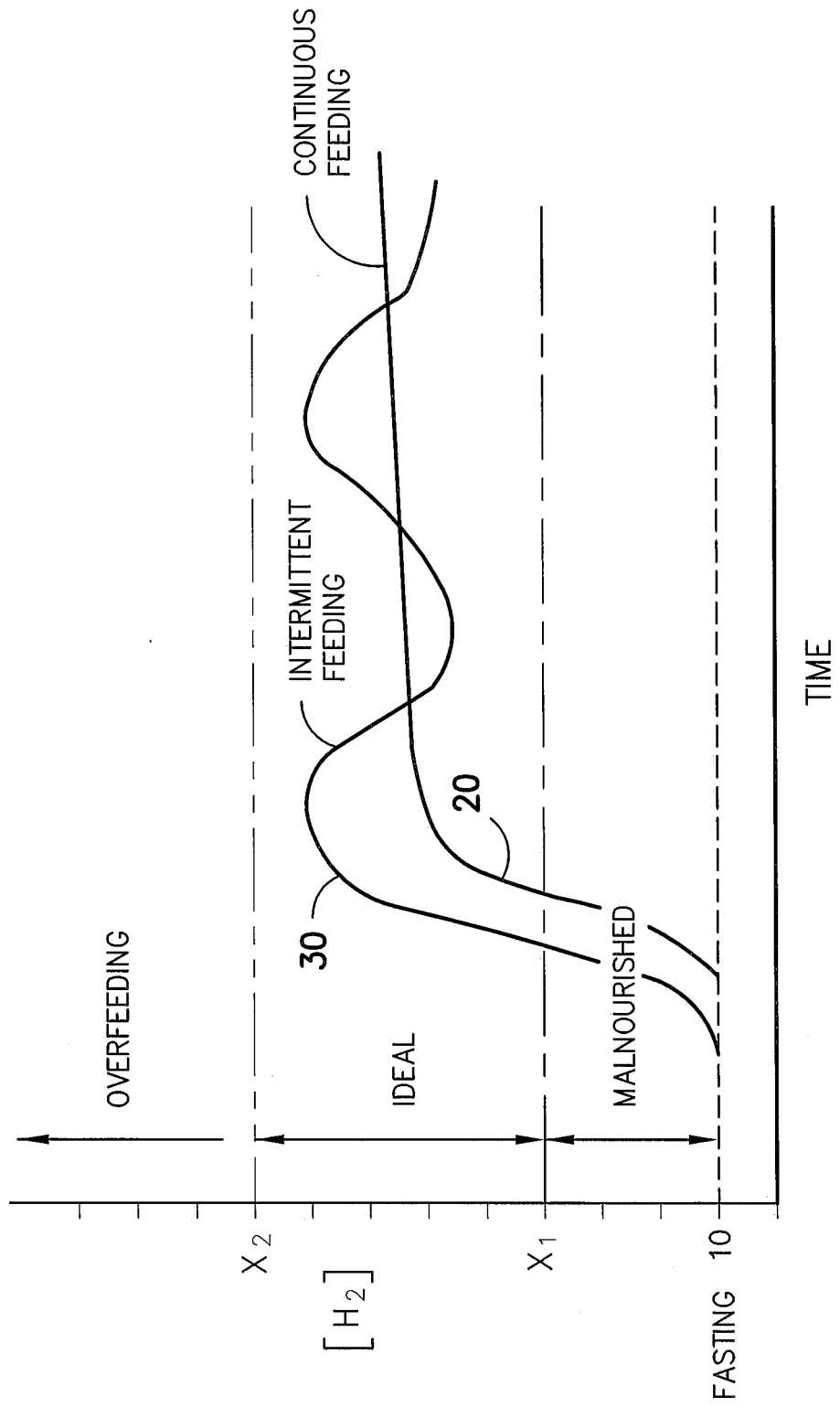

FIG. -1-

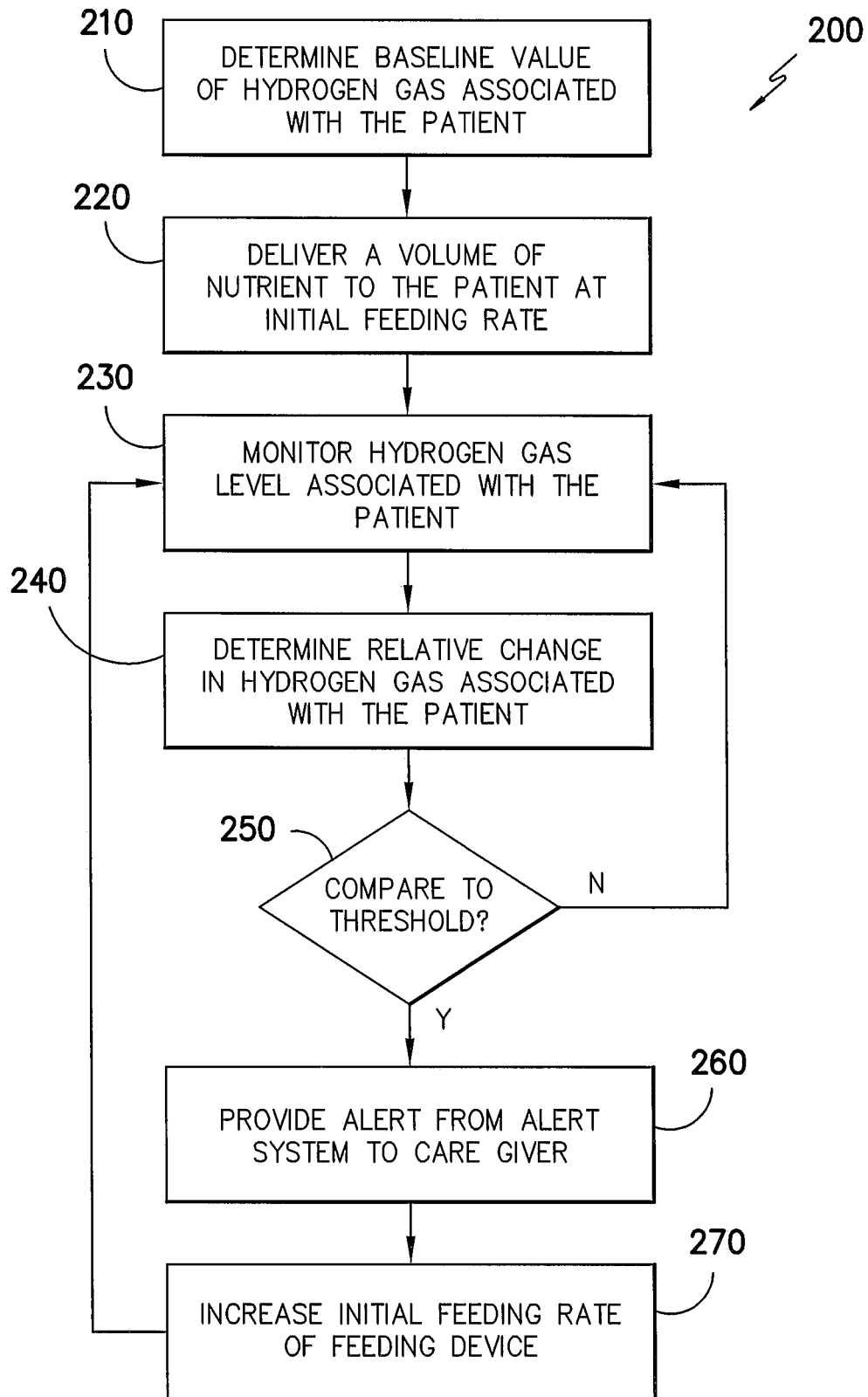

FIG. -2-

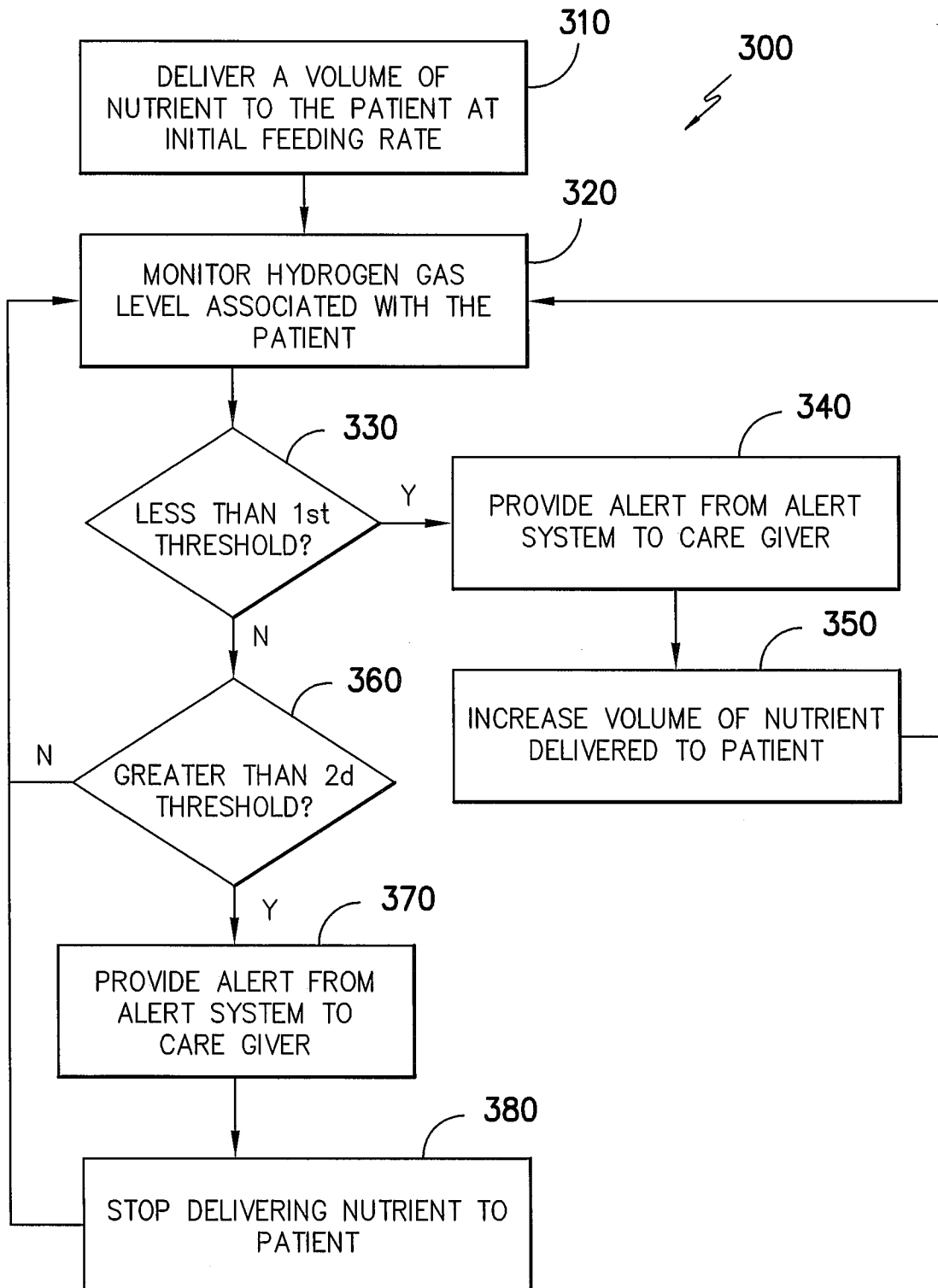
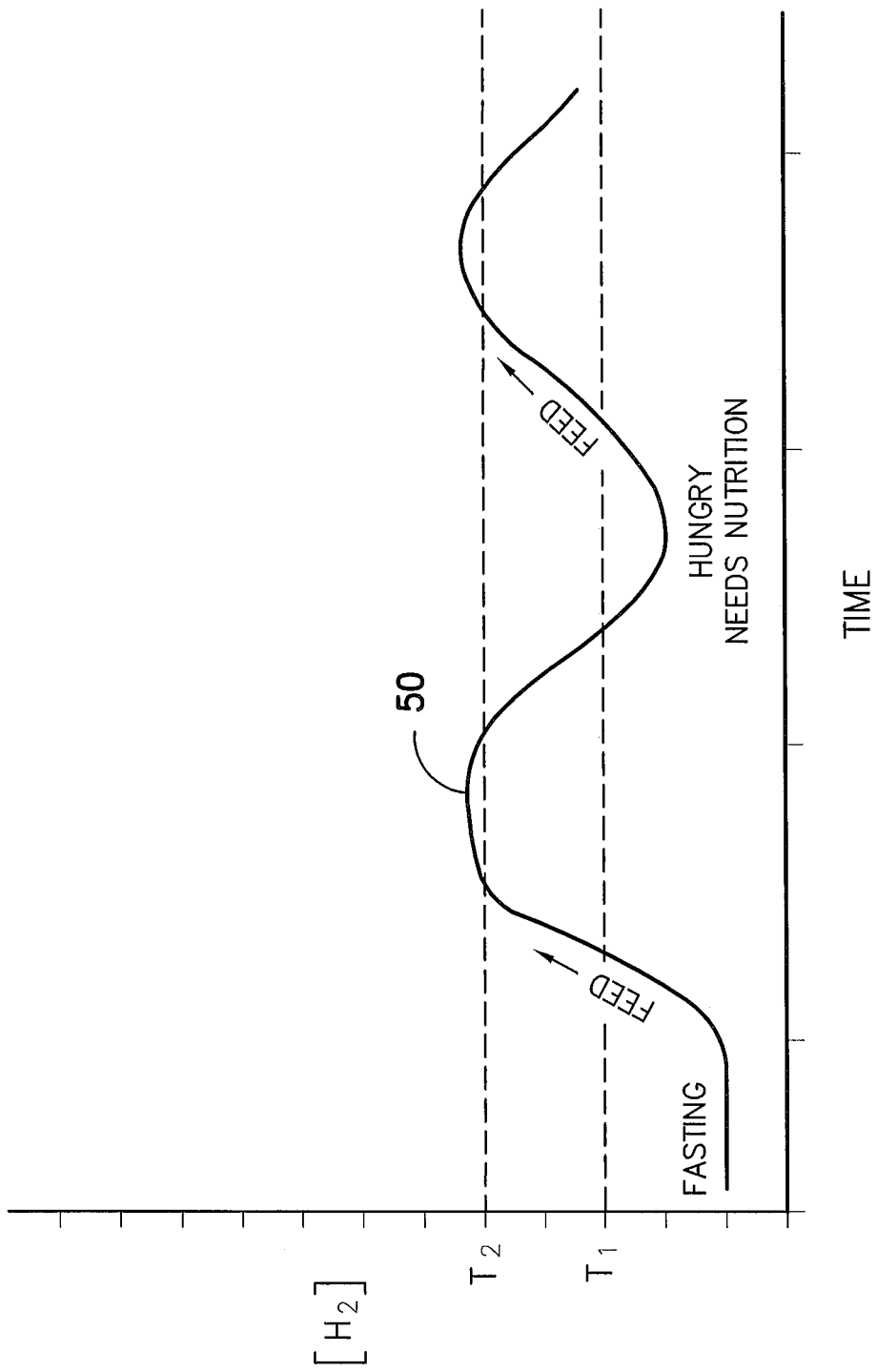
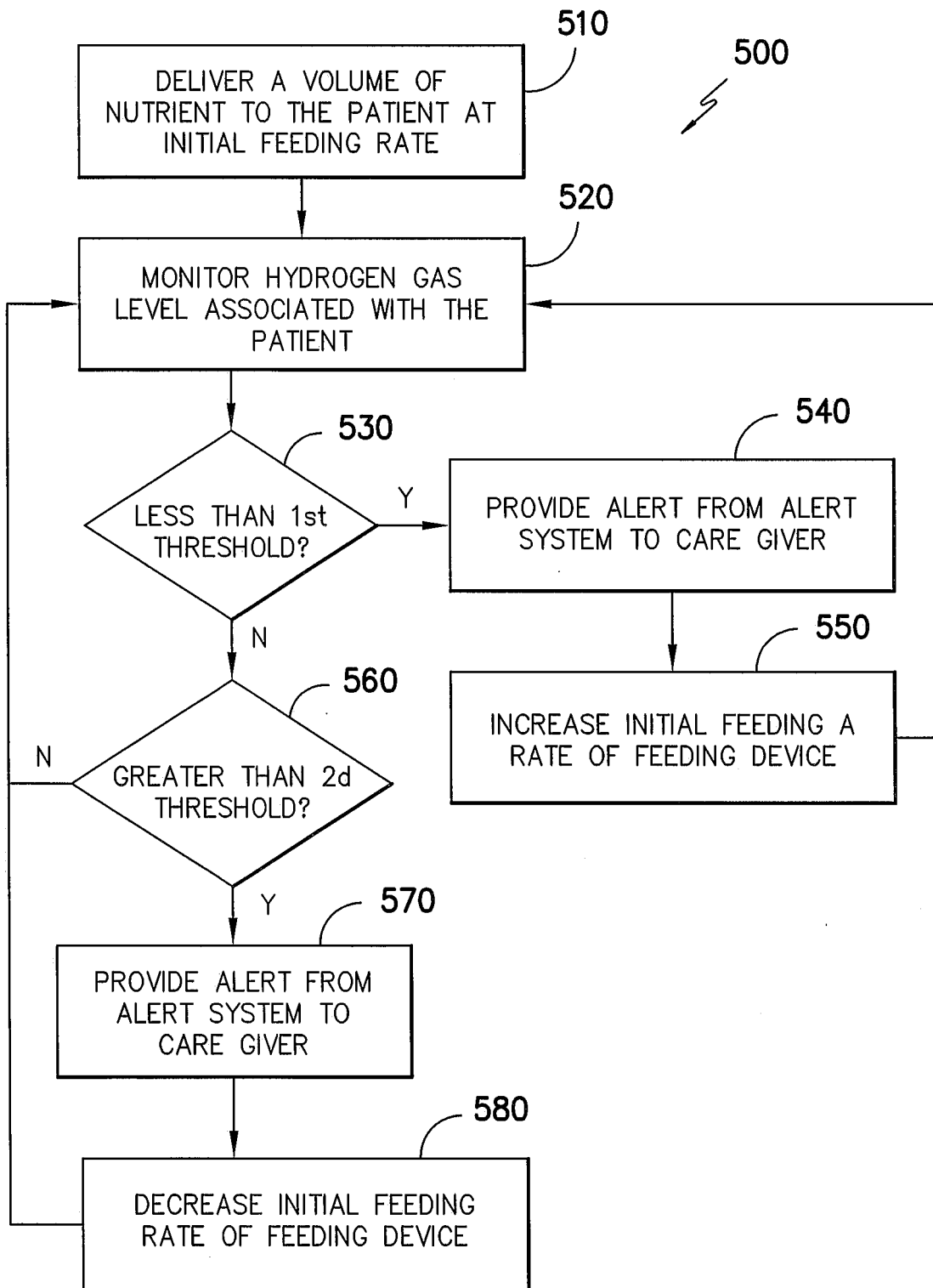

FIG. -3-



**FIG. -4-**



*FIG. -5-*

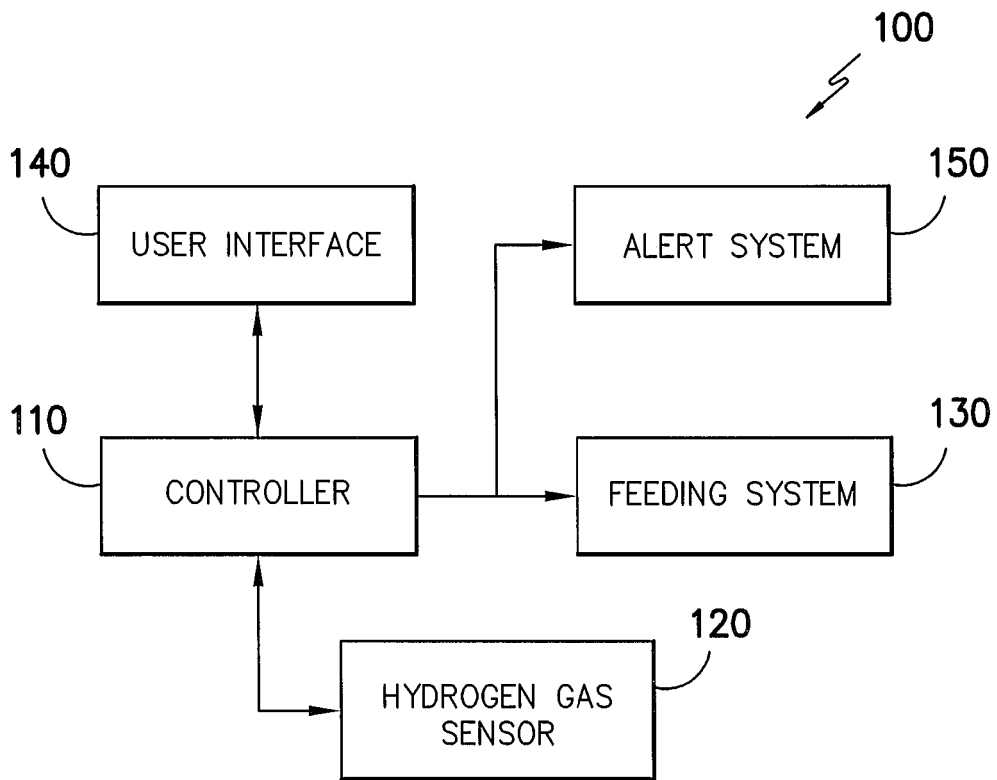

*FIG. -6-*

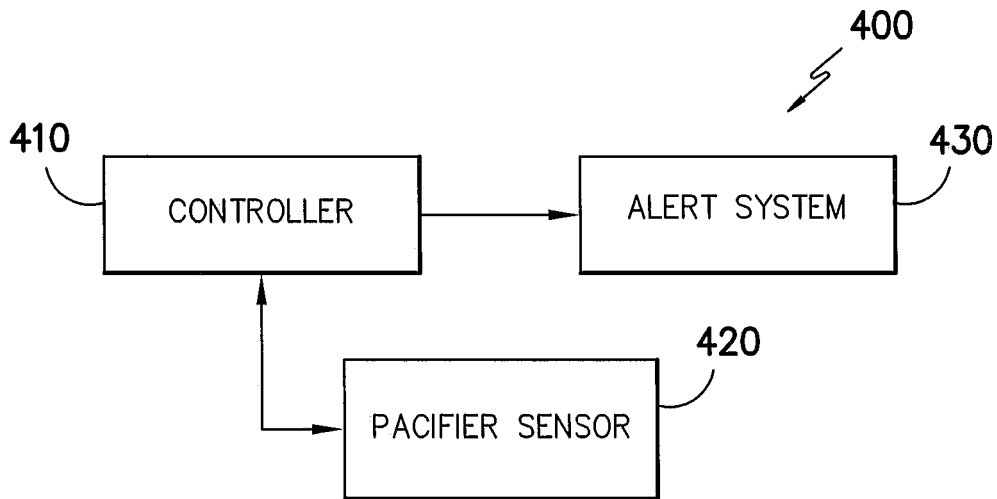

*FIG. -9-*

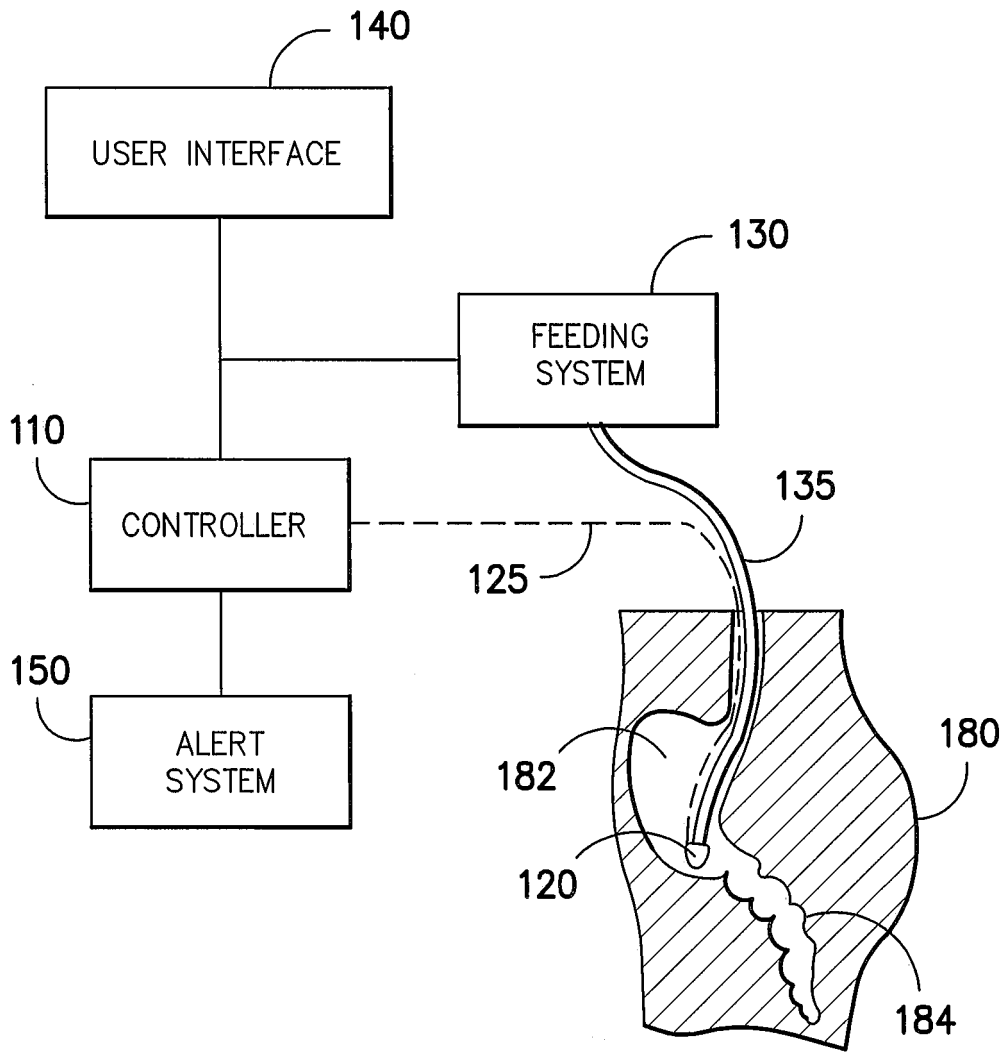

*FIG. -7-*

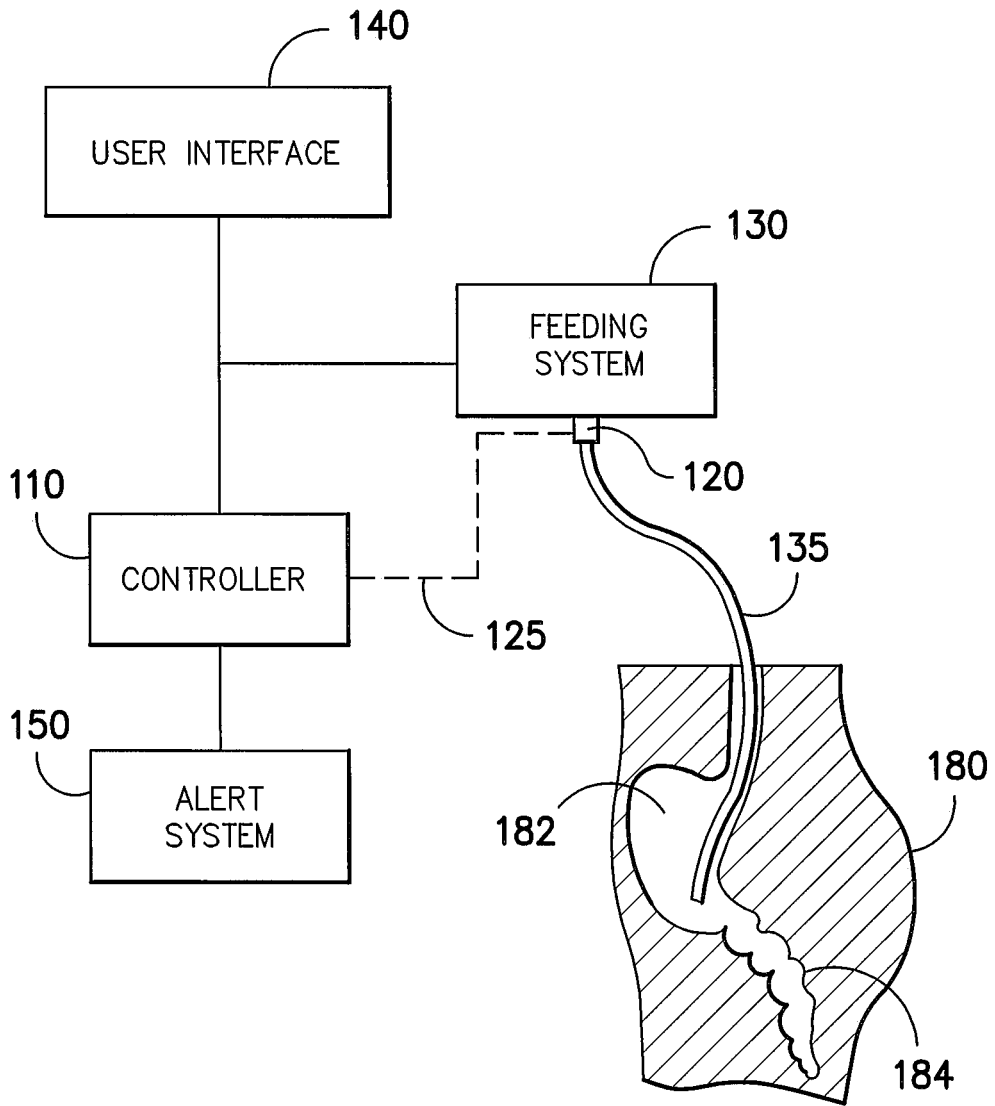

*FIG. -8-*

## REFERENCES CITED IN THE DESCRIPTION

This list of references cited by the applicant is for the reader's convenience only. It does not form part of the European patent document. Even though great care has been taken in compiling the references, errors or omissions cannot be excluded and the EPO disclaims all liability in this regard.

## Non-patent literature cited in the description

- **HOMANN et al.** Control of postoperative enteral feeding by hydrogen breath test. *Clinical Nutrition*, 01 January 1991, vol. 10 [0006]
- **BEHALL, K.M. ; SCHOLFIELD, D.J. ; VAN DER SLUIJS, A.M.C. ; HALLFRISCH, J.** Breath hydrogen and methane expiration in men and women after oat extract consumption. *J. Nutrition*, 1998, vol. 128, 79-84 [0017] [0028]
- **LI, D-Y ; BARNES, T. ; THOMPSON, R.E. ; CUF-FARI, C.** Who should request a breath hydrogen test. *Journal of Applied Research*, 2004, vol. 4 (2), 266 [0027]
- **LINDBERG, D.A.** Hydrogen breath testing in adults. *Gastroenterology Nursing*, 2009, vol. 32 (1), 19-24 [0027]
- **ATTAR, A. ; FLOURIE, B. ; RAMBAUD, J-C. ; FRA-CHISSEUR, C. ; RUSZNIEWSKI, P. ; BOUHNİK, Y.** Antibiotic efficacy in small intestinal bacterial overgrowth. *Gastroenterology*, 1999, vol. 117 (4), 794-797 [0027]
- **TADESSE, K. ; SMITH, D. ; EASTWOOD, M.A.** Breath hydrogen and methane excretion patterns in normal man and in clinical practice. *Quarterly Journal of Experimental Physiology*, 1980, vol. 65, 85-97 [0028]
- **BOND, J.H. ; LEVITT, M.D.** Use of breath hydrogen in the study of carbohydrate absorption. *Digestive Diseases*, 1997, vol. 22 (4), 379-382 [0028]
- Selective hydrogen gas nanosensors using individual ZnO nanowire with fast response at room temperature. **LUPAN O et al.** *Sensors and Actuators B Chemical*. University of Florida, 2009 [0061]
- **VARGHESE O.K. et al.** Hydrogen sensing using titania nanotubes. *Sensors and Actuators*, 2003, vol. B93, 338-344 [0061]
- **SHAFIEI M et al.** Pt/MoO<sub>3</sub> nano-flower SiC Schottky diode based hydrogen gas sensors. *Prof of IEEE Sensors Conf.*, 2010, 354-357 [0061]
- **RIVERA I F.** Graphene based ultra-sensitive gas sensors. *IEEE Sensors Conf.*, 2010, 1543-37 [0061]
- **MOAFI A et al.** Oriented graphitic carbon films for hydrogen gas sensors. *IEEE Sensors Conf.*, 2010, 378-381 [0061]

专利名称(译)	用于监测作为微生物菌群肠气水平的函数的营养摄取的方法和系统		
公开(公告)号	<a href="#">EP2651286A2</a>	公开(公告)日	2013-10-23
申请号	EP2011849806	申请日	2011-11-07
[标]申请(专利权)人(译)	金伯利-克拉克环球有限公司		
申请(专利权)人(译)	金佰利WORLDWIDE , INC.		
当前申请(专利权)人(译)	金佰利WORLDWIDE , INC.		
[标]发明人	MACDONALD JOHN GAVIN KOH CHOLWON SA INYOUNG ABRAHAM JOSE K RANGANATHAN SRIDHAR		
发明人	MACDONALD, JOHN, GAVIN KOH, CHOLWON SA, INYOUNG ABRAHAM, JOSE, K. RANGANATHAN, SRIDHAR		
IPC分类号	A61B5/00 A61B5/145		
CPC分类号	C12N5/0678 A61B5/082 A61B5/4866 A61B5/6867 A61B5/6871 A61B5/6873 A61J15/00 A61J15/0015 A61J15/0084 A61K35/39 A61M2039/085 C12N15/113 C12N2310/14 C12N2310/141 C12N2310/531 C12N2330/50 C12N2500/25 C12N2500/34 C12N2500/38 C12N2500/90 C12N2501/16 C12N2501/42 C12N2501/602 C12N2501/65 C12N2501/998		
优先权	61/422730 2010-12-14 US 13/245412 2011-09-26 US		
其他公开文献	EP2651286B1 EP2651286A4		
外部链接	<a href="#">Espacenet</a>		

#### 摘要(译)

公开了用于监测个体的营养摄取的系统和方法。该方法可以包括监测与患者相关的微生物菌群肠气浓度水平，并且至少部分地基于与患者相关的微生物菌群肠气水平，用人工喂养装置调节患者提供的营养物的体积。微生物菌群肠气传感器可用于监测与患者相关的微生物菌群肠气。微生物菌群肠气传感器可以监测患者呼出气体或患者消化道中的微生物菌群肠气。微生物菌群肠气传感器作为肠内喂养系统的一部分包括在肠饲管的远端或外端。还公开了基于与婴儿相关的微生物菌群肠气水平监测婴儿营养摄取的系统和方法。