



(11) **EP 2 270 195 A1**

(12) **EUROPEAN PATENT APPLICATION**

(43) Date of publication:
05.01.2011 Bulletin 2011/01

(51) Int Cl.:
C12Q 1/00 ^(2006.01) **A61B 5/00** ^(2006.01)
G01N 27/406 ^(2006.01)

(21) Application number: **10179721.5**

(22) Date of filing: **11.04.2006**

(84) Designated Contracting States:
BE DE FR GB IT NL

(30) Priority: **12.04.2005 US 671026 P**
28.04.2005 US 118947
28.04.2005 US 118507
28.04.2005 US 118894

(62) Document number(s) of the earlier application(s) in accordance with Art. 76 EPC:
06252010.1 / 1 712 635

(71) Applicant: **Lifescan Scotland Ltd**
Inverness IV2 3ED (GB)

(72) Inventors:
• **Rodgers, James Iain**
Inverness-shire IV2 4LL Scotland (GB)
• **Liu, Zuifang**
Inverness-shire, IV2 4LL Scotland (GB)
• **MacLennan, Margaret**
Inverness-shire, IV2 7TB Scotland (GB)

- **Moffat, James**
Inverness-shire, IV3 8QU Scotland (GB)
- **Lillie, Geoffrey**
Inverness-shire, IV3 5JW Scotland (GB)
- **MacDonald, Michael**
Inverness-shire, IV2 3BF Scotland (GB)
- **McNeilage, Alan Watson**
Inverness-shire, IV3 8LZ Scotland (GB)

(74) Representative: **James, Anthony Christopher W.P.**
Carpmaels & Ransford
One Southampton Row
London
WC1B 5HA (GB)

Remarks:

This application was filed on 25-09-2010 as a divisional application to the application mentioned under INID code 62.

(54) **Water-miscible conductive ink for use in enzymatic electrochemical-based sensors**

(57) A water-miscible conductive ink for use in enzymatic electrochemical-based sensors includes a conductive material, an enzyme, a mediator and a binding agent. The conductive material, enzyme, mediator, and binding

agent are formulated as a water-miscible aqueous-based dispersion wherein the binding agent becomes operatively water-insoluble upon drying.

EP 2 270 195 A1

Description**BACKGROUND OF THE INVENTION**Field of the Invention

[0001] The present invention relates, in general, to sensors and, in particular, to enzymatic electrochemical-based sensors.

Description of the Related Art

[0002] The use of enzymatic electrochemical-based sensors that employ an enzymatic reagent, for example, an enzymatic reagent that includes a redox mediator (e.g., ferrocene) and a redox enzyme (e.g., glucose oxidase), in conjunction with an electrode(s) for the determination of an analyte in a liquid sample has become of heightened interest in recent years. Such enzymatic electrochemical-based sensors are believed to be particularly suitable for continuous or semi-continuous monitoring of analytes (e.g., glucose) in a fluid samples (e.g., blood or interstitial fluid samples). For example, enzymatic electrochemical-based glucose sensors employing a redox mediator, a redox enzyme and a working electrode can determine (i.e., measure) glucose concentration using relatively low potentials (e.g., less than 0.4 V vs SCE), thereby limiting any interfering responses, at the working electrode. For a further description of enzymatic electrochemical-based sensors, see, for example, U.S. Patent Nos. 5,089,112 and 6,284,478.

BRIEF DESCRIPTION OF THE DRAWINGS

[0003] A better understanding of the features and advantages of the present invention will be obtained by reference to the following detailed description that sets forth illustrative embodiments, in which the principles of the invention are utilized, and the accompanying drawings of which:

FIG. 1 depicts a copolymer that can be employed in a binding agent of a water-miscible conductive ink according to an exemplary embodiment of the present invention;

FIG. 2 depicts another copolymer that can be employed in a binding agent of a water-miscible conductive ink according to another exemplary embodiment of the present invention;

FIG. 3 depicts yet another copolymer that can be employed in a binding agent of a water-miscible conductive ink according to yet another exemplary embodiment of the present invention;

FIG. 4 depicts a reaction sequence for creating a copolymer that can be employed in a binding agent of a water-miscible conductive ink according to a further exemplary embodiment of the present invention;

FIG. 5A is a simplified top view depiction of a portion

of an enzymatic electrochemical-based sensor according to an exemplary embodiment of the present invention;

FIG. 5B is a simplified cross-sectional depiction of the enzymatic electrochemical-based sensor of FIG. 5A taken along line 5B-5B;

FIG. 5C is a simplified cross-sectional depiction of the enzymatic electrochemical-based sensor of FIG. 5A taken along line 5C-5C;

FIG. 5D is a simplified cross-sectional depiction of the enzymatic electrochemical-based sensor of FIG. 5A taken along line 5D-5D;

FIG. 6 is a flow chart of a process for manufacturing a portion of an enzymatic electrochemical-based sensor according to an exemplary embodiment of the present invention;

FIG. 7 depicts a simplified reaction sequence for the synthesis of a high molecular weight redox copolymer of acrylamide and vinylferrocene that can be employed in a binding agent of a water-miscible conductive ink according to an exemplary embodiment of the present invention;

FIG. 8A is a graph depicting calibration data of an enzymatic electrochemical-based glucose sensor according to an exemplary embodiment of the present invention obtained in a continuous flow mode;

FIG. 8B is a graph depicting current stability over time for an enzymatic electrochemical-based glucose sensor according to an exemplary embodiment of the present invention;

FIG. 9 is a graph depicting calibration data of an enzymatic electrochemical-based sensor according to an exemplary embodiment of the present invention obtained employing a microfluidic test system;

FIG. 10 is a graph depicting transient response to a variety of glucose concentrations for an embodiment of an enzymatic electrochemical-based sensor according to the present invention;

FIG. 11 is a graph depicting integrated transient response to a variety of glucose concentrations for an embodiment of an enzymatic electrochemical-based sensor according to the present invention;

FIG. 12 is a calibration graph for an enzymatic electrochemical-based sensor according to an exemplary embodiment of the present invention;

FIG. 13 is a graph depicting response stability for an enzymatic electrochemical-based sensor according to an exemplary embodiment of the present invention; and

FIG. 14 is a graph depicting calibration data for an enzymatic electrochemical-based glucose sensor according to an exemplary embodiment of the present invention.

DETAILED DESCRIPTION OF ILLUSTRATIVE EMBODIMENTS OF THE INVENTION

[0004] A water-miscible conductive ink for use in an enzymatic electrochemical-based sensor according to an embodiment of the present invention includes a conductive material, an enzyme, a mediator and a binding agent. In addition, the conductive material, enzyme, mediator and binding agent are formulated as a water-miscible aqueous-based dispersion wherein the binding agent becomes operatively water-insoluble upon drying. In this regard, one skilled in the art will recognize that a dispersion is essentially a mixture comprising discrete particle material (e.g., particles of conductive material) dispersed in a continuous phase of a different material (e.g., a continuous binding agent phase). Characteristics, benefits and other exemplary details of water-miscible conductive inks for use in an enzymatic electrochemical-based sensor according to various exemplary embodiments of the present invention are described below.

[0005] Water-miscible conductive inks according to embodiments of the present invention enable close proximal juxtaposition between the enzyme, the mediator, and the conductive material, thereby facilitating rapid electron exchange (i.e., electron transfer) therebetween. Such rapid electron exchange can lead to a beneficial increase in current collection efficiency.

[0006] Water-miscible conductive inks according to embodiments of the present invention are readily employed in conventional enzymatic electrochemical-based sensor manufacturing techniques such as, for example, screen printing techniques. Furthermore, embodiments of the water-miscible conductive ink are suitable for being immobilized upon drying to a substrate of an enzymatic electrochemical-based sensor as a conductive layer, thus preventing loss of mediator and/or enzyme from the conductive layer during use of the enzymatic electrochemical-based sensor. In addition, in comparison to a conventional discrete electrode, the conductive material of such a conductive layer can have a greater mediator accessible surface area.

[0007] Since water-miscible conductive inks according to embodiments of the present invention are formulated as aqueous-based dispersions, they are readily compatible with typical enzymes and mediators. In addition, water-miscible conductive inks according to embodiments of the present invention are advantageous in that their water-miscible nature enables a wide formulation latitude in terms of the proportion of enzyme and mediator which can be incorporated therein as a uniform dispersion.

[0008] Water-miscible conductive inks according to embodiments of the present invention can be easily manufactured, and are readily applied to substrates of an enzymatic electrochemical-based sensor. The water-miscible conductive inks are, therefore, beneficially suitable for rapid and cost effective production of enzymatic electrochemical-based sensors. Furthermore, since em-

bodiments of water-miscible conductive inks according to embodiments of the present invention combine an enzyme, mediator and a conductive material into a single composition, the number of processing steps and expense required to manufacture an enzymatic electrochemical-based sensor is beneficially reduced.

[0009] It should be noted that a water-miscible conductive ink according to embodiments of the present invention is a conductive ink that can be dissolved and/or otherwise dispersed uniformly in water or other aqueous solution, although the water-miscible conductive ink can also include an organic solvent that does not induce phase separation (i.e., a water-miscible organic solvent).

[0010] Suitable conductive materials, enzymes, mediators and binding agents, as well as a descriptions of suitable techniques for formulating the conductive materials, enzymes, mediators and binding agents into a water-miscible conductive ink according to embodiments of the present invention are detailed below.

Conductive Material

[0011] Any suitable conductive material (also referred to as a pigment or carbon ink as a context may warrant) known to one skilled in the art can be employed in embodiments of the present invention. For example, the conductive material can be a finely divided conductive particle material such as a carbon black material, graphite material, a platinum particle material, a platinumized carbon material, a gold particle material, a platinum/palladium alloy particle material, a palladium particle material, a ruthenium particle material, or a cerium particle material. The size of such finely divided conductive particle material can be, for example, less than 100 microns and, preferably, in the size range of 1nm to 20 microns. In addition, the size range can have a bimodal distribution.

[0012] When a water-miscible conductive ink according to embodiments of the present invention is employed to manufacture a conductive layer of an enzymatic electrochemical-based sensor, the conductive material of the water-miscible conductive ink can serve as an electrode and exchange electrons with the mediator of the water-miscible conductive ink. In this regard, once apprised of the present disclosure, one skilled in the art will recognize that conductive layers formed from water-miscible conductive inks according to the present invention contain the conductive material, enzyme and mediator that were present in the water-miscible conductive ink used to form the conductive layer. Since the conductive material and the mediator (as well as the enzyme and binding agent) can be formulated as a uniform dispersion, the resulting conductive layer has an enhanced ability for electron exchange between the conductive material and the mediator in comparison to electron exchange between a discrete conductive material layer (such as a conventional electrode) and a separate mediator-containing layer.

[0013] Once apprised of the present disclosure, one skilled in the art can select a combination of conductive

particles, binding agent, mediator, enzyme, and, optionally, a water-miscible organic co-solvent that produce a uniform dispersion and, upon drying, a uniform conductive layer (e.g., a conductive layer with an essentially uniformly distributed enzyme, mediator and conductive material). Conventional and well-known experimental techniques for assessing uniformity of dispersions and conductive layers (such as visual and Scanning Electron Microscopy (SEM) inspection and mechanical characterization) can be employed in doing so.

[0014] The electrical characteristics of conductive material (as well as the binding agent) employed in a water-miscible conductive ink, and the proportion of the conductive material, can be predetermined such that a conductive layer formed by drying the water-miscible conductive ink has a conductivity of less than about 10 k Ω . In this regard, it can be particularly beneficial to form a conductive layer with a conductivity of less than about 1 k Ω .

Enzyme

[0015] Any suitable enzyme known to one skilled in the art can be employed in embodiments of the present invention. The enzyme can be, for example, an enzyme that selectively recognizes an analyte (e.g., glucose) to be determined (i.e., detected or measured) within a fluid sample (such as a blood sample). As is known to one skilled in the art of enzymatic electrochemical-based sensors, such an enzyme partakes in an electrochemical reaction that is the basis for an electrochemical determination of the analyte by an enzymatic electrochemical-based sensor. For example, the enzyme may shuttle electrons to an electrode (or other conductive material) using a mediator, thereby enabling a current to be measured at the electrode which is proportional to analyte concentration.

[0016] The enzyme can be, for example, a redox enzyme such as a glucose oxidizing enzyme. In this circumstance, an enzymatic electrochemical-based sensor that employs a water-miscible conductive ink containing a glucose oxidizing enzyme can be used to determine glucose in a fluid sample (e.g., a whole blood sample). Examples of a glucose oxidizing enzymes include, but are not limited to, glucose oxidase and pyrrolo-quinoline-quinone (PQQ) glucose dehydrogenase.

[0017] The formulations of water-miscible conductive inks according to embodiments of the present invention enable the enzyme of such water-miscible conductive inks to be operatively immobilized to a substrate of an enzymatic electrochemical-based sensor. The operative immobilization is such that the enzyme, while immobilized to the substrate, is able to react with an analyte and transfer electrons to the conductive material via the mediator.

Mediator

[0018] Any suitable mediator known to one skilled in the art can be employed in embodiments of the present invention. A mediator is essentially a chemical entity that can operatively exchange electrons with both the conductive material and the enzyme of the water-miscible conductive ink.

[0019] The mediator can be, for example, ferricyanide or ferrocene. In addition, the mediator can be a polymeric mediator such as those described, and referred to as redox polymers, in co-pending European Patent Applications Nos. 1 621 636, 1 630 234 and 1 642 984. Such polymeric mediators can be water soluble and of a high molecular weight, such as a co-polymer of vinyl ferrocene and acrylamide.

[0020] A suitable mediator with limited water-solubility such as, for example, ferrocene or tetrathiafulvalene/tetracyanoquinodimethane (TTF/TCNQ) can be prepared for formulation into a water-miscible conductive ink according to embodiments of the present invention by dispersion or dissolution of the mediator into a water miscible co-solvent such as, for example, methyl carbitol or a glycol ether solvents prior to formulation. Such a water-miscible co-solvent enables the mediator to be effectively dispersed with the conductive material, enzyme and binding agent of the water-soluble conductive ink despite the limited water-solubility of the mediator in the absence of the co-solvent.

[0021] The formulations of water-miscible conductive inks according to embodiments of the present invention enable the mediator to be operatively immobilized to a substrate of an enzymatic electrochemical-based sensor. The operative immobilization is such that the mediator, while immobilized to the substrate, is able to react with an enzyme and transfer electrons to the conductive material.

Binding Agent

[0022] Any suitable binding agent (also referred to as a resin or resin polymer as a context may warrant) known to one skilled in the art can be employed in embodiments of the present invention. This binding agent of water-miscible conductive inks according to embodiments of the present invention serves to operatively immobilize the conductive material, mediator and enzyme of the water-miscible conductive ink to a substrate of an enzymatic electrochemical-based sensor.

[0023] The binding agent can include, for example, a resin polymer and a counter-ion, wherein the counter-ion renders the resin polymer soluble in water by deprotonating or protonating an acid or base group of the resin polymer. The counter-ion can be volatile, such that when the water-miscible conductive ink is dried, the counter ion essentially evaporates and the resulting binding agent (i.e., the dried resin polymer) becomes operatively water insoluble. For example, the resin polymer can have

an acid group derived from a carboxylic acid species, and the volatile counter ion can be derived from a volatile amine such as ammonia, N,N'-dimethylethanolamine, or a volatile organic amine. When the volatile counter-ion evaporates from the water-soluble conductive ink, the resin polymer can become ionically cross-linked onto a substrate of an enzymatic electrochemical-based sensor in such a way that the enzyme, conductive material, and mediator of the water-insoluble conductive ink are substantially immobilized. For a resin polymer with negatively-charged acid groups, the negatively charged acid groups may ionically bind with positively charged species on the resin polymer itself or with any of the conductive material, the enzyme and the mediator.

[0024] Alternatively, for example, an acid or base groups of a polymeric resin can be such that the acid or base group is only ionized within a predetermined pH range, thus rendering the polymeric resin water soluble within the predetermined pH range. Upon drying of the water-miscible conductive ink, the dried or drying ink can be treated with a solution of an appropriate pH beyond the predetermined pH range to render the polymeric resin operatively water insoluble.

[0025] The usefulness of binding agents can be enhanced by the action of co-solvency effects, whereby the presence of a water miscible organic co-solvent in the water-miscible conductive ink improves the water-solubility of the binding agent. Such organic co-solvents can be, for example, removed by evaporation when the water-miscible conductive ink is dried. Notably, upon contact with a fluid sample during use of the enzymatic electrochemical-based sensor, the organic solvent is absent and the resin polymer is operatively water-insoluble. Suitable water miscible organic co-solvents include, for example, alcohols, glycol ethers, methyl carbitol, butyl carbitol, ethylene glycol, ethylene glycol diacetate, diacetone alcohol and triethyl phosphate.

[0026] Once apprised of the present disclosure, one skilled in the art will recognize that various components of water-miscible conductive inks according to the present invention are commercially available. For example, a water-miscible combination of conductive graphite material and binding agent suitable for use in various embodiments of water-miscible conductive inks according to the present invention is available as a conductive graphite paste from Coates Electrographics, a division of Sun Chemical Screen, Norton Hill, Midsomer Norton, Bath UK, under the catalog number 66756. A further water-miscible combination of conductive material and binding agent is commercially available from Precisia, Ann Arbor, Michigan, U.S.A. as water-soluble conductive material LFW201-H.

[0027] The dried binding agent of a conductive layer formed by drying various embodiments of water-miscible conductive inks according to the present invention can serve as a dialytic membrane, with the mediator, enzyme, and conductive material being constrained within the dried and operatively water insoluble binding agent and,

thereby, immobilized to a substrate of an enzymatic electrochemical-based sensor. Such a dialytic membrane can allow relatively small molecules, such as glucose, to penetrate therein and interact with the constrained enzyme.

[0028] Referring to FIGs. 1, 2, 3 and 4, suitable binding agents for use in water-miscible conductive inks according to embodiments of the present invention can include a polymer with carboxylic functional groups, anhydride functional groups, and/or phosphoric acid groups. For example, the binding agent may be a copolymer of polystyrene-co-maleic anhydride 10 depicted in FIG. 1, a hydrolyzed copolymer of polystyrene-co-maleic anhydride 20 depicted in FIG. 2, a copolymer of polystyrene-co-maleic anhydride which is partially hydrolyzed, a partially esterified copolymer of polystyrene-co-maleic anhydride 30 as depicted in FIG. 3, or a phosphoric acid functional polymer 40 derived by the reaction of phosphoric acid 42 with epoxy resin 44 as depicted in FIG. 4.

[0029] Furthermore, binding agents can also be formulated to contain a copolymer or terpolymer made by blending suitable acid functional vinyl monomers, such as an acrylic acid monomer, and/or a methacrylic acid monomer, and/or an itaconic acid monomer, and/or a maleic acid monomer, along with other vinyl monomers, such as a methyl methacrylate monomer, and/or a styrene monomer, and/or an ethyl acrylate monomer, and/or an isopropyl acrylate monomer, and/or a butyl acrylate monomer, and/or an acrylonitrile monomer, and/or a methyl styrene monomer, and/or a vinyl benzoate monomer, and/or an acrylamide monomer, and/or a hydroxymethyl methacrylate monomer. Such polymeric binding agents combine water miscibility with excellent conductive material dispersant properties.

[0030] Referring to FIGs. 5A, 5B, 5C and 5D, an enzymatic electrochemical-based sensor 100 according to an embodiment of the present invention includes a substrate 102, a reference electrode 104a with an electrode surface 106a, a working electrode 104b with an electrode surface 106b, and a conductive layer 108 disposed on electrode surface 106b. Conductive layer 108 is formed by drying a water-miscible conductive ink according to embodiments of the present invention as described herein. Therefore, conductive layer 108 includes a dried binding agent (that is operatively water insoluble), a mediator, an enzyme and conductive material. Although conductive layer 108 is depicted as being disposed on working electrode 104b, a conductive layer formed from water-miscible conductive inks according to embodiments of the present invention can themselves serve as a working electrode or other suitable conductive component of an enzymatic electrochemical-based sensor.

[0031] Enzymatic electrochemical-based sensor 100 also includes a reference ink layer 114 and an optional insulation layer 112. One skilled in the art will recognize that FIGs. 5A through 5D depict only a portion of a complete enzymatic electrochemical-based sensor and that additional components of the enzymatic electrochemical-

based sensor (e.g., a housing, analysis/microprocessor module, and electrical communication circuits) have not been illustrated to avoid unduly complicating FIGs. 5A through 5D.

[0032] One skilled in the art will also recognize that reference ink layer 114, which constitutes an electrochemically active layer integrated with reference electrode 104a, sets the "zero potential" against which a measurement potential is applied at working electrode 104b. One skilled in the art will further recognize that although FIGs. 5A through 5D depict an enzymatic electrochemical-based sensor with a two electrode format, other enzymatic electrochemical-based sensor formats known in the field can be employed in embodiments of the present invention.

[0033] Substrate 102 can be formed, for example, from a sheet of polyethylene terephthalate, polybutylene terephthalate sheet (commercially available from, for example, GE Plastic, United States), or from an oriented polystyrene film (commercially available from, for example, NSW GmbH, Germany).

[0034] Reference ink layer 114 can be formed, for example, from Ag/AgCl paste (commercially available from Gwent Electronic Materials, Pontypool Wales, UK) or any suitable electrochemical reference material including, but not limited to materials that include a metal that forms a partially soluble salt (e.g., silver, copper, titanium and lithium).

[0035] The optional insulation layer 112 can be formed, for example, from a dielectric screen printable ink paste (commercially available from, for example, Sericol Inks Ltd.). Reference electrode 104a and working electrode 104b can be formed of any suitable material known to one skilled in the art.

[0036] Reference electrode 104a, working electrode 104b, insulation layer 112 can have any suitable thickness. However, a typical thickness for each of these layers is in the range of from 1 micron to 100 microns.

[0037] FIG. 6 is a flow chart of a method 600 for manufacturing an enzymatic electrochemical-based sensor according to an exemplary embodiment of the present invention. The manufactured portion can be any conductive layer such as, for example, an electrode, an electrically conductive trace or the conductive layer depicted in FIGs. 5A through 5D. However, one skilled in the art will recognize that although FIGs. 5A through 5D illustrate an enzymatic electrochemical-based sensor that can be manufactured using methods according to the present invention, the methods are not limited to the enzymatic electrochemical-based sensor depicted in FIGs. 5A through 5D.

[0038] Method 600 includes applying a water-miscible conductive ink to a substrate of an enzymatic electrochemical-based sensor, as set forth in step 610. The water-miscible conductive ink includes a conductive material, an enzyme, a mediator, and a binding agent, with the conductive material, enzyme, mediator, and binding agent formulated as a water-miscible aqueous-based

dispersion and wherein the binding agent becomes operatively water-insoluble upon drying.

[0039] The substrate can be any suitable substrate including, for example, an electrically insulating substrate of an enzymatic electrochemical-based sensor and/or a conducting substrate of an enzymatic electro-chemical based sensor.

[0040] The application of step 610 can be accomplished using, for example, any suitable application technique including screen printing techniques, dip coating techniques, spray coating techniques, and inkjet coating techniques. The water-miscible conductive ink applied in step 610 is further described herein with respect to water-miscible conductive inks and enzymatic electrochemical-based sensors according to the present invention.

[0041] As illustrated in step 620 of FIG. 6, method 600 further includes drying the water-miscible conductive ink to form a conductive layer on the substrate that includes an operatively water-insoluble binding agent.

[0042] The drying can be conducted at a temperature and for a time period that is sufficient to immobilize the dried water-soluble conductive ink to the substrate and form the conductive layer, but insufficient to significantly degrade the activity of the enzyme. For example, the water-miscible conductive ink can be dried at about 75 °C for about 20 minutes.

Example 1

[0043] A water-miscible conductive ink according to an exemplary embodiment of the present invention that included the enzyme glucose oxidase, the mediator ferrocene and a commercially available combination of conductive material and binding agent (available from Coates as water-miscible graphite paste 66756) was prepared. The water-miscible conductive ink was formulated as follows: 50 mg of glucose oxidase was dissolved in 0.7ml of Analar water. The resulting solution was added to 5g of water-miscible graphite paste 66756, followed by mixing with 25mg of ferrocene that had been dissolved in 1ml of methyl carbitol co-solvent.

[0044] A portion of the water-miscible conductive ink described above was coated onto a glassy carbon electrode and dried in an oven at 75 °C for 20 minutes to create a glassy carbon electrode with a conductive layer thereon. One skilled in the art will recognize that such an electrode with a conductive layer thereon represents a portion of an enzymatic electrochemical-based sensor.

[0045] The electrode with the conductive layer thereon was tested at a constant potential of 300mV in a beaker containing a stirred buffered glucose solution. The test employed a silver/silver chloride reference electrode and a platinum wire counter electrode. An amperometric response to increasing glucose concentration in the beaker was observed. Amperometric testing was performed for a period in excess of 12 hours, through successive changes in buffer and glucose additions. Upon extended testing, the amperometric response decreased. It is pos-

tulated that the decrease was a result of a loss of mediator from the conductive layer.

Example 2

[0046] A hydrophilic high molecular weight redox polymer (i.e., redox polymer 700 of FIG. 7) suitable for use in a water-miscible conductive ink according to an embodiment of the present invention was synthesized by the free radical co-polymerization reaction depicted in FIG. 7 using a reaction solution of 1.8 g of 97% acrylamide (AAM), 0.3 g of 97% vinylferrocene (VFc), and 0.03 g of 2,2'-azobisisobutyronitrile (AIBN) in a 40 mL mixture of dioxane and ethanol (1/1 v/v). The reaction was performed in a round bottom flask. The reactions was performed with 5 molar percent of vinyl ferrocene and a 95 molar percent of acrylamide.

[0047] Before initiating the reaction, the reaction solution described above was deoxygenated by bubbling nitrogen therethrough for one hour. The reaction solution was then heated to 70 °C in an oil bath for 24 hours with continuous magnetic agitation under a nitrogen atmosphere. The resulting polymer precipitate was filtered off and repeatedly washed with acetone to provide a purified sample of polymer precipitate. The purified sample was subsequently dried in an oven at 50 °C.

[0048] Relatively low molecular weight portions were then eliminated from the dried purified sample through dialysis against de-ionized water using a cellulose membrane tubing with a molecular weight cutoff of 13 Kg/mol. The resulting composition was a hydrophilic high molecular weight redox polymer (i.e., redox polymer 700 of FIG. 7).

Example 3

[0049] A water-miscible conductive ink in accordance with an embodiment of the present invention was formulated using redox polymer 700 described in Example 2. The formulation included mixing together 30 mg of glucose oxidase (obtained from *Aspergillus Niger*), 160 mg of a 5% aqueous solution of redox polymer 700, 1 ml of Analar water, 3g of water miscible graphite paste (commercially available from Coates Screen, a division of Sun Chemical, as catalog number 66756) to form a homogeneous aqueous-based dispersion.

[0050] The water-miscible conductive ink described immediately above was coated onto a substrate of an enzymatic electrochemical-based sensor (namely, sensor artwork of 3.75 square millimeters with conductive tracks and a reference (screen printed Ag/AgCl) electrode). The coated substrate was dried at 75 °C for 20 minutes. The dried coated substrate was then placed into a flow-through cell, and connected to a potentiostat. A potential of 300mV was applied to a working electrode (formed from the water-miscible conductive ink as described immediately above), with a Pt wire inserted into the cell to act as a counter electrode).

[0051] Phosphate buffered saline (PBS) containing glucose at physiologically relevant concentrations in the range of 0-20mmol/L was flowed across the enzymatic electrochemical-based sensor at 0.7ml/minute. The generated current response was proportional to the glucose concentration of the analyte being flowed at a given point in time, as exemplified by the data of FIG. 8A, and was stable for a period in excess of 20 hours. The stability is further exemplified by the data of FIG. 8B, which depicts 11 hours of data.

[0052] Based on the data of FIGs. 8A and 8B, the enzymatic electrochemical-based sensor of this example is eminently suitable for the detection of physiologically relevant concentrations of glucose, in a continuously operating mode. It was postulated that the water-miscible conductive ink employed in the enzymatic electrochemical-based sensor combined the advantages of an immobilized high molecular weight mediator and immobilized enzyme, with improved electrochemical communication between the enzyme, the mediator and the conductive material.

Example 4

[0053] A water-miscible conductive ink similar to that of Example 3 was prepared but with the addition of a rheology modifying agent (i.e., Cabosil LM150 hydrophilic fumed silica). The incorporation of a rheology modifying agent (such as Cabosil LM150 hydrophilic fumed silica or Cabosil TS 610 hydrophobic fumed silica) can improve the suitability of the water-miscible conductive ink for screen printing.

[0054] The water-miscible conductive ink was formulated by combining 540 mg glucose oxidase from *Aspergillus Niger*, 8.14 g of a 5% aqueous solution of redox polymer 700, 60g of Coates 66756 water-miscible graphite paste, and 1.6 g Cabosil LM150 hydrophilic fumed silica. The combination was mixed at a high shear rate (i.e., 2000 rpm) for 5 minutes until a uniform, high viscosity paste. The high viscosity paste was then printed through a screen mesh using a DEK 248 screen printer onto an enzymatic electrochemical-based sensor substrate and dried to form a conductive layer. The resulting enzymatic electrochemical-based sensor was essentially as depicted in FIG. 5D.

[0055] The enzymatic electrochemical-based structure thus formed was then tested in conjunction with a microfluidic test system. When tested with several glucose concentrations, the response of the enzymatic electrochemical-based structure was largely stable and linear up to 20mmol glucose concentration at 300mV, for a period in excess of 10 hours.

[0056] In a further test, various concentrations of glucose in phosphate buffer were flowed through the microfluidic test system at a rate of 200nL/min. The current response (depicted by the data of FIG. 9) was proportional to glucose concentration employed. The data of FIG. 9 indicates that a continuous stable measurement

can be made over a time period in excess of 10 hours, without the need for recalibration or baseline correction.

Example 5

[0057] A further enzymatic electrochemical-based sensor structure and microfluidic test system as described in Example 4 was prepared and tested with an analyte generated by mixing freshly extracted human plasma with phosphate buffer in a ratio of 1:2 such that the resulting fluid was a close physiological match to human interstitial fluid. Glucose additions were made to this fluid to generate a range of samples that represented the usual physiological glucose range in diabetic persons.

[0058] The resulting sample liquid was introduced to the microfluidic test system in 5 minute bursts at a rate of 300nL/min, during which 0V potential was applied between a working and counter electrode of the enzymatic electrochemical-based sensor structure. This was followed by a 10 minute interval during which the analyte was stagnant. During this 10 minute interval when the analyte was stagnant, a 300mV potential was applied to the working electrode, and a transient current response was measured. This process was repeated multiple times, each time with the sample liquid containing a different concentration of glucose. The current response generated at each measurement cycle is depicted in FIG. 10.

[0059] The data of FIG. 10 represents measurements made at 10-15 minute intervals over a period of time in excess 20 hours. The data of FIG. 10 indicates that glucose concentration can be determined from the current response by either an amperometric measurement of the current at a chosen time or from a coulometric measurement made by taking an integration or partial integration of the current response at a given measurement time. For instance FIG. 11 is a graph representing the coulometric integration of each current transient shown in FIG. 10, indicating both the glucose level of the analyte supplied, and the time at which the measurement was made. FIG. 12 depicts a calibration curve derived from the data of FIG. 11. The data of FIG. 13 indicates that the enzymatic electrochemical-based sensor exhibited stability over a period in excess of 20 hours when tested in the manner described above.

Example 6

[0060] A water-miscible conductive ink as described in Example 4 and kept refrigerated at 5 °C for 21 days before being tested. When tested as described in Example 4, there was no significant difference between the current response obtained using the water-miscible conductive ink that had been stored for 21 days at 5 °C, compared to water-miscible conductive ink that had been manufactured, printed and tested on successive days.

Example 7

[0061] A water-miscible conductive ink according to an embodiment of the present invention was formulated by mixing 83g of Precisia LFW201-H water soluble conductive material and binding agent, 8.7g of a 5% solution of redox polymer 700 (described above), and 0.5 g of Glucose oxidase from Aspergillus Niger. After mixing, the resulting water-miscible conductive ink was coated on (i.e., applied to) a printed carbon electrode as described in Example 4. The resulting enzymatic electrochemical-based produced a signal of about 10 nA when exposed to 10 mM glucose. The signal was maintained for the duration of a 1 hour test, thus demonstrating operative immobilization of the various components of the water-miscible conductive ink.

Example 8

[0062] An water-miscible conductive ink according to the present invention was formulated from 5g of finely powdered poly-styrene-co-maleic anhydride partial iso-octyl ester with a cumene end cap of Mw 2300 (obtained from Aldrich) dissolved in 20g of 2-butoxyethanol to form a polymeric resin paste. Next, 12g of graphite powder (particle size 2 micron, obtained from Aldrich) and 2g of Carbon black (grade black pearls 3700, from Cabot Chemical company) was mixed with the polymeric resin paste on a triple roll mill for 10 minutes. This was followed by a 10g portion of the resulting mixture being further mixed with 0.5g of N'N' dimethylethanolamine a volatile counter-ion, available from Aldrich). Next, 3mls of water was added to form an intermediate mixture. The electrical resistance of a portion of this intermediate mixture coated onto a polyester substrate with a no3 K-bar, was approximately 300 ohms per square.

[0063] 1.3 grams of the intermediate mixture was mixed with 0.56g of a 5% aqueous solution of redox polymer 700 and 30 mg of glucose oxidase from Aspergillus Niger to create a water-miscible conductive ink according to an embodiment of the present invention.

[0064] The water-miscible conductive ink was coated onto a carbon electrode (as depicted in FIGs. 5A through 5D) and tested in a flow system at 0.7ml per minute with solutions containing glucose at 0.7ml per minute over a period of about 5 hours. A current of 80nA in response to a solution of 10mmol glucose was obtained during the testing.

Example 9

[0065] A water-miscible conductive ink according to an embodiment of the present invention was formulated by mixing 120mg of glucose dehydrogenase-PQQ adduct (commercially available from Toyobo, at greater than 500 IU/mg) with 6.1g of a 3.5% aqueous solution of redox polymer 700. The resulting mixture was added to 65g of Coates 66756 water-miscible graphite paste. 930mg of

Cabosil LM150 Silica was then added and the resulting composition was mixed with a stirrer at 2000rpm for 10 minutes.

[0066] The water-miscible conductive ink was printed onto a 3.75 mm² electrode artwork with a silver/silver chloride reference electrode and dried for 20 minutes at 75 °C to form an enzymatic electrochemical-based sensor. The enzymatic electrochemical-based sensor was tested in a flow-through cell as described in Example 4, at 300mV applied potential, and using glucose in phosphate buffered saline solution, flowed at 0.7 ml/min. The current response obtained is depicted by the data of FIG. 14. The current response was stable over the 2.5 hours of continuous sensor operation and testing depicted in FIG. 14.

Further Embodiments

[0067] The invention additionally comprises the following embodiments:

1. A water-miscible conductive ink for use in an enzymatic electrochemical-based sensor, the water-miscible conductive ink comprising:

- a conductive material;
- an enzyme;
- a mediator; and
- a binding agent,

wherein the conductive material, enzyme, mediator, and binding agent are formulated as a water-miscible aqueous-based dispersion and wherein the binding agent becomes operatively water-insoluble upon drying.

2. The water miscible conductive ink of embodiment 1, wherein the conductive material is a finely divided conductive particle material.

3. The water miscible conductive ink of embodiment 2, wherein the finely divided conductive particle material is at least one of a carbon black material, a graphite material, a platinum particle material, a platinumized carbon material a gold particle material, a platinum/palladium alloy particle material, a palladium particle material, a ruthenium particle material, or a cerium particle material.

4. The water miscible conductive ink of any one of embodiments 1 to 3, wherein the enzyme is a glucose oxidizing enzyme.

5. The water miscible conductive ink of embodiment 4, wherein the glucose oxidizing enzyme is glucose oxidase.

6. The water miscible conductive ink of embodiment

4, wherein the glucose oxidizing enzyme is pyrrolo-quinoline-quinone (PQQ) glucose dehydrogenase.

7. The water miscible conductive ink of any one of embodiments 1 to 6, wherein the mediator is: ferrocene; ferricyanide; a polymeric mediator; or tetrathiafulvalene/tetracyanoquinodimethane.

8. The water miscible conductive ink of any one of embodiments 1 to 7, wherein the binding agent includes a resin polymer and a counter ion.

9. The water miscible conductive ink of embodiment 8, wherein the counter ion is a volatile counter ion.

10. The water miscible conductive ink of any one of embodiments 1 to 7, wherein the binding agent includes a resin polymer and a water-miscible organic co-solvent that is removed from the water-miscible conductive ink upon drying of the water-miscible conductive ink.

11. The water miscible conductive ink of embodiment 10, wherein the water-miscible organic co-solvent is at least one of an alcohol, a glycol ether, methyl carbitol, butyl carbitol, ethylene glycol, ethylene glycol diacetate, diacetone alcohol, and triethyl phosphate.

12. The water miscible conductive ink of any one of embodiments 1 to 11, wherein the binding agent includes at least one of a copolymer of polystyene-co-maleic anhydride, a hydrolyzed copolymer of polystyene-co-maleic anhydride, a copolymer of polystyene-co-maleic anhydride which is partially hydrolyzed, a partially esterified copolymer of polystyene-co-maleic anhydride, and a phosphoric acid functional polymer derived by the reaction of phosphoric acid with epoxy resin.

13. The water miscible conductive ink of any one of embodiments 1 to 11, wherein the binding agent contains a copolymer of at least one of an acrylic acid monomer, a methacrylic acid monomer, an itaconic acid monomer, a maleic acid monomer, and at least one of a methyl methacrylate monomer, a styrene monomer, an ethyl acrylate monomer, an isopropyl acrylate monomer, a butyl acrylate monomer, an acrylonitrile monomer, a methyl styrene monomer, a vinyl benzoate monomer, an acrylamide monomer, and a hydroxymethyl methacrylate monomer.

14. The water miscible conductive ink of any one of embodiments 1 to 13, further including a water-miscible co-solvent.

15. An enzymatic electrochemical-based sensor comprising:

a substrate; and

a conductive layer formed from a dried water-miscible conductive ink according to any one of embodiments 1 to 14.

16. The enzymatic electrochemical-based sensor of embodiment 15, wherein the conductive layer has a conductivity of less than about 10 kΩ.

17. The enzymatic electrochemical-based sensor of embodiment 16, wherein the conductive layer has a conductivity of less than about 1 kΩ.

18. The enzymatic electrochemical-based sensor of any one of embodiments 15 to 17, wherein the dried binding agent of the conductive layer serves as a dialytic membrane.

19. The enzymatic electrochemical-based sensor of any one of embodiments 15 to 18, wherein the substrate is a working electrode.

20. The enzymatic electrochemical-based sensor of any one of embodiments 15 to 19, wherein the conductive layer serves as an electrode of the enzymatic electrochemical-based sensor.

21. The enzymatic electrochemical-based sensor of any one of embodiments 15 to 20, wherein the conductive layer serves as a working electrode of the enzymatic electrochemical-based sensor.

22. The enzymatic electrochemical-based sensor of any one of embodiments 15 to 21, wherein the enzyme, mediator, and binding agent are essentially uniformly distributed throughout the conductive layer.

23. A method for manufacturing a portion of an enzymatic electrochemical-based sensor, the method comprising:

applying a water-miscible conductive ink according to any one of embodiments 1 to 14 to a substrate of an enzymatic electrochemical-based sensor; and
drying the water-miscible conductive ink to form a conductive layer on the substrate that includes an operatively water-insoluble binding agent.

24. The method of embodiment 23, wherein the applying step is accomplished using a screen printing technique.

25. The method of embodiment 23 or embodiment 24, wherein the drying step is accomplished at a temperature of about 75 °C for a time period of about 20

minutes.

26. The method of any one of embodiments 23 to 25, wherein the drying step immobilizes the water-miscible conductive ink to the substrate, thus forming the conductive layer.

27. The method of any one of embodiments 23 to 26, wherein the applying step applies a water-miscible conductive ink that includes a polymeric mediator.

28. The method of any one of embodiments 23 to 27, wherein the drying step forms a conductive layer that serves as an electrode of the enzymatic electrochemical-based sensor.

29. The method of embodiment 28, wherein the drying step forms a conductive layer that serves as a working electrode of the enzymatic electrochemical-based sensor.

30. The method of any one of embodiments 23 to 29, wherein the applying step applies a water-miscible conductive ink formulated as a uniform dispersion.

31. The method of embodiment 32, wherein the drying step forms a conductive layer containing uniformly distributed enzyme, mediator and conductive material.

32. The method of any one of embodiments 23 to 31, wherein the applying step applies a water-miscible conductive ink containing conductive material that includes finely divided conductive particles with a size of less than 100 microns.

[0068] It should be understood that various alternatives to the embodiments of the invention described herein may be employed in practicing the invention. It is intended that the following claims define the scope of the invention and that methods and structures within the scope of these claims and their equivalents be covered thereby.

Claims

1. A water-miscible conductive ink for use in an enzymatic electrochemical-based sensor, the water-miscible conductive ink comprising:

a conductive material;
an enzyme;
a mediator; and
a binding agent,

- wherein the conductive material, enzyme, mediator, and binding agent are formulated as a water-miscible aqueous-based dispersion and wherein the binding agent becomes operatively water-insoluble upon drying; and
 wherein the binding agent includes a resin polymer and a counter ion, and/or the binding agent contains a copolymer of at least one of an acrylic acid monomer, a methacrylic acid monomer, an itaconic acid monomer, a maleic acid monomer, and at least one of a methyl methacrylate monomer, a styrene monomer, an ethyl acrylate monomer, an isopropyl acrylate monomer, a butyl acrylate monomer, an acrylonitrile monomer, a methyl styrene monomer, a vinyl benzoate monomer, an acrylamide monomer, and a hydroxymethyl methacrylate monomer.
2. The water miscible conductive ink of claim 1, wherein the conductive material is a finely divided conductive particle material.
 3. The water miscible conductive ink of claim 2, wherein the finely divided conductive particle material is at least one of a carbon black material, a graphite material, a platinum particle material, a platinized carbon material a gold particle material, a platinum/palladium alloy particle material, a palladium particle material, a ruthenium particle material, or a cerium particle material.
 4. The water miscible conductive ink of any one of claims 1 to 3, wherein the enzyme is a glucose oxidizing enzyme.
 5. The water miscible conductive ink of claim 4, wherein the glucose oxidizing enzyme is glucose oxidase.
 6. The water miscible conductive ink of claim 4, wherein the glucose oxidizing enzyme is pyrrolo-quinoline-quinone (PQQ) glucose dehydrogenase.
 7. The water miscible conductive ink of any one of claims 1 to 6, wherein the mediator is: ferrocene; ferricyanide; a polymeric mediator; or tetrathiafulvalene/tetracyanoquinodimethane.
 8. The water miscible conductive ink of any one of claims 1 to 7, wherein the counter ion is a volatile counter ion.
 9. The water miscible conductive ink of any one of claims 1 to 8, further including a water-miscible co-solvent.
 10. An enzymatic electrochemical-based sensor comprising:
 - a substrate; and
 - a conductive layer formed from a dried water-miscible conductive ink according to any one of claims 1 to 9.
 11. The enzymatic electrochemical-based sensor of claim 10, wherein the substrate is a working electrode.
 12. The enzymatic electrochemical-based sensor of claim 10, wherein the conductive layer serves as a working electrode of the enzymatic electrochemical-based sensor.
 13. A method for manufacturing a portion of an enzymatic electrochemical-based sensor, the method comprising:
 - applying a water-miscible conductive ink according to any one of claims 1 to 9 to a substrate of an enzymatic electrochemical-based sensor; and
 - drying the water-miscible conductive ink to form a conductive layer on the substrate that includes an operatively water-insoluble binding agent.
 14. The method of claim 13, wherein the applying step is accomplished using a screen printing technique.
 15. The method of claim 13 or claim 14, wherein the drying step is accomplished at a temperature of about 75 °C for a time period of about 20 minutes.

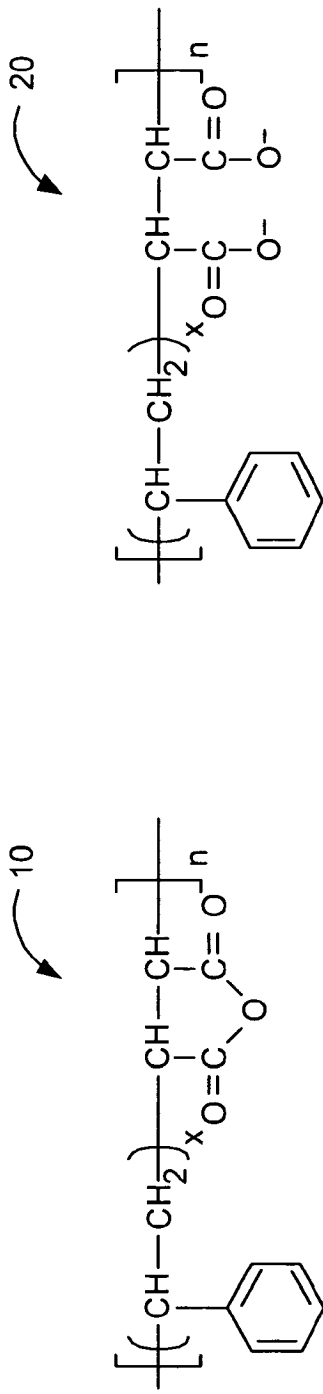

FIG. 2

FIG. 1

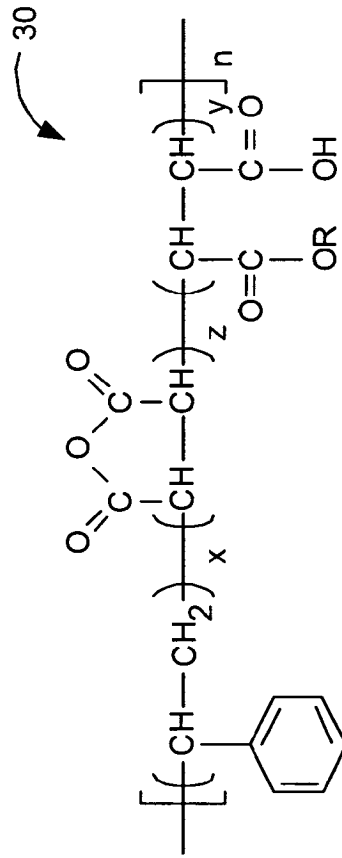

FIG. 3

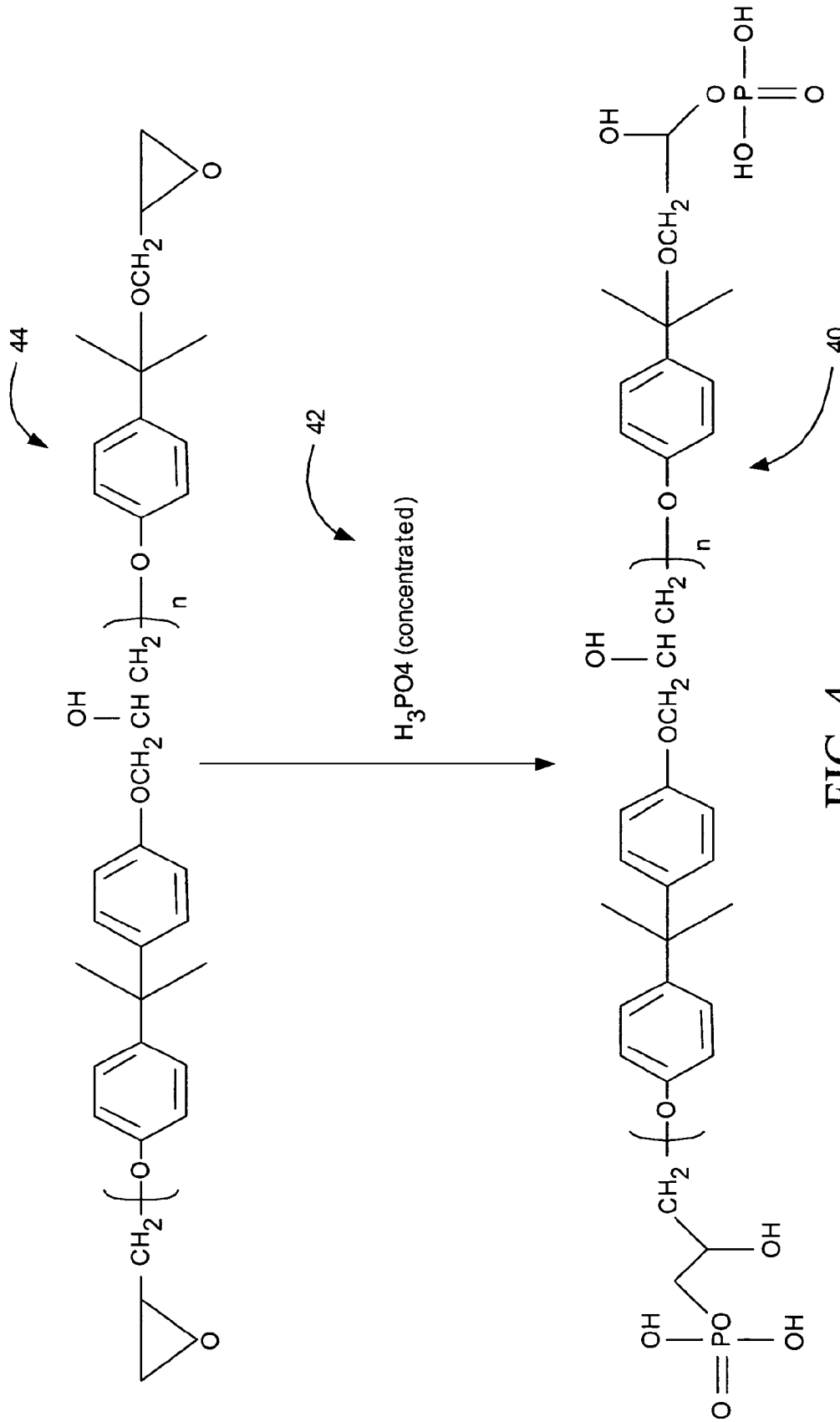

FIG. 4

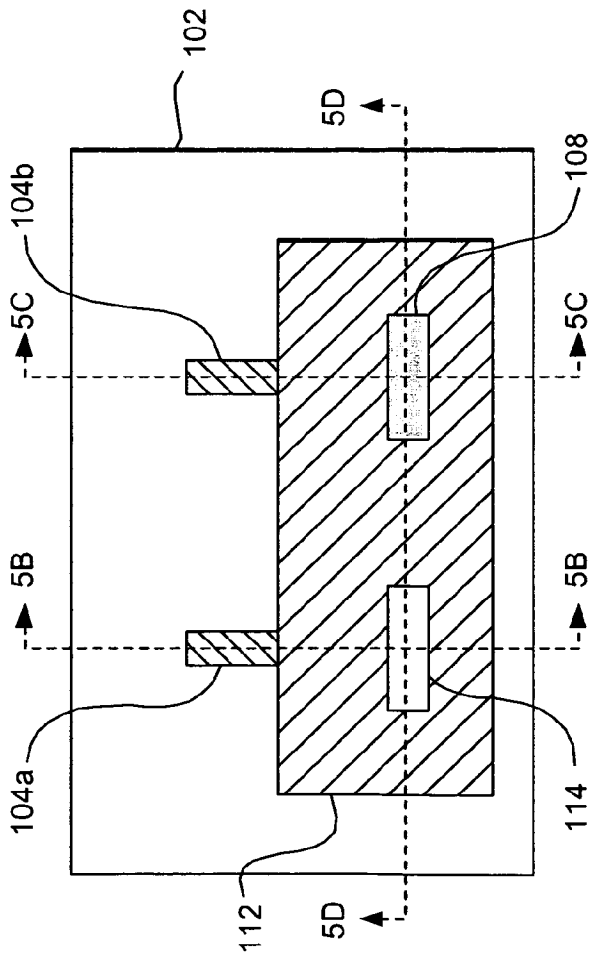

FIG. 5A

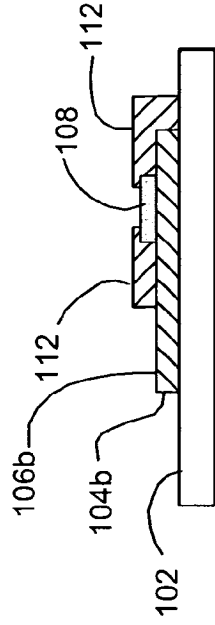

FIG. 5C

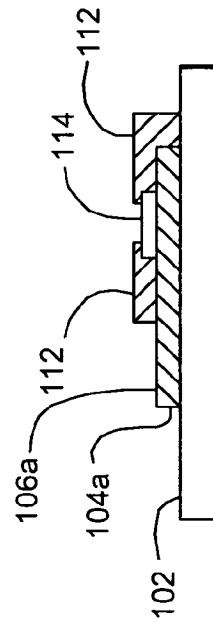

FIG. 5B

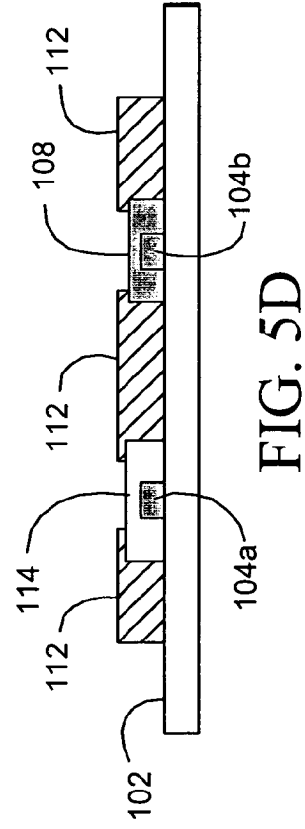

FIG. 5D

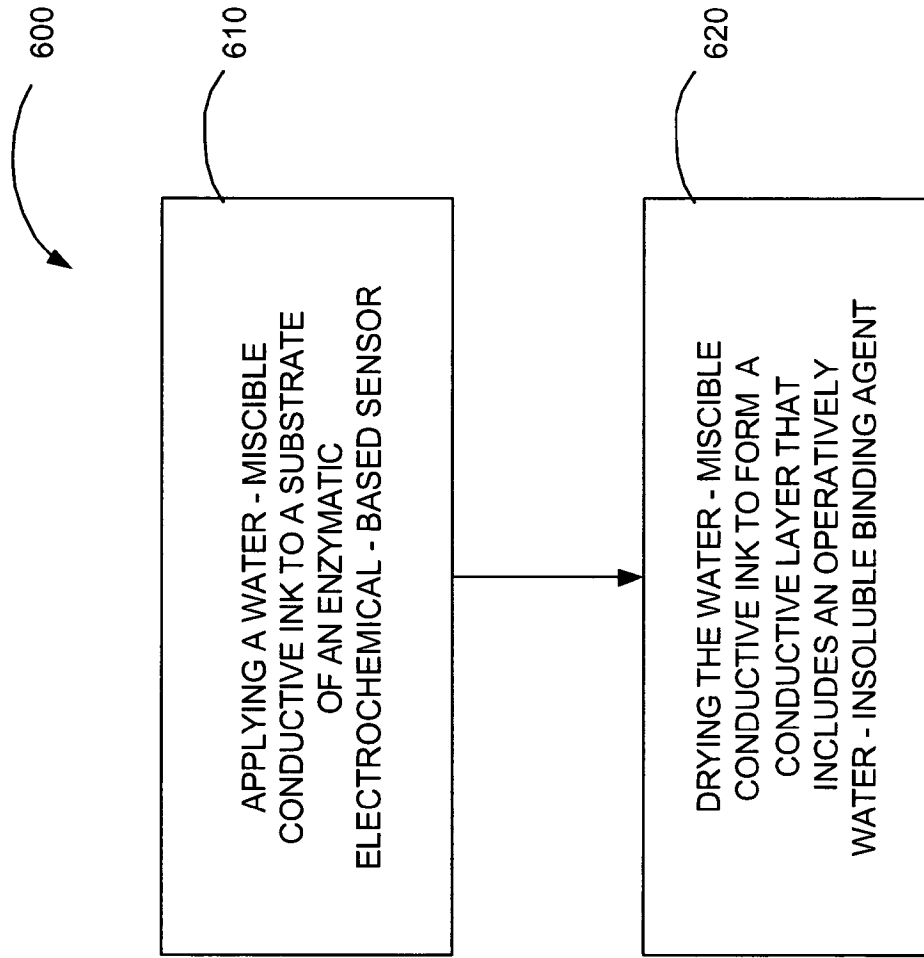

FIG. 6

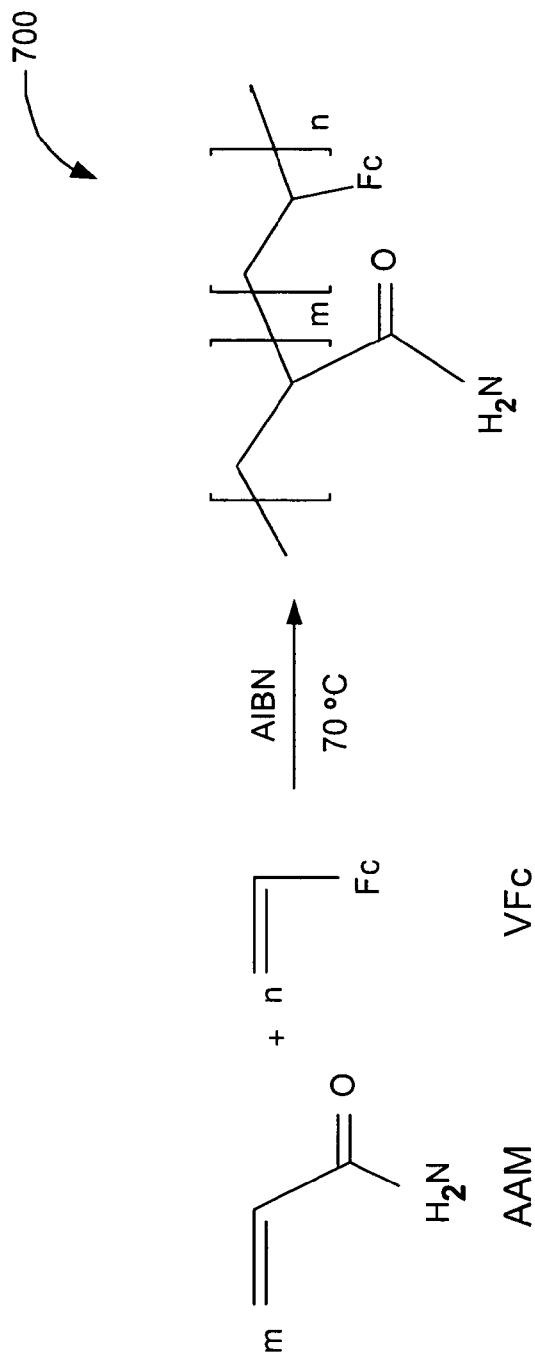

FIG. 7

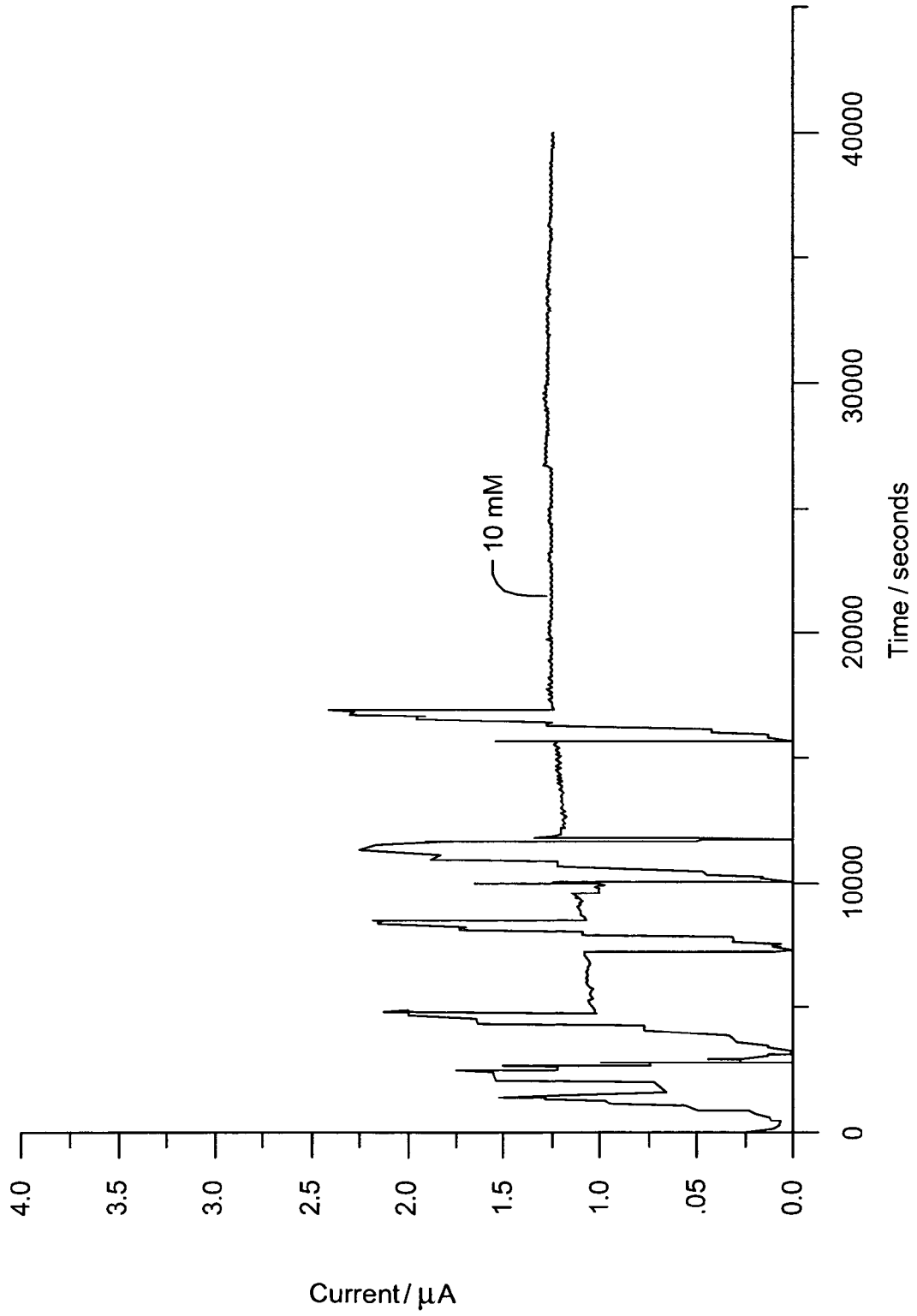

FIG. 8B

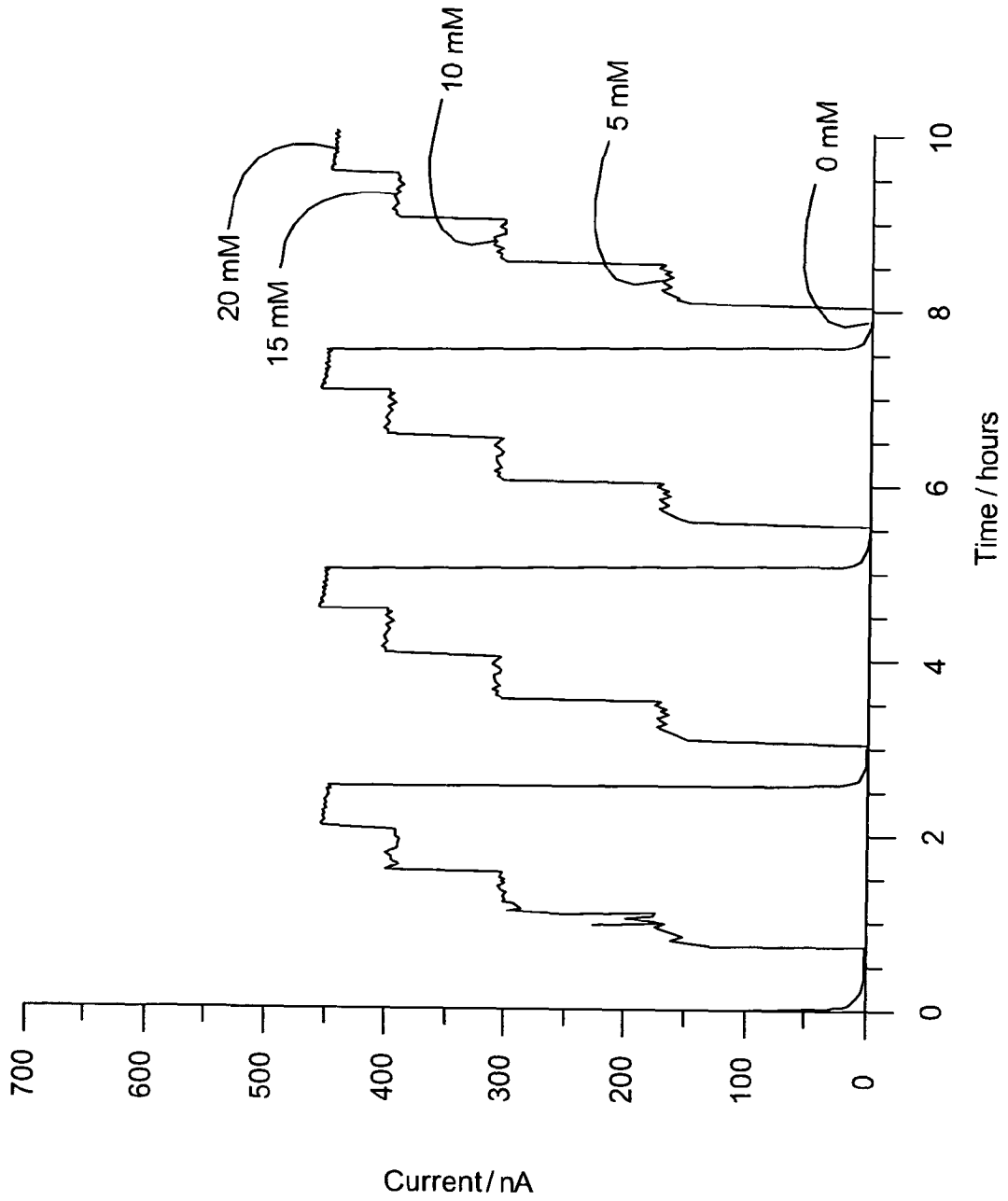

FIG. 9

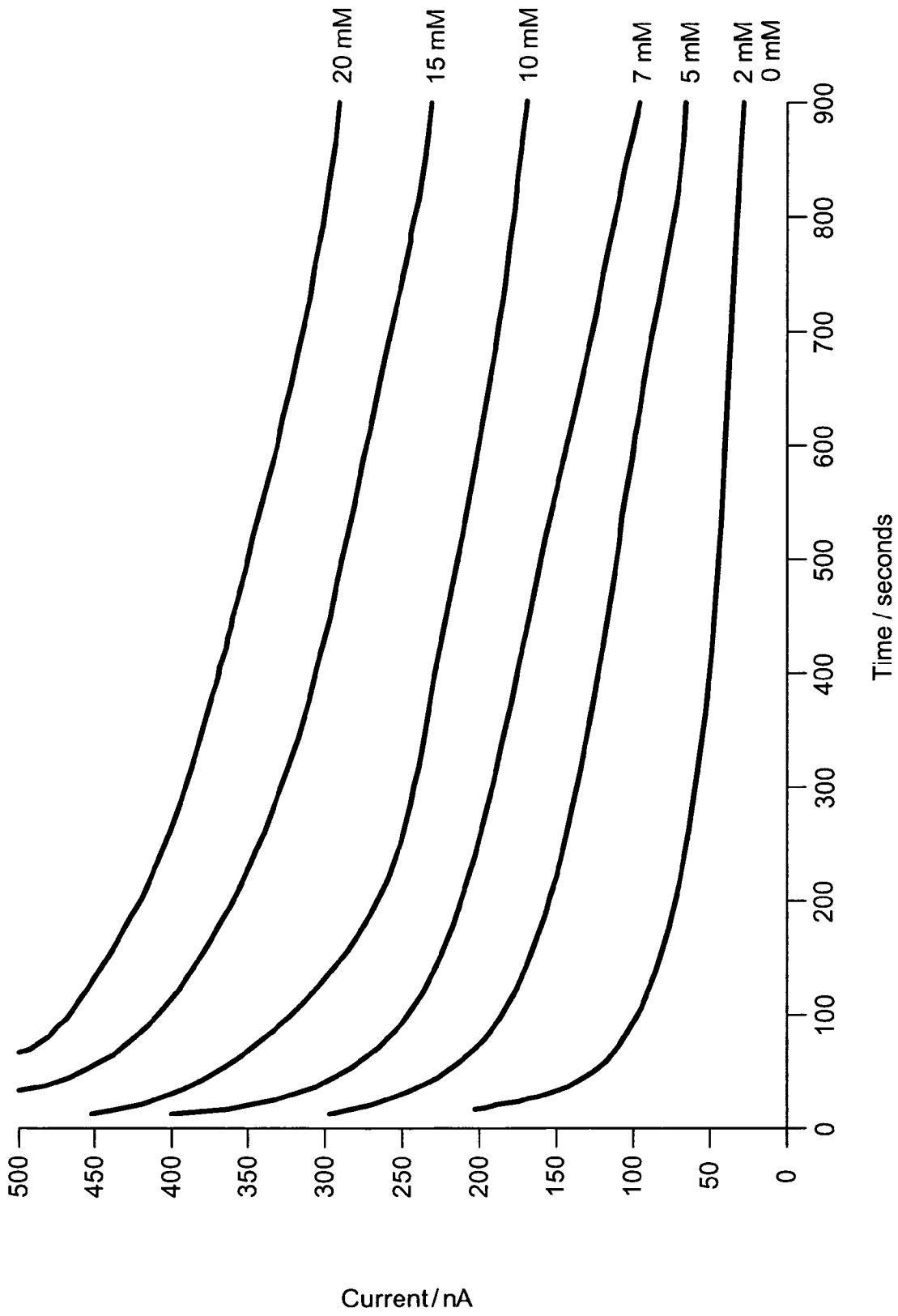

FIG. 10

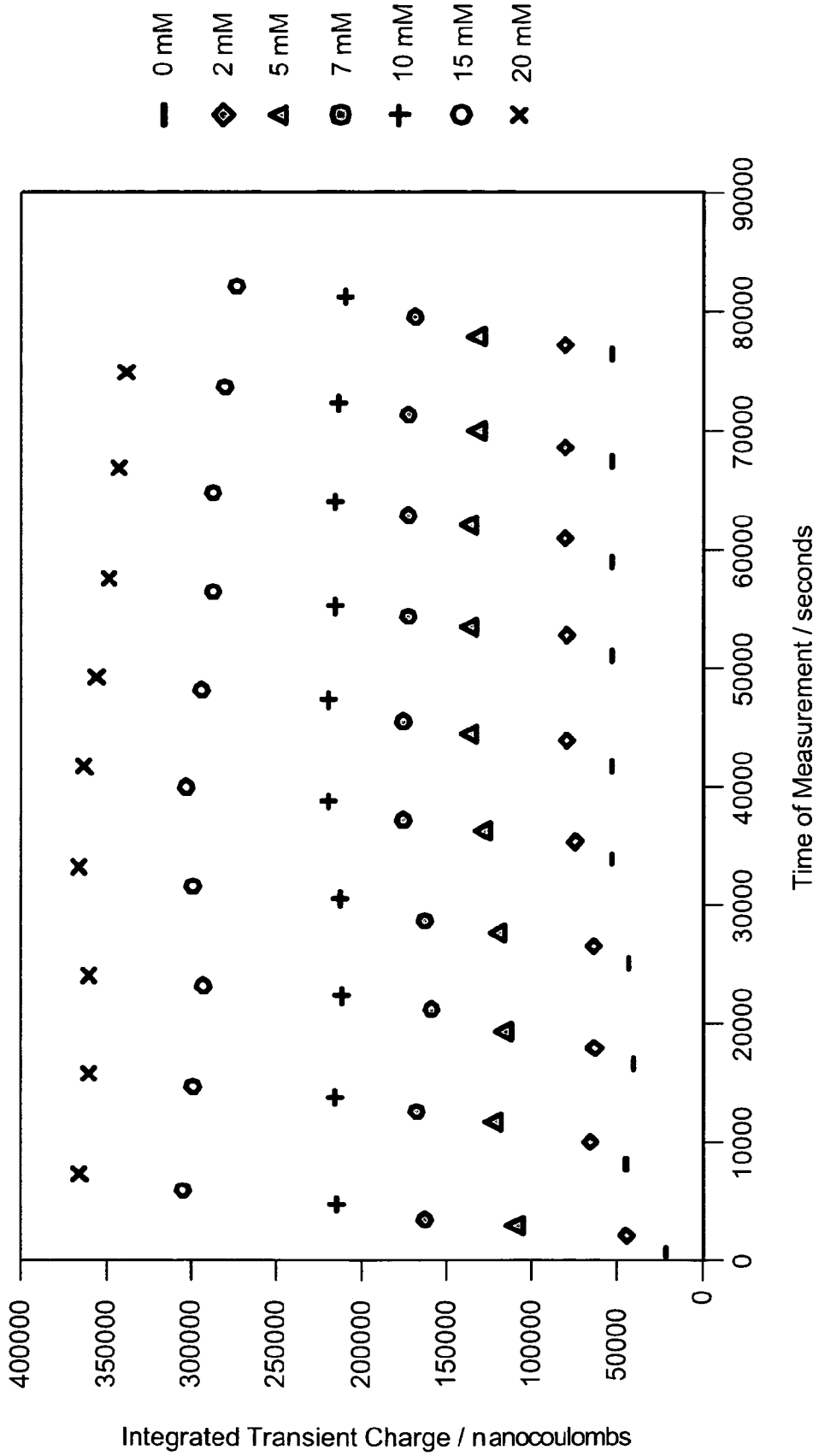

FIG. 11

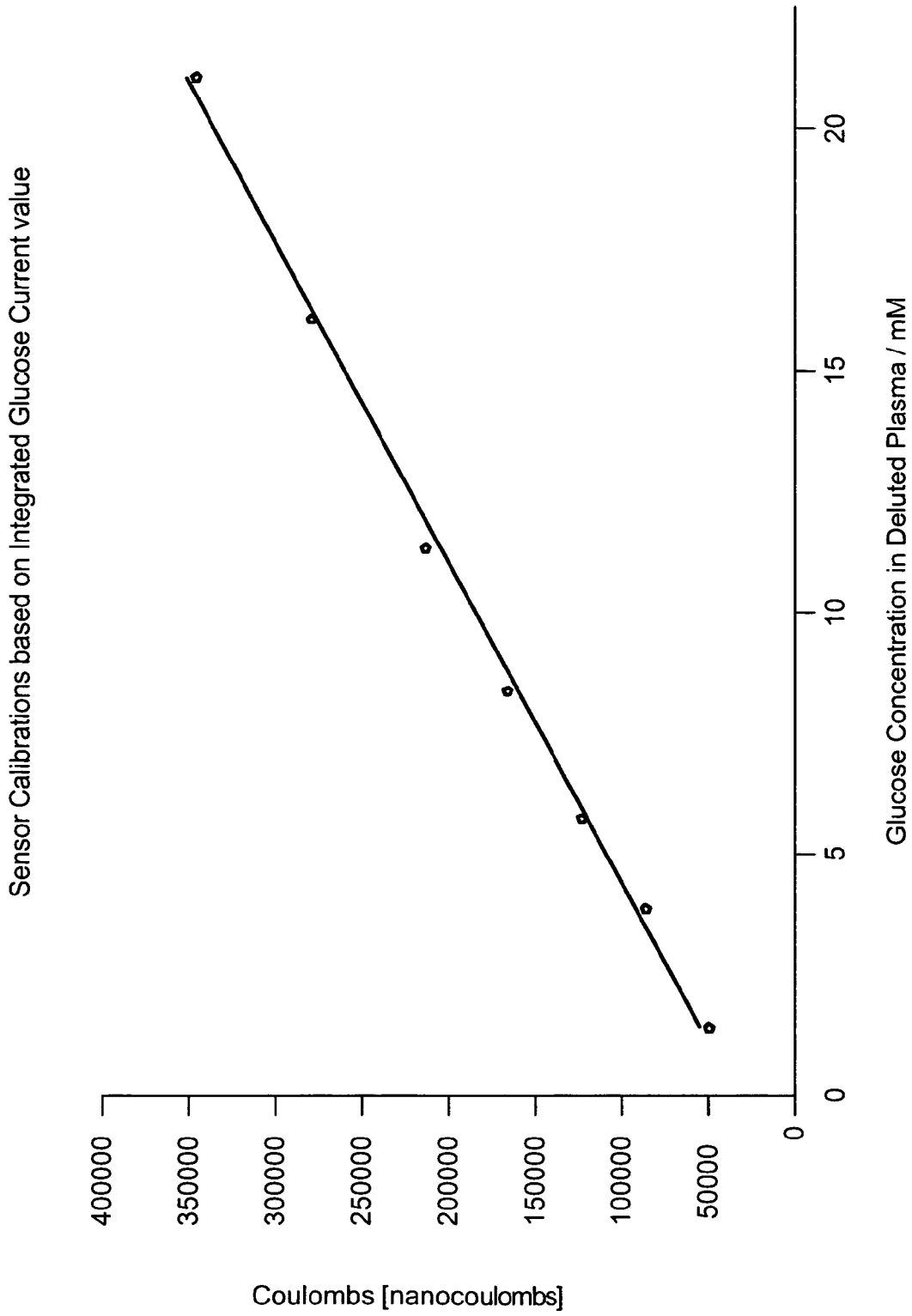

FIG. 12

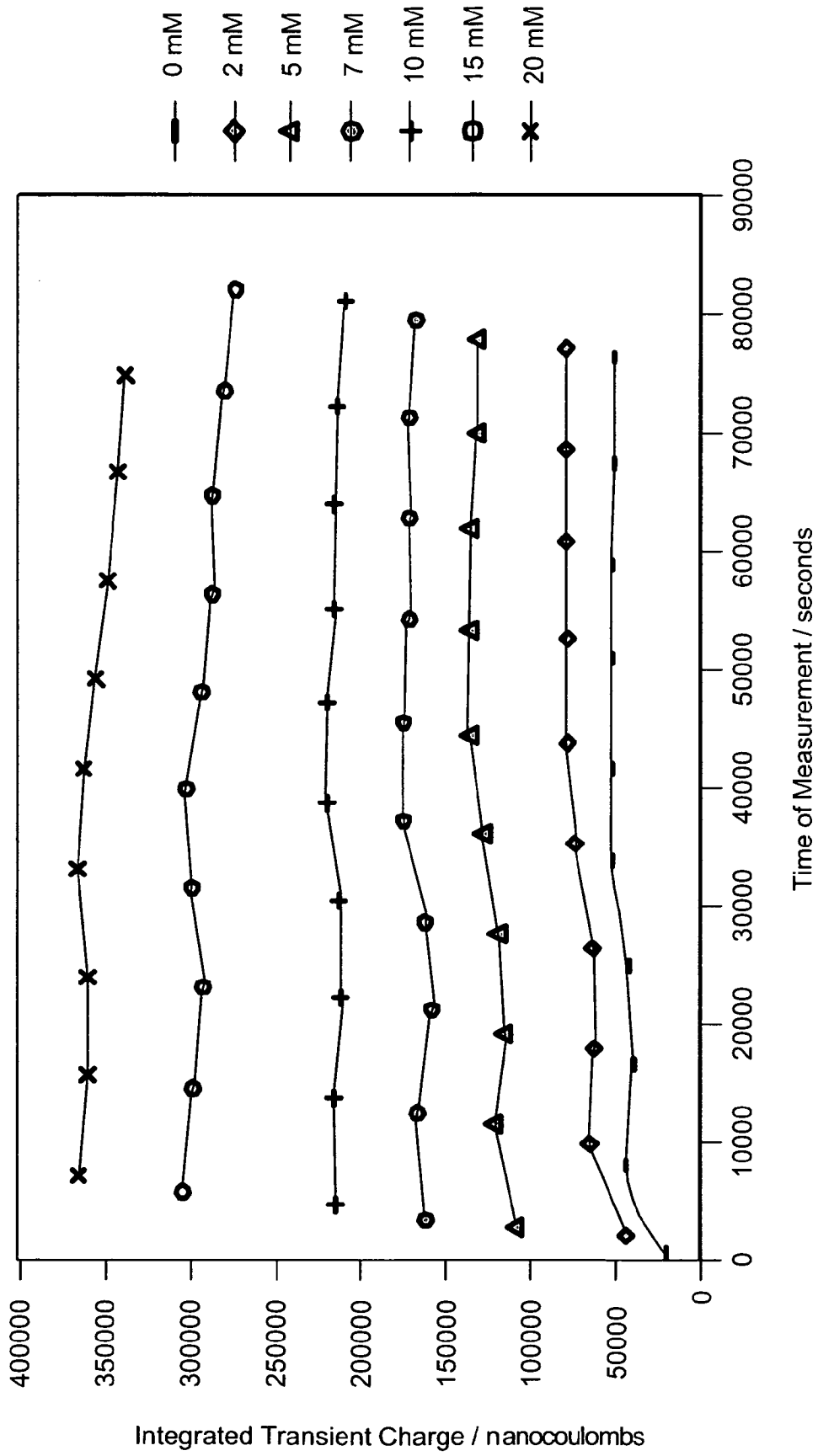

FIG. 13

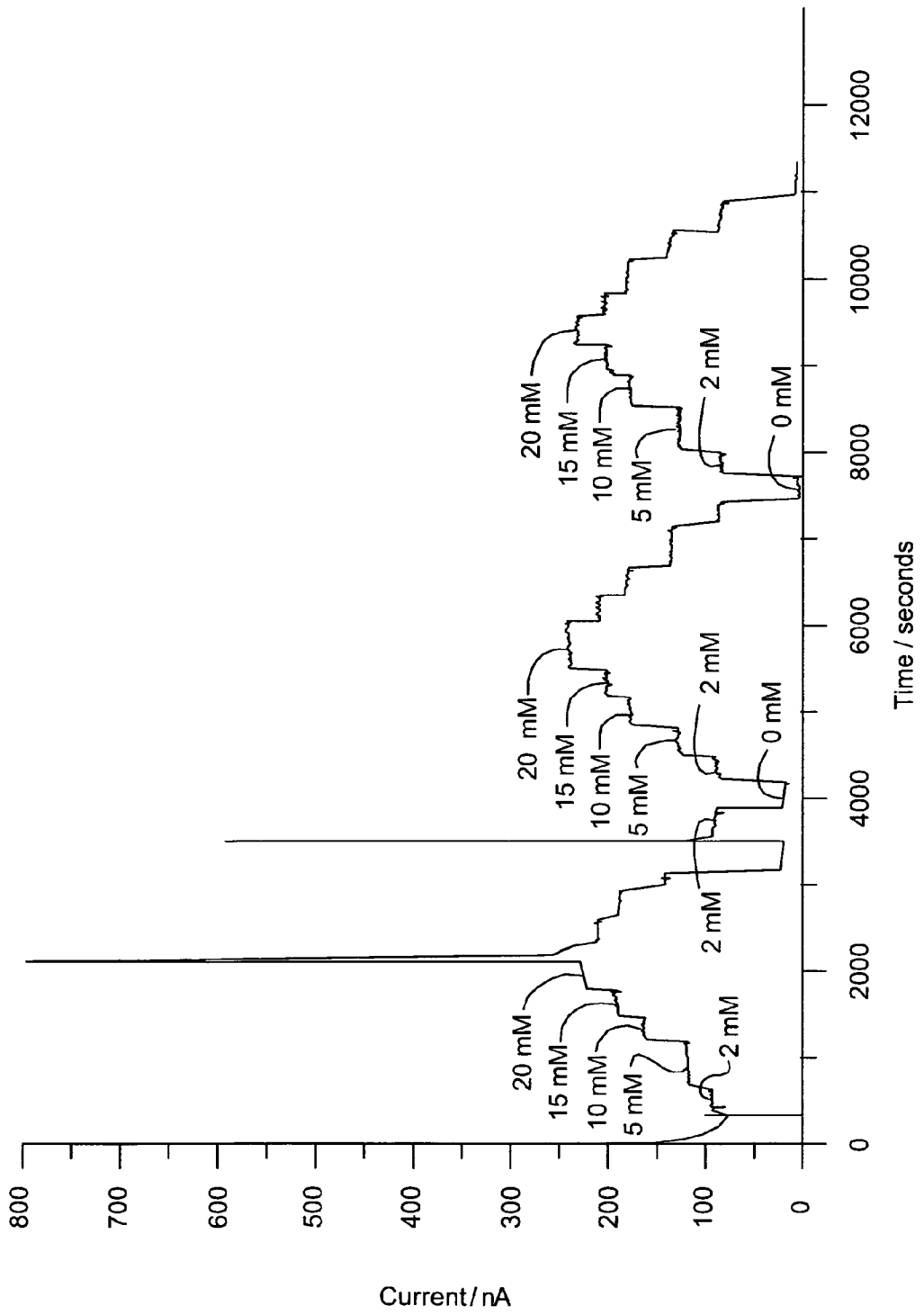

FIG. 14



EUROPEAN SEARCH REPORT

Application Number
EP 10 17 9721

DOCUMENTS CONSIDERED TO BE RELEVANT			
Category	Citation of document with indication, where appropriate, of relevant passages	Relevant to claim	CLASSIFICATION OF THE APPLICATION (IPC)
Y	EP 0 352 925 A (CAMBRIDGE LIFE SCIENCES PLC) 31 January 1990 (1990-01-31) * column 4, line 8 - column 8, line 40 * -----	1-15	INV. C12Q1/00 A61B5/00 G01N27/406
Y	PATENT ABSTRACTS OF JAPAN vol. 1996, no. 2, 29 February 1996 (1996-02-29) & JP 07, 270374, A, (TOPPAN PRINTING CO LTD), 20 October 1995 (1995-10-20) * the whole document * -----	1-15	
Y	US 6 764 581 B1 (FORROW NIGEL J ET AL) 20 July 2004 (2004-07-20) * claims 1-12 * -----	6	
Y	EP 0 992 589 A (MATSUSHITA ELECTRIC INDUSTRIAL CO., LTD) 12 April 2000 (2000-04-12) *the whole document, especially paragraph [0021]* -----	6	
Y	US 3 349 055 A (AKIRA TAGUCHI) 24 October 1967 (1967-10-24) * columns 1,4 * -----	1-5,7-15	
			TECHNICAL FIELDS SEARCHED (IPC)
			C12Q A61B G01N C09D
The present search report has been drawn up for all claims			
Place of search Munich		Date of completion of the search 18 November 2010	Examiner Lindberg, Pia
CATEGORY OF CITED DOCUMENTS X : particularly relevant if taken alone Y : particularly relevant if combined with another document of the same category A : technological background O : non-written disclosure P : intermediate document		T : theory or principle underlying the invention E : earlier patent document, but published on, or after the filing date D : document cited in the application L : document cited for other reasons & : member of the same patent family, corresponding document	

1
EPO FORM 1503 03.82 (P04C01)

ANNEX TO THE EUROPEAN SEARCH REPORT
ON EUROPEAN PATENT APPLICATION NO.

EP 10 17 9721

This annex lists the patent family members relating to the patent documents cited in the above-mentioned European search report. The members are as contained in the European Patent Office EDP file on
The European Patent Office is in no way liable for these particulars which are merely given for the purpose of information.

18-11-2010

Patent document cited in search report		Publication date	Patent family member(s)	Publication date
EP 0352925	A	31-01-1990	AU 621913 B2	26-03-1992
			AU 3821689 A	01-02-1990
			CA 1311522 C	15-12-1992
			DE 68920223 D1	09-02-1995
			DE 68920223 T2	13-07-1995
			DK 371489 A	29-01-1990
			FI 893542 A	29-01-1990
			GB 2221300 A	31-01-1990
			HU 51326 A2	28-04-1990
			IE 60578 B1	27-07-1994
			IL 90983 A	25-01-1994
			JP 2099849 A	11-04-1990
			JP 3056221 B2	26-06-2000
			MX 170142 B	09-08-1993
			NO 893019 A	29-01-1990
			SU 1836428 A3	23-08-1993
US 5160418 A	03-11-1992			

JP 07270374	A	20-10-1995	JP 3379202 B2	24-02-2003

US 6764581	B1	20-07-2004	AT 376594 T	15-11-2007
			AU 742574 B2	10-01-2002
			AU 9129798 A	29-03-1999
			BR 9812017 A	26-09-2000
			CA 2302449 A1	18-03-1999
			DE 69838616 T2	28-08-2008
			EP 2093296 A2	26-08-2009
			EP 1012326 A1	28-06-2000
			JP 2001516039 T	25-09-2001
			WO 9913100 A1	18-03-1999

EP 0992589	A	12-04-2000	CN 1250161 A	12-04-2000
			DE 69917403 D1	24-06-2004
			DE 69917403 T2	28-10-2004
			JP 3694424 B2	14-09-2005
			JP 2000171428 A	23-06-2000
			US 6773564 B1	10-08-2004

US 3349055	A	24-10-1967	NONE	

EPO FORM P0459

For more details about this annex : see Official Journal of the European Patent Office, No. 12/82

REFERENCES CITED IN THE DESCRIPTION

This list of references cited by the applicant is for the reader's convenience only. It does not form part of the European patent document. Even though great care has been taken in compiling the references, errors or omissions cannot be excluded and the EPO disclaims all liability in this regard.

Patent documents cited in the description

- US 5089112 A [0002]
- US 6284478 A [0002]
- EP 1621636 A [0019]
- EP 1630234 A [0019]
- EP 1642984 A [0019]

专利名称(译)	可与水混溶的导电油墨，用于基于酶电化学的传感器		
公开(公告)号	EP2270195A1	公开(公告)日	2011-01-05
申请号	EP2010179721	申请日	2006-04-11
[标]申请(专利权)人(译)	生命扫描苏格兰有限公司		
申请(专利权)人(译)	LIFESCAN SCOTLAND LTD		
当前申请(专利权)人(译)	LIFESCAN SCOTLAND LTD		
[标]发明人	RODGERS JAMES IAIN LIU ZUIFANG MACLENNAN MARGARET MOFFAT JAMES LILLIE GEOFFREY MACDONALD MICHAEL MCNEILAGE ALAN WATSON		
发明人	RODGERS, JAMES IAIN LIU, ZUIFANG MACLENNAN, MARGARET MOFFAT, JAMES LILLIE, GEOFFREY MACDONALD, MICHAEL MCNEILAGE, ALAN WATSON		
IPC分类号	C12Q1/00 A61B5/00 G01N27/406		
CPC分类号	C09D11/52		
优先权	11/118947 2005-04-28 US 11/118507 2005-04-28 US 60/671026 2005-04-12 US 11/118894 2005-04-28 US		
外部链接	Espacenet		

摘要(译)

用于基于酶电化学的传感器的水混溶性导电油墨包括导电材料，酶，介体和粘合剂。将导电材料，酶，介体和粘合剂配制成水混溶性水分散体，其中粘合剂在干燥时变得可操作地不溶于水。

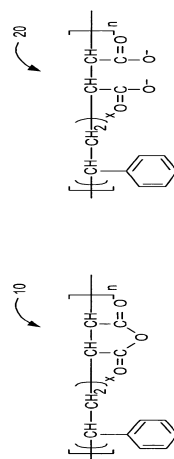

FIG. 1

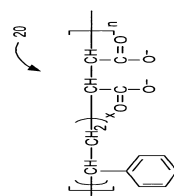

FIG. 2

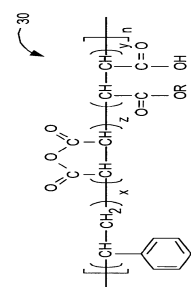

FIG. 3