



(12) **EUROPEAN PATENT APPLICATION**

(43) Date of publication: **04.01.2006 Bulletin 2006/01**  
 (51) Int Cl.: **A61B 5/00 (2006.01) A61B 5/04 (2006.01)**  
**A61B 5/053 (2006.01)**  
 (21) Application number: **05254015.0**  
 (22) Date of filing: **28.06.2005**

(84) Designated Contracting States:  
**AT BE BG CH CY CZ DE DK EE ES FI FR GB GR HU IE IS IT LI LT LU MC NL PL PT RO SE SI SK TR**  
 Designated Extension States:  
**AL BA HR LV MK YU**  
 (30) Priority: **28.06.2004 US 583478 P**  
**24.06.2005 US 165796**  
 (71) Applicant: **The Alfred E Mann Foundation for Scientific Research**  
**Santa Clarita, CA 91380-9005 (US)**

(72) Inventors:  
 • **Karr, Lawrence J.**  
**Santa Monica**  
**California 90402 (US)**  
 • **Schulman, Joseph H.**  
**Santa Clarita**  
**California 91387 (US)**  
 (74) Representative: **Carter, Stephen John et al**  
**Mewburn Ellis LLP**  
**York House**  
**23 Kingsway**  
**London WC2B 6HP (GB)**

(54) **Neural prosthetic with touch-like sensing**

(57) An apparatus and method is related to providing sensing functions that are similar to "human touch" when located in a prosthetic device such as a BION microstimulator that is implanted in a patient. The apparatus includes a power circuit, a communication circuit, and a sensor circuit. The power circuit provides power to the communication circuit and the sensor circuit. The sensor cooperates with the communication circuit, which com-

municates to the brain. The sensor uses various techniques to detect changes in the environment for the surrounding tissue using criteria such as reflectivity, impedance, conductivity, return signal spectrum, return signal rate, and return signal phase to name a few. For example, the impedance observed by the sensor changes when: the skin tissue is deformed around the sensor, or when the skin is surrounded by water. The sensory information is interpreted by the brain as an analog of touch or feel.

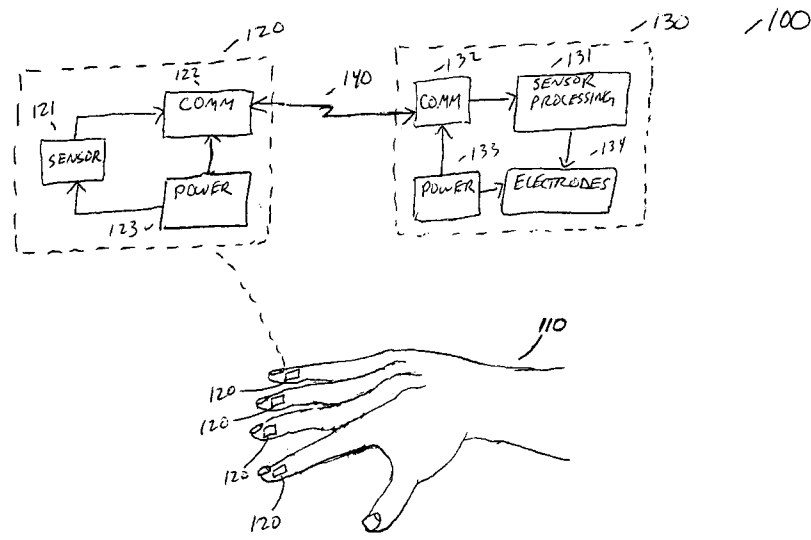

FIG. 1 (INFORMAL DRAFT)

EP 1 611 841 A1

## Description

### Related Application Data

[0001] The present application claims the benefit under 35 U.S.C. § 119(e) to Provisional Patent Application No. 60/583,478, filed on June 28, 2004, and titled "Touch-Like Sensing In Neural Prosthetics."

### Field of the Invention

[0002] The present disclosure relates generally to prosthetic devices. More particularly, the present disclosure relates to an apparatus and method for providing sensing functions that are similar to "human touch" when located in a prosthetic device such as a BION microstimulator that is implanted in a patient (BION is a registered trademark of the Advanced Bionics Corporation of Santa Clarita, CA).

### Background of the Invention

[0003] Bionics is a discipline focusing on the application of advanced technologies to biological systems. Generally speaking, a bionic is a manufactured device or engineered tissue that substitutes for, or augments, the function of a natural limb, organ or other portion of a biological body. Although commonly thought of within the context of science fiction, significant strides have been made in the field of bionics. Research in bionics offers the possibility of restoring function to impaired and damaged biological systems.

[0004] One significant application of bionics is in the area of vision. Over 30 million people have been subject to retinal degenerative diseases. Retinal degenerative diseases can generally be broken into two categories: Retinitis Pigmentosa (RP) and Age-related Macular Degeneration (AMD).

[0005] Retinitis Pigmentosa (RP) is a general term for a number of diseases that predominately affect the photoreceptor layer cells of the retina. The injured photoreceptor cell layer reduces the retina's ability to sense light. Most cases of RP affect the mid-peripheral vision first, which sometimes progresses to affect the far-periphery and the central areas of vision. This narrowing of the field of vision (aka "tunnel vision") can sometimes result in complete blindness.

[0006] Age-Related Macular Degeneration (AMD) refers to a degenerative condition that occurs most frequently in the elderly, where decreased function is observed in specific cellular layers of the retina's macula. The outer retina and inner retina photoreceptor layer are affected such that patients experience a loss of their central vision, which affects their ability to read and perform visually demanding tasks.

[0007] Significant research has been conducted in the areas of artificial vision to develop an artificial silicon retina (ASR). An ASR is a micro-electronic circuit (or micro-

chip) that is implantable in the body and arranged to stimulate damaged retinal cells, allowing the patient to send visual signals to the brain. An ASR contains thousands of light sensitive cells that convert the light into a series of electrical pulses that mimic the functions of the cones and rods in the eye. Clinical trials have been conducted for ASR devices, although currently vision quality is relatively poor. Additional research in ASR-type devices continues to progress and the promise of restored vision, even to the blind, may be within our grasp.

[0008] Another significant application of bionics is in the area of hearing. Hearing loss may be either congenital (acquired either genetically or in utero) or acquired. Various types of hearing loss include: conductive hearing loss, sensorineural hearing loss, or neural hearing loss.

[0009] Conductive hearing loss is caused by a problem in the outer or middle ear, wherein the sound path is blocked impairing the ability of the eardrum and bones from vibrating. Conductive losses are usually mild or moderate in nature and in some cases a conductive hearing loss can be temporary. In most cases of conductive hearing loss, hearing can be either restored through surgery and/or medication, or improved with hearing aids.

[0010] Sensorineural hearing loss is caused by a problem in the inner ear or cochlea. A damaged inner ear does not change sound waves into the tiny electrical pulses that the auditory nerves need to send sound information to the brain. Sensorineural hearing losses are usually permanent, and cannot typically be repaired through surgical procedures. Conventional hearing aids can usually help in mild to severe hearing loss.

[0011] Neural hearing loss is due to a problem in the nerve pathway, wherein the auditory nerve is damaged or missing such that signals cannot be sent to the brain. In very rare cases, hearing loss is caused by the absence of or damage to the auditory nerve, resulting in a neural hearing loss. Conventional hearing aids are of little benefit because to a neural hearing loss since the nerve is unable to pass on information to the brain.

[0012] Cochlear implants can be a very effective option for those with severe, profound hearing loss who obtain little or no benefit from conventional acoustic amplification such as hearing aids. However, cochlear implants will not help unless there is some auditory nerve function. A cochlear implant is an electronic device that consists of two main parts: an internal implanted part called the implant, and an external part known as the speech processor. Sounds are picked up by a microphone and turned into an electrical signal. This signal goes to the speech processor where it is "coded" (turned into a special pattern of electrical pulses). The coded electrical pulses are sent to the coil and are then transmitted across the intact skin (by radio waves) to the implant. The implant sends a pattern of electrical pulses to the electrodes in the cochlea. The auditory nerve picks up these tiny electrical pulses and sends them to the brain. The brain recognizes these signals as sound.

[0013] The examples described above illustrate but a

few applications for bionics. While bionics cannot cure many of the ailments that exist, current developments present a number of opportunities for improving quality of life. Exciting new research in the field of bionics continues in such areas as drug delivery systems for chronic disabilities, neuromuscular stimulation devices that enable the activation or enhancement of motion to replace lost or impaired motor control, micro-stimulators to treat chronic disorders of the central nervous system, as well as many others.

### **Brief Description of the Drawings**

#### **[0014]**

FIGURE 1 illustrates an example operating environment for a neural prosthetic device;  
 FIGURE 2 illustrates an example process flow for another neural prosthetic device;  
 FIGURE 3 is a block diagram for yet another example neural prosthetic device;  
 FIGURE 4 is a block diagram for still another example neural prosthetic device;  
 FIGURE 5 is a block diagram for yet still another example neural prosthetic device;  
 FIGURE 6 is a block diagram for still yet another example neural prosthetic device;  
 FIGURE 7 is a block diagram for a neural prosthetic device that is arranged sense changes in impedance of an antenna by sensing frequency changes;  
 FIGURE 8 is a block diagram for a neural prosthetic device that is arranged sense changes in impedance of an antenna by sensing amplitude and phase changes; and  
 FIGURE 9 is a block diagram for a neural prosthetic device that is arranged sense changes in impedance of an antenna by locking a reference signal to a variable signal, arranged in accordance with at least one aspect of present invention.

### **Detailed Description of the Preferred Embodiment**

**[0015]** Throughout the specification, and in the claims, the term "connected" means a direct electrical connection between the things that are connected, without any intermediary devices. The term "coupled" means either a direct electrical connection between the things that are connected, or an indirect connection through one or more passive or active intermediary devices. The term "circuit" means one or more passive and/or active components that are arranged to cooperate with one another to provide a desired function. The term "signal" means at least one current signal, voltage signal, electromagnetic wave signal, or data signal. The meaning of "a", "an", and "the" include plural references. The meaning of "in" includes "in" and "on".

**[0016]** Briefly stated, the present disclosure is related to an apparatus and method for providing sensing func-

tions that are similar to "human touch" when located in a prosthetic device such as a BION microstimulator that is implanted in a patient. The apparatus includes a power circuit, a communication circuit, and a sensor circuit. The power circuit provides power to the communication circuit and the sensor circuit. The sensor cooperates with the communication circuit, which communicates with the brain. The sensor uses various techniques to detect changes in the environment for the surrounding tissue using criteria such as reflectivity, impedance, conductivity, return signal spectrum, return signal rate, and return signal phase to name a few. For example, the impedance observed by the sensor changes when: the skin tissue is deformed around the sensor, or when the skin is surrounded by water. The sensory information is interpreted by the brain as an analog of touch or feel.

**[0017]** Although many of the examples found herein are described within the context of a sensory device that can be used to communicate with a main control unit (MCU), applications of the devices are not so limited. In one example, the sensory device is configured to communicate with other sensory devices (e.g., BION microstimulators that are arranged to "talk" to one another). In another example, the sensory device is configured to communicate with other devices such as BION microstimulators that are arranged to stimulate or influence muscular functions, stimulate nerves to influence or control motor function, as well as others. In yet another example, the sensory device is configured to communicate with a data-logging device that is external to the body (e.g., a computer system, a monitoring system, etc). In still another example, the sensory device is configured in communication with a set of electrodes that are implanted in a neural pathway. In a further example, the sensory device is configured to stimulate or influence a communication path to a sensory system (e.g., another neural path), a physiological control system (e.g., muscular contraction), or the brain. Such examples can be accomplished by mechanisms that are internal to the body (e.g., through an electrode, through another implanted BION microstimulator, or through some other device) or external to the body (e.g., to an external master control unit, an external computing device, etc.). Many varieties of circuits can be arranged to provide such functions where sensory information is relayed, processed, data-logged, or otherwise handled and communicated.

**[0018]** The examples described above are only to be construed as example applications for such sensory devices as described below. Many embodiments of the invention can be made without departing from the spirit and scope of the invention, and the invention resides in the claims that follow this disclosure.

**[0019]** The overall operating environment for the present invention will be discussed as follows below with reference to FIGURES 1 and 2.

### Example Operating Environment

**[0020]** FIGURE 1 illustrates an example operating environment (100) for a neural prosthetic device. A person may have lost or impaired ability to sense touch in a particular region of the body such as a hand (110). One or more bionic implants (120) are placed in locations where sensor information is desirable. Each of the bionic implants (120) includes a sensor circuit (121), and a communication circuit (122) that are powered by a power source circuit (123). The sensor circuit (121) provides sensory information to the communication circuit (122), which subsequently communicates information to the brain. The brain receives the sensory information and interprets the sensory information as touch or feel.

**[0021]** In one example, the communication circuit is arranged to provide a wireless communication signal 140 to a master control unit (MCU, 130) that may be implanted in the body (e.g., coupled to a neural pathway), or it may be external to the body. For this example, MCU 130 includes a sensor processing circuit (131), and a communication circuit (132) that are powered by a power source circuit (133). The communication circuit (132) receives wireless communication signal 140, and provides sensory information to sensor processing circuit (131). Sensor processing circuit 131 is arranged to communicate to the MCU, where the sensory information may be further processed for application. Example applications include communication to other bios to affect motor functions, muscular contractions, etc. The sensory information is interpreted as touch or feel.

**[0022]** MCU 130 may not be necessary in some implementations. In example application, the patient has damaged a nerve ending in a finger such that touch sensitivity is impaired even though the nerve is still capable of communicating to the brain. In this example, communication circuit 122 corresponds to a signal conditioner that is configured to couple electrical signals (e.g., via one or more electrodes) to the nerve. In another case where the nerve is incapable of communicating to the brain, a different nerve may be used to communicate electrical signals that are associated with sensor 121 to the brain.

### Example Process Flow

**[0023]** FIGURE 2 illustrates an example process flow (200) for another neural prosthetic device. Process flow 200 may be implemented as software that is stored in a memory device (e.g., a read only memory), as a programmable logic device (PLD), as a digital logic circuit, as operations that are handled by a controller, or any other appropriate mechanism as will become apparent from the present disclosure. Processing begins at block 210, and proceeds to block 220.

**[0024]** At block 220, time is evaluated to determine if an appropriate time has elapsed for activating an emitter. Processing flows from decision block 230 to block 240

when sufficient time has elapsed to begin emitting. Alternatively, processing returns from decision block 230 to block 220 when insufficient time has elapsed to begin emitting a signal. Optional block 280 may be used to place the device in a suspended operating mode (e.g., sleep, conserve power, suspend, etc.) as may be needed.

**[0025]** At block 240 the emitter (or emitters) are activated such that one or more signals are emitted from the neural prosthetic device. Example emitters include: modulated transmitters, ultra-wideband transmitters, wideband transmitters, narrow band transmitters, sweep frequency transmitters, pulse transmitters, RF transmitters, ultrasonic transducers, high frequency LC oscillators, and infrared devices. The emitter(s) transmit a signal (or signals) through the tissue that surrounds the implanted device. One or more signals may be reflected from within the tissue, or perhaps from outside of the tissue depending on the environmental conditions that are exerted upon the region of the tissue that surrounds the neural prosthetic device. Continuing to block 250 the return signal is received by the neural prosthetic device (e.g., via a detector circuit, a receiver circuit, a transducer circuit, etc.).

**[0026]** Continuing to block 260, the received signal is processed by a signal processing means to provide an information signal (or signals). Example signal processing means includes: an analog signal processing circuit, a digital signal processing circuit, a Fast Fourier Transform (FFT) circuit, an amplifier circuit, a filter circuit, a correlator circuit, a convolution circuit, and an integrator circuit, to name a few. The signal processing means may further include an encoder circuit that is arranged to prepare the information signal for transmission (e.g., provide encryption, coding, compression, etc.).

**[0027]** Flowing to block 270, the information signal (or the coded information signal) is transmitted from the neural prosthetic device to the MCU. Processing returns from block 270 to block 220, where the processing flow cycle repeats again.

### Sensory Factors

**[0028]** A single bionic device, or multiple bionic devices, can be implanted in tissue to provide sensory feedback from the various limbs or other parts of the human body that may be inoperable (or impaired) due to nervous system malfunction or damage. The sensory feedback is useful for both functional and safety reasons. Although it is difficult to restore the exact set of neural stimulations that are interpreted in the human body as touch, it is possible to use radio frequency communication techniques to generate sensory data that is similar to human tactile sensation.

**[0029]** Materials can be characterized based on their electrical, magnetic, acoustic, and mechanical properties as described by: conductivity, dielectric constant, magnetic permeability, acoustic impedance, and sound ve-

locity, to name a few. These materials further vary in their characteristic as a function of frequency, denoting their real and imaginary parts. An antenna can be used as part of a sensor system since the antenna perceives the surrounding environment as a complex impedance. A modulated communication signal, as well as other communication signals can be provided to the antenna, bionic devices can be arranged to provide functions that are analogous to human tactile sensation (e.g., "touch") by emitting (or transmitting) a frequency sensitive signal into a resonant circuit that includes the antenna. Since the surrounding human tissue presents a complex impedance to the load, the tissue exhibits quantifiable characteristics that can be evaluated by the difference between the desired operating frequency of the resonant circuit and the actual resonant frequency.

**[0030]** The complex impedance of the antenna/resonant circuit can be indexed according to a number of test frequencies. The vectors can then be evaluated with a signal processor such as a vector analyzer, an inverse FFT algorithm, or some other processing that provides a time domain representation of the antennas performance. Wider frequency ranges of operation can be used to permit collection of more information. In some instances, a very wide band (UWB) signal may be desirable since the wide band signal contains a significant amount of information related to the environment surrounding the sensor.

**[0031]** In one example, a modulated signal in one portion of the RF spectrum is transmitted into the human tissue (e.g. TDMA modulated UHF) surrounding the sensor device. The modulated signal may be the same communication signal that is used for normal BION microstimulator communication, or it could be a separate signal. RF communication signals are affected in number of complex ways when transmitted into tissue such as in the body of a patient. At the skin boundary, some RF signals are transmitted out of the tissue while others are reflected back towards the tissue. The reflectivity of the tissue at the boundary is dependent on the complex impedances of the tissue(s) and of the external environment. For example, the complex RF impedance of the surrounding tissue changes when the shape of the tissue immediately surrounding the bionic implant device changes due to external pressure. The complex impedance is also affected by the boundary region when the tissue is adjacent a medium different from air (e.g., water causes a change in the impedance at the surface). By sensing the changes in impedance at the surface, as well as changes in the impedance surrounding the bionic implant, a model can be constructed for sensing human touch.

**[0032]** One very convenient way to achieve sensing human touch is to create a complex correlation between the desired transmitted signal and the actual transmitted signal, as affected by the environment. In one example, an analog multiplier-type circuit is employed to multiply the complex modulated signal proved to a final amplifier

stage by either the signal at the output of the final amplifier or the signal at the output of a matching network. The output of the multiplier can be integrated and digitized for transmission over a regular interval (e.g., 100 times per second). A receiver circuit can receive the transmissions and communicate the information to the brain (e.g., through an implanted bionic receiver device).

**[0033]** In another example, a complex digital multiplier circuit is employed consisting of XOR gates or the like, followed by an integrator. Since the modulated signal is used as a reference, the modulation itself is absent from the resulting signal. For more sophisticated systems, a half analog and half digital circuit can be utilized. A maximum amount of information can be recovered with information such as time and modulation, since in this way reflections can be sensed.

**[0034]** In general terms, a reference complex impedance can be generated and then variations from this reference complex impedance can be evaluated to identify changes in the environment about the implanted sensor device. Very small changes in the phase and/or amplitude of the signals can be identified with this method. Also changes in the frequency may also be evaluated with this method.

**[0035]** While pressure information can be inferred from impedance due to tissue deformation, other effects, such as changes in external conductivity and dielectric properties can also be measured. Therefore, the proposed sensor devices can detect close objects without contact, and can further be arranged to differentiate between substances such as wood, metal, plastic, and water, to name a few. This sensory data can be combined with other information to formulate a highly informative artificial sensor (e.g., infra-red sensing can be combined with impedance sensing, etc.)

**[0036]** The presentation of sensory information to the brain can be accomplished through direct connection to the remaining peripheral (or central) nervous system or converted to audio or visual signals. The brain's natural ability to uniquely interpret recurring stimuli can generate a sensory map to the provided sensory data.

### **Example Neural Prosthetic Devices**

**[0037]** FIGURES 3 - 7 are block diagrams for various example neural prosthetic devices.

**[0038]** FIGURE 3 is a block diagram (300) illustrating an example neural prosthetic device that includes a sensor circuit (320) and a communication circuit (330). Sensor circuit 320 includes a controller (321), an emitter (322), a receiver (323), and a signal processor (324). Controller 321 is arranged to coordinate the various timing and control signals that are necessary to provide for proper operation of emitter 322, receiver 323 and signal processor 324. An output of the signal processor is coupled to the communication circuit (330) for communication of sensory information to the brain as previously described.

**[0039]** The sensor (320) is implanted in the tissue (310) of a person in a region (311) near a surface (312) where sensory data is relevant (e.g., the tip of a finger). Emitter 322 is configured to provide an emitted signal (341) when selectively activated by controller 321. As illustrated, emitted signal 341 is transmitted towards surface 312 through region 311. A portion of emitted signal 341 may be reflected back from surface 312 into tissue region 311. Another portion of emitted signal 341 may be transmitted into adjacent region 313 as illustrated by signal 342. Adjacent region 342 is external to tissue region 310 and may contain foreign matter such as an object that the person is in contact with, and/or a number of other environmental conditions such as: heat, cold, water, light, etc. The various conditions and forces exerted on signal 342 may result in another reflected signal (343).

**[0040]** Receiver 323 is configured to receive a return signal (344) when selectively activated by controller 321. Return signal 344 consists of all reflected signals that result from emitted signal 341. Signal processor 324 is configured to condition the received return signal and provide the resulting signal to communication circuit (330) for communication of sensory information. Signal processor 324 may be arranged to provide a number of signal processing functions including, but not limited to: analog signal processing, digital signal processing, FFTs, amplification, attenuation, filtering, correlation, convolution, integration, time displacement, spectrum analysis, return signal strength, peak signal strength, average signal strength, mean signal strength, and return signal phase, to name a few. The signal processing means may further include an encoder circuit that is arranged to prepare the information signal(s) for transmission (e.g., provide encryption, coding, compression, etc.).

**[0041]** FIGURE 4 is a block diagram (400) for still another example neural prosthetic device. The example neural prosthetic device includes: a controller (410), a transmitter (420), a receiver (430), a matching network (440), an antenna (450), and a sensor processor (460).

**[0042]** Controller 410 is arranged in cooperation with transmitter 420, receiver 430, and matching network 440. Transmitter 420 and receiver 430 are selectively coupled to antenna 450 via matching network 440. For this example device, transmitter 420 is configured to operate similar to emitter 322 described previously with respect to FIG. 3. Also, receiver 430 is arranged to operate similar to receiver 323 from FIG. 3. Since transmitter 420 and receiver 430 share the use of a single antenna, controller 410 must be arranged to ensure that the operation of receiver 430 and transmitter 420 do not interfere with one another.

**[0043]** Sensory processor 460 includes a correlator (461), a signal conditioner (462), and an optional encoder (463). The correlator includes an input that is coupled to an output of receiver 430, and an output that is coupled to signal conditioner 462. Signal conditioner 462 includes an output that is coupled to an input of optional encoder

463. The signal conditioner is configured to provide any desired function such as gain, attenuation, filtering, limiting, as well as other signal processing functions as described previously. The optional encoder is arranged to encode signals from the signal conditioner for communication to the MCU via transmitter 420.

**[0044]** Sensor Processor 460 is arranged to receive an output signal from receiver 430, and provide an input signal to transmitter 420. Controller 410 is arranged to selectively operate transmitter 420 and matching network 440 for communication to an MCU unit without the use of an additional circuitry. In other words, antenna 450 and matching network 440 can be tuned for two operations. The first operation corresponds to transmission of a signal through tissue for sensory purposes. The second operation corresponds to transmission of a communication signal to the MCU.

**[0045]** FIGURE 5 is a block diagram (500) for yet still another example neural prosthetic device. The device includes a controller (510), a transmitter (520), a receiver (530), one or more antenna circuits (540, 550), a signal processor (560), an optional encoder (570), and a communication block (580).

**[0046]** Controller 510 is arranged in communication with at least one of transmitter 520, receiver 530, signal processor 560, optional encoder 570, and communication block 580. Transmitter 520 includes a pulse generator (520) that is arranged to selectively couple pulse signals to a driver (522). Driver 522 is arranged to transmit a pulse signal via antenna circuit 540. Receiver 530 includes a detector (531) that is coupled to an amplifier (532), where reflected signals that are received by antenna circuit 550 are detected and amplified. The amplified signal is provided to signal processor 560, which is arranged to provide gain, attenuation, filtering, as well as any other desired signal processing function. The output of the signal processor can be encoded by encoder 570 for communication via communication block 580.

**[0047]** Antenna circuit 550 can be eliminated when antenna 540 is shared between the transmitter (520) and receiver (530). In one example, the pulse generator is arranged to provide an ultra-wideband signal pulse via antenna 540. For this example, the receiver is arranged to capture the reflected signal and extract various signal characteristics with signal processor 560. Example characteristics of the reflected signal includes: return signal spectrum, signal amplitudes for the return signal spectrum, peak return signal frequency, return signal phase, signal dispersion, and other useful characteristics. These various characteristics may be used to identify different materials that are proximate to the sensor, different pressures that are exerted about the tissue surrounding the sensor, as well as any other appropriate condition.

**[0048]** As described previously, wider frequency ranges of operation can be used to permit collection of a significant amount of information related to the environment surrounding the sensor. For this example, the pulse generator can be arranged to provide ultra-short pulses such

that the received signals can be time domain separated from the transmitted signal, similar to a conventional radar system. To accomplish this, the round-trip time between the transmission of the pulse and the reception of a reflected pulse is on the order of 200ps for a 1cm distance. In some applications, pulses on the order of 50ps may be necessary to generate sensory data to detect skin deformation.

**[0049]** FIGURE 6 is a block diagram (600) for still yet another example neural prosthetic device. The device includes a transmitter (610), a transducer (620), a capture block (630), a signal processor (640), an optional encoder (650), an optional communication block (660), and an optional transducer (670).

**[0050]** Transmitter 610 includes a signal generator (611) that is arranged in communication with a driver (612) to provide a suitable input signal for transducer 620 to transmit an emitted signal. A reflected signal is received from either transducer 620 or optional transducer 670) and stored in capture block 630. Signal processor block 640 is arranged to provide various signal processing functions to the stored signals resulting from the reflected signals. Optional encoder 650 and communication block 660 operate similar to that previously described.

**[0051]** In one example, signal generator 611 is arranged to provide a pulsed signal. In another example, signal generator 611 is arranged to provide a chirped signal. In still another example, signal generator 611 is arranged to provide a pseudo-noise like modulation signal. In yet another example, transducer 620 is capable of providing an ultrasonic signal as the emitted signal. In still yet another example, transducer 620 is arranged to provide sense pressure changes in the surrounding tissue. In yet another implementation, transducer 620 is capable of transmitting/sensing an audio signal or a subsonic signal. The basic function of the transducer is that of a signal emitter and receiver for any of a number of sensing applications.

**[0052]** An ultrasonic sensor application may be implemented with the topology illustrated in FIGURE 6. Ultrasound travels through tissue at a rate on the order of 1200-1700 meters/second. For frequencies on the order of 10MHz, the wavelength is on the order of 0.1mm, which provide adequate resolution for sensory data. Such an ultrasonic transducer can be used to measure skin deformations in a different manner than the RF communication signals.

**[0053]** FIGURE 7 is a block diagram (700) for a neural prosthetic device that is arranged sense changes in impedance of an antenna by sensing frequency changes. The device includes an oscillator (710), a tuned circuit (720), and a frequency meter.

**[0054]** The oscillator is arranged to excite the tuned circuit, which includes a capacitor (C7), an inductor (L7) and an antenna. Frequency meter 730 is arranged to evaluate resonant frequencies associated with the tuned circuit. The frequency meter provides one or more output

signals, which can subsequently be coded and communicated to an MCU as previously described.

**[0055]** The illustrated example is arranged to provide one particular type of sense (e.g., touch) by detecting a change in the impedance of an antenna. As the antenna is brought into close proximity with an object (e.g., 740), the impedance of the antenna changes based on electrical effects. The inductor (L7) and the capacitor (C7) form a resonance with the antenna. The resonant frequency of the tuned circuit is thus varied based on a distance between the object and the antenna.

**[0056]** The object may be any type of material such as metal, stone, wood, water, etc. Each object has its own particular effect on the inductive and/or capacitive characteristics of the tuned circuit. When the object and the implantable device are proximal to each other, the total amount of the LC coupled to the oscillator is affected. For example, if the object proximal to the LC circuit is a material that affects the capacitive component of the LC circuit, then the total amount of the inductance and capacitance coupled to the power oscillator is the sum of L7 and C7 plus the capacitance associated with the object. The change in the total amount of the inductance and capacitance causes a corresponding change in the impedance of the LC resonant circuit and consequently changes the frequency of the oscillator. By measuring the corresponding change in the frequency and comparing the same with a table of values associated with different materials, the characteristic of the material namely, metal, wood, or any other type of material can be identified.

**[0057]** It is further contemplated that in the event pressure is exerted on the tissue proximal to the implantable device, the change in the physical characteristics of the compressed tissue accordingly produces a change in the total inductance and capacitance of the LC circuit. As described above, the change in the value of the LC circuit results in a corresponding change in the frequency of the oscillator. In this manner, the implantable device is capable of measuring pressure proximal thereto.

**[0058]** FIGURE 8 is a block diagram (800) for a neural prosthetic device that is arranged sense changes in impedance of an antenna by sensing amplitude and phase changes. The device includes a fixed frequency oscillator (810), a tuned circuit (820), amplitude detectors (830, 840), a signal processor (850), and a phase meter (860).

**[0059]** Fixed frequency oscillator 810 is coupled to the tuned circuit, which includes an inductor (L8) and a capacitor (C8) that are coupled to an antenna. Phase meter 860 is coupled across inductor L8. Amplitude detector 830 is coupled to an input side of the tuned circuit (820), while amplitude detector 840 is coupled to an output side of the tuned circuit (820). Signal processor 850 is arranged to receive various inputs such as the output of the amplitude detectors (830, 840) and the output of the phase meter (860). The impedance of the tuned circuit is varied based on the proximity of the antenna to an object (870).

**[0060]** In one example, the fixed frequency oscillator is a crystal oscillator for generating signals that are supplied to the inductor (L8) and the capacitor (C8) of the tuned circuit. The first amplitude detector (830) is arranged to measure the amplitude of the signals generated by the oscillator, while the second amplitude detector (840) is arranged to measure an amplitude of the signal across the capacitor (C8). The two amplitudes are evaluated by the signal processor (850), which can determine a ratio of the respective amplitudes.

**[0061]** The physical and electrical properties of the object affect the inductance and capacitance of the tuned circuit (820). A change in the phase shift and also a change in the ratio of the amplitudes of the respective generated signals is observed as a result in the changed impedance of the tuned circuit (820). Signal processor 850 is arranged to evaluate the various sensory inputs and identify touch-like characteristics as amplitude change and phase change.

**[0062]** FIGURE 9 is a block diagram for a neural prosthetic device that is arranged sense changes in impedance of an antenna by locking a reference signal to a variable signal, using a closed loop control topology (e.g., frequency locked loop, phase locked loop, delay locked loop, etc.). The device includes a fixed frequency oscillator (910), a voltage controlled circuit (920), a tuned circuit (930), a signal comparator (940, and a signal processor (950).

**[0063]** The fixed frequency oscillator is arranged to provide a reference signal. Voltage controlled circuit 910 and tuned circuit 930 are arranged to operate together as a voltage controlled oscillator to provide a variable signal. Although voltage controlled circuit 910 is responsive to a control signal (V<sub>control</sub>), tuned circuit 930 has a variable resonant frequency that is responsive to the environmental conditions. The result is that the variable signal is affected by the environmental conditions that are surrounding the tissue near the device. The signal comparator is arranged to compare the variable signal to the reference signal to provide the closed loop feedback in the form of the control signal (V<sub>control</sub>). Signal processor 950 can be employed to evaluate the control signal and identify the relevant sensory information.

**[0064]** The signal comparator can be arranged to compare frequency, phase, and amplitude of the signals to adjust the control signal. A phase locked loop topology can be used to lock the variable frequency to the reference frequency. The resulting control voltage indicates the sensory information since the tuned circuit will have a different resonant condition in each different environment.

**[0065]** Although the electronic systems and circuits are illustrated by various individual blocks, the electronic system should not be interpreted as limited to these discrete blocks. One or more of the electronic system blocks may be combined or separated into one or more blocks that provide a similar functionality. The invention is not limited to the embodiments described above, but rather covers

all modifications, alternatives, and equivalents that fall within the spirit and scope of the invention. Since many embodiments of the invention can be made without departing from the spirit and scope of the invention, the invention resides in the claims hereinafter appended.

## Claims

1. A neural prosthetic sensor device that is implanted into a tissue, comprising:
  - an emitter that is arranged to emit a first transmitted signal when activated, wherein the emitter is configured such that the first signal is emitted in the tissue such that changes in the tissue environment influences the first transmitted signal;
  - a receiver that is arranged to receive a second signal when activated, wherein the second signal corresponds to an altered version of the first transmitted signal, and the altered version is related to the first transmitted signal as influenced by the tissue environment;
  - a signal processor that is arranged to evaluate at least one of the first signal and the second signal to provide sensory information; and
  - a controller that is arranged to selectively activate at least one of the emitter and the receiver.
2. The neural prosthetic sensor device of claim 1, wherein the emitter corresponds to at least one of: an antenna, a transmitter, a modulator, a modulated transmitter, a matching network, a tuned circuit, a filter circuit, a tuned frequency oscillator, a variable tuned frequency oscillator, a high frequency LC oscillator, an RF transmitter, a signal generator, a pulse generator, an oscillator, a driver, an ultra wide-band pulse generator, a narrow-band pulse generator, a sweep-frequency transmitter, a transducer, an ultrasonic transducer, an infrared source, and a visible light source.
3. The neural prosthetic sensor device of claim 1, wherein the receiver corresponds to at least one of: an antenna, an RF signal receiver, a pulse detector, a signal amplifier, a peak detector, an amplitude detector, a phase detector, a frequency detector, a demodulator, a matching network, a tuned circuit, a filter circuit, a capture circuit, a correlator circuit, an integrator circuit, a transducer, an ultrasonic transducer, an infrared detector, and a visible light detector.
4. The neural prosthetic sensor device of claim 1, wherein the signal processor corresponds to at least one of: an analog signal processor, a digital signal processor, a frequency detector, a phase detector,

an amplitude detector, a peak detector, a limiter, a correlator, an integrator, a signal conditioner, and an encoder.

5. The neural prosthetic sensor device of claim 1, wherein the emitter and the receiver are arranged to share at least one of: a common antenna, a common matching network, a common tuned circuit, a common oscillator, a common transducer.

6. The neural prosthetic sensor device of claim 1, wherein the emitter and the receiver are arranged in a common circuit.

7. The neural prosthetic sensor device of claim 1, further comprising a communications circuit that is arranged to communicate the sensory information to a master control unit.

8. The neural prosthetic sensor device of claim 1, wherein the emitter circuit is further arranged to communicate the sensory information to a master control unit at substantially the same time that additional sensory information is collected from the receiver.

9. The neural prosthetic sensor device of claim 1, wherein at least one of the emitter and the receiver are responsive to conditions associated with the tissue such that the sensory information indicates a change in the conditions of the tissue related to at least one of: an electrical property, a magnetic property, an acoustic property, a mechanical property, a conductivity, a dielectric constant, a magnetic permeability, an acoustic impedance, and a sound velocity.

10. A neural prosthetic sensor device that is implanted into a tissue, comprising:

a tuned circuit that has an operating frequency that varies in response to an environmental condition associated with the tissue;

a signal processor that is arranged to evaluate the operating frequency to provide sensory information; and

a controller that is arranged in cooperation with at least one of the tuned circuit and the signal processor.

11. The neural prosthetic sensor device of claim 10, wherein the environmental condition comprises at least one of: ambient temperature of the tissue, surface temperature of a surface of the tissue, pressure exerted on the surface by a foreign object, heat exerted on the surface by the foreign object, cold exerted on the surface by the foreign object, and deformation of a region of tissue about the prosthetic sensor device.

12. The neural prosthetic sensor device of claim 10, further comprising:

a fixed frequency oscillator that is arranged to generate a first signal having a first frequency; a voltage controlled oscillator that includes a tuned circuit, wherein the voltage controlled oscillator is arranged to generate a second signal having a second frequency in response to a control signal, wherein the second frequency of the voltage controlled oscillator varies in response to environmental conditions associated with the tissue; and

a controller circuit that is arranged to vary the control signal such that the second frequency is substantially matched to the first frequency.

13. A neural prosthetic sensor device that is implanted into a tissue, comprising:

a fixed frequency oscillator that is arranged to generate a first signal having a first frequency; a variable frequency oscillator that includes a tuned circuit, wherein the variable frequency oscillator is arranged to generate a second signal having a second frequency, wherein the second frequency of the variable frequency oscillator varies in response to environmental conditions associated with the tissue; and

a frequency meter circuit that is arranged to compare the first frequency to the second frequency to identify sensory information associated with the environmental conditions associated with the tissue.

14. The neural prosthetic sensor device of claim 13, wherein the tuned circuit comprises an LC tank circuit, wherein at least one of a capacitance and an inductance associated with the LC tank circuit is varied in response to the environmental conditions associated with the tissue.

15. A neural prosthetic sensor device that is implanted into a tissue, comprising:

a fixed frequency oscillator that is arranged to generate a first signal having a first frequency, a first amplitude, and a first phase;

a tuned circuit that is coupled to the fixed frequency oscillator circuit, wherein the tuned circuit is arranged to provide a second signal having a second frequency, a second amplitude, and a second phase, wherein at least one of the second frequency, the second amplitude, and the second phase is varied in response to environmental conditions associated with the tissue; and

a signal processor circuit that is arranged to

- compare the first signal to the second signal to identify sensory information that is associated with the environmental conditions associated with the tissue.
- 5
16. The neural prosthetic sensor device of claim 15, wherein the signal processor circuit comprises at least one of: an amplitude detector, a phase detector, a frequency detector, an amplitude comparator, a phase comparator, and a frequency comparator.
- 10
17. The neural prosthetic sensor device of claim 15, further comprising at least one of: a communication circuit that is arranged to communicate the sensory information to a master control unit, a capture circuit that is arranged to store the sensory information, and an encoder that is arranged to encode the sensory information in a data signal.
- 15
18. A neural prosthetic sensor device that is implanted into a tissue, comprising:
- 20
- a transmitter circuit that is arranged to provide an input signal
- a transducer circuit that is arranged to provide an emitted signal in response to the input signal;
- 25
- a detector circuit that is arranged to provide an output signal that is related to the emitted signal, wherein a characteristic of the emitted signal is varied in response to an environmental condition that is associated with the tissue; and
- 30
- a signal processor circuit that is arranged to identify sensory information that is associated with the environmental conditions associated with the tissue in response to the output signal.
- 35
19. The neural prosthetic sensor device of claim 18, wherein the transmitter circuit corresponds to an ultrasonic signal generator, and wherein the detector circuit is arranged to sense a reflected ultrasonic signal that is received from the transducer circuit.
- 40
20. The neural prosthetic sensor device of claim 18, wherein: the transmitter circuit corresponds to an ultra-wide band pulse generator, the detector circuit is arranged to receive signals from the transducer circuit, and wherein the signal processor circuit is arranged to evaluate a signal spectrum associated with the received signals to identify the sensory information.
- 45
21. A method of collecting sensory information with a neural prosthetic device that is implanted in a tissue, the method comprising:
- 50
- emitting an emitted signal from an emitter into the tissue;
- receiving a return signal in response to the emitted signal; and
- 55
- evaluating at least one of the emitted signal and the return signal to identify sensory information associated with the operating environment for the tissue.
22. The method of claim 21, wherein evaluating comprises:
- 60
- identifying at least one of a first phase, a first amplitude, and a first frequency from the emitted signal;
- identifying at least one of a second phase, a second amplitude, and a second frequency from the return signal; and
- comparing at least one of the first phase, first amplitude and first frequency to a corresponding one of the second phase, second amplitude and second frequency to identify sensory information.
23. The method of claim 21, wherein emitting comprises generating at least one of: a modulated signal, an RF communication signal, an ultrasonic signal, an infrared signal, a visible light signal, an RF pulse, an ultra-wide band pulse, a wideband pulse, and a narrow band pulse.
24. The method of claim 21, further comprising: communicating the sensory information to a master control unit with the emitted signal.
25. A neural prosthetic sensor device that is implanted into a tissue, comprising:
- 65
- an emitter means that is arranged to emit a signal into the tissue;
- a receiving means that is arranged to receive a return signal in response to the emitted signal; and
- a signal processing means that is arranged to evaluate at least one of the emitted signal and the return signal to identify sensory information associated with the operating environment for the tissue.
26. The neural prosthetic sensor device of claim 25, wherein the emitter means comprises a resonant circuit that has a characteristic that varies according to the operating environment surrounding the tissue that is proximate to the device, wherein the characteristic corresponds to at least one of: a complex impedance, an inductance, a capacitance, a signal frequency, a signal amplitude, a signal phase, and a signal spectrum.
27. The neural prosthetic sensor device of claim 25, wherein the emitter means comprises at least one:

an antenna, a transmitter, a modulator, a modulated transmitter, a matching network, a tuned circuit, a filter circuit, a tuned frequency oscillator, a variable tuned frequency oscillator, a high frequency LC oscillator, an RF transmitter, a signal generator, a pulse generator, an oscillator, a driver, an ultra wide-band pulse generator, a narrow-band pulse generator, a sweep-frequency transmitter, a transducer, an ultrasonic transducer, an infrared source, and a visible light source.

5

10

**28.** The neural prosthetic sensor device of claim 25, wherein the emitter means is arranged to communicate the sensory information to a master control unit at substantially the same time that the signal processing means is evaluating new sensory information.

15

20

25

30

35

40

45

50

55

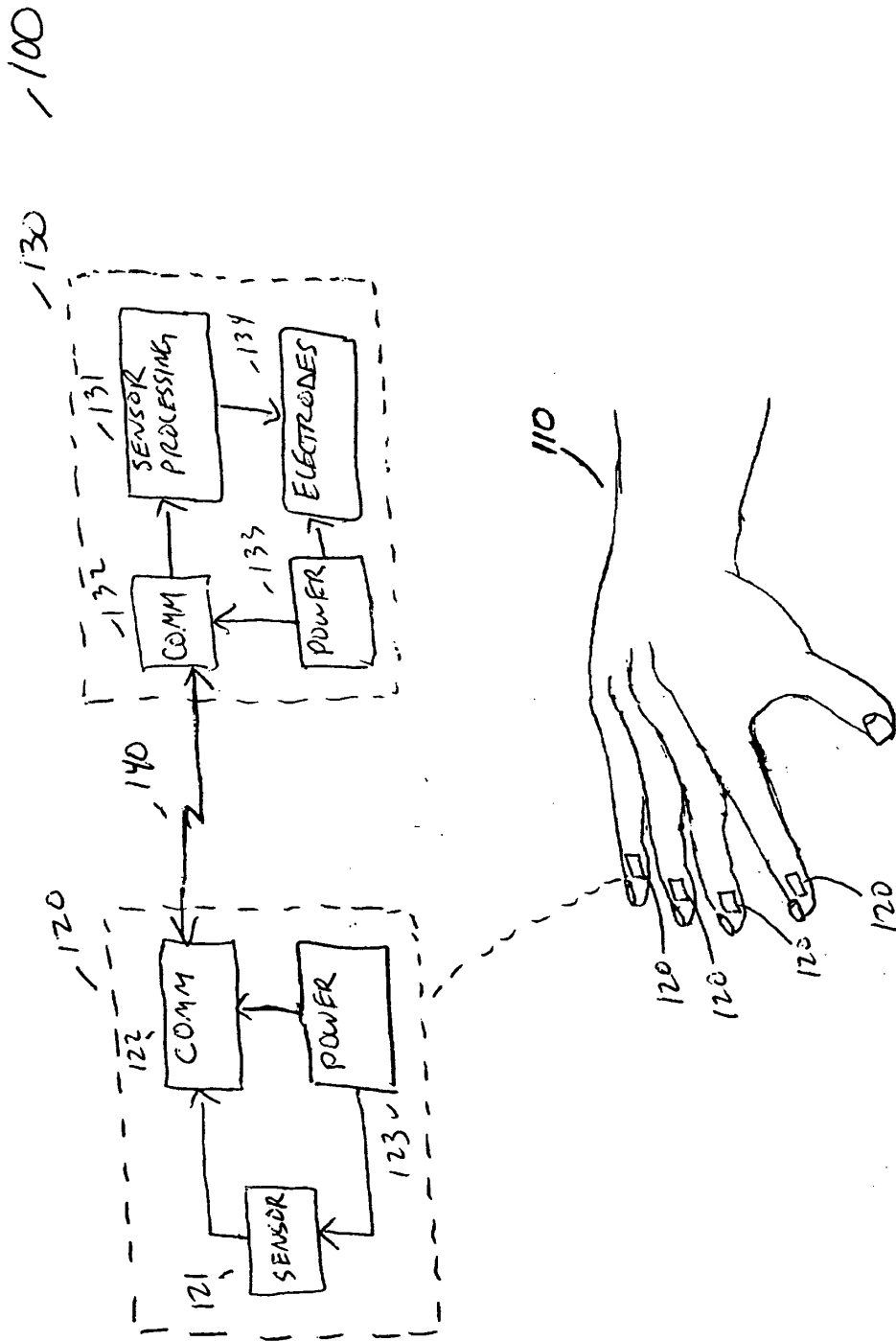

FIG. 1 (INFORMAL DRAFT)

/ 200

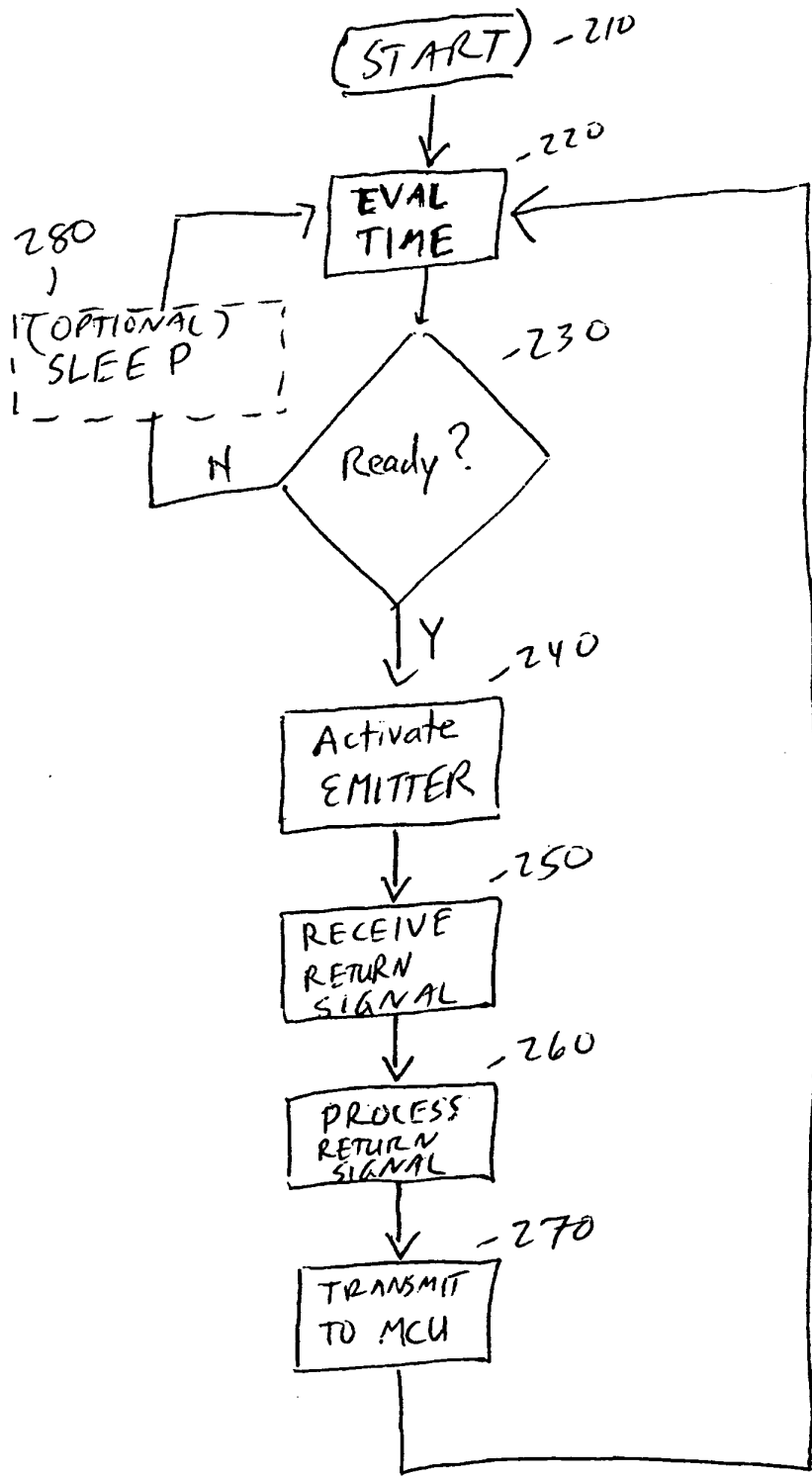

FIG. 2 (INFORMAL DRAFT)

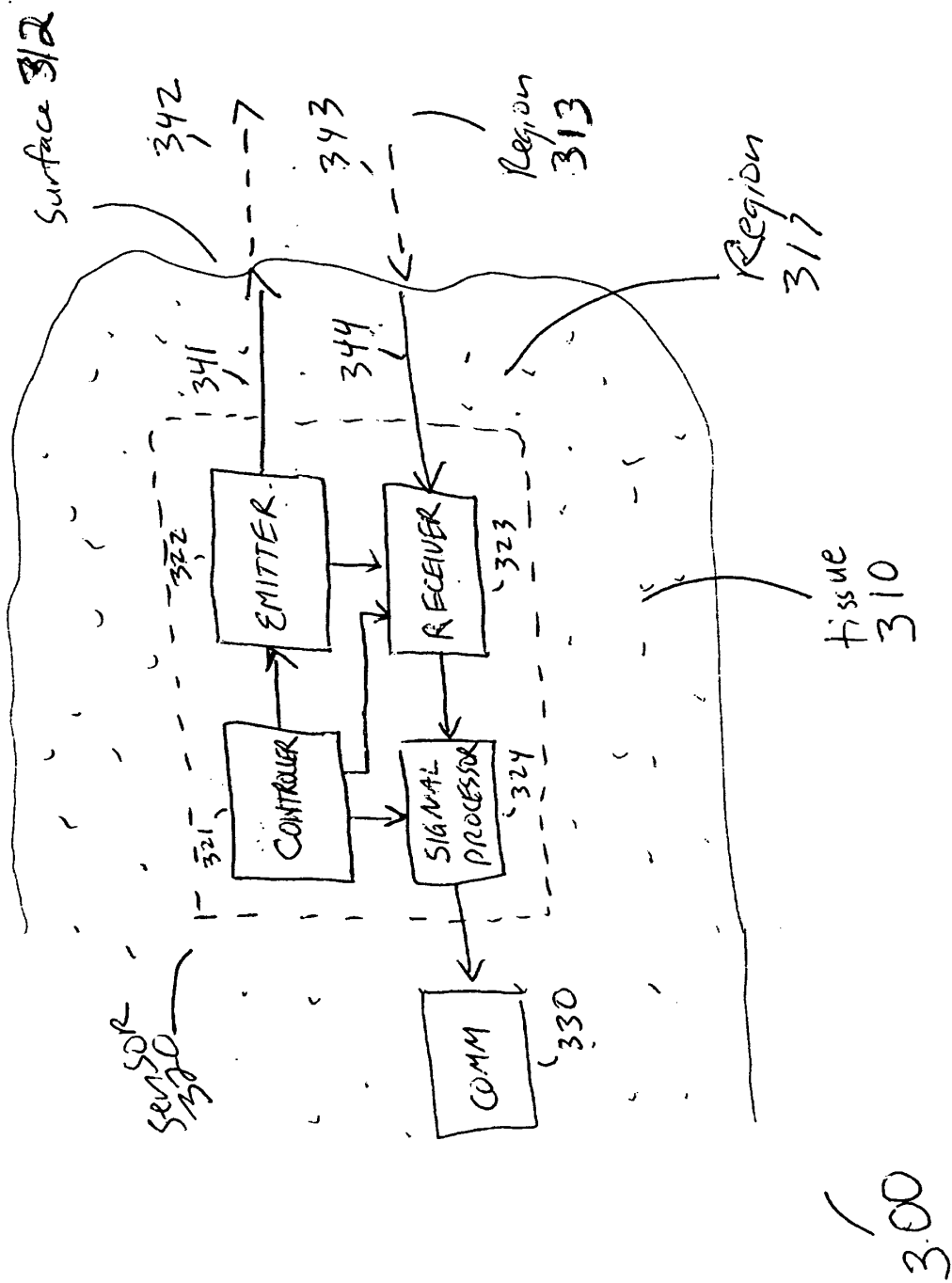

FIG. 3 (INFORMAL DRAFT)

,400

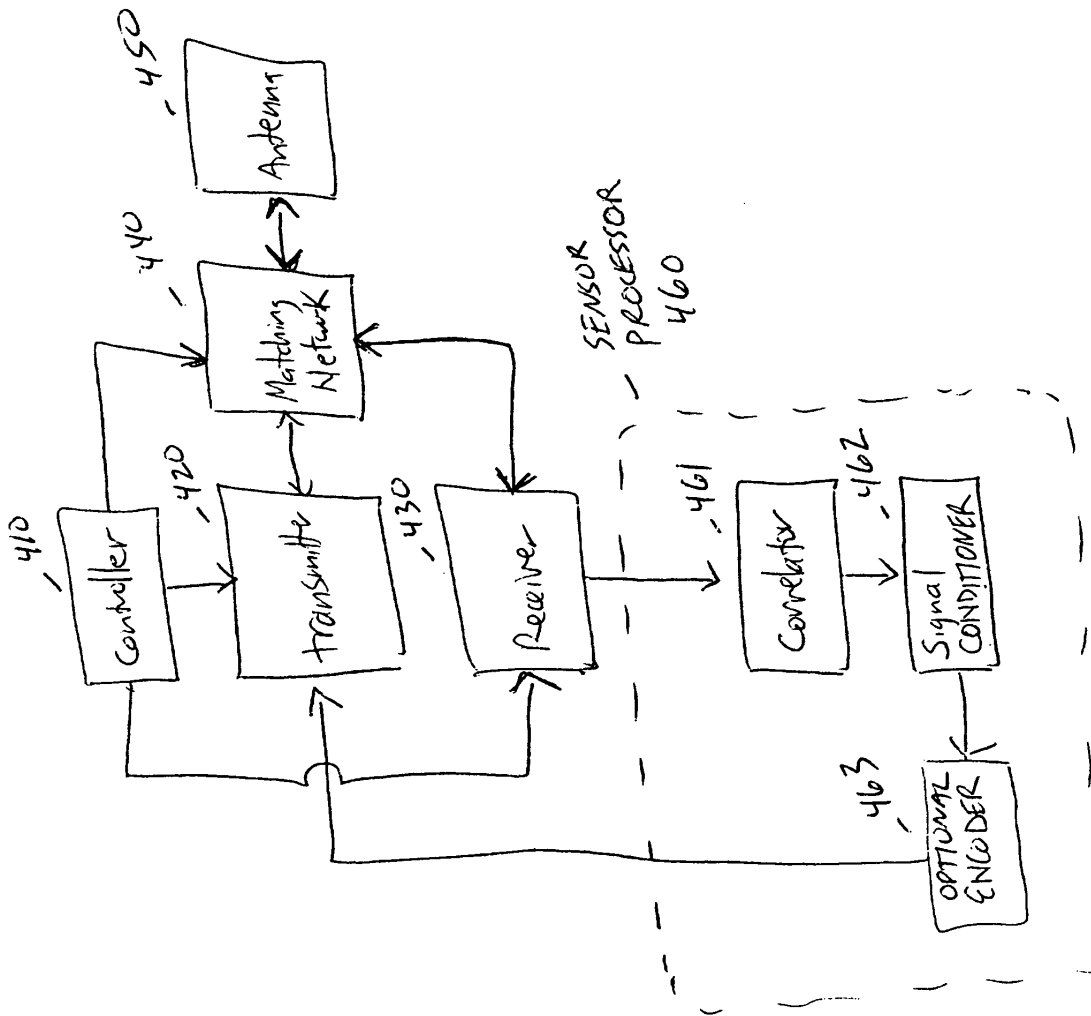

FIG. 4 (INFORMAL DRAFT)

1500

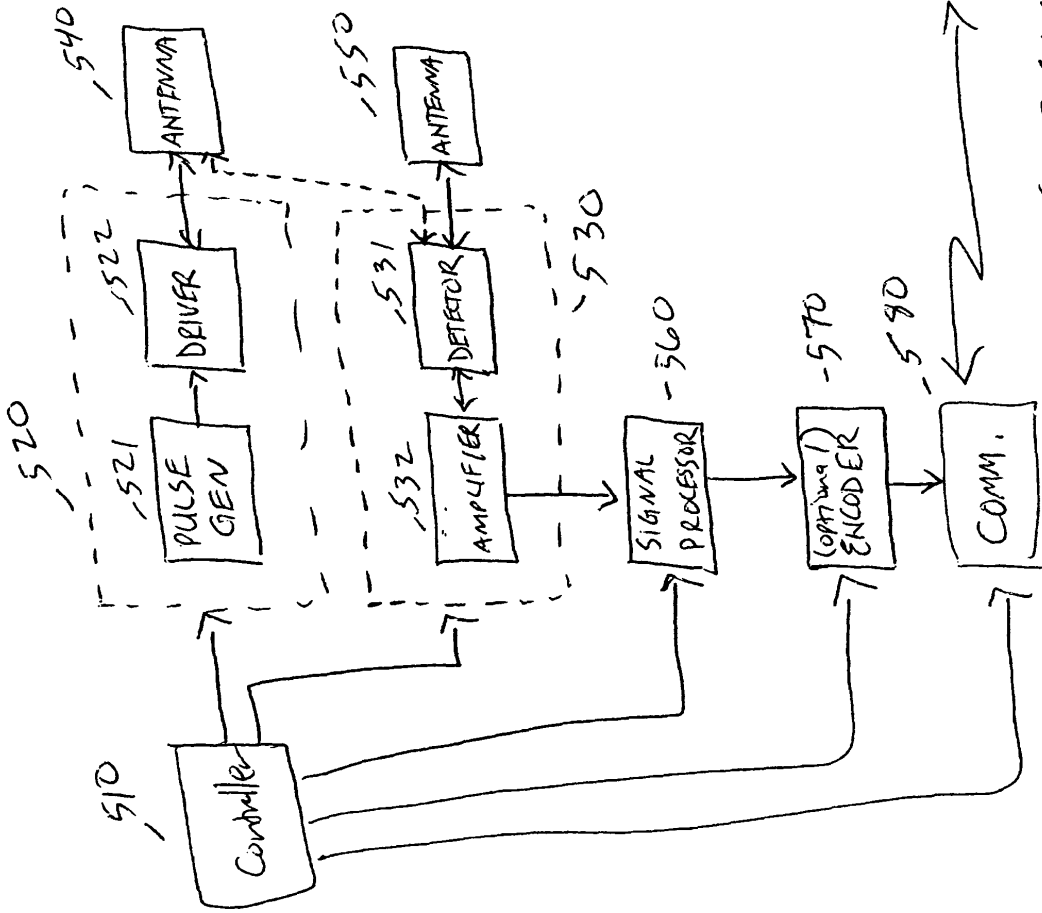

FIGURE 5 (INFORMAL DRAFT)

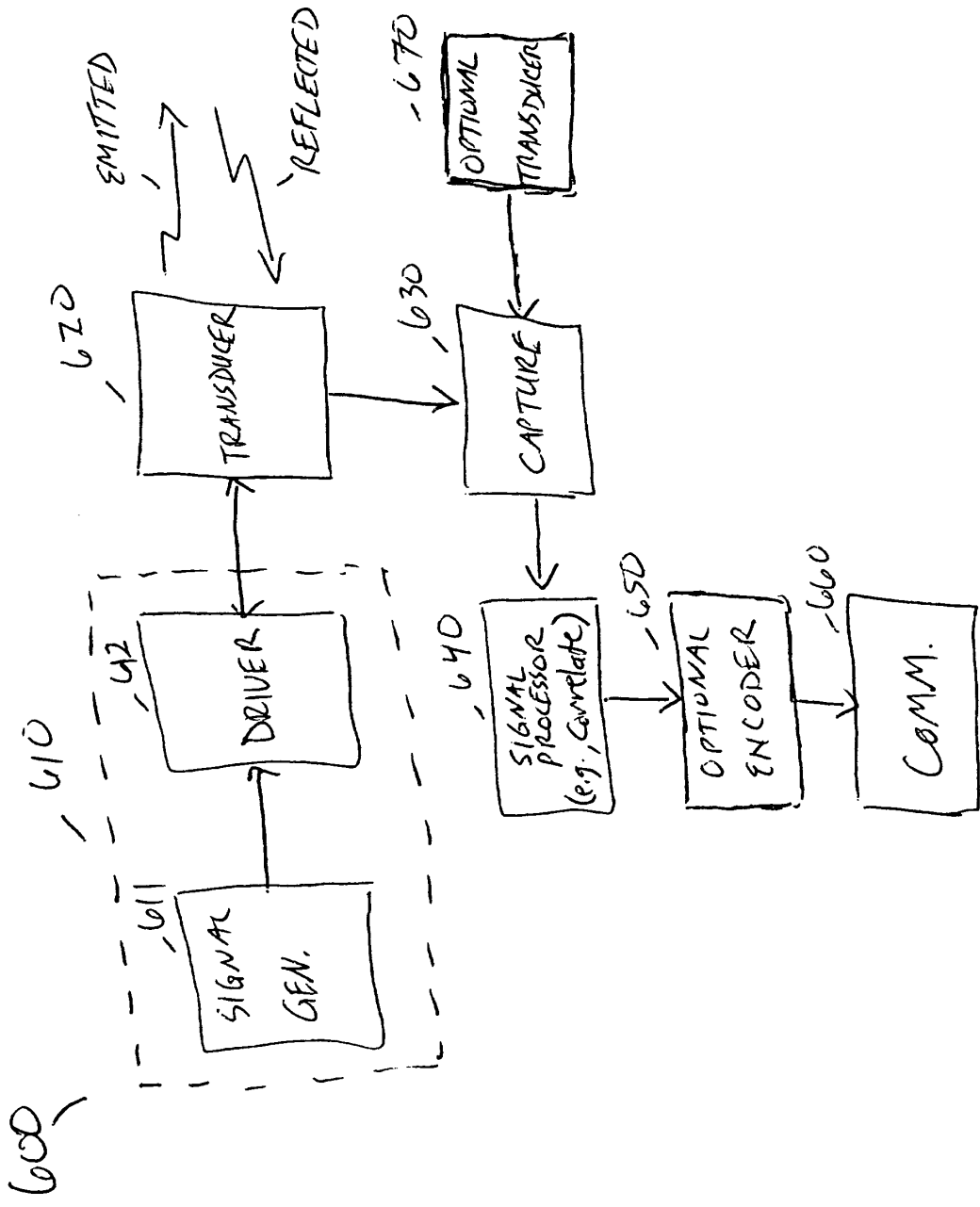

FIGURE 6 (INFORMAL DRAFT)

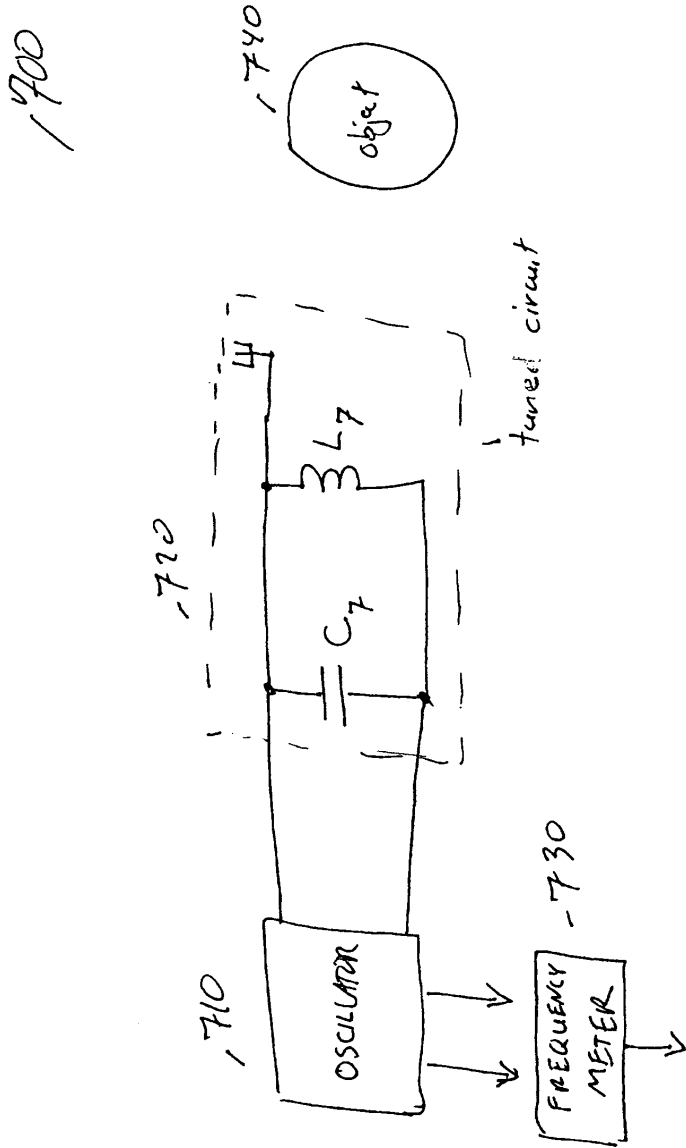

FIGURE 7 (INFORMAL DRAFT)

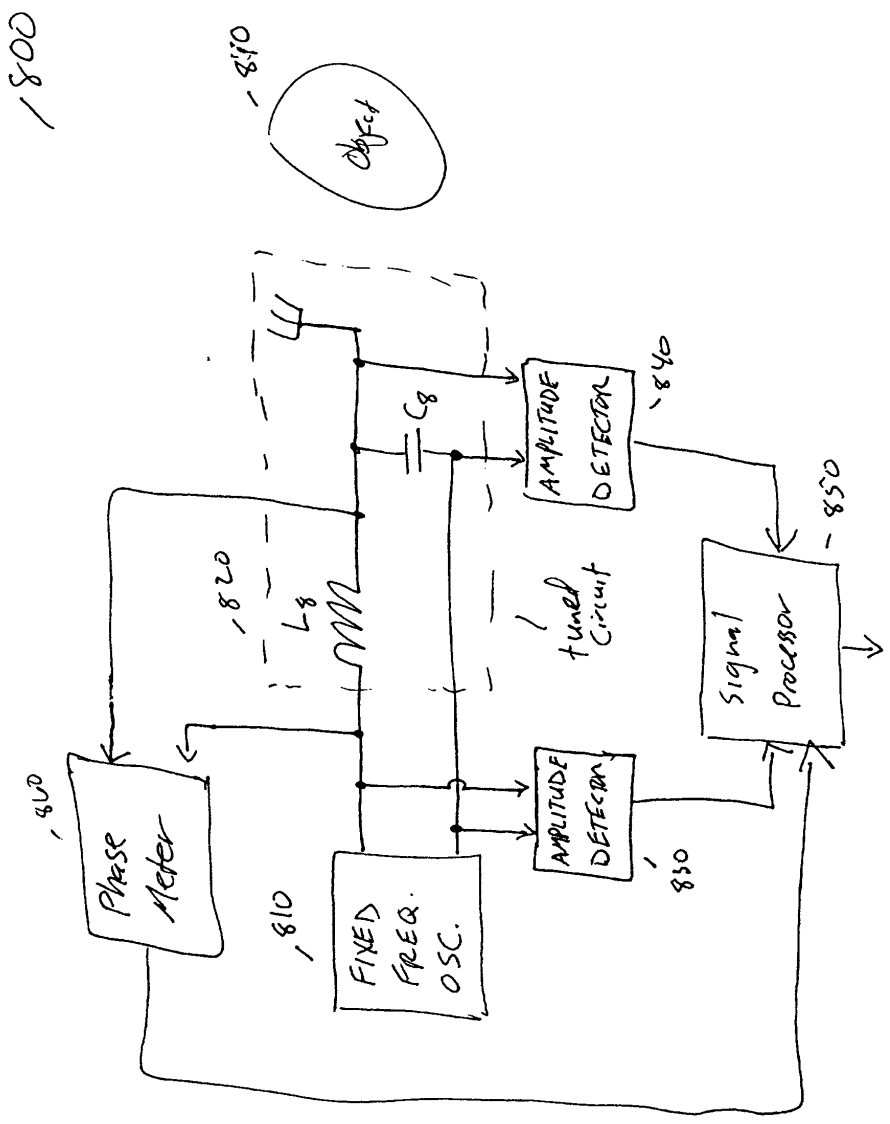

FIGURE 8 (INFORMAL DRAFT)

1900

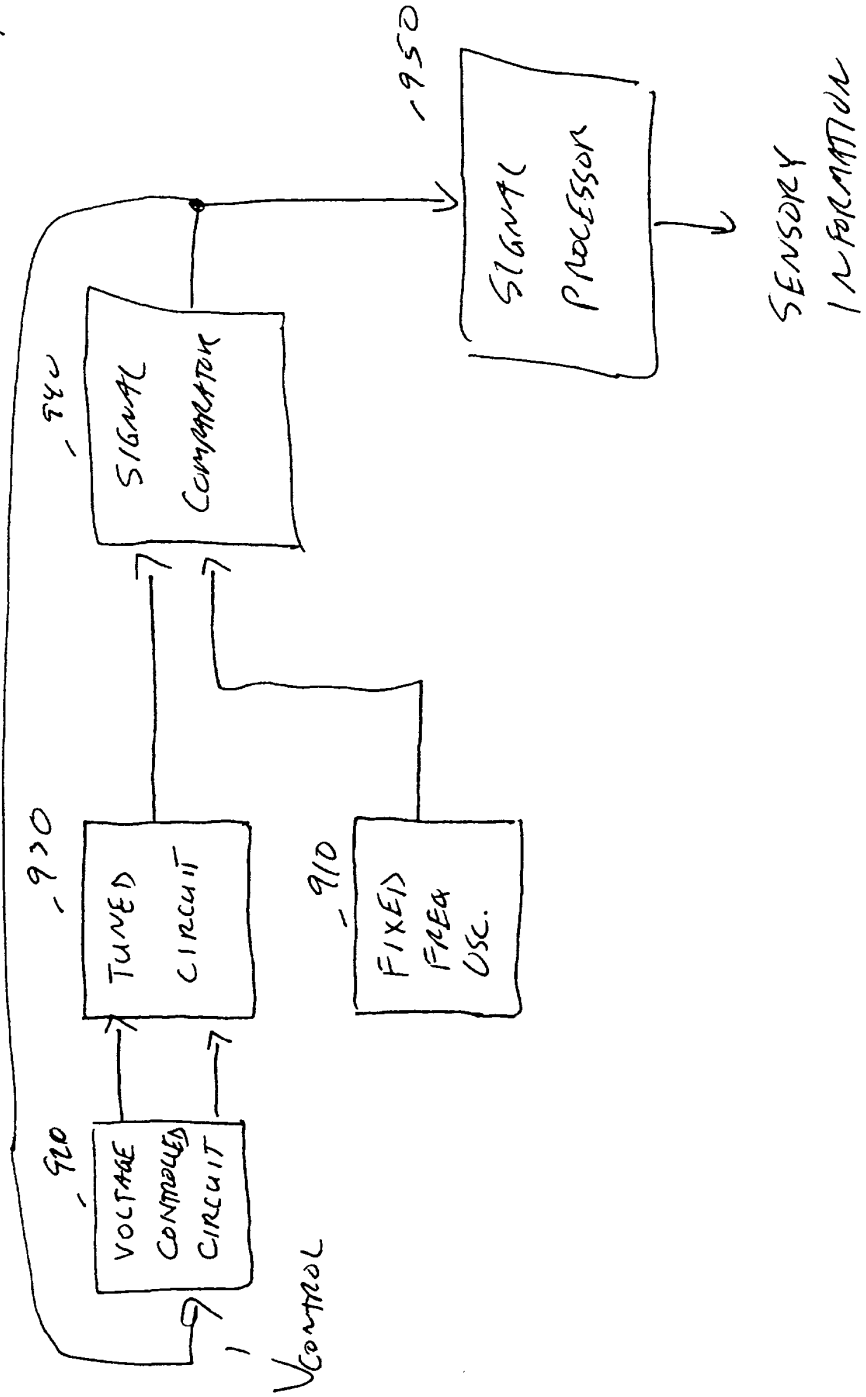

FIG. 9. (1X FORM DRAFT)



DOCUMENTS CONSIDERED TO BE RELEVANT			
Category	Citation of document with indication, where appropriate, of relevant passages	Relevant to claim	CLASSIFICATION OF THE APPLICATION (Int.Cl.7)
X	US 2004/103906 A1 (SCHULMAN JOSEPH H ET AL) 3 June 2004 (2004-06-03)  * paragraphs [0004] - [0014] * * paragraphs [0069] - [0071] * -----	1-4,7-9, 18,19, 25,27,28	A61B5/00 A61B5/04 A61B5/053
A	PATENT ABSTRACTS OF JAPAN vol. 1998, no. 11, 30 September 1998 (1998-09-30) & JP 10 155754 A (SEIKO EPSON CORP), 16 June 1998 (1998-06-16) * abstract *	1-28	
A	EP 1 312 303 A (NEUROSTREAM TECHNOLOGIES INC) 21 May 2003 (2003-05-21) * paragraphs [0011] - [0021] * -----	1,3,4, 7-9	
A	US 2003/144710 A1 (HAUGLAND MORTON ET AL) 31 July 2003 (2003-07-31)  * paragraphs [0033] - [0043] * * paragraphs [0094], [0095] * * claim 1 *  -----	1,10,13, 15,18, 21,25	
			TECHNICAL FIELDS SEARCHED (Int.Cl.7)
			A61B
The present search report has been drawn up for all claims			
Place of search Munich		Date of completion of the search 26 September 2005	Examiner Rivera Pons, C
<p>CATEGORY OF CITED DOCUMENTS</p> <p>X : particularly relevant if taken alone                      Y : particularly relevant if combined with another document of the same category                      A : technological background                      O : non-written disclosure                      P : intermediate document</p> <p>T : theory or principle underlying the invention                      E : earlier patent document, but published on, or after the filing date                      D : document cited in the application                      L : document cited for other reasons                      .....                      &amp; : member of the same patent family, corresponding document</p>			

2

EPO FORM 1503 03-02 (F04C01)

**ANNEX TO THE EUROPEAN SEARCH REPORT  
ON EUROPEAN PATENT APPLICATION NO.**

EP 05 25 4015

This annex lists the patent family members relating to the patent documents cited in the above-mentioned European search report. The members are as contained in the European Patent Office EDP file on  
The European Patent Office is in no way liable for these particulars which are merely given for the purpose of information.

26-09-2005

Patent document cited in search report		Publication date	Patent family member(s)	Publication date
US 2004103906	A1	03-06-2004	NONE	
-----				
JP 10155754	A	16-06-1998	NONE	
-----				
EP 1312303	A	21-05-2003	CA 2382500 A1	19-10-2002
			US 2003097050 A1	22-05-2003
-----				
US 2003144710	A1	31-07-2003	AU 3361901 A	27-08-2001
			WO 0160445 A2	23-08-2001
			EP 1257318 A2	20-11-2002
-----				

专利名称(译)	具有触摸感应的神经修复		
公开(公告)号	<a href="#">EP1611841A1</a>	公开(公告)日	2006-01-04
申请号	EP2005254015	申请日	2005-06-28
申请(专利权)人(译)	科学研究的基金会		
当前申请(专利权)人(译)	科学研究的基金会		
[标]发明人	KARR LAWRENCE J SCHULMAN JOSEPH H		
发明人	KARR, LAWRENCE J. SCHULMAN, JOSEPH H.		
IPC分类号	A61B5/00 A61B5/04 A61B5/053		
CPC分类号	A61B5/0031 A61B5/053 A61B5/6826 A61B5/6838 A61B8/08 A61F2/72 A61F2002/6827 A61N1/3605 A61N1/37205		
代理机构(译)	CARTER, STEPHEN JOHN		
优先权	60/583478 2004-06-28 US 11/165796 2005-06-24 US		
其他公开文献	EP1611841B1		
外部链接	<a href="#">Espacenet</a>		

摘要(译)

装置和方法涉及提供当位于假体装置(例如植入患者体内的BION微刺激器)中时类似于“人体触摸”的感测功能。该装置包括电源电路,通信电路和传感器电路。电源电路向通信电路和传感器电路提供电力。传感器与通信电路协作,通信电路与大脑通信。传感器使用各种技术来使用诸如反射率,阻抗,电导率,返回信号频谱,返回信号速率和返回信号相位等标准来检测周围组织的环境变化。例如,当皮肤组织在传感器周围变形时,或当皮肤被水包围时,由传感器观察到的阻抗改变。感觉信息被大脑解释为触摸或感觉的模拟。

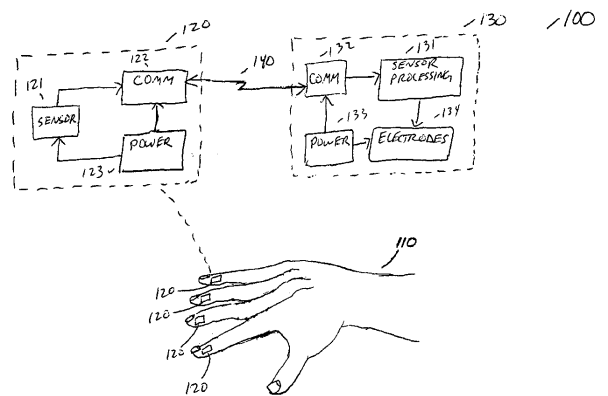

FIG. 1 (INFORMAL DRAFT)