

(19)



(11)

EP 2 182 838 B1

(12)

EUROPEAN PATENT SPECIFICATION

(45) Date of publication and mention of the grant of the patent:
04.05.2016 Bulletin 2016/18

(51) Int Cl.:
A61B 5/00 (2006.01) A61B 5/145 (2006.01)
A61B 5/1495 (2006.01) A61M 5/172 (2006.01)

(21) Application number: **08796500.0**

(86) International application number:
PCT/US2008/070923

(22) Date of filing: **23.07.2008**

(87) International publication number:
WO 2009/018058 (05.02.2009 Gazette 2009/06)

(54) **METHOD AND APPARATUS FOR PROVIDING DATA PROCESSING AND CONTROL IN A MEDICAL COMMUNICATION SYSTEM**

VERFAHREN UND VORRICHTUNG ZUR BEREITSTELLUNG VON DATENVERARBEITUNG UND -KONTROLLE IN EINEM MEDIZINISCHEN KOMMUNIKATIONSSYSTEM

PROCÉDÉ POUR EFFECTUER UN TRAITEMENT ET UNE COMMANDE DE DONNÉES DANS UN SYSTÈME DE COMMUNICATIONS MÉDICALES

(84) Designated Contracting States:
AT BE BG CH CY CZ DE DK EE ES FI FR GB GR HR HU IE IS IT LI LT LU LV MC MT NL NO PL PT RO SE SI SK TR

- **MAZZA, John, C.**
Pleasanton, CA 94588 (US)
- **FELDMAN, Benjamin, J.**
Oakland, CA 94618 (US)
- **HARPER, Wesley, Scott**
Milpitas, CA 95035 (US)

(30) Priority: **31.07.2007 US 831895**
31.07.2007 US 831866
31.07.2007 US 831881

(74) Representative: **Kazi, Ilya et al**
Mathys & Squire LLP
The Shard
32 London Bridge Street
London SE1 9SG (GB)

(43) Date of publication of application:
12.05.2010 Bulletin 2010/19

(73) Proprietor: **Abbott Diabetes Care Inc.**
Alameda, CA 94502 (US)

(56) References cited:
WO-A1-2007/027691 WO-A2-2005/051170
US-A- 5 935 224 US-A1- 2005 027 180
US-A1- 2006 020 186 US-A1- 2007 066 873
US-A1- 2007 066 873 US-B1- 6 565 509
US-B2- 6 698 269

(72) Inventors:
 • **HAYTER, Gary**
Oakland, CA 94618 (US)
 • **MCGARRAUGH, Geoffrey, V.**
Oakland, CA 94611 (US)
 • **NAEGELI, Andrew, H.**
Walnut Creek, CA 94598 (US)

EP 2 182 838 B1

Note: Within nine months of the publication of the mention of the grant of the European patent in the European Patent Bulletin, any person may give notice to the European Patent Office of opposition to that patent, in accordance with the Implementing Regulations. Notice of opposition shall not be deemed to have been filed until the opposition fee has been paid. (Art. 99(1) European Patent Convention).

Description

BACKGROUND

[0001] Analyte, e.g., glucose monitoring systems including continuous and discrete monitoring systems generally include a small, lightweight battery powered and microprocessor controlled system which is configured to detect signals proportional to the corresponding measured glucose levels using an electrometer, and RF signals to transmit the collected data. One aspect of certain analyte monitoring systems include a transcutaneous or subcutaneous analyte sensor configuration which is, for example, partially mounted on the skin of a subject whose analyte level is to be monitored. The sensor cell may use a two or three-electrode (work, reference and counter electrodes) configuration driven by a controlled potential (potentiostat) analog circuit connected through a contact system.

[0002] The analyte sensor may be configured so that a portion thereof is placed under the skin of the patient so as to detect the analyte levels of the patient, and another portion of segment of the analyte sensor that is in communication with the transmitter unit. The transmitter unit is configured to transmit the analyte levels detected by the sensor over a wireless communication link such as an RF (radio frequency) communication link to a receiver/monitor unit. The receiver/monitor unit performs data analysis, among others on the received analyte levels to generate information pertaining to the monitored analyte levels. To provide flexibility in analyte sensor manufacturing and/or design, among others, tolerance of a larger range of the analyte sensor sensitivities for processing by the transmitter unit is desirable.

[0003] In view of the foregoing, it would be desirable to have a method and system for providing data processing and control for use in medical telemetry systems such as, for example, analyte monitoring systems.

[0004] US 2007/066873 A1 relates to systems and methods for measuring an analyte in a host, and in particular a method for analysing data from an analyte sensor, the method comprising receiving sensor data from the analyte sensor, the sensor data comprising at least two sensor data points and calculating a rate of change of sensor data from the sensor data points.

[0005] US 2005/027180 A1 relates to systems and methods for analyte sensor data processing, and in particular to a method for initializing a substantially continuous analyte sensor, the method including: receiving a data stream from an analyte sensor, receiving reference data from a reference analyte monitor, providing matched data pairs by matching reference analyte data to time corresponding sensor data, forming a calibration set including the matching pairs and determining a stability of the continuous analyte sensor.

[0006] US 6565509 B1 relates to analyte monitoring devices and systems that includes, for example, a sensor control unit in signal contact with an electrochemical sen-

sor for monitoring analyte levels.

[0007] US 2006/020186 A1 relates to an analyte measuring system comprising a mounting unit for mounting on the skin of a host, an electronics unit connectable to the mounting unit, a sensor for measuring a level of the analyte comprising a portion for insertion through the skin of a host and a portion connected to the mounting unit and a communication station for receiving and processing analyte measurements received from the electronics unit.

[0008] WO 2005/051170 A2 relates to a system for monitoring glucose in a host, comprising a glucose sensor that produces a data stream indicative of a host's glucose concentration, an integrated receiver that receives the data stream from the glucose sensor and calibrates the data stream using a single point glucose monitor integral with the integrated receiver.

[0009] WO 2007/027691 A1 relates to a method for improving the accuracy of a continuous glucose sensor, comprising the steps of calibrating the continuous glucose sensor at a first time; and changing the continuous glucose sensor calibration at a second time that is determined based on a dynamically monitored continuous glucose sensor value, a rate of continuous glucose sensor change, and a predetermined criterion.

SUMMARY OF THE INVENTION

[0010] In one embodiment, method and apparatus for detecting a failure state of a calibration routine to calibrate an analyte sensor, retrieving one or more calibration parameters associated with the detected failure state of the calibration routine, determining one or more conditions corresponding to the retrieved one or more calibration parameters to correct the detected failure state of the calibration routine, and generating a notification associated with the determined one or more conditions, is disclosed.

[0011] In one embodiment, method and apparatus for prior to calibrating an in vivo analyte sensor, retrieving one or more parameters to calibrate the analyte sensor data, analyzing the retrieved one or more parameters to determine whether the analyte sensor data calibration will fail, and generating a notification based on the analysis of the retrieved one or more parameters, is disclosed.

[0012] In one embodiment, method and apparatus for acquiring data associated with a monitored analyte level, determining a glucose level based at least in part on the acquired data associated with the monitored analyte level, manipulating a data set based on a processing mode following the glucose level determination, where the processing mode includes one of a data set transmission and output display, a data set storing and output display without transmission, or a data set transmission and data set storing without output display, is disclosed.

[0013] These and other objects, features and advantages of the present invention will become more apparent from the following detailed description of the embodi-

ments, the appended claims and the accompanying drawings.

BRIEF DESCRIPTION OF THE DRAWINGS

[0014]

FIG. 1 illustrates a block diagram of a data monitoring and management system for practicing one or more embodiments of the present invention;

FIG. 2 is a block diagram of the transmitter unit of the data monitoring and management system shown in FIG. 1 in accordance with one embodiment of the present invention;

FIG. 3 is a block diagram of the receiver/monitor unit of the data monitoring and management system shown in FIG. 1 in accordance with one embodiment of the present invention;

FIGS. 4A-4B illustrate a perspective view and a cross sectional view, respectively of an analyte sensor in accordance with one embodiment of the present invention;

FIG. 5 is a flowchart illustrating ambient temperature compensation routine for determining on-skin temperature information in accordance with one embodiment of the present invention;

FIG. 6 is a flowchart illustrating digital anti-aliasing filtering routing in accordance with one embodiment of the present invention;

FIG. 7 is a flowchart illustrating actual or potential sensor insertion or removal detection routine in accordance with one embodiment of the present invention;

FIG. 8 is a flowchart illustrating receiver unit processing corresponding to the actual or potential sensor insertion or removal detection routine of FIG. 7 in accordance with one embodiment of the present invention;

FIG. 9 is a flowchart illustrating data processing corresponding to the actual or potential sensor insertion or removal detection routine in accordance with another embodiment of the present invention;

FIG. 10 is a flowchart illustrating a concurrent passive notification routine in the data receiver/monitor unit of the data monitoring and management system of FIG. 1 in accordance with one embodiment of the present invention;

FIG. 11 is a flowchart illustrating a data quality verification routine in accordance with one embodiment of the present invention;

FIG. 12 is a flowchart illustrating a rate variance filtering routine in accordance with one embodiment of the present invention;

FIG. 13 is a flowchart illustrating a composite sensor sensitivity determination routine in accordance with one embodiment of the present invention;

FIG. 14 is a flowchart illustrating an outlier data point verification routine in accordance with one embodi-

ment of the present invention;

FIG. 15 is a flowchart illustrating a sensor stability verification routine in accordance with one embodiment of the present invention;

FIG. 16 is a flowchart illustrating a calibration failure state detection and/or notification routine in accordance with one embodiment of the present invention;

FIG. 17 is a flowchart illustrating pre-calibration analysis routine in accordance with one embodiment of the present invention; and

FIG. 18 is a flowchart illustrating asynchronous serial data output transmission routine in accordance with one embodiment of the present invention.

15 DETAILED DESCRIPTION

[0015] As described in further detail below, in accordance with the various embodiments of the present invention, there is provided a method and apparatus for providing data processing and control for use in a medical telemetry system. In particular, within the scope of the present invention, there are provided a method and system for providing data communication and control for use in a medical telemetry system such as, for example, a continuous glucose monitoring system.

[0016] FIG. 1 illustrates a data monitoring and management system such as, for example, analyte (e.g., glucose) monitoring system 100 in accordance with one embodiment of the present invention. The subject invention is further described primarily with respect to a glucose monitoring system for convenience and such description is in no way intended to limit the scope of the invention. It is to be understood that the analyte monitoring system may be configured to monitor a variety of analytes, e.g., lactate, and the like.

[0017] Analytes that may be monitored include, for example, acetyl choline, amylase, bilirubin, cholesterol, chorionic gonadotropin, creatine kinase (e.g., CK-MB), creatine, DNA, fructosamine, glucose, glutamine, growth hormones, hormones, ketones, lactate, peroxide, prostate-specific antigen, prothrombin, RNA, thyroid stimulating hormone, and troponin. The concentration of drugs, such as, for example, antibiotics (e.g., gentamicin, vancomycin, and the like), digitoxin, digoxin, drugs of abuse, theophylline, and warfarin, may also be monitored.

[0018] The analyte monitoring system 100 includes a sensor 101, a transmitter unit 102 coupled to the sensor 101, and a primary receiver unit 104 which is configured to communicate with the transmitter unit 102 via a communication link 103. The primary receiver unit 104 may be further configured to transmit data to a data processing terminal 105 for evaluating the data received by the primary receiver unit 104. Moreover, the data processing terminal in one embodiment may be configured to receive data directly from the transmitter unit 102 via a communication link which may optionally be configured for bi-directional communication.

[0019] Also shown in FIG. 1 is a secondary receiver unit 106 which is operatively coupled to the communication link and configured to receive data transmitted from the transmitter unit 102. Moreover, as shown in the Figure, the secondary receiver unit 106 is configured to communicate with the primary receiver unit 104 as well as the data processing terminal 105. Indeed, the secondary receiver unit 106 may be configured for bi-directional wireless communication with each of the primary receiver unit 104 and the data processing terminal 105. As discussed in further detail below, in one embodiment of the present invention, the secondary receiver unit 106 may be configured to include a limited number of functions and features as compared with the primary receiver unit 104. As such, the secondary receiver unit 106 may be configured substantially in a smaller compact housing or embodied in a device such as a wrist watch, for example. Alternatively, the secondary receiver unit 106 may be configured with the same or substantially similar functionality as the primary receiver unit 104, and may be configured to be used in conjunction with a docking cradle unit for placement by bedside, for night time monitoring, and/or bi-directional communication device.

[0020] Only one sensor 101, transmitter unit 102, communication link 103, and data processing terminal 105 are shown in the embodiment of the analyte monitoring system 100 illustrated in FIG. 1. However, it will be appreciated by one of ordinary skill in the art that the analyte monitoring system 100 may include one or more sensor 101, transmitter unit 102, communication link 103, and data processing terminal 105. Moreover, within the scope of the present invention, the analyte monitoring system 100 may be a continuous monitoring system, or semi-continuous, or a discrete monitoring system. In a multi-component environment, each device is configured to be uniquely identified by each of the other devices in the system so that communication conflict is readily resolved between the various components within the analyte monitoring system 100.

[0021] In one embodiment of the present invention, the sensor 101 is physically positioned in or on the body of a user whose analyte level is being monitored. The sensor 101 may be configured to continuously sample the analyte level of the user and convert the sampled analyte level into a corresponding data signal for transmission by the transmitter unit 102. In one embodiment, the transmitter unit 102 is coupled to the sensor 101 so that both devices are positioned on the user's body, with at least a portion of the analyte sensor 101 positioned transcutaneously under the skin layer of the user. The transmitter unit 102 performs data processing such as filtering and encoding on data signals, each of which corresponds to a sampled analyte level of the user, for transmission to the primary receiver unit 104 via the communication link 103.

[0022] In one embodiment, the analyte monitoring system 100 is configured as a one-way RF communication path from the transmitter unit 102 to the primary receiver

unit 104. In such embodiment, the transmitter unit 102 transmits the sampled data signals received from the sensor 101 without acknowledgement from the primary receiver unit 104 that the transmitted sampled data signals have been received. For example, the transmitter unit 102 may be configured to transmit the encoded sampled data signals at a fixed rate (e.g., at one minute intervals) after the completion of the initial power on procedure. Likewise, the primary receiver unit 104 may be configured to detect such transmitted encoded sampled data signals at predetermined time intervals. Alternatively, the analyte monitoring system 100 may be configured with a bi-directional RF (or otherwise) communication between the transmitter unit 102 and the primary receiver unit 104.

[0023] Additionally, in one aspect, the primary receiver unit 104 may include two sections. The first section is an analog interface section that is configured to communicate with the transmitter unit 102 via the communication link 103. In one embodiment, the analog interface section may include an RF receiver and an antenna for receiving and amplifying the data signals from the transmitter unit 102, which are thereafter, demodulated with a local oscillator and filtered through a band-pass filter. The second section of the primary receiver unit 104 is a data processing section which is configured to process the data signals received from the transmitter unit 102 such as by performing data decoding, error detection and correction, data clock generation, and data bit recovery.

[0024] In operation, upon completing the power-on procedure, the primary receiver unit 104 is configured to detect the presence of the transmitter unit 102 within its range based on, for example, the strength of the detected data signals received from the transmitter unit 102 or a predetermined transmitter identification information. Upon successful synchronization with the corresponding transmitter unit 102, the primary receiver unit 104 is configured to begin receiving from the transmitter unit 102 data signals corresponding to the user's detected analyte level. More specifically, the primary receiver unit 104 in one embodiment is configured to perform synchronized time hopping with the corresponding synchronized transmitter unit 102 via the communication link 103 to obtain the user's detected analyte level.

[0025] Referring again to FIG. 1, the data processing terminal 105 may include a personal computer, a portable computer such as a laptop or a handheld device (e.g., personal digital assistants (PDAs)), and the like, each of which may be configured for data communication with the receiver via a wired or a wireless connection. Additionally, the data processing terminal 105 may further be connected to a data network (not shown) for storing, retrieving and updating data corresponding to the detected analyte level of the user.

[0026] Within the scope of the present invention, the data processing terminal 105 may include an infusion device such as an insulin infusion pump or the like, which may be configured to administer insulin to patients, and

which may be configured to communicate with the receiver unit 104 for receiving, among others, the measured analyte level. Alternatively, the receiver unit 104 may be configured to integrate an infusion device therein so that the receiver unit 104 is configured to administer insulin therapy to patients, for example, for administering and modifying basal profiles, as well as for determining appropriate boluses for administration based on, among others, the detected analyte levels received from the transmitter unit 102.

[0027] Additionally, the transmitter unit 102, the primary receiver unit 104 and the data processing terminal 105 may each be configured for bi-directional wireless communication such that each of the transmitter unit 102, the primary receiver unit 104 and the data processing terminal 105 may be configured to communicate (that is, transmit data to and receive data from) with each other via the wireless communication link 103. More specifically, the data processing terminal 105 may in one embodiment be configured to receive data directly from the transmitter unit 102 via the communication link 106, where the communication link 106, as described above, may be configured for bi-directional communication.

[0028] In this embodiment, the data processing terminal 105 which may include an insulin pump, may be configured to receive the analyte signals from the transmitter unit 102, and thus, incorporate the functions of the receiver 103 including data processing for managing the patient's insulin therapy and analyte monitoring. In one embodiment, the communication link 103 may include one or more of an RF communication protocol, an infrared communication protocol, a Bluetooth enabled communication protocol, an 802.11x wireless communication protocol, or an equivalent wireless communication protocol which would allow secure, wireless communication of several units (for example, per HIPPA requirements) while avoiding potential data collision and interference.

[0029] FIG. 2 is a block diagram of the transmitter of the data monitoring and detection system shown in FIG. 1 in accordance with one embodiment of the present invention. Referring to the Figure, the transmitter unit 102 in one embodiment includes an analog interface 201 configured to communicate with the sensor 101 (FIG. 1), a user input 202, and a temperature detection section 203, each of which is operatively coupled to a transmitter processor 204 such as a central processing unit (CPU).

[0030] Further shown in FIG. 2 are a transmitter serial communication section 205 and an RF transmitter 206, each of which is also operatively coupled to the transmitter processor 204. Moreover, a power supply 207 such as a battery is also provided in the transmitter unit 102 to provide the necessary power for the transmitter unit 102. Additionally, as can be seen from the Figure, clock 208 is provided to, among others, supply real time information to the transmitter processor 204.

[0031] As can be seen from FIG. 2, the sensor unit 101 (FIG. 1) is provided four contacts, three of which are electrodes - work electrode (W) 210, guard contact (G) 211,

reference electrode (R) 212, and counter electrode (C) 213, each operatively coupled to the analog interface 201 of the transmitter unit 102. In one embodiment, each of the work electrode (W) 210, guard contact (G) 211, reference electrode (R) 212, and counter electrode (C) 213 may be made using a conductive material that is either printed or etched, for example, such as carbon which may be printed, or metal foil (e.g., gold) which may be etched, or alternatively provided on a substrate material using laser or photolithography.

[0032] In one embodiment, a unidirectional input path is established from the sensor 101 (FIG. 1) and/or manufacturing and testing equipment to the analog interface 201 of the transmitter unit 102, while a unidirectional output is established from the output of the RF transmitter 206 of the transmitter unit 102 for transmission to the primary receiver unit 104. In this manner, a data path is shown in FIG. 2 between the aforementioned unidirectional input and output via a dedicated link 209 from the analog interface 201 to serial communication section 205, thereafter to the processor 204, and then to the RF transmitter 206. As such, in one embodiment, via the data path described above, the transmitter unit 102 is configured to transmit to the primary receiver unit 104 (FIG. 1), via the communication link 103 (FIG. 1), processed and encoded data signals received from the sensor 101 (FIG. 1). Additionally, the unidirectional communication data path between the analog interface 201 and the RF transmitter 206 discussed above allows for the configuration of the transmitter unit 102 for operation upon completion of the manufacturing process as well as for direct communication for diagnostic and testing purposes.

[0033] As discussed above, the transmitter processor 204 is configured to transmit control signals to the various sections of the transmitter unit 102 during the operation of the transmitter unit 102. In one embodiment, the transmitter processor 204 also includes a memory (not shown) for storing data such as the identification information for the transmitter unit 102, as well as the data signals received from the sensor 101. The stored information may be retrieved and processed for transmission to the primary receiver unit 104 under the control of the transmitter processor 204. Furthermore, the power supply 207 may include a commercially available battery.

[0034] The transmitter unit 102 is also configured such that the power supply section 207 is capable of providing power to the transmitter for a minimum of about three months of continuous operation after having been stored for about eighteen months in a low-power (non-operating) mode. In one embodiment, this may be achieved by the transmitter processor 204 operating in low power modes in the non-operating state, for example, drawing no more than approximately 1 μ A of current. Indeed, in one embodiment, the final step during the manufacturing process of the transmitter unit 102 may place the transmitter unit 102 in the lower power, non-operating state (i.e., post-manufacture sleep mode). In this manner, the

shelf life of the transmitter unit 102 may be significantly improved. Moreover, as shown in FIG. 2, while the power supply unit 207 is shown as coupled to the processor 204, and as such, the processor 204 is configured to provide control of the power supply unit 207, it should be noted that within the scope of the present invention, the power supply unit 207 is configured to provide the necessary power to each of the components of the transmitter unit 102 shown in FIG. 2.

[0035] Referring back to FIG. 2, the power supply section 207 of the transmitter unit 102 in one embodiment may include a rechargeable battery unit that may be recharged by a separate power supply recharging unit (for example, provided in the receiver unit 104) so that the transmitter unit 102 may be powered for a longer period of usage time. Moreover, in one embodiment, the transmitter unit 102 may be configured without a battery in the power supply section 207, in which case the transmitter unit 102 may be configured to receive power from an external power supply source (for example, a battery) as discussed in further detail below.

[0036] Referring yet again to FIG. 2, the temperature detection section 203 of the transmitter unit 102 is configured to monitor the temperature of the skin near the sensor insertion site. The temperature reading is used to adjust the analyte readings obtained from the analog interface 201. The RF transmitter 206 of the transmitter unit 102 may be configured for operation in the frequency band of 315 MHz to 322 MHz, for example, in the United States. Further, in one embodiment, the RF transmitter 206 is configured to modulate the carrier frequency by performing Frequency Shift Keying and Manchester encoding. In one embodiment, the data transmission rate is 19,200 symbols per second, with a minimum transmission range for communication with the primary receiver unit 104.

[0037] Referring yet again to FIG. 2, also shown is a leak detection circuit 214 coupled to the guard electrode (G) 211 and the processor 204 in the transmitter unit 102 of the data monitoring and management system 100. The leak detection circuit 214 in accordance with one embodiment of the present invention may be configured to detect leakage current in the sensor 101 to determine whether the measured sensor data are corrupt or whether the measured data from the sensor 101 is accurate.

[0038] FIG. 3 is a block diagram of the receiver/monitor unit of the data monitoring and management system shown in FIG. 1 in accordance with one embodiment of the present invention. Referring to FIG. 3, the primary receiver unit 104 includes a blood glucose test strip interface 301, an RF receiver 302, an input 303, a temperature detection section 304, and a clock 305, each of which is operatively coupled to a receiver processor 307. As can be further seen from the Figure, the primary receiver unit 104 also includes a power supply 306 operatively coupled to a power conversion and monitoring section 308. Further, the power conversion and monitoring section 308 is also coupled to the receiver processor 307.

Moreover, also shown are a receiver serial communication section 309, and an output 310, each operatively coupled to the receiver processor 307.

[0039] In one embodiment, the test strip interface 301 includes a glucose level testing portion to receive a manual insertion of a glucose test strip, and thereby determine and display the glucose level of the test strip on the output 310 of the primary receiver unit 104. This manual testing of glucose can be used to calibrate sensor 101. The RF receiver 302 is configured to communicate, via the communication link 103 (FIG. 1) with the RF transmitter 206 of the transmitter unit 102, to receive encoded data signals from the transmitter unit 102 for, among others, signal mixing, demodulation, and other data processing. The input 303 of the primary receiver unit 104 is configured to allow the user to enter information into the primary receiver unit 104 as needed. In one aspect, the input 303 may include one or more keys of a keypad, a touch-sensitive screen, or a voice-activated input command unit. The temperature detection section 304 is configured to provide temperature information of the primary receiver unit 104 to the receiver processor 307, while the clock 305 provides, among others, real time information to the receiver processor 307.

[0040] Each of the various components of the primary receiver unit 104 shown in FIG. 3 is powered by the power supply 306 which, in one embodiment, includes a battery. Furthermore, the power conversion and monitoring section 308 is configured to monitor the power usage by the various components in the primary receiver unit 104 for effective power management and to alert the user, for example, in the event of power usage which renders the primary receiver unit 104 in sub-optimal operating conditions. An example of such sub-optimal operating condition may include, for example, operating the vibration output mode (as discussed below) for a period of time thus substantially draining the power supply 306 while the processor 307 (thus, the primary receiver unit 104) is turned on. Moreover, the power conversion and monitoring section 308 may additionally be configured to include a reverse polarity protection circuit such as a field effect transistor (FET) configured as a battery activated switch.

[0041] The serial communication section 309 in the primary receiver unit 104 is configured to provide a bi-directional communication path from the testing and/or manufacturing equipment for, among others, initialization, testing, and configuration of the primary receiver unit 104. Serial communication section 104 can also be used to upload data to a computer, such as time-stamped blood glucose data. The communication link with an external device (not shown) can be made, for example, by cable, infrared (IR) or RF link. The output 310 of the primary receiver unit 104 is configured to provide, among others, a graphical user interface (GUI) such as a liquid crystal display (LCD) for displaying information. Additionally, the output 310 may also include an integrated speaker for outputting audible signals as well as to provide

vibration output as commonly found in handheld electronic devices, such as mobile telephones presently available. In a further embodiment, the primary receiver unit 104 also includes an electro-luminescent lamp configured to provide backlighting to the output 310 for output visual display in dark ambient surroundings.

[0042] Referring back to FIG. 3, the primary receiver unit 104 in one embodiment may also include a storage section such as a programmable, non-volatile memory device as part of the processor 307, or provided separately in the primary receiver unit 104, operatively coupled to the processor 307. The processor 307 is further configured to perform Manchester decoding as well as error detection and correction upon the encoded data signals received from the transmitter unit 102 via the communication link 103.

[0043] In a further embodiment, the one or more of the transmitter unit 102, the primary receiver unit 104, secondary receiver unit 105, or the data processing terminal/infusion section 105 may be configured to receive the blood glucose value wirelessly over a communication link from, for example, a glucose meter. In still a further embodiment, the user or patient manipulating or using the analyte monitoring system 100 (FIG. 1) may manually input the blood glucose value using, for example, a user interface (for example, a keyboard, keypad, and the like) incorporated in the one or more of the transmitter unit 102, the primary receiver unit 104, secondary receiver unit 105, or the data processing terminal/infusion section 105.

[0044] Additional detailed description of the continuous analyte monitoring system, its various components including the functional descriptions of the transmitter are provided in U.S. Patent No. 6,175,752 issued January 16, 2001 entitled "Analyte Monitoring Device and Methods of Use", and in application US 2004-0186365 A1 published September 23, 2004 entitled "Continuous Glucose Monitoring System and Methods of Use", each assigned to the Assignee of the present application.

[0045] FIGS. 4A-4B illustrate a perspective view and a cross sectional view, respectively of an analyte sensor in accordance with one embodiment of the present invention. Referring to FIG. 4A, a perspective view of a sensor 400, the major portion of which is above the surface of the skin 410, with an insertion tip 430 penetrating through the skin and into the subcutaneous space 420 in contact with the user's biofluid such as interstitial fluid. Contact portions of a working electrode 401, a reference electrode 402, and a counter electrode 403 can be seen on the portion of the sensor 400 situated above the skin surface 410. Working electrode 401, a reference electrode 402, and a counter electrode 403 can be seen at the end of the insertion tip 403.

[0046] Referring now to FIG. 4B, a cross sectional view of the sensor 400 in one embodiment is shown. In particular, it can be seen that the various electrodes of the sensor 400 as well as the substrate and the dielectric layers are provided in a stacked or layered configuration

or construction. For example, as shown in FIG. 4B, in one aspect, the sensor 400 (such as the sensor unit 101 FIG. 1), includes a substrate layer 404, and a first conducting layer 401 such as a carbon trace disposed on at least a portion of the substrate layer 404, and which may comprise the working electrode. Also shown disposed on at least a portion of the first conducting layer 401 is a sensing layer 408.

[0047] Referring back to FIG. 4B, a first insulation layer such as a first dielectric layer 405 is disposed or stacked on at least a portion of the first conducting layer 401, and further, a second conducting layer 409 such as another carbon trace may be disposed or stacked on top of at least a portion of the first insulation layer (or dielectric layer) 405. As shown in FIG. 4B, the second conducting layer 409 may comprise the reference electrode 402, and in one aspect, may include a layer of silver/silver chloride (Ag/AgCl).

[0048] Referring still again to FIG. 4B, a second insulation layer 406 such as a dielectric layer in one embodiment may be disposed or stacked on at least a portion of the second conducting layer 409. Further, a third conducting layer 403 which may include carbon trace and that may comprise the counter electrode 403 may in one embodiment be disposed on at least a portion of the second insulation layer 406. Finally, a third insulation layer 407 is disposed or stacked on at least a portion of the third conducting layer 403. In this manner, the sensor 400 may be configured in a stacked or layered construction or configuration such that at least a portion of each of the conducting layers is separated by a respective insulation layer (for example, a dielectric layer).

[0049] Additionally, within the scope of the present invention, some or all of the electrodes 401, 402, 403 may be provided on the same side of the substrate 404 in a stacked construction as described above, or alternatively, may be provided in a coplanar manner such that each electrode is disposed on the same plane on the substrate 404, however, with a dielectric material or insulation material disposed between the conducting layers/electrodes. Furthermore, in still another aspect of the present invention, the one or more conducting layers such as the electrodes 401, 402, 403 may be disposed on opposing sides of the substrate 404.

[0050] Referring back to the Figures, in one embodiment, the transmitter unit 102 (FIG. 1) is configured to detect the current signal from the sensor unit 101 (FIG. 1) and the skin temperature near the sensor unit 101, which are preprocessed by, for example, by the transmitter processor 204 (FIG. 2) and transmitted to the receiver unit (for example, the primary receiver unit 104 (FIG. 1) periodically at a predetermined time interval, such as for example, but not limited to, once per minute, once every two minutes, once every five minutes, or once every ten minutes. Additionally, the transmitter unit 102 may be configured to perform sensor insertion and/or removal detection and data quality analysis, information pertaining to which are also transmitted to the receiver

unit 104 periodically at the predetermined time interval. In turn, the receiver unit 104 may be configured to perform, for example, skin temperature compensation as well as calibration of the sensor data received from the transmitter 102.

[0051] For example, in one aspect, the transmitter unit 102 may be configured to oversample the sensor signal at a nominal rate of four samples per second, which allows the analyte anti-aliasing filter in the transmitter unit 102 to attenuate noise (for example, due to effects resulting from motion or movement of the sensor after placement) at frequencies above 2 Hz. More specifically, in one embodiment, the transmitter processor 204 may be configured to include a digital filter to reduce aliasing noise when decimating the four Hz sampled sensor data to once per minute samples for transmission to the receiver unit 104. As discussed in further detail below, in one aspect, a two stage Kaiser Finite Impulse Response (FIR) filter may be used to perform the digital filtering for anti-aliasing. While Kaiser FIR filter may be used for digital filtering of the sensor signals, within the scope of the present disclosure, other suitable filters may be used to filter the sensor signals.

[0052] In one aspect, the temperature measurement section 203 of the transmitter unit 102 may be configured to measure once per minute the on skin temperature near the analyte sensor at the end of the minute sampling cycle of the sensor signal. Within the scope of the present disclosure, different sample rates may be used which may include, for example, but are not limited to, measuring the on skin temperature for each 30 second periods, each two minute periods, and the like. Additionally, as discussed above, the transmitter unit 102 may be configured to detect sensor insertion, sensor signal settling after sensor insertion, and sensor removal, in addition to detecting for sensor - transmitter system failure modes and sensor signal data integrity. Again, this information is transmitted periodically by the transmitter unit 102 to the receiver unit 104 along with the sampled sensor signals at the predetermined time intervals.

[0053] Referring again to the Figures, as the analyte sensor measurements are affected by the temperature of the tissue around the transcutaneously positioned sensor unit 101, in one aspect, compensation of the temperature variations and affects on the sensor signals are provided for determining the corresponding glucose value. Moreover, the ambient temperature around the sensor unit 101 may affect the accuracy of the on skin temperature measurement and ultimately the glucose value determined from the sensor signals. Accordingly, in one aspect, a second temperature sensor is provided in the transmitter unit 102 away from the on skin temperature sensor (for example, physically away from the temperature measurement section 203 of the transmitter unit 102), so as to provide compensation or correction of the on skin temperature measurements due to the ambient temperature effects. In this manner, the accuracy of the estimated glucose value corresponding to the sensor sig-

nals may be attained.

[0054] In one aspect, the processor 204 of the transmitter unit 102 may be configured to include the second temperature sensor, and which is located closer to the ambient thermal source within the transmitter unit 102. In other embodiments, the second temperature sensor may be located at a different location within the transmitter unit 102 housing where the ambient temperature within the housing of the transmitter unit 102 may be accurately determined.

[0055] Referring now to FIG. 5, in one aspect, an ambient temperature compensation routine for determining the on-skin temperature level for use in the glucose estimation determination based on the signals received from the sensor unit 101. Referring to FIG. 5, for each sampled signal from the sensor unit 101, a corresponding measured temperature information is received (510), for example, by the processor 204 from the temperature measurement section 203 (which may include, for example, a thermistor provided in the transmitter unit 102). In addition, a second temperature measurement is obtained (520), for example, including a determination of the ambient temperature level using a second temperature sensor provided within the housing of the transmitter unit 102. In one aspect, the measured on-skin temperature information (510) and the ambient temperature information (520) may be received substantially simultaneously, or in a further aspect, the ambient temperature information (520) may be received prior to or after the measured on-skin temperature information (510).

[0056] In one aspect, based on a predetermined ratio of thermal resistances between the temperature measurement section 203 and the second temperature sensor (located, for example, within the processor 204 of the transmitter unit 102), and between the temperature measurement section 203 and the skin layer on which the transmitter unit 102 is placed and coupled to the sensor unit 101, ambient temperature compensation may be performed (530), to determine the corresponding ambient temperature compensated on skin temperature level (540). In one embodiment, the predetermined ratio of the thermal resistances may be approximately 0.2. However, within the scope of the present invention, this thermal resistance ratio may vary according to the design of the system, for example, based on the size of the transmitter unit 102 housing, the location of the second temperature sensor within the housing of the transmitter unit 102, as well as based on, for example, one or more complex compensation modeling algorithms such as a linear model with an offset, a polynomial model and the like.

[0057] With the ambient temperature compensated on-skin temperature information, the corresponding glucose value from the sampled analyte sensor signal may be determined.

[0058] Referring again to FIG. 2, the processor 204 of the transmitter unit 102 may include a digital anti-aliasing filter. Using analog anti-aliasing filters for a one minute measurement data sample rate would require a large ca-

capacitor in the transmitter unit 102 design, and which in turn impacts the size of the transmitter unit 102. As such, in one aspect, the sensor signals may be oversampled (for example, at a rate of 4 times per second), and then the data is digitally decimated to derive a one-minute sample rate.

[0059] As discussed above, in one aspect, the digital anti-aliasing filter may be used to remove, for example, signal artifacts or otherwise undesirable aliasing effects on the sampled digital signals received from the analog interface 201 of the transmitter unit 102. For example, in one aspect, the digital anti-aliasing filter may be used to accommodate decimation of the sensor data from approximately four Hz samples to one-minute samples. In one aspect, a two stage FIR filter may be used for the digital anti-aliasing filter, and which includes improved response time, pass band and stop band properties.

[0060] Referring to FIG. 6, a routine for digital anti-aliasing filtering is shown in accordance with one embodiment. As shown, in one embodiment, at each predetermined time period such as every minute, the analog signal from the analog interface 201 corresponding to the monitored analyte level received from the sensor unit 101 (FIG. 1) is sampled (610). For example, at every minute, in one embodiment, the signal from the analog interface 201 is over-sampled at approximately 4 Hz. Thereafter, the first stage digital filtering on the over-sampled data is performed (620), where, for example, a 1/6 down-sampling from 246 samples to 41 samples is performed, and the resulting 41 samples is further down-sampled at the second stage digital filtering (630) such that, for example, a 1/41 down-sampling is performed from 41 samples (from the first stage digital filtering), to a single sample. Thereafter, the filter is reset (640), and the routine returns to the beginning for the next minute signal received from the analog interface 201.

[0061] While the use of FIR filter, and in particular the use of Kaiser FIR filter, is within the scope of the present invention, other suitable filters, such as FIR filters with different weighting schemes or Infinite Impulse Response (IIR) filters, may be used.

[0062] Referring yet again to the Figures, the transmitter unit 102 may be configured in one embodiment to periodically perform data quality checks including error condition verifications and potential error condition detections, and also to transmit the relevant information related to one or more data quality, error condition or potential error condition detection to the receiver unit 104 with the transmission of the monitored sensor data. For example, in one aspect, a state machine may be used in conjunction with the transmitter unit 102 and which may be configured to be updated four times per second, the results of which are transmitted to the receiver unit 104 every minute.

[0063] In particular, using the state machine, the transmitter unit 102 may be configured to detect one or more states that may indicate when a sensor is inserted, when a sensor is removed from the user, and further, may ad-

ditionally be configured to perform related data quality checks so as to determine when a new sensor has been inserted or transcutaneously positioned under the skin layer of the user and has settled in the inserted state such that the data transmitted from the transmitter unit 102 does not compromise the integrity of signal processing performed by the receiver unit 104 due to, for example, signal transients resulting from the sensor insertion.

[0064] That is, when the transmitter unit 102 detects low or no signal from the sensor unit 102, which is followed by detected signals from the sensor unit 102 that is above a given signal, the processor 204 may be configured to identify such transition is monitored signal levels and associate with a potential sensor insertion state. Alternatively, the transmitter unit 102 may be configured to detect the signal level above the another predetermined threshold level, which is followed by the detection of the signal level from the sensor unit 101 that falls below the predetermined threshold level. In such a case, the processor 204 may be configured to associate or identify such transition or condition in the monitored signal levels as a potential sensor removal state.

[0065] Accordingly, when either of potential sensor insertion state or potential sensor removal state is detected by the transmitter unit 102, this information is transmitted to the receiver unit 104, and in turn, the receiver unit may be configured to prompt the user for confirmation of either of the detected potential sensor related state. In another aspect, the sensor insertion state or potential sensor removal state may be detected or determined by the receiver unit based on one or more signals received from the transmitter unit 102. For example, similar to an alarm condition or a notification to the user, the receiver unit 104 may be configured to display a request or a prompt on the display or an output unit of the receiver unit 104 a text and/or other suitable notification message to inform the user to confirm the state of the sensor unit 101.

[0066] For example, the receiver unit 104 may be configured to display the following message: "New Sensor Inserted?" or a similar notification in the case where the receiver unit 104 receives one or more signals from the transmitter unit 102 associated with the detection of the signal level below the predetermined threshold level for the predefined period of time, followed by the detection of the signal level from the sensor unit 101 above another predetermined threshold level for another predefined period of time. Additionally, the receiver unit 104 may be configured to display the following message: "Sensor Removed?" or a similar notification in the case where the receiver unit 104 received one or more signals from the transmitter unit 102 associated with the detection of the signal level from the sensor unit 101 that is above the another predetermined threshold level for the another predefined period of time, which is followed by the detection of the signal level from the sensor unit 101 that falls below the predetermined threshold level for the predefined period of time.

[0067] Based on the user confirmation received, the

receiver unit 104 may be further configured to execute or perform additional related processing and routines in response to the user confirmation or acknowledgement. For example, when the user confirms, using the user interface input/output mechanism of the receiver unit 104, for example, that a new sensor has been inserted, the receiver unit 104 may be configured to initiate a new sensor insertion related routines including, such as, for example, a sensor calibration routine including, for example, calibration timer, sensor expiration timer and the like. Alternatively, when the user confirms or it is determined that the sensor unit 101 is not properly positioned or otherwise removed from the insertion site, the receiver unit 104 may be accordingly configured to perform related functions such as, for example, stop displaying of the glucose values/levels, or deactivating the alarm monitoring conditions.

[0068] On the other hand, in response to the potential sensor insertion notification generated by the receiver unit 104, if the user confirms that no new sensor has been inserted, then the receiver unit 104 in one embodiment is configured to assume that the sensor unit 101 is in acceptable operational state, and continues to receive and process signals from the transmitter unit 102.

[0069] In this manner, in cases, for example, when there is momentary movement or temporary dislodging of the sensor unit 101 from the initially positioned transcutaneous state, or when one or more of the contact points between sensor unit 101 and the transmitter unit 102 are temporarily disconnected, but otherwise, the sensor unit 101 is operational and within its useful life, the routine above provides an option to the user to maintain the usage of the sensor unit 101, and not replacing the sensor unit 101 prior to the expiration of its useful life. In this manner, in one aspect, false positive indications of sensor unit 101 failure may be identified and addressed.

[0070] For example, FIG. 7 is a flowchart illustrating actual or potential sensor insertion or removal detection routine in accordance with one embodiment of the present invention. Referring to the Figure, the current analyte related signal is first compared to a predetermined signal characteristic (710). In one aspect, the predetermined signal characteristic may include one of a signal level transition from below a first predetermined level (for example, but not limited to 18 ADC (analog to digital converter) counts) to above the first predetermined level, a signal level transition from above a second predetermined level (for example, but not limited to 9 ADC counts) to below the second predetermined level, a transition from below a predetermined signal rate of change threshold to above the predetermined signal rate of change threshold, and a transition from above the predetermined signal rate of change threshold to below the predetermined signal rate of change threshold. Moreover, in another aspect, the predetermined signal characteristic may include the determination of the current analyte related signal maintained at the transitioned signal

state for a predetermined time period, such as, for example, approximately 10 seconds. That is, referring to FIG. 7, in one embodiment, the current analyte related signal may be compared to the predetermined signal characteristic such that it is determined that the current analyte related signal has transitioned from one state to another as described above, and further, that the current analyte related signal is maintained at the transitioned signal level/characteristic for a given time period.

[0071] Referring back to the Figure, after comparing the current analyte related signal to the predetermined signal characteristic (710), a corresponding operational state associated with an analyte monitoring device is determined (720). That is, in one aspect, based on the one or more of the signal level transition discussed above, the corresponding operational state of the analyte monitoring device such as, for example, the operational state of the analyte sensor 101 (FIG. 1) may be determined. Referring again to FIG. 7, after determining the corresponding operational state associated with the analyte monitoring device (720), an output data associated with the operational state is generated (730). That is, in one aspect, an output indication representative of the determined sensor operational state may be provided.

[0072] In this manner, in one aspect of the present invention, based on a transition state of the received analyte related signals, it may be possible to determine the state of the analyte sensor and, based on which, the user or the patient may confirm whether the analyte sensor is in the desired or proper position, has been temporarily dislocated, or otherwise, removed from the desired insertion site so as to require a new analyte sensor.

[0073] In this manner, in one aspect, when the monitored signal from the sensor unit 101 crosses a transition level (for example, from no or low signal level to a high signal level, or vice versa), the transmitter unit 102 may be configured to generate an appropriate output data associated with the sensor signal transition, for transmission to the receiver unit 104 (FIG. 1). Additionally, as discussed in further detail below, in another embodiment, the determination of whether the sensor unit 101 has crossed a transition level may be determined by the receiver/monitor unit 104/106 based, at least in part, on the one or more signals received from the transmitter unit 102.

[0074] FIG. 8 is a flowchart illustrating receiver unit processing corresponding to the actual or potential sensor insertion or removal detection routine of FIG. 7 in accordance with one embodiment of the present invention. Referring now to FIG. 8, when the receiver unit 104 receives the generated output data from the transmitter unit 102 (810), a corresponding operation state is associated with the received output data (820), for example, related to the operational state of the sensor unit 101. Moreover, a notification associated with the sensor unit operation state is generated and output to the user on the display unit or any other suitable output segment of the receiver unit 104 (830). When a user input signal is

received in response to the notification associated with the sensor state operation state (840), the receiver unit 104 is configured to execute one or more routines associated with the received user input signal (850).

[0075] That is, as discussed above, in one aspect, if the user confirms that the sensor unit 101 has been removed, the receiver unit 104 may be configured to terminate or deactivate alarm monitoring and glucose displaying functions. On the other hand, if the user confirms that a new sensor unit 101 has been positioned or inserted into the user, then the receiver unit 104 may be configured to initiate or execute routines associated with the new sensor insertion, such as, for example, calibration procedures, establishing calibration timer, and establishing sensor expiration timer.

[0076] In a further embodiment, based on the detected or monitored signal transition, the receiver/monitor unit may be configured to determine the corresponding sensor state without relying upon the user input or confirmation signal associated with whether the sensor is dislocated or removed from the insertion site, or otherwise, operating properly.

[0077] FIG. 9 is a flowchart illustrating data processing corresponding to the actual or potential sensor insertion or removal detection routine in accordance with another embodiment of the present invention. Referring to FIG. 9, a current analyte related signal is received and compared to a predetermined signal characteristic (910). Thereafter, an operational state associated with an analyte monitoring device such as, for example, the sensor unit 101 (FIG. 1) is retrieved (920) from a storage unit or otherwise resident in, for example, a memory of the receiver/monitor unit 104/106. An output data is generated which is associated with the operational state, and which at least in part is based on the one or more of the received current analyte related signal and the retrieved prior analyte related signal (930).

[0078] Referring again to FIG. 9, when the output data is generated, a corresponding user input command or signal is received in response to the generated output data (940), and which may include one or more of a confirmation, verification, or rejection of the operational state related to the analyte monitoring device.

[0079] FIG. 10 is a flowchart illustrating a concurrent passive notification routine in the data receiver/monitor unit of the data monitoring and management system of FIG. 1 in accordance with one embodiment of the present invention. Referring to FIG. 10, a predetermined routine is executed for a time period to completion (1010). During the execution of the predetermined routine, an alarm condition is detected (1020), and when the alarm or alert condition is detected, a first indication associated with the detected alarm or alert condition is output concurrent to the execution of the predetermined routine (1030).

[0080] That is, in one embodiment, when a predefined routine is being executed, and an alarm or alert condition is detected, a notification is provided to the user or patient associated with the detected alarm or alert condition, but

which does not interrupt or otherwise disrupt the execution of the predefined routine. Referring back to FIG. 10, upon termination of the predetermined routine, another output or second indication associated with the detected alarm condition is output or displayed (1040).

[0081] More specifically, in one aspect, the user interface notification feature associated with the detected alarm condition is output to the user only upon the completion of an ongoing routine which was in the process of being executed when the alarm condition is detected. As discussed above, when such alarm condition is detected during the execution of a predetermined routine, an alarm notification such as, for example, a backlight indicator, an icon, a modification in any display item feature such as a border around a field that flashes, or a text output on the user interface display or any other suitable output indication may be provided to alert the user or the patient of the detected alarm condition substantially in real time, but which does not disrupt an ongoing routine.

[0082] Within the scope of the present disclosure, the ongoing routine or the predetermined routine being executed may include one or more of performing a blood glucose test (for example, for purposes of periodically calibrating the sensor unit 101), or any other processes that interface with the user interface, for example, on the receiver/monitor unit 104/106 (FIG. 1) including, but not limited to the configuration of device settings, review of historical data such as glucose data, alarms, events, entries in the data log, visual displays of data including graphs, lists, and plots, data communication management including RF communication administration, data transfer to the data processing terminal 105 (FIG. 1), or viewing one or more alarm conditions with a different priority in a preprogrammed or determined alarm or notification hierarchy structure.

[0083] In this manner, in one aspect of the present invention, the detection of one or more alarm conditions may be presented or notified to the user or the patient, without interrupting or disrupting an ongoing routine or process in, for example, the receiver/monitor unit 104/106 or the data monitoring and management system 100 (FIG. 1).

[0084] Referring again to the Figures, in one aspect, the transmitter unit 102 may be configured to perform one or more periodic or routine data quality check or verification before transmitting the data packet to the receiver/monitor unit 104/106. For example, in one aspect, for each data transmission (e.g., every 60 seconds, or some other predetermined transmission time interval), the transmitter data quality flags in the data packet are reset, and then it is determined whether any data fields in the transmission data packet includes an error flag. If one error flag is detected, then in one aspect, the entire data packet may be considered corrupt, and this determination is transmitted to the receiver/monitor unit 104/106. Alternatively, the determination that the entire data packet is corrupt may be performed by the receiver/monitor unit 104/106. Accordingly, in one aspect, when at least

one data quality check fails in the transmitter data packet, the entire packet is deemed to be in error, and the associated monitored analyte level is discarded, and not further processed by the receiver/monitor unit 104/106.

[0085] In a further aspect, when an error flag is included in the data packet, the receiver monitor unit 104/106 may be configured to determine the level or degree of signal degradation or corruptness, and further, may utilize the data in one or more further routines.

[0086] In another aspect, the data quality check in the transmitter unit 102 data packet may be performed so as to identify each error flag in the data packet, and those identified error flag are transmitted to the receiver/monitor unit 104/106 in addition to the associated monitored analyte level information. In this manner, in one aspect, if the error flag is detected in the transmitter data packet which is not relevant to the accuracy of the data associated with the monitored analyte level, the error indication is flagged and transmitted to the receiver/monitor unit 104/106 in addition to the data indicating the monitored analyte level. In a further aspect, when one or more error flags is identified in the transmitter unit 102 data packet, the transmitter unit 102 data packet may not be transmitted, but rather, the error flags may be transmitted and not the associated data. Alternatively, the transmitted data from the transmitter unit 102 may include the error flags as well as the associated data.

[0087] In one aspect, examples of error condition that may be detected or flagged in the transmitter unit 102 data packet include sensor connection fault verification by, for example, determining, among others, whether the monitored analyte level signal is within a predetermined range, whether the counter electrode voltage signal is within a predetermined range, one or more rate of changes of the monitored analyte level deviating from a predetermined threshold level, transmitter unit temperature (ambient and/or on-skin temperature) out of range, and the like. As discussed above, the data quality check in the transmitter unit 102 may be performed serially, such that detection of an error condition or an error flag renders the entire data packet invalid or deemed corrupt. In this case, such data is reported as including error to the receiver/monitor unit 104/106, but not used to process the associated monitored analyte level.

[0088] In another aspect, all data quality fields in the data packet of the transmitter unit 102 may be checked for error flags, and if there are error flags detected, the indication of the detected error flags is transmitted with the data packet to the receiver/monitor unit 104/106 for further processing. Alternatively, the transmitter unit 102 may be configured to transmit the data packet with the error flags to the receiver/monitor unit 104/106, and where the above-described error checking/verification routine is performed by the receiver/monitor unit 104/106.

[0089] In one embodiment, on the receiver/monitor unit 104/106 side, for each periodic data packet received (for example every 60 seconds or some other predetermined time interval), the receiver/monitor unit 104/106 may be

configured to receive the raw glucose data including any data quality check flags from the transmitter unit 102, and to apply temperature compensation and/or calibration to the raw data to determine the corresponding glucose data (accounting for any data quality flags as may have been identified). The unfiltered, temperature compensated and/or calibrated glucose data is stored along with any data quality flags in a FIFO buffer (including, for example, any invalid data identifier). Alternatively, a further data quality check may be performed by the receiver/monitor unit 104/106 on the temperature compensated and calibrated glucose data to determine the rate of change or variance of the measured glucose data. For example, in one embodiment, a high variance check or verification is performed on 15 minutes of glucose data stored in the FIFO buffer. If it is determined that the rate of variance exceeds a predetermined threshold, then the data packet in process may be deemed invalid. The FIFO buffer stores all or a subset of this data, including any associated validity or error flags.

[0090] Thereafter, the data processing is performed on the stored data to determine, for example, the respective glucose level estimation or calculation. That is, the stored data in the FIFO buffer, in one embodiment, is processed to reduce unwanted variation in signal measurements due to noise or time delay, among others. In one aspect, when the rate of change or a certainty measure of the rate of change of the data stored in the FIFO buffer is within a predetermined limit, the glucose measurements are filtered over a 15 minute period. On the other hand, if it is determined that the rate of change or the certainty measure of the rate of change is greater than the predetermined limit, a more responsive 2 minute filtering is performed. In one aspect, the filtering is performed for each 60 second glucose data. In this manner, in one embodiment, a rate variance filter is provided that may be configured to smooth out the variation in the glucose measurement when the glucose level is relatively stable, and further, that can respond quickly when the glucose level is changing rapidly. The rate variance filter may be implemented in firmware as an FIR filter which is stable and easy to implement in integer-based firmware, for example, implemented in fixed point math processor.

[0091] In one embodiment, for each 60 second glucose data received, two filtered values and two additional parameters are determined. That is, using an FIR filter, for example, a weighted average for a 15 minute filtered average glucose value and a 2 minute average filtered glucose value are determined. In addition, a rate of change based on 15 minutes of data as well as a standard deviation is determined. To determine the final filtered glucose value for output and/or display to the user, a weighted average of the two determined filtered glucose values is determined, where when the rate of change of the glucose values is above a predetermined threshold (high), then weighting is configured to tend towards the 2 minute filtered value, while when the uncertainty is high, the weighting tends towards the 15 minute filtered value. In

this manner, when the rate of change is high, the 2 minute filtered value is weighted more heavily (as the 15 minute filtered average value potentially introduces lag, which at higher rates of change, likely results in large error).

[0092] Referring back, during the calibration routine, in one embodiment, when the discrete blood glucose value (or reference glucose value) is received to calibrate the analyte related data from the sensor unit 101 (FIG. 1), the processing unit of the receiver/monitor unit 104/106 is configured to retrieve from the FIFO buffer two of the last five valid transmitter data packet that does not include any data quality flags associated with the respective data packets. In this manner, in one aspect, calibration validation check may be performed when the blood glucose value is provided to the receiver/monitor unit 104/106 determined using, for example, a blood glucose meter. In the event that two valid data from the last five data packets cannot be determined, the receiver/monitor unit 104/106 is configured to alarm or notify the user, and the calibration routine is terminated.

[0093] On the other hand, if the calibration validation check is successful, the sensitivity associated with the sensor 101 (FIG. 1) is determined, and its range verified. In one aspect, if the sensitivity range check fails, again, the receiver/monitor unit 104/106 may be configured to alarm or otherwise notify the user and terminate the calibration routine. Otherwise, the determined sensitivity is used for subsequent glucose data measurement and processing (until a subsequent calibration is performed).

[0094] In one aspect, when calibration is required, the underlying conditions for performing calibration are verified or evaluated to determine whether the conditions associated with the calibration routine is appropriate, and the resulting determination (whether the conditions are appropriate or not) is indicated to the user. For example, the determination of whether the underlying one or more conditions (pre-calibration conditions) are appropriate for the calibration routine may include adequate sensor data availability and validity for sensitivity determination, adequate sensor data availability and validity for rate of change determination, assessment of the rate of change based on a predetermined threshold level, determination of the higher order sensor data variation estimate below a predetermined threshold level, the elapsed time since the sensor insertion exceeding a predetermined time period, the temperature associated with the sensor data within a predefined range, suitability of the calibration routine timing, and the like.

[0095] Based on the result of the pre-calibration processing described above, for example, in one embodiment, the user is notified of the outcome of the pre-calibration condition determination. For example, in one aspect, the user may be provided with a "wait" icon displayed on the user interface of the receiver/monitor unit 104/106 (FIG. 1) when calibration is necessary but it has been determined that the conditions associated with the calibration routine are not appropriate. Thereafter, when the one or more underlying conditions associated with

the calibration routine changes, and thus the calibration may be performed, the "wait" icon displayed may be changed into another icon or visual display (such as a blood drop icon, for example), or any other suitable user notification output. For example, the notification associated with the calibration, the determination of the underlying conditions associated with the calibration routine and the like may be provided using one or more graphical, text, audible and tactile output.

[0096] In one aspect, the sensor 101 (FIG. 1) may require a predetermined number of baseline calibrations during its use. For a five day operational lifetime of a sensor, four calibrations may be required at different times during the five day period. More specifically, in one embodiment, the user may be prompted to perform the scheduled calibrations based on a predetermined calibration schedule.

[0097] For each sensor implant period, which is for a predetermined time (for example, 3 days, 5 days or 7 days), baseline calibrations are required at predefined times which can be determined in different ways. The first baseline calibration time may be a predefined elapsed time relative to sensor insertion confirmation. In one embodiment, the two or more following baseline calibrations request times are each based on predefined elapsed time periods since the last successful baseline calibration. For instance, in the embodiment in which the initial baseline request is made at 10 hours since insertion, baseline calibration requests are made for the second, third and fourth baseline calibrations 2, 12 and 48 hours since the last successful baseline calibration, respectively.

[0098] In a further aspect, the scheduled calibration timing may be relative to the prior calibration time periods, starting with the initial sensor positioning. That is, after the initial transcutaneous positioning of the sensor unit 101 (FIG. 1) and the scheduled time period has elapsed to allow the sensor unit 101 to reach a certain stability point, the user may be prompted to perform the first baseline calibration as described above (for example, at the 10th hour since the initial sensor placement).

[0099] In the case when the user waits until the 11th hour to perform the initial baseline calibration, the second scheduled calibration at the 12th hour, for example, may be performed at the 13th hour (so that the two hour spacing between the two calibrations are maintained, and the second calibration timing is based on the timing of the first successful baseline calibration performed. In an alternate embodiment, each scheduled calibration time period may be based on the timing of the initial sensor positioning. That is, rather than determining the appropriate subsequent calibration time periods based on the prior calibration performed, the timing of the scheduled calibration time periods may be made to be absolute and based from the time of the initial sensor placement.

[0100] Furthermore, in one aspect, when the scheduled calibration is not performed at the scheduled time periods, the glucose values may nevertheless be deter-

mined based on the sensor data for display to the user for a limited time period (for example, for no more than two hours from when the scheduled calibration time period is reached). In this manner, a calibration time window may be established or provided to the user with flexibility in performing the scheduled calibration and during which the glucose values are determined for output display to the user, for example. In one aspect, if within the calibration time window for the scheduled calibrations are not performed, the glucose values may be deemed in error, and thus not provided to the user or determined until the calibration is performed.

[0101] For example, after the initial successful baseline calibration at the 10th hour (for example, or at any other suitable scheduled initial baseline calibration time), glucose values are displayed or output to the user and stored in a memory. Thereafter, at the next scheduled calibration time period (For example, at the 12th hour), the user may be prompted to perform the second calibration. If the user does not perform the second calibration, a grace period of two hours, for example, is provided during which valid glucose values and alarms are provided to the user (for example, on the display unit of the receiver/monitor unit 104/106) based on the prior calibration parameters (for example, the initial baseline calibration performed at the 10th hour). However, if the second calibration is still not performed after the grace period, in one aspect, no additional glucose values are provided to user until the scheduled calibration is performed. Additionally, in one aspect, the user is notified that glucose values and alarms are no longer provided.

[0102] In still another aspect, the user may supplement the scheduled calibrations, and perform manual calibration based on the information that the user has received. For example, in the case that the user determines that the calibration performed and determined to be successful by the receiver/monitor unit 104/106, for example, is not sufficiently accurate, rather than replacing the sensor, the user may recalibrate the sensor even if the scheduled calibration time has not reached. For example, based on a blood glucose test result, if the determined blood glucose level is not close to or within an acceptable range as compared to the sensor data, the user may determine that additional calibration may be needed.

[0103] In the case where the scheduled calibration is not performed, in one embodiment, the glucose value determination for user display or output (on the receiver/monitor unit 104/106, for example) based on the received sensor data may be disabled after a predetermined time period has lapsed. In another embodiment, the two or more following baseline calibration request times are each based on predefined elapsed time periods since insertion confirmation. For instance, in one embodiment, when the initial baseline request is made at 1 hour since sensor insertion, the subsequent baseline calibration requests may be made at 1.5, 10, 24, 72 and 120 hours, respectively since the last successful baseline calibration. Alternatively, the second baseline calibration re-

quest time may be relative to the first successful baseline calibration, with the subsequent calibration time periods determined relative to the sensor insertion confirmation.

[0104] Furthermore, if the actual performed calibration is delayed beyond a predefined calibration prompt time, it is possible that the next scheduled baseline calibration request could occur prior to the previous baseline calibration actually occurring. In this case, the earlier baseline calibration request may be ignored. Within the scope of the present invention, other combinations of the timing approaches, relative to successful baseline calibration or relative to sensor insertion, are contemplated.

[0105] When a calibration routine fails, the receiver/monitor unit 104/106 in one embodiment displays a notification or a message indicating to the user that the calibration has failed. The displayed message would indicate that the user should repeat the reference glucose measurement immediately or after a predetermined time period has elapsed or after mitigating some circumstance that is preventing calibration, such as skin temperature being out of range, for example. The indication or message presented to the user may depend on the reason for the calibration routine failure and/or other conditions. For instance, if the calibration failed because there was an error in the reference glucose reading, then the indication presented to the user would be to repeat the calibration immediately. If the calibration failed because the reference glucose reading was out of range, the indication would be to repeat the calibration in an hour, allowing time for the glucose level to fall back into the predetermined range. If the calibration failed because the sensitivity was out of range, the indication would be to repeat the calibration in a half an hour (or some other suitable time period) to allow sufficient time for the sensitivity to recover.

[0106] In still another embodiment, after a calibration failure, when the indication is to attempt calibration at a later time, the receiver/monitor 104/106 may be configured to provide an alarm at this later time to remind the user to perform the calibration.

[0107] For the initial calibration, a timer may be set so that a minimum time elapses before calibration is attempted. In one embodiment, the time from sensor insertion confirmation to the first calibration request is approximately 10 hours, for example, to avoid or minimize sensor sensitivity attenuation during this time period.

[0108] Referring back, optimal sensitivity accuracy accounts for error sources represented in each blood glucose value calibration and the potential sensitivity drift. Accordingly, using a weighted average of the two most recent blood glucose values used for calibration, the sensitivity accuracy may be optimized. For example, in one embodiment, a weighted average of the two most recent blood glucose values used for calibration may be used to determine a composite sensitivity determination to improve accuracy and reduce calibration errors. In this aspect, earlier blood glucose values used for calibration are discarded to accommodate for sensitivity drift. In one em-

bodiment, the number of blood glucose values used for determining the weighted average, and also, the weighting itself may be varied using one or more approaches including, for example, a time based technique.

[0109] For example, for each sensor calibration routine, the sensitivity derived from the blood glucose value from the current blood glucose test and the stored sensitivity value associated with the most recent prior stored blood glucose value may be used to determine a weighted average value that is optimized for accuracy. Within the scope of the present invention, as discussed above, the weighting routine may be time based such that if the earlier stored blood glucose value used for prior calibration is greater than a predetermined number of hours, then the weighting value assigned to the earlier stored blood glucose may be less heavy, and a more significant weighting value may be given to the current blood glucose value to determine the composite sensitivity value.

[0110] In one embodiment, a lookup table may be provided for determining the composite sensitivity determination based on a variable weighting average which provides a non-linear correction to reduce errors and improve accuracy of the sensor sensitivity.

[0111] Periodically, when a calibration is performed, the result is substantially wrong and can be deemed an outlier. When a previous sensitivity estimate (referred to hereafter as the "original sensitivity estimate" is available to the receiver/monitor unit 104/106 (FIG. 1) from one or more previous calibration or from some other source such as a sensor code entered by the user, the sensitivity from the present calibration can be compared to determine if it is a likely outlier. During the outlier check routine performed by the receiver/monitor unit 104/106, for example, it is determined whether the sensitivity difference between two successive calibrations are within a predetermined acceptable range. If it is determined that the difference is within the predetermined range, then the present sensitivity is accepted (that is, not deemed an outlier) and a new composite sensitivity value is determined based on a weighted average of the two sensitivity values. As discussed above, the weighted average may include a time based function or any other suitable discrete weighting parameters.

[0112] If on the other hand, the difference between the two sensitivities is determined to be outside of the predetermined acceptable range, then the second (more recent) sensitivity value is considered to be a potential outlier (for example, due to sensitivity attenuation or due to bad or erroneous blood glucose value), and the user is prompted to perform another fingerstick testing to enter a new blood glucose value (for example, using a blood glucose meter).

[0113] If the difference between the second current sensitivity associated with the new blood glucose value and the prior sensitivity (the one that is a potential outlier) is determined to be outside the predetermined acceptable range, then the second current sensitivity is compared to the original sensitivity estimate. If the difference

is within a predetermined acceptable range, then it is determined that the potential outlier sensitivity was indeed an outlier and the composite sensitivity is determined based the second current sensitivity value and the original sensitivity.

[0114] On the other hand, when the second current sensitivity value is determined to be within the predetermined acceptable range of the prior sensitivity value (the one that is a potential outlier), then it is determined that a sensitivity shift, rather than an outlier, has occurred prior to the time of the prior sensitivity. Accordingly, the composite sensitivity may be determined based, in this case, on the first and second current sensitivity values.

[0115] If, for example, the second current sensitivity value is determined to be outside the predetermined range of both of the two successive sensitivities described above, then the user in one embodiment is prompted to perform yet another blood glucose test to input another current blood glucose value, and the outlier check routine described above is repeated.

[0116] Referring to the Figures, during the period of use, as discussed above, the sensor unit 101 (FIG. 1) is periodically calibrated at predetermined time intervals. In one aspect, after the second baseline calibration (for example, at 12th hour of sensor unit 101 transcutaneously positioned in fluid contact with the user's analyte), sensor sensitivity stability verifications may be performed to determine whether, for example, additional stability calibrations may be necessary before the third baseline calibration is due. In one aspect, the sensitivity stability verification may be performed after the outlier checks as described above is performed and prior to the third scheduled baseline calibration at the 24th hour (or at another suitable scheduled time period).

[0117] That is, the sensor sensitivity may be attenuated (e.g., ESA) early in the life of the positioned sensor unit 101 (FIG. 1), and if not sufficiently dissipated by the time of the first baseline calibration, for example, at the 10th hour (or later), and even by the time of the second calibration at the 12th hour. As such, in one aspect, a relative difference between the two sensitivities associated with the two calibrations is determined. If the determined relative difference is within a predefined threshold or range (for example, approximately 26% variation), then it is determined that the sufficient stability point has been reached. On the other hand, if the relative difference determined is beyond the predefined threshold, then the user is prompted to perform an additional calibration at a timed interval (for example, at each subsequent 2 hour period), when the stability check may be repeated. This may be repeated for each two hour interval, for example, until acceptable stability point has been reached, or alternatively, until the time period for the third baseline calibration is reached, for example, at the 24th hour of sensor unit 101 (FIG. 1) use.

[0118] In this manner, in one aspect, the stability verification may be monitored as the sensitivity attenuation is dissipating over a given time period. While the descrip-

tion above is provided with particular time periods for baseline calibrations and additional calibration prompts for stability checks, or example, within the scope of the present invention, other time periods or calibration schedule including stability verifications may be used. In addition, other suitable predefined threshold or range of the relative sensitivity difference to determine acceptable attenuation dissipation other than approximately 26% may be used. Moreover, as discussed above, the predetermined calibration schedule for each sensor unit 101 (FIG. 1) may be modified from the example provided above, based on, for example, the system design and/or sensor unit 101 (FIG. 1) configuration.

[0119] Furthermore, in one aspect, reference glucose readings taken for other reasons (for instance, to evaluate whether the sensitivity has been attenuated) may be used for calibration, even when the baseline calibration timers are such that baseline calibration may not be required.

[0120] As the sensitivity value of a given sensor tends to stabilize over time, a manual user initiated calibration later in the sensor's life may provide improved accuracy in the determined glucose values, as compared to the values based on calibrations performed in accordance with the prescribed or predetermined calibration schedule. Accordingly, in one aspect, additional manual calibrations may be performed in addition to the calibrations based on the predetermined calibration schedule.

[0121] In a further aspect, user notification functions may be programmed in the receiver/monitor unit 104/106, or in the transmitter unit 102 (FIG. 1) to notify the user of initial conditions associated with the sensor unit 101 (FIG. 1) performance or integrity. That is, visual, auditory, and/or vibratory alarms or alerts may be configured to be triggered when conditions related to the performance of the sensor are detected. For example, during the initial one hour period (or some other suitable time period) from the sensor insertion, in the case where data quality flags/conditions (described above) are detected, or in the case where low or no signal from the sensor is detected from a given period of time, an associated alarm or notification may be initiated or triggered to notify the user to verify the sensor position, the sensor contacts with the transmitter unit 102 (FIG. 1), or alternatively, to replace the sensor with a new sensor. In this manner, rather than waiting a longer period until the acceptable sensor stability point has been reached, the user may be provided at an early stage during the sensor usage that the positioned sensor may be defective or has failed.

[0122] In addition, other detected conditions related to the performance of the sensor, calibration, or detected errors associated with the glucose value determination, may be provided to the user using one or more alarm or alert features. For example, when the scheduled calibration has not been timely performed, and the grace period as described above has expired, in one embodiment, the glucose value is not processed for display or output to

the user anymore. In this case, an alarm or alert notifying the user that the glucose value cannot be calculated is provided so that the user may timely take corrective actions such as performing the scheduled calibration. In addition, when other parameters that are monitored such as the temperature, sensor data, and other variables that are used to determine the glucose value, include error or otherwise is deemed to be corrupt, the user may be notified that the associated glucose value cannot be determined, so that the user may take corrective actions such as, for example, replacing the sensor, verifying the contacts between the sensor and the transmitter unit, and the like.

[0123] In this manner, in one embodiment, there is provided an alarm or notification function that detects or monitors one or more conditions associated with the glucose value determination, and notifies the user of the same when such condition is detected. Since the alarms or notifications associated with the glucose levels (such as, for example, alarms associated with potential hyperglycemic, hypoglycemic, or programmed trend or rate of change glucose level conditions) will be inactive if the underlying glucose values cannot be determined, by providing a timely notification or alarm to the user that the glucose value cannot be determined, the user can determine or be prompted/notified that these alarms associated with glucose levels are inactive.

[0124] In one aspect of the present invention, glucose trend information may be determined and provided to the user, for example, on the receiver/monitor unit 104/106. For example, trend information in one aspect is based on the prior monitored glucose levels. When calibration is performed, the scaling used to determine the glucose levels may change. If the scaling for the prior glucose data (for example, one minute prior) is not changed, then in one aspect, the trend determination may be more error prone. Accordingly, in one aspect, to determine accurate and improved trend determination, the glucose level determination is performed retrospectively for a 15 minute time interval based on the current glucose data when each successive glucose level is determined.

[0125] That is, in one aspect, with each minute determination of the real time glucose level, to determine the associated glucose trend information, the stored past 15 minute data associated with the determined glucose level is retrieved, including the current glucose level. In this manner, the buffered prior glucose levels may be updated with new calibration to improve accuracy of the glucose trend information.

[0126] In one aspect, the glucose trend information is determined based on the past 15 minutes (or some other predetermined time interval) of glucose data including, for example, the current calibration parameter such as current sensitivity. Thereafter, when the next glucose data is received (at the next minute or based on some other timed interval), a new sensitivity is determined based on the new data point associated with the new glucose data. Also, the trend information may be determined based on

the new glucose data and the past 14 minutes of glucose data (to total 15 minutes of glucose data). It is to be noted that while the trend information is determined based on 15 minutes of data as described above, within the scope of the present invention, other time intervals may be used to determine the trend information, including, for example, 30 minutes of glucose data, 10 minutes of glucose data, 20 minutes of glucose data, or any other appropriate time intervals to attain an accurate estimation of the glucose trend information.

[0127] In this manner, in one aspect of the present invention, the trend information for the historical glucose information may be updated based on each new glucose data received, retrospectively, based on the new or current glucose level information, and the prior 14 glucose data points (or other suitable number of past glucose level information). In another aspect, the trend information may be updated based on a select number of recent glucose level information such that, it is updated periodically based on a predetermined number of determined glucose level information for display or output to the user.

[0128] In still another aspect, in wireless communication systems such as the data monitoring and management system 100 (FIG. 10), the devices or components intended for wireless communication may periodically be out of communication range. For example, the receiver/monitor unit 104/106 may be placed out of the RF communication range of the transmitter unit 102 (FIG. 1). In such cases, the transmitted data packet from the transmitter unit 102 may not be received by the receiver/monitor unit 104/106, or due to the weak signaling between the devices, the received data may be invalid or corrupt. In one aspect, the transmitter unit 102 (FIG. 1) may be configured to transmit the most recent 3 minutes of data in each data packet to the receiver/monitor unit 104/106 in order to help minimize the impact of dropped packets. Other time periods of data may be contemplated. The receiver/monitor unit 104/106 may be configured to account for the missing data by identifying that data was not received at the time expected and processing the data as if it were received but invalid. When a data packet is eventually received, and previous data was missed, the receiver/monitor unit retrieves the previous data and updates the FIFO buffer for subsequent glucose calculations, trend calculations and/or filtering operations.

[0129] In cases where there are missing data points associated with the periodically monitored glucose levels, the trend information (and filtered glucose) may be nevertheless determined. The trend information is determined based on a predetermined time period of past or prior glucose data points (for example, the past 15 minutes of glucose data).

[0130] In one aspect, even if there is a certain number of glucose data points within the 15 minute time frame that may be either not received by the receiver/monitor unit 104/106, or alternatively be corrupt or otherwise invalid due to, for example, weakness in the communication link, the trend information may be determined. For

example, given the 15 minutes of glucose data, if up to 3 of the 15 data points are not received or otherwise corrupt, the receiver/monitor unit 104/106 may still determine the glucose trend information based on the other 12 glucose data points that are received and considered to be valid. As such, the features or aspects of the analyte monitoring system which are associated with the determined trend information may continue to function or operate as programmed.

[0131] That is, the projected alarms or alerts programmed into the receiver/monitor unit 104/106, or any other alarm conditions associated with the detection of impending hyperglycemia, impending hypoglycemia, hyperglycemic condition or hypoglycemic condition (or any other alarm or notification conditions) may continue to operate as programmed even when there are a predetermined number or less of glucose data points. However, if and when the number of missing glucose data points exceed the tolerance threshold so as to accurately estimate or determine, for example, the glucose trend information, or any other associated alarm conditions, the display or output of the associated glucose trend information or the alarm conditions may be disabled.

[0132] For example, in one aspect, the glucose trend information and the rate of change of the glucose level (which is used to determine the trend information) may be based on 15 minute data (or data based on any other suitable time period) of the monitored glucose levels, where a predetermined number of missing data points within the 15 minutes may be tolerated. Moreover, using least squares approach, the rate of change of the monitored glucose level may be determined to estimate the trend, where the monitored valid glucose data are not evenly spaced in time. In this approach, the least squares approach may provide an uncertainty measure of the rate of change of the monitored glucose level. The uncertainty measure, in turn, may be partially dependent upon the number of valid data points available.

[0133] Indeed, using the approaches described above, the trend information or the rate of change of the glucose level may be estimated or determined without the need to determine which data point or glucose level is tolerable, and which data point is not tolerable. For example, in one embodiment, the glucose data for each minute including the missing date is retrieved for a predetermined time period (for example, 15 minute time period). Thereafter, least squares technique is applied to the 15 minute data points. Based on the least squares (or any other appropriate) technique, the uncertainty or a probability of potential variance or error of the rate of glucose level change is determined. For example, the rate of change may be determined to be approximately 1.5 mg/dL/minute \pm 0.1 mg/dL/minute. In such a case, the 0.1 mg/dL/minute may represent the uncertainty information discussed above, and may be higher or lower depending upon the number of data points in the 15 minutes of data that are missing or corrupt.

[0134] In this manner, in one aspect, the glucose trend

information and/or the rate of change of monitored glucose level may be determined based on a predefined number of past monitored glucose level data points, even when a subset of the predefined number of past monitored glucose level data points are missing or otherwise determined to be corrupt. On the other hand, when the number of past glucose level data points based on which the glucose trend information is determined, exceeds the tolerance or acceptance level, for example, the display or output of the glucose trend information may be disabled. Additionally, in a further aspect, if it is determined that the underlying data points associated with the monitored glucose level based on which the trend information is determined, includes uncertainly or error factor that exceeds the tolerance level (for example, when there are more than a predetermined number of data points which deviate from a predefined level), the receiver/monitor unit 104/106, for example, may be configured to disable or disallow the display or output of the glucose trend information.

[0135] For example, when the 15 minute glucose data including the current glucose level as well as the past 14 minutes of glucose level data is to be displayed or output to the user, and the determined variance of the 15 data points exceeds a preset threshold level (for example, 3.0), the glucose trend information display function may be disabled. In one aspect, the variance may be determined based on the square function of the standard deviation of the 15 data points. In one aspect, this approach may be performed substantially on a real time basis for each minute glucose data. Accordingly, as discussed above, the glucose trend information may be output or displayed substantially in real time, and based on each new glucose data point received from the sensor/transmitter unit.

[0136] Additionally, when it is determined that the 15 data points (or any other suitable number of data points for determining glucose trend information, for example), deviate beyond a predetermined tolerance range, in one aspect, the 15 minute data may be deemed error prone or inaccurate. In this case, rather than outputting or displaying glucose trend information that may be erroneous, the receiver/monitor unit 104/106 may be configured to display the output or display function related to the output or display of the determined glucose trend information. The same may apply to the output or display of projected alarms whose estimates may be based in part, on the determined trend information. Accordingly, in one aspect, there may be instances when the projected alarm feature may be temporarily disabled where the underlying monitored glucose data points are considered to include more than acceptable level of uncertainly or error.

[0137] In a further aspect, it is desired to determine an estimate of sensor sensitivity, and/or a range of acceptable or reasonable sensitivity. For example, during determination or verification of the glucose rate of change prior to calibration, the estimated sensor sensitivity information is necessary, for example, to determine whether

the rate of change is within or below an acceptable threshold level, and/or further, within a desired range. Moreover, when determining whether the sensor sensitivity is within an acceptable or reasonable level, it may be necessary to ascertain a range of reasonable or acceptable sensitivity - for example, a verification range for the sensitivity value for a given sensor or batch of sensors.

[0138] Accordingly, in one aspect, during sensor manufacturing process, a predetermined number of sensor samples (for example, 16 samples) may be evaluated from each manufacturing lot of sensors (which may include, for example, approximately 500 sensors) and the nominal sensitivity for each lot (based, for example, on a mean calculation) may be determined. For example, during the manufacturing process, the predetermined number of sensors (for example, 16 sensors) is sampled, and the sensitivity of each sampled sensor is measured in vitro. Thereafter, a mean sensitivity may be determined as an average value of the 16 sampled sensor's measured sensitivity, and thereafter, the corresponding sensor code is determined where the determined mean sensitivity falls within the preassigned sensitivity range. Based on the determined sensor code, the sensor packaging is labeled with the sensor code.

[0139] For example, each sensor code value (e.g., 105, 106, 107 or any suitable predetermined number or code) may be preassigned a sensitivity range (For example, code 105: S1-S2, code 106: S2-S2, and code 107: S3-S4), where each sensitivity range (e.g., S1-S2, or S2-S3, or S3-S4) is approximately over a 10 percent increment (for example, S1 is approximately 90% of S2). Also, each sensor code (e.g., 105, 106, 107 etc) is assigned a nominal sensitivity value (Sn) that is within the respective preassigned sensitivity range.

[0140] Referring back, when the user inserts the sensor or positions the sensor transcutaneously in place, the receiver/monitor unit 104/106 in one embodiment prompts the user to enter the associated sensor code. When the user enters the sensor code (as derived from the sensor packing label discussed above), the receiver/monitor unit 104/106 is configured to retrieve or look up the nominal sensitivity associated with the user input sensor code (and the nominal sensitivity which falls within the preassigned sensitivity range associated with that sensor code, as described above). Thereafter, the receiver/monitor unit 104/106 may be configured to use the sensor code in performing associates routines such as glucose rate of change verification, data quality checks discussed above, and/or sensor sensitivity range acceptability or confirmation.

[0141] In a further aspect, the sensor codes may be associated with a coefficient of variation of the predetermined number of sampled sensors discussed above in addition to using the mean value determined as discussed above. In one embodiment, the coefficient of variation may be determined from the predetermined number of sampled sensors during the manufacturing

process. In addition, the mean response time of the sampled sensors may be used by separately measuring the predetermined number of sampled sensors which may be used for lag correction adjustments and the like.

[0142] In this manner, in one aspect, the manufacturing process control described above ensures that the coefficient of variation of the sampled sensors is within a threshold value. That is, the value of the nominal sensitivity is used to determine a sensor code, selected or looked up from a predetermined table, and that is assigned to the sensors from the respective sensor lot in manufacturing. The user then enters the sensor code into the receiver/monitor unit that uses the sensor code to determine the glucose rate of change for purposes of data quality checking, for example, and also to determine validity or reasonableness of the sensitivity that is determined.

[0143] FIG. 11 is a flowchart illustrating a data quality verification routine in accordance with one embodiment of the present invention. Referring to FIG. 11, initially the data quality status flags are cleared or initialized or reset (1110). Thereafter data quality checks or verifications are performed, for example, as described above (1120). Thereafter, a data quality flag is generated and associated with the data packet when data quality check has failed (1130). Thereafter, the data packet including the raw glucose data as well as the data quality flags are transmitted, for example, to the receiver/monitor unit 104/106 for further processing.

[0144] As described above, the data quality checks may be performed in the transmitter unit 102 (FIG. 1) and/or in the receiver/monitor unit 104/106 in the data monitoring and management system 100 (FIG. 1) in one aspect of the present invention.

[0145] FIG. 12 is a flowchart illustrating a rate variance filtering routine in accordance with one embodiment of the present invention. Referring to FIG. 12, when glucose related data is detected or received (1210), for example, for each predetermined time intervals such as every minute, every five minutes or any other suitable time interval, a plurality of filtered values based on the received or detected unfiltered glucose values is determined (1220). For example, as discussed above, in one aspect, using, for example, an FIR filter, or based on a weighted average, a plurality of filtered values for a 15 minute and two minute glucose related data including the currently received or detected glucose related are determined. Thereafter, a rate of change of the glucose level based in part on the detected or received glucose related data is determined as well a standard deviation based on the unfiltered glucose values (1230).

[0146] Referring again to FIG. 12, a weighted average associated with the current detected or monitored glucose related data is determined based on the plurality of filtered values and the determined standard deviation as well as the rate of change of the glucose level (1240). For example, when the rate of change is determined to be greater than a predetermined threshold level, the fil-

tered value based on the two minute data is weighted more heavily. On the other hand, when the rate of change is determined to be less than the predetermined threshold level, the filtered glucose related data includes the one of the plurality of filtered values based on the 15 minute data which is weighted more heavily. In this manner, in one aspect, there is provided a rate variance filtering approach which may be configured to dynamically modify the weighting function or data filtering to, for example, reduce undesirable variation in glucose related signals due to factors such as noise.

[0147] FIG. 13 is a flowchart illustrating a composite sensor sensitivity determination routine in accordance with one embodiment of the present invention. Referring to FIG. 13, during scheduled calibration time periods or otherwise manual calibration routines to calibrate the analyte sensor, when current blood glucose value is received or detected (1310), a prior blood glucose value previously stored or otherwise received is retrieved, for example, from a storage unit such as a memory (1320). Thereafter, the calibration event time associated with the retrieved prior blood glucose value is determined or retrieved from the storage unit (1330), a first weighted parameter is applied to the current received blood glucose value, and a second weighted parameter is applied to the retrieved prior blood glucose value (1340). For example, based on the time lapsed between the calibration event associated with the retrieved blood glucose value and the current calibration event (associated with the current or received blood glucose value), the first and second weighted parameters may be modified (e.g., increased or decreased in value) to improve accuracy.

[0148] Referring back to FIG. 13, based on applying the first and the second weighted parameters to the current blood glucose value and the retrieved prior blood glucose value, a composite sensitivity associated with the analyte sensor for the current calibration event is determined (1350). For example, using a time based approach, in one embodiment, the sensitivity associated with the analyte sensor for calibration may be determined to, for example, reduce calibration errors or accommodate sensitivity drift. Alternatively, the first and the second weighted parameters may be fixed at predetermined values.

[0149] FIG. 14 is a flowchart illustrating an outlier data point verification routine in accordance with one embodiment of the present invention. Referring to FIG. 14, and as discussed in detail above, in determining composite sensitivity associated with the analyte sensor calibration, in one aspect, an outlier data point may be detected and accordingly corrected. For example, in one aspect, two successive sensitivities associated with two successive calibration events for the analyte sensor is compared (1410). If it is determined that the comparison between the two sensitivities are within a predetermined range (1420), the composite sensitivity for the current calibration of the analyte sensor is determined based on the two successive sensitivity values (1430), using, for example,

the weighted approach described above.

[0150] Referring back to FIG. 14, if it is determined that the comparison of the two successive sensitivities results in the compared value being outside of the predetermined range, then the user may be prompted to enter or provide a new current blood glucose value (for example, using a blood glucose meter) (1440). Based on the new blood glucose value received, an updated or new sensitivity associated with the analyte sensor is determined (1450). Thereafter, the new or updated sensitivity determined is compared with the two prior sensitivities compared (at 1420) to determine whether the new or updated sensitivity is within a predefined range of either of the two prior sensitivities (1460). If it is determined that the new or updated sensitivity of the analyte sensor is within the predefined range of either of the two prior successive sensitivities, a composite sensitivity is determined based on the new or updated sensitivity and the one of the two prior successive sensitivities within the defined range of which the new or updated sensitivity is determined (1470). On the other hand, if it is determined that the new or updated sensitivity is not within the predefined range of either of the two prior sensitivities, then the routine repeats and prompts the user to enter a new blood glucose value (1440).

[0151] FIG. 15 is a flowchart illustrating a sensor stability verification routine in accordance with one embodiment of the present invention. Referring to FIG. 15, and as discussed above, between predetermined or scheduled baseline calibration events to calibrate the sensor, the analyte sensor sensitivity stability may be verified, to determine, for example, if additional stability calibrations may be needed prior to the subsequent scheduled baseline calibration event.

[0152] For example, referring to FIG. 15, in one embodiment, after the second baseline calibration event to calibrate the analyte sensor, the user may be prompted to provide a new blood glucose value. With the current blood glucose value received (1510), the current sensor sensitivity is determined (1520). Thereafter, the most recent stored sensor sensitivity value from prior calibration event is retrieved (for example, from a storage unit) (1530), and the determined current sensor sensitivity is compared with the retrieved stored sensor sensitivity value to determine whether the difference, if any, between the two sensitivity values are within a predefined range (1540).

[0153] Referring back to FIG. 15, if it is determined that the difference between the current and retrieved sensitivity values are within the predefined range, then the stability associated with the sensor sensitivity is confirmed (1550), and no additional calibration is required prior to the subsequent scheduled baseline calibration event. On the other hand, if it is determined that the difference between the current sensitivity and the retrieved prior sensitivity is not within the predefined range, then after a predetermined time period has lapsed (1560), the routine returns to the beginning and prompts the user to

enter a new blood glucose value to perform the stability verification routine.

[0154] In this manner, in one aspect, the stability checks may be performed after the outlier check is performed, and a new composite sensitivity determined as described above. Accordingly, in one aspect, analyte sensor sensitivity may be monitored as the sensitivity attenuation is dissipating to, among others, improve accuracy of the monitored glucose data and sensor stability.

[0155] FIG. 16 is a flowchart illustrating a calibration failure state detection and/or notification routine in accordance with one embodiment of the present invention. Referring to FIG. 16, when a failure state of a calibration routine to calibrate an analyte sensor such as a subcutaneously positioned analyte sensor 101 (FIG. 1) (1610), one or more calibration parameters associated with the calibration routine is retrieved (1620). For example, the retrieved one or more calibration related parameters may include one or more of a current sensitivity value, a predetermined number of preceding valid analyte sensor data, a valid analyte data verification, a rate of change of analyte sensor data, a predetermined number of valid analyte sensor data for sensitivity determination; a predetermined number of valid analyte sensor data for analyte sensor data rate of change determination, a temperature data associated with the analyte sensor data, a determined sensitivity data, a reference blood glucose data, or a validity indication of the reference blood glucose data.

[0156] In one aspect, the one or more calibration related parameters may be stored in a data storage unit of the receiver/monitor unit 104/106, or alternatively, may be stored in a memory device of the transmitter unit 102, for example. Additionally, the one or more calibration related parameters may be stored at a remote location such as a computer terminal or a data processing terminal 105 (FIG. 1) which may be coupled in signal communication in one or more of the transmitter unit 102 or the receiver/monitor unit 104/106.

[0157] Referring back to FIG. 16, after retrieving the one or more calibration parameters, one or more conditions corresponding to or associated with the respective one or more calibration parameters to correct the detected calibration routine failure state is determined (1630).

That is, in one embodiment, when a calibration routine is initiated (based on a predetermined baseline calibration schedule or a user initiated calibration routine to calibrate the analyte sensor 101 (FIG. 1)), the parameters that are needed to perform the calibration routine is retrieved and thereafter evaluated to determine the condition associated with the one or more parameters which is associated with the calibration failure state.

[0158] For example, in one embodiment, the one or more determined conditions associated with the one or more calibration parameters that is associated with the calibration failure state may include an invalid reference blood glucose value received, a rate of change of the glucose value which deviates from a predetermined

range that is established for performing the calibration routine. While these examples are described herein, in accordance with the various embodiments of the present invention, the one or more determined conditions that is associated with the one or more calibration parameters may include, for example, any invalid or not acceptable level of state of the respective calibration parameter to successfully perform the calibration routine to calibrate the analyte sensor.

[0159] Referring still again to FIG. 16, after determining the one or more conditions corresponding to the one or more retrieved calibration parameters to correct the detected calibration failure state, a notification may be generated to provide or alert the user to reenter or provide the information or data input associated with the determined one or more conditions (1640). Referring back to the example described above, if it is determined that the reference blood glucose value referenced is invalid, the notification generated and provided to the user may include a request to reenter or provide another reference blood glucose value, by, for example, prompting the user to perform another blood glucose test. If the determined condition associated with one or more calibration parameters is related to the rate of change of the analyte level that exceeds a predetermined range suitable for analyte sensor calibration, then the generated notification may include a prompt or output display to the user to wait a predetermined time period to allow the glucose level variation to settle within the acceptable range for performing the calibration routine.

[0160] In one aspect, the generated notification provided to the user may include one or more of an audible output such as an alarm, a visual output such as a static or moving icon or image on the receiver/monitor unit 104/106 (for example,), a vibratory output, or one or more combinations thereof.

[0161] In this manner, in one aspect, the user may be promptly notified of the failed calibration routine state, and further, provided with information associated with one or more corrective actions that the user may take to correct the failed calibration state to calibrate the analyte sensor.

[0162] FIG. 17 is a flowchart illustrating pre-calibration analysis routine in accordance with one embodiment of the present invention. Referring to FIG. 17, prior to performing calibration routine to calibrate an analyte sensor based, for example, on a baseline calibration schedule or on user initiated calibration routine, one or more parameters associated with the calibration routine for calibrating the analyte sensor is retrieved (1710), and the retrieved one or more parameters are analyzed to determine whether the one or more parameters are acceptable or valid to successfully perform the calibration of the analyte sensor (1720). That is, prior to the calibration routine execution, the underlying parameters are analyzed or assessed to determine whether they are valid or acceptable.

[0163] Referring to FIG. 17, after analyzing the re-

trieved one or more calibration related parameters to determine whether the calibration routine will be successful, a notification is generated to provide or alert the user based on the analysis of the retrieved one or more parameters associated with the calibration routine. In this manner, the user may be notified or alerted that the calibration routine will likely be unsuccessful. For example, if the user planned to perform a fingerstick test to determine and provide the blood glucose value to calibrate the analyte sensor, the analysis of the retrieved one or more calibration related parameters determining that the calibration routine will fail (for example, based on a rate of change of the analyte level that is not suitable for calibration), and the corresponding notification to the user will alert the user to not proceed with the painful fingerstick test.

[0164] In this manner, in one aspect, the user may be notified of the condition of the various parameters associated with the calibration routine, and in the case where the condition of the various calibration related parameters is not valid or suitable for performing the calibration routine, the user is notified to prevent additional steps that the user may take to complete the calibration routine which may be unnecessary. That is, in one embodiment, pre-calibration routines may be performed by one or more of the transmitter unit 102, the receiver/monitor unit 104/106, or the data processing terminal 105, for example, to determine whether the calibration routine will be successful, and when it is determined that the one or more conditions related to one or more of the calibration parameters is not suitable or valid, the user is notified.

[0165] In one aspect, the user may be notified by one or more of an audible alert, a visual output, a vibratory indication, or one or more combinations thereof. For example, an icon illustrating a blood drop which corresponds to a request or prompt to enter a blood glucose value may be displayed with a line across the icon to alert the user to not enter a blood glucose value. Alternatively, or in addition to the icon display, a text message or notification may be provided to the user with or without an audible alarm that indicates that the user should not enter a blood glucose value. In this manner, in one aspect, the user may be notified prior to the calibration routine execution, whether the calibration routine will be successful, and if not, the user will be prevented or at least notified to not take further steps or perform additional processes such as the fingerstick test, for the calibration routine.

[0166] FIG. 18 is a flowchart illustrating asynchronous serial data output transmission routine in accordance with one embodiment of the present invention. Referring to FIG. 18, in one embodiment, when each analyte sensor measurement is detected or received (for example, each minute, 5 minutes, or 10 minutes, or at any other suitable intervals configured by the monitoring system) (1810), the analyte sensor measurement is processed to a corresponding glucose value (1820), and in accordance with the processing mode, the data set including for example, one or more of the glucose value, the corresponding sen-

sensor measurement, one or more calibration parameters, temperature information and the like may be manipulated (1830).

[0167] For example, in one aspect, when the processing mode is configured for asynchronous serial data output mode, the periodic sensor measurement value, the corresponding glucose level information and/or any other related data set may be manipulated or processed for real time data transmission via a serial data port, for example, in the receiver/monitor unit 104/106. In one aspect, the data set may be output substantially in real time relative to the sensor measurement over a data communication path such as a wireless or wired connection including for example, the RF communication link, a Bluetooth communication link, an Infrared communication connection, a USB cable connection, or any other suitable data communication link.

[0168] In another aspect, the processing mode may be configured to display the determined glucose level substantially in real time on the display unit of the receiver/monitor unit 104/106, and also concurrently transmit the determined glucose level substantially in real time (along with other data or information associated with the determined glucose level described herein), to the data processing terminal 105 or other external devices. Alternatively, the processing mode may be configured not display the real time glucose information, but rather, transmit the determined glucose level and one or more other information related to the glucose level to the external device.

[0169] In this manner aspect, the external device (for example, the data processing terminal/infusion section 105 (FIG. 1) or any other suitable device) may be configured to query and/or obtain data from the receiver/monitor unit 104/106, where external device may be configured to obtain the current or real time data sample from the receiver/monitor unit 104/106. More specifically, in one embodiment, when the receiver/monitor unit 104/106 receives the real time analyte related data from the transmitter unit 102 (FIG. 1) for example, the receiver/monitor unit 104/106 may be configured to automatically output or transmit, via a predetermined or configured data transmission port (or medium), the received analyte related data and/or associated data processing results.

[0170] In one embodiment, the receiver/monitor unit 104/106 may be configured to perform this operation via a serial command. Upon receipt of the command, for example, the receiver/monitor unit 104/106 may be configured to automatically send out of its serial port, for example, one or more of the following data: measured analyte sensor data, sensor temperature data, data quality detection information, error detection information, other data associated with the measured analyte sensor data, filtered and/or unfiltered glucose level determinations, intermediate glucose determinations, glucose trend information, alarm determination, system status information, for example. Alternatively, the receiver/monitor unit

104/106 may be configured to automatically transmit the data set and not in response to a command such as the serial command described above.

[0171] Furthermore, while the serial port data communication is described above, within the scope of the present disclosure, other modes of data transmission and/or communication including wireless and wired/cabled data communication are contemplated. In this manner, in one aspect, the output data from the receiver/monitor 104/106 may be placed in a buffer of predefined length (for example 2 minutes for a one minute sample rate), and when queried, outputting the last entry into the buffer. In this manner, in one aspect, monitored analyte related data may be provided to a remote device (for example, the data processing terminal/infusion section 105 (FIG. 1), automatically, for example, for further analysis and processing. In addition, the receiver/monitor unit 104/106 may be configured to communicate with other devices or systems that operate on their own time base independently.

[0172] A method in one embodiment includes detecting a failure state of a calibration routine to calibrate an analyte sensor, retrieving one or more calibration parameters associated with the detected failure state of the calibration routine, determining one or more conditions corresponding to the retrieved one or more calibration parameters to correct the detected failure state of the calibration routine, generating a notification associated with the determined one or more conditions.

[0173] The method may include outputting the generated notification associated with the determined one or more conditions, where outputting the generated notification may include outputting one or more of an audible output, a text output, a graphical output, a status screen display output, or one or more combinations thereof.

[0174] In one aspect, the method may include displaying a calibration routine failure state notification.

[0175] The generated notification may include a corrective indication to correct the detected failure state of the calibration routine, where the corrective indication may include one or more of a calibration routine repeat notification, or a calibration routine repeat after a predetermined time period notification, and further, where the predetermined time period may include one of a 30 minute time period, one hour time period, or a two hour period.

[0176] The method may also include displaying the corrective indication.

[0177] Additionally, the method may include storing the notification associated with the determined one or more conditions.

[0178] The one or more calibration parameters may include one or more of a current sensitivity value, a predetermined number of preceding valid analyte sensor data, a valid analyte data verification, a rate of change of analyte sensor data, a predetermined number of valid analyte sensor data for sensitivity determination; a predetermined number of valid analyte sensor data for an-

alyte sensor data rate of change determination, a temperature data associated with the analyte sensor data, a determined sensitivity data, a reference blood glucose data, a validity indication of the reference blood glucose data.

[0179] The one or more conditions may include a correction factor associated with the one or more calibration parameters.

[0180] An apparatus in accordance with another embodiment includes a data storage unit, and a processing unit operatively coupled to the data storage unit configured to detect a failure state of a calibration routine to calibrate an analyte sensor, retrieve one or more calibration parameters associated with the detected failure state of the calibration routine, determine one or more conditions corresponding to the retrieved one or more calibration parameters to correct the detected failure state of the calibration routine, and generate a notification associated with the determined one or more conditions.

[0181] The apparatus may include output unit operatively coupled to the processing unit to output the generated notification associated with the determined one or more conditions, where the output unit may be configured to output one or more of an audible output, a text output, a graphical output, a status screen display output, or one or more combinations thereof.

[0182] The apparatus in another aspect may include an output unit operatively coupled to the processing unit to display a calibration routine failure state notification.

[0183] The generated notification may include a corrective indication to correct the detected failure state of the calibration routine, where the corrective indication may include one or more of a calibration routine repeat notification, or a calibration routine repeat after a predetermined time period notification, and further, where the predetermined time period may include one of a 30 minute time period, one hour time period, or a two hour period.

[0184] The apparatus may include an output unit operatively coupled to the processing unit to display the corrective indication.

[0185] The data processing unit in another aspect may be configured to store the notification associated with the determined one or more conditions.

[0186] The one or more parameters may include one or more of a current sensitivity value, a predetermined number of preceding valid analyte sensor data, a valid analyte data verification, a rate of change of analyte sensor data, a predetermined number of valid analyte sensor data for sensitivity determination; a predetermined number of valid analyte sensor data for analyte sensor data rate of change determination, a temperature data associated with the analyte sensor data, a determined sensitivity data, a reference blood glucose data, a validity indication of the reference blood glucose data.

[0187] Also, the one or more conditions may a correction factor associated with the one or more calibration parameters.

[0188] A method in accordance with another embodiment may include prior to calibrating an in vivo analyte sensor, retrieving one or more parameters to calibrate the analyte sensor data, analyzing the retrieved one or more parameters to determine whether the analyte sensor data calibration will fail, and generating a notification based on the analysis of the retrieved one or more parameters.

[0189] The method may include determining a calibration time period based on a predetermined calibration schedule, where the predetermined calibration schedule may include a plurality of calibration time periods after the positioning of the analyte sensor in fluid contact with an analyte.

[0190] The plurality of calibration time periods may include two or more of 10 minutes, 30 minutes, 45 minutes, one hour, two hours, five hours, 10 hours, 12 hours, 24 hours, 48 hours or 72 hours measured from the positioning of the analyte sensor.

[0191] In another aspect, the plurality of calibration time periods may be determined based on a valid calibration procedure to calibrate the positioned analyte sensor.

[0192] The retrieved one or more parameters to calibrate the analyte sensor may include one or more of a current sensitivity value, a predetermined number of preceding valid analyte sensor data, a valid analyte data verification, a rate of change of analyte sensor data, a predetermined number of valid analyte sensor data for sensitivity determination; a predetermined number of valid analyte sensor data for analyte sensor data rate of change determination, or a temperature data associated with the analyte sensor data.

[0193] Further, the predetermined number of preceding valid analyte sensor data may include two valid analyte sensor data from the five most recent analyte sensor data determined from the analyte sensor calibration event.

[0194] In one aspect, the notification may include a request for one of a current blood glucose measurement value input, or a delayed blood glucose measurement value input.

[0195] The request in one aspect may include includes one or more of a text information, a graphical information, an audible information, or a combined one or more of the text, graphical or audible information to alert a user to enter a current blood glucose value.

[0196] The method in another aspect may include storing the generated notification.

[0197] Moreover, the notification may include an output signal to indicate that the one or more retrieved parameters to calibrate the analyte sensor are invalid.

[0198] In still another aspect, the notification may include an output message to prevent entering a current blood glucose value information.

[0199] When the retrieved one or more parameters to calibrate the analyte sensor are determined to be out of range for valid calibration, the method may include gen-

erating one or more notifications associated with correcting the invalid determination.

[0200] Additionally, the one or more notifications associated with correcting the invalid determination may include one or more of a skin temperature adjustment notification, a notification to control the glucose level within a predetermined range, or a notification to delay calibration until the rate of change of the glucose value is within a predetermined threshold range, where each of the one or more notifications may include an icon, an audible and/or vibratory alarm, or a status screen display.

[0201] An apparatus in accordance with still another embodiment includes a data storage unit, and a processing unit operatively coupled to the data storage unit, and configured to retrieve one or more sensor calibration parameters to calibrate an analyte sensor data prior to calibrating an in vivo analyte sensor, analyze the retrieved one or more parameters to determine whether the analyte sensor data calibration will fail, and generate a notification based on the analysis of the retrieved one or more parameters.

[0202] The processing unit may be configured to determine a calibration time period based on a predetermined calibration schedule, where the predetermined calibration schedule may include a plurality of calibration time periods after the positioning of the analyte sensor in fluid contact with an analyte.

[0203] In still a further aspect, the plurality of calibration time periods may include two or more of 10 minutes, 30 minutes, 45 minutes, one hour, two hours, five hours, 10 hours, 12 hours, 24 hours, 48 hours or 72 hours measured from the positioning of the analyte sensor.

[0204] The plurality of calibration time periods may be determined based on a valid calibration procedure to calibrate the positioned analyte sensor.

[0205] The retrieved one or more parameters to calibrate the analyte sensor may include one or more of a current sensitivity value, a predetermined number of preceding valid analyte sensor data, a valid analyte data verification, a rate of change of analyte sensor data, a predetermined number of valid analyte sensor data for sensitivity determination; a predetermined number of valid analyte sensor data for analyte sensor data rate of change determination, or a temperature data associated with the analyte sensor data, where the predetermined number of preceding valid analyte sensor data may include two valid analyte sensor data from the five most recent analyte sensor data determined from the analyte sensor calibration event.

[0206] The apparatus may also include output unit operatively coupled to the processing unit, the output unit configured to output the notification to request for one of a current blood glucose measurement value input, or a delayed blood glucose measurement value input, where the request includes one or more of a text information, a graphical information, an audible information, or a combined one or more of the text, graphical or audible information.

[0207] The processing unit may be configured to store the generated notification in the storage unit.

[0208] The notification may include an output signal to indicate that the one or more retrieved parameters to calibrate the analyte sensor is invalid.

[0209] In another aspect, the notification may include an output message to prevent entering a current blood glucose value information.

[0210] When the retrieved one or more parameters to calibrate the analyte sensor are determined to be out of range for valid calibration, the processing unit may be further configured to generate one or more notifications associated with correcting the invalid determination.

[0211] Also, the one or more notifications associated with correcting the invalid determination may include one or more of a skin temperature adjustment notification, a notification to control the glucose level within a predetermined range, or a notification to delay calibration until the rate of change of the glucose value is within a predetermined threshold range.

[0212] Moreover, each of the one or more notifications may include an icon, an audible and/or vibratory alarm, or a status screen display.

[0213] A method in accordance with still another embodiment includes acquiring data associated with a monitored analyte level, determining a glucose level based at least in part on the acquired data associated with the monitored analyte level, manipulating a data set based on a processing mode following the glucose level determination, where the processing mode includes one of a data set transmission and output display, a data set storing and output display without transmission, or a data set transmission and data set storing without output display.

[0214] The data set may be automatically transmitted following the glucose level determination.

[0215] The data set may include one or more of the monitored analyte level, temperature information associated with the monitored analyte level, a data quality information associated with the monitored analyte level, or an error detection information associated with the monitored analyte level.

[0216] Also, the data set may include one or more of a filtered glucose data, an unfiltered glucose data, glucose trend information, or glucose alarm condition determination.

[0217] Additionally, transmitting the data set may include data transmission over one or more of a wired connection or a wireless connection, where the wired connection may include one or more of a serial port connection, or a USB connection, and further, where the wireless connection may include one or more of an RF communication link, a Bluetooth communication link, an infrared communication link, or a Wi-Fi communication link.

[0218] In one aspect, the data set may be transmitted within a predetermined time period from when the data associated with the monitored analyte level is acquired, where the predetermined time period may include one of less than 5 milliseconds, less than one second, or less

than 5 minutes.

[0219] An apparatus in accordance with still yet another aspect may include a data storage unit, and a processing unit coupled to the data storage unit, the processing unit configured to acquire data associated with a monitored analyte level, determine a glucose level based at least in part on the acquired data associated with the monitored analyte level, and manipulate a data set based on a processing mode following the glucose level determination, where the processing mode includes one of a data set transmission and output display, a data set storing and output display without transmission, or a data set transmission and data set storing without output display.

[0220] The processing unit may be configured to automatically transmit the data set following the glucose level determination.

[0221] The data set may include one or more of the monitored analyte level, temperature information associated with the monitored analyte level, a data quality information associated with the monitored analyte level, or an error detection information associated with the monitored analyte level.

[0222] The data set may include one or more of a filtered glucose data, an unfiltered glucose data, glucose trend information, or glucose alarm condition determination.

[0223] In another aspect, the processing unit may be configured to transmit the data set over one or more of a wired connection or a wireless connection, where the wired connection may include one or more of a serial port connection, or a USB connection, and further, the wireless connection may include one or more of an RF communication link, a Bluetooth communication link, an infrared communication link, or a Wi-Fi communication link.

[0224] The processing unit may be configured to transmit the data set within a predetermined time period from when the data associated with the monitored analyte level is acquired, where the predetermined time period may include one of less than 5 milliseconds, less than one second, or less than 5 minutes.

[0225] Various other modifications and alterations in the structure and method of operation of this invention will be apparent to those skilled in the art without departing from the scope and spirit of the invention. Although the invention has been described in connection with specific preferred embodiments, it should be understood that the invention as claimed should not be unduly limited to such specific embodiments. It is intended that the following claims define the scope of the present invention and that structures and methods within the scope of these claims and their equivalents be covered thereby.

Claims

1. A method, comprising:
prior to calibrating an in vivo analyte sensor

(101), retrieving one or more parameters to calibrate the analyte sensor data (1710); analyzing the retrieved one or more parameters to determine whether the analyte sensor data calibration will fail (1720); and generating a notification based on the analysis of the retrieved one or more of the parameters (1730); wherein if it is determined the analyte sensor data calibration will not fail, the method further comprises:

performing a calibration routine to calibrate the analyte sensor (101); detecting a failure state of the calibration routine (1610); retrieving one or more calibration parameters associated with the detected failure state of the calibration routine (1620), wherein the one or more calibration parameters includes a predetermined number of preceding valid analyte sensor data; determining one or more conditions corresponding to the retrieved one or more calibration parameters to correct the detected failure state of the calibration routine (1630); and generating a notification associated with the determined one or more conditions (1640).

- 2. The method of claim 1 including outputting the generated notification associated with the determined one or more conditions.
- 3. The method of claim 2 wherein outputting the generated notification includes outputting one or more of an audible output, a text output, a graphical output, a status screen display output, or one or more combinations thereof.
- 4. The method of claim 1 including displaying a calibration routine failure state notification.
- 5. The method of claim 1 wherein the generated notification associated with the determined one or more conditions includes a corrective indication to correct the detected failure state of the calibration routine.
- 6. The method of claim 5 wherein the corrective indication includes one or more of a calibration routine repeat notification, or a calibration routine repeat after a predetermined time period notification.
- 7. The method of claim 6, wherein the predetermined time period includes one of a 30 minute time period, one hour time period, or a two hour period.
- 8. The method of claim 6, including displaying the cor-

rective indication.

9. The method of claim 1 including storing the notification associated with the determined one or more conditions.
10. The method of claim 1 wherein the one or more calibration parameters further includes one or more of a current sensitivity value, a valid analyte data verification, a rate of change of analyte sensor data, a temperature data associated with the analyte sensor data, a determined sensitivity data, a reference blood glucose data, a validity indication of the reference blood glucose data.
11. The method of claim 1 wherein the one or more conditions includes a correction factor associated with the one or more calibration parameters.
12. An apparatus, comprising:

a data storage unit (307); and
a processing unit (204, 307) operatively coupled to the data storage unit, configured to:

prior to calibrating an analyte sensor (101), retrieve one or more parameters to calibrate the analyte sensor data (1710);
analyze the retrieved one or more parameters and determine whether the analyte sensor data calibration will fail (1720);
generate a notification based on the analysis of the retrieved one or more of the parameters (1730); and
perform a calibration routine to calibrate the analyte sensor (101) when it is determined the analyte sensor data calibration will not fail, **characterised in that** the processing unit (204, 307) is further configured to:

detect a failure state of the calibration routine (1610),
retrieve one or more calibration parameters associated with the detected failure state of the calibration routine (1620), wherein the one or more calibration parameters includes a predetermined number of preceding valid analyte sensor data,
determine one or more conditions corresponding to the retrieved one or more calibration parameters to correct the detected failure state of the calibration routine (1630), and
generate a notification associated with the determined one or more conditions (1640).

5

10

15

20

25

30

35

40

45

50

55

13. The apparatus of claim 12 including an output unit (310) operatively coupled to the processing unit (307) to output the generated notification associated with the determined one or more conditions.

14. The apparatus of claim 13 wherein the output unit (310) is configured to output one or more of an audible output, a text output, a graphical output, a status screen display output, or one or more combinations thereof.

15. The apparatus of claim 12 including an output unit (310) operatively coupled to the processing unit (307) to display a calibration routine failure state notification.

16. The apparatus of claim 12 wherein the generated notification includes a corrective indication to correct the detected failure state of the calibration routine.

17. The apparatus of claim 16 wherein the corrective indication includes one or more of a calibration routine repeat notification, or a calibration routine repeat after a predetermined time period notification.

18. The apparatus of claim 17 wherein the predetermined time period includes one of a 30 minute time period, one hour time period, or a two hour period.

19. The apparatus of claim 17 including an output unit (310) operatively coupled to the processing unit (307) to display the corrective indication.

20. The apparatus of claim 12 wherein the processing unit (204, 307) stores the notification associated with the determined one or more conditions.

21. The apparatus of claim 12 wherein the one or more calibration parameters includes one or more of a current sensitivity value, a valid analyte data verification, a rate of change of analyte sensor data, a temperature data associated with the analyte sensor data, a determined sensitivity data, a reference blood glucose data, a validity indication of the reference blood glucose data.

22. The apparatus of claim 12 wherein the one or more conditions includes a correction factor associated with the one or more calibration parameters.

Patentansprüche

1. Verfahren, das Folgendes beinhaltet:

Abrufen, vor dem Kalibrieren eines In-vivo-Analysensors (101), von einem oder mehreren Parametern zum Kalibrieren der Analysensordda-

- ten (1710);
Analysieren der abgerufenen ein oder mehreren Parameter, um zu bestimmen, ob die Kalibration der Analytsensordaten erfolglos sein wird (1720); und
Erzeugen einer Benachrichtigung auf der Basis der Analyse der abgerufenen ein oder mehreren der Parameter (1730);
wobei das Verfahren, wenn festgestellt wird, dass die Kalibration der Analytsensordaten nicht erfolglos verlaufen wird, ferner Folgendes beinhaltet:
- Durchführen einer Kalibrationsroutine zum Kalibrieren des Analytsensors (101);
Erkennen eines Erfolgloszustands der Kalibrationsroutine (1610);
Abrufen von einem oder mehreren mit dem erkannten Erfolgloszustand der Kalibrationsroutine (1620) assoziierten Kalibrationsparametern, wobei die ein oder mehreren Kalibrationsparameter eine vorbestimmte Anzahl von vorhergehenden gültigen Analytsensordaten beinhalten;
Feststellen von einer oder mehreren Bedingungen entsprechend den abgerufenen ein oder mehreren Kalibrationsparametern, um den erkannten Erfolgloszustand der Kalibrationsroutine (1630) zu korrigieren; und
Erzeugen einer mit den festgestellten ein oder mehreren Bedingungen (1640) assoziierten Benachrichtigung.
2. Verfahren nach Anspruch 1, das das Ausgeben der mit den festgestellten ein oder mehreren Bedingungen assoziierten erzeugten Benachrichtigung beinhaltet.
 3. Verfahren nach Anspruch 2, wobei das Ausgeben der erzeugten Benachrichtigung das Ausgeben von einem oder mehreren aus hörbarem Ausgang, Textausgang, Graphikausgang, Statusbildschirmanzeigenausgang oder einer oder mehreren Kombinationen davon beinhaltet.
 4. Verfahren nach Anspruch 1, das das Anzeigen einer Benachrichtigung über einen Erfolgloszustand einer Kalibrationsroutine beinhaltet.
 5. Verfahren nach Anspruch 1, wobei die mit den festgestellten ein oder mehreren Bedingungen assoziierte erzeugte Benachrichtigung eine Korrekturanzeige zum Korrigieren des erkannten Erfolgloszustands der Kalibrationsroutine beinhaltet.
 6. Verfahren nach Anspruch 5, wobei die Korrekturanzeige eines oder mehrere aus einer Kalibrationsroutinen-Wiederholbenachrichtigung oder einer Kalibrationsroutinenwiederholung nach einer vorbestimmten Zeitperiodenbenachrichtigung beinhaltet.
 7. Verfahren nach Anspruch 6, wobei die vorbestimmte Zeitperiode eine oder mehrere aus einer 30-Minuten-Zeitperiode, einer Ein-Stunden-Zeitperiode oder einer Zwei-Stunden-Periode beinhaltet.
 8. Verfahren nach Anspruch 6, das das Anzeigen der Korrekturanzeige beinhaltet.
 9. Verfahren nach Anspruch 1, das das Speichern der mit den festgestellten ein oder mehreren Bedingungen assoziierten Benachrichtigung beinhaltet.
 10. Verfahren nach Anspruch 1, wobei die ein oder mehreren Kalibrationsparameter ferner ein oder mehrere aus einem aktuellen Empfindlichkeitswert, einer gültigen Analytdatenverifizierung, einer Analytsensordaten-Änderungsrate, von mit den Analytsensordaten assoziierten Temperaturdaten, von ermittelten Empfindlichkeitsdaten, von Referenzblutglukosedaten, einer gültigen Anzeige der Referenzblutglukosedaten beinhaltet.
 11. Verfahren nach Anspruch 1, wobei die ein oder mehreren Bedingungen einen mit den ein oder mehreren Kalibrationsparametern assoziierten Korrekturfaktor beinhalten.
 12. Vorrichtung, die Folgendes umfasst:
 - eine Datenspeichereinheit (307); und
 - eine Verarbeitungseinheit (204, 307), die mit der Datenspeichereinheit wirkgekoppelt ist, konfiguriert zum:
 - Abrufen, vor dem Kalibrieren eines Analytsensors (101), von einem oder mehreren Parametern zum Kalibrieren der Analytsensordaten (1710);
 - Analysieren der abgerufenen ein oder mehreren Parameter und Feststellen, ob die Kalibration der Analytsensordaten erfolglos verlaufen wird (1720);
 - Erzeugen einer Benachrichtigung auf der Basis der Analyse der abgerufenen ein oder mehreren der Parameter (1730); und
 - Ausführen einer Kalibrationsroutine zum Kalibrieren des Analytsensors (101), wenn festgestellt wird, dass die Kalibration der Analytsensordaten nicht erfolglos verlaufen wird, **dadurch gekennzeichnet, dass** die Verarbeitungseinheit (204, 307) ferner konfiguriert ist zum:
 - Erkennen eines Erfolgloszustands der Kalibrationsroutine (1610),

- Abrufen von einem oder mehreren mit dem erkannten Erfolgloszustand der Kalibrationsroutine (1620) assoziierten Kalibrationsparameter, wenn die ein oder mehreren Kalibrationsparameter eine vorbestimmte Anzahl von vorhergehenden gültigen Analytsensordaten beinhalten,
Feststellen von einer oder mehreren Bedingungen entsprechend den abgerufenen ein oder mehreren Kalibrationsparametern zum Korrigieren des erkannten Erfolgloszustands der Kalibrationsroutine (1630), und
Erzeugen einer mit den ermittelten ein oder mehreren Bedingungen (1640) assoziierten Benachrichtigung.
- 5
- 10
- 15
- 20
- 25
- 30
- 35
- 40
- 45
- 50
- 55
13. Vorrichtung nach Anspruch 12, die eine Ausgabereinheit (310) aufweist, die mit der Verarbeitungseinheit (307) wirkgekoppelt ist, um die mit den ermittelten ein oder mehreren Bedingungen assoziierte erzeugte Benachrichtigung auszugeben.
 14. Vorrichtung nach Anspruch 13, wobei die Ausgabereinheit (310) zum Ausgeben von einem oder mehreren aus hörbarer Ausgabe, Textausgabe, Graphikausgabe, Statusbildschirmdisplay-Ausgabe oder einer oder mehreren Kombinationen davon konfiguriert ist.
 15. Vorrichtung nach Anspruch 12 mit einer Ausgabereinheit (310), die mit der Verarbeitungseinheit (307) wirkgekoppelt ist, um eine Benachrichtigung über den Erfolgloszustand der Kalibrationsroutine anzuzeigen.
 16. Vorrichtung nach Anspruch 12, wobei die erzeugte Benachrichtigung eine Korrekturanzeige zum Korrigieren des erkannten Erfolgloszustands der Kalibrationsroutine beinhaltet.
 17. Vorrichtung nach Anspruch 16, wobei die Korrekturanzeige ein oder mehrere aus einer Kalibrationsroutinen-Wiederholbenachrichtigung oder einer Kalibrationsroutinenwiederholung nach einer vorbestimmten Zeitperiodenbenachrichtigung beinhaltet.
 18. Vorrichtung nach Anspruch 17, wobei die vorbestimmte Zeitperiode eine aus einer 30-Minuten-Zeitperiode, einer Ein-Stunden-Zeitperiode oder einer Zwei-Stunden-Periode beinhaltet.
 19. Vorrichtung nach Anspruch 17 mit einer Ausgabereinheit (310), die mit der Verarbeitungseinheit (307) wirkgekoppelt ist, um die Korrekturanzeige anzuzeigen.

20. Vorrichtung nach Anspruch 12, wobei die Verarbeitungseinheit (204, 307) die mit den ein oder mehreren Bedingungen assoziierte Benachrichtigung speichert.
21. Vorrichtung nach Anspruch 12, wobei die ein oder mehreren Kalibrationsparameter ein oder mehrere aus einem aktuellen Empfindlichkeitswert, einer gültigen Analytdatenverifizierung, einer Analytsensordaten-Änderungsrate, von mit den Analytsensordaten assoziierten Temperaturdaten, von festgestellten Empfindlichkeitsdaten, von Referenzblutglukosedaten, einer Gültigkeitsanzeige der Referenzblutglukosedaten beinhalten.
22. Vorrichtung nach Anspruch 12, wobei die ein oder mehreren Bedingungen einen mit den ein oder mehreren Kalibrationsparametern assoziierten Korrekturfaktor beinhalten.

Revendications

1. Procédé, comprenant :

avant l'étalonnage d'un capteur d'analyte in vivo (101), le recouvrement d'un ou de plusieurs paramètres pour étalonner les données de capteur d'analyte (1710) ;
l'analyse des un ou plusieurs paramètres recouverts pour déterminer que l'étalonnage des données de capteur d'analyte va échouer ou non (1720) ; et
la génération d'une notification en fonction de l'analyse des un ou plusieurs paramètres recouverts (1730) ;
le procédé comprenant en outre s'il est déterminé que l'étalonnage des données de capteur d'analyte ne va pas échouer :

l'exécution d'un sous-programme d'étalonnage pour étalonner le capteur d'analyte (101) ;
la détection d'un état de défaillance du sous-programme d'étalonnage (1610) ;
le recouvrement d'un ou de plusieurs paramètres d'étalonnage associés à l'état de défaillance détecté du sous-programme d'étalonnage (1620), les un ou plusieurs paramètres d'étalonnage comportant un nombre prédéterminé de données de capteur d'analyte valables précédentes ;
la détermination d'une ou de plusieurs conditions correspondant aux un ou plusieurs paramètres d'étalonnage recouverts pour corriger l'état de défaillance détecté du sous-programme d'étalonnage (1630) ; et
la génération d'une notification associée

- aux une ou plusieurs conditions déterminées (1640).
2. Procédé selon la revendication 1 comportant la production en sortie de la notification générée associée aux une ou plusieurs conditions déterminées. 5
 3. Procédé selon la revendication 2 dans lequel la production en sortie de la notification générée comporte la production en sortie d'une ou de plusieurs d'une sortie audible, d'une sortie de texte, d'une sortie graphique, d'une sortie d'affichage d'écran d'état, ou d'une ou de plusieurs combinaisons de celles-ci. 10
 4. Procédé selon la revendication 1 comportant l'affichage d'une notification d'état de défaillance de sous-programme d'étalonnage. 15
 5. Procédé selon la revendication 1 dans lequel la notification générée associée aux une ou plusieurs conditions déterminées comporte une indication de correction pour corriger l'état de défaillance de sous-programme d'étalonnage détecté. 20
 6. Procédé selon la revendication 5 dans lequel l'indication de correction comporte une ou plusieurs d'une notification de répétition de sous-programme d'étalonnage, ou d'une notification de répétition de sous-programme d'étalonnage après une période de temps prédéterminée. 25
30
 7. Procédé selon la revendication 6, dans lequel la période de temps prédéterminée comporte l'une d'une période de 30 minutes, d'une période d'une heure ou d'une période de deux heures. 35
 8. Procédé selon la revendication 6, comportant l'affichage de l'indication de correction.
 9. Procédé selon la revendication 1 comportant la mémorisation de la notification associée aux une ou plusieurs conditions déterminées. 40
 10. Procédé selon la revendication 1 dans lequel les un ou plusieurs paramètres d'étalonnage comportent en outre un ou plusieurs d'une valeur de sensibilité actuelle, d'une vérification de données d'analyte valables, d'un taux de changement de données de capteur d'analyte, de données de température associées aux données de capteur d'analyte, de données de sensibilité déterminées, de données de glycémie de référence, d'une indication de validité des données de glycémie de référence. 45
50
 11. Procédé selon la revendication 1 dans lequel les une ou plusieurs conditions comportent un facteur de correction associé aux un ou plusieurs paramètres d'étalonnage. 55
12. Appareil, comprenant :
- une unité de mémorisation de données (307) ; et une unité de traitement (204, 307) couplée fonctionnellement à l'unité de mémorisation de données, configurée pour :
- avant l'étalonnage d'un capteur d'analyte (101), recouvrer un ou plusieurs paramètres pour étalonner les données de capteur d'analyte (1710) ; analyser les un ou plusieurs paramètres recouverts et déterminer que l'étalonnage des données de capteur d'analyte va échouer ou non (1720) ; générer une notification en fonction de l'analyse des un ou plusieurs paramètres recouverts (1730) ; et exécuter un sous-programme d'étalonnage pour étalonner le capteur d'analyte (101) quand il est déterminé que l'étalonnage des données de capteur d'analyte ne va pas échouer, **caractérisé en ce que** l'unité de traitement (204, 307) est configurée en outre pour :
- détecter un état de défaillance du sous-programme d'étalonnage (1610), recouvrer un ou plusieurs paramètres d'étalonnage associés à l'état de défaillance détecté du sous-programme d'étalonnage (1620), les un ou plusieurs paramètres d'étalonnage comportant un nombre prédéterminé de données de capteur d'analyte valables précédentes ; déterminer une ou plusieurs conditions correspondant aux un ou plusieurs paramètres d'étalonnage pour corriger l'état de défaillance détecté du sous-programme d'étalonnage (1630) ; et générer une notification associée aux une ou plusieurs conditions déterminées (1640).
13. Appareil selon la revendication 12 comportant une unité de sortie (310) couplée fonctionnellement à l'unité de traitement (307) pour produire en sortie la notification générée associée aux une ou plusieurs conditions déterminées.
14. Appareil selon la revendication 13 dans lequel l'unité de sortie (310) est configurée pour produire en sortie une ou plusieurs d'une sortie audible, d'une sortie de texte, d'une sortie graphique, d'une sortie d'affichage d'écran d'état, ou d'une ou de plusieurs combinaisons de celles-ci.

15. Appareil selon la revendication 12 comportant une unité de sortie (310) couplée fonctionnellement à l'unité de traitement (307) pour afficher une notification d'état de défaillance de sous-programme d'étalonnage. 5
16. Appareil selon la revendication 12, dans lequel la notification générée comporte une indication de correction pour corriger l'état de défaillance de sous-programme d'étalonnage détecté. 10
17. Appareil selon la revendication 16 dans lequel l'indication de correction comporte une ou plusieurs d'une notification de répétition de sous-programme d'étalonnage, ou d'une notification de répétition de sous-programme d'étalonnage après une période de temps prédéterminée. 15
18. Appareil selon la revendication 17, dans lequel la période de temps prédéterminée comporte l'une d'une période de 30 minutes, d'une période d'une heure ou d'une période de deux heures. 20
19. Appareil selon la revendication 17, comportant une unité de sortie (310) couplée fonctionnellement à l'unité de traitement (307) pour afficher l'indication de correction. 25
20. Appareil selon la revendication 12 dans lequel l'unité de traitement (204, 307) mémorise la notification associée aux une ou plusieurs conditions déterminées. 30
21. Appareil selon la revendication 12 dans lequel les un ou plusieurs paramètres d'étalonnage comportent un ou plusieurs d'une valeur de sensibilité actuelle, d'une vérification de données d'analyte valables, d'un taux de changement de données de capteur d'analyte, de données de température associées aux données de capteur d'analyte, de données de sensibilité déterminées, de données de glycémie de référence, d'une indication de validité des données de glycémie de référence. 35
40
22. Appareil selon la revendication 12 dans lequel les une ou plusieurs conditions comportent un facteur de correction associé aux un ou plusieurs paramètres d'étalonnage. 45

50

55

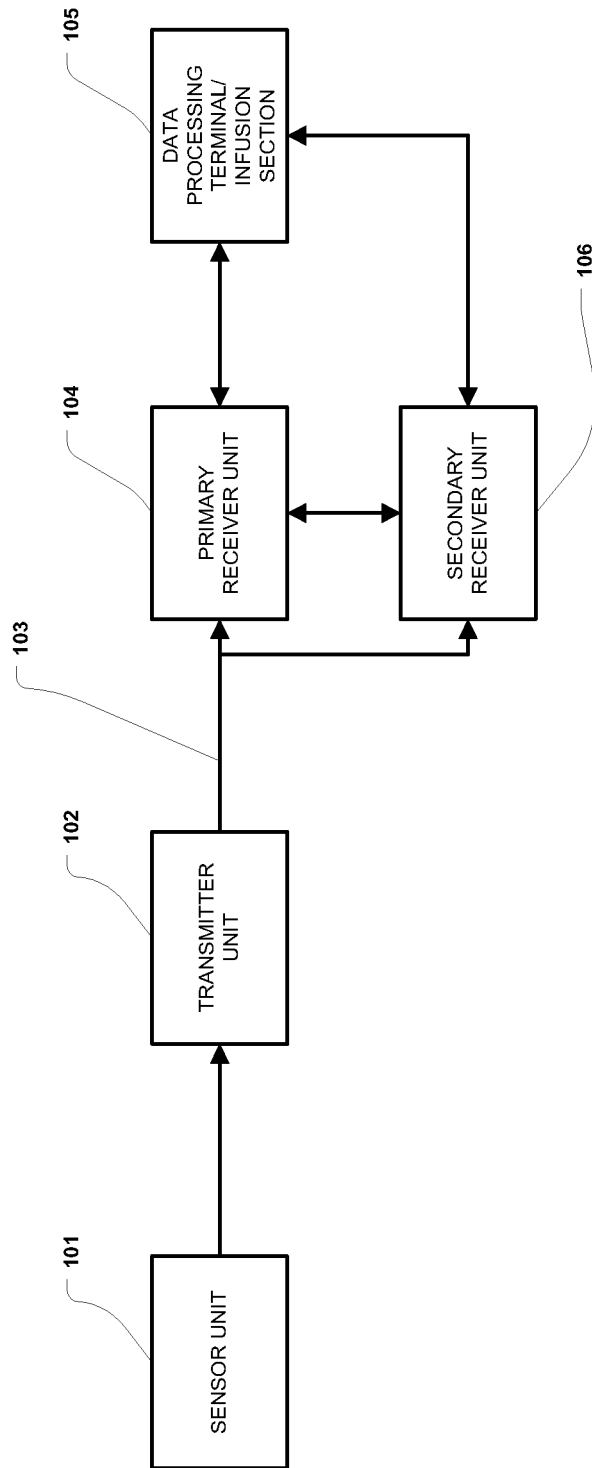

100

FIGURE 1

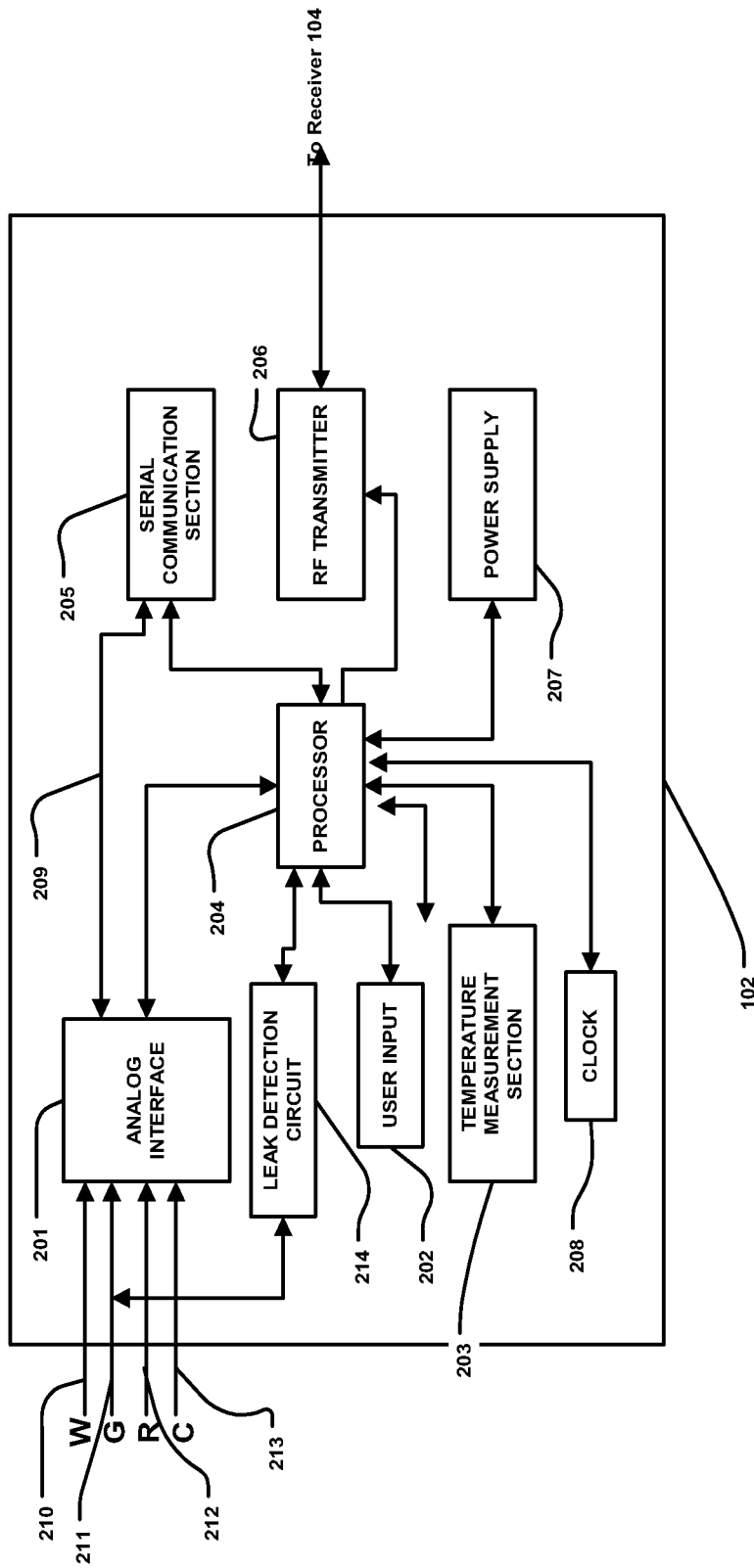

FIGURE 2

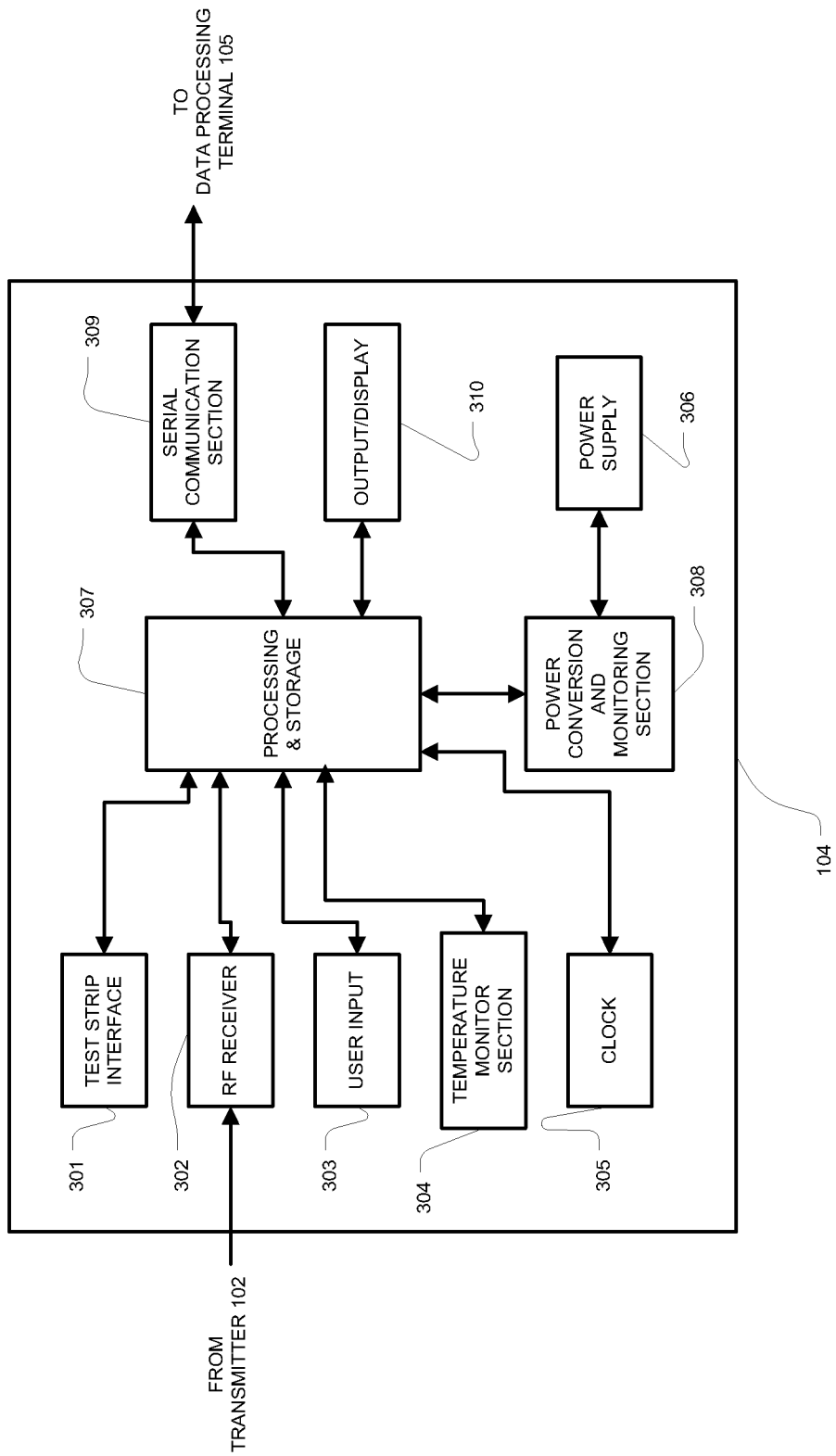
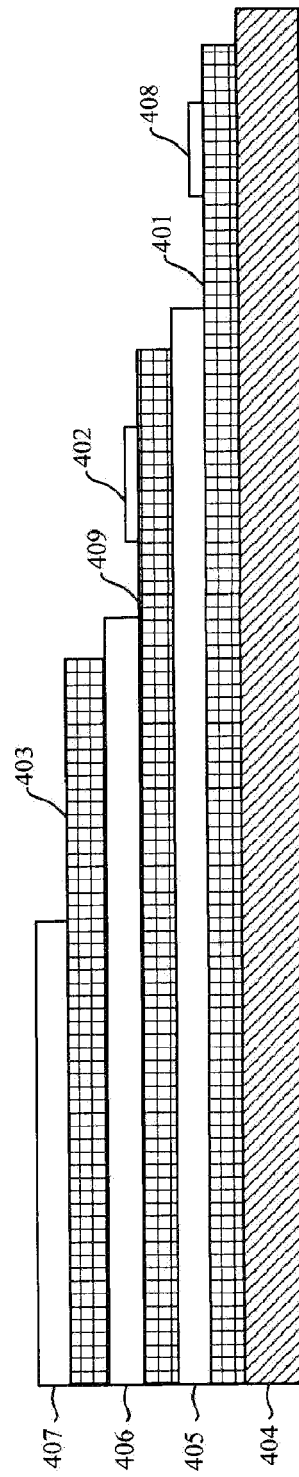
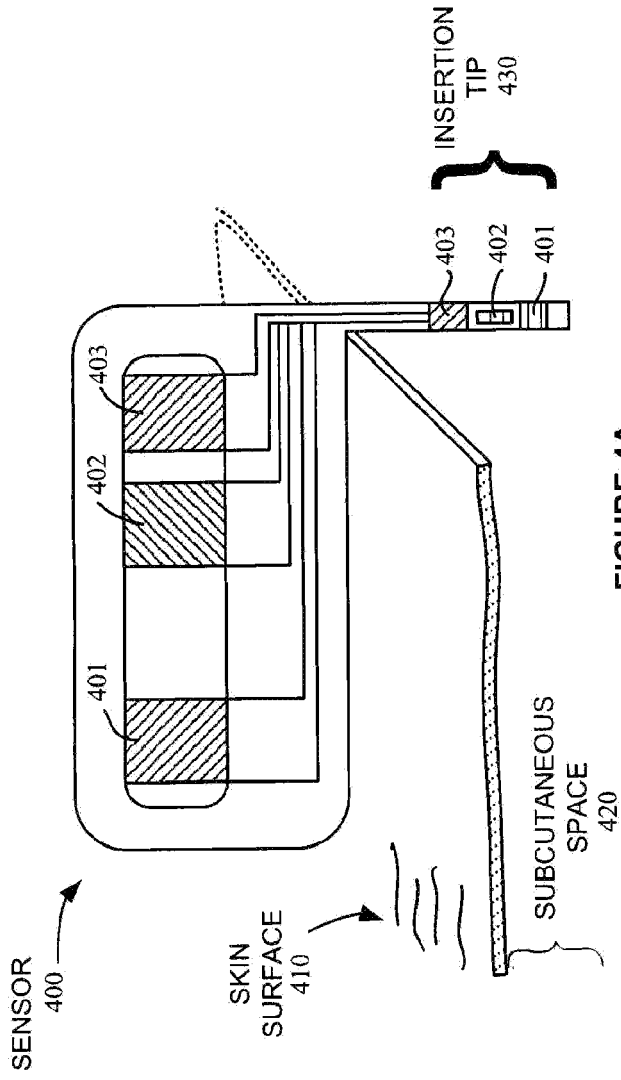

FIGURE 3



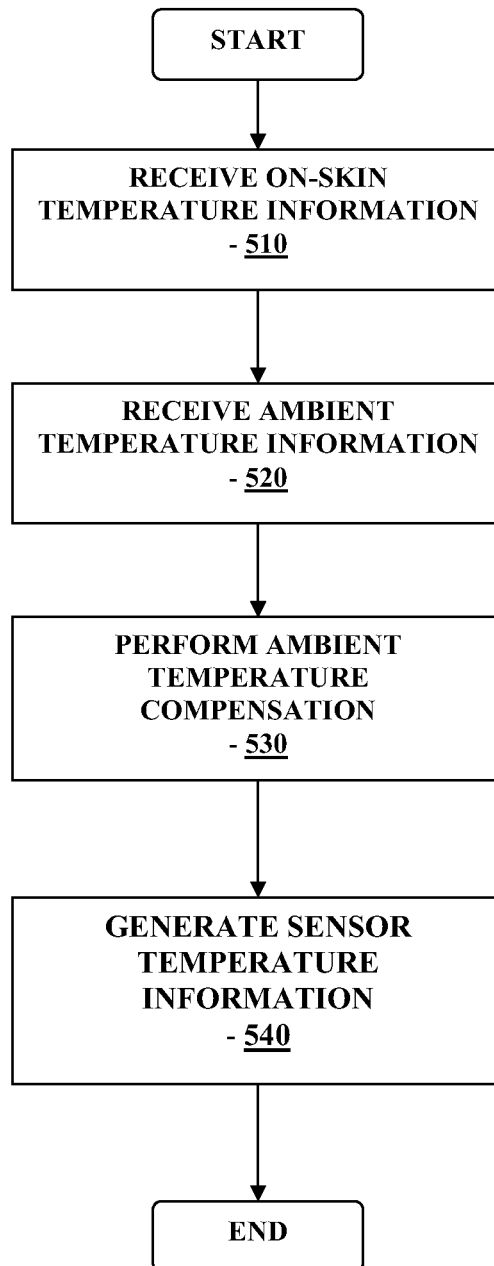

FIGURE 5

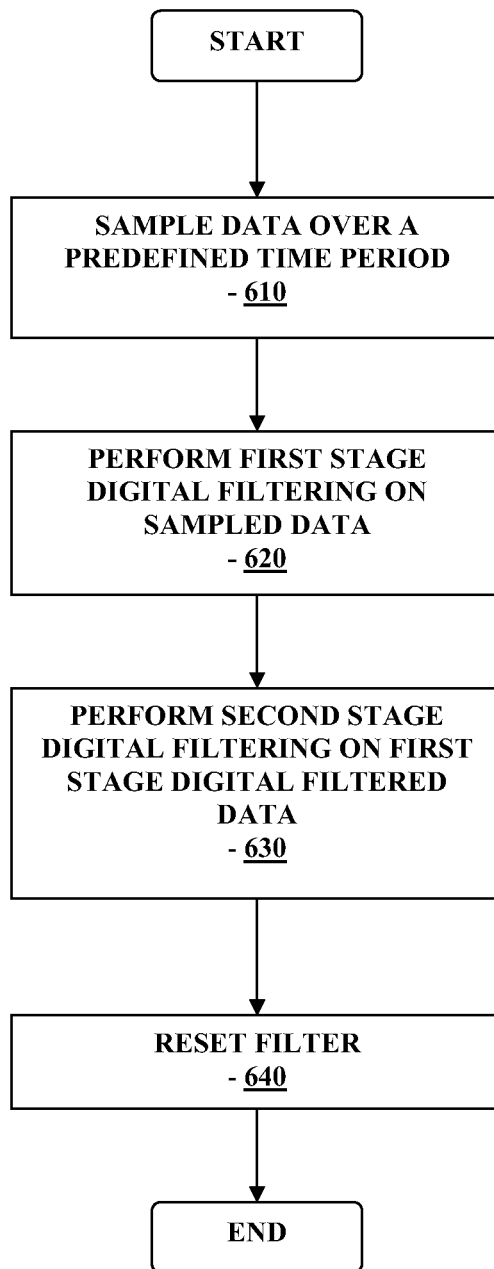

FIGURE 6

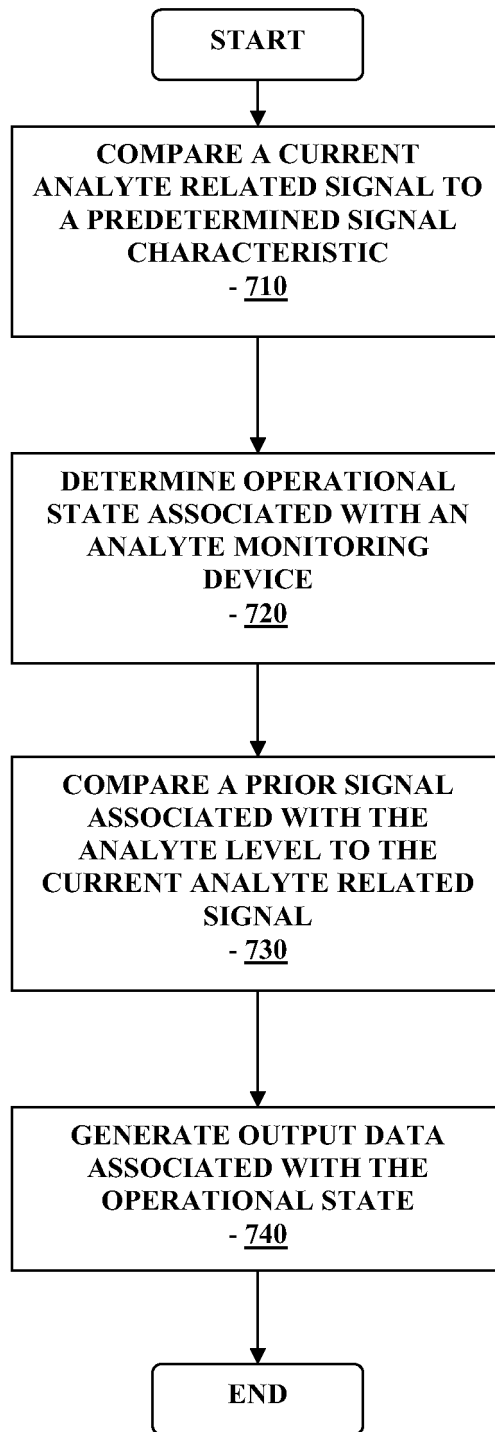

FIGURE 7

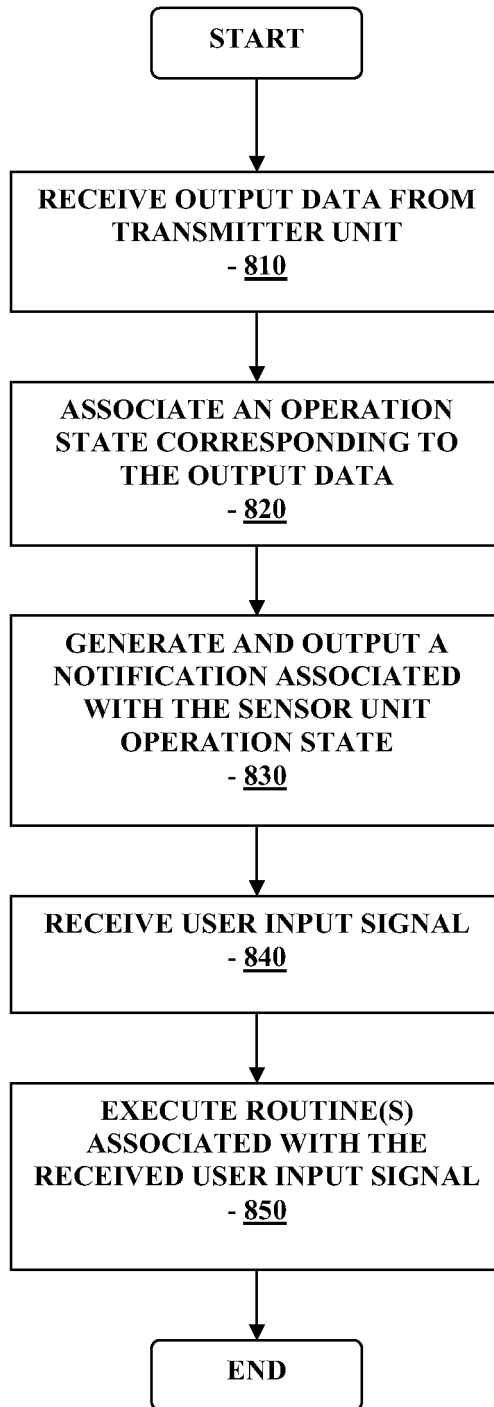

FIGURE 8

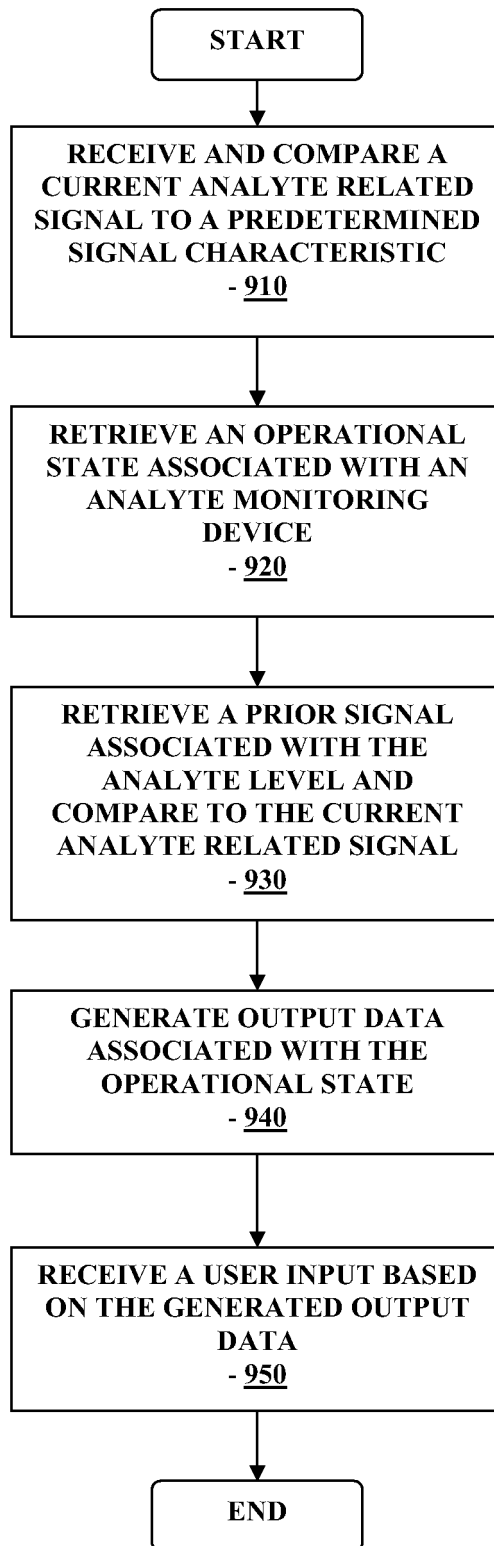

FIGURE 9

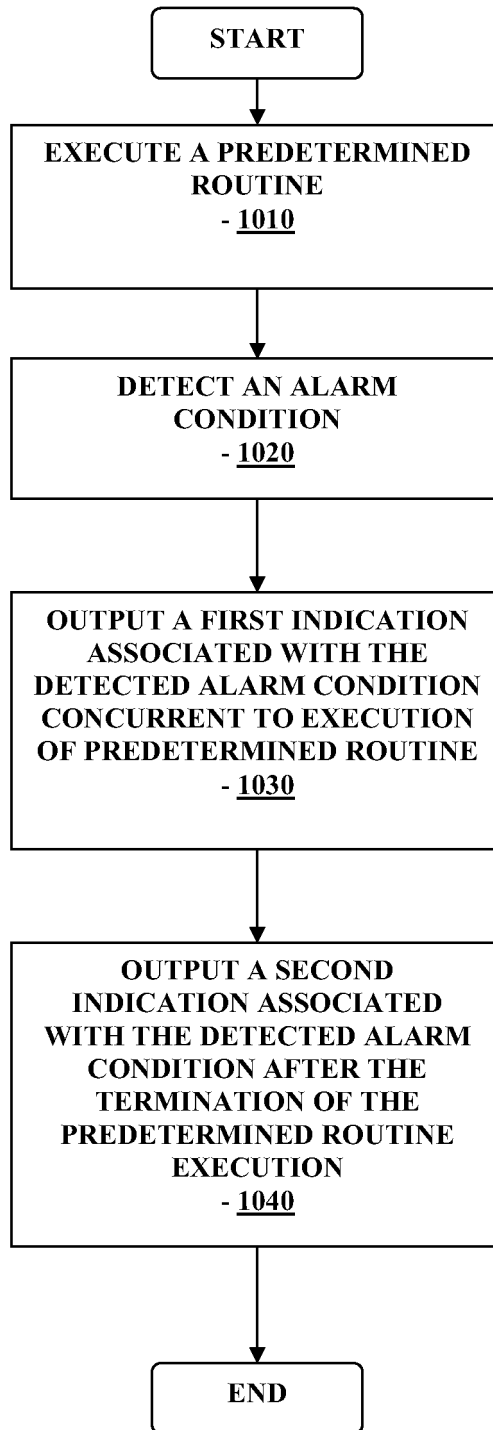

FIGURE 10

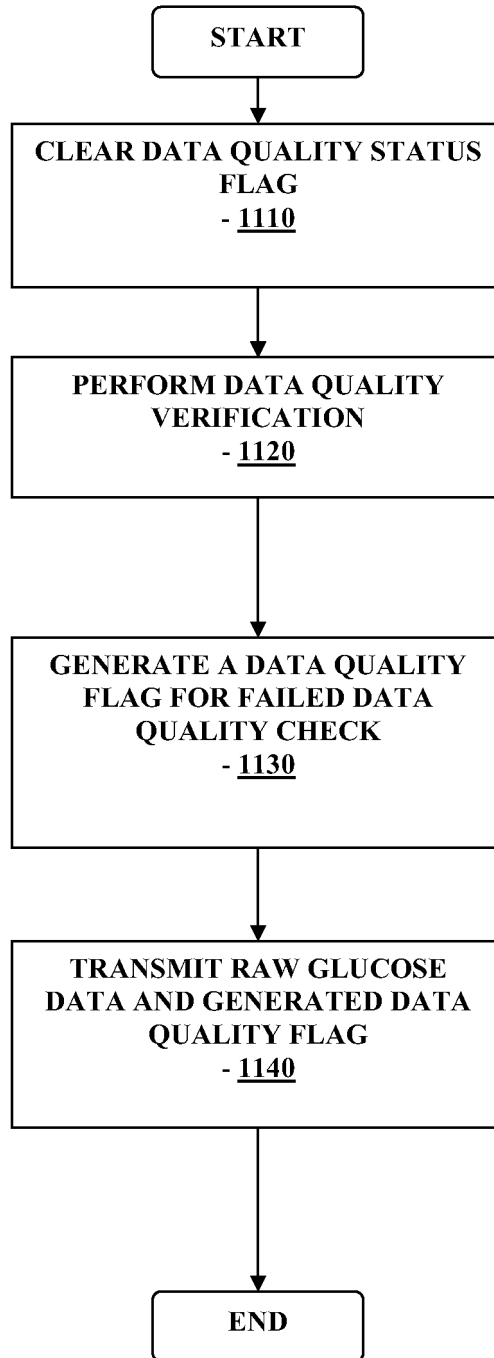

FIGURE 11

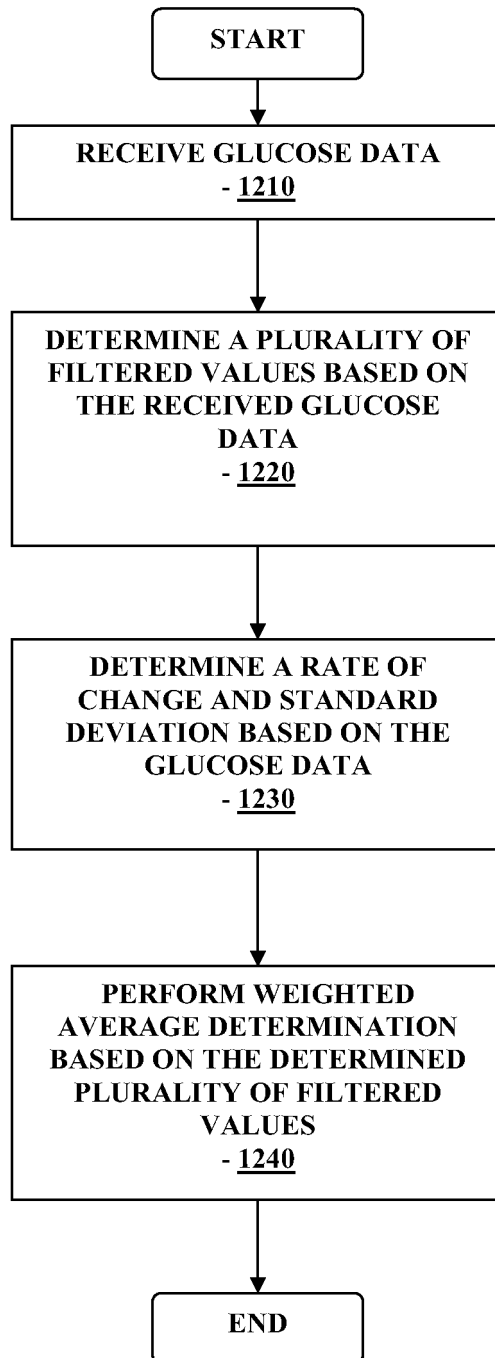

FIGURE 12

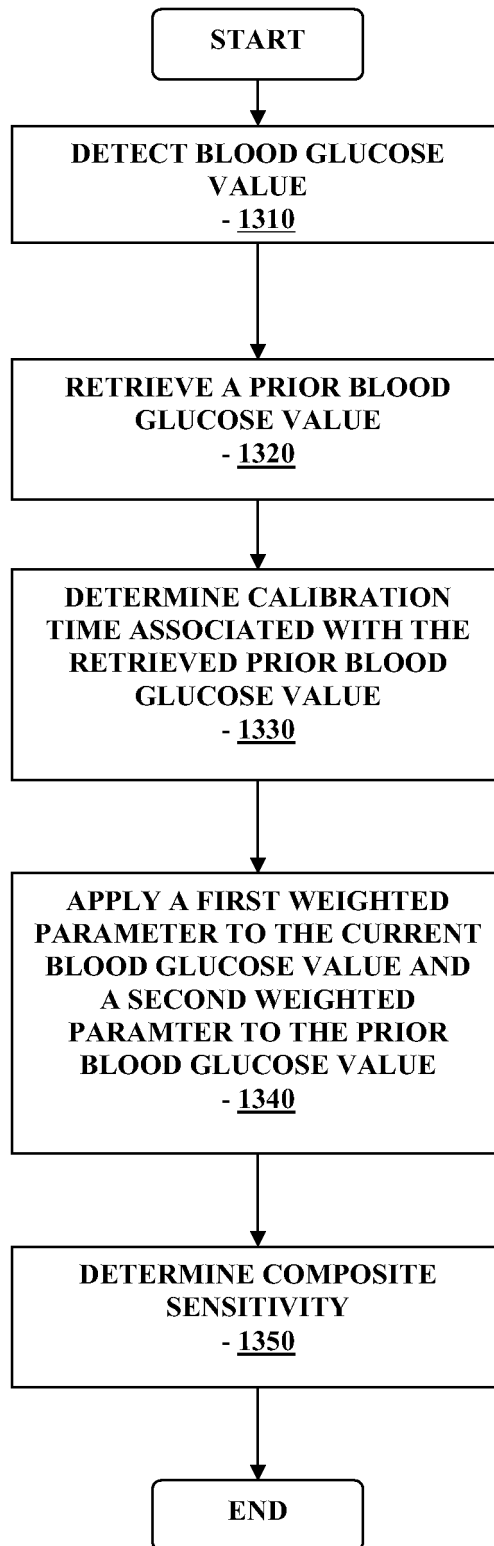

FIGURE 13

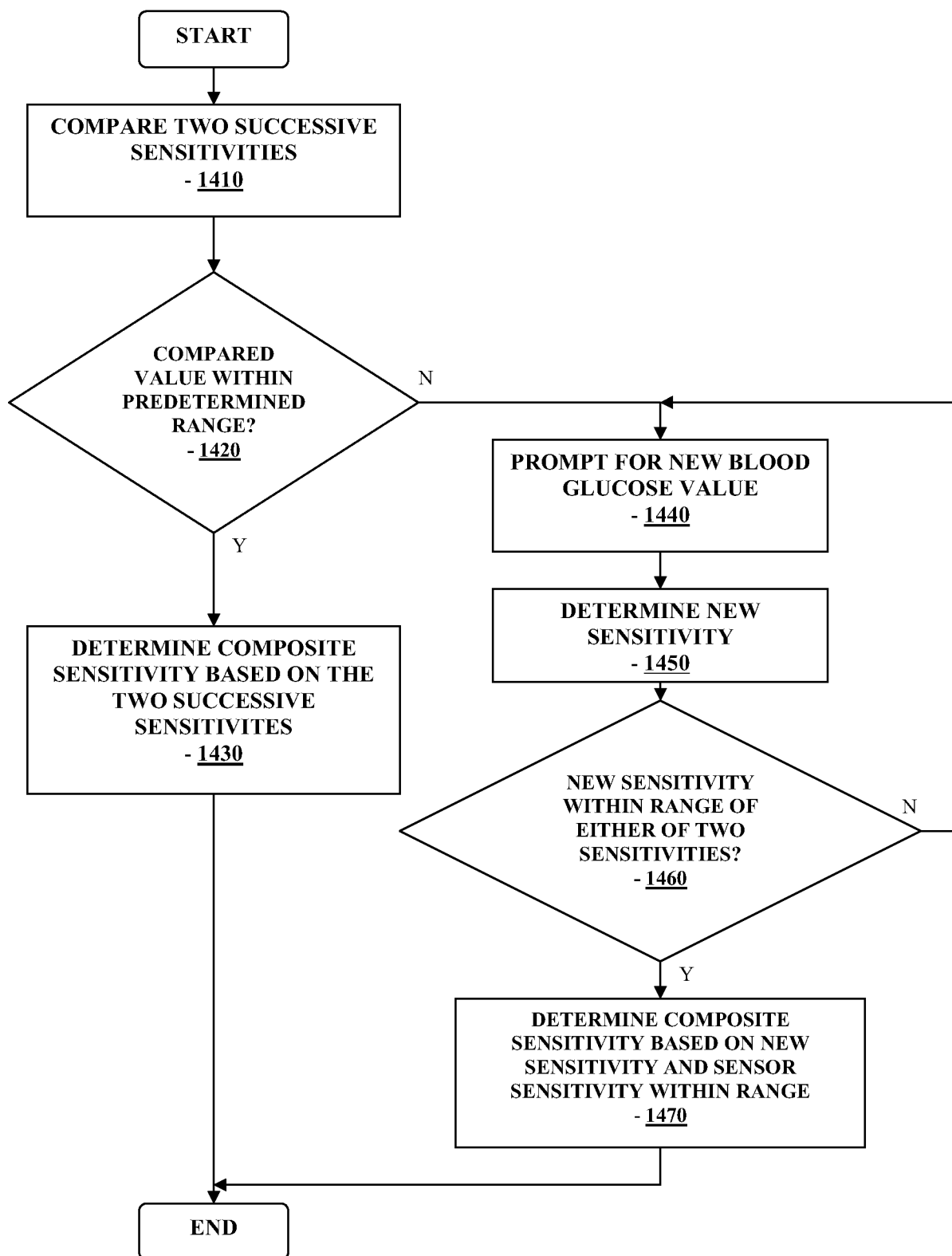

FIGURE 14

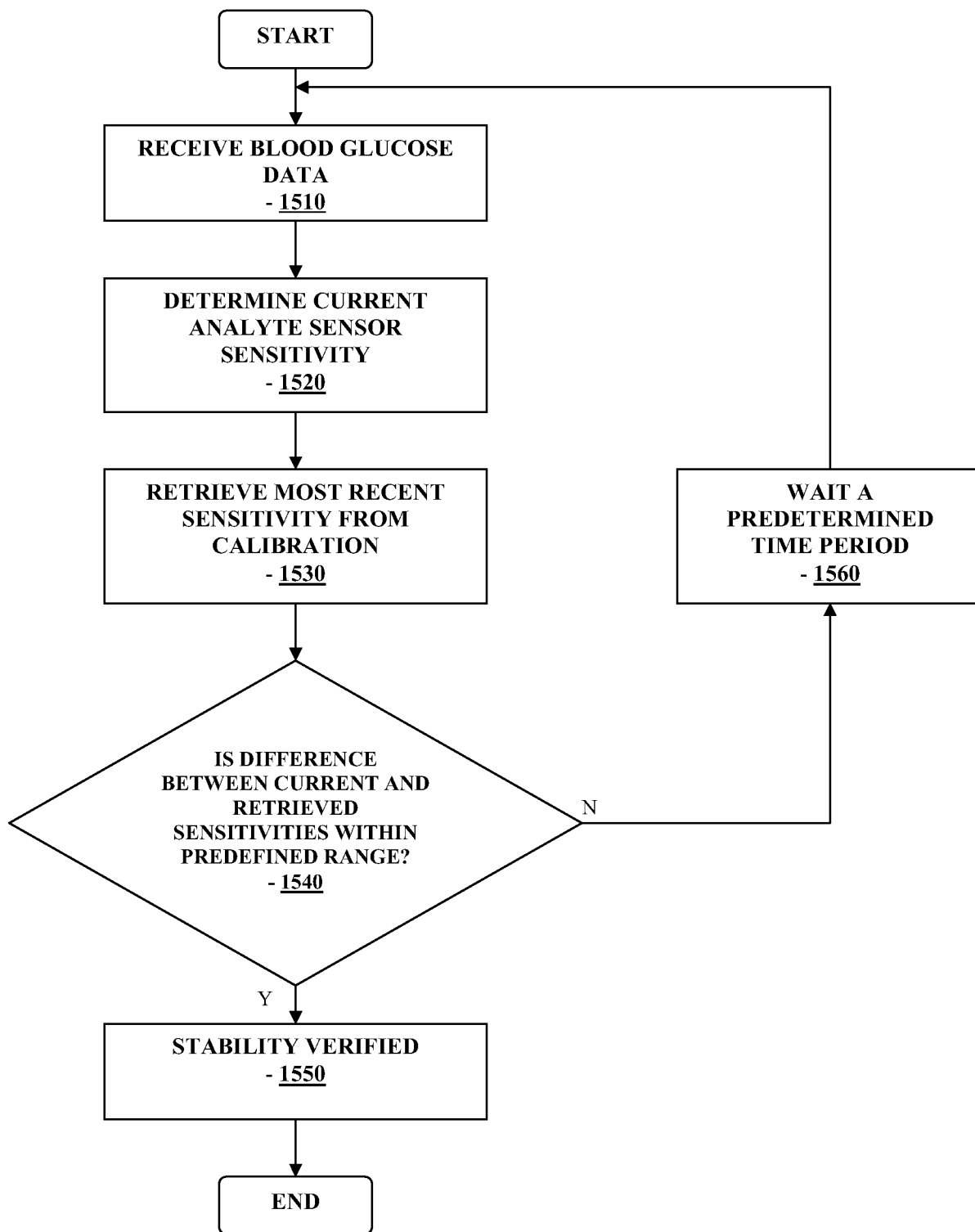

FIGURE 15

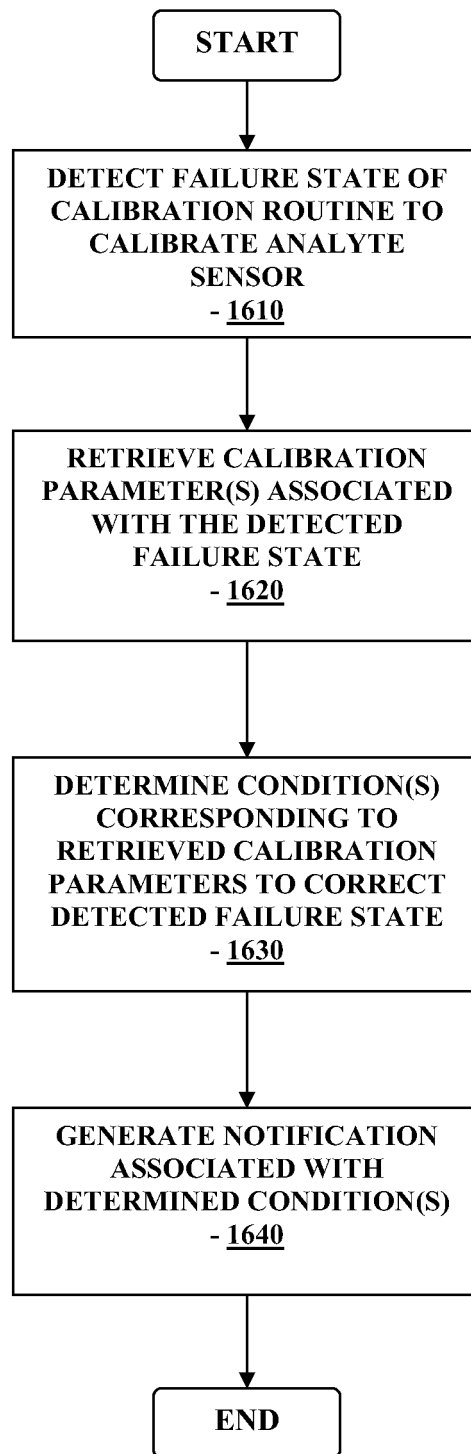

FIGURE 16

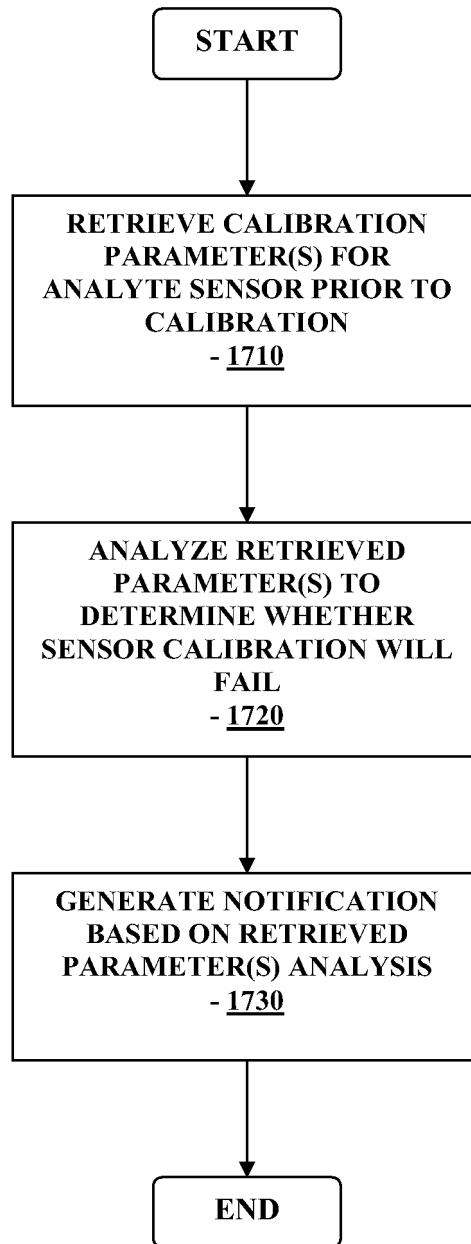

FIGURE 17

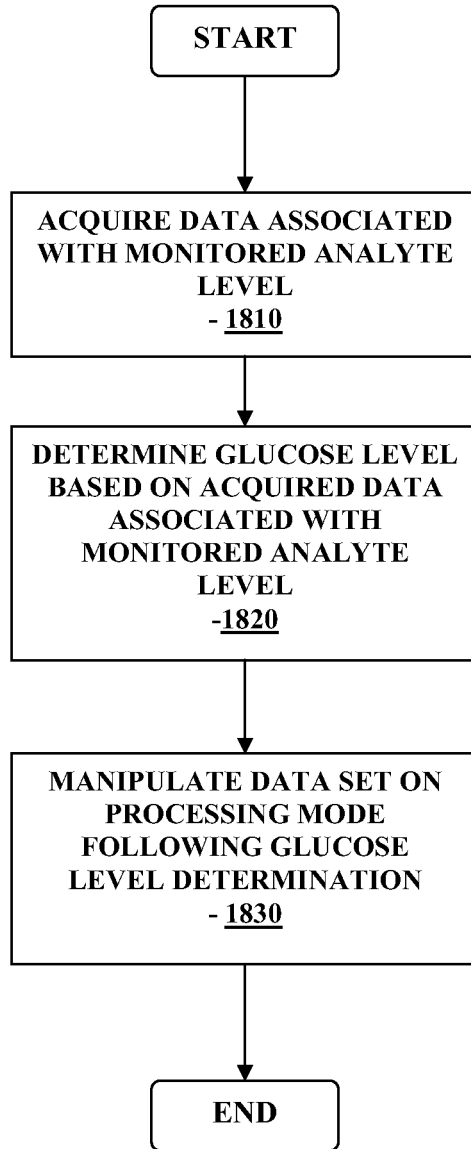

FIGURE 18

REFERENCES CITED IN THE DESCRIPTION

This list of references cited by the applicant is for the reader's convenience only. It does not form part of the European patent document. Even though great care has been taken in compiling the references, errors or omissions cannot be excluded and the EPO disclaims all liability in this regard.

Patent documents cited in the description

- US 2007066873 A1 [0004]
- US 2005027180 A1 [0005]
- US 6565509 B1 [0006]
- US 2006020186 A1 [0007]
- WO 2005051170 A2 [0008]
- WO 2007027691 A1 [0009]
- US 6175752 B [0044]
- US 20040186365 A1 [0044]

专利名称(译)	用于在医疗通信系统中提供数据处理和控制的方法和装置		
公开(公告)号	EP2182838A4	公开(公告)日	2014-02-12
申请号	EP2008796500	申请日	2008-07-23
[标]申请(专利权)人(译)	雅培糖尿病护理公司		
申请(专利权)人(译)	雅培糖尿病INC.		
当前申请(专利权)人(译)	雅培糖尿病INC.		
[标]发明人	HAYTER GARY MCGARRAUGH GEOFFREY V NAEGELI ANDREW H MAZZA JOHN C FELDMAN BENJAMIN J HARPER WESLEY SCOTT		
发明人	HAYTER, GARY MCGARRAUGH, GEOFFREY, V. NAEGELI, ANDREW, H. MAZZA, JOHN, C. FELDMAN, BENJAMIN, J. HARPER, WESLEY, SCOTT		
IPC分类号	A61B5/00 A61B5/145 A61B5/1495 A61M5/172		
CPC分类号	A61B5/14532 A61B5/002 A61B5/14865 A61B2560/0209 A61B2560/0223 A61B2560/0252 A61B2562/0295 A61M5/1723 A61M2205/35 A61M2230/201		
优先权	11/831866 2007-07-31 US 11/831881 2007-07-31 US 11/831895 2007-07-31 US		
其他公开文献	EP2182838A1 EP2182838B1		
外部链接	Espacenet		

摘要(译)

提供了用于提供用于医疗通信系统的数据处理和控制的的方法和装置。