

(19) World Intellectual Property Organization
International Bureau



(43) International Publication Date
7 August 2008 (07.08.2008)

PCT

(10) International Publication Number
WO 2008/094253 A2

(51) International Patent Classification: Not classified

(74) Agent: O'ROURKE, Thomas, A.; Bodner & O'Rourke, LLP, 425 Broadhollow Road, Suite 108, Melville, NY 11747 (US).

(21) International Application Number:
PCT/US2007/026419

(81) Designated States (unless otherwise indicated, for every kind of national protection available): AE, AG, AL, AM, AO, AT, AU, AZ, BA, BB, BG, BH, BR, BW, BY, BZ, CA, CH, CN, CO, CR, CU, CZ, DE, DK, DM, DO, DZ, EC, EE, EG, ES, FI, GB, GD, GE, GH, GM, GT, HN, HR, HU, ID, IL, IN, IS, JP, KE, KG, KM, KN, KP, KR, KZ, LA, LC, LK, LR, LS, LT, LU, LY, MA, MD, ME, MG, MK, MN, MW, MX, MY, MZ, NA, NG, NI, NO, NZ, OM, PG, PH, PL, PT, RO, RS, RU, SC, SD, SE, SG, SK, SL, SM, SY, TJ, TM, TN, TR, TT, TZ, UA, UG, US, UZ, VC, VN, ZA, ZM, ZW.

(22) International Filing Date:
28 December 2007 (28.12.2007)

(25) Filing Language: English

(26) Publication Language: English

(30) Priority Data:
60/898,506 31 January 2007 (31.01.2007) US
11/700,729 31 January 2007 (31.01.2007) US
11/807,359 25 May 2007 (25.05.2007) US

(71) Applicant (for all designated States except US): VE-NOUSLIGHT, LLC [US/US]; 40 Goose Hill Road, Cold Spring Harbor, NY 11724 (US).

(84) Designated States (unless otherwise indicated, for every kind of regional protection available): ARIPO (BW, GH, GM, KE, LS, MW, MZ, NA, SD, SL, SZ, TZ, UG, ZM, ZW), Eurasian (AM, AZ, BY, KG, KZ, MD, RU, TJ, TM), European (AT, BE, BG, CH, CY, CZ, DE, DK, EE, ES, FI, FR, GB, GR, HU, IE, IS, IT, LT, LU, LV, MC, MT, NL, PL, PT, RO, SE, SI, SK, TR), OAPI (BF, BJ, CF, CG, CI, CM, GA, GN, GQ, GW, ML, MR, NE, SN, TD, TG).

(72) Inventors; and

(75) Inventors/Applicants (for US only): WOOD, Fred [US/US]; 8 Deering Court, Medford, NY 11763 (US). GOLDMAN, Ron [US/US]; 42 Goose Hill Road, Cold Spring Harbor, NY 11724 (US). CONLON, Stephen, P. [US/US]; 40 Goose Hill Road, Cold Spring Harbor, NY 11724 (US). LUCIANO, Vincent [US/US]; 96 Horizon View Drive, Farmingville, NY 11738 (US).

Published:
— without international search report and to be republished upon receipt of that report

(54) Title: ENHANCED LASER VEIN CONTRAST ENHANCER

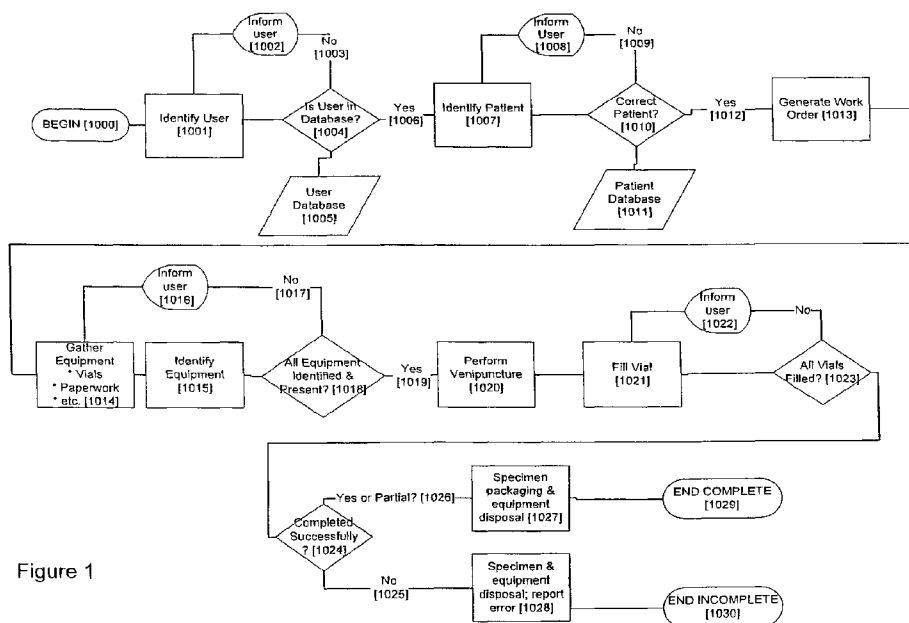

Figure 1

(57) Abstract: It is known in the art to use an apparatus to enhance the visual appearance of the veins and arteries in a patient to facilitate insertion of needles into those veins and arteries. This application discloses a number of inventions that add additional data collection and presentation capabilities to a handheld vein enhancement apparatus and a set of processes for the collection of blood and the delivery of IV medicines that use the handheld device to mediate the process.

WO 2008/094253 A2

ENHANCED LASER VEIN CONTRAST ENHANCER

Field of Invention

This application claims priority on U.S. Provisional Patent Application Serial No. 60/898,506 filed January 31, 2007 and U.S. Provisional Patent Application Serial No. 60/817,623 filed June 29, 2006. This application is a continuation in part of United States
5 Patent Application Serial No. 11/700,729 filed January 31, 2007, United States Patent Application Serial No. 11/478,322, filed on June 29, 2006. The disclosures of each of these applications are incorporated herein by reference.

In these applications, technology, embodiments and ergonomics of a miniature vein enhancement system is described that uses scanned lasers and other light sources to
10 accomplish the acquisition and projection of a vein pattern to aid the user in locating a vein for venipuncture. In this application, additional capabilities and how these capabilities improve the processes associated with venipuncture are set forth.

Key among these is the use of enhanced embodiments that allow additional data collection and application processes that are critical to the successful performance of
15 venipuncture and related medical and business procedures.

Background of Invention

It is known in the art to use an apparatus to enhance the visual appearance of the veins and arteries in a patient to facilitate insertion of needles into those veins and arteries. Such a system is described in US Patents 5,969,754 and 6,556,858 incorporated herein by
20 reference as well as a paper by Zeman, H.D. et al., "The Clinical Evaluation of Vein Contrast Enhancement", Department of Biomedical Engineering, University of Tennessee Health Science Center, Memphis, TN. 8 Feb. 2007. Luminetx is currently marketing such a device.

under the name "Veinviewer Imaging System" and other information related thereto is available on their website, www.luminetx.com, which is incorporated herein by reference.

In this application, the use of biometrics to identify the user and/or the patient to aid in the management and safety of processes involving venipuncture are described. One such biometric that is unique to this field is to use vein patterns to identify the individual. For example, United States Patent 5,787,185, provides for "A method of verifying the identity of an individual comprises capturing an image of the subcutaneous vein pattern at a predetermined region of the individual, converting the captured image to a plurality of stored values representative of the intensity of said image at specified relative locations, processing the stored values to produce a second plurality of stored values representative of the image of the vein pattern having enhanced contrast and subjecting the second plurality of stored values to a thresholding process to select those above a predetermined value and storing a set of measurements derived from the selected ones of said second plurality of stored values for comparison with a corresponding set of measurements made on the individual."

Current embodiments are large, fixed mounted devices. The present invention allows this capability to be integrated into a handheld device as well as to be used as part of the management of the venipuncture process and the handling of delivered drugs and drawn blood.

Objects of the invention

- 1) It is an object of the invention to integrate data collection capabilities such as bar code decoding and biometrics and use those to control the use of the vein scanner

- 2) It is another object of the invention to combine the projection of vein patterns with the projection of data such as text and/or icons to enhance the usability and capabilities of the device
- 3) It is another object of the invention to project variable data overlaid on the vein pattern.
- 5 4) It is yet another object of the invention to enable payment schemes such that the practitioner can acquire the device at a reduced initial cost and pay per use or pay per user.
- 5) It is yet another object of the invention to gather and then project back on the patient additional parameters of the patient such as pulse and temperature.
- 10 6) It is yet another object of the invention to connect the scanner to a host computer to allow data collected to be stored for future uses such as patient history and billing through wired or wireless means.
- 7) It is yet another object of the invention to connect to other devices monitoring the patient and to project the data from those monitors back on to the patient
- 15 8) It is yet another object of the invention to project the data collected by the invention and other devices onto an arbitrary surface so that the practitioner can view the data
- 9) It is yet another object of the invention to allow the practitioner to avoid blood vessels when performing a procedure on a patient
- 10) It is yet another object of this invention to vary the resolution over the working area to
20 allow certain portions of the viewed area to be scanned in higher resolutions than in other areas thereby using the limited bandwidth of the device in an optimized manner.
- 11) It is yet another object of the invention to provide additional lighting on the working area to aid the practitioner to see the patient's body.

12) It is yet another object of the invention to provide a mechanism for measuring pulse and projecting the pulse rate back on to the body

13) It is yet another object of the invention to provide a mechanism for measuring blood oxygen levels and projecting the value back on to the body.

5 14) It is yet another object of the invention to provide a mechanism for reading pulse rate without body contact when the target person is participating in exercise.

15) It is yet another object of the invention to provide the ability for a remote practitioner to perform or assist in the performance of a venipuncture.

10 **SUMMARY OF THE INVENTION**

In this application a handheld vein detection device is described with capabilities that allow it to enhance the management of venipuncture processes including blood draw, venous or arterial injection or intravenous starts through the use of bar codes and biometrics; as well as embodiments that enhance usability; and the ability to detect and record additional data
15 about the patient such as the location of venous valves, diagnostic data and re-project that data on to the patients body.

Brief Description of Drawings

Figure 1 – this flowchart describes the process for taking blood samples using an embodiment of the invention that combines vein location with other data collection including
20 biometrics and bar code scanning

Figure 2 - this flowchart describes the process for injecting medicines into a patient using an embodiment of the invention that combines vein location with other data collection including biometrics and bar code scanning

Figure 3 – this exhibit shows the types of bar codes that might be used in the invention

Figure 4 – this drawing shows examples of text and icons that might be projected by the engine

5 Figure 5 – this drawing shows how variable data can be projected to increase the amount of data available to the practitioner

Figure 6 – these drawings shows how pulse and oxygen levels can be determined

Figure 7 – these drawings shows how the device can be integrated into a robotic system

10 Figure 8 shows a person on a treadmill using the invention.

Detailed Description of the Invention

Text and Iconography Projection

15 The preferred embodiment of the invention simultaneously captures information about the target part of the body (e.g., forearm) such as vein location and then re-projects information about the captured image directly over that area of capture. As previously described, in one embodiment a visible representation of the vein position(s) is projected directly on the vein locations thereby highlighting the veins and making them easier for the
20 practitioner to find.

In enhanced embodiments, digital information in the form of text and/or icons can be included in the information that is re-projected on to the skin. The text and icons can be any useful information to assist the practitioner in performing the procedure. This

information may be real time information such as vein depth or it may be patient information such as patient name or it may be mistake proofing information such as the quantity of blood needed to be drawn next so that the vial size can be verified.

Referring to Figure 4, text 1100 is projected that indicates information about the
5 process being performed (e.g., next), the status of the system (e.g., OK) or attribute of the patient (e.g., blood pressure is 110/50). As a further enhancement, icons or pictographs 1101 can be projected that shows information in a graphical manner such that it doesn't require a common language between users. Further extending the capabilities, combinations of text and icons 1102 can be projected that show both a specific value for a piece of data and a
10 qualitative indication of the importance of the data. In the example 1102, normal temperature is checked, and high and low temperatures are similarly indicated.

An alternative embodiment uses variable markings to indicate some value about the patient's status. In figure 5, an arm 1131 is shown with several veins 1127/1132 shown. The projection area 1130 overlaps two veins which are therefore highlighted so that the
15 practitioner can easily find them. Additional information about those veins such as depth can be shown with size indicators 1125/1126/1128/1129. The size of the line between the end marks can be varied to show relative or absolute depth of the vein. If additional colors or intensities are available in the embodiment, the line can be directly overlaid on the vein track 1128/1129 in a different color or in a different intensity or both. Alternatively, a negative
20 image in relation to the projection image can be used to show the size bars 1128/1129. A further alternative would be to place the size bars in proximity but not on top of the imaged veins 1125/1128.

Blood Sample Lifecycle Management

The process of obtaining blood, storing it, transporting it, testing it and returning the test results has many steps, involves multiple persons and is prone to errors. Through the use of the invention many of these mistakes can be eliminated. Referring to Figure 1, a process for drawing blood samples is described. The process begins 1000 with the verification of the user/practitioner 1001. This verification can take many forms. The device can be equipped with a keypad such that the user can enter in a personal identifier such as employee id along with an optional pass code. The device can also have a built in token reader such as a smart card reader or an RFID reader such that the user presents this physical token to the device to identify themselves. The device can have built-in biometrics reading capabilities such as a fingerprint reader or an audio input subsystem to allow for voice recognition. Since the device is inherently an image capturing system, image based biometrics such as vein pattern recognition and facial recognition can be used. In most cases a single identifier would be used. However, in some circumstances, a higher level of security might be desired and combinations of identifiers could be used before the process is allowed to continue.

Once an identifier or identifiers have been acquired 1001, they can be compared to a database 1005 of valid users of the device either in a locally stored database or in the case of a scanner that is connected either wired or wirelessly, a remote database can be queried. If the user isn't found in the database 1003 or if the user does not have appropriate training or privileges for the procedure they can be prompted to try again 1002. This prompt could be in a display built into the device, through audio feedback, through visual feedback of an indicator such as an LED, or in the preferred embodiment, through the projection of text or icons from the scanner's projection field. If they user has been successfully identified 1006 then the process moves on to verifying that the patient is the correct patient.

Verification of the patient 1007 can take all of the forms described above for the user of the device. In addition, it is common in hospital environments for a patient to wear a bar coded wrist band. The device can be used to scan that wrist band as a means of identifying the patient. Once an identifier or identifiers have been acquired 1010, they can be compared to a database 1011 of valid patients of the device either in a locally stored database or in the case of a scanner that is connected either wired or wirelessly, a remote database can be queried. If the patient isn't found in the database 1011 or if there are not orders on file for the procedure, the user can be prompted to try again or to correct the situation. 1008. This prompt could be in a display built into the device, through audio feedback, through visual feedback of an indicator such as an LED, or in the preferred embodiment, through the projection of text or icons from the scanner's projection field.

Now that the practitioner and the patient have been validated, a list of blood needed and the equipment needed to perform the procedure 1013 can be presented to the user through one of the modalities described above.

Since the invention can be used for bar code data collection, it can be used to ensure that the appropriate materials are in hand before the venipuncture is performed. As the user selects each piece of equipment 1014 they can use bar code or other means of identification such as RFID to verify that the item 1015 is on the list of needed equipment. The process repeats and prompts the user 1016 to continue with gathering equipment until all of the equipment has been identified 1018.

Once a complete set of equipment has been verified 1019, the user can use the vein scanner to find a vein and perform the venipuncture 1020. As the user fills the vials 1021 they can be identified again as filled and if all of the required vials have not been filled 1023, the user can be prompted to continue 1022.

Once all of the vials are filled 1080 the user verifies that the process has completed successfully 1075 and then packages the specimens taken for delivery to the lab 1027/1028 and. The status of the completed process is reported either in the documents forwarded on with the specimens and in a preferred embodiment, this information can be updated in to the
5 medical records database using one of the input and connectivity modalities previously described.

The flowchart and the associated descriptions are shown to highlight how additional input and output modalities integrated into the vein scanner can be used to enhance the process of blood collection. However, the specifics of the processes implemented in
10 different medical environments will require changes to the process flow to meet the unique requirements of the specific environment.

Injection Lifecycle Management

Improper or mistaken delivery of medicines is one of the leading causes of accidental injury or death in the healthcare system. In addition to the use of the vein scanner to help
15 identify the position of veins to aid in the taking of blood specimens, the vein scanner can be used to assist in the delivery of medicines into the patient.

In addition, an enhanced scanner can assist in the management of the injection process in a similar way as described above for taking blood specimens. Referring to Figure 2, a substantially similar process is presented. Steps 1050-1069 are handled as previously
20 described for steps 1000-1019 in Figure 1. While blood draw is typically handled with a single catheter and multiple containers, injections might use multiple hypodermics, so step 1070 is not always performed and step 1071 might include multiple injections and therefore multiple

uses of the scanner to verify vessel location. All of the remaining steps are substantially identical to that described above.

Intramuscular Injections

A primary focus of the invention has been to locate blood vessels so that a practitioner can access that vessel with a needle for withdrawing blood or injecting a material into the blood stream. In medical practice, some inject-able substances must be injected into the muscle rather than into a vein. Through the use of the invention, veins can be located for this procedure and the area between veins can be targeted by the practitioner thereby reducing the risk of inadvertently injecting the substance into a vein.

Image Capture

In an embodiment of the invention where the laser is scanned in a predictable and repeatable pattern, such as a raster pattern, an image of the targeted area can be captured and stored into memory. This image can be of sufficient quality and resolution to allow image processing techniques that are well know in the art to be applied to this captured image.

As previously described, this stored image can be used for many purposes such as using various image processing techniques to find the vein pattern within the image. In addition to the location of the vein, with appropriate image processing software the scanner can be used to capture and present additional information about objects seen in the field of view.

In a digital camera a photo detector array that has elements that are separately sensitive to red, green and blue light are used with either ambient light or a broad spectrum white light to capture the image. In a laser based system, the image being captured is based

on the target surface's reflection of the light of the specific color (wavelength) of the laser being projected.

For each laser used in the system an additional color can be captured and included in the image. In the preferred embodiment with an infrared and a visible red laser, an image can be captured based on both the reflectivity at infrared and red. Depending on the desired result, one or both of these images can be used. For example, in a bar code application, a bar code could be scanned with the infrared laser that is invisible to the human eye. With the addition of other color lasers, more information about the target surface can be captured.

Finding needle

Since the needle is a large object that is above the surface of the body prior to venipuncture, image processing software can be used to identify the position of the needle using its different characteristics when compared to skin and sub-skin body parts. Since the invention both captures an image and projects an image, the user can be prompted with projected feedback as to the position of the needle in relation to the nearest vein in the field of view. Since it is important that the needle pierces the vein in its center, icons such as cross hairs or arrows can be used to guide the practitioner to the proper position. For example, right/left/forward arrows can be used to accurately guide the practitioner to the center of the vein by showing them the direction to move the needle. The invention is also able to use other feedback mechanisms such as audible feedback or that of projecting text into the field of view with prompting information.

Finding vein

Once the image is captured from the penetrating infrared laser, many algorithms well known in the art can be used to find the veins. Several things are typical in the types of veins

that one would wish to select for venipuncture, including that it has a sizeable segment that is linear. Therefore, a line detection algorithm can be used. Another thing that is characteristic of the vein image being captured is that there are edge boundaries between the area surrounding the vein and the vein itself. An edge detection algorithm such as the one
5 described by Canny in the IEEE Transactions on Pattern Analysis and Machine Intelligence archive, Volume 8 , Issue 6 (November 1986), Pages: 679 – 698, Year of Publication: 1986, ISSN:0162-8828, can be used to find these edges.

Finding depth

In a preferred embodiment, the output intensity of the laser (or the gain of the photo
10 detection circuitry, or a combination of both) can be varied from frame to frame as the scanner passes over the target area. The higher the intensity, the deeper the laser will penetrate the body. At a low setting, the veins identified will be close to the surface. At higher settings, more and deeper veins will be identified.

By comparing the images between frames a determination can be made of which
15 veins are close to the surface of the body and which veins are deeper. As the intensity increases and new veins become visible, the image processing software can tag the veins seen with an indicator of the intensity at which they first became visible. This provides an indication of relative depth.

Several user interfaces are possible. In a system with multiple, differently colored
20 projection lasers, veins at different depths can be displayed in different colors. In a system with a single projection color, the lines that represent the veins could have patterns superimposed over the vein to indicate depth such as crosshatching for shallow and solid for

deep. An alternative embodiment would be to allow the user to set what depth to look at so that only the veins of a specific depth are presented to the user.

Bar code

There is a significant body of knowledge on the use of image capture devices to read
5 bar codes such as described US Patent 6223988. Since the invention is capable of capturing
an image of the necessary resolution and quality for bar code detection, algorithms well known
in the art can be used to find and decode bar codes that are in the field of view.

Bar codes are commonly used to identify users (through ID cards or badges), identify
patients (through wrist bands) and to identify equipment (through bar-coded labels) in
10 medical environments. It is an important extension of the invention to have it able to read
bar codes so that it can be fully integrated into the work flows of the medical environment.

The invention can be implemented such that it captures images of the field of view,
and stores those images into computer memory. Using techniques well known in the art, the
captured images can be searched for the presence of bar codes such as those shown in Figure
15 3. Both the 1D and 2D bar codes shown in Figure 3 could be captured by an image
capturing version of the invention. An alternative version of the invention can use the signal
from a single line of the laser scanning pattern, as it crosses a 1D bar code as seen in the
upper portion of Figure 3, and decode the bar code through the reflections of the marks and
spaces through techniques that are well known in the art.

20 By re-using the image capture capabilities of the scanner for bar code reading a very
small, tightly integrated, low cost embodiment can be created that combines vein location and
bar code scanning.

An alternative implementation of bar code scanning would be to use a commercially available off the shelf bar code scanning engine such as those available from Hand Held Products integrated into the housing of the invention. This would have the advantage of keeping the vein detection portion of the design simpler and forgo the need to develop or
5 integrate bar code reading into the vein detection electronics and software. The disadvantage is that there would be redundancies that might increase the size and cost of the unit.

Biometrics

As previously described, the ability to identify the user of the invention and the patient upon which the invention will be used are very useful to the management of the
10 medical procedures. Simple methods of passwords or PINs can be used for the user identification, and as previously described bar coded wrist bands can be used to identify the patient. However, each of these approaches has its weaknesses in that the password or PINs can be misplaced and the wrist band is only available in a hospital environment.

Once again, the image capture capabilities of the invention can be used for capturing
15 many biometric identifiers such as but not limited to fingerprint, face recognition, iris or retina recognition, and vein pattern recognition through techniques well known in the art.

There are many biometric capture devices available on the market that are designed to be integrated into an OEM devices such as laptops. This includes fingerprint modules such as those available from AuthenTec (www.authentec.com) which can be integrated into the
20 invention. This avoids the complexity of the user having to 'take a picture' of their finger and allows them to simply swipe their finger on the sensor.

While fingerprint has become a common method of biometric identification, any biometric identification device could be integrated into the invention to allow the user and patient to be identified.

Non contact biometrics can be valuable in a medical situation. For example, a fingerprint would be difficult to read from the gloved hand of the practitioner and the device would have to be cleaned between patients if they came in physical contact with it for a fingerprint swipe. Therefore, non contact biometrics are very desirable. By adding a microphone and associated analog to digital circuitry, sound sampling can be included in the invention and voice recognition techniques well known in the art can be applied to user and patient identification.

Non-linear scanning speeds

The scanning speed of a moving laser and the resolution of the captured image are subject to many physical limitations such as the maximum speed of the mirror, and the bandwidth of the electronic circuitry. However, it is desirable in some embodiments to have a higher resolution of the image on a particular area of the body than the device is inherently capable of. One mechanism to overcome this limitation would be to reduce the area being scanned so that whatever the native resolution of the device is, it is being applied to a smaller physical area. This trades off scanning area vs. resolution.

An alternative embodiment of the device would be to change the resolution of the scanned image in a particular area of the field of view. For example, since the practitioner would typically focus their attention on the center of the field of view, if the device can be made to have higher resolution at the center, the information content of the projected image would be higher at that most important point, without reducing the total field of view of the

device. In a scanned laser implementation, this is done by varying the amplitude of the drive circuit so that the mirror moves less quickly in the center and more quickly outside of the center. The increase in dwell time at the center of the image provides higher resolution in that area. The decrease in dwell time outside the center would reduce the resolution in that area. The advantage of this over the previous embodiment is that the total field of view is maintained while still gaining an improvement in resolution of the targeted area.

Business Models

Most medical practitioners will have the need to draw blood or otherwise stick the patient in their normal course of practice. However, for many of these practitioners this is not done on a regular basis. For example, in a general practitioners office this might be only two to three times a day. This presents a dilemma. On one hand, they don't do the procedure often enough to become very skilled, and would therefore gain an extraordinary benefit from a vein location device, but on the other hand they don't perform the procedure often enough to cost justify the acquisition of such a device.

Records of usage can be:

1. Uploaded immediately through a wireless connection
2. Kept in the device memory and then uploaded to a billing system later through a wired or wireless connection
3. Kept in the device on a removable storage device such as an SD card and then transferred to a billing system by removing the card from the device
4. Entirely within the device by using a pre-paid billing approach where a certain number of usages are enabled and the device counts down until there are

none left and then disables itself until such a time as more credit is added,
through a wired, wireless or physical token as discussed above.

To overcome this dilemma, the device can be modified to provide a per use-type licensing
model. This can be approached by keeping track of the number of times the device is

5 activated in memory that is built in to the device. Various schemes can be used to activate
the device such as:

1. Enable the device for a pre-determined period of time. This can be cheated in that
there is no limit to the number of patients scanned during that period of time.

2. Enable the device for an unlimited period of time after a particular patient is
10 identified through a biometric scan such as vein pattern, face or voice recognition.
This is more expensive to implement, but is much harder to cheat.

3. Some combination of 1 and 2.

The inverse of this dilemma is an office with many practitioners where they share the device.

In such a circumstance, the benefit of the device is very large when the entire group is
15 considered. It would desirable to be paid more for the device in such a circumstance.

Through the use of biometrics, the practitioner can be identified and a record can be kept in
the device of that practitioner's access of the device. As above, various schemes can be used
to activate the device such as:

1. Enable the device for a pre-determined period of time. This can be cheated in that
20 there is no limit to the number of patients scanned during that period of time.

2. Enable the device for an unlimited period of time after a particular patient is
identified through a biometric scan such as vein pattern, face or voice recognition.
This is more expensive to implement, but is much harder to cheat.

3. Some combination of 1 and 2.

Data collection

In the simplest embodiment, a vein scanner is a stand alone device that simply detects and projects a vein pattern back on to the skin of the patient. In this embodiment, no data about the process or the patient is retained for future use. In an enhanced embodiment, the device can be used to collect, store, manipulate and transmit information about the user, the usage of the device, and the patient. Also, updated control software and firmware can be uploaded to the device. In addition, data can be transferred into the scanner that can be used as previously described to manage the processes associated with venipuncture.

The transfer of information can either be batched up so that when needed the device can be connected to a computer system for upload and download, but in normal operation it is unconnected, or the device can be always connected to a computer system either through a wired or wireless connection. There are advantages and disadvantages and costs associated with each of these techniques that are well known.

While a bi-directional connection that allows the systems to acknowledge that communications have been properly received, a one-way communication scheme can be used for simple embodiments.

Wired Connectivity

The device can be connected to a computer system using a cable such as commonly seen in bar code scanners at store checkouts. The advantage of this implementation is that it is typically low cost and doesn't require that a battery be in the handheld and eliminates the need to charge the battery. The disadvantage is that the unit cannot be moved far from the computer and the cable can get in the way and easily breaks. Approaches well known in the

art can be used for cabled communication such as RS232, USB or Ethernet can be used for transport medium.

Wireless Connectivity

A wireless implementation eliminates the problems associated with a cable with the tradeoff that a battery is needed in the device. Wireless can be implemented with well understood approaches such as point-to-point proprietary protocols such as seen in remote control key fobs or standard protocols such as Bluetooth or WiFi.

Optical Connectivity

Since the device contains both a means of measuring light with its photo detector and emitting light with its lasers, these devices can also be used to transmit and receive data. Thorough the use of modulation schemes that are well known in the art, the laser can be used to transmit data to a remote receiver that could be integrated into the cradle or into a stand alone receiver. This receiver would have a photo detector system capable of detecting and decoding the modulated laser light. It would also have an output system such as a LED or LEDs that would transmit a modulated light signal at a wavelength that can be detected by the photo detector in the handheld. In this manner a two-way communication session can be established.

Batch Connectivity

Memory can be added to the system so that system events can be captured and system control information can be kept in that memory. From time to time, the information collected will need to be sent to another computer or new control information will need to be downloaded to the scanner. Any of the communication techniques previously described can

be used on an ad-hoc basis to connect the scanner to a computer and to transfer the information. When not transferring information, the scanner is disconnected from the computer system and continues to operate in a stand alone mode.

Flashlight

5 In many field medical situations, there is limited ambient light available for performing procedures such as venipuncture. One mechanism that a practitioner would use to improve lighting would be to use a handheld flashlight to illuminate a specific area of the patient's body. One embodiment of the invention would be to integrate the scanning capability into a flashlight and the inverse of integrating a flashlight into the device.

10 One embodiment is that the invention be used such that the intensity of the projected field is bright enough to illuminate the body area without the need of additional lighting during the venipuncture process. This can be implemented so that the intensity is controllable by the user with the same hand that is holding the scanner. By varying the intensity of both the dark areas that represent veins and the light areas that represent the
.15 spaces between veins, and keeping the contrast between the two sufficiently different, the field of work can be kept well lit while maintaining the ability to discern the vein positions.

Integrated scanner into a flashlight

Most of the embodiments of the invention have been described as stand-alone devices. However, since the scan engine of the invention can be miniaturized, it is uniquely
20 suited to be integrated into other devices already in use by the practitioner. For example, the scan engine can be built into an otoscope such that it becomes a multi-function device for both looking into shaded areas of the body such as the ear canal and then used for vein

location. The advantages to the user are that they have a single device to buy and manage and a single battery can be used.

Another device that the invention can be integrated with is a flashlight. Depending on the application, the scanner can be integrated so that the light beam and the scan/projection field are aligned along the same path. In this manner, the area of the body is illuminated by the flashlight and the vein pattern is viewable in the same field. The laser projection will be bright enough for most applications, but the flashlight/scanner combo can contain controls that alternately switch between scan/project only, light only and both or other combinations of those modes. The intensity of both the flash light and the projector can be controlled in these modes to ensure that the pattern remains visible without becoming over-bright or too dim.

Integrated flashlight into the scanner

An alternative approach is to add lighting capabilities to the scanner. Finer control over the modes of the device can be accomplished in this way. In a preferred embodiment, the scanner is implemented so that multiple lasers allow any color to be projected on to the body including white. In this way, the field of view can be illuminated in white light and the other colors can be used to identify the position of the veins and to project data into the field of view. Since there is no competing illumination from a flashlight bulb, the image will be easier to read, while still illuminating the body part.

A further enhancement of the invention would be to implement a non-linear scanning pattern so that the illuminated area can be made arbitrarily wide, thereby increasing the device's utility as a flashlight while maintaining a good vein image in the center of the scan area.

A user interface can be implemented that allows the practitioner to switch between these modes and to modify the parameters such as intensity, field of view and field of high resolution. This user interface can be either controls for user input or based on the distance to the target area or both.

5 ***Telemedicine***

The use of robots to provide fine control of surgical tools is well known in the art. In United States Patent 7155316, a robot system for use in surgical procedures is described. In United States Patent 7158859, a mobile robot that provides the ability to remotely control the robot and to see the patient, the patient surroundings and the tools in use is described.

10 In a normal patient encounter for venipuncture, the practitioner would use several senses to locate a vein and then to perform venipuncture. This would include looking for both visible and tactile indicators of the vein position. The invention enhances the visible feedback of the position of the veins. By using the visual position enhancement, the ability to use a tele-robot to perform venipuncture is enhanced.

15 The vein scanner engine can be integrated into one of these robots so that the scanning/projection field is positioned in alignment with the end of a robotic arm which contains the needle or catheter for the venipuncture procedure. The engine can be mounted directly to the arm that contains the needle or it can be mounted to a separately controllable arm.

20 The engine can work in one of three modes. It can work as it normally does such that the acquisition of the vein pattern and the projection of the vein pattern is directly on the patient's skin. In this mode, the cameras that are already on the robot can view the pattern

on the skin and send that back to the remote operator on the screen that is already provided for the remote operator.

In a second mode, the detected vein pattern is captured and then rather than projecting the pattern back on to the patient, the pattern is sent to the remote practitioner and is shown to them on a screen. In this mode, there are several possible embodiments. One is that the pattern of veins can be overlaid on the video display of the patient's body. In this manner, what they see on the screen is very much like what they would see on the body. The advantage of this is that the image from the vein scanner can be enhanced and made brighter than it would be in the first mode.

In a third mode, a combination of the first two modes can be used that allows the practitioner to switch between the modes or for both modes to be used simultaneously on two different screens or windows on a single screen.

Referring to figure 7a and b, a robotic control system 1204 is shown with a controllable articulated arm 1200 holding a medical device 1205. The remote medical practitioner 1207 uses a corresponding control system 1206 to move the arm 1200 and the medical device 1205 to perform a medical procedure on the patient 1201. The remote system 1206 has a display 1208 that the practitioner uses to view the patient 1201 and the action of the medical device 1205. Typically this is performed by a camera mounted to the medical device 1205 or to the arm 1200. Our invention adds a vein scanner device 1202 to either the medical device 1205 or the arm 1200. The vein scanner is arranged in such a way that the scanned area overlaps in a known orientation with the medical device. In a preferred embodiment the medical device is a syringe and the enhanced vein pattern is used to properly position the syringe for venipuncture. The invention enables this by either projecting the pattern on the patient's body such that it is viewed by the camera and seen by the practitioner

on the remote display 1208 or alternatively a second display is mounted along with the camera display 1208 so that a digital version of the vein pattern can be seen or alternatively a single display is used with the digital version of the vein pattern overlaid over the camera view of the patient.

5 ***Non contact photoplethysmography***

Pulse oximetry is a non-invasive method of measuring arterial oxygen saturation. The use of an infrared light source and a red light source along with a photo detector in a finger clip arrangement to measure pulse and oxygen levels in blood are well known in the art. The basis for the measurement is the differential absorption between oxygenated hemoglobin and non-oxygenated hemoglobin of the two different wavelengths of light. The traditional
10 technique for performing this measurement requires contact with the body and relies on the transmission of the light through an area of the body with a small cross section such as a finger or an earlobe. By alternating between the red and infrared light sources and measuring the level of the light that is passed through a body part, a waveform that is know as a
15 photoplethysmograph (PPG) is captured. Through signal processing techniques that are well known in the art, oxygenation levels and pulse rates can be calculated.

Several articles and patents have been published that use non-contact techniques to measure the necessary waveforms by replacing the photo detector with a remote device such as a CMOS camera. US Patent 6,491,639 describes the use of a light sources and the photo
20 detector in the same plane eliminating the need for a small cross section part of the body to be used for measurement of the necessary waveforms. This design relies on the internal reflections of the body such that the light is directed in to the body and then reflected out of the body rather than completely passing through a small cross section portion of the body.

In the article by Humphreys, K. et al, "A CMOS Camera-Based Pulse Oximetry Imaging System." Proceedings of the 2005 IEEE Engineering in Medicine and Biology 27th Annual Conference (2005). 7 Feb. 2007, they describe a non-contact pulse oximetry system that uses a CMOS camera as the detector. In this design, the detector is held at a distance
5 from the body and a bounding box is selected in the captured image. The average intensity of the bounding box is used as a proxy of the photo detector value that would be found in a contact pulse oximeter. By plotting the changing value of the average intensity of that location over time a PPG is derived that can be used to measure oxygenation and pulse using the same techniques as previously described.

10 Our micro vein enhancer invention uses scanned lasers to capture a pattern of veins below the surface of the skin and then re-projects a vein pattern image directly back on to the body. In one embodiment those laser light sources are visible red for projecting the image and infrared for detecting the veins. The vein detection relies on absorption characteristics that are related to those used in pulse oximetry in that the infrared light is absorbed
15 differentially by hemoglobin than surrounding tissues.

Furthermore, we have previously described how a micro vein enhancer can be used to capture images based on the light transmitted by the lasers and reflected back to the micro vein enhancer's photo detector circuitry. Through the combination of these techniques, a miniature vein enhancer can be extended to read pulse and oxygen levels without contact
20 with the patient.

Referring to Figure 6a, view of the body surface 1150 is being illuminated by the scanning laser pattern 1160. Since information must be collected separately from each laser wavelength, a mechanism is required for the system to differentiate the reflected energy from each laser. One mechanism is to use optical filters and two photo detectors, each responsive

to only one of the lasers. Another mechanism is to polarize the lasers so that two photo detectors, each sensitive to only one of the laser's polarization.

A further mechanism is to project using both the visible red and infrared lasers in an alternating pattern. The alternation can be handled in multiple ways. Possibilities include the
5 lasers time sliced so that short pulses of each laser are alternated while the laser scans. Alternatively, the lasers can be switched between scan lines with right to left with one laser and left to right with the other laser. Alternately, the lasers can be switched on some multiple of scan lines or on alternate complete passes of the scan area.

Referring to Figure 6b, a part of the body 1153 is illuminated by the scanning laser
10 pattern 1154 from the vein enhancer. Portions of the laser light are reflected and absorbed off different structures of the body. The portion that is reflected 1155 is measured by the photo detector of vein enhancer. The laser projects a point source on to the body. Therefore the reflected signal is characteristic of a small area of the body. Since the PPG
needs to be representative of both venous and arterial blood, the small point source reflection
15 may be insufficient for detecting the PPG.

Referring back to Figure 6a, the scanned area 1160 is broken down in to a number of smaller areas (e.g., 1151/1152) that are sized to capture a large enough area of the body such that an adequate PPG can be detected. The system can dynamically change the size of the smaller areas such that they are sufficiently large to obtain an adequate return signal regardless
20 of the distance of the scanner from the body. The system then averages the returned signal from all of the pixels in the smaller areas and records the values. By keeping track of these values for the same location, over time, a PPG is generated.

Since the preferred embodiment is a handheld device, the motion of the device in relation to the patient must be allowed for. In the simplest embodiment, since the device is

breaking the scan area down into a series of subsections and generating the PPG from the subsections and there would be similar return signals from these subsections, the motion can be ignored. However, if the motion becomes too severe or if the area being imaged is heterogeneous, then the system can use digital or optical image stabilization well known in the art to maintain alignment from frame to frame. An alternative method would be to keep PPGs from all of the subsections, then as the hand moves, the system would use the PPG from areas that still remain in view.

Non Contact Pulse Measurement

Many commercially available exercise machines such as treadmills and bicycles provide the capability to measure pulse rate. Knowledge of the current pulse rate is very valuable for managing exercise intensity. One commonly seen embodiment relies on hand contact with electrodes that are used to measure heart rate. In many situations, such as running, it is difficult or dangerous to maintain contact with the electrodes. Another common embodiment uses a chest strap that measures heart rate and then wirelessly transmits it to the exercise machine so that the value can be displayed. This requires that the user acquire this separate device in order for pulse rate to be displayed. In a preferred embodiment of the invention, a capture only scan engine is mounted in proximity to the user such that the scanning pattern is oriented such that it strikes an uncovered portion of the body such as the hands, arms, neck or face. As described previously, the PPG waveform can be captured and the pulse rate can be fed back into the exercise machine and displayed to the user.

Referring to figure 8, a person is shown exercising on a treadmill. A typical treadmill is composed of the bed 1305 which houses a moving belt, an upright 1302 at the front of the

treadmill and a combination control panel, display panel and handle at 1303. The invention needs access to bare skin and therefore needs to be mounted in proximity to typically uncovered locations such as the legs 1310, the arms 1309 or the neck 1312 and head 1308. In addition, to normally uncovered body parts during exercise, in some embodiments it would be desirable for the torso 1313 to be bare or for a shirt made from materials that are transparent to the wavelength of the scanning light to be worn. Various embodiments of the invention can have at one or more of locations including a laser scanner engine 1304 mounted on the treadmill upright 1302, or an engine mounted in the display panel 1303. In addition, an additional upright 1307 can be added to the treadmill to allow for a scanner engine 1306 to be mounted above the standard parts of the treadmill. Given that the person will typically be moving, it is preferred that the scanner target a part of the body that moves the least. Therefore, the preferred embodiment would target the upper part of the body rather than the legs or the arms. Given that the pulse measurement application requires much lower resolution than the projector application described elsewhere, the full travel of the moving mirror can be used to steer the measurement zone over a fairly wide range of locations. This agility provides two benefits. One, the beam can be steered to the general desired location and the beam can be moved in synchrony with the movement of the body during exercise. Beam positions 1300, 1311 and 1301 show nominal center points for the beam. However, they can be steered in real time as desired within the general area of the center point.

Claims:

1. A handheld vein enhancer comprising
a means for projecting light on a target area of a patient's skin,
a means for capturing an image of said target area,
a means for projecting said captured image over the area of capture in the form of a visible representation of at least one vein,
a means for projecting data onto said target area where the type of data projected by said projection means is capable of varying.
2. The vein enhancer according to claim 1 wherein means for projecting light projects laser light.
3. The vein enhancer according to claim 1, wherein said data is data about the patient.
4. The vein enhancer according to claim 2, wherein said data is in the form of text and/or icons.
5. The vein enhancer according to claim 1, wherein said data is diagnostic data.
6. The vein enhancer according to claim 3 wherein said patient data is information on vein depth.
7. The vein enhancer according to claim 3 wherein said patient data includes a patient identification.
8. The vein enhancer according to claim 1 wherein said data is information concerning the process to be performed.
9. The vein enhancer according to claim 2 wherein the data includes information on the status of the vein enhancer.

10. The vein enhancer according to claim 1 wherein relative information concerning the depth of a vein is shown on said target area.
11. The vein enhancer according to claim 1 wherein the relative depth of said vein is shown by the size of a line projected on said target area.
12. The vein enhancer according to claim 11 wherein said line is projected onto the vein.
13. The vein enhancer according to claim 11 wherein the line is projected in a color different than the color of said vein.
14. The vein enhancer according to claim 11 wherein said line varies in intensity depending on a vein's properties.
15. The vein enhancer according to claim 1 wherein size bars are projected in proximity to said vein.
16. The vein enhancer according to claim 1 wherein said vein enhancer further comprises an otoscope.
17. The vein enhancer according to claim 2 further comprising a means for projecting visible light.
18. The vein enhancer according to claim 2 wherein there are multiple lasers.
19. The apparatus according to claim 2 wherein the image projected onto said target area has higher resolution in a first portion of the target area than in a second portion of the target area.
20. The apparatus according to claim 19 wherein a drive circuit of said projecting means

can vary the amplitude of said drive circuit so that a mirror used to project said image moves less quickly on said first portion.

21. A process for obtaining blood comprising
verifying the identity of a user/practitioner,
verifying the identity of a patient,
providing to the user, data on the procedure to be performed,
using a vein scanner to find a vein,
performing a venipuncture.

22. The process according to claim 21 further comprising the additional step of verifying that the venipuncture has been completed.

23. The process according to claim 22 further comprising prompting a user to continue in the event the venipuncture is not completed.

24. The process according to claim 21 wherein the process further comprises the additional step of updating patient records.

25. The process according to claim 21 wherein verification of said user includes comparing one or more identifiers to a database of valid users.

26. The process according to claim 21 further comprising the step of verifying that the appropriate equipment is on hand prior to commencing venipuncture.

27. The process according to claim 26 wherein said user is prompted to continue gathering equipment until all the appropriate equipment has been identified.

28. The process according to claim 21 herein a user is prompted to fill additional vials during a venipuncture if all of the vials required to be filled have not been filled.

29. The process according to claim 21 further comprising the step of identifying the position of a needle used in said venipuncture.
30. The process according to claim 21 wherein a graphic image is projected on said vein to guide a user to a vein center.
31. The process according to claim 21 wherein a line detection algorithm is used to determine edge boundaries of said vein.
32. The process according to claim 21 wherein image processing software is used to determine vein depth.
33. The process according to claim 21 wherein a bar code is projected onto said target area.
34. An apparatus for obtaining blood comprising
a means for verifying the identity of a user/practitioner,
a means for verifying the identity of a patient,
a means for providing to the user data on the procedure to be performed, and
a vein scanner for finding a vein.
35. The apparatus according to claim 34 wherein said vein scanner includes a means for performing a venipuncture.
36. The apparatus according to claim 35 wherein said apparatus includes a means for verifying that the venipuncture has been completed.
37. The apparatus according to claim 36 wherein said apparatus includes a means for updating patient records.

38. The apparatus according to claim 34 wherein at least one means for verifying includes a key pad.

39. The apparatus according to claim 34 wherein at least one means for verifying includes a token reader.

40. The apparatus according to claim 39 wherein said token reader is a smart card reader.

41. The apparatus according to claim 39 wherein said token reader has an RFID reader.

42. The apparatus according to claim 34 wherein at least one means for verifying includes a biometric reader.

43. The apparatus according to claim 42 wherein said biometric reader reads vein patterns.

44. The apparatus according to claim 42 wherein said biometric reader reads facial patterns.

45. The apparatus according to claim 42 wherein said biometric reader includes voice recognition.

46. The apparatus according to claim 34 wherein one or more identifiers are used for verification.

47. An apparatus for projecting an enhanced image of a patient's vein pattern onto said patient so that a user can perform a venipuncture on said patient, said apparatus comprising a means for communicating with one or more patient data collection devices.

48. The apparatus according to claim 47 wherein said patient data can be projected onto said patient.

49. The apparatus according to claim 47 wherein said means for communicating can communicate with remote computer
50. The apparatus according to claim 49 wherein said means for communicating uses an RF connection
51. The apparatus according to claim 49 wherein said means for communicating uses a wired connection
52. The apparatus according to claim 49 wherein said means for communicating uses an optical connection
53. The apparatus according to claim 2 wherein said data, is previously stored data.
54. A handheld vein enhancer comprising
a means for projecting light on a target area of a patient's skin,
a means for capturing an image of said target area,
a means for projecting said captured image over the area of capture in the form of a visible representation of at least one vein,
a means for projecting data onto a surface where the type of data projected by said projection means is capable of varying.
55. The apparatus according to claim 54 wherein patient data and vein data are projected onto said surface
56. The apparatus according to claim 2, wherein the position of a vein image on the target area and a needle are compared
57. The apparatus according to claim 56, wherein information is projected to the user to correct the needle position if necessary
58. The apparatus according to claim 1 wherein there is a second source of light for projecting onto said target area
59. The apparatus according to claim 58, wherein the second source of light is one or more lasers
60. The apparatus according to claim 1 further comprising a means for using scanned lasers to measure pulse rate
61. The apparatus according to claim 1 further comprising a means for using scanned lasers to measure blood oxygen levels
62. The apparatus according to claim 60, which is integrated into exercise equipment.

63. The apparatus according to claim 61, which is integrated into exercise equipment
64. The apparatus according to claim 62, that further displays said data on a display on said equipment
65. The apparatus according to claim 61, that further displays said data on a display on said equipment
66. A vein position detection device according to claim 1 which is integrated into a robotic system
67. The apparatus according to claim 65, which can be operated by a remote operator
68. The apparatus according to claim 66, which can be operated by a remote operator
69. The apparatus according to claim 68, where the vein pattern is shown to the remote operator
70. The apparatus according to claim 69, where the vein pattern is shown to the remote operator via a video showing the reprojected pattern on the patient
71. The apparatus according to claim 70, wherein the vein pattern is shown to the remote operator via a data connection to a screen in view of the remote operator

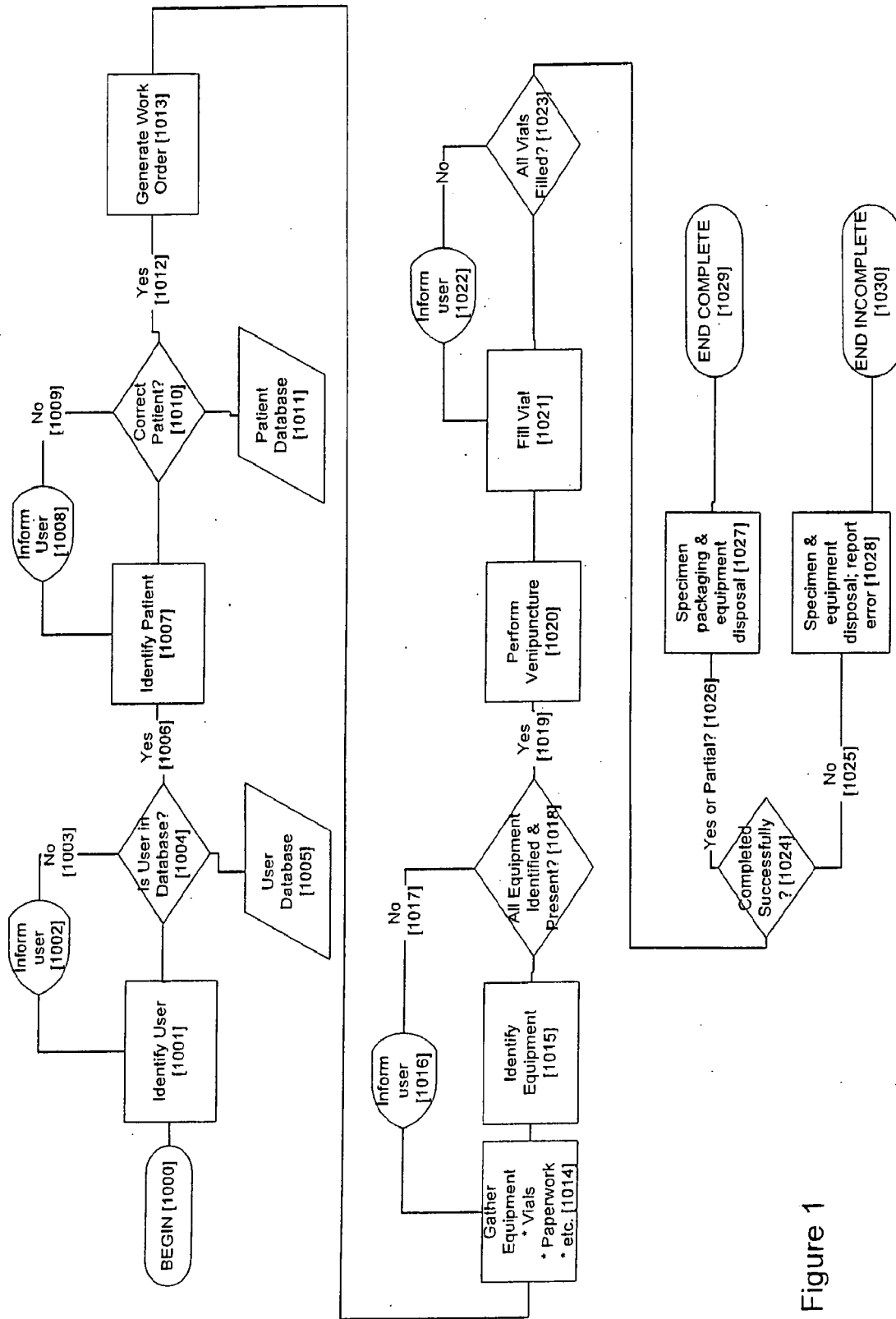

Figure 1

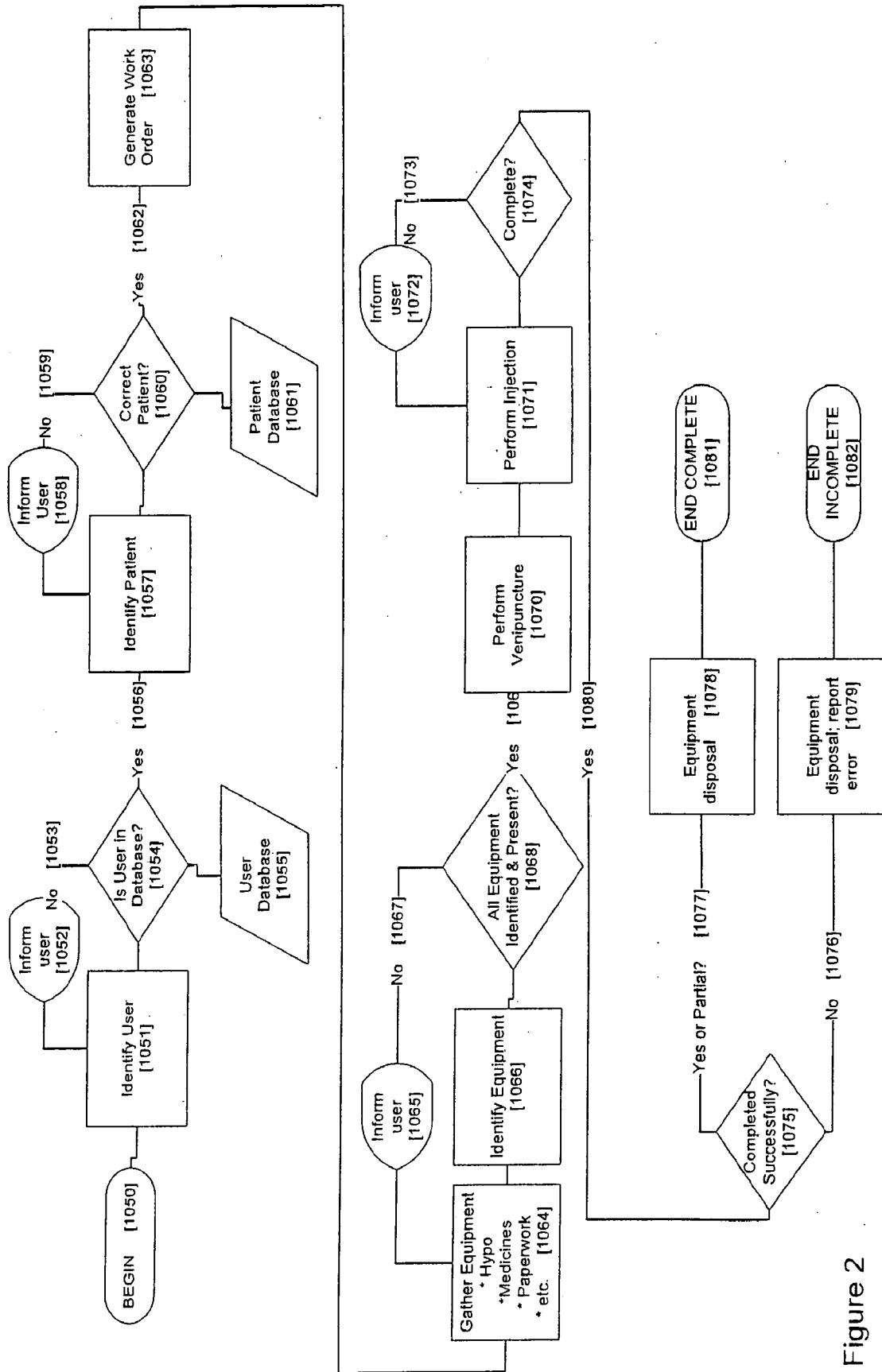















Figure 2



Test Symbols

Hand Held Products' 2D Imagers omni directionally read Linear, Stacked, Matrix, Composite and Postal barcode symbols, plus OCR!





Linear Barcodes

Code 39  A B C 1 2 3	Codabar  A 1 2 3 4 5 6 7 8 B	UPC-A  12345 67890 6
Interleaved 2/5  1 2 3 4 5 6 7 8 9 0 1 2 3 4	RSS-14  (01)5512345678901(2)	UPC-E  0 012345 7
Code 128 / EAN 128  0 1 2 3 4 5 6 7 8 9 0	RSS Limited  (01)1234567890123(1)	EAN-8  0123 4565
Code 93 / 931  A B C 1 2 3 4 5	RSS Expanded  (01)9881234567890(8)	EAN-13 / Bookland  9 781234 567897

03032005



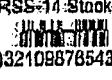

1D
Pattern

Stacked Barcodes

Micro PDF417  (37 characters)	PDF417  (38 characters)	RSS-14 Stacked  (01)3210987654321(1)
RSS Expanded Stacked  (01)5512345678901(2)1599123		



2D
Pattern

Matrix Barcodes

Data Matrix  (43 characters)	Aztec Code  (243 characters)	QR Code  (39 characters)	Maxicode  (40 characters)
--	--	--	--

2D
Pattern

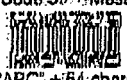
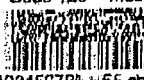
Composite Barcodes

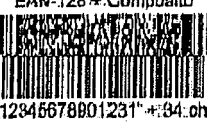
Code 39 + Mesa  *ABC* + 64 chars	Code 128 + Mesa  *12345678* + 65 chars	RSS Limited + Composite  (01)12345678901231* + 38 chars	EAN-128 + Composite  10112345678901231* + 84 chars
--	--	---	---

2D
Pattern

OCR-A

00001234

OCR-B

32478450

Postal Codes

Postnet



BPO-4 State

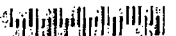

Figure 3

[1100] Next OK bp:110/50

[1101]    

[1102]  37.0°  38.3°  35.9°

Figure 4

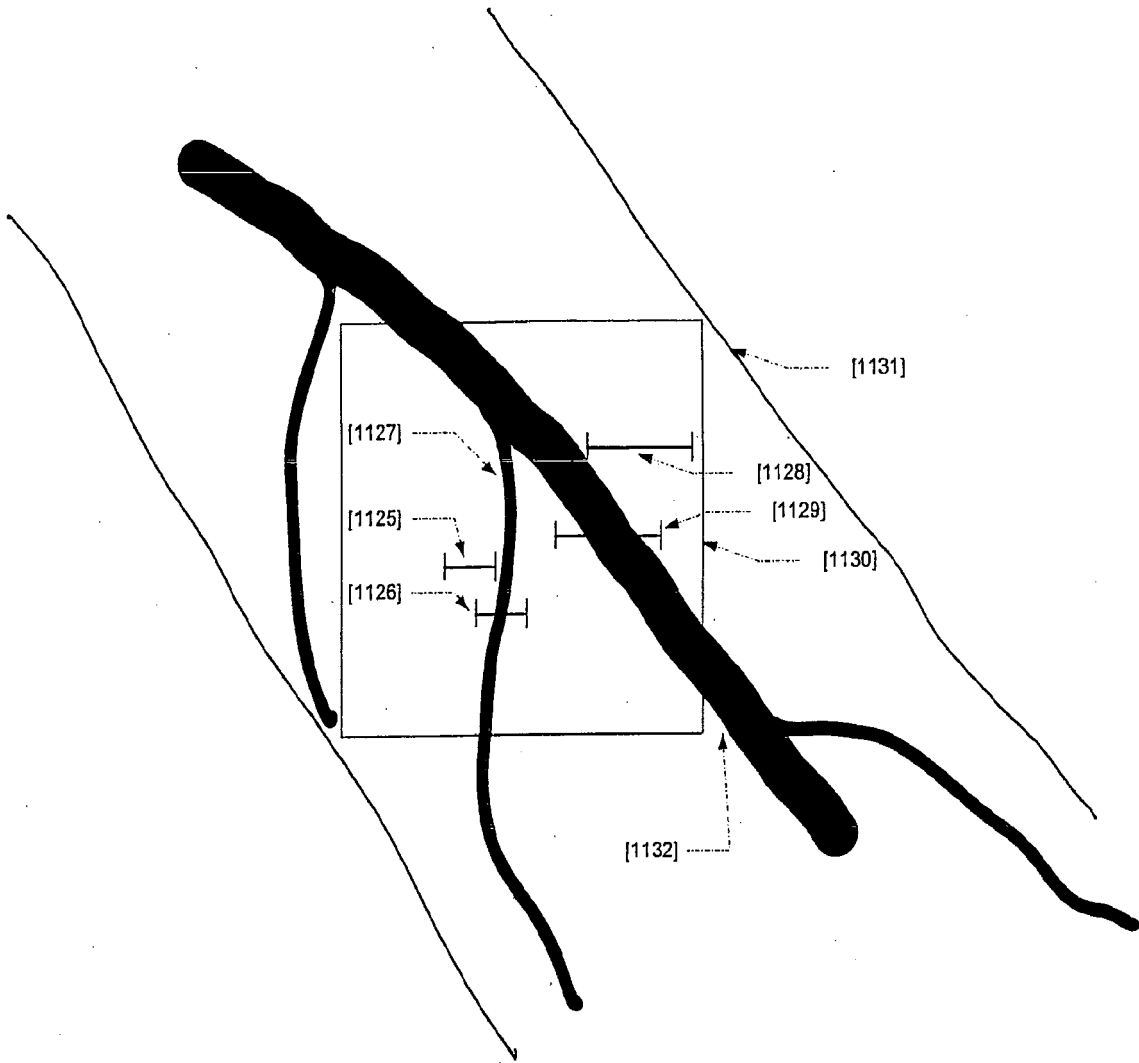

Figure 5

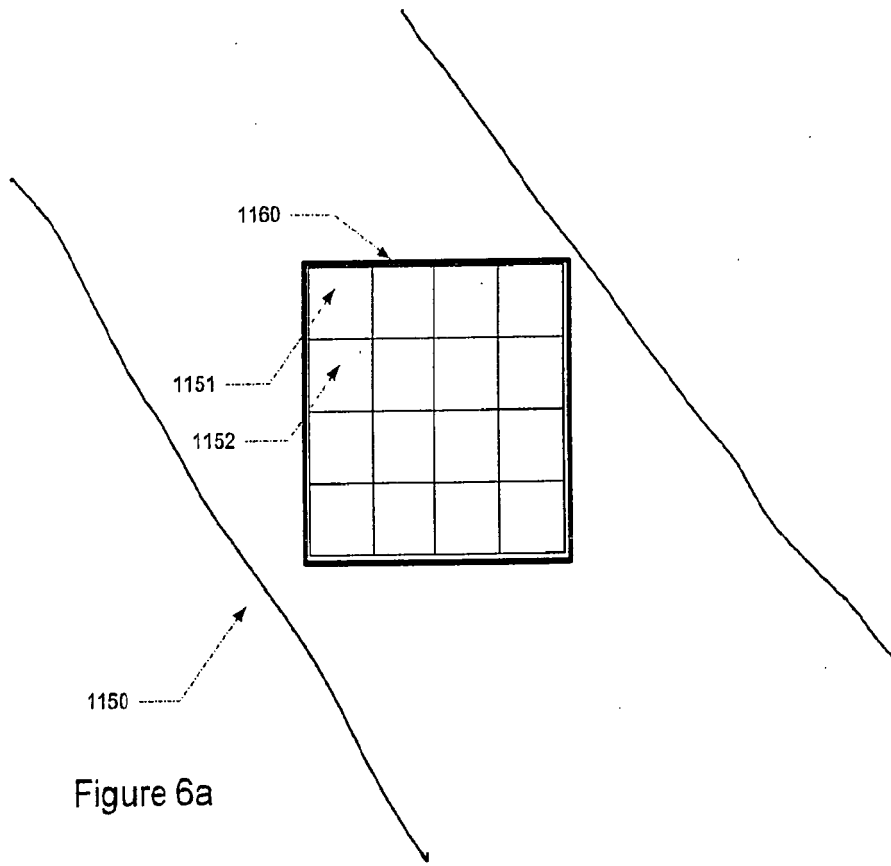

Figure 6a

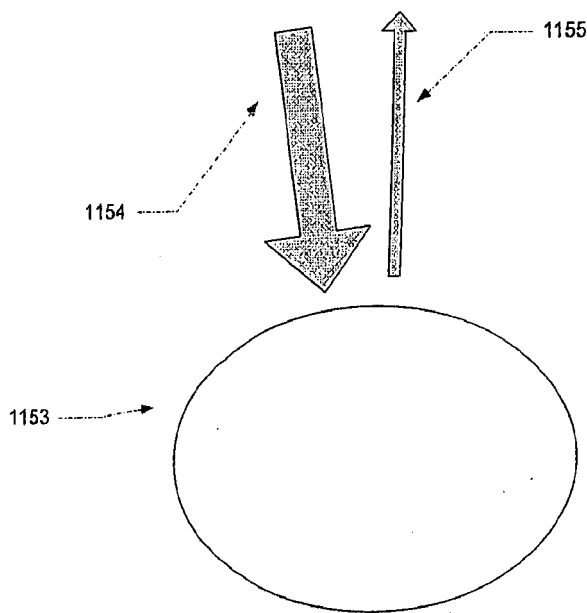

Figure 6b

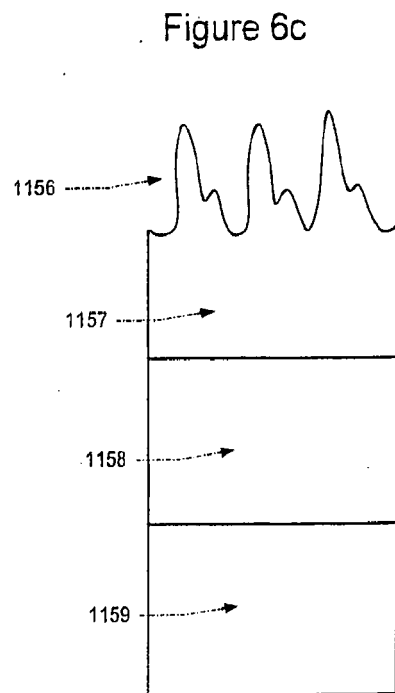

Figure 6c

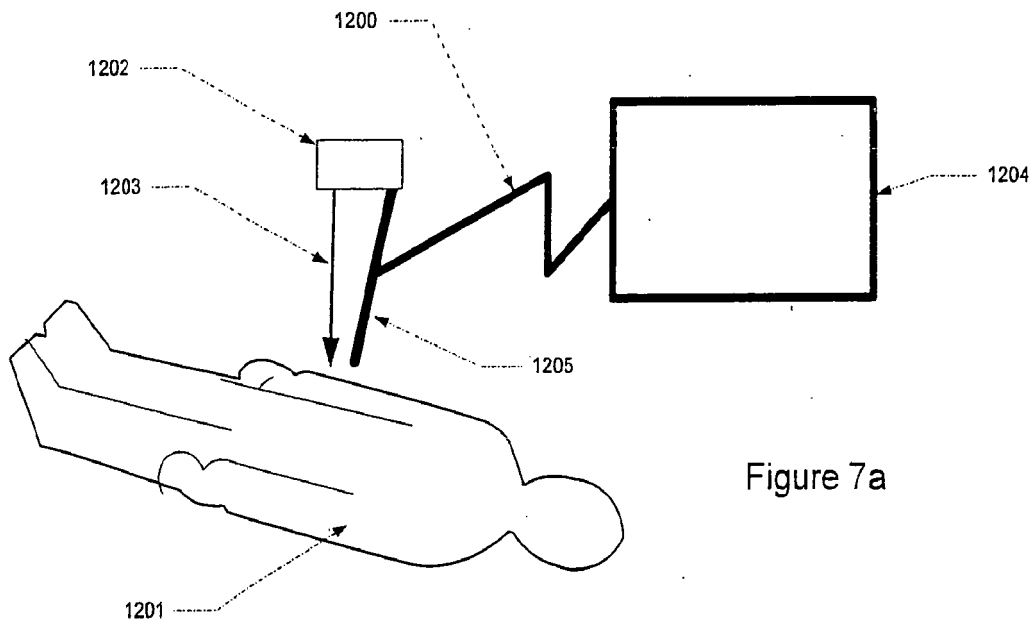

Figure 7a

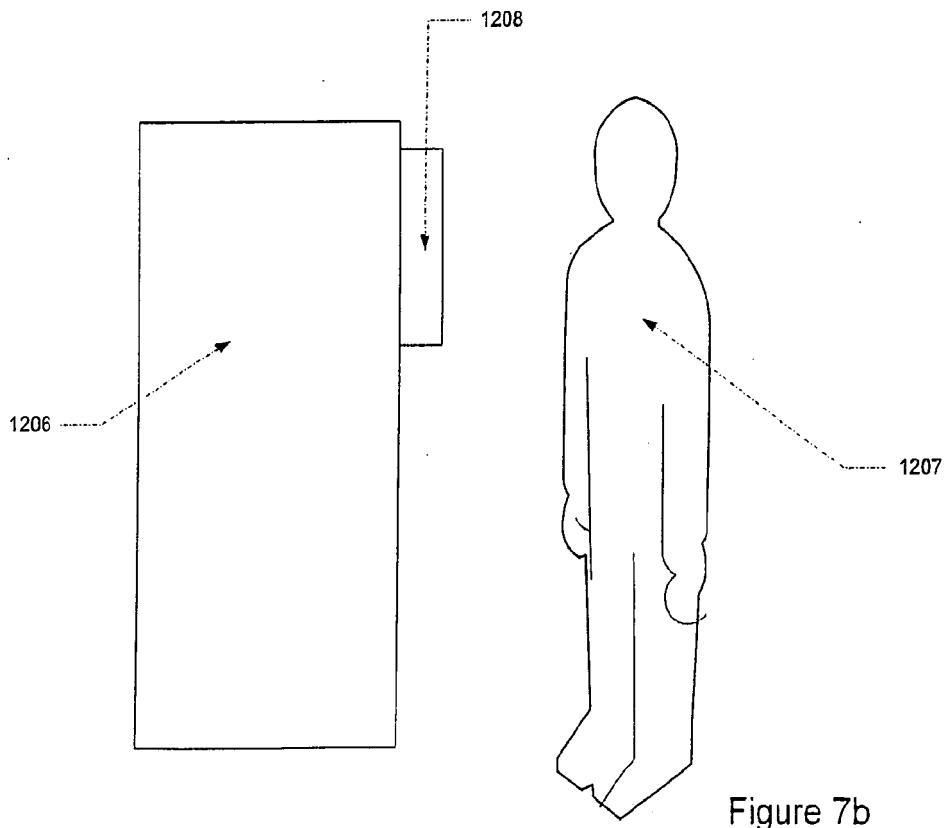

Figure 7b

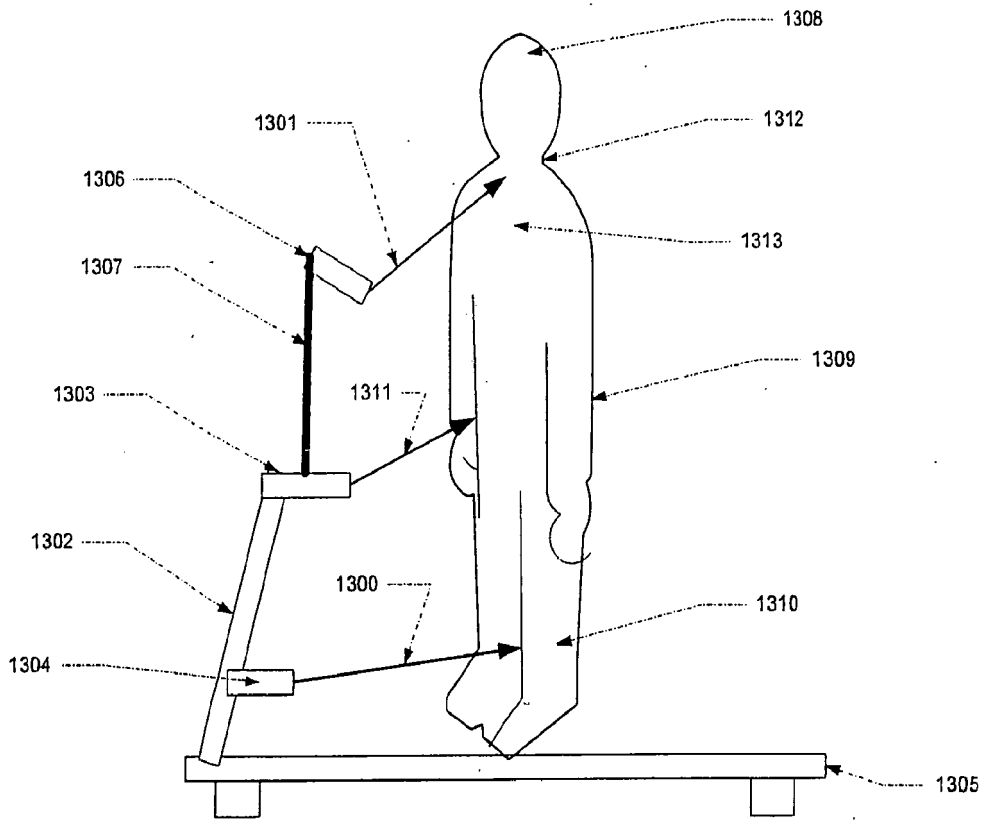

Figure 8

专利名称(译)	增强激光静脉对比增强剂		
公开(公告)号	EP2124728A4	公开(公告)日	2011-11-09
申请号	EP2007868095	申请日	2007-12-28
[标]申请(专利权)人(译)	活力灯		
申请(专利权)人(译)	VENOUS LIGHT , LLC		
当前申请(专利权)人(译)	VENOUS LIGHT , LLC		
[标]发明人	WOOD FRED GOLDMAN RON CONLON STEPHEN P LUCIANO VINCENT		
发明人	WOOD, FRED GOLDMAN, RON CONLON, STEPHEN, P. LUCIANO, VINCENT		
IPC分类号	A61B5/00 A61B6/00 A61M5/42		
CPC分类号	A61B5/0059 A61B5/024 A61B5/15003 A61B5/150748 A61B5/150786 A61B5/153 A61B5/489 A61B5/7495 A61B90/98 A61M5/427 A61B5/0064 A61B5/0082 A61B5/02416 A61B5/1172 A61B5/1176 A61B5/150343 A61B5/4839 A61B5/72 A61B2576/00 A61M2205/276 A61M2205/50 A61M2205/52 A61M2205/609		
优先权	60/898506 2007-01-31 US 11/700729 2007-01-31 US 11/807359 2007-05-25 US		
其他公开文献	EP2124728A2		
外部链接	Espacenet		

摘要(译)

本领域已知使用一种装置来增强患者静脉和动脉的视觉外观，以便于将针插入那些静脉和动脉中。该申请公开了许多发明，其将附加的数据收集和呈现能力添加到手持式静脉增强装置和用于收集血液和使用手持式装置来介导该过程的IV药物的递送的一组过程。