

(19)



(11)

EP 2 348 959 B1

(12)

EUROPEAN PATENT SPECIFICATION

(45) Date of publication and mention of the grant of the patent:
19.09.2018 Bulletin 2018/38

(51) Int Cl.:
A61B 5/00 (2006.01)

(21) Application number: **09749275.5**

(86) International application number:
PCT/US2009/062829

(22) Date of filing: **30.10.2009**

(87) International publication number:
WO 2010/051479 (06.05.2010 Gazette 2010/18)

(54) SYSTEM FOR FACILITATING OBSERVATION OF MONITORED PHYSIOLOGIC DATA

SYSTEM ZUR EINFACHEREN BEOBACHTUNG VON PHYSIOLOGISCHEN MESSERGEBNISSEN
SYSTÈME POUR FACILITER L'OBSERVATION DE DONNÉES PHYSIOLOGIQUES MONITORÉES

(84) Designated Contracting States:
AT BE BG CH CY CZ DE DK EE ES FI FR GB GR HR HU IE IS IT LI LT LU LV MC MK MT NL NO PL PT RO SE SI SK SM TR

- **AMUNDSON, Scott**
Oakland
California 94602 (US)
- **BRECHT, Mark**
Imperial Beach
California 91932 (US)

(30) Priority: **31.10.2008 US 110259 P**
30.10.2009 US 609314

(43) Date of publication of application:
03.08.2011 Bulletin 2011/31

(74) Representative: **Kinsler, Maureen Catherine et al**
Marks & Clerk LLP
40 Torphichen Street
Edinburgh EH3 8JB (GB)

(73) Proprietor: **Covidien LP**
Mansfield, MA 02048 (US)

(56) References cited:
WO-A2-2006/076498 US-A1- 2008 076 977
US-A1- 2008 097 175 US-A1- 2008 221 418

(72) Inventors:
• **BATCHELDER, Keith**
New York
New York 10001 (US)

EP 2 348 959 B1

Note: Within nine months of the publication of the mention of the grant of the European patent in the European Patent Bulletin, any person may give notice to the European Patent Office of opposition to that patent, in accordance with the Implementing Regulations. Notice of opposition shall not be deemed to have been filed until the opposition fee has been paid. (Art. 99(1) European Patent Convention).

Description

BACKGROUND

5 **[0001]** The present disclosure relates generally to user-interface applications for patient monitoring devices. In particular, present embodiments relate to display features that facilitate observation of monitored physiological data with patient monitoring instruments. This section is intended to introduce the reader to various aspects of art that may be related to various aspects of the present disclosure, which are described and/or claimed below. This discussion is believed to be helpful in providing the reader with background information to facilitate a better understanding of the various aspects of the present disclosure. Accordingly, it should be understood that these statements are to be read in this light, and not as admissions of prior art.

10 **[0002]** Patient monitors include medical devices that facilitate measurement and observation of patient physiological data. For example, pulse oximeters are a type of patient monitor. A typical patient monitor cooperates with a sensor to detect and display a patient's vital signs (e.g., temperature, pulse rate, or respiratory rate) and/or other physiological measurements (e.g., water content of tissue, or blood oxygen level) for observation by a user (e.g., clinician). For example, pulse oximeters are generally utilized with related sensors to detect and monitor a patient's functional oxygen saturation of arterial hemoglobin (i.e., SpO₂) and pulse rate. Other types of patient monitors may be utilized to detect and monitor other physiological parameters. The use of patient monitors may improve patient care by facilitating supervision of a patient without continuous attendance by a human observer (e.g., a nurse or physician).

15 **[0003]** A patient monitor may include a screen that displays information relating to operation and use of the patient monitor. A typical patient monitor screen may display patient data for further interpretation by a user. For example, a pulse oximetry monitor may display data in the form of a plethysmographic waveform or in the form of a numeric index, such as an oxygen saturation value. However, while a monitor may convey information to a user about the patient's condition, such information may be difficult to interpret quickly.

20 **[0004]** US 2008/097175 describes a monitoring system configured to receive input relating to patient physiological parameters, which includes a display control feature configured to automatically find and display on a screen an event in historical data when the display control feature is activated. US 2008/0076977 describes a monitoring system that includes a snapshot display feature configured to display a snapshot view on a screen, wherein the snapshot view includes fixed or stabilised graphical features that correspond to measurements of patient physiological parameters. US2008/0221418 describes a handheld multi-parameter patient monitor capable of determining multiple physiological parameters from the output of a light sensitive detector capable of detecting light attenuated by body tissue. WO 2006/076498 describes a multi-parametric vital signs monitoring device configured to use as an ambulatory and a bedside monitor.

25 **BRIEF DESCRIPTION OF THE DRAWINGS**

[0005] Advantages of present embodiments may become apparent upon reading the following detailed description and upon reference to the drawings in which:

- 40 FIG. 1 is a perspective view of an exemplary patient monitor;
- FIG. 2 is a perspective view of the exemplary patient monitor in a system with separate devices;
- 45 FIG. 3 is a representation of an exemplary display including a trend of physiological data that exhibits a detected pattern;
- FIG. 4 is an exemplary block diagram of an electronic device;
- 50 FIG. 5 is an exemplary graph of SpO₂ trend data with an upper band and lower band based on mean and standard deviation values;
- FIG. 6 is an exemplary graph including an SpO₂ trend that contains a ventilatory instability SpO₂ pattern and a trend of the resulting saturation pattern detection index;
- 55 FIG. 7 is an exemplary display including a graphical indicator related to ventilatory instability;
- FIG. 8 is an exemplary display including a graphical indicator related to ventilatory instability;

FIG. 9 is an exemplary display including a graphical indicator related to ventilatory instability;

FIG. 10 is an exemplary display including a graphical indicator related to ventilatory instability;

5 FIG. 11 is an exemplary display including a graphical indicator related to ventilatory instability;

FIG. 12 is an exemplary display including a graphical indicator related to ventilatory instability;

10 FIG. 13 is an exemplary display including a graphical indicator related to ventilatory instability;

FIG. 14 is an exemplary display including a graphical indicator related to ventilatory instability;

FIG. 15 is an exemplary display including a graphical indicator related to ventilatory instability;

15 FIG. 16 is an exemplary display including a graphical indicator related to ventilatory instability;

FIG. 17 is an exemplary display of a menu related to alarm management and settings for alarms related to ventilatory instability;

20 FIG. 18 is an exemplary display of a menu related to alarm management and settings for alarms related to ventilatory instability;

FIG. 19 is an exemplary display of a menu related to alarm management and settings for alarms related to ventilatory instability; and

25

FIG. 20 is an exemplary flow chart of a process for alarm management for alarms related to ventilatory instability.

DETAILED DESCRIPTION

30 **[0006]** One or more specific embodiments of the present disclosure will be described below. In an effort to provide a concise description of these embodiments, not all features of an actual implementation are described in the specification. It should be appreciated that in the development of any such actual implementation, as in any engineering or design project, numerous implementation-specific decisions must be made to achieve the developers' specific goals, such as compliance with system-related and business-related constraints, which may vary from one implementation to another. 35 Moreover, it should be appreciated that such a development effort might be complex and time consuming, but would nevertheless be a routine undertaking of design, fabrication, and manufacture for those of ordinary skill having the benefit of this disclosure.

[0007] Present embodiments facilitate observation of certain events (e.g., SpO₂ patterns) displayed on a monitor's user-interface by providing graphic indicators that relate to the status of certain features. Further, present embodiments 40 include one or more graphic features that are actively representative of a status of pattern detection or a level (e.g., a percentage of an alarm level) of a detected occurrence. Such graphic features provide an active representation of a gradual build up of indicators that correspond to identification of a particular pattern or that are indicative of a severity level of an identified condition. Indeed, present embodiments utilize an accumulation of data indicators to identify a physiologic pattern or a severity level of a particular event, and the graphic feature gradually changes as observed 45 indications accumulate. For example, in accordance with embodiments, ventilatory instability may be detected when a number of certain data features have been detected within a time period. Thus, a percentage value associated with ventilatory instability detection may be identified by dividing the number of detected data features by the number utilized for identification of a ventilatory instability pattern, and the percentage may be represented in a dynamic graphic (e.g., a status bar). As a specific example, a graphic displayed as a triangle outline gradually fills in the triangle outline from 50 the bottom as certain indicators of a particular pattern accumulate. Thus, the triangle graphic may be completely filled in when the pattern is actually confirmed. Likewise, the triangle may empty when certain aspects are reduced. Similarly, a graphic may gradually fill or empty as certain severity thresholds or indexes of a particular event are reached.

[0008] FIG. 1 is a perspective view of a patient monitor 10 in accordance with an exemplary embodiment of the present disclosure. Specifically, the patient monitor 10 illustrated by FIG. 1 is a pulse oximeter that is configured to detect and 55 monitor blood oxygen saturation levels, pulse rate, and so forth. It should be noted that while the illustrated embodiment includes a pulse oximeter, other examples may include different types of patient monitors 10. For example, the patient monitor 10 may be representative of a vital signs monitor, a critical care monitor, an obstetrical care monitor, or the like.

[0009] The illustrated patient monitor 10 includes a front panel 12 coupled to a body 14 of the monitor 10. The front

panel **12** includes a display screen **16** and various indicators **18** (e.g., indicator lights and display screen graphics) that facilitate operation of the monitor **10** and observation of a patient's physiological metrics (e.g., pulse rate). Some of the indicators **18** are specifically provided to facilitate monitoring of a patient's physiological parameters. For example, the indicators **18** may include representations of the most recently measured values for SpO₂, pulse rate, index values, and pulse amplitude. In embodiments, the indicators **18** may include an indicator related to ventilatory instability. In an embodiment, the indicator **18** may be a triangular indicator that is related to an index of ventilatory instability determined by the monitor **10**. When the index increases, the triangle fills from bottom to top. In an embodiment, the indicator **18** may be a Sat Seconds indicator that provides an indication related to low oxygen saturation. Other indicators **18** may be specifically provided to facilitate operation of the monitor **10**. For example, the indicators **18** may include an A/C power indicator, a low battery indicator, an alarm silence indicator, a mode indicator, and so forth. The front panel **12** may also include a speaker **20** for emitting audible indications (e.g., alarms), a sensor port **22** for coupling with a sensor **24** (e.g., a temperature sensor, a pulse oximeter sensor) and other monitor features.

[0010] Additionally, the front panel **12** may include various activation mechanisms **26** (e.g., buttons and switches) to facilitate management and operation of the monitor **10**. For example, the front panel **12** may include function keys (e.g., keys with varying functions), a power switch, adjustment buttons, an alarm silence button, and so forth. It should be noted that in other embodiments, the indicators **18** and activation mechanisms **26** may be arranged on different parts of the monitor **10**. In other words, the indicators **18** and activation mechanisms **26** need not be located on the front panel **12**. Indeed, in some embodiments, activation mechanisms **26** are virtual representations in a display or actual components disposed on separate devices.

[0011] In some embodiments, as illustrated in **FIG. 2**, the monitor **10** may cooperate with separate devices, such as a separate screen **28**, a wireless remote **30**, and/or a keyboard **32**. These separate devices may include some of the indicators **18** and activation mechanisms **26** described above. For example, buttons **34** on the remote **30** and/or keyboard **32** may operate as activation mechanisms **26**. Specifically, for example, the buttons **34** may cause the monitor **10** to perform specific operations (e.g., power up, adjust a setting, silence an alarm) when actuated on the separate device. Similarly, the indicators **18** and/or activation mechanisms **26** may not be directly disposed on the monitor **10**. For example, the indicators **18** may include icons, indicator lights, or graphics on the separate screen **28** (e.g., a computer screen). Further, the activation mechanisms **26** may include programs or graphic features that can be selected and operated via a display. It should be noted that the separate screen **28** and/or the keyboard **32** may communicate directly or wirelessly with the monitor **10**.

[0012] **FIG. 3** is a representation of a display **180** that includes a trend **182** of oxygen saturation over time. As illustrated in **FIG. 3**, the monitor **10** may detect a cluster or pattern **184** of desaturation data, which the monitor **10** may determine is likely indicative of sleep apnea or some other issue. The monitor **10** may then label the pattern **184** with a textual graphic **186** and a timestamp **188** indicating a beginning and end of the detected pattern **184**. Further, the monitor **10** may highlight or flash the pattern, as indicated by block **190**, or utilize some other graphical indicator. In addition, the monitor may display an indicator that may provide information to a clinician that provides information that may be related to a patient condition. For example, the clinician may use present embodiments to simply snap or jump to a display including the pattern **184** (e.g., indication of sleep apnea or ventilation instability) by activating the display control feature (e.g., pressing a button), and the graphic indicators may draw the users attention to facilitate diagnosis.

[0013] In order to graphically or textually indicate the patterns in SpO₂ trend data (e.g., saturation patterns indicative of ventilatory instability), as discussed above, the patterns must first be detected. Accordingly, present embodiments may include code stored on a tangible, computer-readable medium (e.g., a memory) and/or hardware capable of detecting the presence of a saturation pattern in a series of physiologic data. For example, **FIG. 4** is a block diagram of an electronic device or pattern detection feature in accordance with present embodiments. The electronic device is generally indicated by the reference number **200**. The electronic device **200** (e.g., an SpO₂ monitor and/or memory device) may comprise various subsystems represented as functional blocks in **FIG. 4**. Those of ordinary skill in the art will appreciate that the various functional blocks shown in **FIG. 4** may comprise hardware elements (e.g., circuitry), software elements (e.g., computer code stored on a hard drive) or a combination of both hardware and software elements. For example, each functional block may represent software code and/or hardware components that are configured to perform portions of an algorithm. Specifically, in the illustrated embodiment, the electronic device **200** includes a reciprocation detection (RD) feature **202**, a reciprocation qualification (RQ) feature **204**, a cluster determination (CD) feature **206**, a saturation pattern detection index (SPDi) calculation feature **208**, and a user notification (UN) feature **210**. Each of these components and the coordination of their functions will be discussed in further detail below.

It should be noted that, in order to detect certain data patterns, embodiments of the present disclosure may utilize systems and methods such as those disclosed in U.S. Patent No. 6,760,608, U.S. Patent No. 6,223,064, U.S. Patent No. 5,398,682, U.S. Patent No. 5,605,151, U.S. Patent No. 6,748,252, U.S. Publication No 2006/235324A1 filed June 19, 2006, U.S. Publication No. 2006/155206 filed March 7, 2006, and U.S. Publication No. 2007/129647 A1 filed February 10, 2006. Accordingly, U.S. Patent No. 6,760,608, U.S. Patent No. 6,223,064, U.S. Patent No. 5,398,682, U.S. Patent No. 5,605,151, U.S. Patent No. 6,748,252.

[0014] The RD feature 202 may be capable of performing an algorithm for detecting reciprocations in a data trend. Specifically, the algorithm of the RD feature 202 may perform a statistical method to find potential reciprocation peaks and nadirs in a trend of SpO₂ data. A nadir may be defined as a minimum SpO₂ value in a reciprocation. The peaks may include a rise peak (e.g., a maximum SpO₂ value in a reciprocation that occurs after the nadir) and/or a fall peak (e.g., a maximum SpO₂ value in a reciprocation that occurs before the nadir). Once per second, the RD feature 202 may calculate a 12 second rolling mean and standard deviation of the SpO₂ trend. Further, based on these mean and standard deviation values, an upper band 220 and lower band 222 with respect to an SpO₂ trend 224, as illustrated by the graph 226 in FIG. 5, may be calculated as follows:

$$\text{Upper Band} = \text{mean} + \text{standard deviation};$$

$$\text{Lower Band} = \text{mean} - \text{standard deviation}.$$

[0015] Once the upper band 220 and lower band 222 have been determined, potential reciprocation peaks and nadirs may be extracted from the SpO₂ trend 224 using the upper band 220 and the lower band 224. Indeed, a potential peak may be identified as the highest SpO₂ point in a trend segment which is entirely above the upper band 220. Similarly, a potential nadir may be identified as the lowest SpO₂ point in a trend segment that is entirely below the lower band 222. In other words, peaks identified by the RD feature 202 may be at least one standard deviation above the rolling mean, and nadirs identified by the RD feature 202 may be at least one standard deviation below the mean. If there is more than one minimum value below the lower band 222, the last (or most recent) trend point may be identified as a nadir. If more than one maximum value is above the upper band 220, the point identified as a peak may depend on where it is in relation to the nadir. For example, regarding potential peaks that occur prior to a nadir (e.g., fall peaks) the most recent maximum trend point may be used. In contrast, for peaks that occur subsequent to a nadir (e.g., rise peaks), the first maximum point may be used. In the example trend data represented in FIG. 5, a peak and nadir is detected approximately every 30-60 seconds.

[0016] In one embodiment, a window size for calculating the mean and standard deviation may be set based on historical values (e.g., average duration of a set number of previous reciprocations). For example, in one embodiment, a window size for calculating the mean and standard deviation may be set to the average duration of all qualified reciprocations in the last 6 minutes divided by 2. In another embodiment, an adaptive window method may be utilized wherein the window size may be initially set to 12 seconds and then increased as the length of qualified reciprocations increases. This may be done in anticipation of larger reciprocations because reciprocations that occur next to each other tend to be of similar shape and size. If the window remained at 12 seconds, it could potentially be too short for larger reciprocations and may prematurely detect peaks and nadirs. The following equation or calculation is representative of a window size determination, wherein the output of the filter is inclusively limited to 12-36 seconds, and the equation is executed each time a new reciprocation is qualified:

```

If no qualified reciprocations in the last 6 minutes:
    Window Size = 12 (initial value)
else:
    RecipDur = ½ * current qualified recip duration + ½ * previous RecipDur
    Window Size = bound(RecipDur,12,36).
    
```

[0017] With regard to SpO₂ signals that are essentially flat, the dynamic window method may fail to find the three points (i.e., a fall peak, a rise peak, and a nadir) utilized to identify a potential reciprocation. Therefore, the RD feature 202 may limit the amount of time that the dynamic window method can search for a potential reciprocation. For example, if no reciprocations are found in 240 seconds plus the current adaptive window size, the algorithm of the RD feature 202 may timeout and begin to look for potential reciprocations at the current SpO₂ trend point and later. The net effect of this may be that the RD feature 202 detects potential reciprocations less than 240 seconds long. Once potential peaks and nadirs are found using the RD feature 202, the RQ feature 204 passes the potential reciprocations through one or more qualification stages to determine if a related event is caused by ventilatory instability. A first qualification stage may include checking reciprocation metrics against a set of limits (e.g., predetermined hard limits). A second qualification stage may include a linear qualification function. In accordance with present embodiments, a reciprocation may be required to pass through both stages in order to be qualified.

As an example, in a first qualification stage, which may include a limit-based qualification, four metrics may be calculated for each potential reciprocation and compared to a set of limits. Any reciprocation with a metric that falls outside of these limits may be disqualified. The limits may be based on empirical data. For example, in some embodiments, the limits

may be selected by calculating the metrics for potential reciprocations from sleep lab data where ventilatory instability is known to be present, and then comparing the results to metrics from motion and breathe-down studies. The limits may then be refined to filter out true positives.

[0018] The metrics referred to above may include fall slope, magnitude, slope ratio, and path length ratio. With regard to fall slope, it may be desirable to limit the maximum fall slope to filter out high frequency artifact in the SpO₂ trend, and limit the minimum fall slope to ensure that slow SpO₂ changes are not qualified as reciprocations. Regarding magnitude, limits may be placed on the minimum magnitude because of difficulties associated with deciphering the difference between ventilatory instability reciprocations and artifact reciprocations as the reciprocation size decreases, and on the maximum magnitude to avoid false positives associated with severe artifact (e.g., brief changes of more than 35% SpO₂ that are unrelated to actual ventilatory instability). The slope ratio may be limited to indirectly limit the rise slope for the same reasons as the fall slope is limited and because ventilatory instability patterns essentially always have a desaturation rate that is slower than the resaturation (or recovery) rate. The path length ratio may be defined as Path Length/((Fall Peak - Nadir) + (Rise Peak - Nadir)), where Path Length = $\sum | \text{Current SpO}_2 \text{ Value} - \text{Previous SpO}_2 \text{ value} |$ for all SpO₂ values in a reciprocation, and the maximum path length ratio may be limited to limit the maximum standard deviation of the reciprocation, which limits high frequency artifact. The following table (Table I) lists the above-identified metrics along with their associated equations and the limits used in accordance with one embodiment:

Table I

Metric	Equation	Minimum	Maximum
Fall Slope	$(\text{Nadir} - \text{Fall Peak}) / \text{Time between Fall Peak and Nadir}$	-1.6 (Fast Response Mode) -1 (Normal Response Mode)	-0.08 (Fast Response Mode) -0.05 (Normal Response Mode)
Magnitude	$\text{Max}(\text{Rise Peak}, \text{Fall Peak}) - \text{Nadir}$	3	35
Slope Ratio	$ \text{Fall Slope} / \text{Rise Slope} $	0.05	1.75
Path Length Ratio	Path Length = $\sum \text{Current SpO}_2 \text{ Value} - \text{Previous SpO}_2 \text{ Value} $ for all SpO ₂ values in a Reciprocation. Path Length Ratio = $\text{Path Length} / ((\text{Fall Peak} - \text{Nadir}) + (\text{Rise Peak} - \text{Nadir}))$	N/A	2

[0019] As indicated in Table I above, an oximetry algorithm in accordance with present embodiments may operate in two response modes: Normal Response Mode or Fast Response Mode. The selected setting may change the SpO₂ filtering performed by the oximetry algorithm, which in turn can cause changes in SpO₂ patterns. Therefore a saturation pattern detection feature may also accept a response mode so that it can account for the different SpO₂ filtering. Table I indicates values associated with both types of response mode with regard to the Fall Slope values.

A second qualification stage of the RQ feature 204 may utilize a object reciprocation qualification feature. Specifically, the second qualification stage may utilize a linear qualification function based on ease of implementation, efficiency, and ease of optimization. The equation may be determined by performing a least squares analysis. For example, such an analysis may be performed with MATLAB®. The inputs to the equation may include the set of metrics described below. The output may be optimized to a maximum value for patterns where ventilatory instability is known to be present. The equation may be optimized to output smaller values (e.g., 0) for other data sets where potential false positive reciprocations are abundant.

[0020] To simplify optimization, the equation may be factored into manageable sub-equations. For example, the equation may be factored into sub-equation 1, sub-equation D, and sub-equation 2, as will be discussed below. The output of each sub-equation may then be substituted into the qualification function to generate an output. The outputs from each of the sub-equations may not be utilized to determine whether a reciprocation is qualified in accordance with present embodiments. Rather, an output from a full qualification function may be utilized to qualify a reciprocation. It should be noted that the equations set forth in the following paragraphs describe one set of constants. However, separate sets of constants may be used based on the selected response mode. For example, a first set of constants may be used for the Normal Response Mode and a second set of constants may be used for the Fast Response Mode.

[0021] Preprocessing may be utilized in accordance with present embodiments to prevent overflow for each part of the qualification function. The tables (Tables II-VII) discussed below, which relate to specific components of the qualification function may demonstrate this overflow prevention. Each row in a table contains the maximum value of term

which is equal to the maximum value of the input variable multiplied by the constant, wherein the term "maximum" may refer to the largest possible absolute value of a given input. Each row in a table contains the maximum intermediate sum of the current term and all previous terms. For example, a second row may contain the maximum output for the second term calculated, as well as the maximum sum of terms 1 and 2. It should be noted that the order of the row may match the order that the terms are calculated by the RQ feature 204. Further, it should be noted that in the tables for each sub-equation below, equations may be calculated using temporary signed 32-bit integers, and, thus, for each row in a table where the current term or intermediate term sum exceeds 2147483647 or is less than -2147483647 then an overflow/underflow condition may occur.

[0022] A first sub-equation, sub-equation 1, may use metrics from a single reciprocation. For example, sub-equation 1 may be represented as follows:

$$\text{Eq1Score} = \text{SlopeRatio} * \text{SrCf} + \text{PeakDiff} * \text{PdCf} + \text{FallSlope} * \text{FsCf} + \text{PathRatio} * \text{PrCf} + \text{Eq1Offset},$$

where SrCf, PdCf, FsCf, PrCf, and Eq1Offset may be selected using least squares analysis (e.g., using MATLAB®). PeakDiff may be defined as equal to |Recip Fall Peak - Recip Rise Peak|. It should be noted that PeakDiff is typically not considered in isolation but in combination with other metrics to facilitate separation. For example, a true positive reciprocation which meets other criteria but has a high peak difference could be an incomplete recovery. That is, a patient's SpO₂ may drop from a baseline to a certain nadir value, but then fail to subsequently recover to the baseline. However, when used in combination with other metrics in the equation, PeakDiff may facilitate separation of two classifications, as large peak differences are more abundant in false positive data sets.

[0023] With regard to sub-equation 1, the tables (Tables II and III) set forth below demonstrate that the inputs may be preprocessed to prevent overflow. Further, the tables set forth below include exemplary limits that may be utilized in sub-equation 1 in accordance with present embodiments. It should be noted that Table II includes Fast Response Mode constants and Table III includes Normal Response Mode constants.

Table II.

Term	Variable Type	Maximum Variable Value (a)	Variable Preprocessing	Constant Value (b) (Fast Mode)	Maximum Term Value (a * b)	Maximum Intermediate Sum (sum of all previous rows)	Overflow
PeakDiff*PdCf	U8	100	None. This value may not exceed 100 since the maximum SpO ₂ value accepted is 100	-29282	-2928200	-2928200	NO
SlopeRatio*SrCf	U8	255	None	-1534	-391170	-3319370	NO
FallSlope*FsCf	S16	-32768	None	-19	622592	-2696778	NO
PathRatio*PrCf	U16	65535	None	-7982	-523100370	-525797148	NO
Eq1Offset	N/A	N/A	N/A	809250	809250	-524987898	NO

Table III.

Term	Variable Type	Maximum Variable Value (a)	Variable Preprocessing	Constant Value (b) (Normal Mode)	Maximum Term Value (a * b)	Maximum Intermediate Sum (sum of all previous rows)	Overflow
PeakDiff*PdCf	U8	100	None. This value may not exceed 100 since the maximum SpO ₂ value accepted is 100	-33311	-3331100	-3331100	NO
SlopeRatio*SrCf	U8	255	None	-2151	-548505	-3879605	NO
FallSlope*FsCf	S16	-32768	None	-706	23134208	19254603	NO
PathRatio*PrCf	U16	65535	None	-6178	-404875230	-385620627	NO
Eq1Offset	N/A	N/A	N/A	576330	576330	-385044297	NO

EP 2 348 959 B1

[0024] A second sub-equation, sub-equation D, may correspond to a difference between two consecutive reciprocations which have passed the hard limit qualifications checks, wherein consecutive reciprocations include two reciprocations that are separated by less than a defined time span. For example, consecutive reciprocations may be defined as two reciprocations that are less than 120 seconds apart. The concept behind sub-equation D may be that ventilatory instability tends to be a relatively consistent event, with little change from one reciprocation to the next. Artifact generally has a different signature and tends to be more random with greater variation among reciprocations. For example, the following equation may represent sub-equation D:

$$\text{EqD} = \text{SlopeRatioDiff} * \text{SrDCf} + \text{DurationDiff} * \text{DDCf} + \text{NadirDiff} * \text{NdCf} + \text{PathLengthRatioDiff} * \text{PrDCf} _ \text{EqDOffset},$$

where, SrDCf, DDCf, NdCf, PrDCf, and EqDOffset may be selected using least squares analysis (e.g., using MATLAB®). With regard to other variables in sub-equation D, SlopeRatioDiff may be defined as |Current Recip Slope Ratio - Slope Ratio of last qualified Recip|; DurationDiff may be defined as |Current Recip Duration - Duration of last qualified Recip|; NadirDiff may be defined as |Current Recip Nadir - Nadir value of last qualified Recip|; and PathLengthRatioDiff may be defined as |Current Recip Path Length Ratio - Path Length Ratio of last qualified Recip|.

[0025] With regard to sub-equation D, the tables (Tables IV and V) set forth below demonstrate that the inputs may be preprocessed to prevent overflow. Further, the tables set forth below include exemplary limits that may be utilized in sub-equation D in accordance with present embodiments. It should be noted that Table IV includes Fast Response Mode constants and Table V includes Normal Response Mode constants.

Table IV.

Term	Variable Type	Maximum Variable Value (a)	Variable Preprocessing	Constant Value (b) (Fast Mode)	Maximum Term Value (a * b)	Maximum Intermediate Sum (sum of all previous rows)	Overflow
EqDOffset	N/A	N/A	N/A	885030	885030	885030	NO
SlopeRatioDiff * SrDCf	U8	255	None	-2809	-716295	168735	NO
DurationDiff * DDCf	U16	240	The Recip detection module may only detect recipis less than or equal to 240 seconds long	-2960	-710400	-541665	NO
NadirDiff * NdCf	U8	100	This value may not exceed 100 since the maximum SpO ₂ value accepted is 100	-13237	-1323700	-1865365	NO
PathLengthRatioDiff * PrDCf	U16	65535	None	-7809	-511762815	-513628180	NO

Table V.

Term	Variable Type	Maximum Variable Value (a)	Variable Preprocessing	Constant Value (b) (Normal Mode)	Maximum Term Value (a * b)	Maximum Intermediate Sum (sum of all previous rows)	Overflow
EqDOffset	N/A	N/A	N/A	847650	847650	847650	NO
SlopeRatioDiff * SrDCf	U8	255	None	-2629	-670395	177255	NO
DurationDiff * DDCf	U16	240	The Recip detection module may only detect recips less than or equal to 240 seconds long	-4282	-1027680	-850425	NO
NadirDiff * NdCf	U8	100	This value may not exceed 100 since the maximum SpO ₂ value accepted is 100	-11705	-1170500	-2020925	NO
PathLengthRatioDiff * PrDCf	U16	65535	None	-7844	-514056540	-516077465	NO

EP 2 348 959 B1

[0026] A third sub-equation, sub-equation 2, may combine the output of sub-equation D with the output of sub-equation 1 for a reciprocation (e.g., a current reciprocation) and a previous reciprocation. For example, the following equation may represent sub-equation 2:

5

$$\text{Eq2Score} = \text{EqDScore} * \text{DCf} + \text{Eq1ScoreCurrent} * \text{CurrEq1Cf} + \text{Eq1ScorePrev} * \text{PrevEq1Cf},$$

10

where DCf, N1Cf, PrevEq1Cf, and Eq2Offset may be selected using least squares analysis (e.g., using MATLAB®). With regard to other variables in sub-equation 2, EqDScore may be described as the output of sub-equation D; Eq1ScoreCurrent may be described as the output of sub-equation 1 for a current reciprocation; and Eq1ScorePrev may be described as the output of sub-equation 1 for the reciprocation previous to the current reciprocation.

15

[0027] With regard to sub-equation 2, the tables (Tables VI and VII) set forth below demonstrate that the inputs may be preprocessed to prevent overflow. Further, the tables set forth below include exemplary limits that may be utilized in sub-equation 2 in accordance with present embodiments. It should be noted that Table VI includes Fast Response Mode constants and Table VII includes Normal Response Mode constants.

20

25

30

35

40

45

50

55

Table VI.

Term	Variable Type	Maximum Variable Value (a)	Variable Preprocessing	Constant Value (b) (Fast Mode)	Maximum Term Value (a * b)	Maximum Intermediate Sum (sum of all previous rows)	Overflow
Eq2Offset	N/A	N/A	N/A	-203800	-203800	-203800	NO
EqDScore * DCf	S32	-501590	The largest output for sub-equation D may be -513628180 (see Table IV). The input value may be scaled by dividing the value by 1024. Therefore the largest input value may be -501590	529	-265341110	-265544910	NO
Eq1ScorePrev * PrevEq1Cf	S32	-512683	The largest output for sub-equation 1 may be -524987898 (see Table II). The input value may be scaled by dividing the value by 1024. Therefore the largest input value may be -512683	333	-170723439	-436268349	NO
Eq1ScoreCurrent * CurrEq1Cf	S32	-512683	Same as previous row	617	-316325411	-752593760	NO

5

10

15

20

25

30

35

40

45

50

55

Table VII.

Term	Variable Type	Maximum Variable Value (a)	Variable Preprocessing	Constant Value (b) (Normal Mode)	Maximum Term Value (a * b)	Maximum Intermediate Sum (sum of all previous rows)	Overflow
Eq2Offset	N/A	N/A	N/A	-194550	-194550	-194550	NO
EqDScore * DCf	S32	-503981	The largest output for sub-equation D may be -516077465 (see Table V). The input value may be scaled by dividing the value by 1024. Therefore the largest input value may be -503981	532	-268117892	-268312442	NO
Eq1ScorePrev * PrevEq1Cf	S32	-376000	The largest output for sub-equation 1 may be -385024297 (see Table III). The input value may be scaled by dividing the value by 1024. Therefore the largest input value may be -376000	496	-186496000	-454808442	NO
Eq1ScoreCurrent * CurrEq1Cf	S32	-376000	Same as previous row	406	-152656000	-607464442	NO

[0028] A qualification function may utilize the output of each of the equations discussed above (i.e., sub-equation 1, sub-equation D, and sub-equation 2) to facilitate qualification and/or rejection of a potential reciprocation. For example, the output of the qualification function may be filtered with an IIR filter, and the filtered output of the qualification function may be used to qualify or reject a reciprocation. An equation for an unfiltered qualification function output in accordance with present embodiments is set forth below:

$$QF_{\text{Unfiltered}} = \text{Eq1Score} * \text{SingleRecipWt} * \text{Eq2Cf} + \text{N2Score} * \text{MultipleRecipWt} * \text{Eq2Cf} + \text{NConsecRecip} * \text{ConsecCf} + \text{RecipMax} * \text{MaxCf} + \text{Artifact\%} * \text{ArtCf} + \text{QFOffset},$$

where Eq2Cf, ConsecCf, MaxCf, ArtCf, and QFOffset may be selected using least squares analysis (e.g., using MATLAB®), and, as indicated above, Eq1Score may be defined as the output of sub-equation 1.

[0029] Other metrics in the unfiltered qualification function include SingleRecipWt, MultipleRecipWt, NConsecRecip, RecipMax, and Artifact%. With regard to SingleRecipWt and MultipleRecipWt, when there are two or more consecutive qualified reciprocations (e.g., qualified reciprocations that are less than 120 seconds apart) present, SingleRecipWt may equal 0 and MultipleRecipWt may equal 1. However, when only a single reciprocation is present, SingleRecipWt may equal 1 and MultipleRecipWt may equal 0.

[0030] NConsecRecip, which may be defined as equal to max(NConsecRecip', QFConsecMax), may include a count of the number of consecutive reciprocations (e.g., reciprocations that are less than or equal to 120 seconds apart) that have passed the hard limit checks. The value for NConsecRecip may be reset to 0 whenever a gap between any two partially qualified reciprocations exceeds 120 seconds. This may be based on the fact that ventilatory instability is a relatively long lasting event as compared to artifact. Therefore, as more reciprocations pass the hard limit checks, the qualification function may begin qualifying reciprocations that were previously considered marginal. However, to guard against a situation where something is causing a longer term artifact event (e.g., interference from nearby equipment), the value may be clipped to a maximum value to limit the metrics influence on the qualification function output.

[0031] RecipMax, which may be defined as equal to max(Fall Peak, Rise Peak), may facilitate making decisions about marginal reciprocations. Indeed, marginal reciprocations with higher maximum SpO₂ values may be more likely to get qualified than marginal reciprocations with lower SpO₂ values. It should be noted that this metric works in tandem with the NConsecRecip metric, and multiple marginal reciprocations with lower maximum SpO₂ values may eventually, over a long period of time, get qualified due to the NConsecRecip metric.

[0032] The metric Artifact% may be defined as an artifact percentage that is equal to 100*Total Artifact Count / Recip Duration, where Total Artifact Count is the number of times and artifact flag was set during the reciprocation. Present embodiments may include many metrics and equations that are used to set the artifact flag. Because of this it is a generally reliable indication of the amount of artifact present in the oximetry system as a whole. Marginal reciprocations with a high Artifact% are less likely to be qualified than marginal reciprocations with a low (or 0) artifact percentage.

[0033] A last component of the qualification function may include an infinite impulse response (IIR) filter that includes coefficients that may be tuned manually using a tool (e.g., a spreadsheet) that models algorithm performance. The filtered qualification function may be represented by the following equation, which includes different constants for different modes (e.g., Fast Response Mode and Normal Response Mode):

$$QF_{\text{Filtered}} = \text{SingleRecipWt} * QF_{\text{Unfiltered}} + ((1-a) * QF_{\text{Unfiltered}} + a * \text{Prev}QF_{\text{Filtered}}) * \text{MultipleRecipWt},$$

where QFUnfiltered may be defined as the current unfiltered qualification function output; PrevQFFiltered may be defined as the previous filtered qualification function output; and where the constat "a" may be set to 0.34 for Fast Response Mode and 0.5 for Normal Response Mode.

[0034] The filtered output of the qualification function may be compared to a threshold to determine if the current reciprocation is the result of RAF or artifact. The optimum threshold may theoretically be 0.5. However, an implemented threshold may be set slightly lower to bias the output of the qualification function towards qualifying more reciprocations, which may result in additional qualification of false positives. The threshold may be lowered because, in accordance with present embodiments, a cluster determination portion of the algorithm, such as may be performed by the CD feature 206, may require a certain number (e.g., 5) of fully qualified reciprocations before an index may be calculated, and a certain number (e.g., at least 2) of consecutive qualified reciprocations (with no intervening disqualified reciprocations) within the set of fully qualified reciprocations. Since multiple reciprocations may be required, the clustering detection method may be biased toward filtering out false positives. Accordingly, the reciprocation qualification function threshold may be lowered to balance the two processes.

EP 2 348 959 B1

[0035] The CD feature **206** may be capable of performing an algorithm that maintains an internal reciprocation counter that keeps track of a number of qualified reciprocations that are currently present. When the reciprocation counter is greater than or equal to a certain value, such as 5, the clustering state may be set to "active" and the algorithm may begin calculating and reporting the SPD_i. When clustering is not active (e.g., reciprocation count < 5) the algorithm may not calculate the SPD_i. The SPD_i is defined as a scoring metric associated with the identification of a saturation trend pattern generated in accordance with present embodiment and correlates to ventilatory instability in a population of sleep lab patients.

[0036] The CD feature 206 may utilize various rules to determine the reciprocation count. For example, when the clustering state is inactive, the following rules may be observed:

- If the distance between qualified reciprocation exceeds 120 seconds, then the reciprocation count = 0;
- If the current reciprocation is qualified, and the time from the start of the current reciprocation to the end of the last qualified reciprocation is <= 120 seconds, then the reciprocation count = reciprocation count + 1;
- If the current reciprocation is not qualified, then the reciprocation count = max(reciprocation count - 2, 0).

[0037] Once clustering is active, it may remain active until the time between two qualified reciprocations exceeds **120** seconds. The following table (Table II) illustrates an example of how the reciprocation count rules may be applied to determine a clustering state.

Table VIII

Current Reciprocation Qualified	Time Since Last Qualified Reciprocation (seconds)	Reciprocation Count	Clustering State
TRUE	N/A	1	INACTIVE
FALSE	60	0	INACTIVE
TRUE	N/A	1	INACTIVE
FALSE	60	0	INACTIVE
TRUE	N/A	1	INACTIVE
TRUE	30	2	INACTIVE
TRUE	120	3	INACTIVE
FALSE	60	1	INACTIVE
TRUE	10	2	INACTIVE
TRUE	20	3	INACTIVE
TRUE	40	4	INACTIVE
FALSE	30	2	INACTIVE
FALSE	60	0	INACTIVE
TRUE	N/A	1	INACTIVE
TRUE	20	2	INACTIVE
TRUE	120	3	INACTIVE
TRUE	10	4	INACTIVE
FALSE	90	2	INACTIVE
TRUE	120	3	INACTIVE
TRUE	60	4	INACTIVE
TRUE	20	5	ACTIVE
TRUE	30	6	ACTIVE
FALSE	50	6	ACTIVE
FALSE	100	6	ACTIVE

(continued)

Current Reciprocation Qualified	Time Since Last Qualified Reciprocation (seconds)	Reciprocation Count	Clustering State
TRUE	121	1	INACTIVE
FALSE	50	0	INACTIVE
TRUE	N/A	1	INACTIVE
TRUE	30	2	INACTIVE
TRUE	121	1	INACTIVE
TRUE	10	2	INACTIVE
TRUE	20	3	INACTIVE
TRUE	40	4	INACTIVE
TRUE	40	5	ACTIVE

[0038] When the clustering state is active, the SPDi calculation feature **208** may calculate an unfiltered SPDi for each new qualified reciprocation. The following formula may be used by the SPDi calculation feature **208**:

$$\text{Unfiltered SPDi} = a * \text{Magnitude} + b * \text{PeakDelta} + c * \text{NadirDelta};$$

wherein a = 1.4, b = 2.0, c = 0.2;

wherein Magnitude = average magnitude of all reciprocations in the last 6 minutes;

wherein PeakDelta = average of the three highest qualified reciprocation rise peaks in the last 6 minutes minus the average of the three lowest qualified reciprocation rise peaks in the last 6 minutes; and

wherein NadirDelta = average of the three highest qualified reciprocation nadirs in the last 6 minutes minus the average of the three lowest qualified reciprocation nadirs in the last 6 minutes.

Wherein SPDi <= 31

[0039] The above formula may be utilized to quantify the severity of a ventilatory instability pattern. The constants and metrics used may be based on input from clinical team members. It should be noted that the PeakDelta parameter may be assigned the largest weighting constant since the most severe patterns generally have peak reciprocation values that do not recover to the same baseline.

[0040] The unfiltered SPDi may be updated whenever clustering is active and a new qualified reciprocation is detected. Non-zero SPDi values may be latched for a period of time (e.g., 6 minutes). The unfiltered SPDi may then be low pass filtered to produce the final output SPDi value. The following IIR filter with a response time of approximately 40 seconds may be used:

$$\text{SPDi} = \text{Unfiltered SPDi} / a + \text{Previous Filtered SPDi} * (a-1) / a;$$

wherein a = 40.

[0041] FIG. 6 is an exemplary graph **260** including an SpO₂ trend **262** that contains a ventilatory instability SpO₂ pattern and a trend of the resulting SPDi **264**. In the illustrated example, it should be noted that the SPDi is sensitive to the decreasing peaks (incomplete recoveries) starting at approximately t=6000.

[0042] The UN feature **210** may be capable of determining if a user notification function should be employed to notify a user (e.g., via a graphical or audible indicator) of the presence of a detected patterns such as ventilatory instability. The determination of the UN feature **210** may be based on a user configurable tolerance setting and the current value of the SPDi. For example, the user may have four choices for the sensitivity or tolerance setting: Off, Low, Medium, and High. When the sensitivity or tolerance setting is set to Off, an alarm based on detection of a saturation pattern may never be reported to the user. The other three tolerance settings (i.e., Low, Medium, and High) may each map to an SPDi threshold value. For example, Low may map to an SPDi threshold of 6, Medium may map to an SPDi threshold of 15, and High may map to an SPDi threshold of 24. The thresholds may be based on input from users. When the SPDi is at or above the threshold for a given tolerance setting, the user may be notified that ventilatory instability is present. As discussed below, the indication to the user may include a graphical designation of the trend data corresponding to

the detected pattern. For example, the trend data utilized to identify a ventilatory instability pattern may be highlighted, flashing, or otherwise indicated on a user interface of a monitor in accordance with present embodiments. Similarly, parameters such as the SPD_i value and the tolerance settings may be graphically presented on a display.

[0043] In embodiments, the display includes a graphical indicator that provides information to a user related to the occurrence, frequency, and/or magnitude of the patterns detected. The information is based on the SPD_i index, which is proportional to the magnitude and variability of qualified reciprocations. The SPD calculation feature may be capable of notifying a user of ventilatory instability that corresponds to a certain SPD_i index value. When the SPD_i is at or above a threshold setting, the user may be notified via a graphical indicator 600. As illustrated in FIG. 7, the graphical indicator 600 may be represented on display 598 as a dashed triangle that may graphically fill from top to bottom as a monitored and/or calculated value increases. For example, in one embodiment, the graphical indicator 600 gradually fills as the SPD_i index calculated by the SPD_i calculation feature 208 increases. Further, the graphical indicator 600 may include a tolerance level indicator 602 that displays an index, for example 1, 2, or 3, for tolerance or sensitivity settings of High, Medium, and Low, respectively, for the SPD_i calculation feature 208. The tolerance settings may set the threshold for triggering a change in the graphical indicator 600 and/or for triggering SPD-associated alarms. As shown in FIG. 9, the graphical indicator 600 may be empty, indicating that an SPD_i index is below a certain threshold. In addition, the display 598 may also include additional indicators, such as a Sat Seconds indicator 604 that relates to oxygen saturation information. Sat Seconds indicators may assist clinicians in focusing on desaturations related to a patient condition rather than short desaturations that may be the result of measurement anomalies. As shown, the Sat Seconds indicator 604 may be partially full while the graphical indicator 600 is empty. The Sat Seconds indicator 604 may display results determined by a Sat Second analyzing function, which in an embodiment analyzes desaturation events by multiplying their duration (seconds) by the number of percentage points the patient exceeds the alarm limit. In an embodiment, the Sat Seconds analyzer may determine if an oxygen desaturation event has occurred by analyzing a plot of oxygen saturation versus time. The Sat Seconds analyzer may integrate the area under the curve of time spent below a certain oxygen saturation threshold. Accordingly, sudden, short desaturation readings that may be measurement noise (e.g., that otherwise may trigger nuisance alarms) may be eliminated from a Sat Seconds counter clock while more prolonged desaturations may be counted. Clinicians can set the SatSeconds limit, or clock, to 10, 25, 50 or 100 SatSeconds. In an embodiment, the clock may be set to 100, and therefore only events that equal or surpass the 100 SatSeconds limit may trigger an alarm. In addition, the Sat Seconds indicator 604 may fill up in relation to the Sat Seconds count. For example, the indicator 604 may be full when the count reaches 100.

[0044] While the Sat Seconds indicator 604 may manage nuisance alarms related to desaturation events, the graphical indicator 600 may display information determined by not only the duration and magnitude of the oxygen desaturation, but also to the patterns of the desaturation events, as provided herein. Such analysis may provide information to the healthcare provider about ventilatory instability that may, for example, be related to sleep apnea. Turning to the graphical indicator 600, which provides information to a clinician related to ventilatory instability, FIG. 8 shows a display screen 620 in which the graphical indicator 600 has started to fill up from the bottom. The "filling up" may represent the addition of a fill (e.g., any color pixels) to the area of the triangle. In one embodiment, the graphical indicator 600 may fill up when the calculated SPD_i index is higher than a tolerance setting. As noted, the High Tolerance, Medium Tolerance, and Low Tolerance alarm limits may refer to certain default values of the SPD_i index, such as 24, 15, and 6, respectively. When the SPD_i index is higher than, for example, 24 (High Tolerance setting), the graphical indicator 600 may begin to fill. In an embodiment, the graphical indicator 600 may begin to fill up when the SPD_i index is lower than but near 24, whereby an SPD_i index of 24 represents a "full" state. In such an embodiment, the approximately 25% full graphical indicator as shown may represent an SPD_i index of, for example, 18.

FIG. 9 is a display 640 including an indicator 600 that is approximately 50% full. As noted, the graphical indicator 600 may continue to fill as the SPD_i index rises over time. The SPD_i index may be calculated over a rolling period of time. In embodiments, the SPD_i index may be calculated over a 240 second window. If, during this window of time, the SPD_i index increases as a result an increase in measured reciprocation frequency or magnitude parameters used to determine the index, the graphical indicator 600 may continue to fill up.

FIG. 10 is an exemplary display 660 showing a graphical indicator 600 that is approximately 75% full, and FIG. 11 is an exemplary display 680 showing a graphical indicator 600 that is approximately 100% full. As shown in FIGs. 7-11, the indicator 600 may fill up as a percentage or fraction of the total indicator space as the SPD_i index increases. For example, the indicator 600 may have five possible display states: empty, 25% full, 50% full, 75% full, or 100% full. In embodiments, the indicator 600 may fill in any suitable manner. For example, a graphical indicator may have any number of fill states, e.g., filling up in 10%, 20%, 25%, or 50% increments. In other embodiments, the indicator 600 may also change in intensity to indicate increasing ventilatory instability. For example, an indicator may fill in uniformly, but with increasing intensity, as the SPD_i index increases. In an embodiment, the indicator 600 may have states that resemble different values on a grayscale, with the percentage grayscale increasing at the SPD_i index increases.

[0045] A filled state of the graphical indicator 600 may trigger a primary or secondary alarm. In an embodiment, a primary alarm, such as a text alert, may be triggered when the graphical indicator 600 begins to fill. When the indicator

600 has reached a full state, a secondary alarm, such as an audio alarm, may then be triggered.

[0046] The indicator 600 may be displayed on any number of monitor views to provide information to a healthcare provider during various monitoring activities. FIG. 12 shows an exemplary general pleth display 700 with a plethysmographic waveform 702. The display 700 may include a graphical indicator 600 for saturation pattern detection with a tolerance indicator 602. The display may also include softkeys 704 for navigating between other display views.

[0047] FIG. 13 shows an exemplary blip display 720. As shown, the location of the graphical indicator 600 on the screen may change according to the particular display view chosen. However, the general shape of the indicator 600 may remain substantially the same so that the user may easily identify the indicator 600. FIG. 14 shows an exemplary general care format view 760. As shown, the graphical indicator 600 and the Sat Seconds indicator 604 may be relatively larger in certain views. FIG. 15 shows a real-time trend display 780 with a trend xy plot 782. FIG. 16 shows a display 786 in which an SPD event 788 is highlighted on the xy plot 782. In FIG. 15 and FIG. 16, the graphical indicator 600 may be displayed along with other indicators and patient data.

[0048] In embodiments, a user may have the ability to change certain settings on the monitor 10 related to the graphical indicator 600. In one embodiment, a user may be able to change settings related to SPD alarm limits. An alarm setup display related to the SPD alarm settings may be accessed via softkey from other display screens. FIG. 17 is an exemplary alarm setup display 800. As shown, a user may be able to select an option in which the monitor 10 activates SPD calculation features and associated indicators and alarms. In addition, a user may activate a Sat Seconds calculation and/or display feature. In an embodiment, a user may be able to select between audio and/or visual alarms in response to saturation pattern detection by the monitor 10, as shown in FIG. 18, which depicts a display 820 in which a user may select to turn off audio alerts related to saturation pattern detection.

[0049] In another embodiment, a user may be able to change the default values on the limits to user-selected values. FIG. 19 is an exemplary display 840 showing an SPD Tolerance menu. A user may select between multiple SPD tolerance settings for High, Medium, or Low Tolerance of the SPD-associated alarms. In an embodiment, a monitor 10 may store certain default values associated with SPD_i index values. These default values may be determined based on clinical observations of a test patient population or other input from healthcare providers. For example, the default High Tolerance value may be associated with an SPD_i index value of 24. Accordingly, any SPD-associated alarms may not trigger until the SPD_i index for a calculated window of time is at or near 24.

[0050] A user may input specific values for High, Medium, and Low Tolerance limits. A user may select any value, so long as the High Tolerance limit is higher than the Medium Tolerance limit, and the Medium Tolerance limit is higher than the Low Tolerance limit. A monitor 10 may be able to trigger an error message if a user attempts to set a limit of less than zero or if a user attempts to set a High Tolerance limit that is lower than a Medium Tolerance limit, and so on. FIG. 20 is a flow chart 900 indicating how a monitor 10 may trigger alarms based on the SPD_i tolerance settings. At start 902, if a tolerance setting is set to "OFF" at 904, the process sets the alarm status to "NO SPD ALARM" at 905. If the tolerance is set to Low (906), Medium (908), or High (910), the SPD_i index is compared to the appropriate threshold, depending on the setting. For example, if the tolerance is set to Low at 906, the SPD_i index is compared to the Low Index Limit at 912. If the SPD_i index is lower than the Low Index Limit, the process may set the alarm status to "NO SPD ALARM" at 905. If the SPD_i index is higher than the Low Index Limit, the process may then determine if audio alerts have been enabled at 914. If such alerts have not been enabled, the process set the alarm status to "VISUAL ONLY" to trigger visual alarms at 916. If audible alerts have been enabled, the alarm status may be set to "AUDIBLE VISUAL" at 918 for triggering audible and visual alarms before the process ending at 920. Similarly, a Medium Tolerance setting may be compared to a Medium Index Limit at 922 and a High Tolerance setting may be compared to a High Index Limit at 924.

[0051] While the embodiments of the present disclosure may be susceptible to various modifications and alternative forms, specific embodiments have been shown by way of example in the drawings and will be described in detail herein. However, it should be understood that the present embodiments are not intended to be limited to the particular forms disclosed. Rather, present embodiments are to cover all modifications, equivalents and alternatives falling within the scope of the following appended claims.

Claims

1. A monitoring system, comprising:
a monitor (10) capable of receiving input relating to patient physiological parameters and storing data related to the parameters, the monitor comprising:-

a pattern detection feature (202) capable of analyzing SpO₂ data to detect a pattern in the SpO₂ data, the pattern comprising at least one reciprocation, wherein each reciprocation is defined by a fall peak, a nadir, and a rise peak;
a reciprocation qualification feature (204) capable of determining if the detected pattern in the SpO₂ data is due

to a ventilatory instability, the reciprocation qualification feature being configured to pass the detected pattern in the SpO₂ data of a potential reciprocation through a qualification stage that comprises checking fall slope in the detected pattern against a set of limits comprising a maximum fall slope limit and a minimum fall slope limit; a cluster determination feature (206) that is configured to keep track of a number of qualified reciprocations and to calculate and report a scoring metric when the number of qualified reciprocations is greater than or equal to a certain number; and a graphical indicator (600) capable of being displayed comprising a graphical representation based at least in part one or more of an occurrence, frequency, or magnitude of the pattern, and configured to notify a user when the scoring metric is at or above a threshold setting.

2. The system of claim 1, wherein data related to the parameters comprises pulse oximetry data.
3. The system of claim 1, wherein the graphical indicator (600) comprises an indicator that changes in relation to the magnitude of the pattern or the graphical indicator comprises a geometric shape and wherein the geometric shape is filled in relation to one or more of an occurrence, frequency, or magnitude of the pattern.
4. The system of claim 1, wherein the pattern detection feature (202) comprises an index calculation feature capable of determining the scoring metric associated with the pattern, and wherein the graphical indicator (600) changes in relation to the scoring metric calculated over time.
5. The system of claim 4, comprising an alarm that is triggered when the scoring metric reaches a predetermined threshold.
6. The system of claim 5, wherein the predetermined threshold may be selected by a user or wherein the predetermined threshold may be selected from a high tolerance, medium tolerance, and low tolerance threshold.
7. The system of claim 1, wherein the graphical indicator (600) comprises a graphic triangle capable of filling from the bottom of the triangle to the top of the triangle as an saturation pattern detection index (SPDi) value increases.
8. A system according to claim 1, further comprising:
a sensor capable of sensing patient physiological parameters, wherein the monitor (10) is configured to receive the input related to the patient physiological parameters from the sensor.
9. A system according to Claim 8, wherein the sensor comprises a pulse oximetry sensor or the monitor comprises an alarm capable of being triggered when the graphical indicator is empty or full.

Patentansprüche

1. Überwachungssystem, Folgendes umfassend:
einen Monitor (10), der dazu befähigt ist, Eingabe zu empfangen, die physiologische Patientenparameter betreffen und Daten zu speichern, die die Parameter betreffen, wobei der Monitor Folgendes umfasst:

eine Musterdetektionsfunktion (202), dazu befähigt, SpO₂-Daten zu analysieren, um ein Muster in den SpO₂-Daten zu detektieren, wobei das Muster mindestens eine Reziprokation umfasst, worin jede Reziprokation durch eine Fallspitze, einen Nadir und eine Anstiegsspitze definiert ist;
eine Reziprokation-Qualifikationsfunktion (204), zum Bestimmen befähigt, falls das detektierte Muster in den SpO₂-Daten auf eine Ventilationsinstabilität zurückzuführen ist, dass die Reziprokation-Qualifikationsfunktion dazu konfiguriert ist, das detektierte Muster in den SpO₂-Daten einer potentiellen Reziprokation durch eine Qualifikationsstufe zu leiten, die umfasst, dass der Gefällegradient im detektierten Muster gegen einen Satz von Grenzwerten geprüft wird, die einen maximalen Grenzwert des Gefällegradienten und einen minimalen Grenzwert des Gefällegradienten umfassen;
eine Clusterbestimmungsfunktion (206), die dazu konfiguriert ist, eine Anzahl von qualifizierten Reziprokationen zu verfolgen und eine Scoring-Metrik zu berechnen und zu melden, wenn die Anzahl von qualifizierten Reziprokationen größer oder gleich einer gewissen Anzahl ist; und
einen graphischen Anzeiger (600), der dazu befähigt ist, angezeigt zu werden, welcher eine graphische Repräsentation umfasst, die mindestens zum Teil auf eine oder mehrere von Folgenden basiert: Vorkommen, Frequenz oder Größe des Musters, und dazu konfiguriert ist, einem Benutzer zu melden, wenn die Scoring-

Metrik an oder über einer Schwelleneinstellung liegt.

2. System nach Anspruch 1, worin Daten, die die Parameter betreffen, Pulsoxymetriedaten umfassen.
- 5 3. System nach Anspruch 1, worin der graphische Anzeiger (600) einen Indikator umfasst, der sich im Verhältnis zur Größe des Musters verändert oder der graphische Indikator eine geometrische Form umfasst und worin die geometrische Form im Verhältnis zu einem oder mehreren von Folgenden gefüllt ist: Vorkommen, Frequenz oder Größe des Musters.
- 10 4. System nach Anspruch 1, worin die Musterdetektionsfunktion (202) eine Indexberechnungsfunktion umfasst, die dazu befähigt ist, die Scoring-Metrik zu bestimmen, die mit dem Muster assoziiert ist, und worin sich der graphische Anzeiger (600) im Verhältnis zur zeitlich berechneten Scoring-Metrik verändert.
- 15 5. System nach Anspruch 4, einen Alarm umfassend, die getriggert wird, wenn die Scoring-Metrik eine vorgegebene Schwelle erreicht.
6. System nach Anspruch 5, worin die vorgegebene Schwelle von einem Benutzer ausgewählt werden kann oder worin die vorgegebene Schwelle aus einer hohen Toleranz-, mittleren Toleranz- und niedrigen Toleranzschwelle ausgewählt werden kann.
- 20 7. System nach Anspruch 1, worin der graphische Anzeiger (600) ein graphisches Dreieck umfasst, das befähigt ist, sich von unten bis oben zu füllen, wenn ein Saturationspunkt-Detektionsindex (SPDi) ansteigt.
- 25 8. System nach Anspruch 1, außerdem Folgendes umfassend:
einen Sensor, der dazu befähigt ist, physiologische Parameter eines Patienten abzutasten, worin der Monitor (10) dazu konfiguriert ist, die Eingabe vom Sensor zu empfangen, die die physiologischen Parameter des Patienten betreffen.
- 30 9. System nach Anspruch 8, worin der Sensor einen Pulsoxymetriesensor umfasst oder der Monitor einen Alarm umfasst, der getriggert zu werden befähigt ist, wenn der graphische Anzeiger leer oder voll ist.

Revendications

- 35 1. Système de monitoring, comprenant :
un moniteur (10) qui dispose de la capacité de recevoir une entrée concernant des paramètres physiologiques de patient et de stocker des données relatives aux paramètres, le moniteur comprenant :
 - 40 une caractéristique de détection de motif (202) qui dispose de la capacité d'analyser des données SpO₂ de manière à détecter un motif dans les données SpO₂, le motif comprenant au moins une inversion, dans lequel chaque inversion est définie par un pic descendant, un nadir et un pic montant ;
 - une caractéristique de qualification d'inversion (204) qui dispose de la capacité de déterminer si le motif détecté dans les données SpO₂ est dû à une instabilité ventilatoire, la caractéristique de qualification d'inversion étant configurée de manière à ce qu'elle fasse passer le motif détecté dans les données SpO₂ d'une inversion potentielle par une étape de qualification qui comprend la vérification de pente descendante dans le motif détecté vis-à-vis d'un jeu de limites comprenant une limite de pente descendante maximum et une limite de pente descendante minimum ;
 - une caractéristique de détermination de groupement (206) qui est configurée de manière à ce qu'elle garde trace d'un nombre d'inversions qualifiées et de manière à ce qu'elle calcule et rapporte une mesure de score
 - 50 lorsque le nombre d'inversions qualifiées est supérieur ou égal à un certain nombre ; et
 - un indicateur graphique (600) qui dispose de la capacité d'être affiché, comprenant une représentation graphique qui est basée, au moins en partie, sur un ou plusieurs paramètre(s) pris parmi une occurrence, une fréquence et une amplitude du motif, et qui est configuré de manière à ce qu'il adresse une notification à un utilisateur lorsque la mesure de score est à une consigne de seuil ou au-delà de celle-ci.
 - 55
2. Système selon la revendication 1, dans lequel des données relatives aux paramètres comprennent des données d'oxymétrie pulsée.

EP 2 348 959 B1

3. Système selon la revendication 1, dans lequel l'indicateur graphique (600) comprend un indicateur qui change en relation avec l'amplitude du motif ou l'indicateur graphique comprend une forme géométrique et dans lequel la forme géométrique est remplie en relation avec un ou plusieurs paramètre(s) pris parmi une occurrence, une fréquence et une amplitude du motif.

5

4. Système selon la revendication 1, dans lequel la caractéristique de détection de motif (202) comprend une caractéristique de calcul d'index qui dispose de la capacité de déterminer la mesure de score qui est associée au motif, et dans lequel l'indicateur graphique (600) change en relation avec la mesure de score qui est calculée au fil du temps.

10

5. Système selon la revendication 4, comprenant une alarme qui est déclenchée lorsque la mesure de score atteint un seuil prédéterminé.

6. Système selon la revendication 5, dans lequel le seuil prédéterminé peut être sélectionné par un utilisateur ou dans lequel le seuil prédéterminé peut être sélectionné parmi un seuil de tolérance élevé, un seuil de tolérance intermédiaire et un seuil de tolérance faible.

15

7. Système selon la revendication 1, dans lequel l'indicateur graphique (600) comprend un triangle graphique qui dispose de la capacité d'être rempli depuis la base du triangle jusqu'au sommet du triangle lorsqu'une valeur d'index de détection de motif de saturation (SPDi) augmente.

20

8. Système selon la revendication 1, comprenant en outre :
un capteur qui dispose de la capacité de détecter des paramètres physiologiques de patient, dans lequel le moniteur (10) est configuré de manière à ce qu'il reçoive l'entrée relative aux paramètres physiologiques de patient en provenance du capteur.

25

9. Système selon la revendication 8, dans lequel le capteur comprend un capteur d'oxymétrie pulsée ou le moniteur comprend une alarme qui dispose de la capacité d'être déclenchée lorsque l'indicateur graphique est vide ou plein.

30

35

40

45

50

55

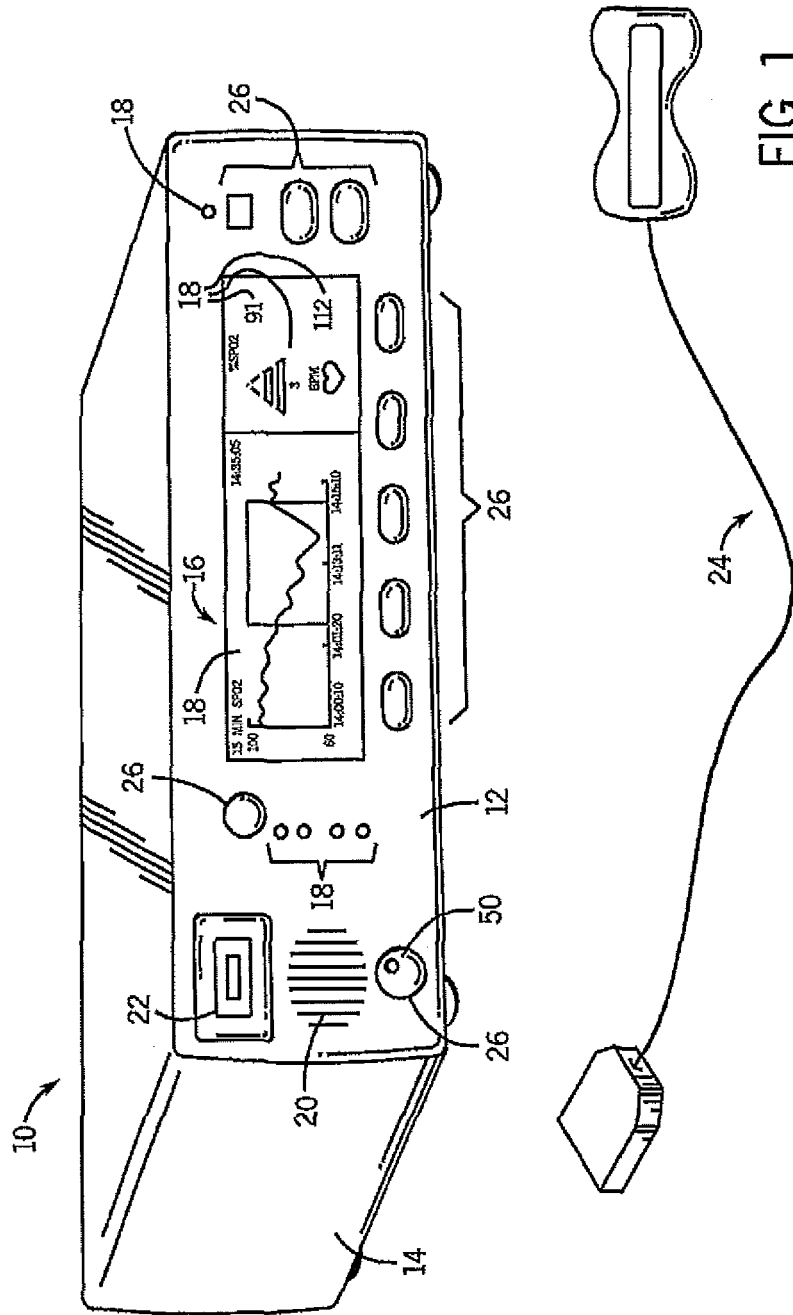

FIG. 1

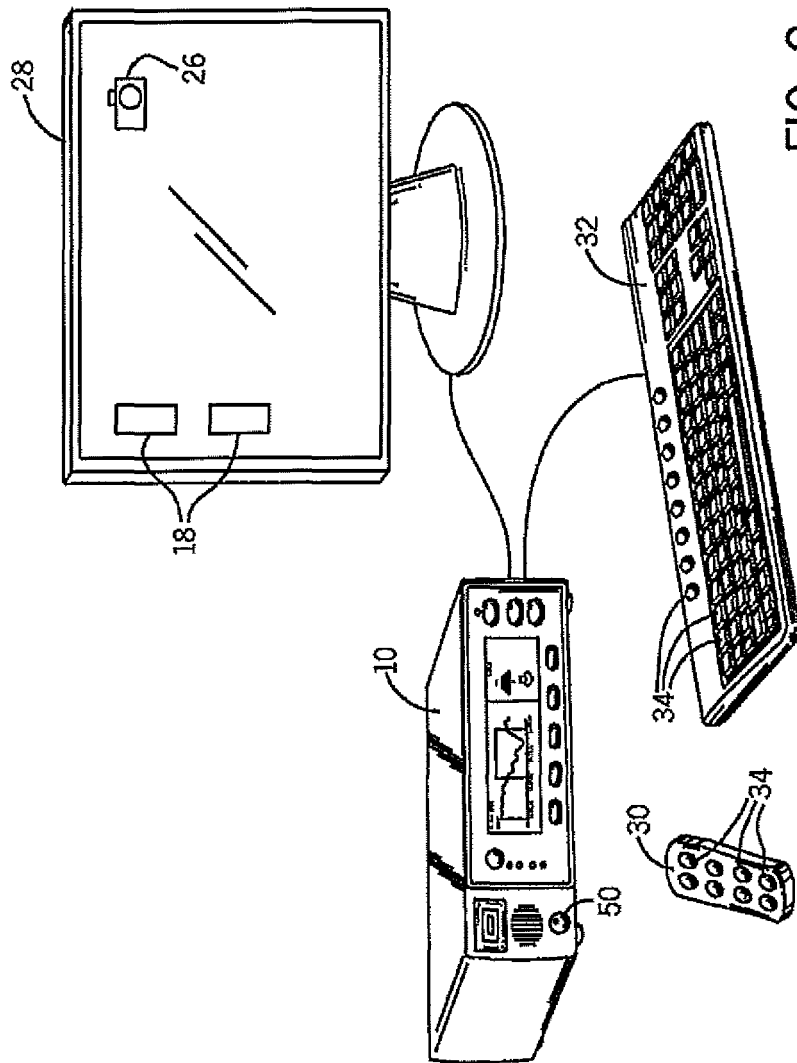

FIG. 2

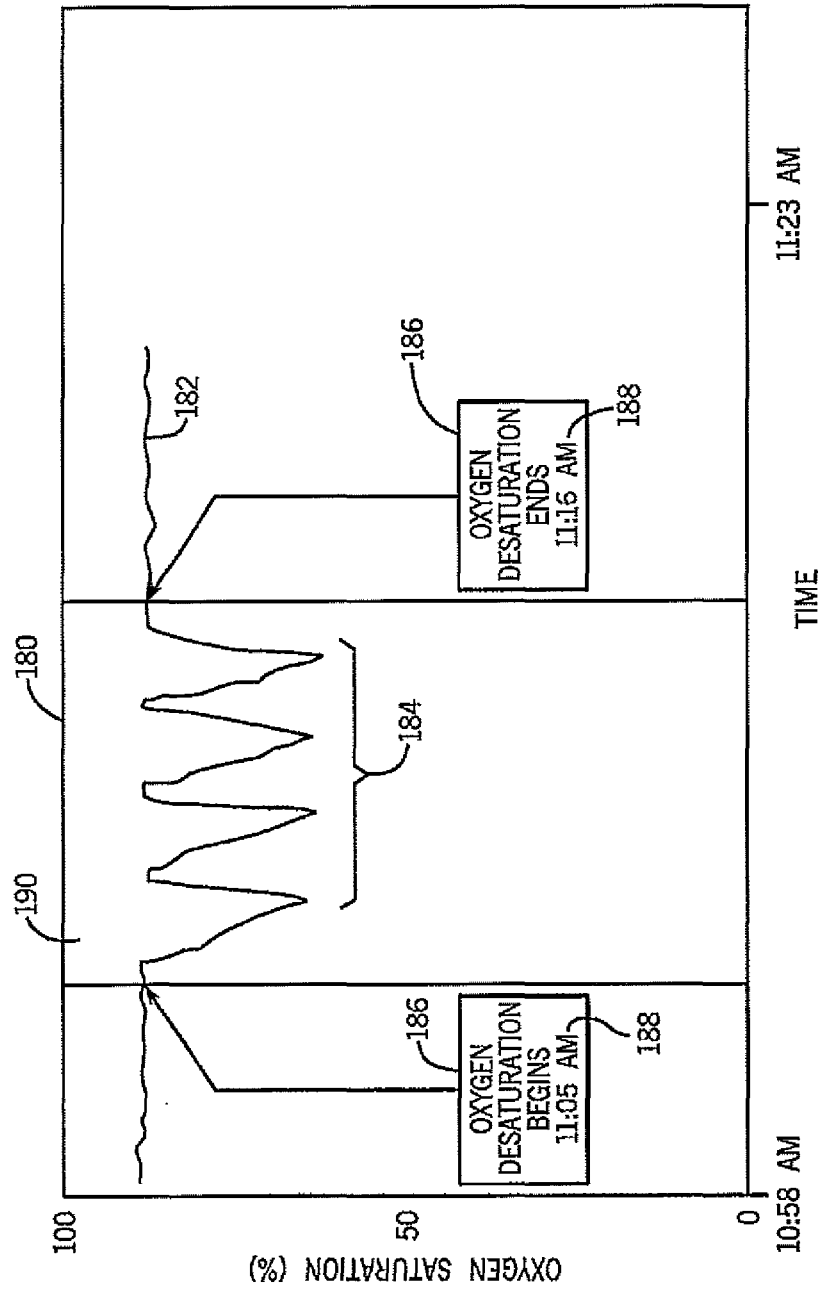

FIG. 3

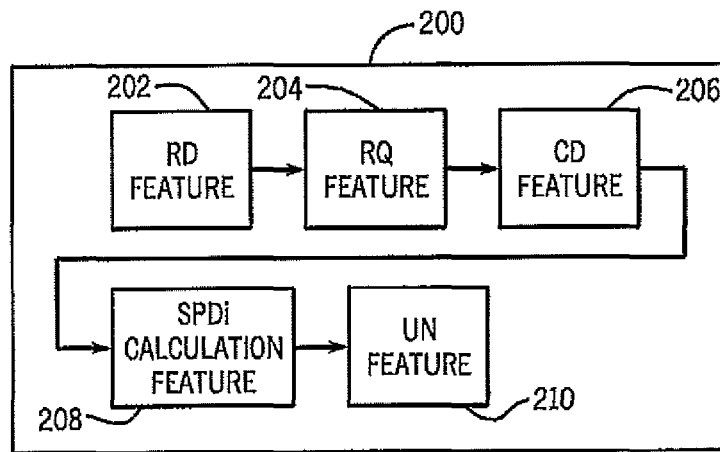

FIG. 4

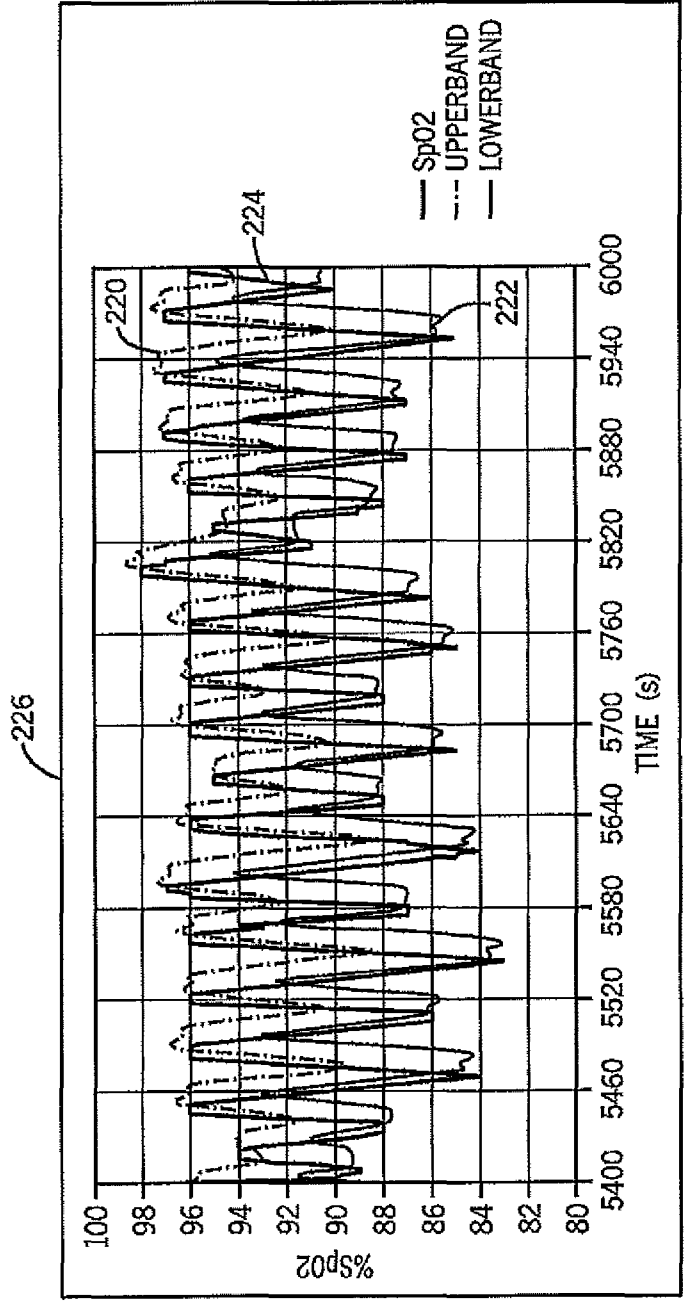

FIG. 5

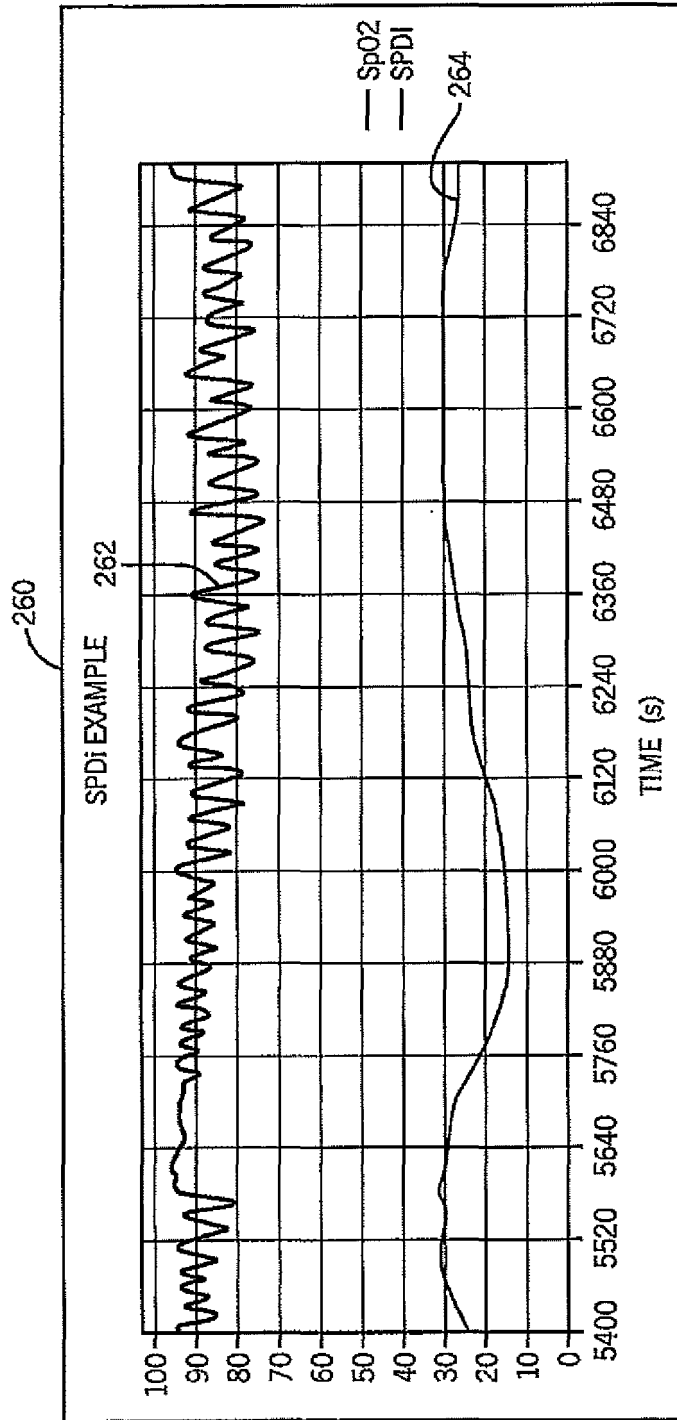

FIG. 6

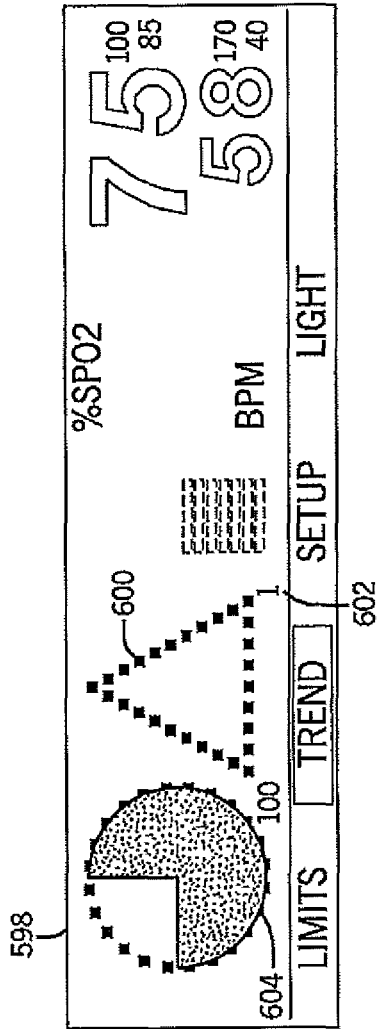

FIG. 7

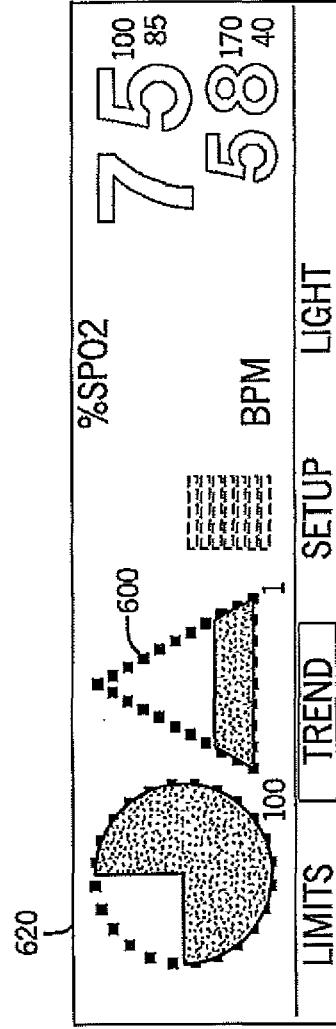

FIG. 8

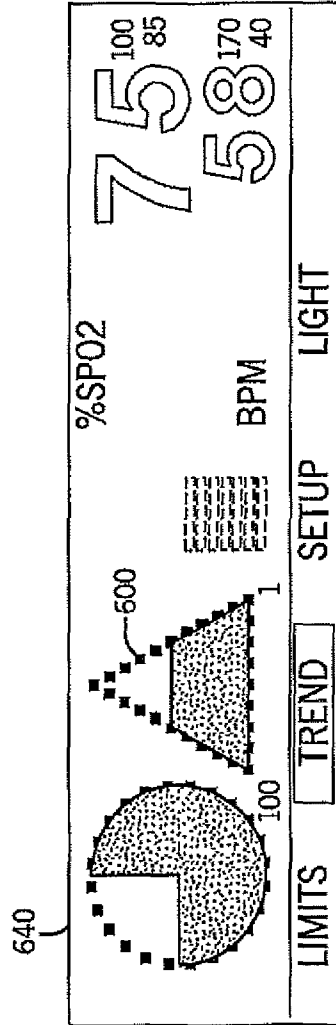

FIG. 9

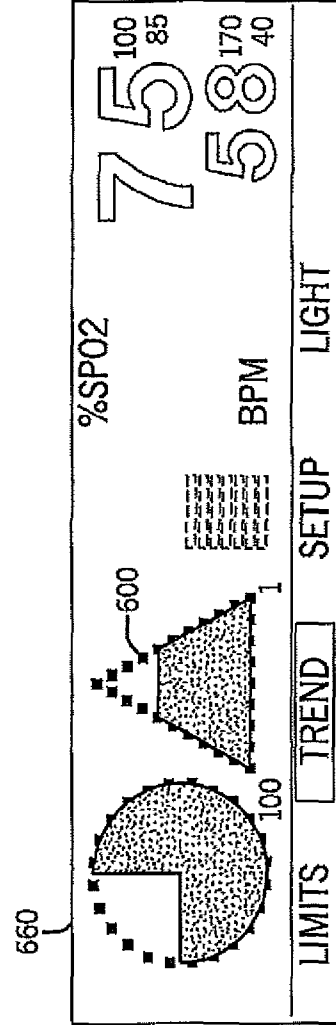

FIG. 10

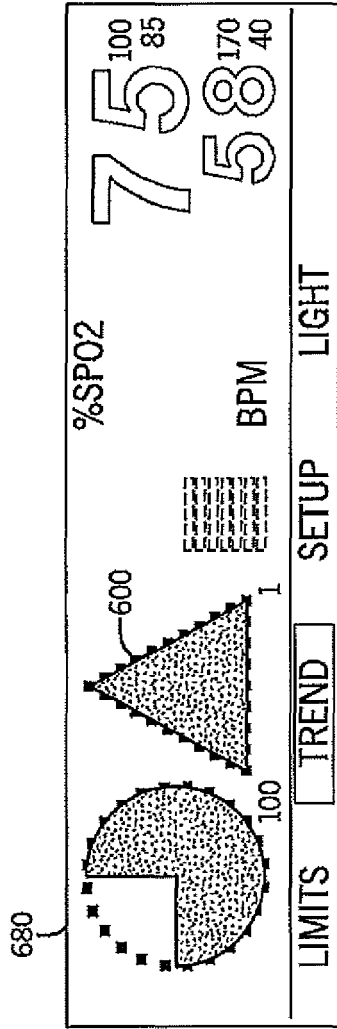

FIG. 11

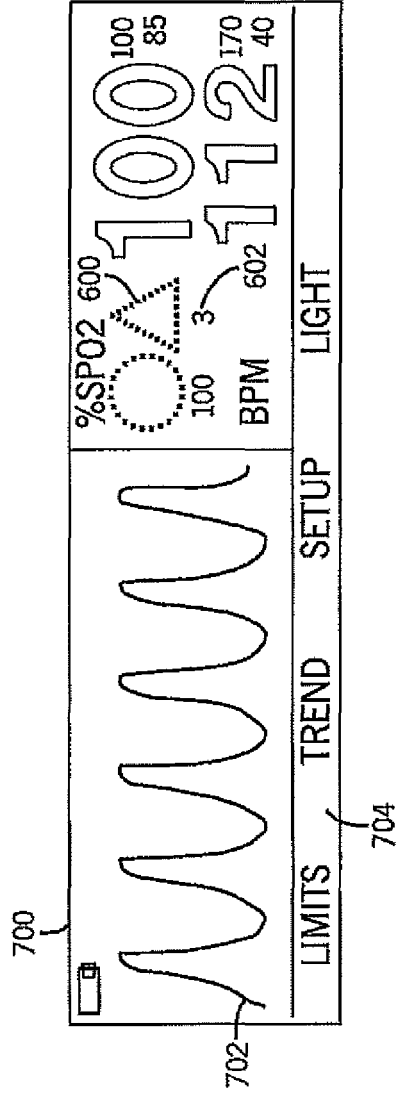

FIG. 12

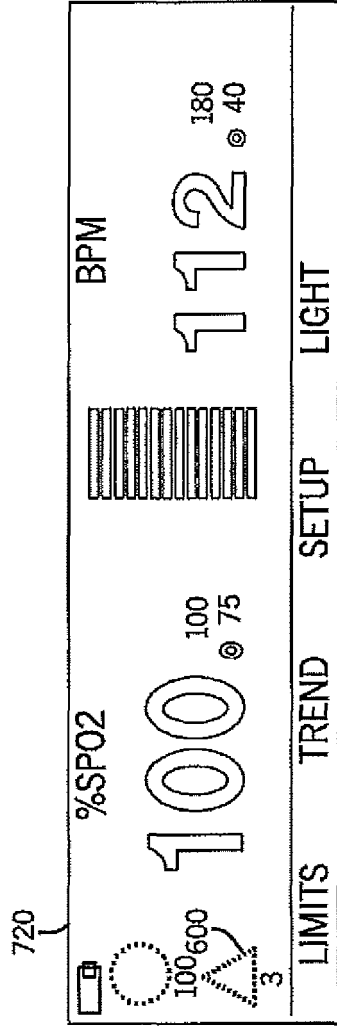

FIG. 13

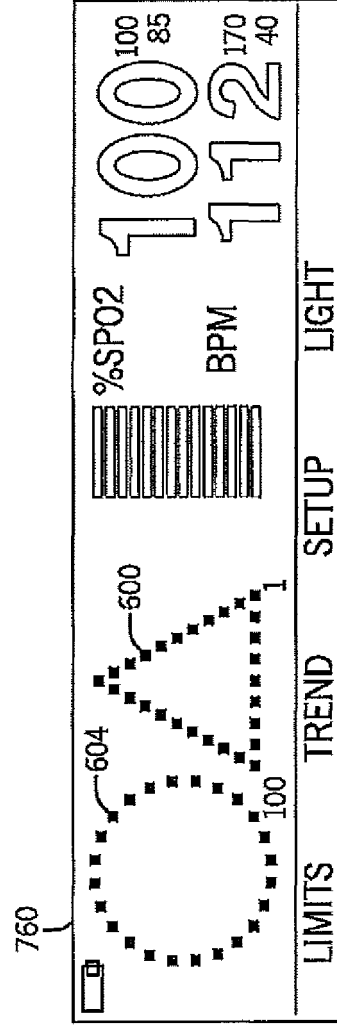

FIG. 14

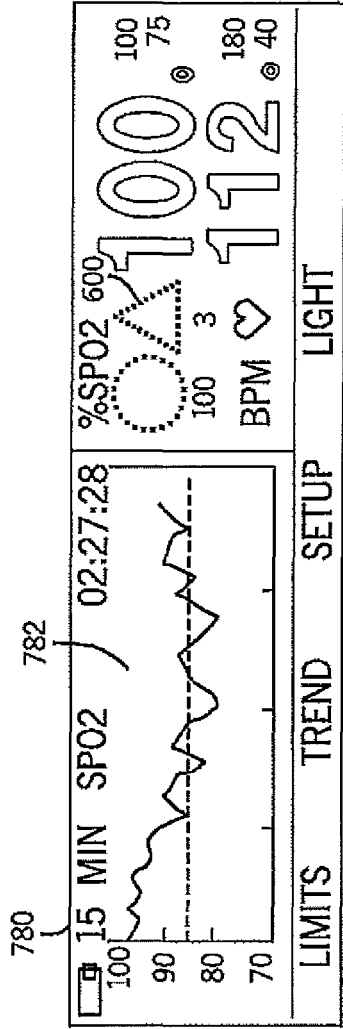

FIG. 15

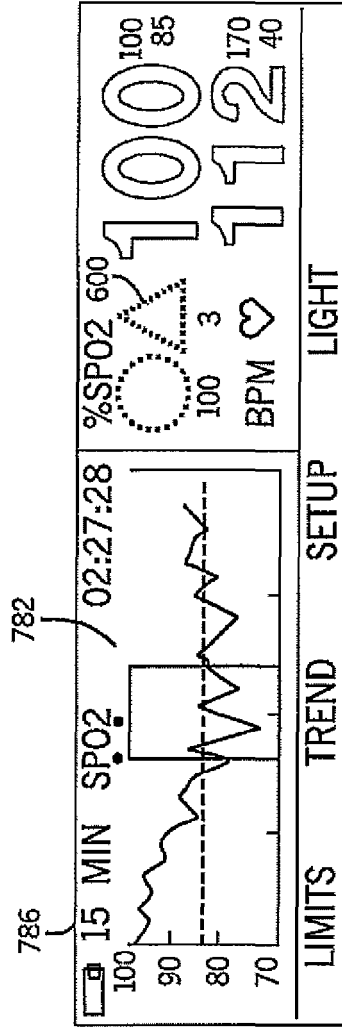

FIG. 16

800

ALARMS				100
ALLOW OFF?	<input type="checkbox"/> NO	<input type="checkbox"/>	<input type="checkbox"/>	85
OFF REMINDER?	YES	<input type="checkbox"/>	<input type="checkbox"/>	170
ALLOW SAT-S	YES	<input type="checkbox"/>	<input type="checkbox"/>	40
SELECT	SPD	BACK		

FIG. 17

820

SPD SETUP				100
ALLOW SPD?	YES	<input type="checkbox"/>	<input type="checkbox"/>	85
SPD AUDIO ALERT?	<input type="checkbox"/> NO	<input type="checkbox"/>	<input type="checkbox"/>	170
SELECT	BACK	<input type="checkbox"/>	<input type="checkbox"/>	40
		EXIT		

FIG. 18

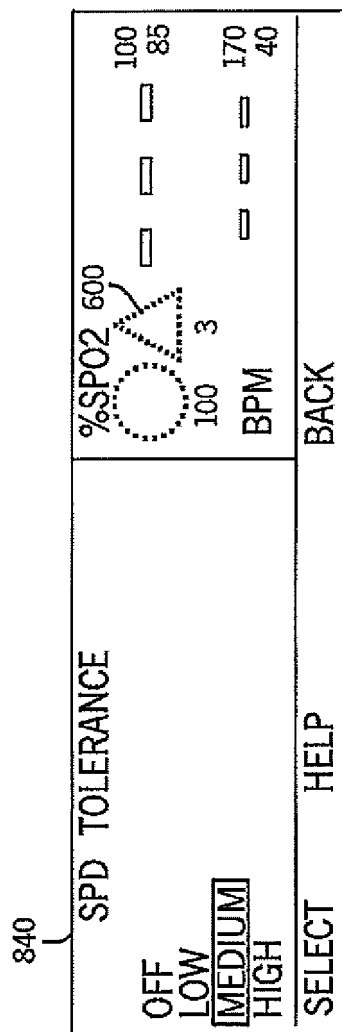
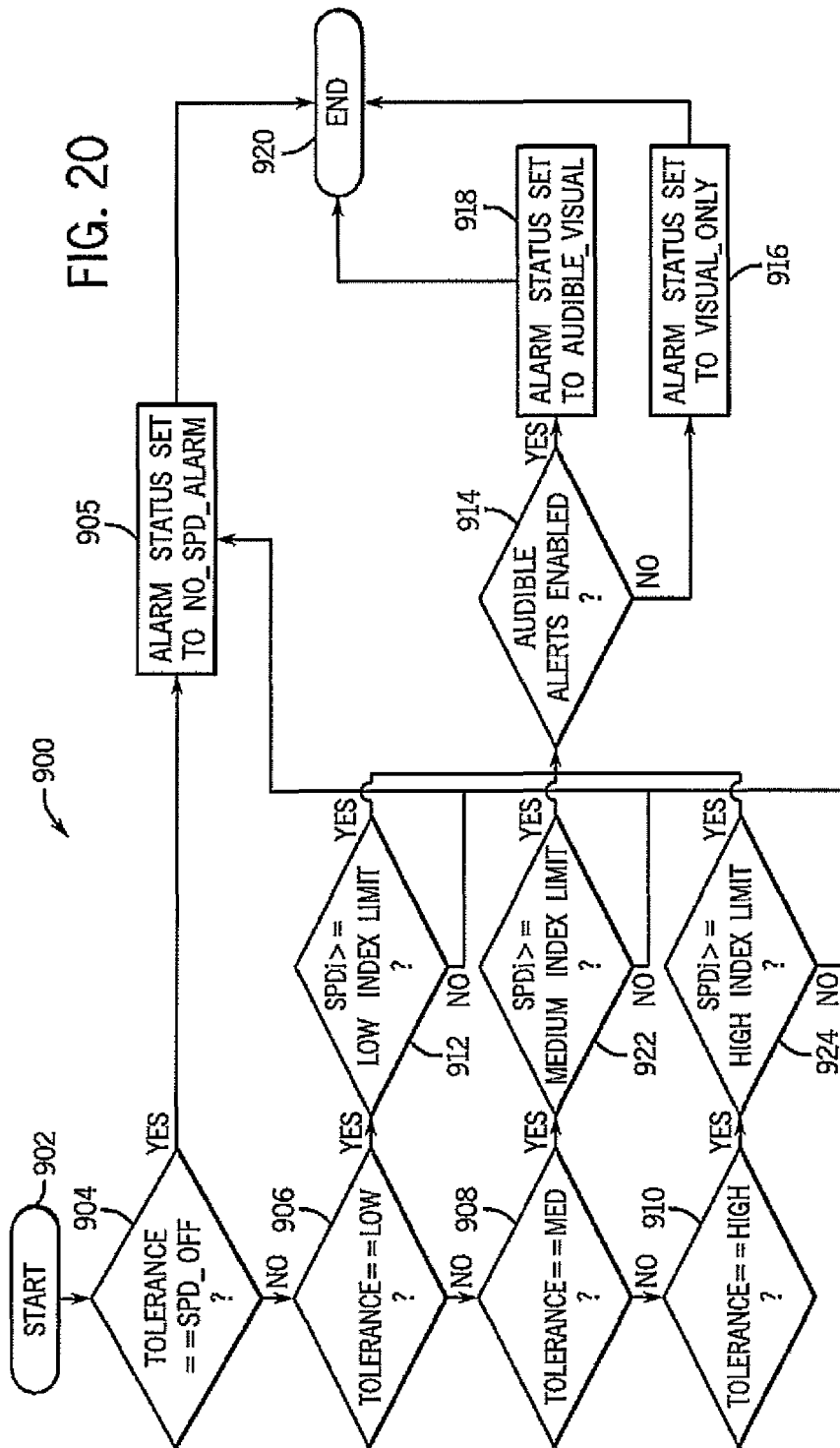

FIG. 19



REFERENCES CITED IN THE DESCRIPTION

This list of references cited by the applicant is for the reader's convenience only. It does not form part of the European patent document. Even though great care has been taken in compiling the references, errors or omissions cannot be excluded and the EPO disclaims all liability in this regard.

Patent documents cited in the description

- US 2008097175 A [0004]
- US 20080076977 A [0004]
- US 20080221418 A [0004]
- WO 2006076498 A [0004]
- US 6760608 B [0013]
- US 6223064 B [0013]
- US 5398682 A [0013]
- US 5605151 A [0013]
- US 6748252 B [0013]
- US 2006235324 A1 [0013]
- US 2006155206 A [0013]
- US 2007129647 A1 [0013]

专利名称(译)	便于观察监测的生理数据的系统和方法		
公开(公告)号	EP2348959A1	公开(公告)日	2011-08-03
申请号	EP2009749275	申请日	2009-10-30
[标]申请(专利权)人(译)	内尔科尔普里坦贝内特公司		
申请(专利权)人(译)	NELLCOR PURITAN BENNETT LLC		
当前申请(专利权)人(译)	COVIDIEN LP		
[标]发明人	BATCHELDER KEITH AMUNDSON SCOTT BRECHT MARK		
发明人	BATCHELDER, KEITH AMUNDSON, SCOTT BRECHT, MARK		
IPC分类号	A61B5/00		
CPC分类号	A61B5/746 A61B5/0205 A61B5/14551 A61B5/4818 A61B5/7235 A61B5/7278 A61B5/7282 A61B5/742 A61B5/743 A61B5/7445		
优先权	61/110259 2008-10-31 US 12/609314 2009-10-30 US		
其他公开文献	EP2348959B1		
外部链接	Espacenet		

摘要(译)

本实施例涉及能够检测和图形指示患者数据中的生理模式的系统和方法。例如，本实施例可以包括监视系统，该监视系统包括能够接收与患者生理参数有关的输入并存储与参数有关的历史数据的监视器。另外，监视系统可以包括能够显示与患者生理参数相对应的历史数据的屏幕。此外，监视系统可以包括模式检测特征，其能够分析历史数据以检测历史数据的片段中的生理模式，并且能够在生理模式存在于屏幕上时启动屏幕上的片段的图形指示。分割。