

(19)



(11)

EP 3 050 035 B1

(12)

EUROPEAN PATENT SPECIFICATION

(45) Date of publication and mention of the grant of the patent:
19.09.2018 Bulletin 2018/38

(51) Int Cl.:
G08B 7/06 ^(2006.01) **H04M 1/725** ^(2006.01)
A61B 5/00 ^(2006.01) **A61B 5/02** ^(2006.01)
A61B 5/021 ^(2006.01)

(21) Application number: **14850070.5**

(86) International application number:
PCT/FI2014/050605

(22) Date of filing: **05.08.2014**

(87) International publication number:
WO 2015/044507 (02.04.2015 Gazette 2015/13)

(54) **WEARABLE ELECTRONIC DEVICE**

TRAGBARE ELEKTRONISCHE VORRICHTUNG
DISPOSITIF ÉLECTRONIQUE VESTIMENTAIRE

(84) Designated Contracting States:
AL AT BE BG CH CY CZ DE DK EE ES FI FR GB GR HR HU IE IS IT LI LT LU LV MC MK MT NL NO PL PT RO RS SE SI SK SM TR

• **MYRYLÄINEN, Sami**
FI-02280 Espoo (FI)

(30) Priority: **27.09.2013 US 201314039043**

(74) Representative: **Espatent Oy**
Kaivokatu 10 D
00100 Helsinki (FI)

(43) Date of publication of application:
03.08.2016 Bulletin 2016/31

(56) References cited:
WO-A1-2008/087870 **JP-A- 2004 147 263**
US-A- 5 979 456 **US-A1- 2003 181 116**
US-A1- 2003 181 116 **US-A1- 2004 210 165**
US-A1- 2007 026 798 **US-A1- 2008 058 620**
US-A1- 2013 154 826 **US-B1- 8 344 862**
US-B1- 8 344 862

(73) Proprietor: **Nokia Technologies Oy**
02610 Espoo (FI)

(72) Inventors:
• **KOSONEN, Matti**
FI-04420 Järvenpää (FI)

EP 3 050 035 B1

Note: Within nine months of the publication of the mention of the grant of the European patent in the European Patent Bulletin, any person may give notice to the European Patent Office of opposition to that patent, in accordance with the Implementing Regulations. Notice of opposition shall not be deemed to have been filed until the opposition fee has been paid. (Art. 99(1) European Patent Convention).

Description**TECHNICAL FIELD**

[0001] The present invention generally relates to wearable electronic devices.

BACKGROUND ART

[0002] Electronic devices can be made of elastic, flexible or bendable material thereby enabling production of wearable electronic devices such as a wrist band or a chest band.

[0003] Following documents have been cited during prosecution of present disclosure:

US 2008/058620 relates to a pressure supplier that applies pressure to only a radial artery area via an actuator and a metallic plate. The pressure supplier is e.g. wrist held bracelet.

[0004] US 2003/181116 discloses a tactile feedback device with an elastic band (e.g. wrist band) and memory alloy. The memory alloy is contracted and relaxed to convey information (e.g. heart rate information is conveyed to the user) to the user.

[0005] US 8344862 discloses a tactile messaging system. Tactile messages are transmitted between wearable tactile user devices. A first user may input tactile information into a first wearable tactile user device and a second user may receive sensory output from a second tactile user device that corresponds to the tactile information entered by the first user into the first tactile user device.

[0006] JP 2004 147263 discloses mobile terminal equipment with a band that may be wound around user's arm. The band attached to the mobile terminal is tightened using a motor and a shaft to inform user of an incoming call.

[0007] According to a first example aspect there is provided an apparatus according to independent apparatus claim.

[0008] According to a second example aspect there is provided a method according to independent method claim.

[0009] In an example implementation there is provided a computer program product comprising computer code for causing performing the method of any example aspect of the invention, when executed by an apparatus.

[0010] In an example implementation there is provided a non-transitory memory medium comprising computer code for causing performing the method of any example aspect of the invention, when executed by an apparatus.

[0011] Some embodiments may be presented only with reference to certain example aspects of the invention. It should be appreciated that corresponding embodiments may apply to other example aspects as well.

BRIEF DESCRIPTION OF THE DRAWINGS

[0012] The invention will be described, by way of example only, with reference to the accompanying drawings, in which:

Fig. 1 shows a schematic view of an apparatus according to an example embodiment of the invention; Fig. 2 shows a schematic view of an apparatus according to an example embodiment of the invention in a bent position;

Fig. 3 shows a schematic view of an apparatus according to an example embodiment of the invention in a loosened position;

Fig. 4 shows a schematic view of an apparatus according to an example embodiment of the invention in a tightened position;

Fig. 5A shows a schematic view of an apparatus according to an example embodiment of the invention; Fig. 5B shows a schematic view of an apparatus according to an example embodiment of the invention; Fig. 5C shows a schematic view of an apparatus according to an example embodiment of the invention;

Fig. 6 shows a schematic block diagram of an apparatus according to an example embodiment of the invention;

Fig. 7 shows a flow diagram illustrating a method according to an example embodiment of the invention;

Fig. 8 shows a flow diagram illustrating a method according to an example embodiment of the invention; and

Fig. 9 shows a flow diagram illustrating a method according to an example embodiment of the invention.

DETAILED DESCRIPTION

[0013] Some example embodiments of the present invention and potential advantages are understood by referring to Figs. 1 through 9 of the drawings.

[0014] According to an example embodiment there is provided shaping and/or tightening of a wearable device with an actuator. The wearable device is for example a wrist band, a chest band, an ankle band or some other device comprising an elongated apparatus structure (e.g. a strap or a band) configured to fit around a body part or body extension of a user. The elongated apparatus structure is made of a suitable elastic, stretchable, flexible or bendable material (such as plastic, textile, or sheet metal), for example. Alternatively the elongated apparatus structure can be made of several strict or tough non-bendable parts (made of plastic, metal, or glass for example) that are linked to each other with a mechanical hinge or flexible / stretchable material to form the elongated structure. The actuator can be used for example for bending the elongated apparatus structure into a cir-

cular, oval, elliptical or the like form suited for being fitted around a body part or body extension of a user. It is to be noted that there may be one actuator or a plurality of actuators.

[0015] In an embodiment the actuator is configured to change tightness of the elongated apparatus structure around the body part of the user based on an action that is being performed by the wearable device or by a physically separate device or apparatus part that communicates with the wearable device over a communication connection. In an example, the shape of the elongated apparatus structure is changed automatically without specific user input or user action.

[0016] In an example embodiment the actuator is configured to change the shape of the elongated apparatus structure linearly so that any shape is available. In an alternative the actuator is configured to provide a step-wise shape change so that for example three different shapes or positions are provided. In an example embodiment there are an unbent position and two bent positions. In an example embodiment there are an unbent position, a loose fitting position and a tight fitting position. These examples are discussed in more detail in connection with Figs. 1-4.

[0017] The method that is used for controlling the actuator depends on what type actuator is used. In an embodiment an actuator made of a shape memory alloy is used. In this case the shape change can be linear. The shape change is provided by changing current or voltage used for controlling the actuator and the shape depends on the current or voltage level. Alternatively there may be a locking mechanism that locks the apparatus structure to desired shape/shapes. In this solution power needs to be used only for driving the apparatus structure to the desired shape and thereafter the locking mechanism maintains the shape and power to the actuator can be switched off thereby saving energy.

[0018] In an alternative solution, the actuator can comprise a motor or a linear motor with appropriate mechanisms. In that case the shape change can be linear or stepwise without significant effect on power consumption.

[0019] In an example embodiment, the elongated apparatus structure is part of a wearable garment, such as a glove, sock, shirt or jacket.

[0020] Fig. 1 shows a schematic view of an apparatus 100 according to an example embodiment of the invention. The apparatus comprises an elongated apparatus structure 110 and an actuator 120. The actuator 120 is for example a wire made of shape memory material fitted along the length of the elongated apparatus structure. The actuator 120 is configured to change shape of the elongated apparatus structure 110. In Fig. 1 the elongated apparatus structure is shown an unbent position.

[0021] Herein it needs to be understood that the shape memory material is only one example of possible actuator. As an alternative, the actuator can comprise a motor or a linear motor accompanied with appropriate mecha-

nisms. -In an example embodiment the actuator comprises a motor with a reduction gear and a ball of wire. The wire is fixed to one end of the elongated strap and the motor with the reduction gear and the ball of wire into the other end. In an example embodiment the actuator comprises a linear motor with a flexible rod. The flexible rod is fixed to one end of the elongated strap and the linear motor with the flexible rod into the other end.

[0022] Fig. 2 shows a schematic view of an apparatus 100 according to an example embodiment of the invention in a bent position. The apparatus 100 comprises an elongated apparatus structure 110 bent into a circular form. The circular form suits well for being fitted around a wrist or some other body part of a user. Alternatively the elongated apparatus structure 110 can be configured to take oval or elliptical or some other suitable form.

[0023] Fig. 3 shows a schematic view of an apparatus according to an example embodiment of the invention in a loosened or loose fitting position. The apparatus comprises a wrist band 300, which is fitted around user's wrist 310. In the shown loosened position there is a gap 320 formed between user's wrist 310 and the wrist band 300.

[0024] Fig. 4 shows a schematic view of an apparatus according to an example embodiment of the invention in a tightened or tight fitting position. The apparatus comprises a wrist band 300, which is fitted around user's wrist 310. In the shown tightened position the wrist band 300 is in contact with user's skin or tightened against the user's wrist, i.e. there is minimal gap 330 or no gap at all formed between user's wrist 310 and the wrist band 300.

[0025] Fig. 5A shows a schematic view of an apparatus 500 according to an example embodiment of the invention. The apparatus 500 comprises an elongated apparatus structure 510 and a user interface unit 520 on a surface of the elongated apparatus structure 510. The elongated apparatus structure 510 is configured to be fitted around a body part of a user. Further the apparatus 500 comprises an actuator (not shown for the sake of clarity) configured to change shape of the elongated apparatus structure 510.

[0026] The user interface unit 520 comprises for example a touch sensitive display. The touch sensitive display comprises for example a touch sensor for detecting the touch of the user. In an example embodiment, the touch sensor comprises a resistive, a surface acoustic wave, a capacitive - such as a surface capacitance, a projected capacitance, a mutual capacitance, or self-capacitance - an infrared, an optical, a dispersive signal and/or acoustic pulse recognition touch sensor or an array thereof. A skilled person appreciates that the user interface unit, in a further example embodiment, comprises further elements such as hardware or soft buttons or further display units. In a further example embodiment, the user interface unit 520 is covered with a glass. It is to be understood that in addition to the user interface unit 520 shown in Fig. 5A the apparatus 500 can comprise other elements, such as a processor or a communication unit.

[0027] Fig. 5B shows a schematic view of an apparatus 550 according to an example embodiment of the invention. The apparatus 550 comprises an elongated apparatus structure 510 and two sensors 560 and 561 on a surface of the elongated apparatus structure 510. The sensors are for example sensors configured to measure heart rate, blood pressure, or skin moisture. The elongated apparatus structure 510 is configured to be fitted around a body part of a user. Further the apparatus 550 comprises an actuator (not shown for the sake of clarity) configured to change shape of the elongated apparatus structure 510. In an example embodiment the actuator is configured to change the shape of the elongated apparatus structure so that the elongated apparatus structure is tightened around the body part of the user when the sensors are in operation, i.e. collect data.

[0028] Fig. 5C shows a schematic view of an apparatus 570 according to an example embodiment of the invention. The apparatus 570 comprises an elongated apparatus structure 510 and an electronic device 580. The elongated apparatus structure 510 is configured to be fitted around a body part of a user. The electronic device 580 and the elongated apparatus structure 510 are configured to communicate with each other over a wireless communication connection 581, such as a Bluetooth connection. Further the apparatus 570 comprises an actuator (not shown for the sake of clarity) configured to change shape of the elongated apparatus structure 510. In an example embodiment the actuator is configured to change the shape of the elongated apparatus structure so that tightness of the elongated apparatus structure 510 around the body part of the user is changed depending on activity in the electronic device 580. In an example embodiment a processor in the electronic device 580 is configured to control the actuator to change the shape of the elongated apparatus structure 510 over the wireless connection 581.

[0029] Fig. 6 shows a schematic block diagram of an apparatus 600 according to an example embodiment of the invention. The apparatus 600 comprises a communication interface module 650, a processor 640 coupled to the communication interface module 650, and a memory 660 coupled to the processor 640. The apparatus further comprises an actuator 630 and a user interface (U/I) unit 620, such as a touch sensitive display, which are coupled to the processor 640. In an example embodiment, the apparatus 600 further comprises one or more sensors configured to measure for example heart rate or skin moisture.

[0030] The memory 660 comprises a work memory and a non-volatile memory such as a read-only memory, flash memory, optical or magnetic memory. In the memory 660, typically at least initially in the non-volatile memory, there is stored software 670 operable to be loaded into and executed by the processor 640. The software 670 may comprise one or more software modules and can be in the form of a computer program product that is software stored in a memory medium.

[0031] It shall be understood that any coupling in this document refers to functional or operational coupling; there may be intervening components or circuitries in between coupled elements unless expressly otherwise described.

[0032] The communication interface module 650 is configured to provide local communications over one or more local links. The links may be wired and/or wireless links. The communication interface 650 may further or alternatively implement telecommunication links suited for establishing links with other users or for data transfer, e.g. using the Internet. Such telecommunication links may be links using any of: wireless local area network links, Bluetooth, ultra-wideband, cellular or satellite communication links. The communication interface 650 may be integrated into the apparatus 600 or into an adapter or card that may be inserted into a suitable slot or port of the apparatus 600. While Fig. 6 shows one communication interface 650, the apparatus may comprise a plurality of communication interfaces 650. In a further example embodiment, the apparatus further 600 comprises a near field communication (NFC) unit.

[0033] The processor 640 is, for instance, a central processing unit (CPU), a microprocessor, a digital signal processor (DSP), a graphics processing unit, an application specific integrated circuit (ASIC), a field programmable gate array, a microcontroller or a combination of such elements. Fig. 6 shows one processor 640, but the apparatus 600 may comprise a plurality of processors. In an example embodiment the processor is configured, in response to certain activity in the processor or in the apparatus 600, to control the actuator 630 to change shape of the apparatus 600, and particularly to control the actuator 630 to change tightness of the apparatus 600 around a body part of a user or tightness of a suitable part of the apparatus 600 around a body part of a user.

[0034] As mentioned in the foregoing, the memory 660 may comprise volatile and a non-volatile memory, such as a read-only memory (ROM), a programmable read-only memory (PROM), erasable programmable read-only memory (EPROM), a random-access memory (RAM), a flash memory, a data disk, an optical storage, a magnetic storage or a smart card. In some example embodiments, only volatile or non-volatile memory is present in the apparatus 600. Moreover, in some example embodiments, the apparatus comprises a plurality of memories. In some example embodiments, various elements are integrated. For instance, the memory 660 can be constructed as a part of the apparatus 600 or inserted for example into a slot or a port. Further still, the memory 660 may serve the sole purpose of storing data, or it may be constructed as a part of an apparatus serving other purposes, such as processing data. Similar options are thinkable also for various other elements.

[0035] A skilled person appreciates that in addition to the elements shown in Fig. 6, the apparatus 600 may comprise other elements, such as microphones, displays, as well as additional circuitry such as a camera

unit, further input/output (I/O) circuitries, memory chips, application-specific integrated circuits (ASIC), processing circuitry for specific purposes such as source coding/decoding circuitry, channel coding/decoding circuitry and ciphering/deciphering circuitry. Additionally, the apparatus 600 may comprise a disposable or rechargeable battery (not shown) for powering the apparatus if external power supply is not available.

[0036] It is also useful to realize that the term apparatus is used in this document with varying scope. In some of the broader claims and examples, the apparatus may refer to only a subset of the features presented in Fig. 6 or even be implemented without any one of the features of Fig. 6.

[0037] The term apparatus may refer to a single physical apparatus or to an apparatus comprising two or more physically separate parts. One needs to understand that elements shown in Fig. 6 for example may be implemented in more than one physically separate parts. There may be for example a wearable part and a separate other part forming the apparatus. Different parts forming the apparatus may communicate with each other over a suitable wireless communication link. For example, the term apparatus may refer to a combination of a wrist band and an electronic device, such as a mobile phone.

[0038] Fig. 7 shows a flow diagram illustrating a method according to an example embodiment of the invention. The method may be performed for example by the apparatus 100, 300, 500, 550, 570 or 600 of previous Figures. In phase 710 of the method, the apparatus performs an action, and in phase 720, an actuator is controlled to change tightness of an elongated apparatus structure, such as a band or a strap, around a body part of a user based on the action. Examples of suitable actions include for example: collection of data using one or more sensors, receipt of an incoming call or message, detection of a need to alert the user, and the like. In an example the elongated apparatus structure is a wrist band and the wrist band is tightened or loosened around a wrist of the user based on the action.

[0039] In an example embodiment of the invention, the apparatus performing the action is part of the band that is fitted around the body part of the user. In another example, the apparatus performing the action is a separate apparatus that is configured to communicate with a processing unit in the band over a suitable wireless communication connection.

[0040] Fig. 8 shows a flow diagram illustrating a method according to an example embodiment of the invention. The method may be performed for example by the apparatus 100, 300, 500, 550, 570 or 600 of previous Figures. In this example there are one or more sensors arranged in an elongated apparatus structure, such as a band, that is fitted around a body part of a user. In phase 810 of the method, an actuator is controlled to tighten the band around the body part of the user while the sensors collect data. The band may be tightened for example when the apparatus initiates collection of data through

the sensors. In phase 820, the actuator is controlled to loosen the band around the body part of the user in response to the sensors ending collection of data. In an example the elongated apparatus structure is a wrist band and the wrist band is tightened or loosened around a wrist of the user.

[0041] For collection of data, e.g. heart rate, blood pressure or skin moisture, through sensors it is advantageous that the sensors are in contact with skin of the user. When the sensors do not collect data there is no need to have a skin contact, though. Use of the band is more pleasant to the user if the band is not at all times tightened around the user's wrist or other body part. Therefore better user experience can be achieved by automatically loosening the band when the sensors end collection of data and by automatically tightening the band for the duration of the sensors collecting data.

[0042] For collection of data, e.g. heart rate, blood pressure or skin moisture, through sensors it is advantageous that the pressure with which the sensors are in contact with the skin of the user is reproducible. In an example embodiment one or more of the following mechanisms are included in the band for ensuring that the pressure is the same for all measurements: a pressure sensor configured to detect band's compression force against the skin, a strain-gauge transducer configured to detect curvature of the band, a shape memory alloy actuator configured to detect curvature of the band (the resistance of a shape memory alloy wire changes when the length of the wire changes and this can be used for curvature detection).

[0043] Fig. 9 shows a flow diagram illustrating a method according to an example embodiment of the invention. The method may be performed for example by the apparatus 100, 300, 500, 550, 570 or 600 of previous Figures. In phase 910 of the method, activity in an apparatus is detected. For example, it is detected that an incoming call or message is received, or an alert is triggered (such as low battery charging level, reminder in a calendar, availability of new information etc.). In phase 920, an actuator is controlled to change shape of an elongated apparatus structure, such as a band or a strap, in order to change tightness of the elongated apparatus structure around a body part of a user as an indication of the activity. In an example the elongated apparatus structure is a wrist band and the wrist band is tightened or loosened around a wrist of the user as an indication of the activity. In an example the band is periodically tightened and loosened. In this way a new type of user interaction is provided. In an example, the user can be informed of an action without the user needing to look at the device since the user senses the band being tightened around the wrist or other body part.

[0044] In this example the apparatus in which the activity is detected can be part of the band that is fitted around the body part of the user. Alternatively, the apparatus in which the activity is detected can be a separate apparatus that is configured to communicate with a

processing unit in the band over a suitable wireless communication connection.

[0045] Without in any way limiting the scope, interpretation, or application of the claims appearing below, a technical effect of one or more of the example embodiments disclosed herein is to provide that one size band fits all. There may be settings in a memory comprising parameters that define how the band shall fit to a user. There may be for example a setting that defines the pressure with which the band is in contact with the skin of the user and/ or a setting that defines certain curvature for the band. When the band is fitted to a new user these settings and appropriate sensors and other mechanisms are used for providing fitting that corresponds to the settings. In an example embodiment these setting are user-adjustable. In an example embodiment one or more of the following mechanisms are included in the band for ensuring that the band fits any user (for controlling bending of the band so that the parameters defined in the settings are met): a pressure sensor configured to detect band's compression force against the skin of the user, a strain-gauge transducer configured to detect curvature of the band, a shape memory alloy actuator configured to detect curvature of the band (the resistance of a shape memory alloy wire changes when the length of the wire changes and this can be used for curvature detection).

[0046] Another technical effect of one or more of the example embodiments disclosed herein is improved user experience due to the band being tightened only when sensors collect data. Another technical effect of one or more of the example embodiments disclosed herein is to provide reliable measuring due to the band being tightened with the same force every time. Another technical effect of one or more of the example embodiments disclosed herein is to provide possibility for new type of user interaction. For example, the band can be configured to tighten for an indication of an incoming call or text message or as an indication of some other action taking place. As another example of user interaction, the band can be configured to tighten and loosen in cycle to provide vibrating feedback.

[0047] If desired, the different functions discussed herein may be performed in a different order and/or concurrently with each other. Furthermore, if desired, one or more of the above-described functions may be optional or may be combined.

[0048] The invention is defined by the independent claims. Preferred embodiments are set out in the dependent claims.

[0049] It is also noted herein that while the above describes example embodiments of the invention, these descriptions should not be viewed in a limiting sense. Rather, there are several variations and modifications which may be made without departing from the scope of the present invention as defined in the appended claims.

Claims

1. An apparatus (100, 300, 500, 550, 600) comprising:
 - an elongated apparatus structure (110, 510) configured to fit around a body part of a user; at least one sensor; and
 - an actuator (630) configured to change shape of the elongated apparatus structure (110, 510); wherein the actuator (630) is configured to tighten the elongated apparatus structure (110, 510) around the body part of the user in response to the sensor initiating collection of data and to loosen the elongated apparatus structure (110, 510) around the body part of the user in response to the sensor ending collection of data, and wherein
 - the actuator (630) is further configured to tighten or loosen the elongated apparatus structure (110, 510) around the body part of the user as an indication of activity in the apparatus.
2. An apparatus according to claim 1, wherein the actuator (630) is configured to periodically tighten and loosen the elongated apparatus structure (110, 510) around the body part of the user as an indication of activity in the apparatus.
3. An apparatus according to claim 1, wherein the sensor is configured to measure heart rate or skin moisture or blood pressure.
4. An apparatus according to claim 1, wherein the actuator (630) comprises shape memory material.
5. An apparatus according to claim 1, wherein the actuator (630) comprises a motor.
6. An apparatus according to claim 1, further comprising a memory, a communications unit and a processing unit (640) configured to control the actuator (630) to change tightness the elongated apparatus structure around the body part as an indication of activity in the processing unit.
7. An apparatus according to claim 1, further comprising a memory, a communications unit and a processing unit (640), wherein:
 - the processing unit and the elongated apparatus structure (110, 510) are physically separate; and
 - the processing unit is configured to control, over a wireless communication connection, the actuator (630) to change tightness the elongated apparatus structure around the body part.
8. An apparatus according to claim 1, further comprising a memory, a processor (640) and a communica-

tions unit, wherein the actuator (630) is configured to change tightness of the elongated apparatus structure (110, 510) around the body part of the user as an indication of an incoming call or message received at the communications unit.

9. A method comprising

controlling an apparatus (100, 300, 500, 550, 600) comprising an elongated apparatus structure (110, 510) configured to fit around a body part of a user, at least one sensor and an actuator (630) configured to change shape of the elongated apparatus structure (110, 510);
controlling the actuator (630) to tighten the elongated apparatus structure (110, 510) around the body part of the user in response to the sensor initiating collection of data and to loosen the elongated apparatus structure (110, 510) around the body part of the user in response to the sensor ending collection of data, and
controlling the actuator (630) to tighten or loosen the elongated apparatus structure (110, 510) around the body part of the user as an indication of activity in the apparatus (920).

10. A method according to claim 9, comprising controlling the actuator (630) to periodically tighten and loosen the elongated apparatus structure (110, 510) around the body part of the user as an indication of activity in the apparatus.

Patentansprüche

1. Vorrichtung (100, 300, 500, 550, 600) umfassend:

eine längliche Vorrichtungsstruktur (110, 510), die so ausgelegt ist, dass sie um einen Körperteil eines Benutzers passt;
mindestens einen Sensor und
einen Aktor (630), der so ausgelegt ist, dass er eine Form der länglichen Vorrichtungsstruktur (110, 510) ändert;
wobei der Aktor (630) so ausgelegt ist, dass er die längliche Vorrichtungsstruktur (110, 510) in Reaktion darauf, dass der Sensor Datensammlung initiiert, um den Körperteil des Benutzers festzieht, und die längliche Vorrichtungsstruktur (110, 510) in Reaktion darauf, dass der Sensor die Sammlung von Daten beendet, um den Körperteil des Benutzers lockert, und wobei der Aktor (630) ferner so ausgelegt ist, dass er die längliche Vorrichtungsstruktur (110, 510) um den Körperteil des Benutzers als eine Anzeige von Aktivität in der Vorrichtung festzieht oder lockert.

2. Vorrichtung nach Anspruch 1, wobei der Aktor (630) so ausgelegt ist, dass er die längliche Vorrichtungsstruktur (110, 510) um den Körperteil des Benutzers als eine Anzeige von Aktivität in der Vorrichtung periodisch festzieht oder lockert.

3. Vorrichtung nach Anspruch 1, wobei der Sensor zum Messen von Herzfrequenz oder Hautfeuchtigkeit oder Blutdruck ausgelegt ist.

4. Vorrichtung nach Anspruch 1, wobei der Aktor (630) Formgedächtnismaterial umfasst.

5. Vorrichtung nach Anspruch 1, wobei der Aktor (630) einen Motor umfasst.

6. Vorrichtung nach Anspruch 1, ferner umfassend einen Speicher, eine Kommunikationseinheit und eine Verarbeitungseinheit (640), die so ausgelegt ist, dass sie den Aktor (630) so steuert, dass er die Straffheit der länglichen Vorrichtungsstruktur um den Körperteil als eine Anzeige von Aktivität in der Verarbeitungseinheit ändert.

7. Vorrichtung nach Anspruch 1, ferner umfassend einen Speicher, eine Kommunikationseinheit und eine Verarbeitungseinheit (640), wobei:
die Verarbeitungseinheit und die längliche Vorrichtungsstruktur (110, 510) physisch getrennt sind; und
die Verarbeitungseinheit so ausgelegt ist, dass sie den Aktor (630) über eine drahtlose Kommunikationsverbindung so steuert, dass er die Straffheit der länglichen Vorrichtungsstruktur um den Körperteil ändert.

8. Vorrichtung nach Anspruch 1, ferner umfassend einen Speicher, eine Verarbeitungseinheit (640) und eine Kommunikationseinheit, wobei der Aktor (630) so ausgelegt ist, dass er die Straffheit der länglichen Vorrichtungsstruktur um den Körperteil des Benutzers als eine Anzeige eines eingehenden Anrufs oder einer eingehenden Nachricht, der/die an der Kommunikationseinheit empfangen wird, ändert.

9. Verfahren, umfassend:

Steuern einer Vorrichtung (100, 300, 500, 550, 600) mit einer länglichen Vorrichtungsstruktur (110, 510), die so ausgelegt ist, dass sie um einen Körperteil eines Benutzers passt, mindestens einem Sensor und einem Aktor (630), der zum Ändern der Form der länglichen Vorrichtungsstruktur (110, 510) ausgelegt ist;
derartiges Steuern des Aktors (630), dass er die längliche Vorrichtungsstruktur (110, 510) in Reaktion darauf, dass der Sensor Datensammlung initiiert, um den Körperteil des Benutzers festzieht, und die längliche Vorrichtungsstruktur

(110, 510) in Reaktion darauf, dass der Sensor die Sammlung von Daten beendet, um den Körperteil des Benutzers lockert, und derartiges Steuern des Aktors (630), dass er die längliche Vorrichtungsstruktur (110, 510) um den Körperteil des Benutzers als eine Anzeige von Aktivität in der Vorrichtung (920) festzieht oder lockert.

10. Verfahren nach Anspruch 9, umfassend ein derartiges Steuern des Aktors (630), dass er die längliche Vorrichtungsstruktur (110, 510) um den Körperteil des Benutzers als eine Anzeige von Aktivität in der Vorrichtung periodisch festzieht oder lockert.

Revendications

1. Appareil (100, 300, 500, 550, 600) comprenant :

une structure d'appareil allongée (110, 510) configurée pour s'installer autour d'une partie du corps d'un utilisateur ;

au moins un capteur ; et

un actionneur (630) configuré pour modifier la forme de la structure d'appareil allongée (110, 510) ;

dans lequel l'actionneur (630) est configuré pour resserrer la structure d'appareil allongée (110, 510) autour de la partie du corps de l'utilisateur en réponse à l'initiation par le capteur d'une collecte de données et pour desserrer la structure d'appareil allongée (110, 510) autour de la partie du corps de l'utilisateur en réponse à l'interruption par le capteur de la collecte de données, et dans lequel

l'actionneur (630) est également configuré pour resserrer ou desserrer la structure d'appareil allongée (110, 510) autour de la partie du corps de l'utilisateur en tant qu'indication d'une activité dans l'appareil.

2. Appareil selon la revendication 1, dans lequel l'actionneur (630) est configuré pour resserrer et desserrer périodiquement la structure d'appareil allongée (110, 510) autour de la partie du corps de l'utilisateur en tant qu'indication d'une activité dans l'appareil.

3. Appareil selon la revendication 1, dans lequel le capteur est configuré pour mesurer une fréquence cardiaque ou une humidité de la peau ou une pression artérielle.

4. Appareil selon la revendication 1, dans lequel l'actionneur (630) comprend un matériau à mémoire de forme.

5. Appareil selon la revendication 1, dans lequel l'actionneur (630) comprend un moteur.

6. Appareil selon la revendication 1, comprenant en outre une mémoire, une unité de communication et une unité de traitement (640) configurée pour commander l'actionneur (630) pour modifier la tension de la structure d'appareil allongée autour de la partie du corps en tant qu'indication d'une activité dans l'unité de traitement.

7. Appareil selon la revendication 1, comprenant en outre une mémoire, une unité de communication et une unité de traitement (640), dans lequel :

15

l'unité de traitement et la structure d'appareil allongée (110, 510) sont physiquement séparées ;

et l'unité de traitement est configurée pour commander, sur une connexion de communication sans fil, l'actionneur (630) pour modifier la tension de la structure d'appareil allongée autour de la partie du corps.

20

8. Appareil selon la revendication 1, comprenant en outre une mémoire, un processeur (640) et une unité de communication, dans lequel l'actionneur (630) est configuré pour modifier la tension de la structure d'appareil allongée (110, 510) autour de la partie du corps de l'utilisateur en tant qu'indication d'un appel ou message entrant reçu au niveau de l'unité de communication.

30

9. Procédé comprenant la commande d'un appareil (100, 300, 500, 550, 600) comprenant une structure d'appareil allongée (110, 510) configurée pour s'installer autour d'une partie du corps d'un utilisateur, au moins un capteur et un actionneur (630) configuré pour modifier la forme de la structure d'appareil allongée (110, 510) ;

35

la commande de l'actionneur (630) pour resserrer la structure d'appareil allongée (110, 510) autour de la partie du corps de l'utilisateur en réponse à l'initiation par le capteur d'une collecte de données et pour desserrer la structure d'appareil allongée (110, 510) autour de la partie du corps de l'utilisateur en réponse à l'interruption par le capteur de la collecte de données, et

45

la commande de l'actionneur (630) pour resserrer ou desserrer la structure d'appareil allongée (110, 510) autour de la partie du corps de l'utilisateur en tant qu'indication d'une activité dans l'appareil (920).

50

10. Procédé selon la revendication 9, comprenant la commande de l'actionneur (630) pour resserrer et desserrer périodiquement la structure d'appareil allongée (110, 510) autour de la partie du corps de l'utilisateur en tant qu'indication d'une activité dans l'appareil.

55

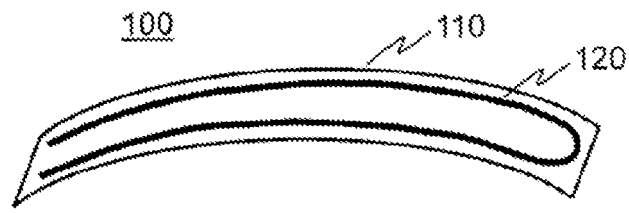

Fig. 1

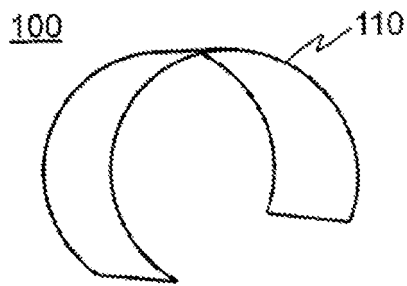
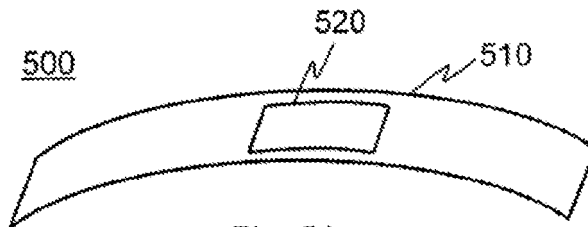
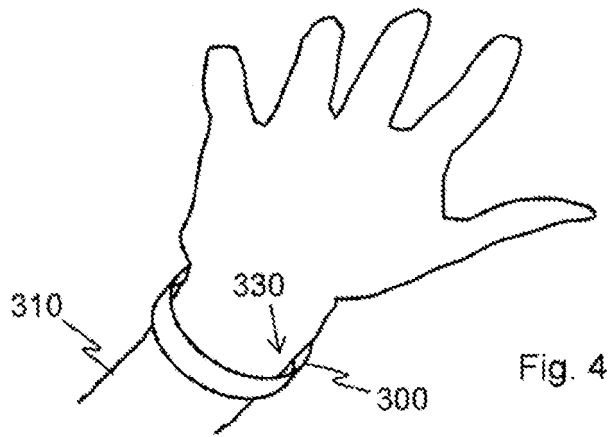
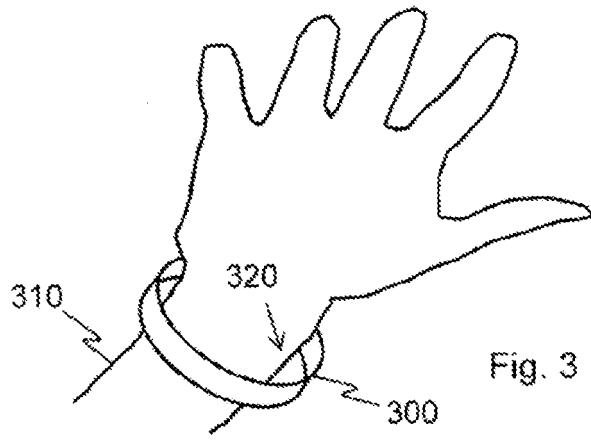

Fig. 2



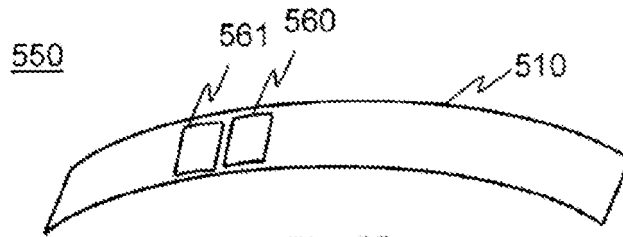

Fig. 5B

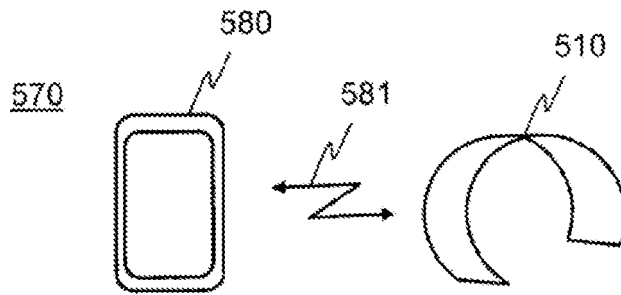

Fig. 5C

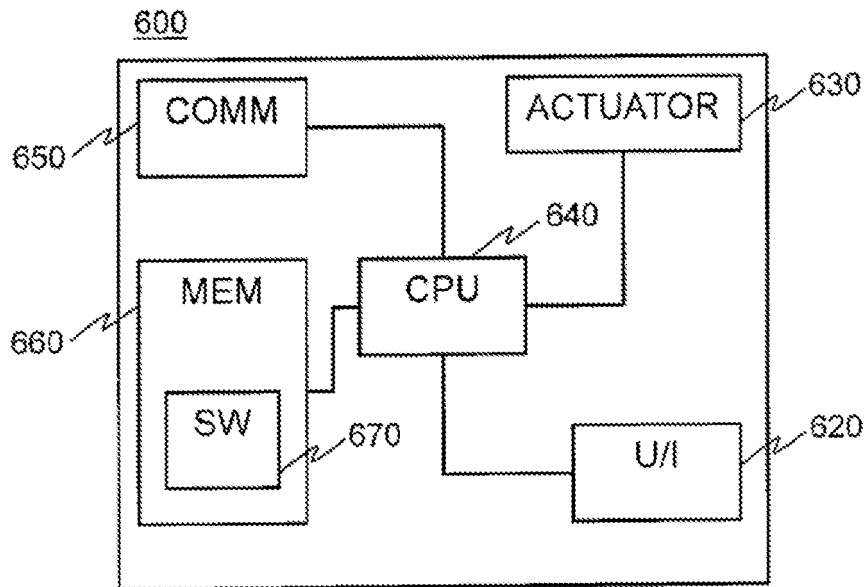

Fig. 6

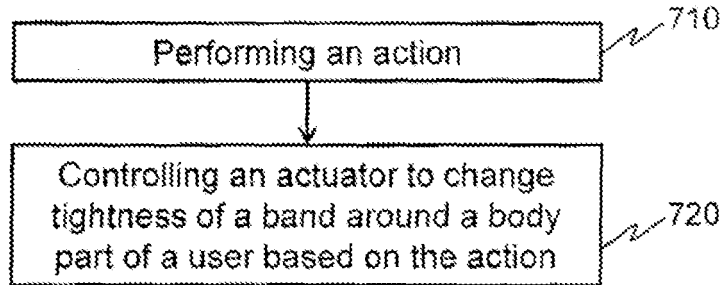

Fig. 7

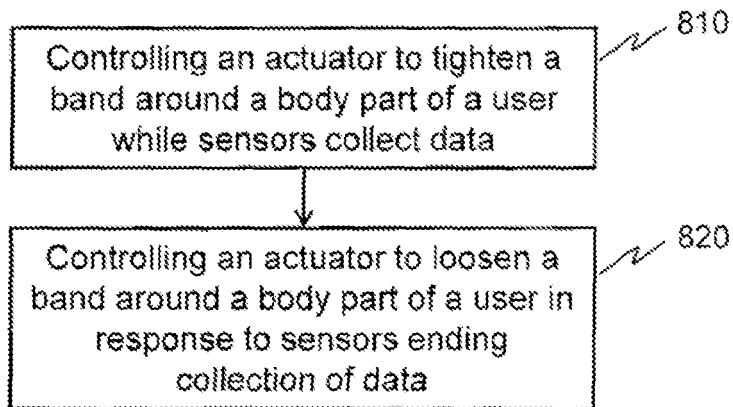

Fig. 8

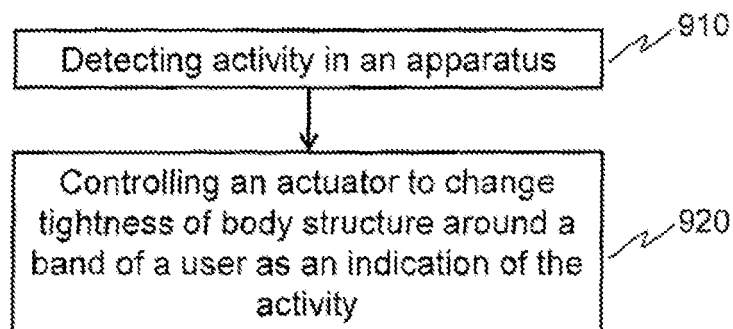

Fig. 9

REFERENCES CITED IN THE DESCRIPTION

This list of references cited by the applicant is for the reader's convenience only. It does not form part of the European patent document. Even though great care has been taken in compiling the references, errors or omissions cannot be excluded and the EPO disclaims all liability in this regard.

Patent documents cited in the description

- US 2008058620 A [0003]
- US 2003181116 A [0004]
- US 8344862 B [0005]
- JP 2004147263 A [0006]

专利名称(译)	可穿戴电子设备		
公开(公告)号	EP3050035B1	公开(公告)日	2018-09-19
申请号	EP2014850070	申请日	2014-08-05
[标]申请(专利权)人(译)	诺基亚技术有限公司		
申请(专利权)人(译)	NOKIA TECHNOLOGIES OY		
当前申请(专利权)人(译)	NOKIA TECHNOLOGIES OY		
[标]发明人	KOSONEN MATTI MYRYLAINEN SAMI		
发明人	KOSONEN, MATTI MYRYLÄINEN, SAMI		
IPC分类号	G08B7/06 H04M1/725 A61B5/00 A61B5/02 A61B5/021		
CPC分类号	A61B5/021 A61B5/024 A61B5/6843 G08B6/00 H04M1/7253 H04M19/04 H04M2250/12 H04M3/02 H04M3/42136		
优先权	14/039043 2013-09-27 US		
其他公开文献	EP3050035A4 EP3050035A1		
外部链接	Espacenet		

摘要(译)

一种装置，包括：细长装置结构，配置为围绕使用者的身体部分配合；以及致动器，配置为改变细长装置结构的形状。致动器被配置为基于装置正在执行的动作来改变细长装置结构围绕用户的身体部分的紧密度。