

(19) World Intellectual Property Organization  
International Bureau



(43) International Publication Date  
15 February 2001 (15.02.2001)

PCT

(10) International Publication Number  
WO 01/10291 A1

(51) International Patent Classification<sup>7</sup>: A61B 1/045,  
5/01, G01K 13/00

MERON, Gavriel [IL/IL]; Weizman Street 21, 49556 Kfar  
Ganim, Petach Tikva (IL). IDAN, Gavriel [IL/IL]; Ein-  
stein Street 44a, 34602 Haifa (IL).

(21) International Application Number: PCT/IL00/00470

(74) Agent: EITAN, PEARL, LATZER & CO-  
HEN-ZEDEK; Gav Yam Center 2, Shenkar Street 7,  
46725 Herzlia (IL).

(22) International Filing Date: 3 August 2000 (03.08.2000)

(25) Filing Language: English

(81) Designated States (national): AE, AG, AL, AM, AT, AU,  
AZ, BA, BB, BG, BR, BY, BZ, CA, CH, CN, CR, CU, CZ,  
DE, DK, DM, DZ, EE, ES, FI, GB, GD, GE, GH, GM, HR,  
HU, ID, IL, IN, IS, JP, KE, KG, KP, KR, KZ, LC, LK, LR,  
LS, LT, LU, LV, MA, MD, MG, MK, MN, MW, MX, MZ,  
NO, NZ, PL, PT, RO, RU, SD, SE, SG, SI, SK, SL, TJ, TM,  
TR, TT, TZ, UA, UG, US, UZ, VN, YU, ZA, ZW.

(26) Publication Language: English

(30) Priority Data:  
131242 4 August 1999 (04.08.1999) IL

(71) Applicant (for all designated States except US): GIVEN  
IMAGING LTD. [IL/IL]; Industrial Park, Building 7b, 4th  
Floor, 20692 Yokneam Ilite (IL).

(84) Designated States (regional): ARIPO patent (GH, GM,  
KE, LS, MW, MZ, SD, SL, SZ, TZ, UG, ZW), Eurasian  
patent (AM, AZ, BY, KG, KZ, MD, RU, TJ, TM), European  
patent (AT, BE, CH, CY, DE, DK, ES, FI, FR, GB, GR, IE,  
IT, LU, MC, NL, PT, SE), OAPI patent (BF, BJ, CF, CG,  
CI, CM, GA, GN, GW, ML, MR, NE, SN, TD, TG).

(72) Inventors; and

(75) Inventors/Applicants (for US only): GLUKHOVSKY,  
Arkady [IL/IL]; Hanuriot Street 24/5, 36790 Nesher (IL).

[Continued on next page]

(54) Title: A METHOD FOR TEMPERATURE SENSING

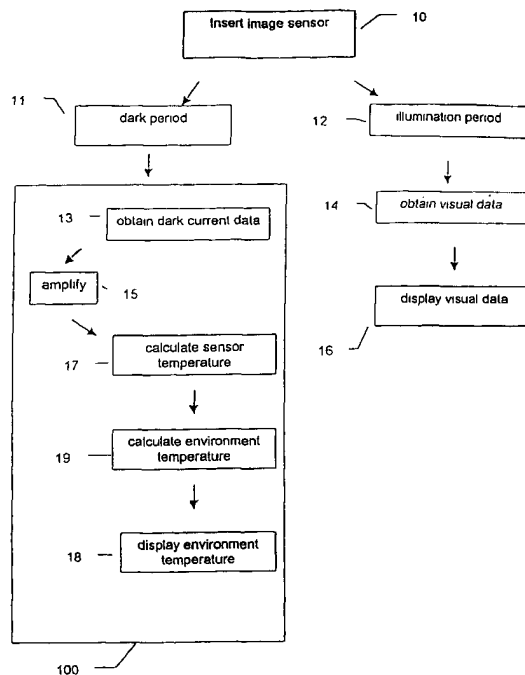

(57) Abstract: A method and system for sensing the temperature of an environment. An image sensor (20), having an image sensing module (42), is introduced into an environment. The temperature of the image sensor is calculated from the sensed dark current noise of the image sensor. The temperature of the environment is calculated and optionally displayed. The system and method are also implemented in a medical device (30).



WO 01/10291 A1



**Published:**

- *With international search report.*
- *Before the expiration of the time limit for amending the claims and to be republished in the event of receipt of amendments.*

*For two-letter codes and other abbreviations, refer to the "Guidance Notes on Codes and Abbreviations" appearing at the beginning of each regular issue of the PCT Gazette.*

## A METHOD FOR TEMPERATURE SENSING

### FIELD OF THE INVENTION

The present invention relates to a method and system for measuring the  
5 temperature of an environment, such as the interior of the body.

### BACKGROUND OF THE INVENTION

In many circumstances it is important to measure the temperature inside  
a material body. Such circumstances may occur during industrial processes or  
10 exploration and analysis processes, such as in geophysical probing or in medical  
diagnostics and treatment of internal parts of the body.

Conventional thermometry and absolute thermometry are known  
methods for measuring temperature.

Conventional thermometry is based upon the temperature coefficient of  
15 properties of materials, such as resistance or mechanical expansion.

Absolute thermometry is a method which directly measures thermal  
energy of a sensor resistance. This method is based upon the known physical  
phenomenon of spontaneous thermal noise arising from the Brownian motion of  
ionized molecules within a resistance.

20 Thermal noise, which can be discussed in terms of thermal current,  
provides a direct measurement of temperature on a thermodynamic scale, thus  
the Boltzmann constant defines the temperature. The phenomenon of thermal

noise is derived, for example, in the book: *CCD arrays cameras and displays* by Holst G.C., p. 128, 2<sup>nd</sup> edition, SPIE Press, 1998. The formula used to define thermal current is:

$$\langle i_n^2 \rangle = k T C$$

5 where  $k$  is the Boltzmann constant,  $T$  is the temperature of a sensor, and  $C$  is the capacitance of the sensor. Thus the magnitude of the signals produced by the thermal current is directly proportional to the square root of the temperature of the sensor. Experiments have indicated that the signal doubles with the increase of 7°C (degrees Centigrade), which means that a resolution better than 0.1°C is  
10 achieved.

In image sensors, the thermal current produced in an operating photodetector device, when no optical radiation impinges on the detector, is called "dark current". In CCD cameras dark current is basically charge which accumulates in the CCD pixels due to thermal noise. The effect of dark current is  
15 to produce an additive quantity to the electron count in each pixel.

US 3,937,086 to von Thuna, US 5,354,130 to Seppa et al. and US 5,098,197 to Shepard et al. all describe devices for measuring the absolute temperature of a body material by receiving and analyzing the thermal noise of the body material.

20 US 4,246,784 to Bowen describes a method for noninvasive temperature measurement of the interior of a body using the acoustic thermal noise spectrum of the measured body.

None of these temperature measurement methods utilize an image sensor to measure the thermal noise of a body material.

## SUMMARY OF THE INVENTION

The present invention provides a method and system for sensing the temperature of an environment, such as inside a body, by calculating the temperature of an image sensor in the environment and deducing the environment's temperature from the image sensor's calculated temperature. The temperature of the image sensor is calculated by measuring its generated dark current noise.

The method and system of the present invention have the advantage of utilizing an image sensor, in which thermal noise is easily detectable, for deducing the temperature of a material body. Furthermore, according to the invention, a single sensor is utilized for obtaining visual data and data relating to the temperature of the environment. Thus, diverse information about an environment can be obtained utilizing a single sensing device.

There is thus provided according to the present invention a method for sensing the temperature of an environment comprising the steps of introducing into an environment an image sensor having an image sensing module, sensing the dark current noise of the image sensor, calculating the temperature of the image sensor, calculating the temperature of the environment and optionally displaying the calculated environment temperature.

It will be appreciated that the term "environment" in the present invention relates to a space enclosed within walls in which it is desired to measure the temperature of the space and/or of the walls.

The temperature of the image sensor is indicative of the temperature of its immediate surroundings and, relying on known factors such as heat distribution, distance from the image sensor, etc., the temperature of further areas can also be calculated.

5 The image sensors utilized in the invention can be digital cameras or video cameras such as vidoicon , CCD cameras or CMOS cameras.

The present invention further provides a system for sensing the temperature of an environment. The system comprises an image sensor having an image sensing module in communication with an integrating unit for detecting  
10 the dark current of the image sensor image sensing module and for calculating the temperature of the image sensor. The integrating unit may further calculate the temperature of the environment or the temperature of the environment may be calculated, based on data from the integrating unit, by a separate unit that is in communication with the integrating unit.

15 The integrating unit may have an amplifying function for amplifying signals received from the image sensor.

The communication between the image sensor and integrating unit can be optionally controlled according to the illumination conditions, optionally through a switch which enables communication only during periods in which the sensor is  
20 not illuminated.

## BRIEF DESCRIPTION OF THE FIGURES

The present invention will be understood and appreciated more fully from the following detailed description taken in conjunction with the figures in which:

5           Figure 1 is a block diagram representing an embodiment of the method according to the invention;

          Figure 2 is a schematic illustration of an embodiment of the system according to the invention;

10           Figure 3 is a schematic illustration of a functional block layout of the image sensor according to the invention; and

          Figure 4 is a schematic illustration of a medical device comprising the system according to the invention.

15

## DETAILED DESCRIPTION OF THE INVENTION

Analytical and diagnostic processes which utilize image sensors to monitor environments could benefit from obtaining information relating to the temperature of the environment, as a local change of temperature can indicate an  
20 irregular event.

For example, US 5,604,531, which is assigned to the common assignees of the present application, describes a swallowable capsule that can pass through the entire digestive tract and operate as an autonomous video endoscope. US 5,604,531, is hereby incorporated by reference. The swallowable

capsule includes a) a camera system, b) an optical system for imaging an area of interest onto the camera system and c) a transmitter which transmits the video output of the camera system. Visual data obtained by the swallowable capsule can indicate, inter alia, the location of pathologies in the gastrointestinal tract. Also  
5 a local change of temperature in the gastrointestinal tract can be indicative of a pathology. Thus, the information obtained by visual means can be complemented and focussed by information relating to local temperature in the gastrointestinal tract.

The method of the present invention enables contemporary visual  
10 monitoring and temperature sensing.

The method is schematically described by a block diagram shown in Fig. 1. An image sensor, such as in the above mentioned swallowable capsule, is inserted  
10 into an environment, such as the gastrointestinal tract.

Illumination is provided intermittently, either by elements connected to the  
15 image sensor itself or by external sources. When illumination is provided 12 only visual data is obtained 14 and displayed 16. A process for obtaining and displaying visual data is described, for example, in the above mentioned US 5,604,531.

In an intermittent dark period 11 an integrating unit 100 is activated to  
20 obtain dark current data 13 from the image sensor, though it is not imperative to shut off illumination in order to obtain data relating to dark current noise, as will be discussed in more detail below.

The integrating unit 100 is a processor capable of amplifying the obtained data 15, if necessary, and calculating the image sensor temperature 17 using the known equations derived for thermal noise. It will be appreciated that these equations are an approximation of a complex phenomenon and that calibration  
5 should be employed in order to deduce the actual calculations that will be applied.

The environment temperature is then calculated 19, either by the integrating unit 100 or by a separate unit in communication with the integrating unit 100. Calculations of the environment temperature are based on the  
10 existence of thermal equilibrium between the image sensor and environment. These calculations take into account energy dissipation from the image sensor. Local temperature or the average temperature within the environment may be calculated, depending on specific requirements. The calculated temperature may then be displayed 18.

15 It will be appreciated that the various calculations are carried out by software or software means executable on computing means such as a computer or similar data processors, microprocessors, embedded processors, microcomputers, microcontrollers etc.,

The integrating unit 100 may comprise separate processors, which need  
20 not all be physically connected. Some of the functions carried out by integrating unit 100, such as calculating the image sensor temperature 17 and calculating the environment temperature 19, can be carried out in processors that are external to the environment and that are fed with data from the integrating unit 100 by communication such as by IR or radio. Indeed, if an operator is to note

the temperature of the environment, at least the function of displaying the calculated temperature 18 must be performed externally to the environment.

Integrating unit 100 may be in communication with other units to further process and use the data obtained by it. For example, a swallowable capsule, such as described in US 5,604,531, may comprise a sample chamber for collecting samples from the environment of the digestive tract. The process of collecting a sample can be controlled by integrating unit 100, such that samples are collected only in locations along the digestive tract in which a predetermined temperature is prevalent.

Reference is now made to Fig. 2 which is a schematic illustration of the system according to an embodiment of the invention. The system comprises an image sensor 20 having an image sensing module which includes a pixel array (as demonstrated in Fig. 3) in communication with an integrating unit 22. Communication is enabled by temperature sense switch 24 which is controlled by illumination indicator 26, such that communication is enabled only during dark periods.

When communication between the image sensor 20 and integrating unit 22 is established, integrating unit 22 receives dark current data from image sensor 20.

As will be discussed below, it is possible to calculate the image sensor's temperature based on dark current data obtained from a single pixel of the image sensor pixel array, though data obtained from a higher number of pixels will achieve more accurate results. It is therefore possible to keep a portion of the image sensor's pixels of the pixel array, constantly unexposed to illumination,

and obtain dark current data from the unexposed pixels, without having to shut off the illumination.

Thus, dark current data can be obtained also during constant illumination by either covering a portion of the pixels of the pixel array or by having  
5 a portion of the pixel array pixels outside of the image field, e.g. the pixels in the periphery of the pixel array .

The integrating unit 22 is a processor capable of amplifying the dark current signal and calculating the image sensor temperature from the dark current signal. It is further capable of calculating the environment temperature from the  
10 image sensor temperature and is capable of displaying the calculated environment temperature 21. Integrating unit 22 may control different temperature sensitive units 28, such as the sample chamber described above, in correspondence with predetermined temperatures.

Reference is now made to Fig. 3 which is a schematic illustration of a  
15 functional block layout of the image sensor according to the invention. The image sensor comprises a single chip 40 having an image sensing module 42 and a control circuits area 44. The image sensing module 42 includes a pixel array 48 for capturing an image. The control circuits area 44 includes the timing and logic circuitry 47 and A/D circuitry 46.

20 Signals can be received from all the pixels of the pixel array 48. Dark current is received from pixels that are not illuminated or from pixels during a dark period whereas current signals received from an illuminated pixel are the summation of the dark current and light current of the pixel. The accumulation of signals from all the pixels is converted to data which is communicated through a

transmitter to the integrating unit for decoding and for displaying a visual representation and /or the temperature derived from the data.

The system of the invention will be further described and demonstrated by Fig. 4 which is a schematic illustration of a medical device comprising a system  
5 according to the invention.

The medical device illustrated in Fig 4 is a swallowable capsule, generally referenced 30, such as that described in the above mentioned US 5,604,531. Swallowable capsule 30 comprises a CMOS camera 32, that is in communication with integrating unit 34. The swallowable capsule 30 further  
10 comprises illuminating elements 36 that are in communication with illumination indicator 33. The gastrointestinal tract walls 31 are illuminated by illuminating elements 36, in intermittent pulses, capturing consecutive images of the gastrointestinal tract walls 31 by camera 32, enabling an operator to view the gastrointestinal tract walls. Communication between camera 32 and integrating  
15 unit 34 is enabled in between illumination pulses when illumination indicator 33, sensing the lack of illumination, activates the temperature sense switch (not shown) to an ON position.

Alternatively, the illumination indicator 33 may be activated by the operator to simultaneously turn off the illumination elements 36 and switch the  
20 temperature sense switch to an ON position.

Once communication is established between camera 32 and integrating unit 34 dark current signals generated from camera 32 are received and processed, as described above, by integrating unit 34. The calculated

gastrointestinal temperature is displayed on a display unit external to the gastrointestinal tract.

Swallowable capsule 30 further comprises a sample chamber 35 for collecting samples from the gastrointestinal tract environment. The collected  
5 sample may be cells from the gastrointestinal tract walls or a liquid sample from the gastrointestinal tract environment. The mechanism for collecting samples, which can be any suitable mechanism known in the art, is controlled by integrating unit 34, such that it is activated in accordance with the gastrointestinal tract environment calculated temperature. Alternatively, the mechanism can be  
10 controlled by the operator based on the displayed temperature.

**CLAIMS .**

1. A method for sensing the temperature of an environment comprising the steps of:

introducing into the environment an image sensor having an  
5 image sensing module;

sensing the dark current noise of the image sensing module;

calculating the temperature of the image sensor from the sensed  
dark current noise; and

calculating the temperature of the environment from the  
10 calculated image sensor temperature.

2. A method according to claim 1 further comprising the step of displaying  
the calculated environment temperature.

3. A method according to claim 1 further comprising a step of amplifying the  
sensed dark current noise prior to the step of calculating the temperature  
15 of the image sensor.

4. A method according to claim 1 wherein the step of sensing the dark  
current noise of the image sensor is performed by an integrating unit that  
is in communication with the image sensor.

5. A method according to claim 3 wherein the sensed dark current noise is  
20 amplified by an integrating unit that is in communication with the image  
sensor.

6. A method according to claim 1 wherein the steps of calculating the temperature of the image sensor and calculating the temperature of the environment are preformed by an integrating unit that is in communication with the image sensor.
- 5 7. A method according to claim 4 wherein anyone of the steps subsequent to the step of sensing the dark current noise of the image sensor is performed by a separate unit that is in communication with the integrating unit.
8. A method according to claim 4 wherein the integrating unit is located  
10 outside of the environment.
9. A method according to claim 7 wherein the separate unit is located outside of the environment.
10. A method according to claim 1 wherein the image sensor is exposed to intermittent illuminated and dark periods.
- 15 11. A method according to claim 10 wherein the step of sensing the dark current noise of the image sensor is preformed during one or more dark periods.
12. A method according to claim 1 wherein the image sensor is a digital or video camera.
- 20 13. A method according to claim 1 wherein the environment is a body cavity.

14. A system for sensing the temperature of an environment comprising an image sensor in communication with an integrating unit,  
said image sensor being introduced into an environment; and  
said integrating unit receiving dark current noise from the image sensor, calculating the temperature of the image sensor, and  
5 calculating the temperature of the environment.
15. A system according to claim 14 wherein the integrating unit amplifies the received dark current noise prior to calculating the temperature of the image sensor, and calculating the temperature of the environment.
- 10 16. A system according to claim 14 wherein one or both calculating the temperature of the image sensor and calculating the temperature of the environment are preformed by a separate unit that is in communication with the integrating unit.
- 15 17. A system according to claim 15 wherein one or more of the steps of amplifying the received dark current noise, calculating the temperature of the image sensor and calculating the temperature of the environment are preformed by a separate unit that is in communication with the integrating unit.
- 20 18. A system according to claim 14 wherein the integrating unit further displays the calculated environment temperature.

19. A system according to claim 18 wherein displaying the calculated environment temperature is preformed by a separate unit that is in communication with the integrating unit.
20. A system according to claim 14 wherein the integrating unit is located  
5 outside of the environment.
21. A system according to claims 16, 17 or 19 wherein the separate unit is located outside of the environment.
22. A system according to claim 14 wherein the image sensor is exposed to intermittent illuminated and dark periods.
- 10 23. A system according to claim 22 further comprising a switch which is in communication with an illumination indicator for receiving indication of illumination, said switch enabling communication between the image sensor and integrating unit only during one or more dark periods.
- 15 24. A system according to claim 14 further comprising a switch which controls illumination elements for exposing the image sensor to intermittent illuminated and dark periods, said switch enabling communication between the image sensor and integrating unit only during one or more dark periods.
- 20 25. A system according to claims 23 or 24 wherein the switch is controlled by an external operator.

26. A system according to claim 14 wherein the integrating unit is in communication with functional units for operating said functional units in accordance with a predetermined temperature.
27. A system according to claim 14 wherein the image sensor is a digital or  
5 video camera.
28. A system according to claim 14 wherein the environment is a body cavity.
29. A medical device comprising the system according to claim 14.
30. A medical device according to claim 29 wherein the device is a swallowable autonomous endoscope.
- 10 31. A medical device comprising the system according to claim 26.
32. A medical device according to claim 31 in which the functional units are units that enable the collection of samples from the environment.
33. Use of the method according to claim 1 in a process of contemporary visual monitoring and temperature sensing of an environment,  
15 substantially as described hereinabove.
34. Use of the system according to claim 14 in a process of contemporary visual monitoring and temperature sensing of an environment, substantially as described hereinabove.

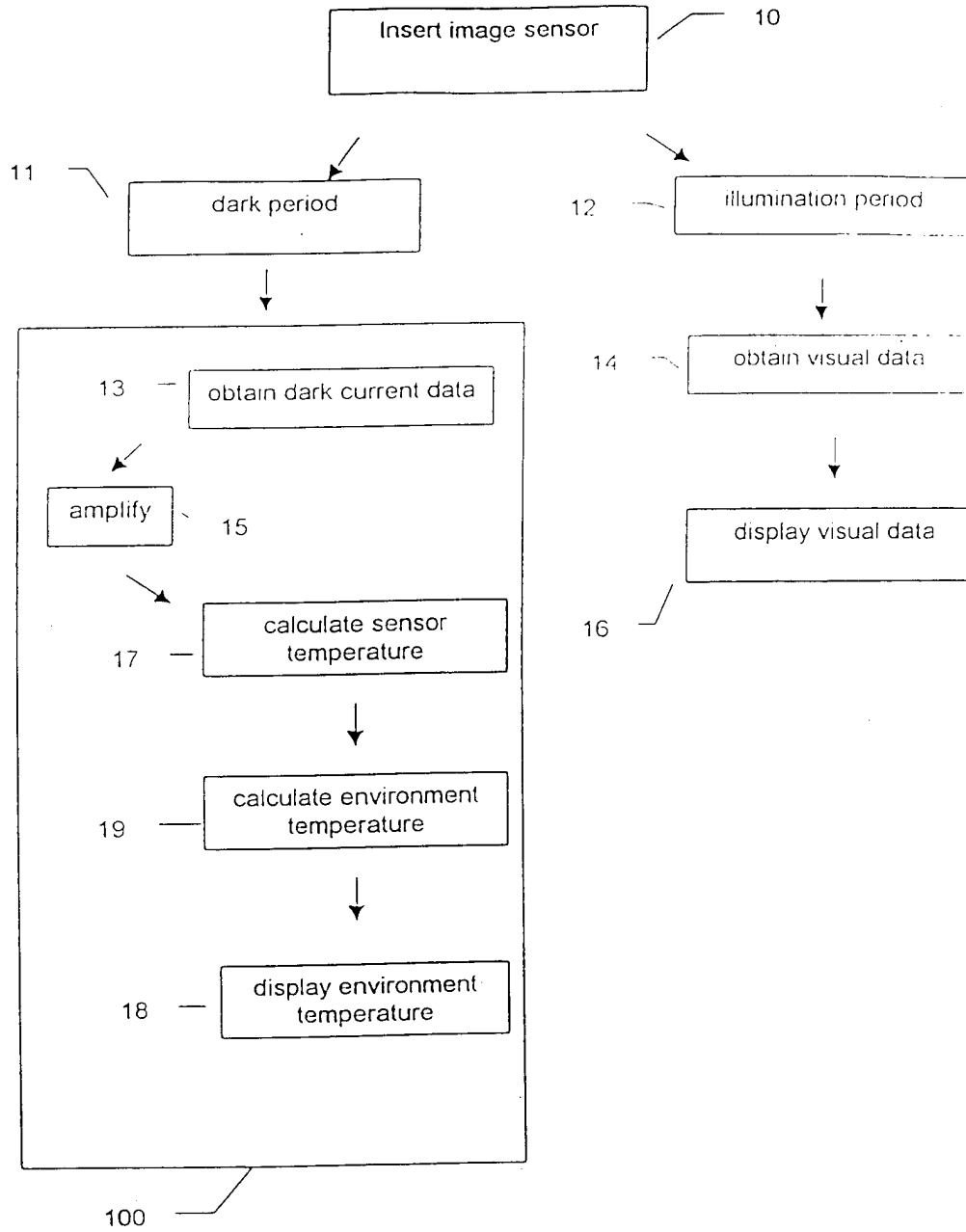

FIGURE 1

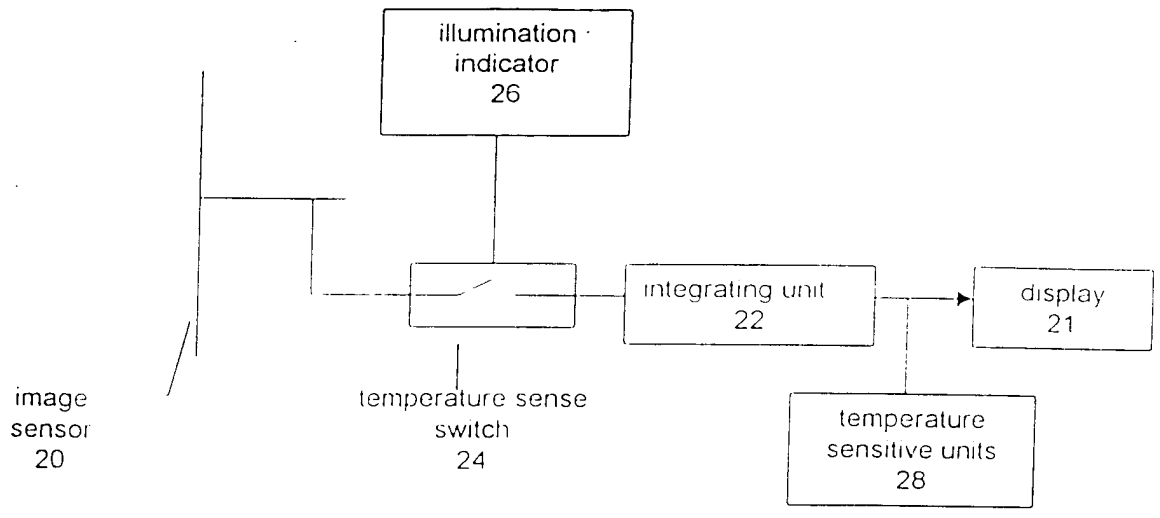

FIGURE 2

3/4

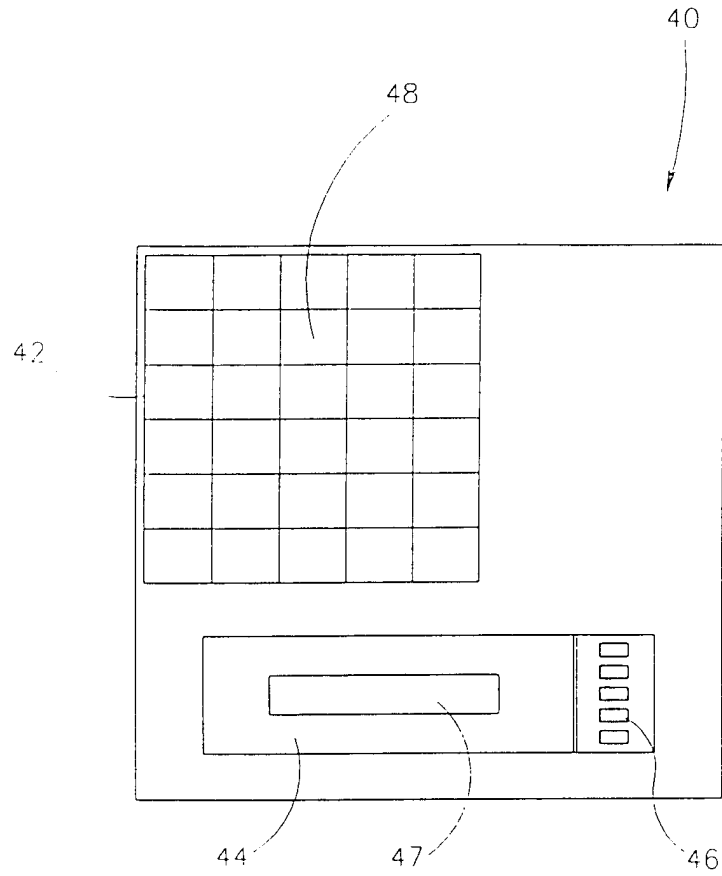

FIG. 3

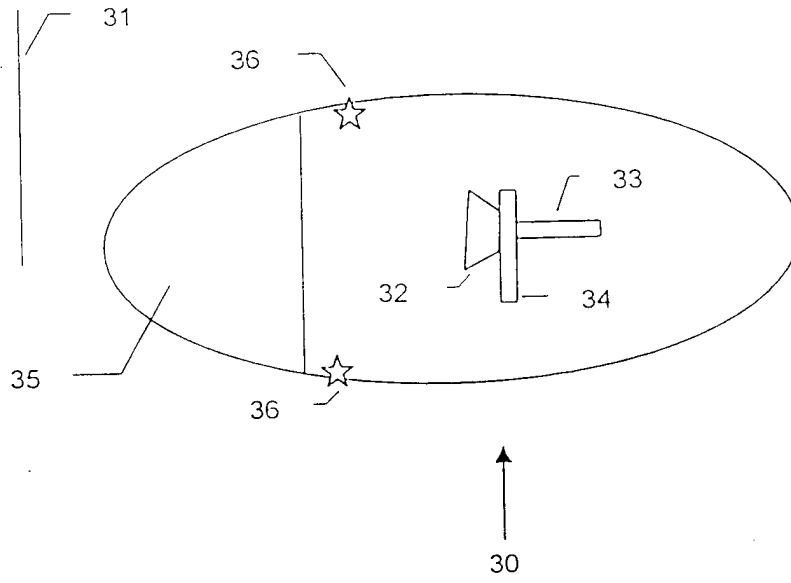

FIGURE 4

INTERNATIONAL SEARCH REPORT

International application No.  
PCT/IL00/00470

**A. CLASSIFICATION OF SUBJECT MATTER**

IPC(7) :A61B 1/045, 5/01; G01K 13/00.  
US CL :600/549, 101; 374/120; 356/222; 348/76  
According to International Patent Classification (IPC) or to both national classification and IPC

**B. FIELDS SEARCHED**

Minimum documentation searched (classification system followed by classification symbols)

U.S. : 374/120, 175; 356/43, 44, 213-226; 600/474, 549,101,109,117,118,127,153,160; 348/65, 74-77, 81-85, 909

Documentation searched other than minimum documentation to the extent that such documents are included in the fields searched

Electronic data base consulted during the international search (name of data base and, where practicable, search terms used)

Please See Extra Sheet.

**C. DOCUMENTS CONSIDERED TO BE RELEVANT**

Category*	Citation of document, with indication, where appropriate, of the relevant passages	Relevant to claim No.
Y	US 5,640,235 A (IWASAKI et al.) 17 June 1997 (17.06.1997), Col. 4, Lines 35-62; Col. 6, Lines 35-51.	1-34
Y	5,604,531 A (IDDAN et al.) 18 February 1997 (18.02.1997), whole document.	1-34
A	US 4,646,724 (SATO et al.) 03 March 1987 (03.03.1987), Col. 7, Lines 34-68.	1, 10, 11

Further documents are listed in the continuation of Box C.  See patent family annex.

* Special categories of cited documents:	"T"	later document published after the international filing date or priority date and not in conflict with the application but cited to understand the principle or theory underlying the invention
"A" document defining the general state of the art which is not considered to be of particular relevance	"X"	document of particular relevance; the claimed invention cannot be considered novel or cannot be considered to involve an inventive step when the document is taken alone
"E" earlier document published on or after the international filing date	"Y"	document of particular relevance; the claimed invention cannot be considered to involve an inventive step when the document is combined with one or more other such documents, such combination being obvious to a person skilled in the art
"L" document which may throw doubts on priority claim(s) or which is cited to establish the publication date of another citation or other special reason (as specified)	"&"	document member of the same patent family
"O" document referring to an oral disclosure, use, exhibition or other means		
"P" document published prior to the international filing date but later than the priority date claimed		

Date of the actual completion of the international search 28 NOVEMBER 2000	Date of mailing of the international search report <b>JAN 19 2001</b>
---	--

Name and mailing address of the ISA/US  
Commissioner of Patents and Trademarks  
Box PCT  
Washington, D.C. 20231  
Facsimile No. (703) 305-3230

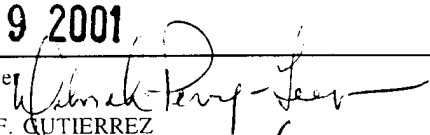
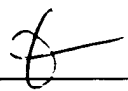
Authorized officer   
DIEGO F. F. GUTIERREZ  
Telephone No. (703) 308-0956 

# INTERNATIONAL SEARCH REPORT

International application No.  
PCT/IL00/00470

## B. FIELDS SEARCHED

Electronic data bases consulted (Name of data base and where practicable terms used):

BRS search in USPAT: DARK CURRENT, JOHNSON NOISE, THERMAL NOISE, SHOT NOISE, IMAG\$3, CAMERA, VIDEO, VIDEOSIGNAL, VIDEOCAMERA, ENDOSCOPE, FALOPSCOPE, LARYNGOSCOPE, ARTHROSCOPE, OTOSCOPE, LAPAROSCOPE, CATHETER. Inventor name search.

专利名称(译)	一种温度传感方法		
公开(公告)号	<a href="#">EP1117323A4</a>	公开(公告)日	2001-12-19
申请号	EP2000951811	申请日	2000-08-03
[标]申请(专利权)人(译)	基文影像公司		
申请(专利权)人(译)	基文影像有限公司.		
当前申请(专利权)人(译)	基文影像有限公司.		
[标]发明人	GLUKHOVSKY ARKADY MERON GAVRIEL IDDAN GAVRIEL		
发明人	GLUKHOVSKY, ARKADY MERON, GAVRIEL IDDAN, GAVRIEL		
IPC分类号	A61B1/00 A61B1/05 A61B5/00 A61B5/01 A61B5/07 G01K7/30 H04N5/335 H04N5/374 A61B1/045 G01K13/00		
CPC分类号	A61B1/041 A61B5/0008 G01K7/30		
优先权	131242 1999-08-04 IL		
其他公开文献	EP1117323B1 EP1117323A1		
外部链接	<a href="#">Espacenet</a>		

#### 摘要(译)

一种用于感测环境温度的方法和系统。将具有图像感测模块 ( 42 ) 的图像传感器 ( 20 ) 引入环境中。根据感测到的图像传感器的暗电流噪声计算图像传感器的温度。计算并可选地显示环境温度。该系统和方法也在医疗设备 ( 30 ) 中实现。