

(12) EUROPEAN PATENT APPLICATION

(43) Date of publication: 08.11.2006 Bulletin 2006/45 (51) Int Cl.: A61B 5/00 (2006.01)

(21) Application number: 06012571.3

(22) Date of filing: 24.03.2000

(84) Designated Contracting States:
AT BE CH CY DE DK ES FI FR GB GR IE IT LI LU
MC NL PT SE

(72) Inventor: The designation of the inventor has not yet been filed

(30) Priority: 25.03.1999 US 126148 P

(74) Representative: Vossius & Partner
Siebertstrasse 4
81675 München (DE)

(62) Document number(s) of the earlier application(s) in accordance with Art. 76 EPC:
00916663.8 / 1 171 025

Remarks:

This application was filed on 19 - 06 - 2006 as a divisional application to the application mentioned under INID code 62.

(71) Applicant: Masimo Corporation
Irvine, CA 92614 (US)

(54) Improved pulse oximeter probe-off detector

(57) An intelligent, rule-based processor (300) provides signal quality based limits to the signal strength operating region of a pulse oximeter. These limits are superimposed on the typical gain dependent signal strength limits (314). If a sensor signal appears physiologically generated, the pulse oximeter is allowed to operate with minimal signal strength, maximizing low perfusion performance. If a sensor signal is potentially due to a signal induced by a dislodged sensor, signal strength requirements are raised. Thus, signal quality limitations

enhance probe off detection without significantly impacting low perfusion performance. One signal quality measure used is pulse rate density (354), which defines the percentage of time physiologically acceptable pulses are occurring. If the detected signal contains a significant portion of unacceptable pulses, the minimum required signal strength is raised proportionately. Another signal quality measure used in conjunction with pulse rate density is energy ratio (352), computed as the percentage of total energy contained in the pulse rate fundamental and associated harmonics.

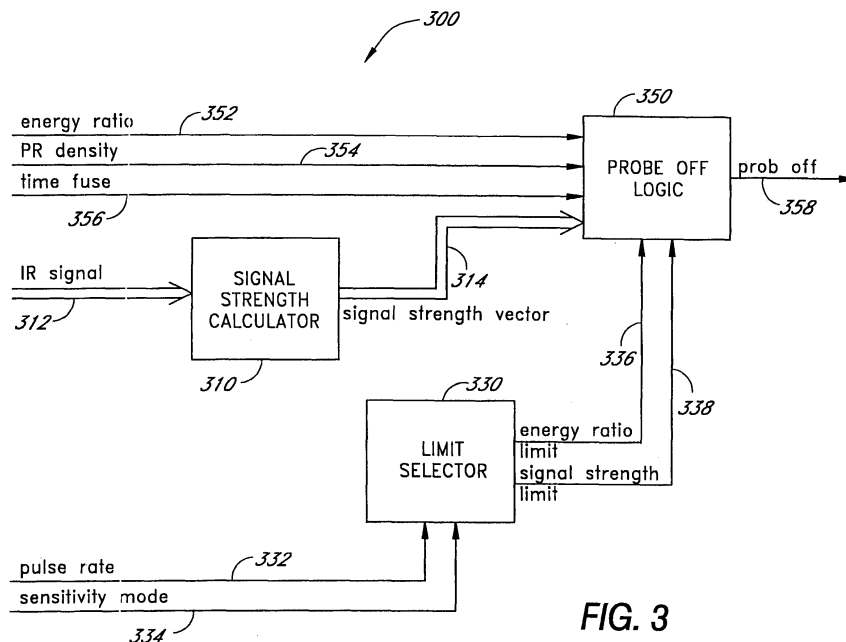

FIG. 3

DescriptionBackground of the Invention

5 **[0001]** Oximetry is the measurement of the oxygen status of blood. Early detection of low blood oxygen is critical in the medical field, for example in critical care and surgical applications, because an insufficient supply of oxygen can result in brain damage and death in a matter of minutes. Pulse oximetry is a widely accepted noninvasive procedure for measuring the oxygen saturation level of arterial blood, an indicator of oxygen supply. A pulse oximetry system consists of a sensor attached to a patient, a monitor, and a cable connecting the sensor and monitor. Conventionally, a pulse oximetry sensor has both red and infrared (IR) light-emitting diode (LED) emitters and a photodiode detector. The sensor is typically attached to a patient's finger or toe, or a very young patient's patient's foot. For a finger, the sensor is configured so that the emitters project light through the fingernail and into the blood vessels and capillaries underneath. The photodiode is positioned at the fingertip opposite the fingernail so as to detect the LED transmitted light as it emerges from the finger tissues.

15 **[0002]** The pulse oximetry monitor (pulse oximeter) determines oxygen saturation by computing the differential absorption by arterial blood of the two wavelengths emitted by the sensor. The pulse oximeter alternately activates the sensor LED emitters and reads the resulting current generated by the photodiode detector. This current is proportional to the intensity of the detected light. The pulse oximeter calculates a ratio of detected red and infrared intensities, and an arterial oxygen saturation value is empirically determined based on the ratio obtained. The pulse oximeter contains circuitry for controlling the sensor, processing the sensor signals and displaying the patient's oxygen saturation and pulse rate. A pulse oximeter is described in U.S. Patent 5,632,272 assigned to the assignee of the present invention.

Summary of the Invention

25 **[0003]** To compute peripheral arterial oxygen saturation, denoted Sp_2O_2 , pulse oximetry relies on the differential light absorption of oxygenated hemoglobin, HbO_2 , and deoxygenated hemoglobin, Hb, to compute their respective concentrations in the arterial blood. This differential absorption is measured at the red and infrared wavelengths of the sensor. In addition, pulse oximetry relies on the pulsatile nature of arterial blood to differentiate hemoglobin absorption from absorption of other constituents in the surrounding tissues. Light absorption between systole and diastole varies due to the blood volume change from the inflow and outflow of arterial blood at a peripheral tissue site. This tissue site might also comprise skin, muscle, bone, venous blood, fat, pigment, etc., each of which absorbs light. It is assumed that the background absorption due to these surrounding tissues is invariant and can be ignored. Accordingly, blood oxygen saturation measurements are based upon a ratio of the time-varying or AC portion of the detected red and infrared signals with respect to the time-invariant or DC portion. This AC/DC ratio normalizes the signals and accounts for variations in light pathlengths through the measured tissue.

30 **[0004]** FIG. 1 illustrates the typical operating characteristics of a pulse oximeter. During a calibration phase, the pulse oximeter input gain is adjusted higher to accommodate opaque skin and lower to accommodate translucent skin at the sensor site. Variations in blood perfusion at the sensor site result in variations in input signal strength. The graph **100** shows acceptable input sensitivity as a function of gain. The y-axis **110** represents the signal strength (SS), which is the ratio of the peak-to-peak **AC** signal to the **DC** signal, expressed as a percentage. The x-axis **120** represents the gain, which is shown with decreasing values along the x-axis. The graph **100** has an unshaded region **130** representing the acceptable operating range of the pulse oximeter and a shaded region **140** representing conditions outside that operating range, which, when detected, will result in a pulse oximeter "probe off" alarm. The operating region **130** has a floor **150** at relatively low gains, representing the highest sensitivity to patients with low perfusion. Because input noise increases with gain, the operating region also has a corner point **160** below which input sensitivity is noise limited and falls off with increasing gain, i.e. increasing opacity.

35 **[0005]** A pulse oximeter with the operating characteristics shown in FIG. 1 may fail to detect a probe off condition. This problem occurs when the sensor becomes partially or completely dislodged from the patient, but continues to detect an AC signal within the operating region of the pulse oximeter. Probe off errors are serious because the pulse oximeter may display a normal saturation when, in fact, the probe is not properly attached to the patient, potentially leading to missed desaturation events.

40 **[0006]** Failure to detect a probe off condition is the result of the sensor detector receiving light directly from the emitters without transmission through the patient's tissue. The pulse oximeter is particularly vulnerable to probe off errors when operating at its highest sensitivity, where even small induced variations in light directly detected from the emitters have sufficient signal strength to be processed as a physiological signal. In a probe off condition, a detector **AC** signal can be induced by slight changes in the direct light path between the emitters and detector. For example, small amounts of patient motion, such as chest movement from breathing, can induce a probe off **AC** signal. As another example, "creep" in the sensor configuration, such as a folded sensor gradually returning to its original unfolded shape after becoming

dislodged can also induce a probe off AC signal. Further restricting the operating region **130** shown in FIG. 1 can reduce probe off errors. Such restrictions, however, would also severely limit the ability of the pulse oximeter to make saturation measurements on patients with poor perfusion.

[0007] The present invention is a monitor-based improvement to detecting the probe off condition described above. Of-course, other methods of detecting the probe-off condition could be combined with the present improvement. In particular, an intelligent, rule-based processor uses signal quality measurements to limit the operating region of the pulse oximeter without significant negative impact on low perfusion performance. These signal-quality operating limits are superimposed on those of FIG. 1 to improve probe off detection. In this manner, the pulse oximeter can reject AC signals that have sufficient signal strength to fall within the operating region **130** of FIG. 1, but that are unlikely to be a plethysmograph signal. One signal quality measurement that is used is pulse rate density, which is the percentage of time detected pulses satisfy a physiologically acceptable model. Another signal quality measurement is energy ratio, which is the percentage of signal energy that occurs at the pulse rate and its harmonics. The operating region of the pulse oximeter is then defined in terms of signal strength versus gain, signal strength versus PR density and energy ratio versus predefined energy ratio limits.

[0008] In one aspect of the present invention, a probe-off detector has a signal input, a signal quality input and a probe off output. The signal quality input is dependent on a comparison between a sensor output and a physiological signal model. The probe off output provides an indication that the sensor may not be properly attached to a tissue site. The detector comprises a signal strength calculator, a stored relationship between signal strength and signal quality and a comparator. The signal strength calculator has an input in communications with the sensor signal and provides a signal strength output that is dependent on the time-varying component of the sensor signal. The stored relationship defines an acceptable operating region for the sensor. The comparator has signal strength and signal quality as inputs and provides the probe off output based on a comparison of the signal strength and the signal quality with the stored relationship.

[0009] In another aspect of the present invention, a pulse oximetry sensor signal is processed to determine if it is properly attached to a tissue site. The process steps involve setting a signal strength limit that is dependent on signal quality, calculating a signal strength value from the sensor signal, calculating a signal quality value from the sensor signal and indicating a probe off condition if the signal strength is below the limit for the signal quality value previously determined.

Brief Description of the Drawings

[0010]

FIG. 1 is a graph illustrating minimum signal strength operating limits for a pulse oximeter;
 FIGS. 2A and 2B are graphs illustrating additional minimum signal strength operating limits for a pulse oximeter, based on signal quality according to the present invention;
 FIG. 2A is a graph of signal quality operating limits for a pulse oximeter in normal input sensitivity mode;
 FIG. 2B is a graph of signal quality operating limits for a pulse oximeter in high input sensitivity mode;
 FIG. 3 is a top-level block diagram of a rule-based intelligent processor that provides the signal quality operating limits illustrated in FIGS. 2A-2B;
 FIG. 4 is a detailed block diagram of the signal strength calculator portion of FIG. 3;
 FIG. 5 is a detailed block diagram of the probe off logic portion of FIG. 3; and
 FIG. 6 is a detailed block diagram of the signal strength dependent checks portion of FIG. 5.

Detailed Description of the Preferred Embodiments

[0011] FIGS. 2A and 2B illustrate how the operating range of a pulse oximeter is modified based on pulse rate density according to one embodiment of the present invention. Calculation of PR density is disclosed in U.S. Provisional Patent Application No. 60/114,127 filed December 30, 1998, and in U.S. Patent Application No. 09/471,510, filed December 23, 1999, entitled "Plethysmograph Pulse Recognition Processor," which is assigned to the assignee of the current application and incorporated by reference herein. The processor described therein has a candidate pulse portion that determines a plurality of potential pulses within the input IR waveform. A physiological model portion of the processor then determines the physiologically acceptable ones of these potential pulses. The processor provides statistics regarding the acceptable pulses. One statistic is pulse density, which is the ratio of the period of acceptable pulses to the duration of a block or "snapshot" of the IR input waveform.

[0012] FIG. 2A shows a graph **200** of signal strength on the y-axis **210** versus PR density on the x-axis **220** for normal sensitivity. The operating region **260** is shown unshaded, and the probe off region **270** is shown shaded. A signal strength floor **230** of .02, below which a probe off condition exists for all values of PR density, determines one portion of the

operating region **260**. That is, no matter how many of the detected plethysmograph pulses are deemed physiologically acceptable, if the signal strength is less than .02, then the pulse oximeter indicates a probe off condition. A signal strength ceiling **250** of .25, above which the pulse oximeter is in a valid operating region for all values of PR density, determines another portion of the operating region **260**. That is, signal quality is ignored if signal strength is above .25. Between the signal strength ceiling **250** and floor **230**, acceptable signal strength is dependent on PR density. The slope of the boundary **240** defining this relationship is:

$$\text{slope} = \frac{-(.25-.02)}{(.5-.2)} = \frac{-.23}{.3} = -.7667 \quad (1)$$

Thus, this boundary can be defined by the following equivalent equations:

$$SS = -.7667 \bullet PR \text{ density} + .4033 \quad (2)$$

$$PR \text{ density} = -1.3043 \bullet SS + 0.5261 \quad (3)$$

[0013] FIG. **2B** shows a graph **200** of signal strength on the y-axis **210** versus PR density on the x-axis **220** for high sensitivity. This graph is equivalent to that of FIG. **2A** except that the signal strength ceiling 250 is set at .05. Thus, signal quality indicated by PR density is ignored as long as the signal strength is above .05.

[0014] Another signal quality measure, energy ratio, is also imposed on the operating region as an absolute limit. Energy ratio is the percentage of IR signal energy occurring at the pulse rate and associated harmonics compared to total IR energy. The energy ratio is computed by transforming each block of the IR signal into the frequency domain as is well known in the art. The energy ratio is computed by identifying each peak in the resulting spectrum. In one embodiment, the peaks occurring at the pulse rate and its harmonics are identified and summed. This value is divided by the sum of the magnitudes of all peaks and output as the energy ratio. Note that energy ratio computed in this manner is not a true energy calculation because the calculations are based on the peak magnitudes and not the squared magnitudes of the IR signal. In this embodiment, the minimum energy ratio must be .6 if the pulse rate is greater than or equal to 30 and .5 otherwise. That is, 60% (or 50% for low pulse rates) of the signal must be at the pulse rate frequency or its harmonics or the pulse oximeter will indicate a probe off condition. A method for calculating the pulse rate used in this calculation is disclosed in U.S. Patent No. 6,002,952, filed April 14, 1997, entitled "Improved Signal Processing Apparatus and Method," which is assigned to the assignee of the current application and incorporated by reference herein.

[0015] FIG. **3** is a block diagram illustrating one embodiment of the improved probe-off detector **300** according to the present invention. The detector has a signal strength calculator **310**, a limit selector **330** and probe-off logic **350**. The signal strength calculator **310** has an IR signal **312** input. This signal is the detected sensor signal after demultiplexing, amplification, filtering and digitization. In a particular embodiment, the IR signal is input to the signal strength calculator **310** at a 62.5 Hz sample rate and in overlapping "snapshots" or blocks of **390** samples, each offset from the previous block by 25 samples. The signal strength calculator **310** creates a signal strength vector output **314** consisting of a set of signal strength scalars for each of these input blocks, as described with respect to FIG. **4** below.

[0016] The limit selector **330** has pulse rate **332** and sensitivity mode **334** inputs. When the sensitivity mode input **334** has a value of 1, it indicates that the pulse oximeter is in a normal sensitivity mode, corresponding to FIG. **2A**. A value of 0 indicates the pulse oximeter is in a high sensitivity mode, corresponding to FIG. **2B**. The pulse oximeter operator selects the sensitivity mode. The limit selector **330** also has energy ratio limit **336** and signal strength limit **338** outputs, which are input to the probe off logic **350** as absolute minimums of energy ratio and signal strength below which a probe off condition may be indicated **350**. The relationship between the pulse rate **332** and sensitivity mode **334** inputs and the energy ratio **336** and signal strength **338** outputs is specified below:

INPUT STATE	SELECTED LIMIT
pulse rate ≥ 30	minimum energy ratio = 0.6
pulse rate < 30	minimum energy ratio = 0.5
sensitivity mode = 0	minimum signal strength = 0.05
sensitivity mode = 1	minimum signal strength = 0.25

[0017] The probe off logic 350 has as inputs energy ratio 332, PR density 334 and signal strength vector 314. These inputs are compared to the energy ratio limit 336 and signal strength limit 338 outputs from the limit selector 330 to determine the operating region of the pulse oximeter. The probe off logic 350 also has a time fuse input 356. The time fuse 356 is a counter that indicates the number of IR waveform blocks containing no acceptable pulses. Acceptable pulses are determined as described for the calculation of PR density 354, above. The time fuse 356 input is 1 if there have been no acceptable pulses in a block since startup. The time fuse 356 is reset to 0 each time no acceptable pulses are detected for an input block. For each block where there are no acceptable pulses, the time fuse 356 is incremented by one. The time fuse enables the energy ratio limit and that portion of the signal strength limits above the floor 230 (FIGS. 2A-2B). This reduces the probability of probe off alarms for transient events. In a particular embodiment, the time fuse 356 is compared to the constants -1 and 5. That is, the energy ratio and signal strength limits are enabled if there have been no acceptable pulses since startup or for more than the previous 5 IR signal blocks.

[0018] The probe off logic 350 has a Boolean probe off output 358 that is set to 1 when the probe off logic 350 detects the pulse oximeter is operating outside permissible limits. Otherwise, the probe off output 358 is 0. The probe off output can be used by the pulse oximeter to trigger a probe off alarm and error message to alert medical personnel to inspect and reattach the sensor or take other appropriate action. The probe off logic 350 is described in more detail below with respect to FIG. 5.

[0019] FIG. 4 shows further details of the signal strength calculator 310 (FIG. 3). Each 390 sample block of the IR signal 312 is initially filtered 410 remove any trends in the IR signal 312 that could cause an error in the signal strength calculations. In a particular embodiment, the filter 410 is a bandpass FIR filter with cutoff frequencies of 50 Hz and 550 Hz and a 151 tap Kaiser window having a shape parameter of 3.906. As a result, 150 samples are lost from each 390 sample input block. Thus, the filtered IR output 412 consists of 240 sample blocks.

[0020] Each 240 sample block of the filtered IR output 412 is converted 430 into multiple overlapping sub-blocks. In a particular embodiment, the sub-blocks each consist of 100 samples, and each sub-block is offset by 10 samples from the previous sub-block. Thus, the sub-block converter 430 creates 15 sub-block outputs 432 for each 240 sample filtered IR block 412. For each sub-block, a max-min calculation 460 is performed. That is, the minimum sample magnitude in a particular sub-block is subtracted from the maximum sample magnitude in that sub-block. Each max-min output 462 is a single scalar representing the signal strength of a particular sub-block. A scalar-to-vector conversion 490 combines the max-min outputs 462 into a vector output 314 containing multiple signal strength values representing the signal strength of a particular block of the IR signal 312.

[0021] FIG. 5 provides further detail of the probe off logic 350 (FIG. 3). The probe off logic 350 has three functional checks that each provide a Boolean output. An energy ratio check 510 compares the energy ratio 352 against the energy ratio limit 336 provided by the limit selector 330 (FIG. 3), specified in the table above. The energy ratio check 510 sets the "poor energy ratio" output 512 if the energy ratio 352 is below the energy ratio limit 336.

[0022] A time fuse check 520 determines if the time fuse 356 indicates no acceptable pulses have occurred in the IR signal 312 (FIG. 3) for a sufficiently long time period. If so, a timeout output 522 is set. In a particular embodiment, the time fuse check 520 consists of comparators that determine if the time fuse 356 is -1 or greater than 5, indicating no acceptable pulses since startup or for a longer period than the past 5 blocks of IR signal 312.

[0023] The signal strength dependent checks 530 determine if the pulse oximeter is within the operating limits described above with respect to FIGS. 2A and 2B. If the signal strength, as determined by the signal strength vector 314, is below the floor 230 (FIGS. 2A-B), then the signal strength failure output 534 is set. If the signal strength is above the floor 230 (FIGS. 2A-B) but otherwise outside the operating region, i.e. within the shaded region 270 (FIGS. 2A-B) above the floor 230 (FIGS. 2A-2B), then the "poor signal strength" output 532 is set.

[0024] A logical AND function 540 sets a "poor signal quality" output 542 if the poor energy ratio 512, poor signal strength 532 and timeout 522 outputs are set. A logical OR function 550 sets the probe off output 358 if the poor signal quality 542 or the signal strength failure 534 outputs are set.

[0025] FIG. 6 shows a particular embodiment of the signal strength dependent checks 530 (FIG. 5). The signal strength vector 314 is converted 610 into the 15 individual signal strength scalars 612. Relative checks 620 and absolute checks 630 are performed on each of the 15 scalars 612. Each relative check 620 determines if signal strength is within the signal strength limit 338 relative to PR density 354. That is, each relative check output 622 is set according to the following, see Eq. 3 above:

INPUT STATE	RESULT
$SS \geq SS \text{ limit}$	output =0
$PR \text{ density} > -1.3043 \cdot SS + 0.5261$	output =0
$(SS < SS \text{ limit}) \text{ AND } PR \text{ density} < -1.3043 \cdot SS + 0.5261$	output =1

[0026] Each absolute check **630** determines if the signal strength is above the absolute minimum floor 230 (FIGS. **2A-2B**). That is, each absolute check output **632** is set according to the following:

INPUT STATE	RESULT
$SS \geq 0.02$	output = 0
$SS < 0.02$	output = 1

[0027] The **15** relative check outputs **622** are processed by a sum and compare **660**, which performs an arithmetic sum of these outputs **622**. If the sum is equal or greater than 5, the poor signal strength output **532** is set. That is, poor signal strength is indicated if at least 1/3 of the scalars in the signal strength vector **314** fail their relative checks **620**. Likewise, the 15 absolute check outputs **632** are processed by a sum and compare **670**, which performs an arithmetic sum of these outputs **632**. If the sum is equal or greater than 5, the signal strength failure output **534** is set. That is, a signal strength failure is indicated if at least 1/3 of the scalars in the signal strength vector **314** fail the absolute checks **630**.

[0028] This improvement to detecting pulse oximetry probe off conditions has been disclosed in detail in connection with various embodiments of the present invention. These embodiments are disclosed by way of examples only and are not to limit the scope of the present invention, which is defined by the claims that follow. One of ordinary skill in the art will appreciate many variations and modifications within the scope of this invention.

Claims

1. A processor for determining when a physiological sensor may not be properly positioned with respect to a measurement site, the processor comprising:

a signal strength calculator which processes a sensor signal input expected to be representative of at least one parameter measured by the physiological sensor, to produce a signal strength output representative of a strength of the sensor signal input, wherein the sensor signal input is provided from the physiological sensor; and a probe off logic module which indicates that the sensor signal input may not represent the parameter when a predetermined portion of the signal strength output is below a threshold value.

2. The processor of Claim 1, wherein the probe off logic module comprises comparator.

3. The processor of Claim 1, wherein the threshold comprises a ratio of a first value of a substantially alternating part of the signal strength output to a second value of a substantially non-alternating part of the signal strength output.

4. The processor of Claim 3, wherein the ratio comprises a value above which a probe-off condition does not exist for all values of the signal strength output.

5. The processor of Claim 3, wherein the ratio is 0.25.

6. The processor of Claim 3, wherein the ratio is 0.05.

7. The processor of Claim 1, wherein the probe off logic module indicates that the sensor signal input may not represent the parameter when the predetermined portion of the signal strength output is below the threshold value and a signal quality of the sensor signal input falls within a non-operative region.

8. The processor of Claim 7, wherein the non-operative region comprises a region defined by a relationship between the signal strength output and the signal quality.

9. The processor of Claim 7, wherein the signal quality comprises a comparison of the sensor signal input with one or more physiological signal models.

10. The processor of Claim 7, further comprising a timeout input indicative of non-acceptable pulses in at least one predetermined block of the sensor signal input.

11. The processor of Claim 7, wherein the probe off logic module indicates that a probe-off condition exists when a

timeout output indicates absence of acceptable pulses in at least one predetermined block of the sensor signal input, when the predetermined portion of the signal strength output is below the threshold, and the signal quality of the sensor signal input falls within a non-operative region.

5 12. The processor of Claim 7, further comprising an energy ratio representative of whether a measurement of energy in the sensor signal input is above the threshold value.

10 13. The detector of Claim 12, wherein the probe off logic module indicates that a probe-off condition may exist when the energy ratio is above the threshold value, when the predetermined portion of the signal strength output is below the threshold, and when the signal quality of the sensor signal input falls within the non-operative region.

15 14. The detector of Claim 12, wherein the probe off logic module indicates that a probe-off condition may exist when the energy ratio is above the threshold value, a timeout output indicates absence of acceptable pulses in at least one predetermined block of the sensor signal input, when the predetermined portion of the signal strength output is below the threshold, and when the signal quality of the sensor signal input falls within the non-operative region.

15 15. The processor of Claim 1, wherein the threshold value comprises a signal strength floor below which a probe-off condition exists for all values of the signal strength output.

20 16. The processor of Claim 1, wherein the threshold value is dependent upon a sensitivity mode of the physiological sensor.

17. The processor of Claim 16, wherein the sensitivity mode is selectable by an operator.

25 18. An improved method of detecting that a pulse oximetry sensor may not be properly attached to a tissue site by processing a sensor signal, said method comprising the steps of:

- setting a signal strength limit that is dependent on signal quality;
- calculating a signal strength value from said sensor signal;
- 30 calculating a signal quality value from said sensor signal; and
- indicating a probe off condition if said signal strength value is below said limit for said signal quality value determined in said calculating step.

35 19. An improvement to a probe-off detector having a signal input, a signal quality input and a probe off output, said signal quality input dependent on a comparison between a sensor output and a physiological signal model, said probe off output providing an indication that said sensor may not be properly attached to a tissue site, said improvement comprising:

- a signal strength calculator having an input in communications with said signal and providing a signal strength output that is dependent on the time-varying component of said signal;
- 40 a stored relationship between said signal strength and said signal quality that defines an acceptable operating region for said sensor; and

45 a comparator having as inputs said signal strength and said signal quality and providing said probe off output based on a comparison of said signal strength and said signal quality with said stored relationship.

50

55

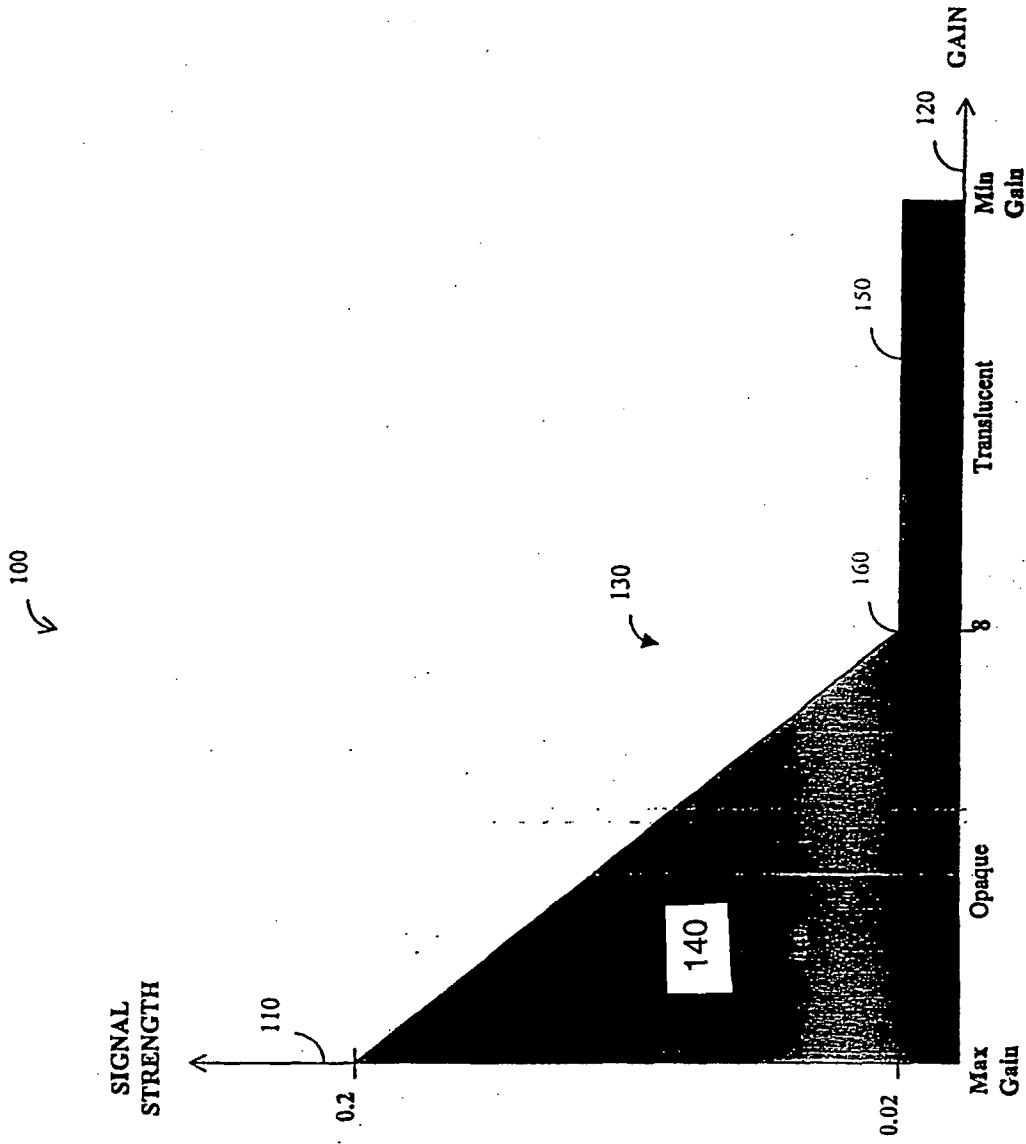

FIG. 1

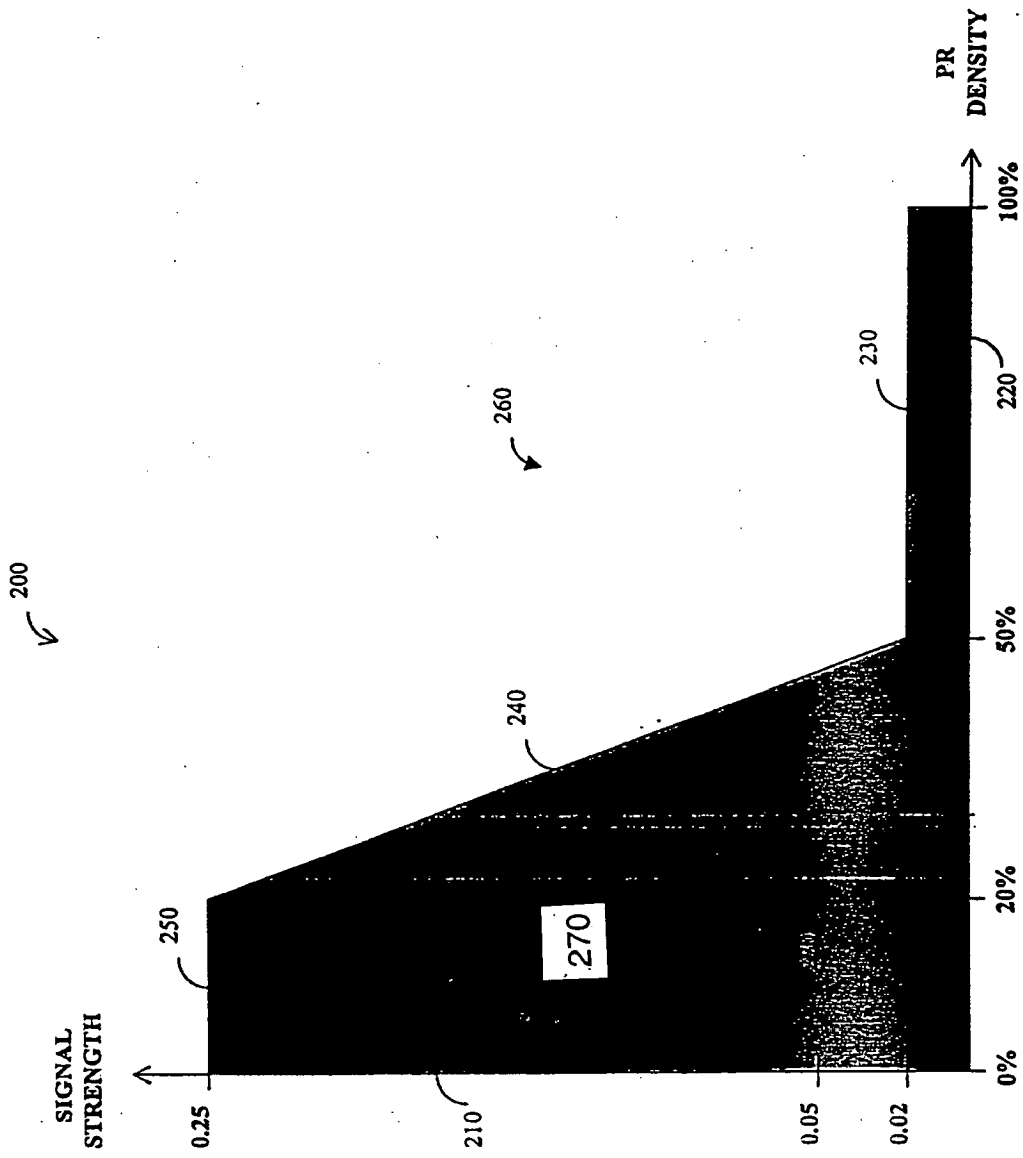

FIG. 2A

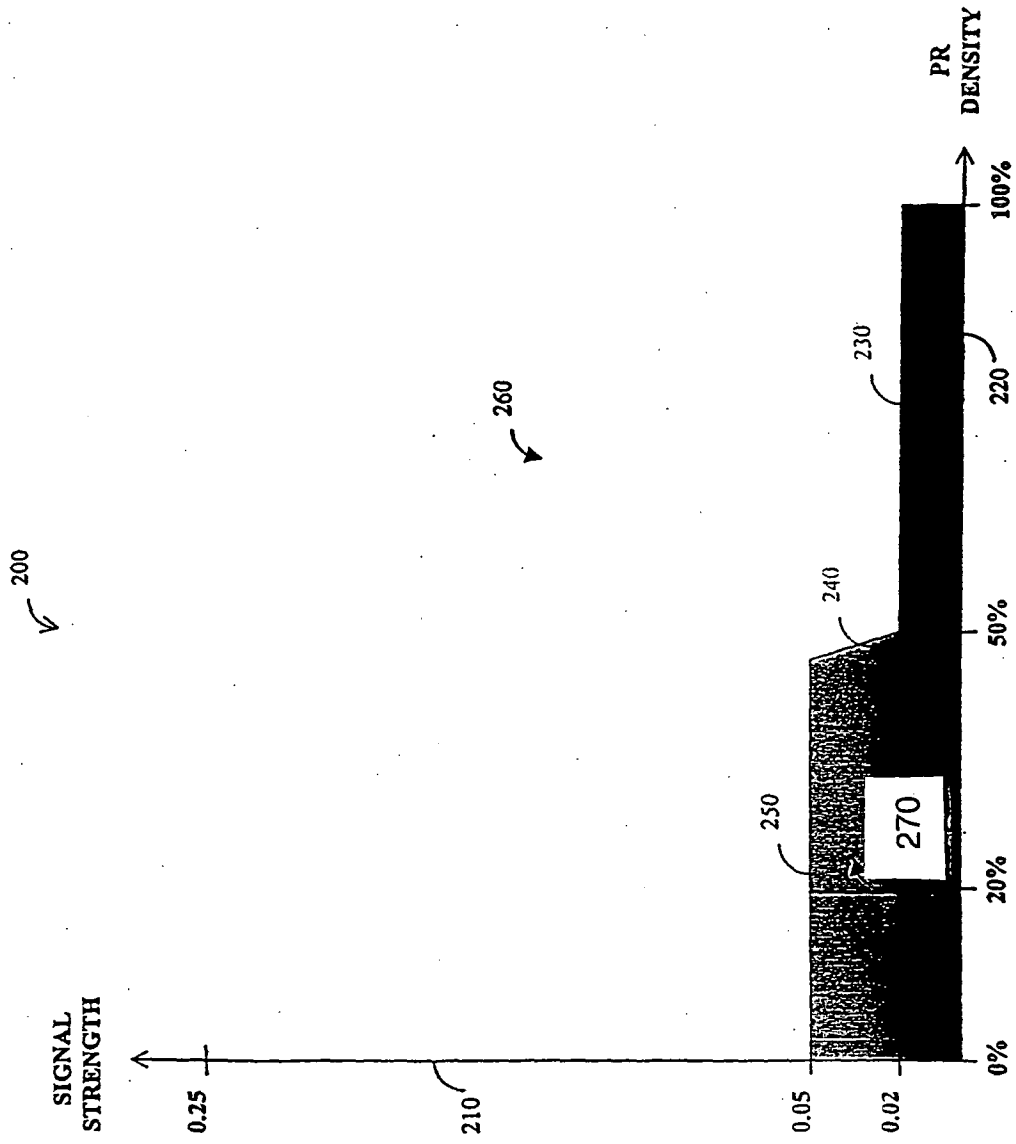

FIG. 2B

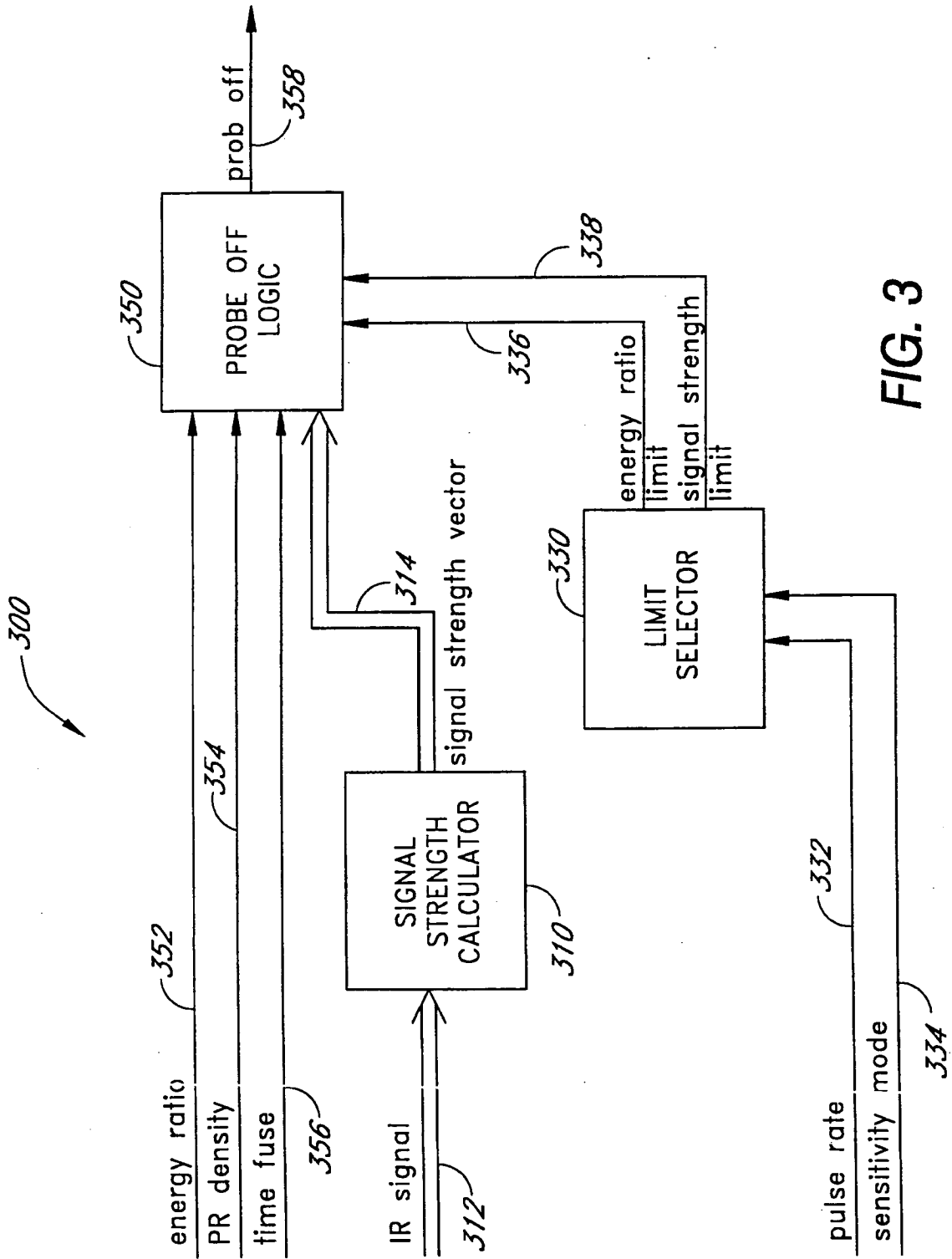

FIG. 3

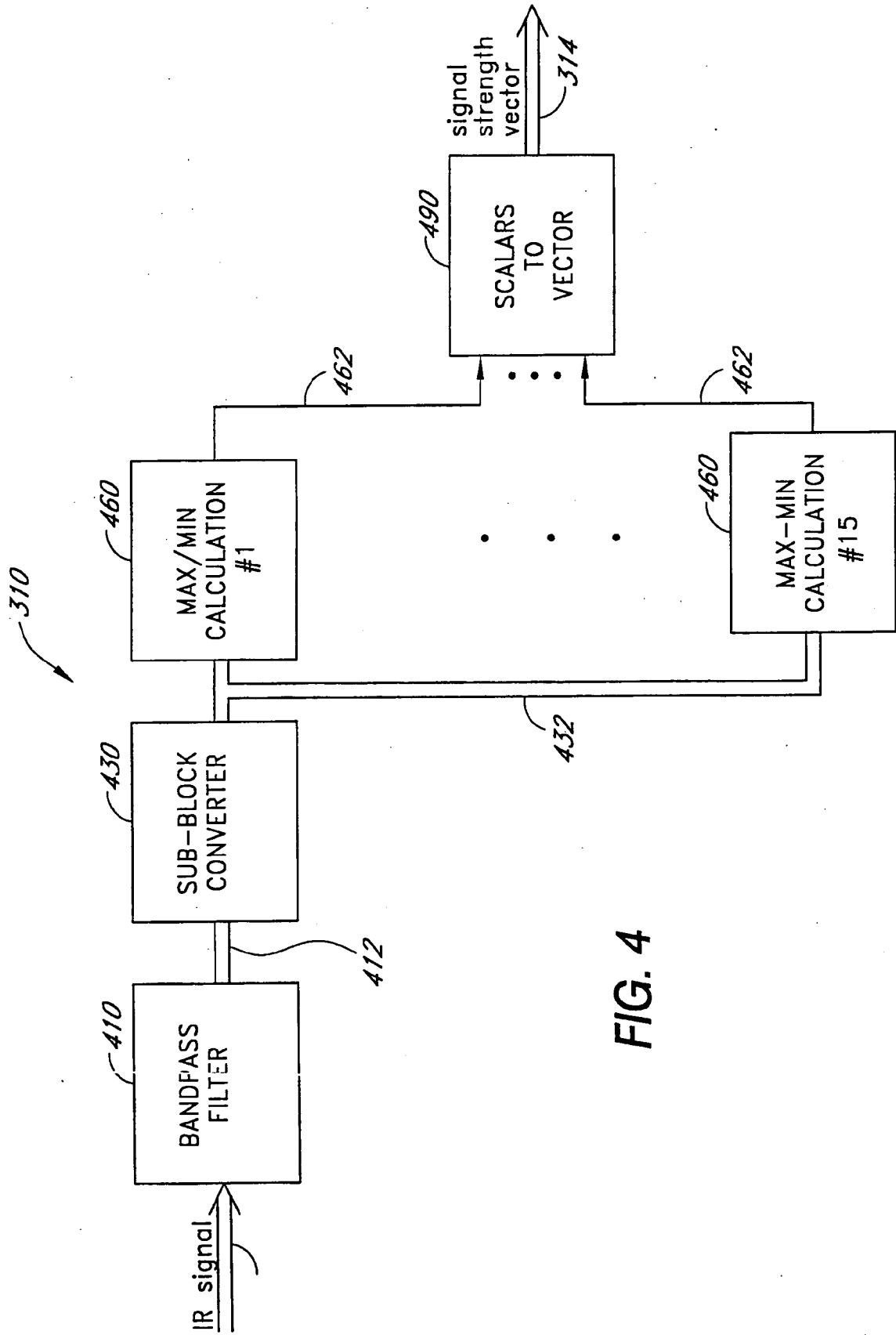

FIG. 4

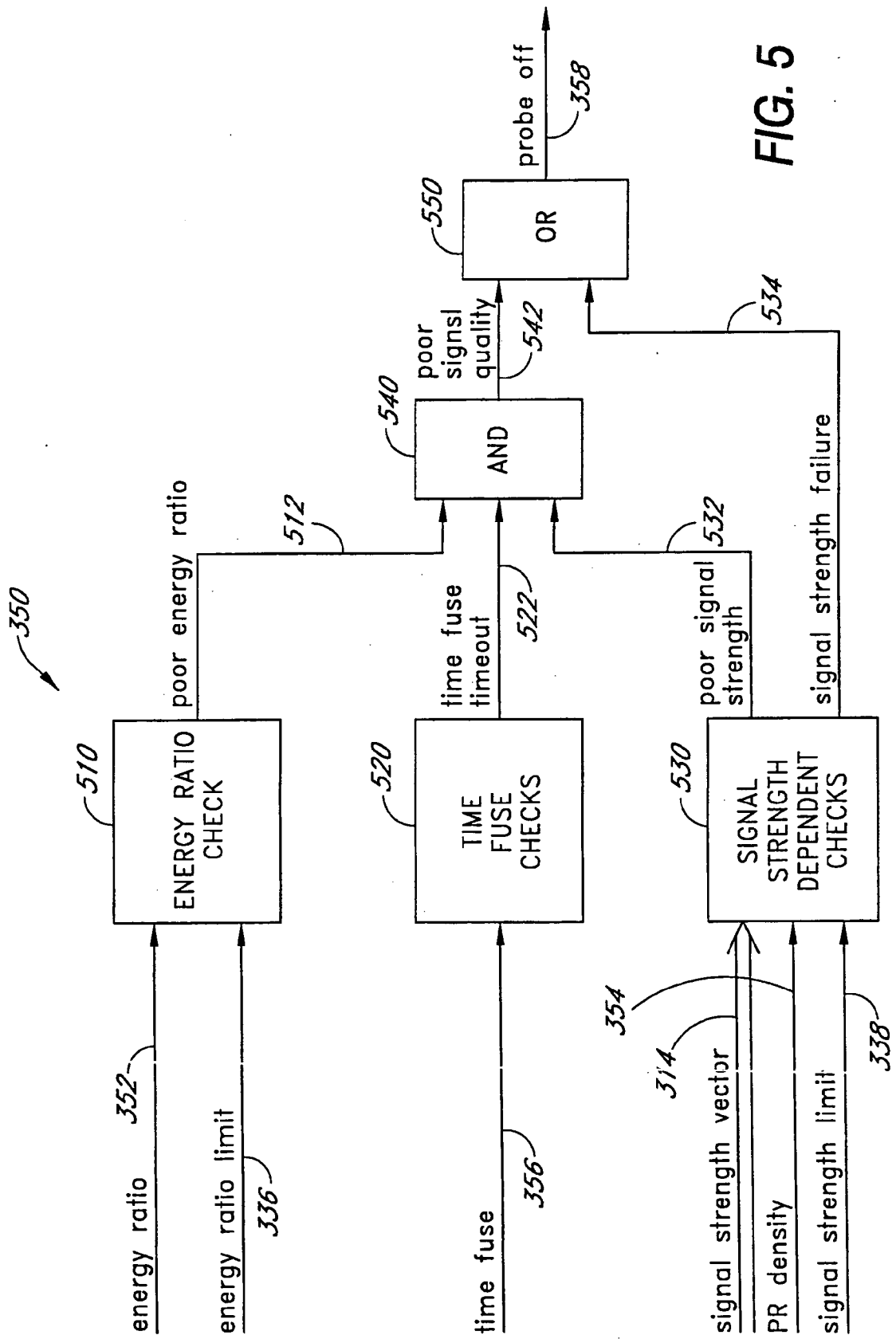

FIG. 5

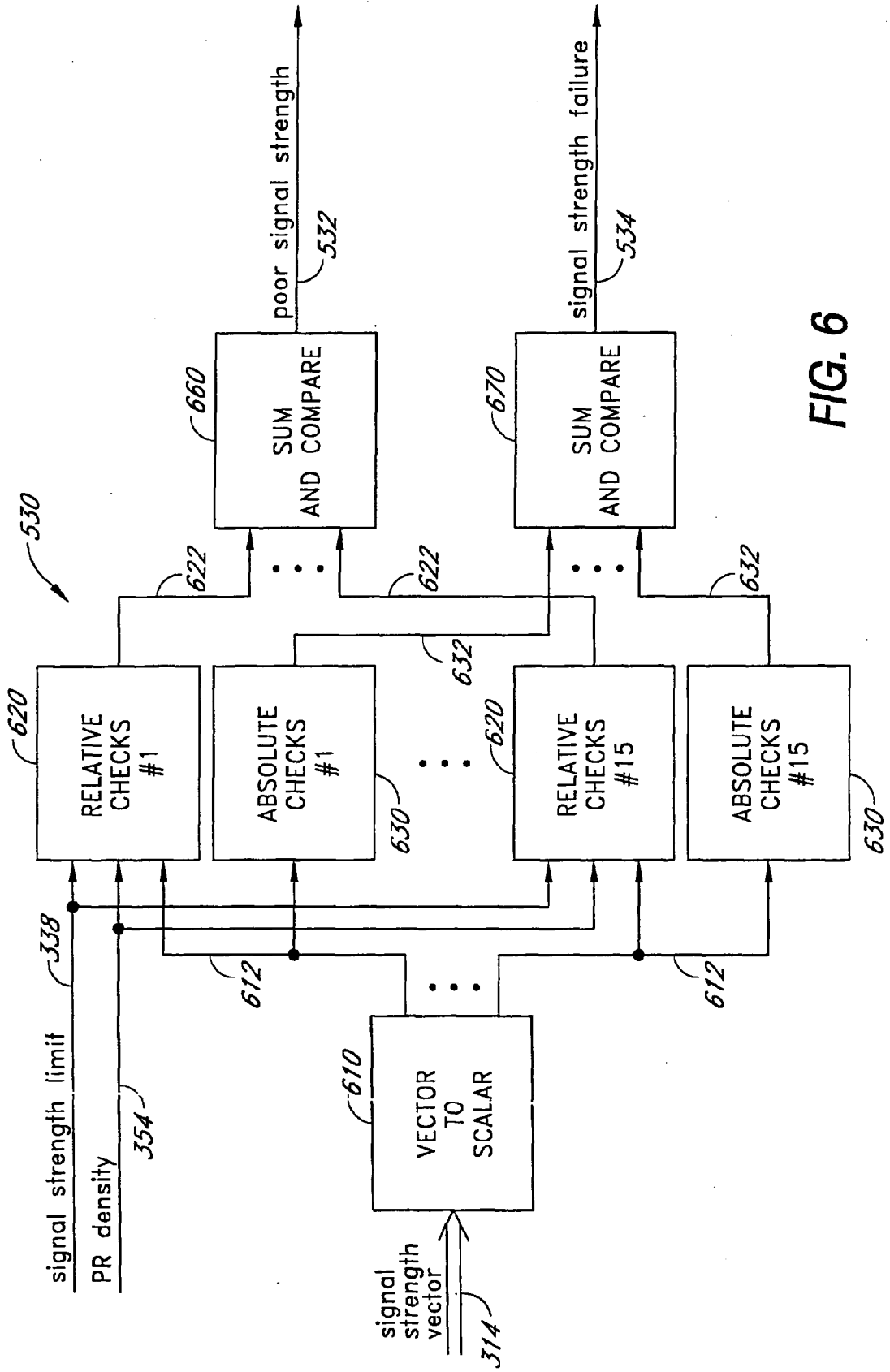

FIG. 6

REFERENCES CITED IN THE DESCRIPTION

This list of references cited by the applicant is for the reader's convenience only. It does not form part of the European patent document. Even though great care has been taken in compiling the references, errors or omissions cannot be excluded and the EPO disclaims all liability in this regard.

Patent documents cited in the description

- US 5632272 A [0002]
- US 11412798 P [0011]
- US 47151099 A [0011]
- US 6002952 A [0014]

专利名称(译)	改进的脉搏血氧仪探测器		
公开(公告)号	EP1719449A2	公开(公告)日	2006-11-08
申请号	EP2006012571	申请日	2000-03-24
[标]申请(专利权)人(译)	梅西莫股份有限公司		
申请(专利权)人(译)	Masimo公司		
当前申请(专利权)人(译)	Masimo公司		
[标]发明人	THE DESIGNATION OF THE INVENTOR HAS NOT YET BEEN FILED		
发明人	THE DESIGNATION OF THE INVENTOR HAS NOT YET BEEN FILED		
IPC分类号	A61B5/00 G01N21/35 A61B5/145 A61B5/1455		
CPC分类号	A61B5/6843 A61B5/14551		
代理机构(译)	法思博事务所		
优先权	60/126148 1999-03-25 US		
其他公开文献	EP1719449B1 EP1719449A3		
外部链接	Espacenet		

摘要(译)

基于规则的智能处理器 (300) 为脉搏血氧计的信号强度操作区域提供基于信号质量的限制。这些限制叠加在典型的增益相关信号强度限制上 (314)。如果生理学上产生传感器信号，则允许脉搏血氧仪以最小信号强度操作，从而最大化低灌注性能。如果传感器信号可能是由移位的传感器引起的信号引起的，则会提高信号强度要求。因此，信号质量限制增强了探针关闭检测，而不会显著影响低灌注性能。使用的一种信号质量测量是脉冲速率密度 (354)，其定义了生理学上可接受的脉冲发生的时间百分比。如果检测到的信号包含很大一部分不可接受的脉冲，则所需的最小信号强度成比例地增加。与脉率密度结合使用的另一种信号质量测量是能量比 (352)，计算为脉冲率基波和相关谐波中包含的总能量的百分比。

