



(11) **EP 2 723 230 B1**

(12) **EUROPEAN PATENT SPECIFICATION**

(45) Date of publication and mention of the grant of the patent:
28.08.2019 Bulletin 2019/35

(51) Int Cl.:
A61B 5/0402^(2006.01) A61B 5/0408^(2006.01)

(21) Application number: **12802549.1**

(86) International application number:
PCT/CA2012/050410

(22) Date of filing: **20.06.2012**

(87) International publication number:
WO 2012/174660 (27.12.2012 Gazette 2012/52)

(54) **COMPUTER-AIDED LOCALIZATION OF SITE OF ORIGIN OF CARDIAC ACTIVATION**

COMPUTERGESTÜTZTE LOKALISIERUNG DER URSPRUNGSORTE VON HERZAKTIVIERUNGEN

LOCALISATION ASSISTÉE PAR ORDINATEUR D'UN SITE D'ORIGINE D'ACTIVATION CARDIAQUE

(84) Designated Contracting States:
AL AT BE BG CH CY CZ DE DK EE ES FI FR GB GR HR HU IE IS IT LI LT LU LV MC MK MT NL NO PL PT RO RS SE SI SK SM TR

(56) References cited:
CA-A1- 2 600 208 US-A1- 2002 038 093
US-B1- 6 584 343

(30) Priority: **24.06.2011 US 201161501036 P**

(43) Date of publication of application:
30.04.2014 Bulletin 2014/18

(73) Proprietor: **Dalhousie University**
Halifax, Nova Scotia B3H 4R2 (CA)

(72) Inventors:
• **SAPP, John, Lewis, Jr.**
Halifax, Nova Scotia B3H 3M9 (CA)
• **HORACEK, Bohumil Milan**
Halifax, Nova Scotia B3P 1G4 (CA)
• **EL-DAMATY, Ahmed Mohamed Fahmey**
Halifax, Nova Scotia B3M 4P1 (CA)

(74) Representative: **Hoffmann Eitle**
Patent- und Rechtsanwälte PartmbB
Arabellastraße 30
81925 München (DE)

- **MARK POTSE* ET AL: "Continuous Localization of Cardiac Activation Sites Using a Database of Multichannel ECG Recordings", IEEE TRANSACTIONS ON BIOMEDICAL ENGINEERING, IEEE SERVICE CENTER, PISCATAWAY, NJ, USA, vol. 47, no. 5, 1 May 2000 (2000-05-01), XP011006889, ISSN: 0018-9294**
- **GERSTENFELD ET AL.: 'Quantitative Comparison of Spontaneous and Paced 12- Lead Electrocardiogram During Right Ventricular Outflow Tract Ventricular Tachycardia' JOURNAL OF THE AMERICAN COLLEGE OF CARDIOLOGY vol. 41, no. 11, July 2003, pages 2046 - 2053, XP055141277**
- **KORSET AL.: 'Improved Spatial Sampling of ECG Potentials on the Body Surface by Repositioning Electrodes from the standard 12-lead ECG' COMPUTERS IN CARDIOLOGY vol. 28, 26 September 2001, pages 29 - 32, XP010573208**

Note: Within nine months of the publication of the mention of the grant of the European patent in the European Patent Bulletin, any person may give notice to the European Patent Office of opposition to that patent, in accordance with the Implementing Regulations. Notice of opposition shall not be deemed to have been filed until the opposition fee has been paid. (Art. 99(1) European Patent Convention).

EP 2 723 230 B1

Description

Field of the Invention

[0001] The present invention relates to computer-aided localization of site of origin of cardiac activation for catheter ablation.

Background of the Invention

[0002] Ventricular tachycardia (VT) is one of the most difficult management challenges in clinical cardiac electrophysiology. The spectrum of ventricular arrhythmias spans a wide range of clinical presentations that include premature ventricular complexes (PVCs), non-sustained ventricular tachycardia (NSVT), sustained ventricular tachycardia (VT) and ventricular fibrillation (VF). Any of these presentations can occur in patients with or without structural heart disease. This spectrum applies to any source of tachycardia originating below the His bundle whether from the bundle branches, Purkinje fibers or ventricular myocardium.

[0003] VT most commonly occurs in the setting of structural heart disease, such as coronary artery disease, heart failure, cardiomyopathy, congenital heart disease or following cardiac surgery. Prior myocardial infarction (MI) is by far the most common cause of sustained VT. Ventricular tachyarrhythmia associated with MI occurs in two stages. During the acute phase of MI, polymorphic ventricular tachycardia that can degenerate into ventricular fibrillation is most common. On the other hand, sustained monomorphic VT generally arises from the anatomic substrate of a healed MI that usually develops within 2 weeks after an MI and remains indefinitely. This substrate of healthy and damaged myocardium interlaced with fibrous tissue is found primarily at the border zone of the scar. Fibrosis creates areas of conduction block and increases the separation of myocyte bundles, slowing conduction through myocyte pathways in the border zone of the infarct thus creating a substrate that supports re-entry when an appropriate trigger occurs. With present management of MI, the incidence of sustained post-infarction VT is low, and fewer than 5% of acute MI survivors have inducible ventricular tachycardia when studied early after the acute event. VT exits the scar into the healthy myocardium and depolarizes the myocardium sequentially from this exit site. The location of the exit is responsible for the morphology of the ECG signal.

[0004] Sustained monomorphic VT occurring in the absence of structural or electrical heart disease is called idiopathic VT. Idiopathic VT can arise from different sites, but the right ventricular outflow tract (most commonly within 1-2 cm of the pulmonary valve) is by far the most common and accounts for approximately 10% of VTs seen by specialized arrhythmia services. Other potential sites include the left ventricular outflow tract, aortic sinuses of Valsalva (most commonly left) from a crescent of ventricular epicardium underlying the base of the sinus

at the aortoventricular junction, in the endocardium adjacent to the mitral annulus and finally from the left ventricular epicardium remote from the sinuses of Valsalva, at sites adjacent to the coronary vasculature. These idiopathic VTs usually have a focal origin caused by triggered activity or abnormal automaticity.

[0005] Suppression of VT may be accomplished with the use of implantable cardioverter-defibrillators (ICDs), anti-arrhythmic drugs, arrhythmia surgery and catheter ablation. While antiarrhythmic drugs are considered first line therapy and are commonly used to complement therapy, they are not completely effective in preventing VT episodes and may cause significant cardiac and non-cardiac side-effects. ICD is the only treatment modality that has been demonstrated to offer a significant reduction in mortality in patients with scar-related VT. Although implantable cardioverter-defibrillators (ICDs) can improve the prognosis for patients with VT, recurrent VT can still be life-threatening. Catheter ablation offers a curative treatment for certain types of idiopathic VT and has been suggested to have a benefit for patients who have suffered prior MI in many case studies.

[0006] Cardiac mapping refers to all procedures involving recording of body-surface electrocardiograms or endocardial/epicardial electrograms generated due to the spread of the cardiac action potential. This can be recorded from the body surface using either conventional 12-lead electrocardiogram (ECG) or multiple leads (such as for body surface potential mapping (BSPM)), the endocardium or the epicardium. Cardiac mapping provides a means of visualizing the pathophysiological mechanisms underlying ventricular tachycardia, which is crucial for directing catheter ablation procedures.

[0007] Several conventional and advanced mapping techniques are frequently utilized to accomplish a successful catheter ablation. However, many of these mapping techniques are hampered by either hemodynamic instability or non-sustained nature of some tachycardias.

[0008] Conventional endocardial mapping techniques with catheters placed percutaneously into the heart chambers continue to be the most popular cardiac mapping modality. These catheters are localized and navigated using fluoroscopy. Several conventional mapping techniques have been developed over the last few decades to help understanding the mechanisms of arrhythmias and to guide catheter ablation. These conventional mapping techniques include activation mapping, pacemapping and entrainment mapping.

[0009] Pacemapping is a commonly used tool for mapping non-sustained or hemodynamically unstable VT; it is based upon the principle that activation of the heart from a given site will yield a reproducible body surface electrocardiogram (ECG) morphology and that pacing from a site very close to the site at which VT activates the heart (i.e. the site of origin) will result in a matching ECG morphology. However, this technique has some limitations. Comparison of the 12-lead ECG morphology between a pace-map and clinical tachycardia is frequently

completely subjective or semiquantitative. Discrepancies in ablation results may result, in part, from subjective differences in the opinion of a pace-map match to the clinical tachycardia. Another important limitation is that increasing the strength to pace diseased tissues, as in scar-related VT, can excite tissues more distant to the area of stimulation (even if unipolar pacing is used) which may lead to a 12/12 match even 1-1.5 cm away from successful ablation sites. This technique is therefore very time consuming and is limited by imperfect accuracy and spatial resolution, subjectivity of interpretation, and by the need for an intuitive interpretation of the ECG to direct catheter manipulation.

[0010] BSPM incorporates data from a much larger number of electrodes, but remains limited by the remote location of the recording site from the cardiac surface resulting in poor spatial resolution of electrical events. The recent development of electrocardiographic imaging (ECGI) represents a further refinement of this technique, combining BSPM and heart torso geometric information to produce detailed electro-anatomical maps of the epicardial surface through application of inverse solution mathematical algorithms. This methodology has permitted accurate localization of focal activation sources, as well as detailed activation sequences during re-entrant arrhythmias. ECGI was recently used to assist in the diagnosis and guiding catheter ablation of focal idiopathic as well as scar related VT. A number of limitations are still under investigation, the most important being the accuracy, but also the complexity of the procedure and the need for a long processing time from electrocardiographic signal acquisition to 3D display of the derived epicardial potentials.

[0011] US 2002/038093 A1 describes systems, devices, and methods to localize and/or treat arrhythmias of the heart of a patient using signals sensed at an accessible body surface. Based on a database of known signals and associated sites, candidate sites are identified. A statistical comparison of an integral of the heart cycle with known body surface maps is performed and a statistical interpolation identifies a candidate site different from the known sites. The method makes use of a database, wherein the database includes known heart signals and associated discrete known ectopic or accident sites. The technique makes use of an array of sensors such as a multi lead electrocardiogram (ECG) at a plurality of sensing locations. Additional approximated sensor signals may be generated by interpolating between sensors of the array. This may be performed, for example, to generate data at 192 sensing locations when only 62 sensors are present in the array. A selected portion of the measured heart signals from a desired reference heart beat are integrated at each sensing location to determine an associated integral value. The reference heart beat may include a premature atrial beat or the initiation of an arrhythmia. A data metrics is generated with integral values and is compared with data matrices of the database generated from the known heart signals. The databases have

been prepared by grouping together sets of pacing data having similar morphology and pacing locations from a number of tests. Each of the maps in the associated known sites or region has been assembled from a serious of individual pacing test on several different patients.

[0012] There is therefore a need for a system that assists in the localization of the site of origin.

[0013] The above need is met by the subject matter of the independent claims. Advantageous embodiments are disclosed by the dependent claims.

Brief Description of the Drawings

[0014] In drawings which illustrate by way of example only a preferred embodiment of the invention,

Figure 1 is a schematic diagram of a computer-aided localization system.

Figure 2 is a schematic diagram of an arrangement of 120 leads on the torso for body surface potential mapping. The left half of the grid represents anterior surface and right half represents the posterior surface of the chest. Transverse levels (labeled 1', 2... 10') are 1-inch apart from neck to waist; potentials at 352 nodes (unlabelled solid squares) are interpolated from potentials recorded at 120 sites (numbered circles); squares labelled 'g' indicate sites of precordial leads V1-V6; squares labelled 'y' mark sites where electrodes of Mason-Likar substitution for extremity leads are placed; squares labelled 'r' are sites of the EASI leads.

Figure 3 is an illustration of a 17-segment model of the left ventricle on a circumferential polar plot and the nomenclature for assignments of the CARTO points to anatomical locations. Diagram of vertical long-axis (VLA, 2-chamber view), horizontal long-axis (HLA, 4-chamber view), and short-axis (SA) planes showing the name, location, and anatomic landmarks for selection of the basal, mid-cavity, and apical short axis slices for the recommended 17-segment system.

Figure 4 is a block diagram for identifying the segment of the heart in which the activation site of origin is likely located.

Figure 5 is a block diagram for displaying an objective measure of the similarity between an BSPM of interest and a pace site BSPM.

Figure 6 shows 12-lead QRS integral templates for 16 endocardial segments. ECG leads on the abscissa in each of the 16 panels are ordered in Cabrera sequence (aVL, I, -aVR, II, aVF, III) followed by precordial leads (VI to V6). Dark-grey (red) bars indicate

positive QRS integrals while light-grey (green) bars indicate negative QRS integrals.

Figure 7 shows 12-lead 100 msec QRS integral templates for 16 endocardial segments. ECG leads on the abscissa in each of the 16 panels are ordered in Cabrera sequence (aVL, I, -aVR, II, aVF, III) followed by precordial leads (VI to V6). Dark-grey (red) bars indicate positive QRS integrals while light-grey (green) bars indicate negative QRS integrals.

Figure 8 shows recorded 120-lead QRS integral body surface potential map templates for 16 endocardial segments. The left side of each map corresponds to the front and the right side corresponds to the back of the chest. ECG leads V1-V6 are identified by the black dots. Areas 410 and 400 of the maps represent positive and negative integrals, respectively, whereas the white line 420 marks the zero integral. The locations of the positive/negative extremes (maxima/minima) are indicated by white dots in areas 410 and 400, respectively, and their amplitudes are expressed in mVms in the upper left and upper right of the map respectively. The isointegral lines are separated by automatically determined linear incremental steps that depend on the magnitude of the maxima and the minima and is, for display clarity, restricted to an upper limit of 15 contour lines per map.

Figure 9 shows recorded 120-lead 100 msec QRS integral body surface potential map templates for 16 endocardial segments. Note the similar morphology to the QRS BSPM templates with lower amplitudes of the maxima and minima.

Figure 10 shows predicted QRS integral BSPM templates from 12-leads ECG by using regression coefficients for 16 endocardial segments. Note the similar morphology to the recorded BSPM and the difference in the values of the maxima and minima.

Figure 11 shows predicted initial 100 msec QRS integral BSPM templates from 12-lead ECG by using regression coefficients for 16 endocardial segments. Note the similar morphology to the recorded BSPM and the difference in the values of the maxima and minima.

Detailed Description of the Invention

[0015] In one embodiment, there is provided a method for localizing an activation site of origin to a segment of the heart comprising: comparing a body surface potential map (BSPM) of interest to each BSPM template of a pre-determined set of BSPM templates, the set comprising one BSPM template for each pre-defined segment of the heart, wherein the BSPM of interest is calculated based

on a plurality of simultaneously recorded electrocardiographic (ECG) signals and wherein comparing comprises, for each BSPM template of the set of BSPM templates: retrieving a BSPM template from memory; and calculating one or more comparison metrics for the BSPM template retrieved as compared to the BSPM of interest, wherein each of the BSPM templates was generated by averaging BSPMs of all pacing sites within the associated segment of the heart from a collection of BSPMs stored in memory; identifying the BSPM template that most closely resembles the BSPM of interest using the comparison metrics calculated in order to identify the segment of the heart in which the activation site of origin is likely to be located.

[0016] In further aspects of this embodiment, each of the BSPMs stored in memory represent a pre-determined number of ECG signals; at least one or more estimated BSPMs of the BSPMs stored in memory were calculated from a different number of ECG signals than the pre-determined number; and/or calculation of the one or more estimated BSPMs comprises interpolating between the different number of ECG signals by application of coefficients pre-derived from a collection of BSPMs each representing the pre-determined number of ECG signals.

[0017] In another embodiment, there is provided a method for quantifying, during pacemapping, a comparison of a BSPM of interest to a pace site BSPM, the method comprising: receiving at a computing device a plurality of ECG signals from an acquisition system; calculating the pace site BSPM using the plurality of ECG signals; comparing the BSPM of interest to the pace site BSPM, wherein comparing comprises: retrieving the BSPM of interest from memory accessible by the computing device; and calculating one or more comparison metrics for the BSPM of interest as compared to the pace site BSPM; and displaying on a user interface in communication with the computing device an indication of similarity between the BSPM of interest and the pace site BSPM based on the comparison metric calculated.

[0018] The present invention provides a system and method for localizing activation sites of origin, such as VT exit site or site of origin. The site of origin may first be localized to a segment or segments of the heart by comparing a BSPM of interest, such as a BSPM calculated from a plurality of ECG signals recorded simultaneously during VT, to BSPM templates, one template for each pre-defined segment of the heart.

[0019] Each BSPM template may be derived from a library collection of BSPMs calculated from ECG measurements captured from many patients. The BSPM template for a heart segment may be calculated by computing the mean or average of the corresponding library BSPMs associated with a pacing site within the corresponding heart segment.

[0020] The library BSPMs of the collection may each be calculated directly from a pre-determined number of previously recorded ECG signals from a patient ("recorded BSPMs"). Where a patient has been measured using

a different number of ECG signals, an "estimated BSPM" may be calculated by interpolating between the different number of ECG signals recorded from the patient.

[0021] The interpolation may use coefficients, such as regression coefficients, pre-derived from a collection of recorded BSPMs to generate the estimated BSPM from integrals of ECG signals recorded from a different number of ECG signals than the pre-determined number of ECG signals used to generate the recorded BSPMs. In an aspect, the different number of ECG signals may comprise a smaller number of ECG signals than the pre-determined number.

[0022] In an aspect, the BSPM of interest may also be calculated from a smaller number of ECG signals (i.e., a reduced set of ECG leads) by using either general or patient-specific regression coefficients. Localization of the activation site of origin may be further facilitated during pacemapping by providing an objective measure of the similarity of the BSPM of interest to a pace site BSPM. The similarity between these BSPMs may be quantified by calculating waveform-comparison metrics.

[0023] As illustrated in Figure 1, body surface potentials may be acquired using an acquisition system 120 such as a BioSemi™ Mark-6. An array of electrodes 140_1...140_N (collectively 140) placed on the patient's torso may be connected via shielded cables or leads 110_1...110_N to the acquisition system 120. The plurality of surface electrodes 140 may, for example, comprise one hundred and twenty disposable radiolucent Ag/AgCl FoxMed™ surface electrodes. Figure 2 illustrates one possible arrangement of 120 leads on the torso for body surface potential mapping. Electrocardiographic signals (ECG signals) are simultaneously recorded using Wilson central terminal as reference. The acquisition system 120 may transmit digitized signals to computing device 130, such as a general purpose personal computer, for data display and recording. The signals may be transmitted through a fibre optic cable to the computing device 130. Data may be recorded to memory such as a hard drive of the computer. In one embodiment, the acquisition system 120 samples each channel at at least 250 Hz and preferably at 2000 Hz, and digitizes the ECG signals with at least 16-bit resolution. The analog ECG signals may be amplified and filtered by an antialiasing bandpass filter (e.g., 0.025 to 300 Hz). The raw data files may be recorded for 15-30 seconds during abnormal rhythm, sinus rhythm or paced rhythm. Faulty signals (e.g., due to poor electrode-skin contact, motion artifacts, inaccessibility of the chest area where the electrodes were supposed to be placed, etc.) may be rejected by the operator. ECG signals recorded for BSPMs may include the standard 12 leads and/or the X,Y,Z leads.

[0024] The computing device 130 comprises a memory module and/or has access to memory in which the recorded ECG signals, collection of BSPMs, set or library of BSPM templates and/or coefficients for interpolation are stored. The computing device 130 also comprises and/or is in communication with a user interface, such

as a display.

[0025] For activation sites in the left ventricle of the heart, segments of the heart may be defined using electroanatomical maps of the left ventricle. For example, the left ventricle may be divided into 16 segments. The left ventricular cavity may be divided along its longitudinal axis into three equal portions; basal, mid-cavity and apical. The basal and mid portions can be divided into 6 segments. The circumferential segments in the basal and mid-cavity may be anterior, anteroseptal, inferoseptal, inferior, inferolateral and anterolateral. Since the left ventricle tapers as it approaches the apex, the apical segment can be divided to 4 segments only: e.g. apical anterior, apical septal, apical inferior and apical lateral or alternatively, apical anteroseptal, apical inferoseptal, apical anterolateral and apical inferolateral. This 16-segment model is a modification from the 17-segment model of Cerqueira et al. ["Standardized myocardial segmentation and nomenclature for tomographic imaging of the heart", *Circulation* 2002; 105:539-42] (shown in Figure 3) due to the absence of an endocardial representative of segment 17 (myocardial cap at the LV apex). The location of each endocardial pacing site or VT origin/exit site may be projected visually from a CARTO™ map to its corresponding location on a polar projection of the left ventricle.

[0026] In one embodiment, recorded BSPMs are calculated by selecting a beat from stored recordings of ECG signals and calculating QRS time integrals for each lead. The QRS time integral is calculated for each lead as the algebraic sum of all potentials from the time instant of QRS onset to QRS offset multiplied by the sampling interval. In another embodiment, the time integral may be calculated for a specified duration, such as the initial 100 msec of the QRS.

[0027] Estimated BSPMs may be calculated from ECG signals collected through a different number of leads than used for the recorded BSPMs. In an aspect, the different number corresponds to a reduced set of leads. The coefficients used for this calculation may be general regression coefficients derived from a collection or database of BSPMs or, alternatively, patient-specific coefficients derived from BSPMs recorded for the same patient in a pre-procedure session. In another embodiment, data from a set of 32 leads may be used. The anatomical sites for these 32 leads may be pragmatically selected based on accessibility of the sites, coverage of the standard 12-lead and X, Y and Z sites, configuration of available strips of electrodes, etc. Alternatively, sites for a given number of electrodes may be selected that are calculated to be optimal using regression analysis on a collection of BSPMs. As for the recorded BSPMs, the integrals may be calculated for QRS onset to QRS offset or for a specified duration, such as the initial 100 msec of the QRS.

[0028] The use of estimated BSPMs greatly simplifies ECG data acquisition during ablation procedure, while maintaining high localization accuracy of BSPMs.

[0029] BSPM templates or patterns for each segment

are calculated by averaging the integrals of all pacing sites within that segment, i.e. averaging all BSPMs for that segment, to obtain a mean BSPM map of the selected interval for each segment. Examples of 12-lead BSPM templates based on recorded BSPMs are shown in Figures 8 and 9, Figure 8 for the interval from QRS onset to QRS offset and Figure 9 for the initial 100 msec of the QRS. Examples of 12-lead BSPM templates based entirely on BSPMs estimated from the 12-lead ECG by using general regression coefficients are shown in Figures 10 and 11, Figure 10 for the interval from QRS onset to QRS offset and Figure 11 for the initial 100 msec of the QRS. In the examples of Figures 8 to 11, isointegral lines or contours in areas 410 and 400 represent positive and negative integrals, respectively. These areas 410 and 400 are separated by a white line or contour 420 representing the zero integral. In an alternative embodiment, BSPM templates may be based on a combination of recorded BSPMs and estimated BSPMs.

[0030] Figures 6 and 7 illustrate 12-lead ECG templates calculated in a similar manner. Although ECG templates for fewer leads such as these may be used to localize activation sites of origin to a segment, localizations may be less accurate than systems that use higher lead count BSPMs.

[0031] As illustrated in Figure 4, to localize a site of origin to a segment or group of segments, a plurality of ECG signals are simultaneous recorded at step 200 and a BSPM of interest is calculated at step 210. If the number of ECG signals simultaneously recorded matches the lead count of the BSPM templates, then the BSPM of interest is calculated as described above for recorded BSPMs. If the number of ECG signals simultaneously recorded has a different lead count, for instance is a lower lead count, from the BSPM templates, then the BSPM of interest is calculated as described above for estimated BSPMs. The BSPM of interest is then compared to each BSPM template of a set or library of BSPM templates at step 220. The set of BSPM templates comprises one template for each pre-defined segment of the heart. To quantify the comparison of the BSPM of interest to each of the BSPM templates, the computing device 130 retrieves the BSPM templates stored in memory and at least one waveform comparison metric is calculated for each BSPM template as compared to the BSPM of interest. Examples of waveform comparison metrics that may be used include correlation coefficients, mean absolute deviation and root mean square of the difference. The BSPM template that most closely resembles the BSPM of interest is identified at step 230 using the calculated comparison metrics, e.g., BSPM template associated with the highest correlation coefficient, the lowest mean absolute deviation and/or the lowest root mean square of the difference. As each BSPM template is associated with a particular segment, the site of origin of the BSPM of interest can be localized if not to the identified segment then to the identified segment and segments adjacent to or near the localized segment.

[0032] By localizing the site of origin to a region of the heart, the area to be mapped by the operator is limited, thereby reducing the time spent in performing catheter mapping and ablation.

[0033] As illustrated in Figure 5, localization of the activation site of origin may be further facilitated during pacemapping by providing an objective measure of the similarity of a pre-recorded BSPM of interest to a pace site BSPM in real-time. In one embodiment, the computing device 130 receives a plurality of simultaneously recorded ECG signals at step 300 associated with a pace site. The computing device 130 then calculates a pace site BSPM at step 310. If the number of ECG signals received matches the lead count of the BSPM of interest, then the pace site BSPM is calculated as described above for recorded BSPMs. If the number of ECG signals received is a different lead count, for instance is a lower lead count, from the BSPM of interest, then the pace site BSPM is calculated as described above for estimated BSPMs. The pace site BSPM is then compared to the BSPM of interest at step 320. To quantify the similarity of the pace site BSPM to the BSPM of interest, the computing device 130 retrieves the BSPM of interest stored in memory and at least one waveform comparison metric is calculated. Examples of waveform comparison metrics that may be calculated include correlation coefficients, mean absolute deviation and root mean square of the difference. An indication of the similarity between the BSPM of interest and the pace site BSPM based on the calculated waveform metric(s) is then displayed on the user interface, such as a computer monitor or screen, in communication with the computing device at step 330.

[0034] From various embodiments of the present invention having been thus described in detail by way of example, it will be apparent to those skilled in the art that variations and modifications may be made without departing from the invention. The invention includes all such variations and modifications as fall within the scope of the appended claims.

[0035] A portion of the disclosure of this patent document contains material which is subject to copyright protection. The copyright owner has no objection to the facsimile reproduction by any one of the patent document or patent disclosure, as it appears in the Patent and Trademark Office patent file or records, but otherwise reserves all copyrights whatsoever.

Claims

1. A method implemented by a computing device (130) for localizing an activation site of origin to one of a plurality of segments of the heart comprising:
 - recording a plurality of simultaneously recorded electrocardiographic (ECG) signals;
 - comparing a body surface potential map (BSPM) of interest to each BSPM template of a

pre-determined set of BSPM templates, the set comprising one BSPM template for each pre-defined segment of the heart, wherein the BSPM of interest is calculated from the plurality of simultaneously recorded ECG signals and wherein comparing comprises, for each BSPM template of the set of BSPM templates:

- retrieving a BSPM template from memory; and
- calculating one or more comparison metrics for the BSPM template retrieved as compared to the BSPM of interest,

wherein each of the BSPM templates was generated by averaging BSPMs of all pacing sites within the associated segment of the heart from a collection of BSPMs stored in memory; identifying the BSPM template that most closely resembles the BSPM of interest using the one or more comparison metrics calculated in order to identify the segment of the heart in which the activation site of origin is likely to be located; wherein each BSPM template of the set of BSPM templates represents a pre-determined number of ECG signals, wherein the BSPMs of interest was calculated from a different number of ECG signals than the pre-determined number and further wherein calculation of the BSPM of interest comprises interpolating between the different number of ECG signals by application of regression coefficients pre-derived from a collection of BSPMs each representing the pre-determined number of ECG signals.

2. The method of claim 1 wherein the BSPMs of interest was calculated from a 12 lead ECG.
3. The method of claim 1 further comprising either general or patient-specific coefficients as regression coefficients.
4. A computer program comprising software code adapted to perform a method for quantifying, during pace mapping, a comparison of a BSPM of interest to a pace site BSPM, the method comprising:

receiving at a computing device (130) a plurality of ECG signals from an acquisition system (120); calculating the pace site BSPM in real-time using the plurality of ECG signals; comparing the BSPM of interest to the pace site BSPM in real-time, wherein comparing comprises:

- retrieving the BSPM of interest from memory accessible by the computing device

(130); and calculating one or more comparison metrics for the BSPM of interest as compared to the pace site BSPM; and displaying on a user interface in communication with the computing device (130) an indication of similarity between the BSPM of interest and the pace site BSPM based on the comparison metric calculated; wherein the BSPM of interest represents a pre-determined number of ECG signals, wherein the pace site BSPM is calculated from a different number of ECG signals than the pre-determined number and further wherein calculation of the pace site BSPM comprises interpolating between the different number of ECG signals by application of regression coefficients pre-derived from a collection of BSPMs each representing the pre-determined number of ECG signals.

5. The computer program of claim 4 wherein calculating one or more comparison metrics comprises calculating one or more wave-form comparison metrics.
6. The computer program of claim 5 wherein the wave-form comparison metrics comprise correlation coefficients, mean absolute deviation and root mean square of the difference.
7. The computer program of claim 4 further comprising, prior to pace mapping, localizing an activation site of origin to one of a plurality of segments of the heart using said retrieved BSPM of interest.
8. Computing device (130) configured to perform the method according to at least one of claims 1 and 2.

40 Patentansprüche

1. Verfahren, implementiert durch eine Computervorrichtung (130), zum örtlichen Eingrenzen einer Aktivierungsursprungsstelle auf eines einer Vielzahl von Segmenten des Herzens, umfassend:

Aufzeichnen einer Vielzahl simultan aufgezeichneter elektrokardiografischer (EKG) Signale;
 Vergleichen einer Körperoberflächenpotentialkarte (BSPM) von Interesse mit jeder BSPM-Vorlage eines vorgegebenen Sets von BSPM-Vorlagen, wobei das Set eine BSPM-Vorlage für jedes zuvor definierte Segment des Herzens umfasst, wobei die BSPM von Interesse aus der Vielzahl simultan aufgezeichneter EKG-Signale berechnet wird und wobei das Vergleichen für jede BSPM-Vorlage des Sets von BSPM-Vorla-

gen Folgendes umfasst:

Abrufen einer BSPM-Vorlage aus dem Speicher; und
Berechnen einer oder mehrerer Vergleichsmetriken für die abgerufene BSPM-Vorlage im Vergleich zu der BSPM von Interesse,

wobei jede der BSPM-Vorlagen durch Mitteln von BSPMs aller Schrittstellen innerhalb des zugehörigen Segments des Herzens aus einer Sammlung in dem Speicher gespeicherter BSPMs erzeugt wurde;

Identifizieren der BSPM-Vorlage, die der BSPM von Interesse am meisten ähnelt, unter Verwendung der einen oder mehreren Vergleichsmetriken, berechnet zur Identifizierung des Segments des Herzens, in dem sich die Aktivierungsursprungsstelle wahrscheinlich befindet; wobei jede BSPM-Vorlage des Sets von BSPM-Vorlagen eine vorgegebene Anzahl von EKG-Signalen darstellt, wobei die BSPMs von Interesse aus einer anderen Anzahl von EKG-Signalen als der vorgegebenen Anzahl berechnet wurde und wobei die Berechnung der BSPM von Interesse weiter das Interpolieren zwischen der anderen Anzahl von EKG-Signalen durch Anwendung von Regressionskoeffizienten, zuvor abgeleitet von einer Sammlung von BSPMs, die jeweils die vorgegebene Anzahl von EKG-Signalen darstellen, umfasst.

2. Verfahren nach Anspruch 1, wobei die BSPMs von Interesse aus einem 12-Kanal-EKG berechnet wurde.
3. Verfahren nach Anspruch 1, weiter umfassend entweder allgemeine oder patientenspezifische Koeffizienten als Regressionskoeffizienten.
4. Computerprogramm, umfassend Software-Code, der angepasst ist, um ein Verfahren zum Quantifizieren, während der Schrittkartierung, eines Vergleichs einer BSPM von Interesse mit einer Schrittstellen-BSPM durchzuführen, wobei das Verfahren Folgendes umfasst:

Empfangen, auf einem Computergerät (130), einer Vielzahl von EKG-Signalen von einem Erfassungssystem (120);
Berechnen der Schrittstellen-BSPM in Echtzeit unter Verwendung der Vielzahl von EKG-Signalen;
Vergleichen der BSPM von Interesse mit der Schrittstellen-BSPM in Echtzeit, wobei das Vergleichen Folgendes umfasst:

Abrufen der BSPM von Interesse aus dem

Speicher, zugänglich durch das Computergerät (130); und

Berechnen einer oder mehrerer Vergleichsmetriken für die BSPM von Interesse im Vergleich zu der Schrittstellen-BSPM; und Anzeigen, auf einer Benutzeroberfläche in Kommunikation mit der Computervorrichtung (130), eines Hinweises für Ähnlichkeit zwischen der BSPM von Interesse und der Schrittstellen-BSPM auf der Basis der berechneten Vergleichsmetrik;

wobei die BSPM von Interesse eine vorgegebene Anzahl von EKG-Signalen darstellt, wobei die Schrittstellen-BSPM aus einer anderen Anzahl von EKG-Signalen als der vorgegebenen Anzahl berechnet wird und wobei die Berechnung der Schrittstellen-BSPM weiter das Interpolieren zwischen der anderen Anzahl von EKG-Signalen durch Anwendung von Regressionskoeffizienten, zuvor abgeleitet von einer Sammlung von BSPM, die jeweils die vorgegebene Anzahl von EKG-Signalen darstellen, umfasst.

5. Computerprogramm nach Anspruch 4, wobei das Berechnen einer oder mehrerer Vergleichsmetriken das Berechnen einer oder mehrerer Wellenform-Vergleichsmetriken umfasst.
6. Computerprogramm nach Anspruch 5, wobei die Wellenform-Vergleichsmetriken Korrelationskoeffizienten, die mittlere absolute Abweichung und das quadratische Mittel des Unterschieds umfassen.
7. Computerprogramm nach Anspruch 4, weiter umfassend das örtliche Eingrenzen, vor der Schrittkartierung, einer Aktivierungsursprungsstelle auf eines einer Vielzahl von Segmenten des Herzens unter Verwendung der abgerufenen BSPM von Interesse.
8. Computervorrichtung (130), die konfiguriert ist, um das Verfahren nach mindestens einem der Ansprüche 1 und 2 durchzuführen.

Revendications

1. Procédé mis en oeuvre par un dispositif informatique (130) pour localiser un site d'activation d'origine sur l'un d'une pluralité de segments du coeur, comprenant :

l'enregistrement d'une pluralité de signaux électrocardiographiques (ECG) simultanément enregistrés ;
la comparaison d'une carte de potentiel de surface corporelle (BSPM) d'intérêt à chaque ma-

trice BSPM d'un ensemble prédéterminé de matrices BSPM, l'ensemble comprenant une matrice BSPM pour chaque segment prédéfini du coeur, dans lequel la BSPM d'intérêt est calculée parmi la pluralité de signaux ECG simultanément enregistrés et dans lequel la comparaison comprend, pour chaque matrice BSPM de l'ensemble de matrices BSPM :

la récupération d'une matrice BSPM dans la mémoire ; et
le calcul d'une ou plusieurs métriques de comparaison pour la matrice BSPM récupérée en comparaison de la BSPM d'intérêt,

dans lequel chacune des matrices BSPM a été générée en prenant la moyenne de toutes les BSPM de tous les sites d'électrostimulation dans le segment associé du coeur dans un recueil de BSPM stockés en mémoire ;

l'identification de la matrice BSPM qui ressemble le plus étroitement à la BSPM d'intérêt en utilisant les une ou plusieurs métriques de comparaison calculées afin d'identifier le segment du coeur dans lequel le site d'origine d'activation est susceptible d'être situé ;

dans lequel chaque matrice BSPM de l'ensemble de matrices BSPM représente un nombre prédéterminé de signaux ECG, dans lequel la BSPM d'intérêt a été calculée dans un nombre de signaux ECG différent du nombre prédéterminé et dans lequel en outre le calcul de la BSPM d'intérêt comprend l'interpolation entre le nombre différent de signaux ECG par application de coefficients de régression pré-dérivés d'un recueil de BSPM représentant chacun le nombre prédéterminé de signaux ECG.

2. Procédé selon la revendication 1, dans lequel la BSPM d'intérêt a été calculée à partir d'un ECG à 12 dérivations.
3. Procédé selon la revendication 1, comprenant en outre des coefficients généraux ou spécifiques à un patient comme coefficients de régression.
4. Programme d'ordinateur comprenant un code de logiciel qui est à même d'effectuer un procédé pour quantifier au cours d'un mappage d'électrostimulation une comparaison d'une BSPM d'intérêt avec une BSPM de site d'électrostimulation, le procédé comprenant :

la réception dans un dispositif informatique (130) d'une pluralité de signaux ECG venant d'un système d'acquisition (120) ;
le calcul de la BSPM du site d'électrostimulation

en temps réel en utilisant la pluralité de signaux ECG ;

la comparaison de la BSPM d'intérêt à la BSPM du site d'électrostimulation en temps réel, dans lequel la comparaison comprend :

la récupération de la BSPM d'intérêt de la mémoire accessible par le dispositif informatique (130) ; et

le calcul d'une ou plusieurs métriques de comparaison pour la BSPM d'intérêt en comparaison de la BSPM du site d'électrostimulation ; et

l'affichage sur une interface utilisateur en communication avec le dispositif informatique (130) d'une indication de similarité entre la BSPM d'intérêt et la BSPM du site d'électrostimulation sur la base de la métrique de comparaison calculée ;

dans lequel la BSPM d'intérêt représente un nombre prédéterminé de signaux ECG, dans lequel la BSPM du site d'électrostimulation est calculé à partir d'un nombre de signaux ECG différent du nombre prédéterminé et dans lequel, en outre, la BSPM du site d'électrostimulation comprend l'interpolation entre le nombre différent de signaux ECG par application de coefficients de régression pré-dérivés d'un recueil de BSPM représentant chacune le nombre prédéterminé de signaux ECG.

5. Programme d'ordinateur selon la revendication 4, dans lequel le calcul d'une ou plusieurs métriques de comparaison comprend le calcul d'une ou plusieurs métriques de comparaison de forme d'onde.
6. Programme d'ordinateur selon la revendication 5, dans lequel la métrique de comparaison de forme d'onde comprend des coefficients de corrélation, l'écart absolu moyen et la moyenne quadratique de la différence.
7. Programme d'ordinateur selon la revendication 4, comprenant en outre, avant le mappage d'électrostimulation, la localisation d'un site d'origine d'activation dans l'un d'une pluralité de segments du coeur utilisant ladite BSPM d'intérêt récupérée.
8. Dispositif informatique (130) configuré pour effectuer le procédé selon au moins l'une quelconque des revendications 1 et 2.

Figure 1

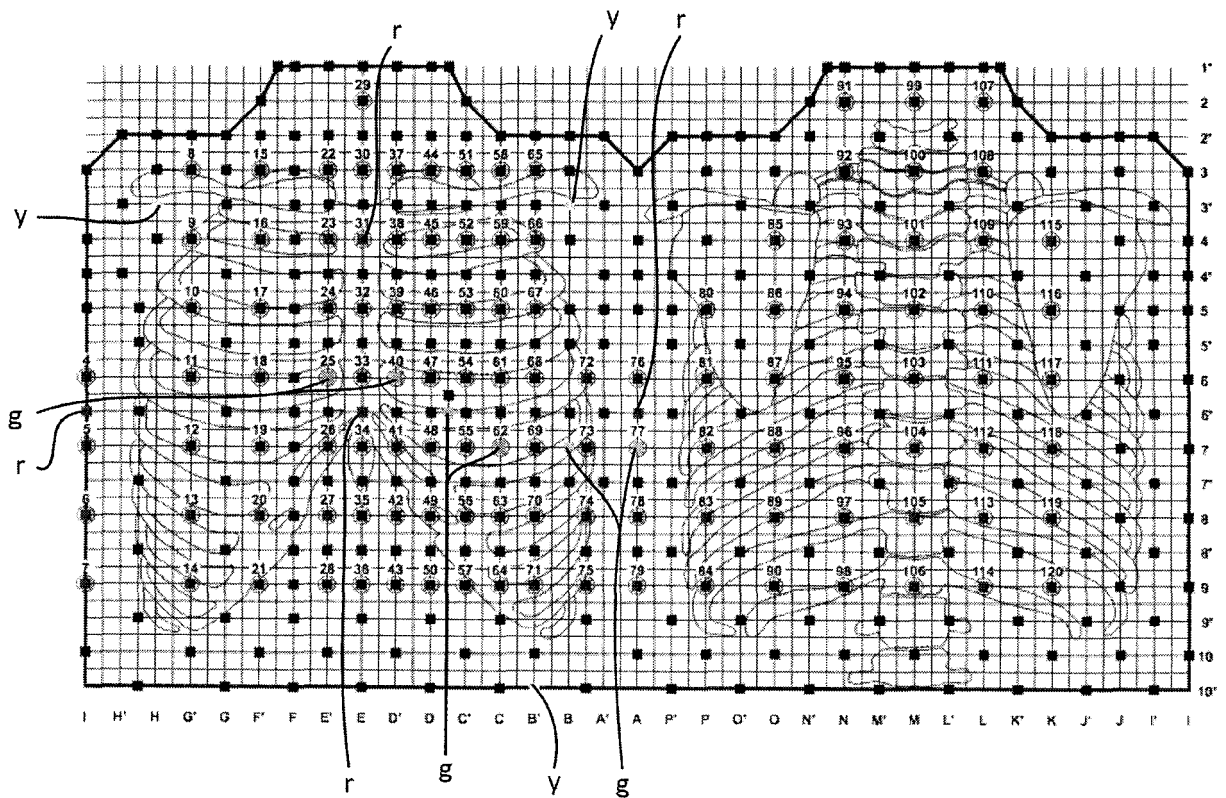
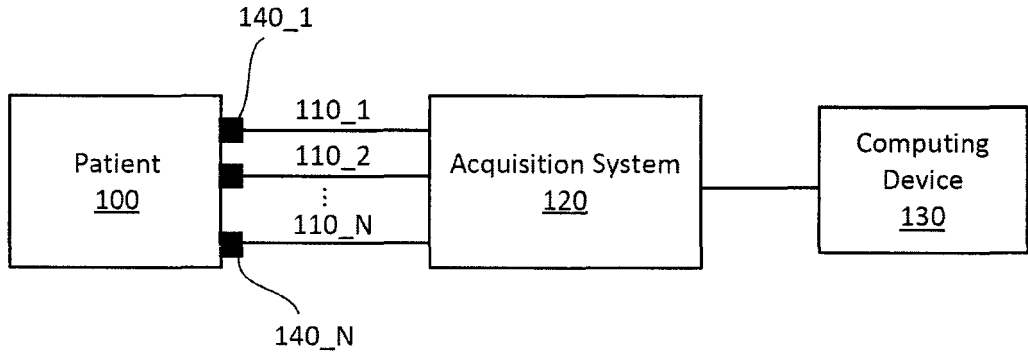

Figure 2

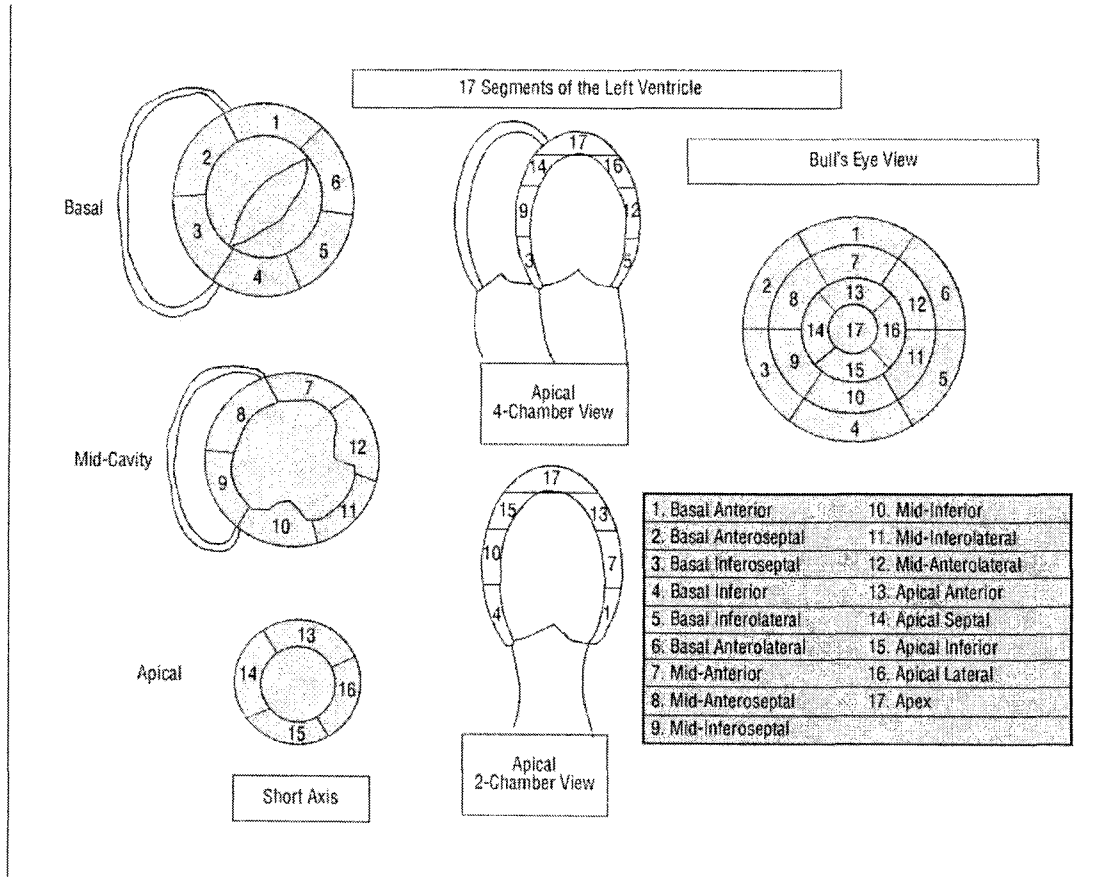

Figure 3

Figure 4

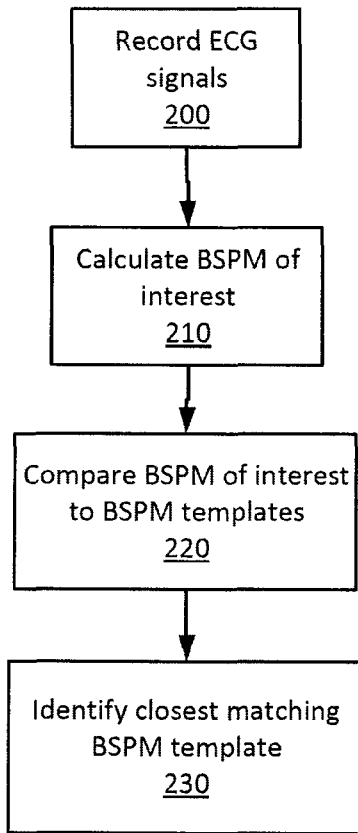
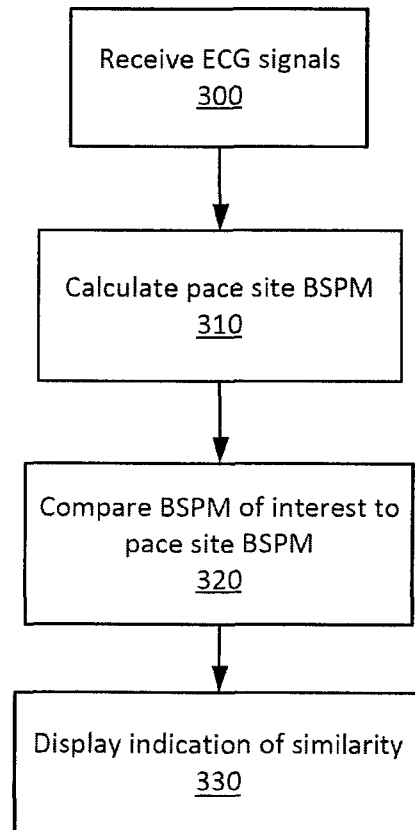

Figure 5



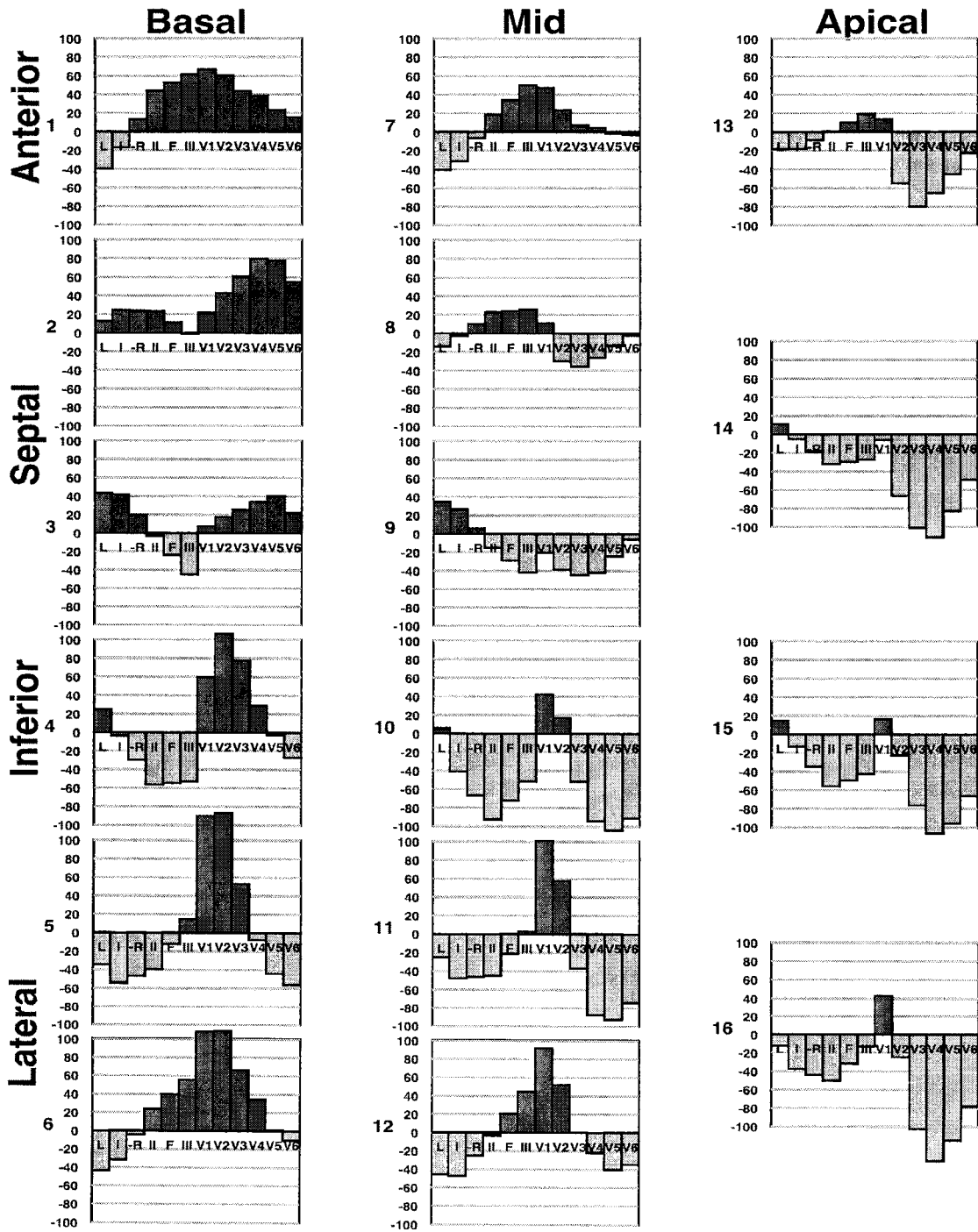

Figure 6

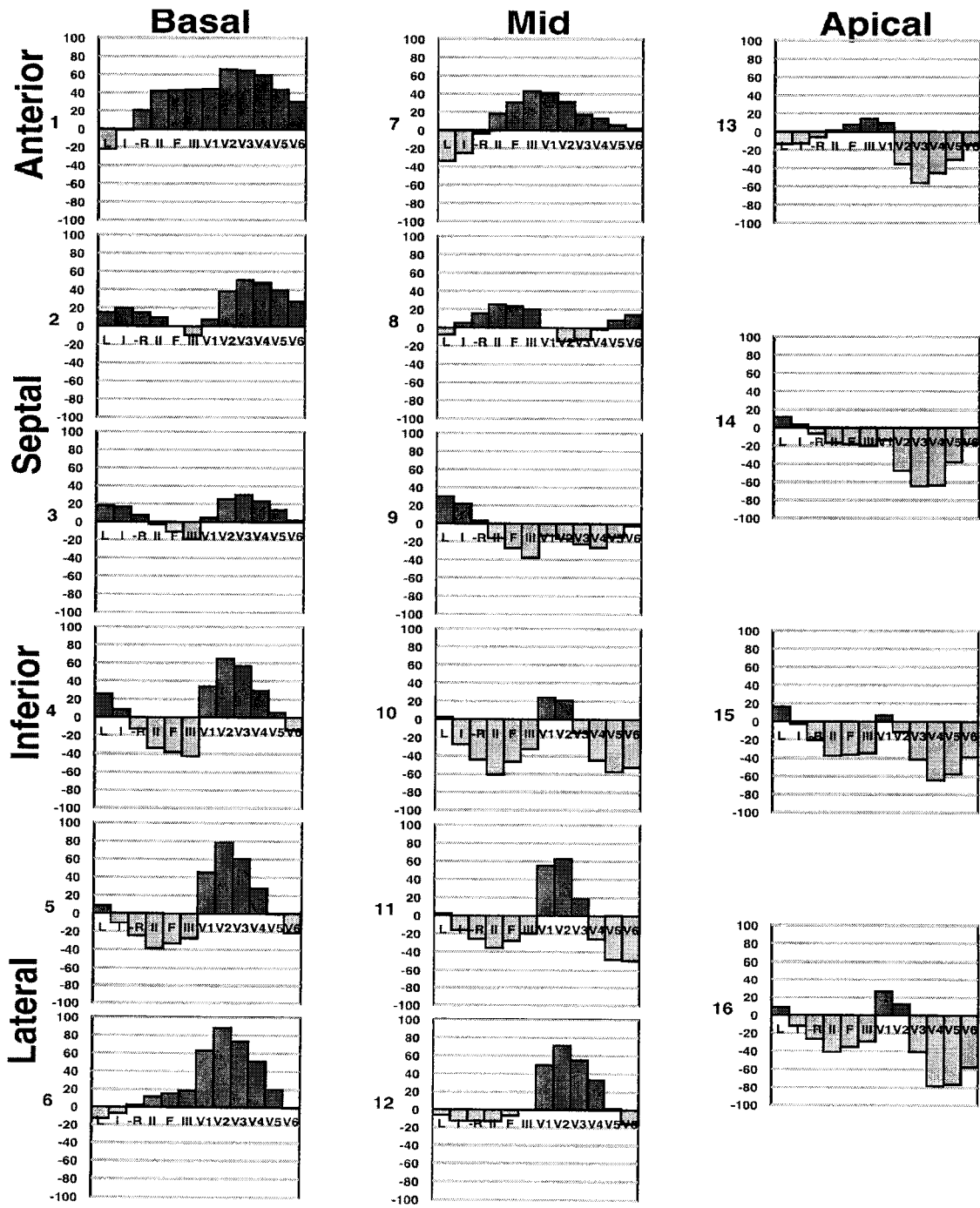

Figure 7

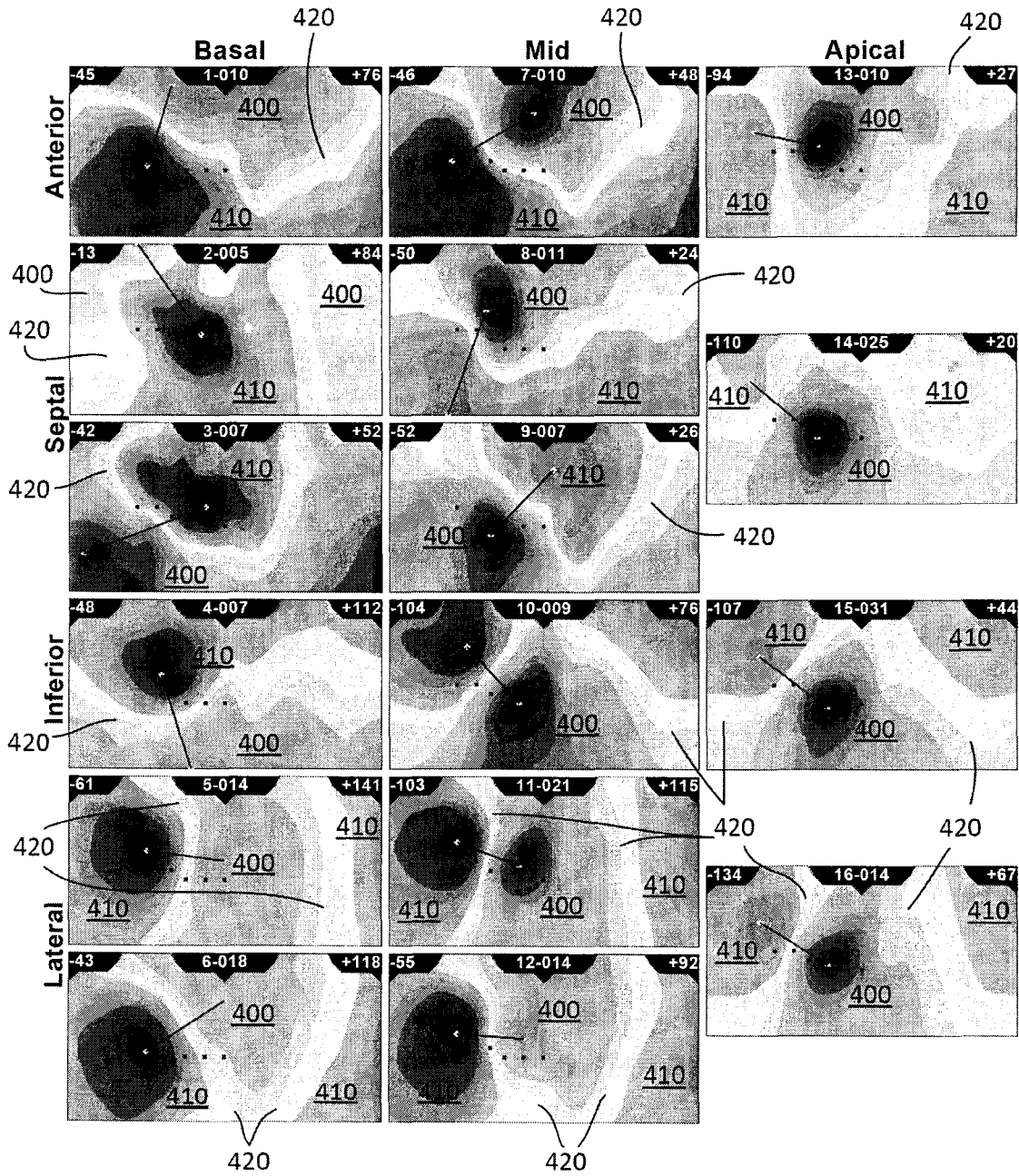

Figure 8

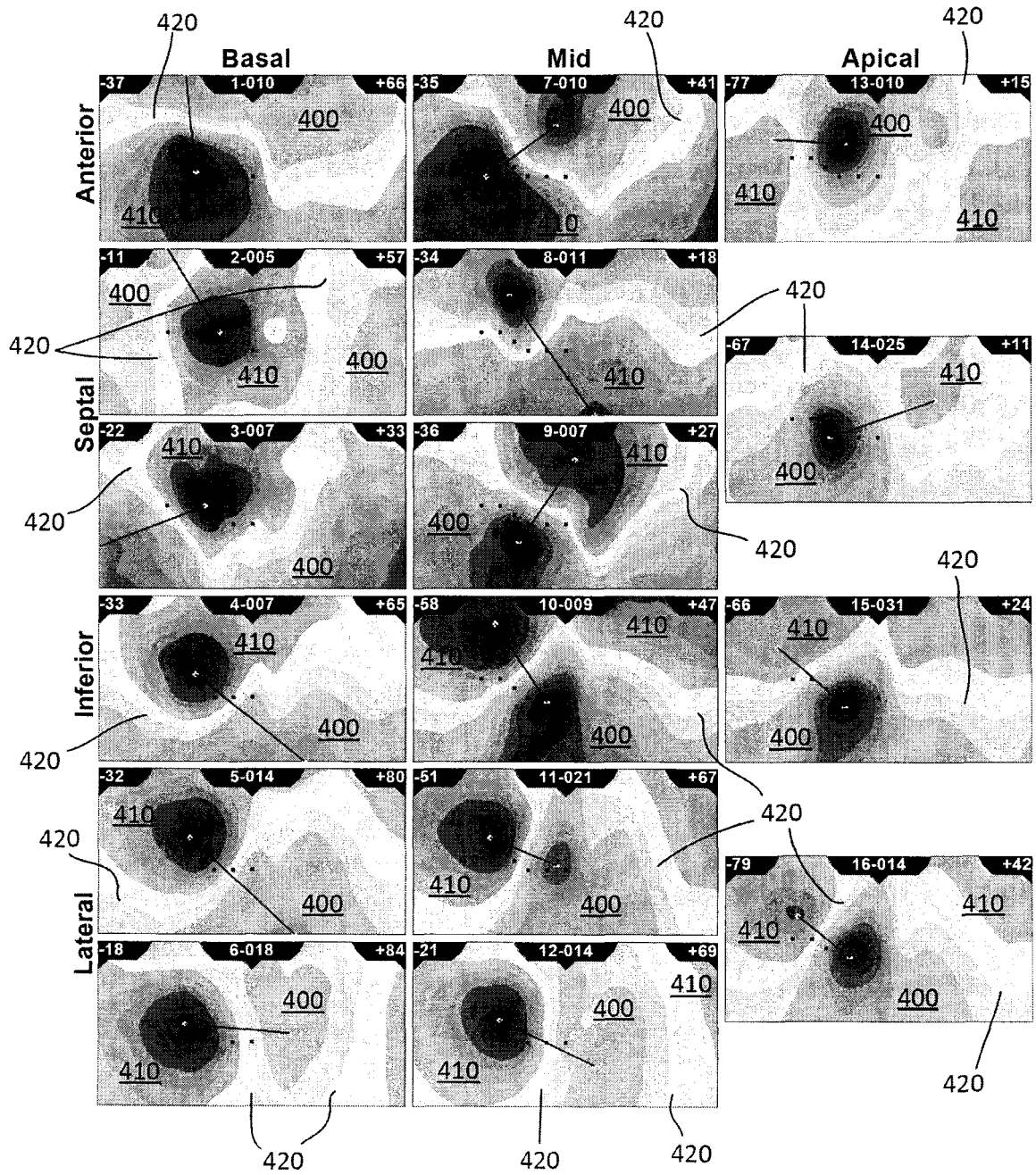

Figure 9

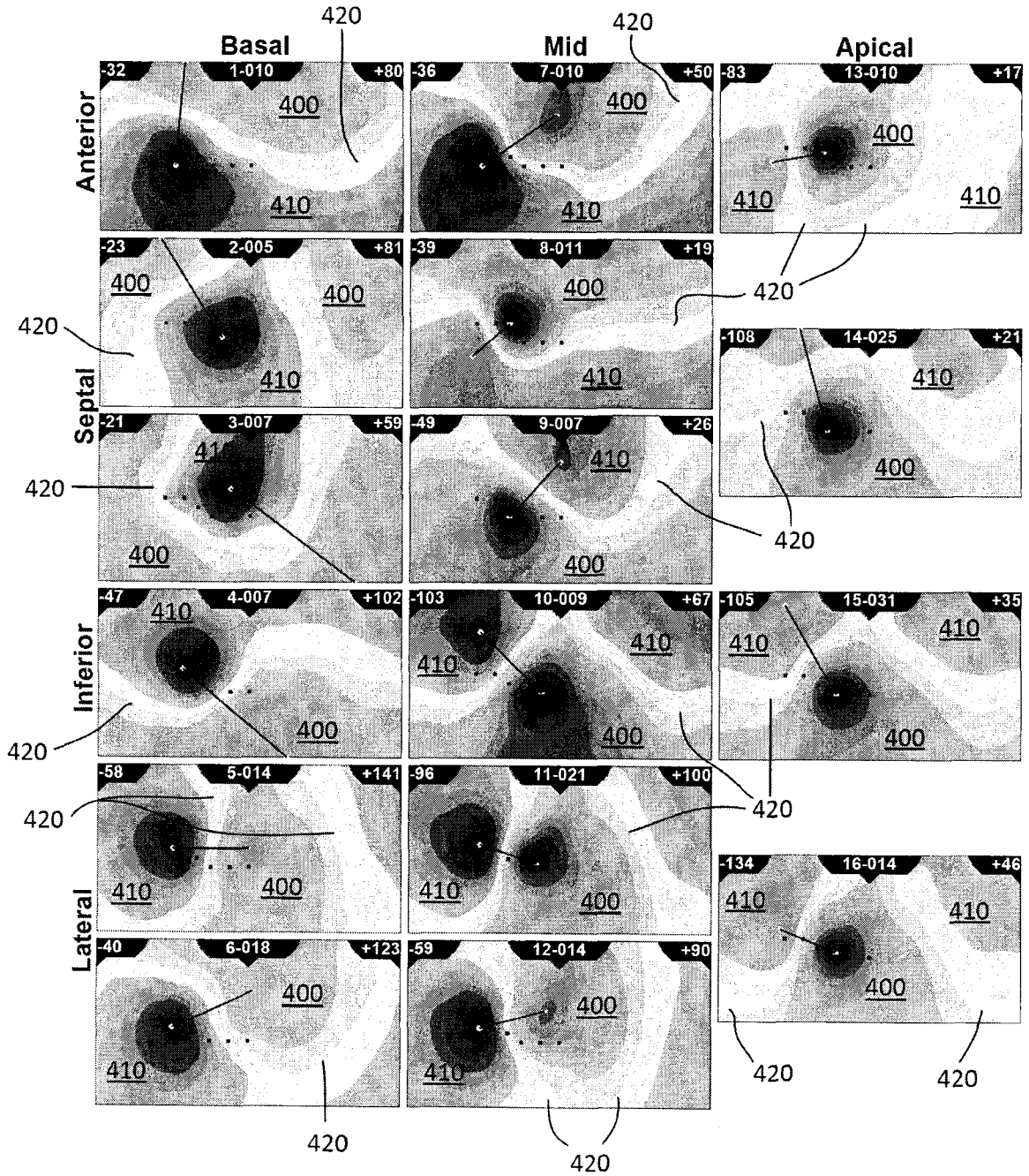

Figure 10

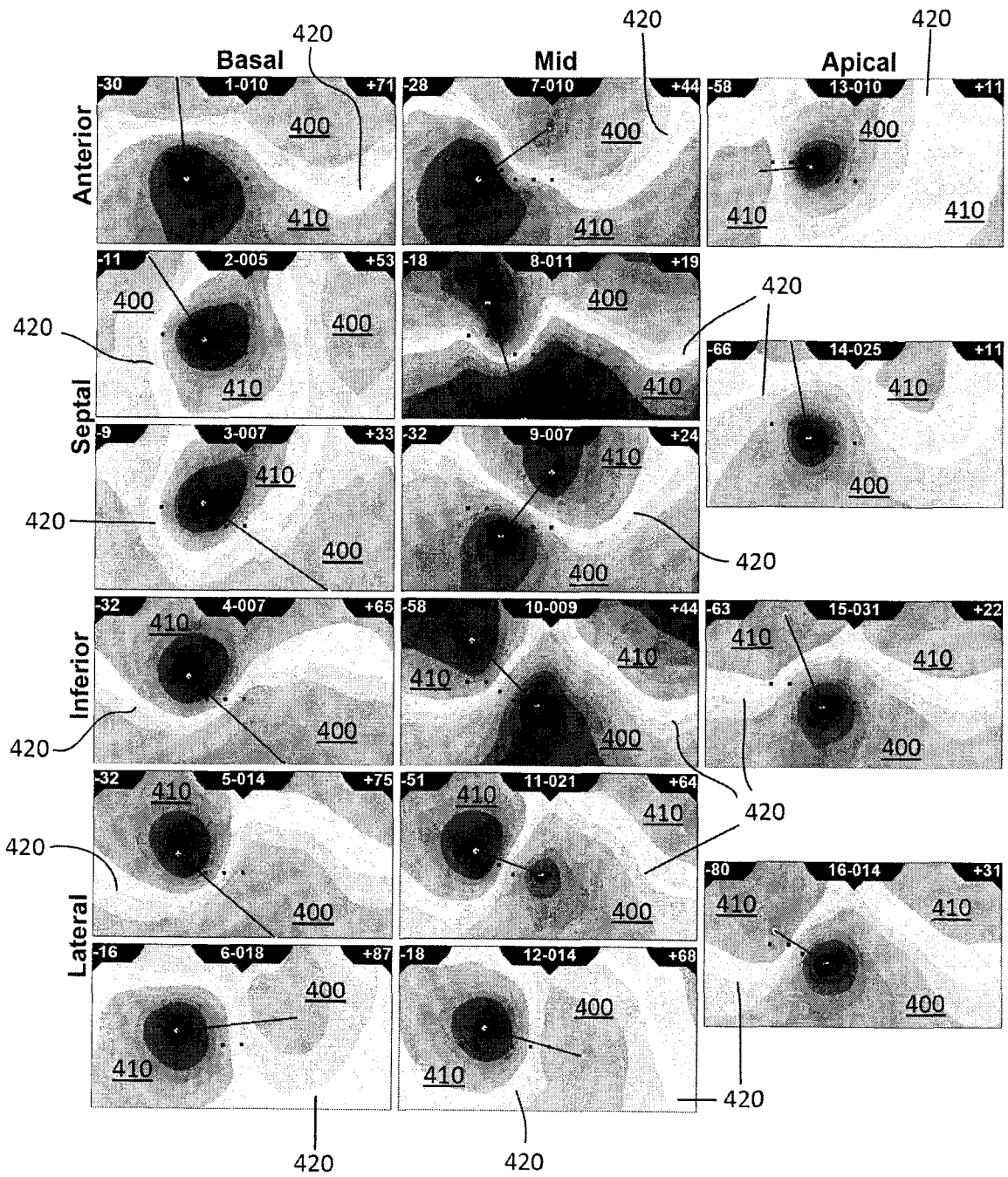

Figure 11

REFERENCES CITED IN THE DESCRIPTION

This list of references cited by the applicant is for the reader's convenience only. It does not form part of the European patent document. Even though great care has been taken in compiling the references, errors or omissions cannot be excluded and the EPO disclaims all liability in this regard.

Patent documents cited in the description

- US 2002038093 A1 [0011]

Non-patent literature cited in the description

- **CERQUEIRA et al.** Standardized myocardial segmentation and nomenclature for tomographic imaging of the heart. *Circulation*, 2002, vol. 105, 539-42 [0025]

专利名称(译)	计算机辅助定位心脏激活的起源点		
公开(公告)号	EP2723230A1	公开(公告)日	2014-04-30
申请号	EP2012802549	申请日	2012-06-20
申请(专利权)人(译)	达尔豪斯大学		
当前申请(专利权)人(译)	达尔豪斯大学		
[标]发明人	SAPP JOHN LEWIS JR HORACEK BOHUMIL MILAN EL DAMATY AHMED MOHAMED FAHMEY		
发明人	SAPP, JOHN, LEWIS, JR. HORACEK, BOHUMIL MILAN EL-DAMATY, AHMED MOHAMED FAHMEY		
IPC分类号	A61B5/0452 A61B5/0402 A61B5/00 A61B5/0408		
CPC分类号	A61B5/0402 A61B5/04028 A61B5/04085 A61B5/7246 A61B5/0205		
优先权	61/501036 2011-06-24 US		
其他公开文献	EP2723230B1 EP2723230A4		
外部链接	Espacenet		

摘要(译)

一种用于在起搏过程中量化感兴趣的BSPM与起搏点BSPM的较的方法。该方法可以包括在计算设备处接收来自采集系统的多个ECG信号。可以使用多个ECG信号来计算起搏部位BSPM。可以通过以下方式将感兴趣的BSPM与起搏站点BSPM进行比较：从计算设备可访问的存储器中检索感兴趣的BSPM；并且，与起搏站点BSPM相比，计算感兴趣的BSPM的一个或多个比较度量。基于所计算的比较度量，感兴趣的BSPM与起搏站点BSPM之间的相似性的指示可以显示在与计算设备通信的用户界面上。