

(12) INTERNATIONAL APPLICATION PUBLISHED UNDER THE PATENT COOPERATION TREATY (PCT)

(19) World Intellectual Property  
Organization

International Bureau

(43) International Publication Date  
04 January 2018 (04.01.2018)



(10) International Publication Number  
WO 2018/002722 A1

(51) International Patent Classification:

A61B 5/117 (2016.01) A61B 5/0205 (2006.01)  
A61B 5/00 (2006.01) A61B 5/0404 (2006.01)  
A61B 5/08 (2006.01) A61B 5/0488 (2006.01)  
G06F 21/32 (2013.01) A61B 5/11 (2006.01)  
G06K 9/00 (2006.01)

(21) International Application Number:

PCT/IB2017/000969

(22) International Filing Date:

03 July 2017 (03.07.2017)

(25) Filing Language:

English

(26) Publication Language:

English

(30) Priority Data:

62/357,665 01 July 2016 (01.07.2016) US

(71) Applicant: **L.I.F.E. CORPORATION S.A.** [LU/LU]; 20,  
rue Jean-Pierre Beicht, L-1226 Luxembourg (LU).

(72) Inventor: **LONGINOTTI-BUITONI, Gianluigi**; 20, rue  
Jean-Pierre beicht, L-1226 Luxembourg (LU).

(74) Agent: **PRICE, Nigel John King et al.**; J.A. Kemp & Co.,  
14 South Square, Gray's Inn, London WC1R 5JJ (GB).

(81) Designated States (*unless otherwise indicated, for every kind of national protection available*): AE, AG, AL, AM, AO, AT, AU, AZ, BA, BB, BG, BH, BN, BR, BW, BY, BZ, CA, CH, CL, CN, CO, CR, CU, CZ, DE, DJ, DK, DM, DO, DZ, EC, EE, EG, ES, FI, GB, GD, GE, GH, GM, GT, HN, HR, HU, ID, IL, IN, IR, IS, JO, JP, KE, KG, KH, KN, KP, KR, KW, KZ, LA, LC, LK, LR, LS, LU, LY, MA, MD, ME, MG, MK, MN, MW, MX, MY, MZ, NA, NG, NI, NO, NZ, OM, PA, PE, PG, PH, PL, PT, QA, RO, RS, RU, RW, SA, SC, SD, SE, SG, SK, SL, SM, ST, SV, SY, TH, TJ, TM, TN, TR, TT, TZ, UA, UG, US, UZ, VC, VN, ZA, ZM, ZW.

(84) Designated States (*unless otherwise indicated, for every kind of regional protection available*): ARIPO (BW, GH, GM, KE, LR, LS, MW, MZ, NA, RW, SD, SL, ST, SZ, TZ, UG, ZM, ZW), Eurasian (AM, AZ, BY, KG, KZ, RU, TJ, TM), European (AL, AT, BE, BG, CH, CY, CZ, DE, DK, EE, ES, FI, FR, GB, GR, HR, HU, IE, IS, IT, LT, LU, LV, MC, MK, MT, NL, NO, PL, PT, RO, RS, SE, SI, SK, SM, TR), OAPI (BF, BJ, CF, CG, CI, CM, GA, GN, GQ, GW, KM, ML, MR, NE, SN, TD, TG).

Published:

- with international search report (Art. 21(3))
- before the expiration of the time limit for amending the claims and to be republished in the event of receipt of amendments (Rule 48.2(h))

(54) Title: BIOMETRIC IDENTIFICATION BY GARMENTS HAVING A PLURALITY OF SENSORS

(57) Abstract: Biometric identification methods and apparatuses (including devices and systems) for uniquely identifying one an individual based on wearable garments including a plurality of sensors, including but not limited to sensors having multiple sensing modalities (e.g., movement, respiratory movements, heart rate, ECG, EEG, etc.).



WO 2018/002722 A1

## BIOMETRIC IDENTIFICATION BY GARMENTS HAVING A PLURALITY OF SENSORS

### CROSS REFERENCE TO RELATED APPLICATIONS

5 [0001] This patent application claims priority to U.S. provisional patent application no. 62/357,665, titled "BIOMETRIC IDENTIFICATION BY WORN MOVEMENT SENSORS," and filed on July 1, 2016, the entirety of which is herein incorporated by reference in its entirety.

### INCORPORATION BY REFERENCE

10 [0002] All publications and patent applications mentioned in this specification are herein incorporated by reference in their entirety to the same extent as if each individual publication or patent application was specifically and individually indicated to be incorporated by reference.

### FIELD

15 [0003] Described herein are systems and methods to determine and/or confirm the identity of an individual based on an analysis of sensed parameters from a plurality of sensors worn as part of an integrated garment. The sensors may include a plurality of sensor management subsystems (SMSes) distributed in characteristic positions as part of the garment(s). These SMSes may be coordinated for local sensing, including precise time-coordination with a central processor, and  
20 may record a variety of different parameters including, but not limited to individuals body movements, including voluntary movements (e.g., gait, arm, hand, leg, finger, foot, knee, elbow, chest, etc. movements), and involuntary movements or reactions (e.g., respiratory rate, heart rate, ECG, EMG, EOG, etc.), from which a biometric pattern may be determined. The voluntary and involuntary movements or reactions may be linked to the voluntary movements. A biometric  
25 indicator may be learned by the system while wearing the apparatus, and features extracted from the recorded data in order to generate a biometric template. The biometric template may be stored and used as a test against future biometric templates (profiles, and in some variations, tokens) from the same or different garments worn by the user to uniquely identify the user. Described herein are methods of forming an identifying biometric template, methods of storing  
30 and transmitting the biometric template information securely, and/or methods of using the biometric template to uniquely and accurately identify an individual. Also described herein are the apparatuses (devices and systems) performing these methods as well.

[0004] For example, described herein are garments having a variety of sensors forming SMSes that may be used to determine, confirm, or analysis biometric identification.

## BACKGROUND

[0005] It has become increasingly important to uniquely identify an individual. Stealing or hacking personal, financial, medical and security information is increasingly common. Attacks  
5 against digital information databases are increasing. For example, by 2015, fraudulent card transactions have exceeded \$11 billion a year worldwide, of which the U.S. represents 50%, while Europe follows with 15% of the total. Health insurance providers are one of the many industries most affected by hacking. In 2014, 47% of American adults had their personal information stolen by hackers-primarily through data breaches at large companies. In 2013, 43%  
10 of companies had a data breach in which hackers got into their systems to steal information. Data breaches targeting consumer information are on the rise, increasing 62% from 2012 to 2013, with 594% more identities stolen. Data about more than 120 million people has been compromised in more than 1,100 separate breaches at organizations handling protected health data since 2009. The data reflects a staggering number of times individuals have been affected  
15 by breaches at organizations trusted with sensitive health information.

[0006] Some of the data can be used to pursue traditional financial crimes, such as setting up fraudulent lines of credit, but it can also be used for medical insurance fraud, including purchasing medical equipment for resale or obtaining pricey medical care for another person. Personal information is also at risk, including information about an individual's mental health or  
20 HIV treatments.

[0007] Existing solutions are not adequate. For example, the security of passwords (e.g., password-protected systems) depends on a variety of factors. Compromising attacks, such as protection against computer viruses, man-in-the-middle attacks (where the attacker secretly intrudes into the communication of two unaware parties intercepting their conversation),  
25 physical breach (such as bystanders stealing the password by covertly observing thorough video cameras, e.g., at ATMs machines), etc. The stronger the password, the more secure is the information it protects. Strength may be a function of length, complexity and unpredictability. Using strong passwords lowers overall risk of a security breach, but strong passwords do not replace the need for other effective security controls. The effectiveness of a password of a given  
30 strength is strongly determined by the design and implementation of the factors (knowledge, ownership, inherence).

[0008] Tokens (security tokens) are used to prove one's identity electronically, as in the case of a customer trying to access their bank account. The token is used in addition to or in place of a password to prove that the customer is who they claim to be. The token acts like an electronic  
35 key to access something.

[0009] The simplest vulnerability with any password container is theft or loss of the device. The chances of this happening, or happening unawares, can be reduced with physical security measures such as locks, electronic leashes, or body sensors and alarms. Stolen tokens can be made useless by using two factor authentication. Commonly, in order to authenticate, a personal  
5 identification number (PIN) must be entered along with the information provided by the token the same time as the output of the token.

[00010] Any system which allows users to authenticate via an untrusted network (such as the Internet) is vulnerable to man-in-the-middle attacks. In this type of attack, a fraudulent party acts as the "go-between" the user and the legitimate system, soliciting the token output from the  
10 legitimate user and then supplying it to the authentication system themselves. Since the token value is mathematically correct, the authentication succeeds and the party is improperly granted access.

[00011] Trusted as much a regular hand-written signature, a digital signature should ideally be made with a private key known only to the person authorized to make the signature. Tokens that  
15 allow secure on-board generation and storage of private keys enable secure digital signatures, and can also be used for user authentication, as the private key also serves as a proof for the user's identity.

[00012] For tokens to identify the user, all tokens must have some kind of number that is unique. Not all approaches fully qualify as digital signatures according to some national laws.  
20 Tokens with no on-board keyboard or another user interface cannot be used in some signing scenarios, such as confirming a bank transaction based on the bank account number that the funds are to be transferred to.

[00013] Biometrics (e.g., biometric identification systems) often physical features to check a person's identity, ensure much greater security than password and number systems. Biometric  
25 features such as the face or a fingerprint can be stored on a microchip in a credit card, for example. A single feature, however, sometimes fails to be exact enough for identification. Another disadvantage of using only one feature is that the chosen feature is not always readable.

[00014] A template protection scheme with provable security and acceptable recognition performance has thus far remained elusive. Development of such a scheme is crucial as  
30 biometric systems are beginning to proliferate into the core physical and information infrastructure of our society. Described herein are methods and apparatuses that may address the issues discussed above.

## SUMMARY OF THE DISCLOSURE

[00015] Described herein are apparatuses (systems, methods, including garments, etc.) and methods that allow individual owners to use their identifier, which may be based on a wearable (e.g., garment) capable of medical-level physiological data and biometrics measuring, acting as a communication platform, which may allow a user to uniquely identify herself/himself in order to perform security-sensitive actions such as being identified, generating medical data, transferring funds, purchasing goods, modify contracts, enter in restricted-access areas, etc., with certainty of identity, without divulging data to a third party, minimizing the risk of data being stolen. These methods and apparatuses may convert data detected in a predefined manner from any of the wearable apparatuses described herein (or similar in at least some of the functional characteristics described herein) into biometric template information that may be stored and later compared against other similarly-acquired biometric information to confirm a user's identity. This information may act as a token in a security protocol, method or system. These methods and apparatuses may generate the biometric information from one or more wearable garments including a plurality of integrated SMSes; the garment may securely receive, record and transmit a biometric profile (e.g., template or token) derived from the one sensor (or more likely plurality of sensors) integrated into the garment(s), in minimal time and with minimal cost. A biometric profile may be a measurement of a physiological trait, traditionally such as fingerprint, iris pattern, retina image, hand or face geometry, or it can be a behavioral trait such as voice, body sweating, and gait. Current biometric technology identifies individuals automatically through one or several of these traits. Automatically means that the person's trait has been scanned, converted into a digital form in a database or on identity card. Thus current technology obliges individuals to divulge their data (to the database that will identify them) with the risk of the database being hacked or the card being stolen. The moment users divulge their data they have lost it, potentially irrevocably: unlike passwords, biometrics cannot be easily changed. Furthermore current biometric technology may not be accurate because it is not able to be universally present, unique to the individual, stable over time and easily measurable and have the disadvantage that, unlike a password, a person's characteristics are not secret and can therefore be copied. Once copied biometric data is lost forever: unlike a password it cannot be reset. The methods and apparatuses (e.g., systems and devices) described herein may overcome these limitations. See, e.g., US6016476, describing a portable information and transaction processing system and method utilizing biometric authorization and digital certificate security.

[00016] Commonly used biometric traits include fingerprint, face, iris, hand geometry, voice, palm print, handwritten signatures, and gait. Biometric traits have a number of desirable properties with respect to their use as an authentication token, namely, reliability, convenience,

universality, and so forth. These characteristics have led to the widespread deployment of biometric authentication systems. But there are still some issues concerning the security of biometric recognition systems that need to be addressed in order to ensure the integrity and public acceptance of these systems. There are five 5 components in a generic biometric authentication system, namely, 1) sensor, 2) feature extractor, 3) template database, 4) matcher, and 5) decision module. A sensor is the interface between the user and the authentication system and its function is to scan the biometric trait of the user. A feature extraction module processes the scanned biometric data to extract the salient information (feature set) that is useful in distinguishing between different users. In some cases, the feature extractor is preceded by a quality assessment module which determines whether the scanned biometric trait is of sufficient quality for further processing.

[00017] The systems described herein may not need all of these components, since biometric data may not necessarily be stored in a database; instead these systems may use data generated during the biometric identification process. Thus, these systems may not need a template database. Otherwise, during enrollment, the extracted feature set may be stored in a database as a template (XT) indexed by the user's identity information. Since the template database could be geographically distributed and contain millions of records (e.g., in a national identification system), maintaining its security is often not a trivial task. The matcher module is usually an executable program, which accepts two biometric feature sets XT and XQ (from template and query, resp.) as inputs, and outputs a match score (S) indicating the similarity between the two sets. Finally, the decision module makes the identity decision and initiates a response to the query.

[00018] A fish-bone model can be used to summarize the various causes of biometric system vulnerability. At the highest level, the failure modes of a biometric system can be categorized into two classes: intrinsic failure and failure due to an adversary attack. Intrinsic failures occur due to inherent limitations in the sensing, feature extraction, or matching technologies as well as the limited discriminability of the specific biometric trait. In adversary attacks, a resourceful hacker (or possibly an organized group) attempts to circumvent the biometric system for personal gains. The adversary attacks may be classified into three types based on factors that enable an adversary to compromise the system security. These factors include system administration, non-secure infrastructure, and biometric overttness.

[00019] Intrinsic failure is the security lapse due to an incorrect decision made by the biometric system. A biometric verification system can make two types of errors in decision making, namely, false accept and false reject. A genuine (legitimate) user may be falsely rejected by the biometric system due to the large differences in the user's stored template and query

biometric feature sets. These intra-user variations may be due to incorrect interaction by the user with the biometric system (e.g., changes in pose and expression in a face image) or due to the noise introduced at the sensor (e.g., residual prints left on a fingerprint sensor). False accepts are usually caused by lack of individuality or uniqueness in the biometric trait which can lead to

5 large similarity between feature sets of different users (e.g., similarity in the face images of twins or siblings). Both intrauser variations and interuser similarity may also be caused by the use of nonsalient features and nonrobust matchers. Sometimes, a sensor may fail to acquire the biometric trait of a user due to limits of the sensing technology or adverse environmental conditions. For example, a fingerprint sensor may not be able to capture a good quality

10 fingerprint of dry/wet fingers. This leads to failure-to-enroll (FTE) or failure-to-acquire (FTA) errors. Intrinsic failures can occur even when there is no explicit effort by an adversary to circumvent the system. So this type of failure is also known as zero-effort attack. It poses a serious threat if the false accept and false reject probabilities are high. Ongoing research is directed at reducing the probability of intrinsic failure, mainly through the design of new sensors

15 that can acquire the biometric traits of an individual in a more reliable, convenient, and secure manner, the development of invariant representation schemes and robust and efficient matching algorithms, and use of multi-biometric systems

**[00020]** The apparatuses and methods described herein may allow one to build a measuring systems that can reduce or eliminate the risk of incorrect decisions being made by the biometric system by synthesizing a large variety (e.g., large array) of biometric data (e.g., specifying which, why and how) provided by the apparatus/garment acting as a biometric system and/or communications platform.

**[00021]** The methods and apparatuses described herein may provide biometric security that may possess the following four properties. Diversity: the secure template must not allow cross-matching across databases, thereby ensuring the user's privacy. Revocability: it should be

25 straightforward to revoke a compromised template and reissue a new one based on the same biometric data. Security: it must be computationally hard to obtain the original biometric template from the secure template. This property prevents an adversary from creating a physical spoof of the biometric trait from a stolen template. Performance: the biometric template

30 protection scheme should not degrade the recognition performance (FAR and FRR) of the biometric system.

**[00022]** Typically, biometric recognition is probabilistic; it is not an absolutely accurate and certain identification technology and, according to critics, this is one of the technology's key limitations. In other words, biometric systems will always only provide a probability of

35 verification. There have been moves to manage the probabilistic nature of biometric matching

and the challenges that this represents, for example by introducing ‘multi-modal biometrics’ such that the uniqueness of a match (i.e. the likelihood of making a correct match) increases with the number of biometrics that are combined (i.e. whilst it is likely that someone might have a fingerprint pattern that matches yours, it is far less likely that someone will have both a fingerprint and an iris image which match yours). In other words: the fusion of multiple biometrics helps to minimize the system error rates.

**[00023]** However, the use of multi-modal biometric systems then entails a different set of limitations and challenges. First, multi-modal biometrics is more expensive as it requires more data to be collected and processed. Besides that, another challenge confronting the implementation of multi-modal biometric systems is that a crucial question still remains unresolved; namely the question of what are the best combinations (modalities). Moreover, multi-modal biometric systems are also challenging to implement because of the complexities involved in making decisions “about the processing architecture to be employed in designing the multi-modal biometric system as it depends upon the application and the choice of the source. Processing is generally complex in terms of memory and or computations.” Besides that, there are also still a number of unresolved issues about the scalability of multi-modal biometric systems. Finally, increasing the amount of biometrics being collected from an individual might increase the performance of the system but might also, at the same time, increase the risk of data theft or misuse of individual information.

**[00024]** Biometrics can be defined as “any automatically measurable, robust and distinctive physical characteristic or personal trait that can be used to identify an individual or verify the claimed identity of an individual.” Contemporary biometric technologies may entail the digitalization of the unique body part, a process that has implications for the knowledge produced from the processing of this digitalized biometric data and hence for the body subjected to this technology, in particular given the possible political use of such biometrically-derived knowledge.

**[00025]** Described herein are systems that through a wearable apparatus (e.g., a wearable computing & communicating device that covers a significant part of the user’s body, e.g., one or more of: torso, arms, legs; and may also include one or more of: head, hands, feet, etc.) accurately measures a plurality of biometrical data (using the same or multiple modalities) to generate an accurate identification of a person, in a private (no third party intrusion), automatic (directly executed by the computing and communication module thus sidestepping user intervention that could generate errors), simple (identification is activated by a single input such as a voice command, a touch on the garment, such as a touch point, a smart screen touch, etc.), fast (synthesis can be produced in just a few seconds), repeatable (it can be generated as many

times as needed), low cost (e.g., virtually no execution cost to the owner of apparatus) and controlled manner (the user is in control and needs no external support). The apparatus may generate its owner identity: a synthesis of traits and data that make her/him unmistakably who she/he is. Most importantly, the system allows the person to be the sole owner of the  
5 identification data produced. Present biometric-recognition systems require sharing data with a database owned by a third party (government, medical facility, financial institution, vendor, etc.) in order for the person to be identified. Being identified through biometrics today has a substantial cost to the data owners of data: they lose ownership of their data and possibility to generate an income with it. In today ever more digital economy, data is becoming exponentially  
10 more valuable: the value is today collected by large corporations rather than by their natural/legitimate owners, partly a cause of today vast economic divide. Securing ownership of personal data could be a mean to close the divide gap by allowing owners to monetize their ever more valuable data.

**[00026]** The biometric identification apparatuses described herein may be: universal, i.e., each  
15 individual possesses this characteristic; easily measured, i.e., it is quite easy technically and convenient for an individual to obtain the characteristic; unique, i.e., there are no two individuals with identical characteristics; and permanent, i.e., the characteristic does not change over time. However, the methods and apparatuses described herein may be particularly well adapted to characteristics that change over long time periods (e.g., are not permanent, but evolving as the  
20 individual grows and ages).

**[00027]** Ideally the characteristic should be universally present, unique to the individual, stable over time and easily measurable. No biometric characteristics have been formally proven to be unique, although they are usually sufficiently distinct for practical uses. Different biometrics will be more suitable for different applications depending, for example, on whether  
25 the aim is to identify someone with their co-operation or from a distance without their knowledge.

**[00028]** For example, described herein are methods of confirming a user's identity using a garment including a variety of sensors. For example, the method may include: wearing a garment comprising a plurality of integrated sensors at predetermined locations; synchronously  
30 recording sensor data from multiple predetermined locations on the garment; generating, in the garment, a biometric profile from the recorded sensor data; transmitting the biometric profile to a lodger in or on the garment; and confirming the user's identity using the biometric profile.

**[00029]** Confirming may be done in the garment, or in a processor separate from the garment. In particular, confirming may comprise comparing the biometric profile to a user biometric  
35 profile using a processor in the garment. For example, confirming may comprise comparing, in

the garment, the biometric profile to a user biometric profile recorded from the user within a predetermined (e.g., recent, such as within the last year, within the last six months, within the last three months, within the last six weeks, within the last four weeks, within the last three weeks, within the last two weeks, etc.) time period. If the confirming step is done separately  
5 from the garment, the biometric profile may be encrypted prior to transmitting from the garment.

**[00030]** A method of confirming a user's identity may include: wearing a garment comprising a plurality of integrated sensors at predetermined locations in the garment that are configured to position the integrated sensors over the user's torso; synchronously recording sensor data from multiple predetermined locations on the garment, using a plurality of  
10 different sensor types; generating, in the garment, a biometric profile from the recorded sensor data; and confirming the user's identity using the biometric profile.

**[00031]** A method of confirming a user's identity may include: wearing a garment comprising a plurality of integrated sensors at predetermined locations; synchronously recording sensor data from multiple predetermined locations on the garment; generating, in the garment, a biometric  
15 profile from the recorded sensor data; transmitting the biometric profile to a lodger in or on the garment; and transmitting the biometric profile to a third party to verify the user's identity. The third party may verify the user's identity by having a biometric template against which the biometric profile is tested or compared.

**[00032]** Generating a biometric profile from the recorded sensor data may comprise  
20 generating the biometric profile in a master and/or scheduler on the garment. The master and/or scheduler may include a processor.

**[00033]** Wearing may include adjusting the position of the sensors based on haptic feedback from the garment. For example, the garment may include one or more haptics that will vibrate or otherwise indicate that a nearby sensor in the garment is not properly positioned on the user's  
25 body.

**[00034]** Synchronously recording sensor data may comprise synchronously recording sensor data from a plurality of motion sensors. The sensors may be of different types (e.g., different modes, such as respiration sensors, cardiac sensors, galvanic skin sensors, EMG sensors, EEG sensors, etc.). Synchronously recording sensor data may comprise synchronously recording  
30 sensor data from a plurality of motion sensors, one or more respiration sensors and one or more electrodes configured to contact the user's skin when the garment is worn. Wearing the garment may comprise wearing the garment over the user's torso (e.g., the garment may be a shirt, or may include a shirt). Synchronously recording may include synchronously recording sensor data from multiple sensor types on the garment. For example, the scheduler and/or master may coordinate  
35 the recording of sensor (slave) data; each sensor or sub-sets of sensors may record at different

frequencies based on the type of sensor it is. Thus, synchronously recording sensor data may comprise recording data at a plurality of frequencies.

[00035] Any of these methods may also include encrypting the biometric profile prior to transmitting the biometric profile to the third party. Thus, in general, the biometric profile is  
5 determined using the master and/or scheduler, which may also encrypt the biometric profile.

[00036] Since the user may wear the apparatus (garment with sensors) continuously for a long period of time, the biometric profile may be determined on an ongoing basis (e.g., a running window) and/or upon demand (e.g., upon a request for identity verification).

[00037] Any of the methods and apparatuses described herein may also include encrypting  
10 and transmitting the biometric template that can be used by a third party to compare with the biometric profile. For example, the garments described herein may generate a biometric template upon some triggering event (e.g., wearing the garment for a predetermined time) or upon request from a third party.

[00038] The substance of the biometric template and/or biometric profile, including the type  
15 of data (sensor type, etc.) may be determined, for example, based on the ability of that type of data to distinguish identity of the individual wearing the garment. For example, the biometric template may be constructed from accelerometer data (including from one of the axes of motion of the accelerometer, such as one axis of motion of the accelerometer) and/or recorded electrical activity (e.g., cardiac data, EMG data, galvanic skin response data, etc.) and/or respiration data.

[00039] Any of these methods may also include sending a coded message requesting approval  
20 of the wearer to proceed from the third party. An approval message may be transmitted to the user in a coded (e.g., in a Morse-like tactile code), and a response code may be transmitted by responding to specific location on the garment (e.g., tactile output) and/or to a touchscreen in communication with the device. Thus, contacting an output on the garment may be used to  
25 indicate agreement to the third party.

[00040] A method of confirming a user's identity may include: wearing a garment comprising  
a plurality of integrated sensors at predetermined locations in the garment that are configured to position the integrated sensors over the user's torso; adjusting the position of the sensors using haptic feedback from the garment; synchronously recording sensor data from multiple  
30 predetermined locations on the garment, using a plurality of different sensor types; generating, in the garment, a biometric profile from the recorded sensor data; confirming the user's identity by comparing, in the garment, the biometric profile to a historical biometric profile recorded from the user within a predetermined time period; and transmitting confirmation of the user's identity a third party.

[00041] A method of confirming a user's identity may include: wearing a garment comprising a plurality of integrated sensors at predetermined locations in the garment that are configured to position the integrated sensors over the user's torso; synchronously recording sensor data from multiple predetermined locations on the garment, using a plurality of different sensor types; 5 generating, in the garment, a biometric profile from the recorded sensor data; and transmitting the biometric profile to a third party to confirm the user's identity.

[00042] A method of confirming a user's identity may include: wearing a garment comprising a plurality of integrated sensors at predetermined locations in the garment that are configured to position the integrated sensors over the user's torso; adjusting the position of the sensors using 10 haptic feedback from the garment; synchronously recording sensor data from multiple predetermined locations on the garment, using a plurality of different sensor types; generating, in the garment, a biometric profile from the recorded sensor data; encrypting the biometric profile; and transmitting the encrypted biometric profile to a third party to confirm the user's identity.

[00043] In any of the methods described herein, biometric templates may not be used by the 15 third party, but instead the wearable apparatus may be the guarantor of the user's (wearer's) identity. In some variations, this may mean that the verification process to the third party is a two (or more) step process, in which the third party verifies that a wearable garment is the garment associated with the account (e.g., a bank account, etc.) and then additionally confirms that the user wearing the garment is the correct user. Further, the third party (e.g., bank, etc.) 20 may request a confirmation response from the user wearing the garment to confirm a transaction, which may be transmitted to the user via one or more haptics on the garment; the response may be encoded through the garment (e.g., through one or more touchpoints, or other inputs, including a touchscreen, associated with the garment). Thus, in any of the apparatuses (e.g., wearable devices) and methods described herein, the garment can be seen as providing the 25 authority to authenticate user's identity. While other systems may send a profile to a requesting third party (e.g., bank) and the third party authorizes the transaction (e.g., payment) based on the profile received, described herein are methods in which the device authorizes the third party to execute the transaction based on identifying the owner. Thus, for extra security, the third party may request additional confirmation by soliciting a message from the user (whose identity has 30 been confirmed or is being confirmed) by communicating through protected haptic actuation/actuators in different parts of the apparatus.

[00044] Any of the methods and apparatuses described herein may be configured so that the user's identity must be produced within a certain time period of an inquiry from the garment or a third party. For example, it cannot be generated from a template or from the memory of the

device, or from an algorithm in a blockchain. Further, the user must be alive for the verification to be made.

[00045] As mentioned, for extra-security (e.g., the transfer of large sums of money, purchasing real estate, etc.), the user's identity can be compared to a recent biometric template, taken within a predetermined maximum time period (e.g., no longer than one year, no longer than within six months, no longer than within three months, no longer than within one month, no longer than within six weeks, no longer than within four weeks, no longer than within 3 weeks, not longer than within two weeks, no longer than within one week, etc.) protected in a blockchain.

10

### BRIEF DESCRIPTION OF THE DRAWINGS

[00046] The novel features of the invention are set forth with particularity in the claims that follow. A better understanding of the features and advantages of the present invention will be obtained by reference to the following detailed description that sets forth illustrative embodiments, in which the principles of the invention are utilized, and the accompanying drawings of which:

[00047] FIG. 1 is a schematic illustrating one example of a method of using a garment having a plurality of sensors to generate a unique biometric code (e.g., profile, e.g., token or template).

[00048] FIG. 2 is an example of an apparatus (e.g., system) comprising a garment for measuring a biometric profile, configured for medical monitoring.

[00049] FIGS. 3A-3C illustrate another example of a garment for determining a biometric profile, configured as a performance/fitness garment.

[00050] FIGS. 4A-4B illustrate another example of a garment for determining a biometric profile.

[00051] FIG. 5 is an example of a schematic for a general apparatus (e.g., system) for determining biometric profile information.

[00052] FIG. 6 is an example of a garment 600 including IMU units integrating a 3D-accelerometer, a 3D-gyroscope and a 3D-magnetometer, ECG sensors, breathing sensors, skin-conductance and temperature sensors. This garment may be further configured to determine a biometric profile based on this sensor information.

[00053] FIGS. 7A-7C illustrate data from a prototypes (such as the one shown in FIG. 6) used for characterizing the behavior of a user can be identified whether by a semi-supervised approach or in a completely unsupervised way.

[00054] FIGS. 8A-8C illustrate the results of a Support Vector Data Description (SVDD) approach, that relies on the construction of a multidimensional domain around typical data points

35

of the target user to identify biometric data upon which to base (at least in part) a biometric profile.

[00055] FIGS. 9A-9C are similar to FIGS. 8A-8C, but illustrate a method of approach using the ‘worst’ feature.

5 [00056] FIGS. 10A-10F illustrate detection confidence for three users in a sparse dataset.

[00057] FIGS. 11A-11F illustrate detection confidence for three users in a sparse dataset in an alternative embodiment.

[00058] FIG. 12 is a generic biometric data system as described herein.

10

### DETAILED DESCRIPTION

[00059] Described herein are biometric identification methods and apparatuses (including devices and systems) for uniquely identifying one an individual based on a garment including one (or more preferably a plurality) of sensors, including but not limited to sensors having multiple sensing modalities (e.g., movement, respiratory movements, heart rate, ECG, EEG, etc.).

15

[00060] FIG. 1A illustrates an exemplary sequence of operations to produce the identity synthesis. This sequence may be part of a method (or in an apparatus as software, hardware and/or firmware configured to control the apparatus to generate a biometric profile that may uniquely identify a user with a very high degree of certitude.

20

[00061] In the first step 101, the user (also referred to as a subject or wearer) may wear the device. In general, the device may be a garment including a plurality of SMSes that each receive and/or record, and/or process sensor data from one or more sensors. For example, the apparatus may be a garment such as the garments described in one or more of U.S. patent application no.

25

14/023,830, titled “WEARABLE COMMUNICATION PLATFORM” (Now U.S. patent no. 9,282,893); U.S. patent application no. 14/331,142, titled “COMPRESSION GARMETS HAVING STRETCHABLE AND CONDUCTIVE INK” (Now U.S. patent no. 8,948,839); U.S.

patent application no. 14/612,060, titled “GARMENTS HAVING STRETCHABLE AND CONDUCTIVE INK” (US-2015-0143601-A1); U.S. patent application no. 14/331,185, titled

30

“METHODS OF MAKING GARMENTS HAVING STRETCHABLE AND CONDUCTIVE INK” (Now U.S. patent no. 8,945,328; U.S. patent application no. 15/324,152, titled

“GARMENTS HAVING STRETCHABLE AND CONDUCTIVE INK ”; U.S. patent

application no. 15/202,833, titled “SYSTEMS AND METHODS TO AUTOMATICALLY DETERMINE GARMENT FIT” (US-2016-0314576-A1); U.S. patent application no.

35

14/644,180, titled “PHYSIOLOGICAL MONITORING GARMENTS” (US-2015-0250420-A1);

U.S. patent application no. 15/516,138, titled "DEVICES AND METHODS FOR USE WITH PHYSIOLOGICAL MONITORING GARMENTS "; and U.S. patent application no. 15/335,403, titled "CALIBRATION PACKAGING APPARATUSES FOR PHYSIOLOGICAL MONITORING GARMENTS," each of which is herein incorporated by reference in its entirety.

5 [00062] These apparatuses (e.g., garments) may include a tutorial application to ensure that the device is properly worn and a) all the sensors are properly functioning and/or correctly positioned. Alternatively or in addition, when wearing the garment, the processor (e.g., computer) communicating with or integrated into the apparatus may detect that a sensor is not working and may indicate it on the smartscreen (e.g., touchscreen), and/or by haptic feedback  
10 near the sensor 103. For example, a message indicating that the sensor needs to be positioned or worn correctly/adjusted may appear on the smart phone or computer's screen in communication with or integrated into the garment.

[00063] In general, sensors integrated into the garment(s) may be properly positioned in the right place. For example: IMU need to be positioned in the middle of the segment (shoulder to  
15 elbow, elbow to wrist), on the back of the hand between wrist and knuckles.

[00064] Once worn and adjusted, the device may be worn for a few minutes or longer so that sensors adapt to body temperature.

[00065] The apparatus may then activate the production of synthesis of biometric data from the plurality of sensors (e.g., from the plurality of SMSes). For example, the apparatus may be  
20 activated automatically or manually, e.g., through a touch point (touching a microchip on the sleeve for example), through voice command, a sensorial command or other type of command. Thereafter, the apparatus may produce a biometric representation (e.g., profile, such as a token or template) of the wearer's physiological data 107. This is described in greater detail below, and generally includes collecting sensor data, e.g., from coordinated SMSes on/in the garment and  
25 analyzing the data in an ongoing or discrete manner to evaluate one or more characteristics ("prototypes") specific to each sensor (per characteristic sensor type and location). The biometric representation may be perfected through machine learning. Thus, the more the owner uses the device, the more precise the identity synthesis algorithm becomes.

[00066] The method and biometric representation can also be made more accurate by using  
30 more than one garment or a garment covering more than one region. For example, the garment may be a garment configured to collect medical diagnostic information. The wearer may wear the garment that covers the body from the tip of the toes (leggings incorporating socks) to the top of the head/balaclava see, e.g., FIG. 2.

[00067] The apparatus in FIG. 2 is an exemplary system that includes a bodysuit/garment 1 a  
35 headpiece 2, an optional pulse oximeter sub-subsystem 3, a controller (e.g., phone module) 4, an

optional battery pack 5, a touchscreen display 6, a remote server (e.g., cloud) 7, and automatic analysis software 8, which may execute on the remote server and/or on the controller. This apparatus can provide many hours of a very large array of physiological data recording through a long period of time (from a few hours to 100 hours plus with auxiliary batteries). This exemplary apparatus may be used from 12 to 48 hours (e.g., while sleeping and in daily activity) once a week or once a month.

[00068] The system shown in FIG. 2 may monitor, for example, respiratory mechanics, PSG, e.g., thoracic and abdominal movements, sleep patterns, oxygen saturation (including the time course of oxygen saturation in different body regions under different activity conditions), ECG measurements (e.g., via an integrated Holter 12 lead ECG sensors). Any of these garments may also include a plurality of movement sensors, such as accelerometers at predetermined positions on the body, secured in reproducible relation to the body by the garment.

[00069] Other garments covering more or less of the body may be used. For example, a garment configured as an efficiency device that may monitor and provide feedback to the owner during daily life to improve health by, for example, analyzing activities and improving habits, may also be used. This apparatus may be, for example, an upper-body device with short or long sleeves very comfortable to be worn during daily life and may optionally include a visor or glasses to monitor EEG, EOG, EMG facial signals, body temperature, and one or more IMUs to monitor head movements, etc. See, e.g., FIGS. 3A-3C. FIG. 3A shows another variation of a wearable sensing garment having a plurality of sensors 309 on the front 301 and back 303 of the garment. The garment may be worn with a touchscreen 305 at or near the wrist/forearm of the wearer. A collar unit 307 may include a speaker and one or more microphones (e.g., for voice recognition, etc.). The variation shown in FIG. 3A is a short-sleeved garment. A similar long-sleeved variation is shown in FIG. 3B. Additional (and optional) accessory such as headband/neckband 315, smartphone 317 and battery pack 319 are shown in FIG. 3C. The sensors shown may include electrodes for measuring galvanic skin responses, movement (e.g., 9 or more IMUs), electrodes for measuring electrocardiograms (ECGs), electrodes for measuring EMGs, and ground electrode(s).

[00070] Other garments may also include an apparatus configured as a performance device that supports the owner during regular or intensive fitness activities or professional sports. See, e.g., FIGS. 4A (front 301) and 4B (back 303) of an exemplary garment. In this example, the garment also includes a plurality of sensors 409 (e.g., galvanic skin responses, movement (e.g., 9 or more IMUs), electrodes for measuring electrocardiograms (ECGs), electrodes for measuring EMGs, and ground electrodes, etc.). The garment may also include a collar 405, 405' and

speakers (shown as earpieces 411). The optional components shown in FIG. 3C may also be used with the garment of FIG. 4A-4B.

[00071] By wearing any of these garments for a period of time (e.g., 1 day, 1 week, 2 or more weeks, 1 month, or more months, etc.) for short period of time (e.g., with the medical device garment of FIG. 2, e.g., once a week, with the garment of FIG. 3A-3C, every day for a few hours, with the performance/fitness garment, 2 to 3 times a week), the apparatus may develop a knowledge of the heart at a medical diagnostic ECG level even when using the apparatus despite the fact that it only has, e.g., 2 sensors rather than the 12 derivations.

[00072] Physiological data captured by the many sensors may be processed in multiple locations throughout the body. For example, the sensors (e.g., IMUs or EMGs) may be positioned in proximity of an SMS (e.g., microchip) that process the data. The physiological data may be jointly processed into the Sensor Management System (SMS). Thus, the data may be synchronously processed at multiple locations in the garment 105; the different processors may be synchronized and the data accurately time stamped (e.g., to within +/- 1 ms, 0.1 ms, 0.001 ms, etc.). The synchronized data are processed/calculated with minimal latency, and may be recombined and/or further processed. SMS software and/or firmware can calculate data at different Hertz velocities depending on the type of physiological data. For example IMU may be measured at 500Hertz, heart rate at the same or at a different frequency (e.g., 100 Hz or less), respiration at the same or at a different frequency (e.g., 10 Hz), EEG at the same or at a different frequency (e.g., 200 Hz), EOG at the same or at a different frequency (e.g., 300 Hz), EMG at the same or at a different frequency, Skin conductance at the same or at a different frequency, body temperature at the same or at a different frequency, etc.

[00073] In general, any of the methods and apparatuses described herein may include tactile feedback, via one or more haptic actuators (e.g., piezoelectric actuators, etc.). For example, the devices may be equipped with haptic actuators to provide touch feedback at or near the sensor(s). Haptic feedback may be provided when confirming that the sensor(s) are correctly positioned. Haptic actuators may provide a tactile feedback to the user to indicate that the synthesis has been performed by the SMS. The synthesis may include the formation of a biometric profile that is synthesized from a plurality of different sensors or combination of sensors in/on the garment. Once synthesized, the biometric profile may be encrypted. For example, the synthesis of the biometric profile may be an encrypted 532 to 1064 characters in SMS.

[00074] The synthesized biometric profile may then be sent by a lodger 109 (a telecommunications module, such as a cell phone or wireless-enabled unit that may be located in or on the garment, e.g., on the upper-back between the shoulder blades in a torso garment such as a shirt). The biometric profile may be sent to an interested party 111 that may verify the

biometric profile and then send a coded message requesting approval of the wearer to proceed, assuming that the biometrics match 113. The request for approval may be displayed on the garment, including on a display integrated into or in communication with the garment. Approval may be provided by a touchpoint in/on the garment and/or a touchscreen. For example, in case  
5 of a bank access, before approval of a payment, the biometric information may be transmitted from the garment (lodger) to the bank, acting as the third party. Assuming that the bank has a reference biometric template to compare to (which is also encoded), the bank may verify the biometric information from the garment and may then request additional verification. Additional (optional) security may then be provided; for example, the coded message may be delivered on  
10 the garment by haptic actuators in a Morse-type code chosen by the user. The user may then send approval to the bank. In some variations, the synthesis can be stored in a blockchain.

**[00075]** In general, the garments described herein may include a sensor network (e.g., a network of sensor elements, including a master, a scheduler, and one or more slaves (sensors). The slave(s) may be the last element(s) of the sensor network, and may typically be placed  
15 directly on the garment. More than one slave sensor can be attached to the sensor network. As mentioned, the garment may support more than one sensor. The slaves/sensors may be responsible to: directly acquire data from sensors, execute signal processing, execute algorithms, derive virtual sensor data from hardware sensors (e.g., Quaternions), etc.

**[00076]** Different sensor types supported. For example, slave breath sensors (e.g., "Type  
20 ECG-BREATH") may be configured to acquire data from a 12-lead ECG and breathing sensors. Slave motion sensors (e.g., "Type IMU-EMG") may be configured to acquire data from an IMU (e.g., Accelerometer, Gyroscope, Magnetometer, Quaternions) and/or EMG sensors.

**[00077]** A scheduler may be placed inside of a control device or directly on/in a garment. The scheduler may generally manage the sensor network of the garment, and may organize slaves to  
25 execute synchronous sampling. The scheduler may control and synchronize the clocks in the individual regions of the garment (and may include a master clock, and may coordinate the sample frequencies and/or synchronize the sensors). The scheduler may also encrypt data provided to the master, and/or provide the access of the sensor network to the master. The scheduler may include circuitry (e.g., clock, processor, memory, etc.).

**[00078]** A master may also be included in the control device, and may be configured to  
30 manage the sensor network (e.g., through the scheduler). The master may obtain data from the sensor network (e.g., encrypted by the scheduler), and may execute control logic (e.g. processes) and/or may directly acquire data from the sensors, store data, exchange data with a remote server (e.g., the cloud, for example, through WiFi/mobile network), exchange data with an external user

device (e.g., through WiFi/Bluetooth), and/or exchange data with an external third party medical devices (e.g., through Bluetooth).

[00079] FIG. 5 is a schematic overview of an apparatus (configured as a system in this example) as described. In FIG. 5, the master 501 communicates directly with the scheduler 503, while the scheduler communicates with the plurality of sensors (slave 505, 505', 505'', 505''', etc.) in the garment through a bus 507.

[00080] In some variations, the biometric apparatuses described herein are wearable devices that cover the major part of the body to maximize the number of sensors located around the body; in general, the higher the number of sensor the higher the medical accuracy of the data. This may also help to ensure that sensors are located in the best possible part of the body for maximum precision. A sensor located around the heart may be more precise than a sensor on the wrist (like in wearable bracelets and watches). The device may be comfortable (e.g., preventing data noise distortions introduced by constriction/lack of comfort), and can be used during daily life (generating more relevant data and habits far from the anxieties and risks of hospitals and medical laboratories) for long period of time. Longer measurement times may enhance the chance to discover pathologies or abnormalities in garments configured for medical use, and may also provide greater accuracy for the data through machine learning.

[00081] The apparatuses described herein may not need a password to authenticate an individual, which may substantially increase the ease of use. Passwords may get misplaced or are forgotten. The biometric technologies linked to the particular individual such as those described herein may provide greater security, speed, and ease of use than traditional methods like passwords, PIN's, or "smart" cards. Biometric login can also save time and reduce costs.

[00082] Rather than simply generate physiological data to compare to previously stored physiological data bases, the methods and apparatuses described herein may determine reliable biometric templates from sensors in/or a garment, these biometric templates may be generalizable between different garments. This may reduce the risk of the user's physiological data being held in possession of a third party (e.g., such as the US government as currently done for fingerprints and retinal scans). The systems, devices and methods described herein may help ensure that the persons generating the physiological data remains the sole owner of their data and does not need to divulge their data in order to be identified or in order to use their data to make transactions or to monetize it.

[00083] Thus, in general, the validation server does not store sensitive user data such as personally identifiable information (PII). A user's unique biometric signature may remain within trusted execution and may not ever be transmitted over the web. Raw biometric data may never be sent through the network or stored in a central database.

[00084] The systems described herein may replace and compete with existing tokens. These systems are typically a synthesis of users' physiological data. The methods and apparatuses described do not reveal the owner's physiological data, but merely provide extracted and/or calibrated information that may be further processed.

5 [00085] Advantageously, the use of multiple, synchronized sensors as described herein may allow for rapid and robust sensing. For example, the apparatuses described herein may generate an accurate biometric profile within under about 10 seconds. Typically these systems may only works with the owner of the system. Once the system is worn for more than a few times (e.g., more than 5 times, more than 6 time, more than 7 times, more than 8 times, more than 9 times,  
10 more than 10 times, etc.) it may recognizes its owner and may be configured to only works when it is worn by the owner.

[00086] As mentioned, any combination of different physiological data types may be used. for example, at least 3 types of physiological data (e.g., at least four types, at least five times, at least six types, etc.) may be used to generate an accurate synthesis of the biometric profile. For  
15 example, heart, respiration, movement, and rest (EEG, EOG, EMG, temperature, skin conductance, etc.), or any component part of these. For example, an accelerometer may include three different axes (x, y, z), which may be analyzed separately or together.

[00087] In any of these variations, SMS information may be encrypted so that data is protected before being sent. The data may be encrypted before being passed into the phone  
20 module to guarantee safety. Once a transaction is automatically approved by a third party device after comparing the biometric template based on a wearable garment with sensors stored by the third party with a biometric profile based on a wearable garment with sensors, a message may be sent to the wearable garment's haptic system of the wearer/owner of physiological data. The haptic communication may be a 'pass-haptic signals' in a Morse-type code rather than a  
25 'password' and thus it can be reset.

[00088] The signal may be performed by two different haptic actuators placed in two different parts of the body, which may oblige the owner to wear the device properly.

[00089] The data may be saved in a physiological data platform (e.g., in the cloud or in a secure remote server. The authentication may be given by the physiological data platform after  
30 matching the data. A biometric encryption may help ensure that a user's credentials are decentralized and stored offline. A cryptographic digital key may be generated from a biometric such as a fingerprint or voice and used to sign transactions initiated by a relying party. Raw biometric data may not be sent through the network or stored in a central database.

[00090] Thus, the authentication solutions described herein may provide biometric encryption  
35 without requiring an authentication channel relying on a centralized storage of biometrics. End-

users may be able to choose which biometric authenticators they will utilize. Biometric data may remain encrypted and protected against malware on a user's device. Relying parties set policies for which biometric authenticators can be used. A UAF Server may provide the server side of UAF protocols; HYPR makes it easy to deploy any FIDO server on-premises or as a cloud solution.

**[00091]** Using public key cryptography, it is possible to prove possession of a private key without revealing that key. The authentication server may encrypt a challenge (typically a random number, or at least data with some random parts) with a public key; the device described herein may allow the apparatus to prove it possesses a copy of the matching private key by providing the decrypted challenge.

**[00092]** The identification systems described herein may use a classical scheme including data acquisition, data preprocessing, formation of input feature space, transition to reduced feature space, and sensor information classification. The generic system structure (FIG. 12, left) shows the sequence of essential data processing stages. Feed forward links show processed data transfer between stages. The output of one stage is the input to the subsequent stage. Each stage can be implemented using different processing methods. The detailed system structure (FIG. 12, right) shows methods considered in this study for each system stage. For most stages, these methods are alternatives, but the data preprocessing stage is usually comprised of several complementary methods.

## 20 EXAMPLES

**[00093]** Previously described biometric authentication has typically been based on data derived from direct measurements of a part of the human body, like the DNA, fingerprint, retina, iris, face, ear, palm, the veins' pattern in the hand or in the wrist, etc. The heart activity has also been used for the person authentication, whether by capturing the electrical activity (ECG) or the sound produced by it (PCG). Photoplethysmography (PPG) has also been used for authentication. Vein patterns have also been used. In addition, it is also possible to perform biometric authentication based on behavioral characteristics of the user, which may be linked/coordinated by these physiological responses. For instance, gait, the way the user walks, signature and voice recognition, keystroke-based or by capturing the response of the user (e.g., EEG) to a given stimulus.

**[00094]** Typically, the raw signals captured from direct measurements of the user to be authenticated are characterized and authentication may be based on a comparison between the features of those measurements and the features of the signals measured on the candidate person. For instance, fingerprint authentication may be based on three basic patterns of fingerprint

ridges: arches, loops, and whorls. The features or data points defining the authenticated user can define a region or a set of regions in a high-dimensional space. In this case, the procedure of authentication consists on computing if the candidate data lies inside those regions.

5 [00095] Described herein are garments that may provide sufficient biometric information (on both voluntary and involuntary responses) to accurately and reliably be used as biometric identifying data; these garments may further be configured to securely determine from the biometric information a synthesis of biometric profile that may be used to verify identity of an individual wearing the garment.

10 [00096] FIG. 6 is an example of a garment 600 including IMU units integrating a 3D-accelerometer, a 3D-gyroscope and a 3D-magnetometer, ECG sensors, breathing sensors, skin-conductance and temperature sensors. The garment in FIG. 6 illustrates one possible positioning of these sensors.

[00097] In a proof of concept test, multiple IMU units present in the sample garment of FIG. 6 were examined for authentication. In particular, we used the accelerometer. In initial test, the 15 accelerometer data was more reliable than the gyroscope data and the magnetometer was somewhat susceptible to interferences from the environment and dependent on the orientation of the user. In practice, any or all of these sensors may be used. For example, the heart rate signal was, in preliminary data, somewhat noisy; however, the possibility remains for using the breath pattern and the exploitation of multiple modalities.

20 [00098] Initial tests identified sets of signal patterns that are uniquely present in a given individual. The resulting authentication system would be of a behavioral type, given that those signals are generated, for instance while the user is walking and working.

[00099] In a first approach, we exhaustively extracted all 1-second time-series of each axis of the available sensors (i.e., 5 sensors x 3 axes of acceleration, thus 15 axes). We then proceeded to 25 group those time-series such that for many similar time-series patterns, we chose one single prototype (e.g., by means of a time-series clustering technique such as K-medoids). The user's behavior is thus characterized by a set of prototypes for each sensor axis (in our experiments, 15 sensor axes x 50 time-series prototypes). Those 750 prototypes may be different for every user, or that at least, we can base the authentication of a user on the distance between the measured 30 time-series patterns of the candidate user and the prototype time-series characterizing the authenticated user. Thus, the candidate user may be recognized as the authenticated user, if the aforementioned distance is below a certain threshold. The set of prototypes used for characterizing the behavior of a user can be identified whether by a semi-supervised approach or in a completely unsupervised way. Results of this approach are summarized in FIGS. 7A-7C.

[000100] In a second approach, we analyzed if a user's way of behaving had a particular pattern in the frequency domain, captured by the IMU's accelerometers. We considered for this purpose all of the available accelerometers in all of the walking datasets. We then computed the power spectrum of the signal for each accelerometer in each of the 3 axes and kept the median  
5 signal over periods of 1 minute. We chose a resolution of 0.25 Hz in the frequency domain ranging from 0 to 20 Hz. These median spectra were used to construct a baseline (or prototype) for each specific user. We considered for this purpose a method called Support Vector Data Description (SVDD). This method relies on the construction of a multidimensional domain around typical data points of the target user. The domain is created using a recorded dataset and  
10 can then be used to classify new measurements as belonging to the target user or not. Data points falling within the boundaries of the domain are considered as belonging to the user and points falling outside are considered outliers. Therefore, by counting the proportion of points that fall in the domain with respect to the total number of measurements, we can estimate quantitatively the likelihood of the garment being worn by a specific user. Results are presented in FIGS. 8A-8C  
15 and 9A-9C.

[000101] A first approach was to look at time-series clustering. The three plots in FIGS. 7A-7C show the distances between the prototypes of three of the users and the rest of users. For the sake of exemplification consider FIG. 7A. This plot shows the resulting distances when the sequences coming from user COCO wearing the garment 108 were used for building the  
20 codebook of prototypes. Hence, the blue curve represents the distances between the prototypes of user COCO-108 and the sequences from the same user. Points before time=0 correspond to training observations. The rest of the curves are the distances between the prototypes of user COCO-108 and the sequences coming from other users (see the labels in the plot). We can say that the first approach effectively discriminate users in this particular setup since the distances  
25 represented by the bottom 703 curve (authenticated user) are lower than the distances represented by the other curves (not authenticated users). The same analysis applies for the second and third row (user EDPI with garment 109 and user FRCA with garment 115).

[000102] Moreover, we have tested how the distances changed depending on which sensors are used. On the one hand, FIGS. 7A-7C show the resulting distances when all the sensors axis are  
30 used. In order to obtain a single value of distances, the distances of each axis are combined by using a weighted average in which each signal is modulated by the compactness of the clusters it generates.

[000103] FIGS. 8A-8C illustrate the use of a 'best' feature. In FIGS. 8A-8C, the resulting distance using the best axis (i.e., most compact clusters) are shown. FIGS. 9A-9C show the  
35 distance using the worst axis (i.e., most spread clusters). The results shown in FIGS. 7A-7C

(i.e., all the axis) indicate a better authentication of the user than the ones shown in FIGS. 8A-8C and 9A-9C. When using all the axis, the differences among users may be clearer making it easier to reject a user having higher distances in this particular example. Additional data may aid further distinguish this approach. FIGS. 9A-9C illustrate a method of approach using the 'worst' feature.

5 **[000104]** Also described herein are methods and apparatuses including the use of support vector data description. The Support Vector Data description (SVDD) deals with the problem of making a description of a training dataset with the aim of detecting which (new) data observations resemble this training set. This procedure is also known as one-class classification.

10 Data description can be used for outlier detection, that is, to detect uncharacteristic data values from a data set. In many one-class classification problems there is a major complication, namely that it is beforehand not clear what the specific distribution of the data will be in practice. With SVDD, we obtain a spherically shaped boundary around the training dataset. We used SVDD to obtain those boundaries in the frequency domain of the accelerometer data, and then computed a

15 confidence of being part of the training data. The plots below (FIGS. 10A-10F) show the confidence level (e.g., the bars) for different users using different garments. The highest bar corresponds to the training data, thus we expect that the second highest bar also corresponds to the same user, when wearing a different garment, which is the case for users MAMA, OSDA and RIRU.

20 **[000105]** FIGS. 10A-10F illustrate detection confidence for users MAMA, OSDA, and RIRU. The top ranking pair (user garment) corresponds always to the dataset that was used for training the model. We observed that the next high confidence results correspond to the same user.

**[000106]** FIGS. 11A-11F shows the detection confidence for users EDPI, FRCA, and CODO. The top ranking pair (user garment) corresponds always to the dataset that was used for training

25 the model. We observe that both datasets corresponding to user EDPI are subject to overfitting as the model is not able to recognize the user wearing a different garment. On the other hand, the model corresponding to user CODO seems to be subject to under-fitting as most of the other users display a high detection confidence as well. In general, FIGS. 11A-11F show detection confidence for users EDPI, FRCA, and CODO.

30 **[000107]** Interestingly, we observed that the quality of the results in terms of prediction accuracy for both the positive class (the target user) and the negative class (all other users) does not depend on the amount of sensor considered. Indeed, the difference in accuracy with respect to the results presented above stays in the ballpark of +/- 5% if we consider the signal of any individual sensor instead of all combined. Nevertheless, we suspect that this might not be the

35 case if we were to repeat this experiment on a larger set of users. In this case, the probability of

having similar signals among individuals would increase thus making the definition of unique user domains more difficult. With more sensors however, we are able to work in a higher dimensional space where overlaps are less likely and identification is therefore improved.

5 [000108] Although the examples described herein use Dynamic Time Warping instead of Euclidean Distance, in some variations it may be more appropriate given that out-of-phase time series can match prototype time-series characterizing the authenticated user. For the second approach, the use of wavelet transforms instead of FFT may add time dependency to the models and may be useful.

10 [000109] In general, further tests including other sensors and a combination of model predictions (e.g., by using a Bayesian approach). The use of a larger collection of data for more accurate models may also be used. Testing the robustness and accuracy (e.g., test if a user can imitate the behavior of another one) of the model. Other kind of features may be used to characterize the signals being used to authenticate the user. For instance, based on theoretical-information measures indicating disorder (entropy), complexity, fractal dimension and chaos  
15 dimension may be used.

[000110] As illustrated, it is possible to build user-specific models of behavior from the available data, which indicates that authentication is feasible based on behavioral biometric data. Authentication is possible among this reduced group of people using all the IMU sensors in the garment.

20 [000111] This proof-of-concept is based on approaches using only one modality (accelerometer). This approach may be extended to a larger group or users, using multiple modalities and combining multiple machine learning-based authentication algorithms working in parallel.

25 [000112] When a feature or element is herein referred to as being "on" another feature or element, it can be directly on the other feature or element or intervening features and/or elements may also be present. In contrast, when a feature or element is referred to as being "directly on" another feature or element, there are no intervening features or elements present. It will also be understood that, when a feature or element is referred to as being "connected", "attached" or "coupled" to another feature or element, it can be directly connected, attached or coupled to the  
30 other feature or element or intervening features or elements may be present. In contrast, when a feature or element is referred to as being "directly connected", "directly attached" or "directly coupled" to another feature or element, there are no intervening features or elements present. Although described or shown with respect to one embodiment, the features and elements so described or shown can apply to other embodiments. It will also be appreciated by those of skill

in the art that references to a structure or feature that is disposed "adjacent" another feature may have portions that overlap or underlie the adjacent feature.

[000113] Terminology used herein is for the purpose of describing particular embodiments only and is not intended to be limiting of the invention. For example, as used herein, the singular forms "a", "an" and "the" are intended to include the plural forms as well, unless the context clearly indicates otherwise. It will be further understood that the terms "comprises" and/or "comprising," when used in this specification, specify the presence of stated features, steps, operations, elements, and/or components, but do not preclude the presence or addition of one or more other features, steps, operations, elements, components, and/or groups thereof. As used herein, the term "and/or" includes any and all combinations of one or more of the associated listed items and may be abbreviated as "/".

[000114] Spatially relative terms, such as "under", "below", "lower", "over", "upper" and the like, may be used herein for ease of description to describe one element or feature's relationship to another element(s) or feature(s) as illustrated in the figures. It will be understood that the spatially relative terms are intended to encompass different orientations of the device in use or operation in addition to the orientation depicted in the figures. For example, if a device in the figures is inverted, elements described as "under" or "beneath" other elements or features would then be oriented "over" the other elements or features. Thus, the exemplary term "under" can encompass both an orientation of over and under. The device may be otherwise oriented (rotated 90 degrees or at other orientations) and the spatially relative descriptors used herein interpreted accordingly. Similarly, the terms "upwardly", "downwardly", "vertical", "horizontal" and the like are used herein for the purpose of explanation only unless specifically indicated otherwise.

[000115] Although the terms "first" and "second" may be used herein to describe various features/elements (including steps), these features/elements should not be limited by these terms, unless the context indicates otherwise. These terms may be used to distinguish one feature/element from another feature/element. Thus, a first feature/element discussed below could be termed a second feature/element, and similarly, a second feature/element discussed below could be termed a first feature/element without departing from the teachings of the present invention.

[000116] Throughout this specification and the claims which follow, unless the context requires otherwise, the word "comprise", and variations such as "comprises" and "comprising" means various components can be co-jointly employed in the methods and articles (e.g., compositions and apparatuses including device and methods). For example, the term "comprising" will be understood to imply the inclusion of any stated elements or steps but not the exclusion of any other elements or steps.

[000117] As used herein in the specification and claims, including as used in the examples and unless otherwise expressly specified, all numbers may be read as if prefaced by the word "about" or "approximately," even if the term does not expressly appear. The phrase "about" or "approximately" may be used when describing magnitude and/or position to indicate that the value and/or position described is within a reasonable expected range of values and/or positions. For example, a numeric value may have a value that is +/- 0.1% of the stated value (or range of values), +/- 1% of the stated value (or range of values), +/- 2% of the stated value (or range of values), +/- 5% of the stated value (or range of values), +/- 10% of the stated value (or range of values), etc. Any numerical values given herein should also be understood to include about or approximately that value, unless the context indicates otherwise. For example, if the value "10" is disclosed, then "about 10" is also disclosed. Any numerical range recited herein is intended to include all sub-ranges subsumed therein. It is also understood that when a value is disclosed that "less than or equal to" the value, "greater than or equal to the value" and possible ranges between values are also disclosed, as appropriately understood by the skilled artisan. For example, if the value "X" is disclosed the "less than or equal to X" as well as "greater than or equal to X" (e.g., where X is a numerical value) is also disclosed. It is also understood that the throughout the application, data is provided in a number of different formats, and that this data, represents endpoints and starting points, and ranges for any combination of the data points. For example, if a particular data point "10" and a particular data point "15" are disclosed, it is understood that greater than, greater than or equal to, less than, less than or equal to, and equal to 10 and 15 are considered disclosed as well as between 10 and 15. It is also understood that each unit between two particular units are also disclosed. For example, if 10 and 15 are disclosed, then 11, 12, 13, and 14 are also disclosed.

[000118] Although various illustrative embodiments are described above, any of a number of changes may be made to various embodiments without departing from the scope of the invention as described by the claims. For example, the order in which various described method steps are performed may often be changed in alternative embodiments, and in other alternative embodiments one or more method steps may be skipped altogether. Optional features of various device and system embodiments may be included in some embodiments and not in others.

Therefore, the foregoing description is provided primarily for exemplary purposes and should not be interpreted to limit the scope of the invention as it is set forth in the claims.

[000119] The examples and illustrations included herein show, by way of illustration and not of limitation, specific embodiments in which the subject matter may be practiced. As mentioned, other embodiments may be utilized and derived there from, such that structural and logical substitutions and changes may be made without departing from the scope of this disclosure.

Such embodiments of the inventive subject matter may be referred to herein individually or collectively by the term “invention” merely for convenience and without intending to voluntarily limit the scope of this application to any single invention or inventive concept, if more than one is, in fact, disclosed. Thus, although specific embodiments have been illustrated and described

5 herein, any arrangement calculated to achieve the same purpose may be substituted for the specific embodiments shown. This disclosure is intended to cover any and all adaptations or variations of various embodiments. Combinations of the above embodiments, and other embodiments not specifically described herein, will be apparent to those of skill in the art upon reviewing the above description.

10

## CLAIMS

What is claimed is:

- 5           1. A method of confirming a user's identity, the method comprising:  
            wearing a garment comprising a plurality of integrated sensors at predetermined  
            locations;  
            synchronously recording sensor data from multiple predetermined locations on the  
            garment;  
10           generating, in the garment, a biometric profile from the recorded sensor data;  
            transmitting the biometric profile to a lodger in or on the garment; and  
            confirming the user's identity using the biometric profile.
2. The method of claim 1, wherein confirming comprises comparing the biometric profile to  
            a user biometric profile recorded from the user within the last six months.
- 15           3. The method of claim 1, wherein confirming comprises comparing the biometric profile to  
            a user biometric profile using a processor in the garment.
4. The method of claim 1, wherein generating a biometric profile from the recorded sensor  
            data comprises generating the biometric profile in a scheduler on the garment.
5. The method of claim 1, wherein wearing comprises adjusting the position of the sensors  
20           based on haptic feedback from the garment.
6. The method of claim 1, wherein synchronously recording sensor data comprises  
            synchronously recording sensor data from a plurality of motion sensors.
7. The method of claim 1, wherein synchronously recording sensor data comprises  
            synchronously recording sensor data from a plurality of motion sensors, one or more  
25           respiration sensors and one or more electrodes configured to contact the user's skin when  
            the garment is worn.
8. The method of claim 1, wherein wearing the garment comprises wearing the garment  
            over the user's torso.
9. The method of claim 1, wherein synchronously recording comprises synchronously  
30           recording sensor data from multiple sensor types on the garment.

10. The method of claim 9, wherein synchronously recording sensor data comprises recording data at a plurality of frequencies.
11. The method of claim 1, further comprising transmitting confirmation of the user's identity to a third party.
- 5 12. The method of claim 1, further comprising encrypting the biometric profile prior to transmitting the biometric profile to a third party.
13. The method of claim 1, further comprising sending a coded message from a third party requesting approval of a transaction to the garment.
14. The method of claim 13, further comprising contacting an output on the garment to  
10 indicate approval to the third party.
15. A method of confirming a user's identity, the method comprising:  
wearing a garment comprising a plurality of integrated sensors at predetermined  
locations in the garment that are configured to position the integrated sensors over  
the user's torso;  
15 synchronously recording sensor data from multiple predetermined locations on the  
garment, using a plurality of different sensor types;  
generating, in the garment, a biometric profile from the recorded sensor data; and  
confirming the user's identity using the biometric profile.
16. The method of claim 15, wherein confirming comprises comparing the biometric profile  
20 to a user biometric profile recorded from the user within the last six months.
17. The method of claim 15, wherein confirming comprises comparing the biometric profile  
to a user biometric profile using a processor in the garment.
18. The method of claim 15, wherein generating a biometric profile from the recorded sensor  
data comprises generating the biometric profile in a scheduler on the garment.
- 25 19. The method of claim 15, wherein wearing comprises adjusting the position of the sensors  
based on haptic feedback from the garment.
20. The method of claim 15, wherein synchronously recording sensor data comprises  
synchronously recording sensor data from a plurality of motion sensors.

21. The method of claim 15, wherein synchronously recording sensor data comprises synchronously recording sensor data from a plurality of motion sensors, one or more respiration sensors and one or more electrodes configured to contact the user's skin when the garment is worn.
- 5 22. The method of claim 15, wherein synchronously recording sensor data comprises recording data at a plurality of frequencies.
23. The method of claim 15, further comprising encrypting the biometric profile prior to transmitting the biometric profile to the third party.
24. The method of claim 15, further comprising verifying the user's identity using a  
10 biometric template against which the biometric profile may be tested.
25. A method of confirming a user's identity, the method comprising:  
wearing a garment comprising a plurality of integrated sensors at predetermined  
locations in the garment that are configured to position the integrated sensors over  
the user's torso;  
15 adjusting the position of the sensors using haptic feedback from the garment;  
synchronously recording sensor data from multiple predetermined locations on the  
garment, using a plurality of different sensor types;  
generating, in the garment, a biometric profile from the recorded sensor data;  
confirming the user's identity by comparing, in the garment, the biometric profile to a  
20 historical biometric profile recorded from the user within a predetermined time  
period; and  
transmitting confirmation of the user's identity a third party.

1 / 13

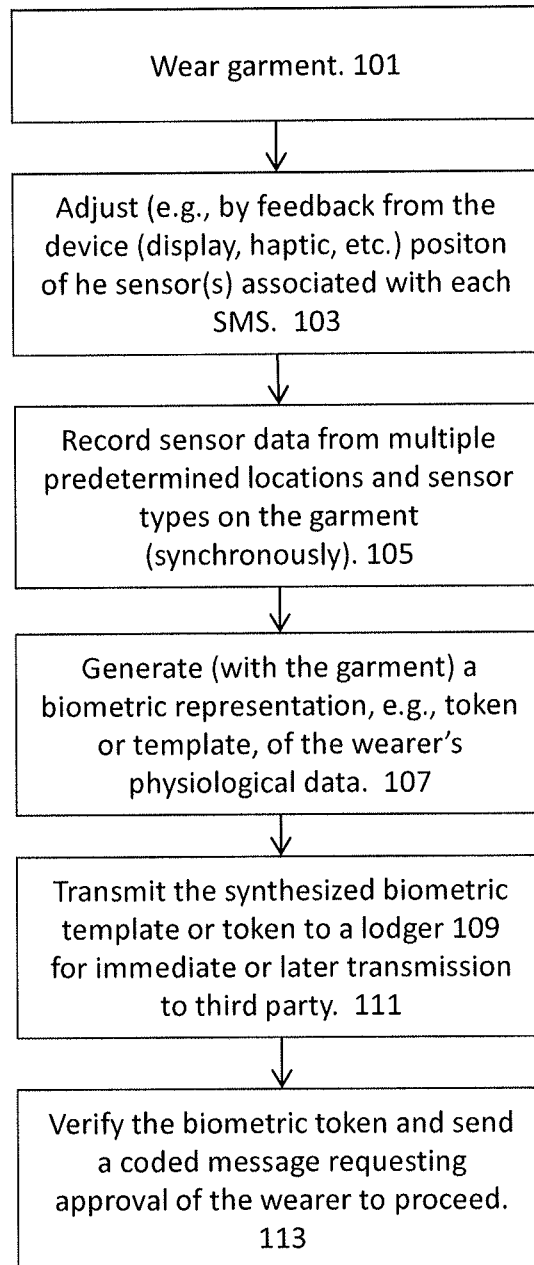

FIG. 1

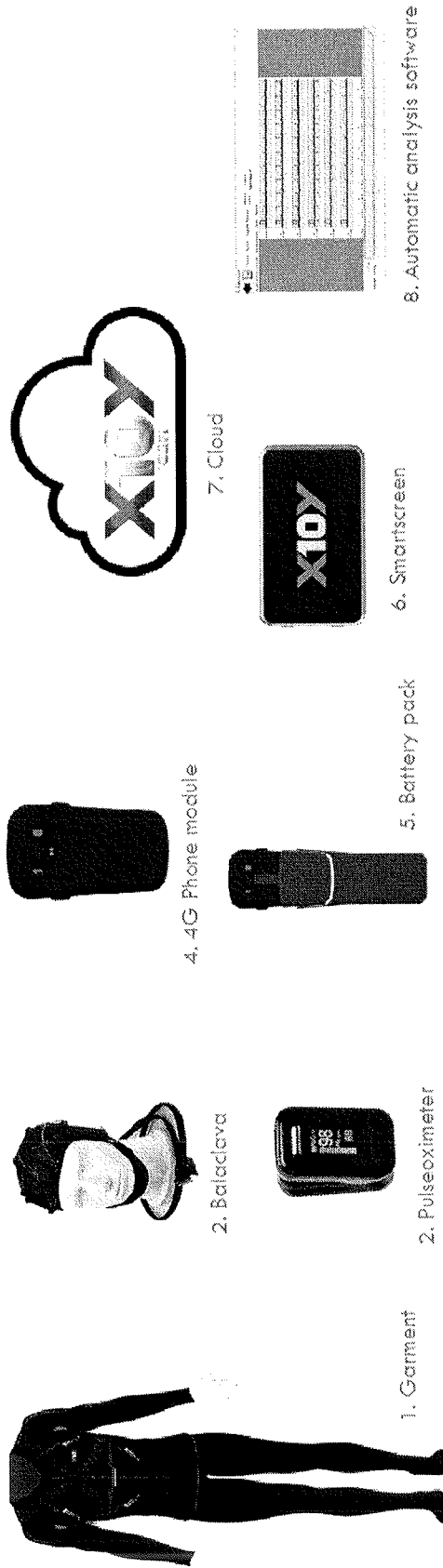

FIG. 2

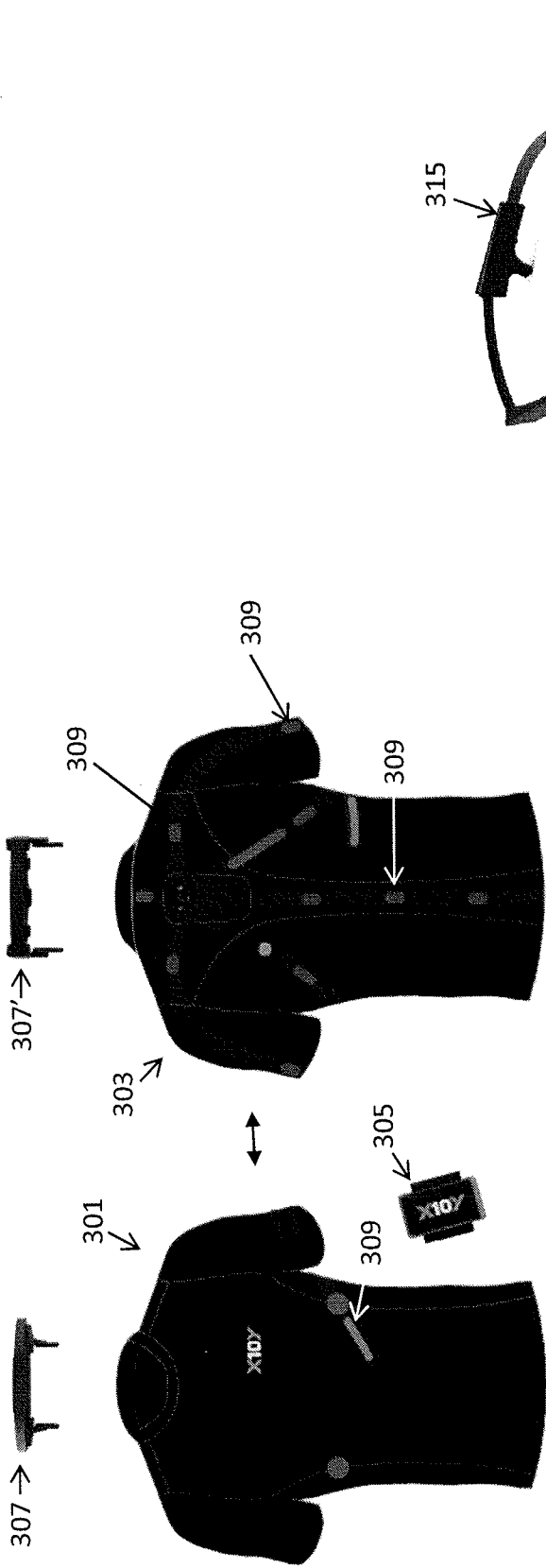

FIG. 3A



FIG. 3B

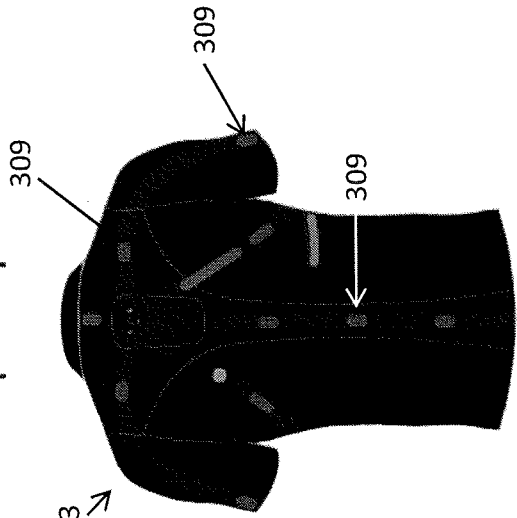
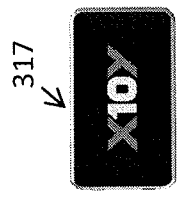
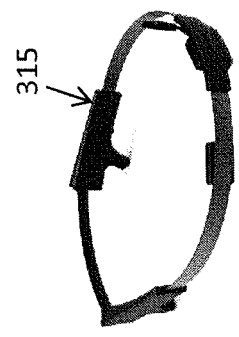

FIG. 3C



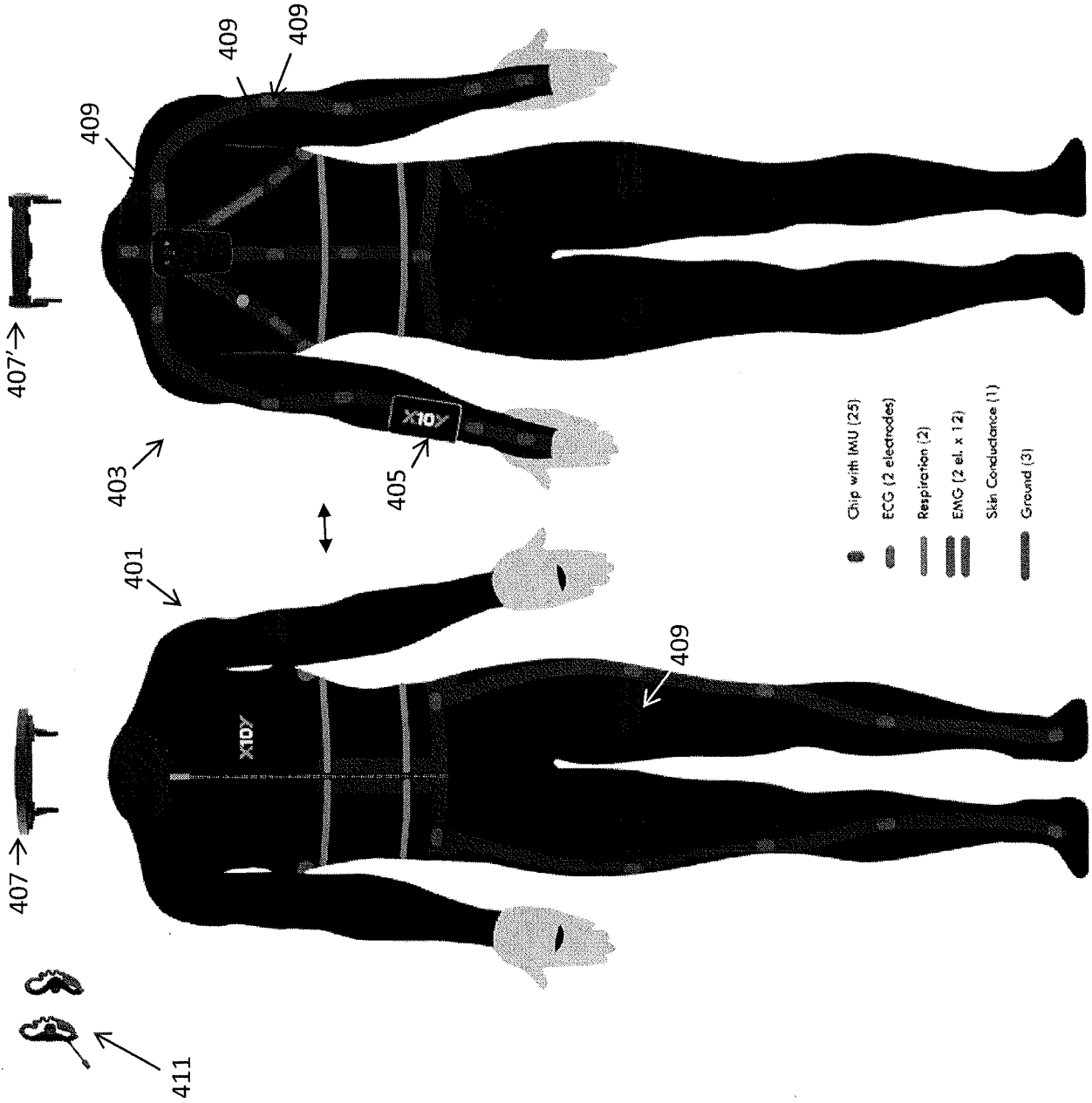

FIG. 4B

FIG. 4A

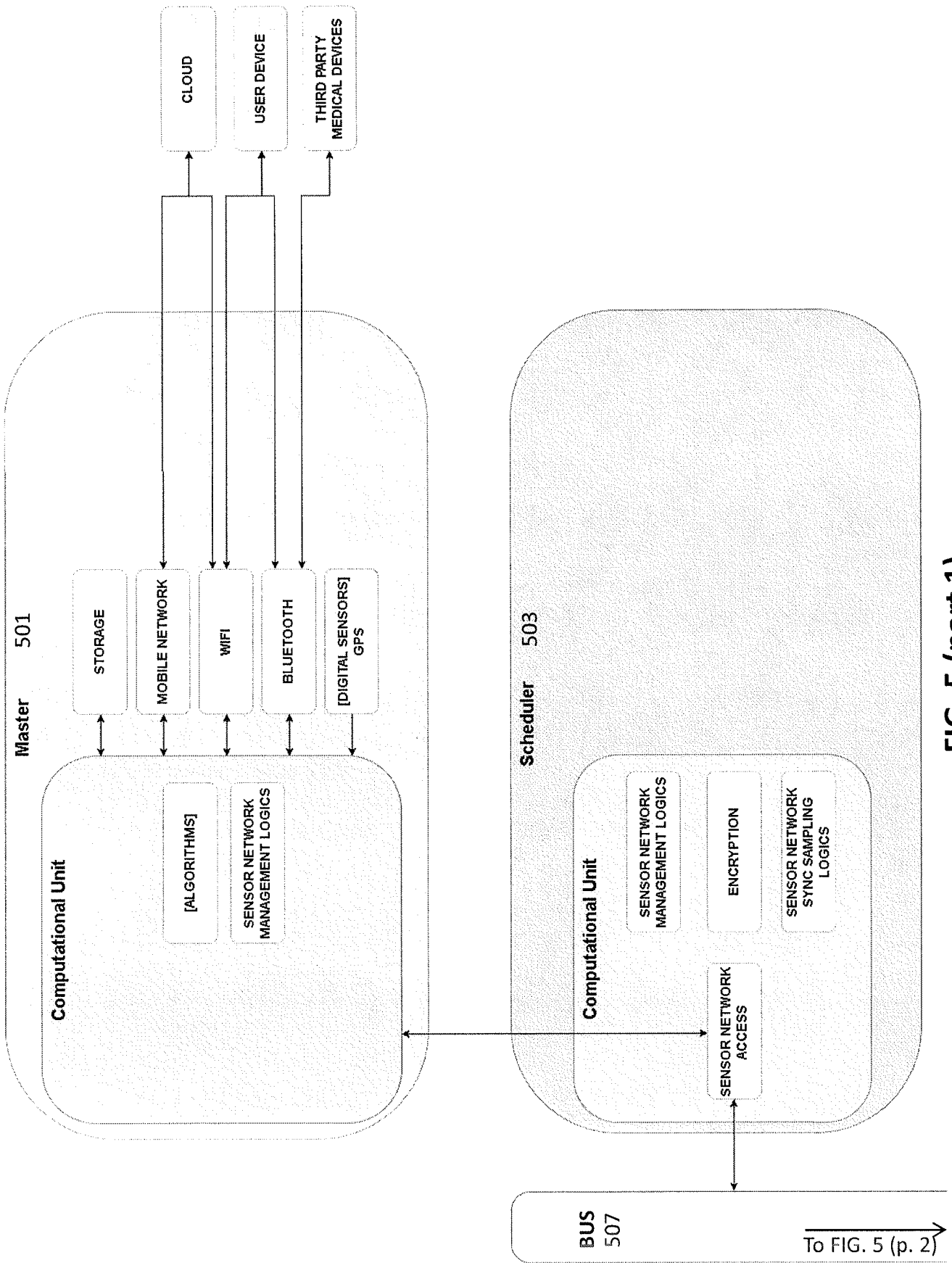

FIG. 5 (part 1)

To FIG. 5 (p. 2)

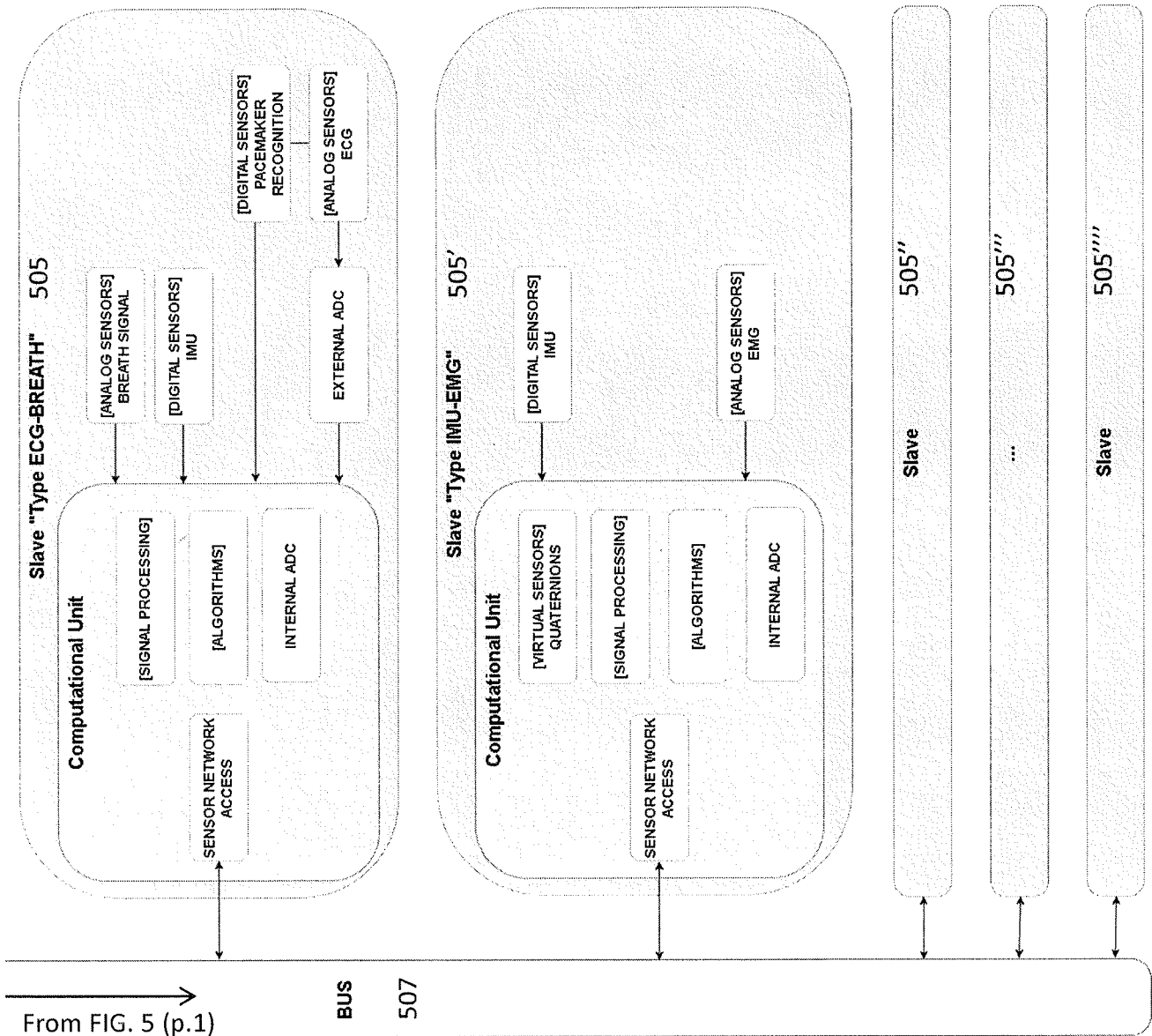

FIG. 5 (part 2)

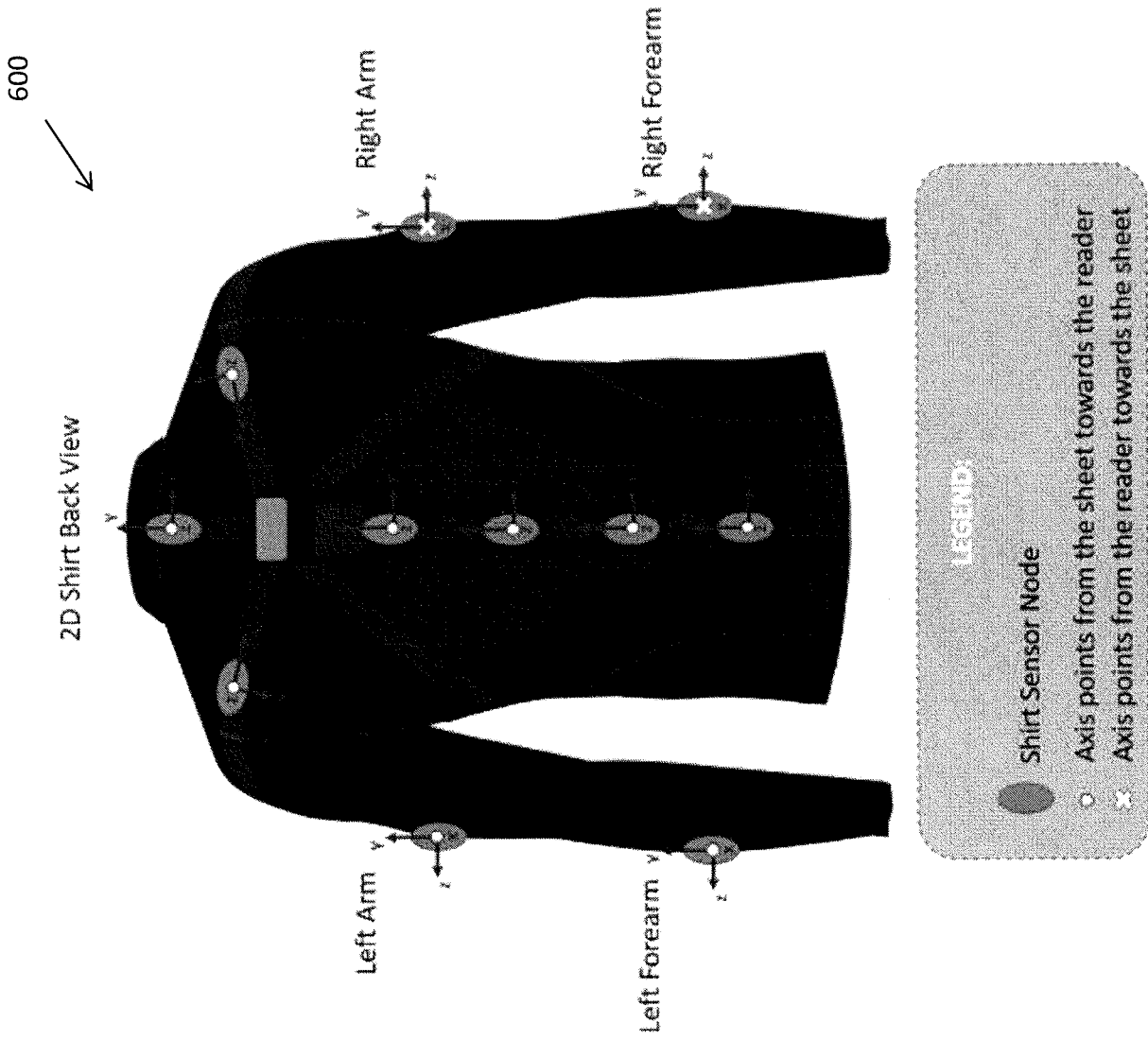

FIG. 6

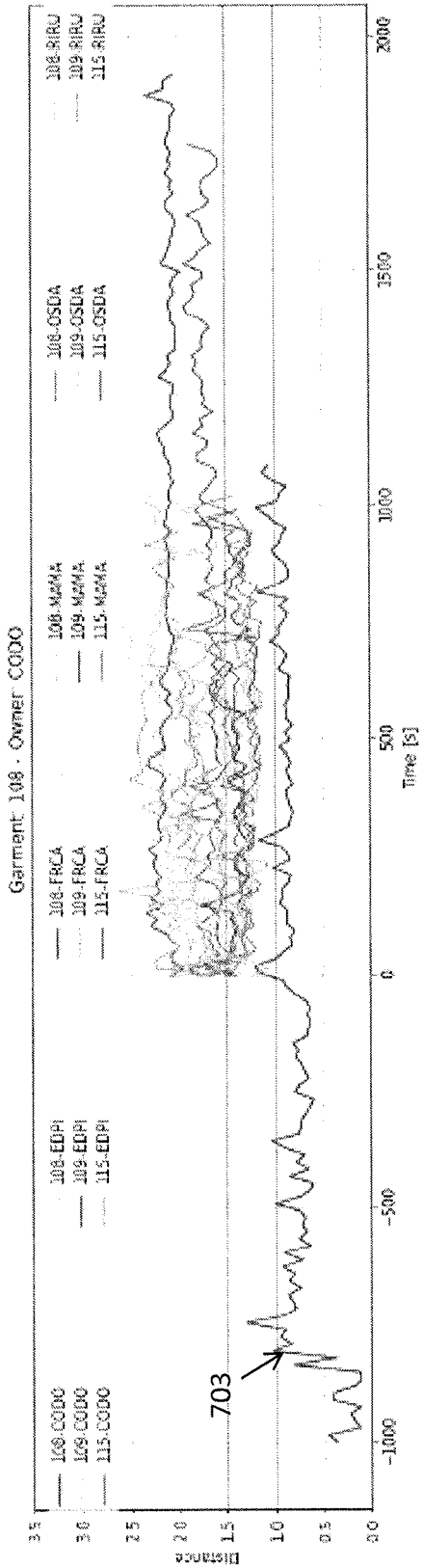

FIG. 7A

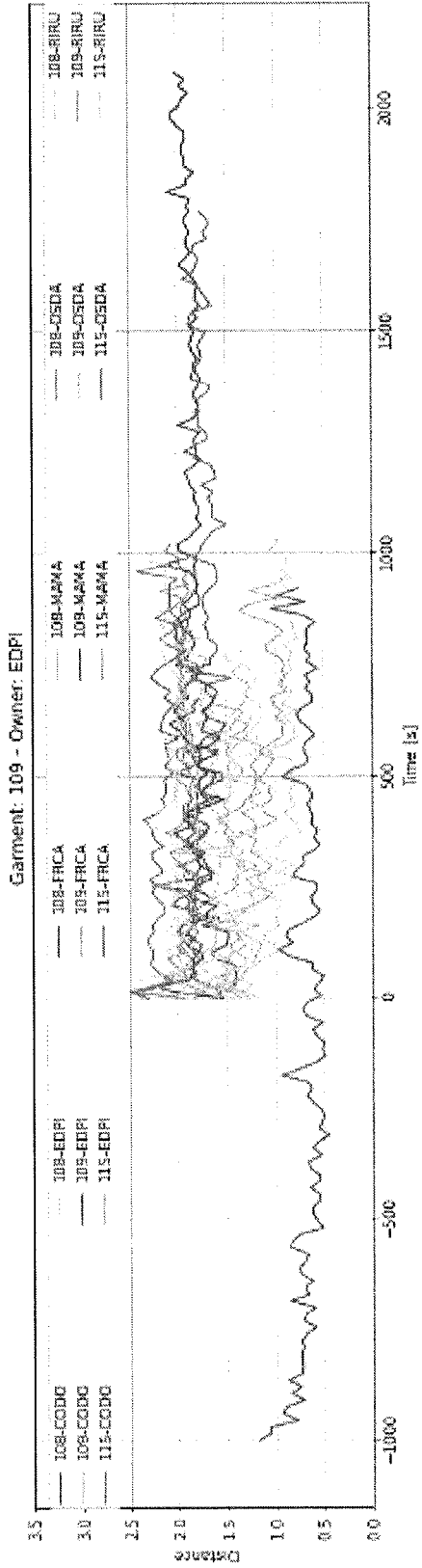

FIG. 7B

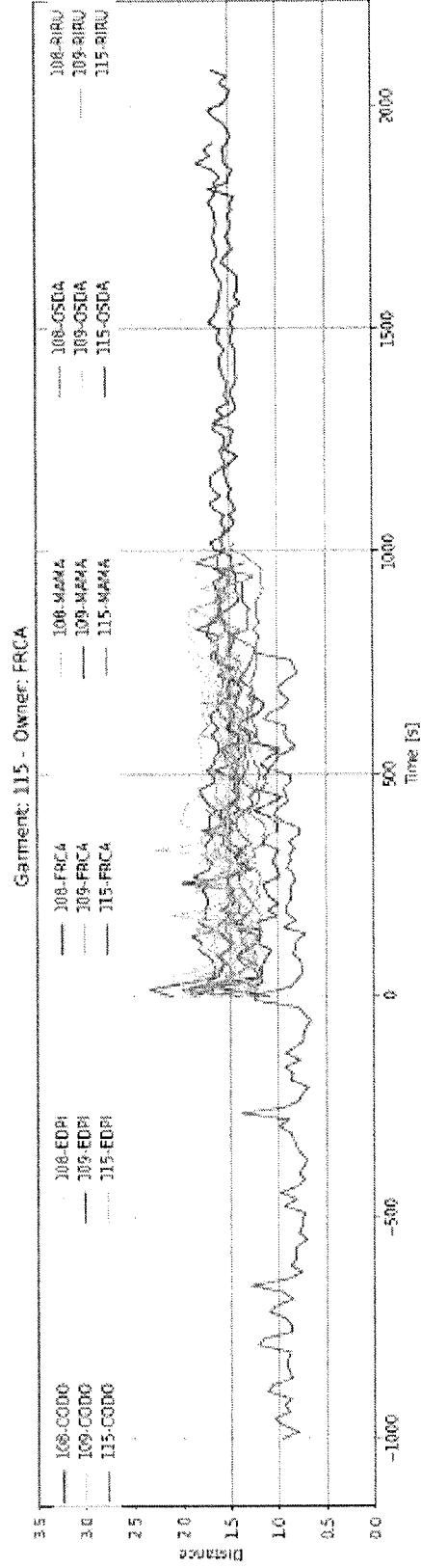

FIG. 7C

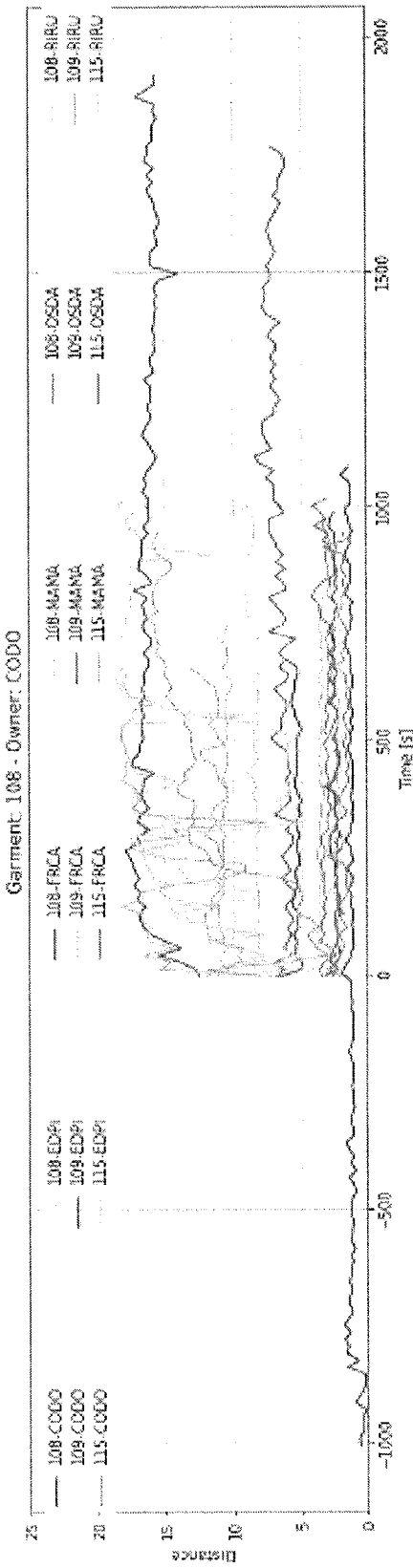

FIG. 8A

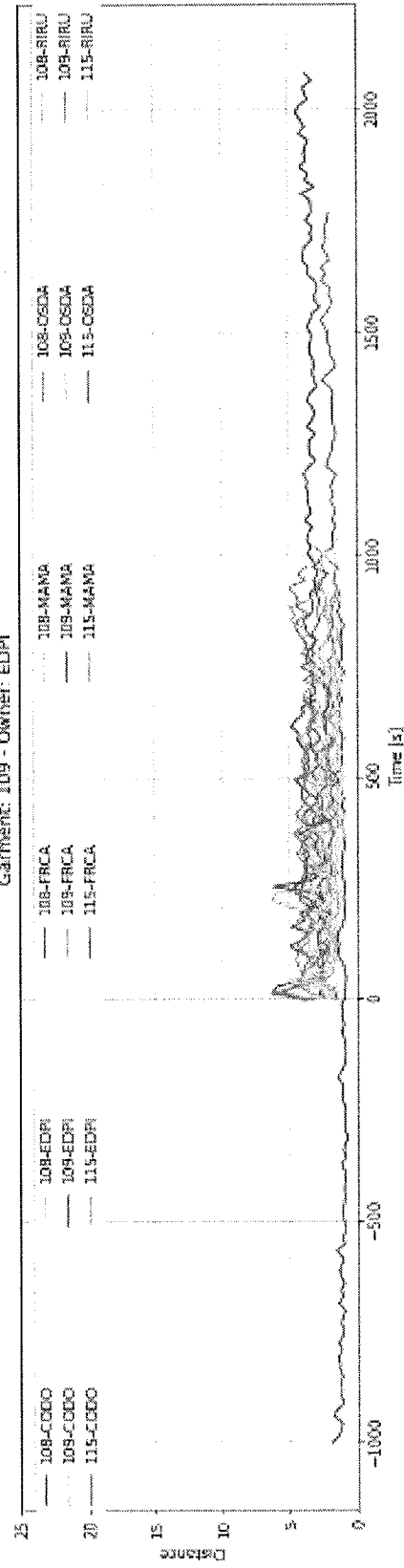

FIG. 8B

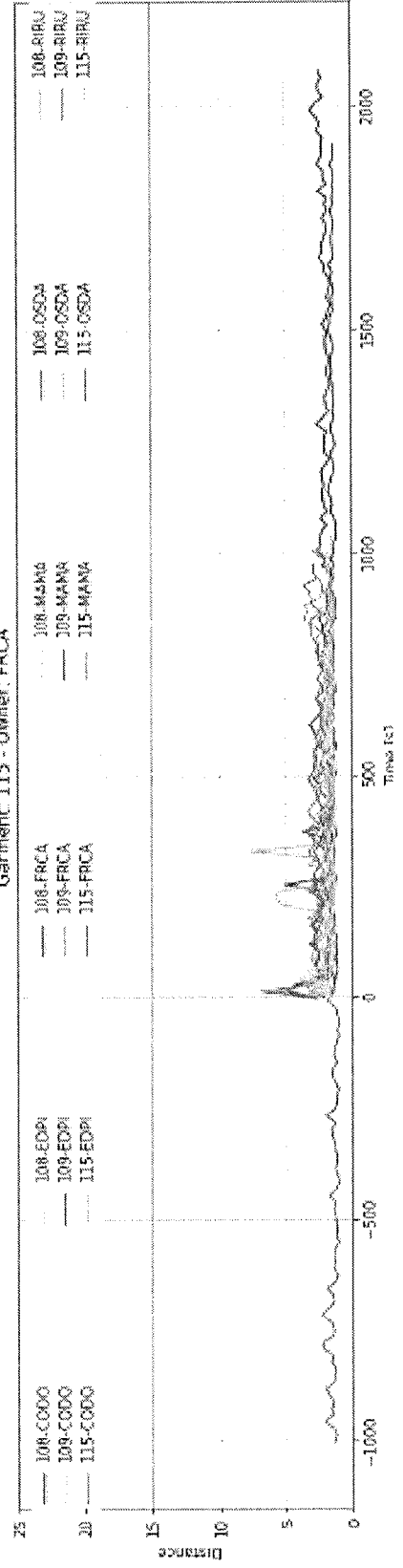

FIG. 8C

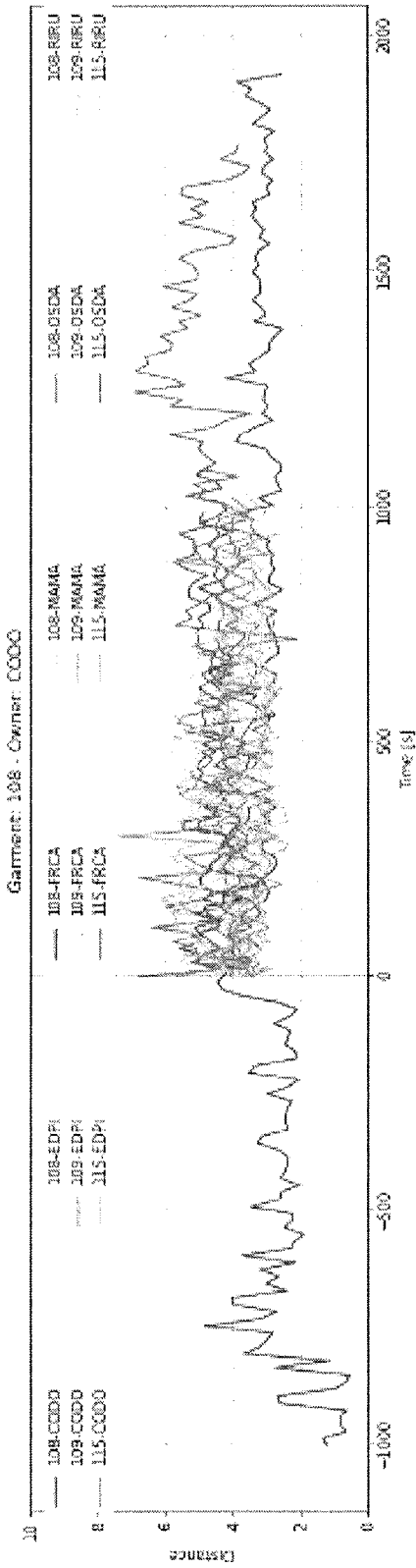

FIG. 9A

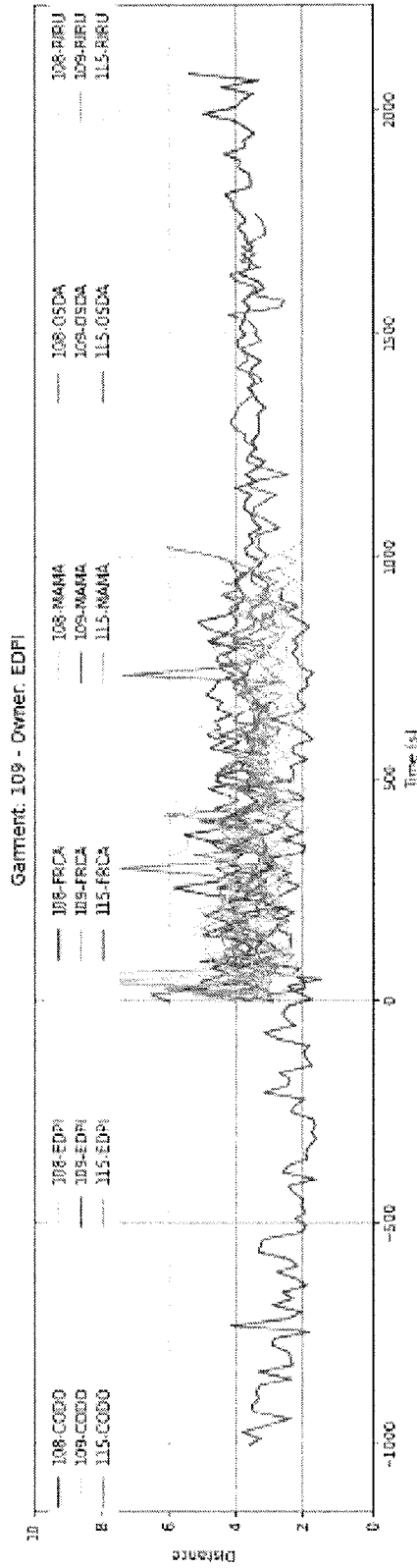

FIG. 9B

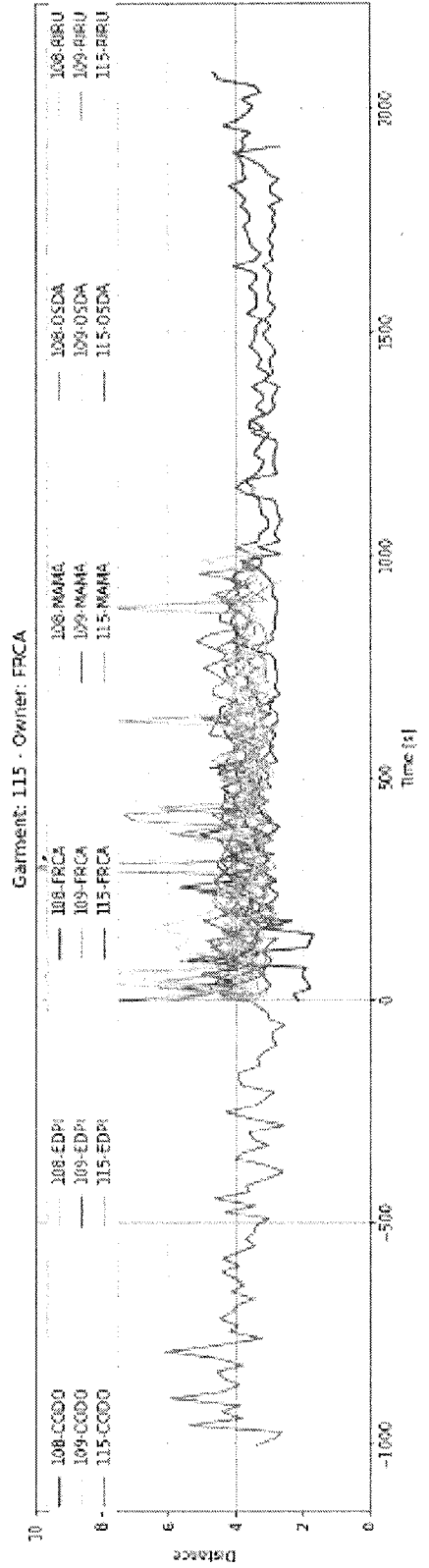

FIG. 9C

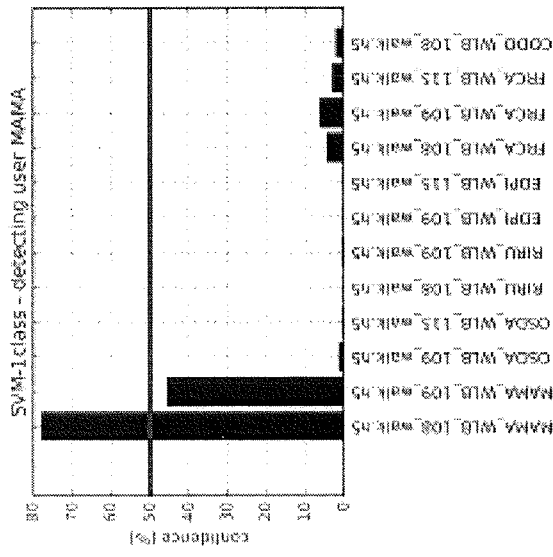
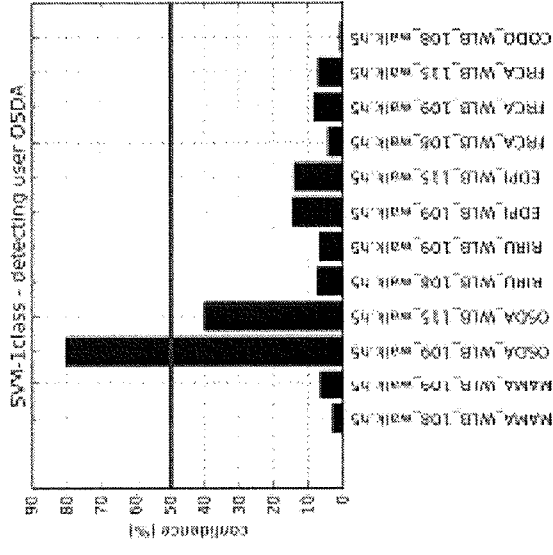
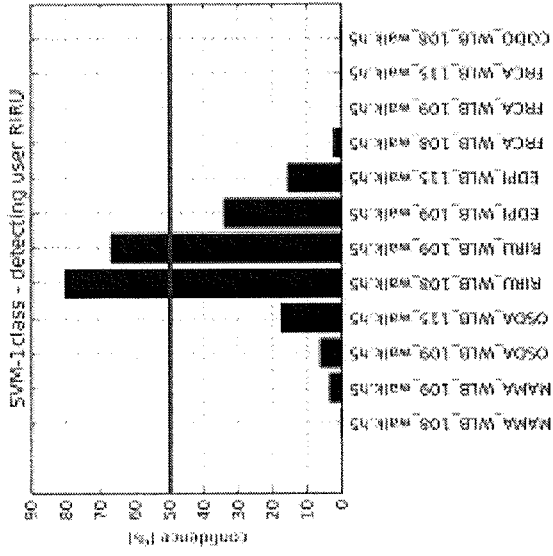

FIG. 10A

FIG. 10B

FIG. 10C

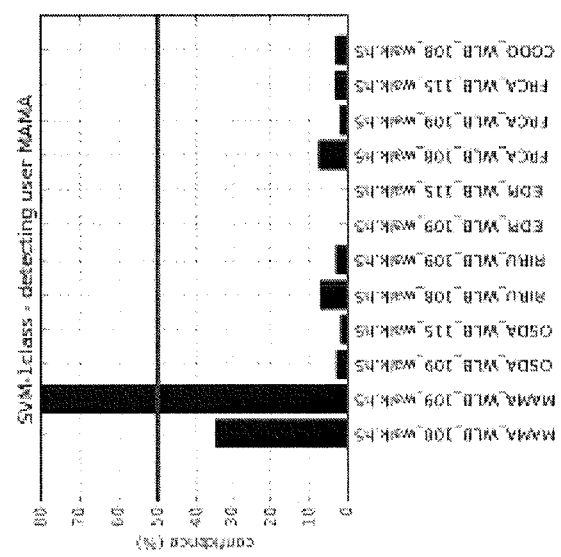
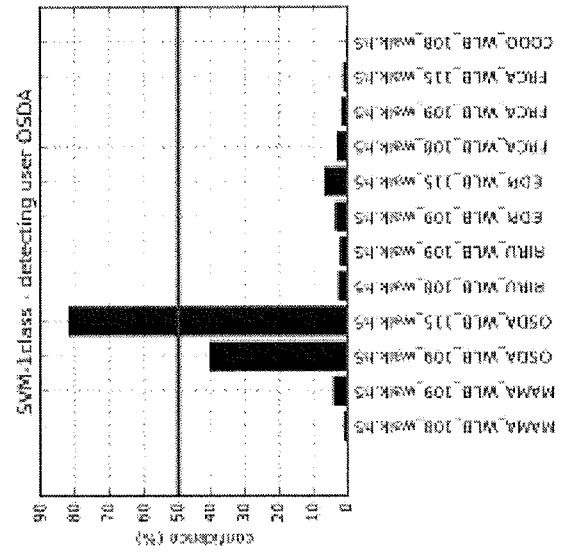
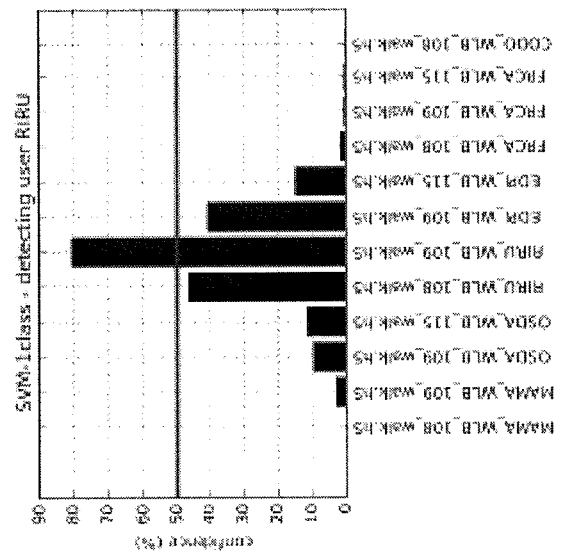

FIG. 10D

FIG. 10E

FIG. 10F



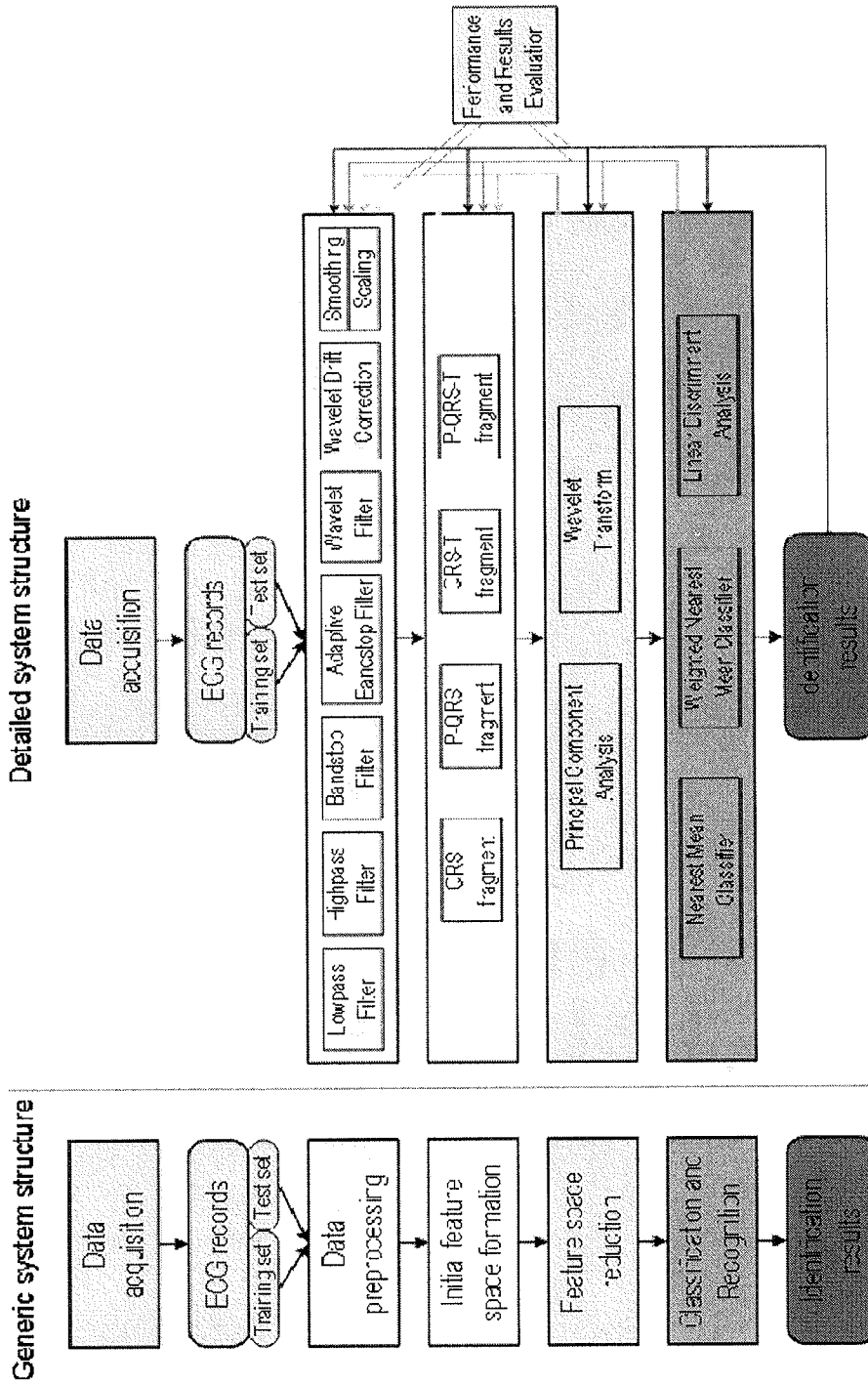

FIG. 12

**INTERNATIONAL SEARCH REPORT**

International application No  
PCT/IB2017/000969

A. CLASSIFICATION OF SUBJECT MATTER					
INV.	A61B5/117	A61B5/00	A61B5/08	G06F21/32	G06K9/00
ADD.	A61B5/0205	A61B5/0404	A61B5/0488	A61B5/11	

According to International Patent Classification (IPC) or to both national classification and IPC

B. FIELDS SEARCHED
Minimum documentation searched (classification system followed by classification symbols) A61B G06F G06K
Documentation searched other than minimum documentation to the extent that such documents are included in the fields searched
Electronic data base consulted during the international search (name of data base and, where practicable, search terms used) EPO-Internal, WPI Data

C. DOCUMENTS CONSIDERED TO BE RELEVANT		
Category*	Citation of document, with indication, where appropriate, of the relevant passages	Relevant to claim No.
X	US 2007/177770 A1 (DERCHAK P A [US] ET AL) 2 August 2007 (2007-08-02)	1-4, 6-18, 20-24
Y	paragraphs [0039] - [0043] paragraphs [0047], [0052] - [0063] figures	5,19,25
Y	US 2015/289820 A1 (MILLER DEVIN WARNER [US] ET AL) 15 October 2015 (2015-10-15) cited in the application paragraphs [0168], [0169]	5,19,25
	----- -/--	

Further documents are listed in the continuation of Box C.

See patent family annex.

* Special categories of cited documents :	
"A" document defining the general state of the art which is not considered to be of particular relevance	"T" later document published after the international filing date or priority date and not in conflict with the application but cited to understand the principle or theory underlying the invention
"E" earlier application or patent but published on or after the international filing date	"X" document of particular relevance; the claimed invention cannot be considered novel or cannot be considered to involve an inventive step when the document is taken alone
"L" document which may throw doubts on priority claim(s) or which is cited to establish the publication date of another citation or other special reason (as specified)	"Y" document of particular relevance; the claimed invention cannot be considered to involve an inventive step when the document is combined with one or more other such documents, such combination being obvious to a person skilled in the art
"O" document referring to an oral disclosure, use, exhibition or other means	"&" document member of the same patent family
"P" document published prior to the international filing date but later than the priority date claimed	

Date of the actual completion of the international search  14 November 2017	Date of mailing of the international search report  21/11/2017
Name and mailing address of the ISA/ European Patent Office, P.B. 5818 Patentlaan 2 NL - 2280 HV Rijswijk Tel. (+31-70) 340-2040, Fax: (+31-70) 340-3016	Authorized officer  Bataille, Frédéric

## INTERNATIONAL SEARCH REPORT

International application No  
PCT/IB2017/000969

C(Continuation). DOCUMENTS CONSIDERED TO BE RELEVANT		
Category*	Citation of document, with indication, where appropriate, of the relevant passages	Relevant to claim No.
X	<p>WO 2010/096907 A1 (BUSINESS ACCELERATORS INC [CA]; LEBLANC DONALD JOSEPH [CA]; PETRUESCU) 2 September 2010 (2010-09-02)            paragraphs [0045] - [0049]            paragraphs [0055] - [0062]            paragraphs [0066] - [0079]            figures</p> <p style="text-align: center;">-----</p>	1-4,6, 9-14
A	<p>WO 03/000015 A2 (SCIENCE APPLIC INT CORP [US]; WIEDERHOLD MARK D [US]; MEYER RODNEY P []) 3 January 2003 (2003-01-03)            paragraphs [0041] - [0050]            paragraphs [0067] - [0075]</p> <p style="text-align: center;">-----</p>	1-25
A	<p>EP 3 037 036 A1 (SAMSUNG ELECTRONICS CO LTD [KR]) 29 June 2016 (2016-06-29)            the whole document</p> <p style="text-align: center;">-----</p>	1-25

# INTERNATIONAL SEARCH REPORT

Information on patent family members

International application No PCT/IB2017/000969
---

Patent document cited in search report	Publication date	Patent family member(s)	Publication date
US 2007177770	A1	02-08-2007	CA 2641305 A1 09-08-2007 EP 1979855 A2 15-10-2008 JP 2009525070 A 09-07-2009 US 2007177770 A1 02-08-2007 US 2014304792 A1 09-10-2014 WO 2007089751 A2 09-08-2007
US 2015289820	A1	15-10-2015	NONE
WO 2010096907	A1	02-09-2010	CA 2662431 A1 24-08-2010 US 2012086550 A1 12-04-2012 WO 2010096907 A1 02-09-2010
WO 03000015	A2	03-01-2003	AU 2002322302 A1 08-01-2003 US 2003135097 A1 17-07-2003 WO 03000015 A2 03-01-2003
EP 3037036	A1	29-06-2016	EP 3037036 A1 29-06-2016 US 2016183812 A1 30-06-2016

专利名称(译)	通过具有多个传感器的服装进行生物识别		
公开(公告)号	<a href="#">EP3478174A1</a>	公开(公告)日	2019-05-08
申请号	EP2017768218	申请日	2017-07-03
[标]申请(专利权)人(译)	立芙公司		
申请(专利权)人(译)	生活. CORPORATION S.A.		
当前申请(专利权)人(译)	生活. CORPORATION S.A.		
[标]发明人	LONGINOTTI BUITONI GIANLUIGI		
发明人	LONGINOTTI-BUITONI, GIANLUIGI		
IPC分类号	A61B5/117 A61B5/00 A61B5/08 G06F21/32 G06K9/00 A61B5/0205 A61B5/0404 A61B5/0488 A61B5/11		
CPC分类号	A61B5/0024 A61B5/0205 A61B5/0404 A61B5/0488 A61B5/0816 A61B5/11 A61B5/117 A61B5/6804 A61B5/6805 A61B2562/0219 G06F1/163 G06F3/011 G06F3/015 G06F3/017 G06F21/32 G06F21/34 G06K9/00342 G06K9/00355 G06K9/00892 G06K2009/00939 H04L63/0861 H04W12/0605 A41D13/1281 A61B5/0428 A61B5/053 G06K9/00906 G06K9/4609 H04W12/06 A61B5/04		
代理机构(译)	J A KEMP		
优先权	62/357665 2016-07-01 US		
外部链接	<a href="#">Espacenet</a>		

#### 摘要(译)

用于基于包括多个传感器的可穿戴服装唯一地识别一个人的生物识别方法和装置(包括装置和系统),包括但不限于具有多个感测模态的传感器(例如,运动,呼吸运动,心率,ECG,脑电图等)。