



- (51) International Patent Classification:
A61B 5/0428 (2006.01) A61B 5/0402 (2006.01)
- (21) International Application Number:
PCT/CA2015/050938
- (22) International Filing Date:
23 September 2015 (23.09.2015)
- (25) Filing Language: English
- (26) Publication Language: English
- (30) Priority Data:
62/054,189 23 September 2014 (23.09.2014) US
62/206,542 18 August 2015 (18.08.2015) US
- (71) Applicant: RR SEQUENCES INC. [CA/CA]; 4311-1751
Richardson, Montreal, Québec H3K 1G6 (CA).

- (72) Inventors: JAIN, Deepak Bobby; 3510 Croissant des
Caryers, Brossard, Québec J4Z 3S8 (CA). WEEKS,
Joshua; 13-3514 Hutchison, Montreal, Québec H2X 2H2
(CA). NADEZHIN, David; 401-1673 St-Patrick,
Montreal, Québec H3K 3G9 (CA). ASSELIN, Jean-
François; 102-70 de Balmoral Ave, Brossard, Québec J5R
4L5 (CA).
- (74) Agent: BENOIT & COTE INC.; 800-1550 Metclafe,
Montreal, Québec H3A 1X6 (CA).
- (81) Designated States (unless otherwise indicated, for every
kind of national protection available): AE, AG, AL, AM,
AO, AT, AU, AZ, BA, BB, BG, BH, BN, BR, BW, BY,
BZ, CA, CH, CL, CN, CO, CR, CU, CZ, DE, DK, DM,
DO, DZ, EC, EE, EG, ES, FI, GB, GD, GE, GH, GM, GT,
HN, HR, HU, ID, IL, IN, IR, IS, JP, KE, KG, KN, KP, KR,
KZ, LA, LC, LK, LR, LS, LU, LY, MA, MD, ME, MG,
MK, MN, MW, MX, MY, MZ, NA, NG, NI, NO, NZ, OM,
PA, PE, PG, PH, PL, PT, QA, RO, RS, RU, RW, SA, SC,
SD, SE, SG, SK, SL, SM, ST, SV, SY, TH, TJ, TM, TN,
TR, TT, TZ, UA, UG, US, UZ, VC, VN, ZA, ZM, ZW.

[Continued on next page]

(54) Title: CONTACTLESS ELECTRIC CARDIOGRAM SYSTEM

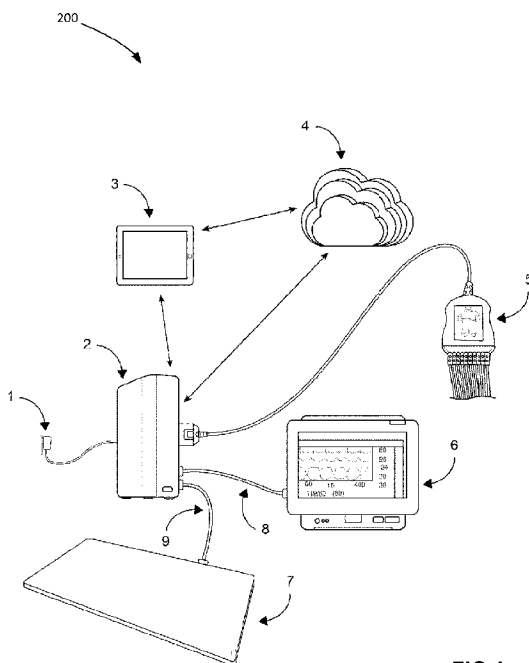

FIG.1

(57) Abstract: A system for providing a standard electrocardiogram (ECG) signal for a human body using contactless ECG sensors for outputting to exiting medical equipment or for storage or viewing on a remote device. The system comprises a digital processing module (DPM) adapted to connect to an array of contactless ECG sensors provided in a fabric or the like. A selection mechanism is embedded into the DPM which allows the DPM to identify body parts using the ECG signals of the different ECG sensors and select for each body part the best sensor lead. The DPM may then produce the standard ECG signal using the selected ECG signals for the different body parts detected. The system is adapted to continuously re-examine the selection to ensure that the best leads are selected for a given body part following a movement of the body part, thereby, allowing for continuous and un-interrupted ECG monitoring of the patient.





(84) Designated States (*unless otherwise indicated, for every kind of regional protection available*): ARIPO (BW, GH, GM, KE, LR, LS, MW, MZ, NA, RW, SD, SL, ST, SZ, TZ, UG, ZM, ZW), Eurasian (AM, AZ, BY, KG, KZ, RU, TJ, TM), European (AL, AT, BE, BG, CH, CY, CZ, DE, DK, EE, ES, FI, FR, GB, GR, HR, HU, IE, IS, IT, LT, LU, LV, MC, MK, MT, NL, NO, PL, PT, RO, RS, SE,

SI, SK, SM, TR), OAPI (BF, BJ, CF, CG, CI, CM, GA, GN, GQ, GW, KM, ML, MR, NE, SN, TD, TG).

Published:

— *with international search report (Art. 21(3))*

CONTACTLESS ELECTRIC CARDIOGRAM SYSTEM

CROSS-REFERENCE TO RELATED APPLICATIONS

[0001] This application claims priority under of US provisional patent application 62/054189 filed on September 23, 2015 and US provisional patent application 62/206542 filed on August 18, 2015, the specifications of which are hereby incorporated by reference.

BACKGROUND

(a) Field

[0002] The subject matter generally relates to electro-cardiogram systems.

(b) Related Prior Art

[0003] Electrocardiograms (hereinafter ECG's) are the only reliable measurement of heart rate, arrhythmia detection, resting ECG abnormalities that necessitate mandatory further testing, changes from previous ECG's.

[0004] The ECG is one of the basic diagnostic and follow up screening tools used in medicine for a large number of cardiac and non-cardiac diseases. While the standard 12-lead electrocardiogram holds a wealth of information, it only captures data for 10 seconds. Long term monitoring with multiple leads provides even more information and leads to better access to changes in the electrocardiogram.

[0005] The lack of long term monitoring is an important medical problem for multiple reasons. The lack of a baseline electrocardiogram in a patient's file often results in confusion and needless additional exams in patients who have ECGs done for the first time which are normal for them, but abnormal according to established criteria. Often, if an old ECG, even one from 10 years prior, is available that is the same as the perceived abnormal ECG, no further exams are required. In other words, the ability to compare a current ECG to an old one is of immense medical value. An unchanged one results in fewer examinations.

[0006] Traditional electrocardiographic measurement systems that rely on contact electrodes (electrodes which form a galvanic connection with the patient's body) present challenges when ECG monitoring is required immediately, unobtrusively or frequently. Traditional contact electrodes require placement by a trained healthcare provider on a clean, prepared skin surface to ensure accurate location (and therefore morphology) and signal quality. Limitations of standard wet gel contact electrode placement include placing them on the body correctly and removing them within their time limit to avoid skin reactions.

[0007] Apart from their inability to provide long term monitoring, their availability is also limited as discussed below.

[0008] Ideally, ECGs should be performed on all patients as part of the routine medical visit, especially if the patient has symptoms that necessitate medical attention. However, the availability of the test is limited. Their availability is limited due to the cost of the ECG equipment and the un-availability of the technicians needed to perform the test on patients to put the leads on the patient correctly. With respect to ECG costs, most physicians do not invest in having the test on site. Even in hospitals, telemetry units are limited to about 6 to 10 units located outside of the intensive care units for the entire patients in a large hospital.

[0009] Another disadvantage is that standard electrodes have multiple problems that limit proper and widespread use of the ECG. These problems are:

1. The electrodes react with the skin due to the metal, gel, and adhesive reactions, which requires multiple changes during a hospital stay;
2. The lack of knowledge required to correctly place the electrodes;
3. The time for placing the electrodes;

4. The complications associated with extended monitoring such as when the electrodes fall off regularly due to sweat, patient's movement, improper placement, etc;
5. ECG's derived using standard electrodes are prone to muscular artifacts that result in false ECG's.

[0010] A further disadvantage is that the electrocardiogram obtained with standard electrodes is labor and material intensive. Even a telemetry unit can take, in certain cases, upwards of 2-3 hours per day per patient of nursing time to install and re-install standard electrodes.

[0011] Yet a further disadvantage is that ECGs are a source of nosocomial infection spread in hospitals because of wires and their contact with nursing and hospital staff, and frequent nursing attention to the electrodes.

[0012] Accordingly, there is a need in the market for a system and method which address the shortcomings addressed above.

SUMMARY

[0013] The embodiments describe an ECG system which allows for frequent, inexpensive and accessible recording of ECG data from any patient or person easily, unobtrusively and quickly by eliminating the need to manually identify and prepare areas on the patient's body for contact sensors and to place sensors on those areas. The described system circumvents issues associated with contact electrodes by being contactless and by allowing multi-hour, multiple lead monitoring on a daily basis and for life.

[0014] In one aspect, there is provided a medical apparatus (aka DPM) for providing electrocardiogram (ECG) signals for a human body using contactless ECG sensors, the medical apparatus comprising: an input adapted to receive contactless ECG signals from an array of contactless ECG sensors; a processor adapted to perform a selection process including: detecting body parts located in proximity of the array of contactless ECG sensors; associating a

group of contactless ECG sensors with each detected body part; selecting from each group a contactless ECG sensor having a highest signal quality; the processor being adapted to produce a standard ECG signal based on the received contactless ECG signal of each selected contactless ECG sensor; and an output for sending the standard ECG signal.

[0015] The Medical apparatus may be a lightweight portable device that weighs less than 2lbs.

[0016] In an embodiment, the selection process further comprises the steps of: obtaining a body outline of the human body using the contactless ECG signals associated with the contactless ECG sensors located in proximity of the human body; determining a position of the human body on the array of contactless ECG sensors; dividing the contactless ECG sensors into groups and associating each group to a body part using the body outline and the position of the human body; and from each group, selecting the contactless ECG sensor providing the contactless ECG signal having the highest quality.

[0017] In an embodiment, the processor may identify the contactless ECG sensors that are located in close proximity to the human body by measuring an impedance between each contactless ECG sensor and the human body.

[0018] In another embodiment, the medical apparatus may be adapted to select another contactless ECG sensor for a given body part following a movement of the human body with respect to the array of contactless ECG sensors. In a further embodiment, the processor may be adapted to re-run the selection process continuously to perform the selection of the other contactless ECG sensor. The processor may also be adapted to continuously monitor a signal quality of the selected contactless ECG sensor associated with each body part to re-run the selection process when the signal quality drops beyond a given threshold.

[0019] The medical apparatus may comprise different operation modes comprising: a contactless mode which outputs a first standard ECG signal resulting from the contactless ECG signals; a hybrid mode which outputs a second standard ECG signal resulting from the contactless ECG signals and conventional ECG signals received from conventional contact electrodes; and a bypass mode which outputs a third standard ECG signal resulting from conventional ECG signals received from conventional contact electrodes.

[0020] The medical apparatus may further comprise an automatic gain control mechanism adapted to control relative impedance differences between different contactless ECG sensors and absolute impedance of each contactless ECG sensor to the human body due to a difference in distance or clothing materials between each contactless ECG sensor and the human body.

[0021] A wired/wireless data port may be provided for transmitting the standard ECG signal to a remote device over a data network.

[0022] In another aspect, a system for providing electrocardiogram (ECG) signals for a human body using contactless ECG sensors, the system comprising: a sensor pad comprising an array of contactless ECG sensors; a processor operatively connected to the sensor pad and adapted to receive contactless ECG signals from the contactless ECG sensors and perform a selection process including: detecting body parts located in proximity of the array of contactless ECG sensors; associating a group of contactless ECG sensors with each detected body part; selecting from each group a contactless ECG sensor having a highest signal quality; the processor being adapted to produce a standard ECG signal based on the contactless ECG signal of each selected contactless ECG sensor; and an output for sending the standard ECG signal.

[0023] In an embodiment, the sensor pad comprises a grounding pad for placing in proximity of and at distance from the human body, the grounding pad

being adapted to provide a capacitively coupled ground reference to the human body for reducing interference.

[0024] In another embodiment, the grounding pad may be driven with a feedback signal derived from the contactless ECG signals.

[0025] The system may further comprise a drive signal generator configured to feed the grounding pad with a high frequency signal that is outside of an ECG frequency band for determining the capacitively coupled ground reference for each contactless ECG sensor.

[0026] In an embodiment, the contactless ECG sensor may comprise: a capacitive electrode adapted to be capacitively coupled to the human body for outputting an electrical charge which is representative of an electrical cardiac activity; an electrodynamic sensor configured to detect and amplify the electrical charge produced by the capacitive electrode; and an electrode shield physically provided in proximity of the electrode for reducing a stray interference at an input of the electrodynamic sensor.

[0027] The contactless ECG sensor may be made of a flexible material.

[0028] In an embodiment, the sensor pad may be provided in a fabric with which the human body comes in contact.

[0029] In a further aspect, there is provided a method for providing electrocardiogram (ECG) signals for a human body using contactless ECG sensors, the method comprising: receiving contactless ECG signals from an array of contactless ECG sensors; detecting body parts located in proximity of the array of contactless ECG sensors; associating a group of contactless ECG sensors with each detected body part; selecting from each group a contactless ECG sensor having a highest signal quality; and producing a standard ECG signal based on the contactless ECG signal of each selected contactless ECG sensor.

[0030] The method may further comprise obtaining a body outline of the human body using the contactless ECG signals associated with the contactless ECG sensors located in proximity of the human body; determining a position of the human body on the array of contactless ECG sensor; dividing the contactless ECG sensors into groups and associate each group to a body part using the body outline and the position of the human body; and from each group, selecting the contactless ECG sensor providing the contactless ECG signal having the highest quality.

[0031] In an embodiment, the method further comprises identifying the contactless ECG sensors that are located in close proximity to the human body by measuring an impedance between each contactless ECG sensor and the human body.

[0032] The method may further repeat the steps of detecting to selecting continuously for selecting another contactless ECG sensor for a given body part following a movement of the human body with respect to the array of contactless ECG sensors. In on embodiment, it is possible to continuously monitor a signal quality of the selected contactless ECG sensor associated with each body part and repeat the steps of detecting to selecting for selecting another contactless ECG sensor for a given body part when the signal quality drops beyond a given threshold following a movement of the human body with respect to the array of contactless ECG sensors.

[0033] The following terms are defined below:

[0034] The term lead is intended to mean a difference in measured voltage between two locations on the human body that provide and show PQRSTU waveforms.

[0035] The term ECG lead is intended to mean a medically defined ECG signal based on a difference in measured voltage between two medically defined locations on the human body.

[0036] Standard ECG signal is an ECG signal that interfaces with existing medical equipment and conforms to ECG standards. A standard ECG signal may include a single rhythm strip or any number of standard medically defined ECG leads.

[0037] A rhythm strip is any lead that shows the rhythm between the PQRSTU waveforms. The rhythm strip does not require that the ECG signal be taken from the medically defined ECG locations.

[0038] Features and advantages of the subject matter hereof will become more apparent in light of the following detailed description of selected embodiments, as illustrated in the accompanying figures. As will be realized, the subject matter disclosed and claimed is capable of modifications in various respects, all without departing from the scope of the claims. Accordingly, the drawings and the description are to be regarded as illustrative in nature, and not as restrictive and the full scope of the subject matter is set forth in the claims.

BRIEF DESCRIPTION OF THE DRAWINGS

[0039] Further features and advantages of the present disclosure will become apparent from the following detailed description, taken in combination with the appended drawings, in which:

[0040] Fig.1 is a block diagram of an exemplary ECG system in accordance with an embodiment;

[0041] Fig.2 illustrates a non-limiting example of a sensor matrix in accordance with an embodiment;

[0042] Fig.3 is a flowchart illustrating the main steps performed by the selection algorithm, in accordance with an embodiment;

[0043] Fig.4 illustrates an example of a full PQRST waveform obtained for a patient using a system in accordance with an embodiment;

- [0044]** Fig.5 illustrates how the sensor array captures ECG signals without direct contact with the patient's skin;
- [0045]** Fig.6 is a block diagram illustrating an exemplary sensor design of a contactless ECG sensor, in accordance with an embodiment;
- [0046]** Fig.7 illustrates an example of a physical design of a contactless ECG sensor, in accordance with an embodiment;
- [0047]** Fig.8 illustrates an exemplary block diagram of an overall design of a system in accordance with an embodiment;
- [0048]** Fig.9 is a block diagram illustrating an exemplary gain control mechanism, in accordance with an embodiment
- [0049]** Fig.10 is an exemplary block diagram illustrating the function of the RLD generator, in accordance with an embodiment
- [0050]** Fig.11 shows medically recognized ECG locations for obtaining standard ECG leads;
- [0051]** Fig.12 illustrates an example of standard ECG leads, each lead being shown as a vector between two locations on the human body;
- [0052]** Figs.13a&13b illustrate an example of how the system determines the body outline of the patient; and
- [0053]** Fig.14 is flowchart of a method for providing electrocardiogram (ECG) signals for a human body using contactless ECG sensors.
- [0054]** It will be noted that throughout the appended drawings, like features are identified by like reference numerals.

DETAILED DESCRIPTION

[0055] A system for providing a standard electrocardiogram (ECG) signal for a human body using contactless ECG sensors for outputting to exiting

medical equipment (as well as to new/dedicated monitors, or for viewing on a display device associated with a computing device) or for storage or viewing on a remote/local device. The system comprises a digital processing module (DPM) adapted to connect to an array of contactless ECG sensors provided in a fabric or the like. A selection mechanism is embedded into the DPM which allows the DPM to identify body parts using the ECG signals of the different ECG sensors and select for each body part the best sensor lead. The DPM may then produce the standard ECG signal using the selected ECG signals for the different body parts detected. The system is adapted to continuously re-examine the selection to ensure that the best leads are selected for a given body part following a movement of the body part, thereby, allowing for continuous and un-interrupted ECG monitoring of the patient.

[0056] The present invention will be more readily understood by referring to the following examples which are given to illustrate the invention rather than to limit its scope.

[0057] Referring now to the drawings, Fig.1 is a block diagram of an exemplary ECG system 200 in accordance with an embodiment. As shown in Fig.1 the system 200 comprises an array of contactless sensors provided in a sensor pad 7 (in a non-limiting example of implementation), and a digital processing module (DPM) 2 which is operatively connected to the array of sensors using a cable 9 for obtaining sensor readings from the sensors provided in the pad 7. The DPM 2 may be configured to simultaneously record the electrophysiological activity of the heart (body surface potential map) as well as identify the best electrodes/sensors to output a standards ECG signal (+ posterior precordials) into existing medical equipment (6). The DPM may be connected to a mobile device (3) or the cloud (4) via the internet or a data network to make the data readily available for doctors and in real-time so that doctors can quickly diagnose arrhythmic and ischemic changes detected by the DPM 2.

[0058] In a non-limiting example, the DPM 2 may be provided as a lightweight portable medical device which weighs about 2lbs or less and may be carried around for performing the continuous ECG monitoring.

[0059] As stated above, the DPM 2 may be configured to produce an output signal which conforms to existing medical standards so that the output signal is identical to those that are acquired by a standard contact ECG system and may be viewed/read using existing medical equipment 6 in a plug and play manner (whereby no changes are to be made to the existing medical equipment to read and output the standard ECG signal received from the DPM). The DPM 2 may include a data output plug adapted to receive a standard cable (8) to output a signal that be simultaneously read using an existing medical equipment 6. The DPM 2 may also be able to simultaneously record contact ECG information if a standard trunk cable 5 is attached.

[0060] However, the DPM 2 may also have its own display device embedded in it or associated with it and may be adapted to send/stream the standard ECG signal via a communications/data network to make the standard ECG signal available on a local/remote personal computer or portable device.

[0061] It should be noted that Fig.1 illustrates a non-limiting example of implementation. Changes to the system 200 are possible without departing from the scope of the invention as defined in the claims. For example, although Fig.1 illustrates cables for communicating the data between different modules, it is also contemplated that wireless connections may be used including but not limited to: Wi-Fi, Bluetooth etc.

[0062] Furthermore, the sensor array may be in a variety of other objects including: clothing, beds, and vehicle devices/components. In another example, the sensor array may be provided in a plurality of devices including but not limited to: furniture (e.g. chair, bed/mattress/cover, sofa, seat, mattress), in-

vehicle devices (e.g. seat, headrest, steering wheel etc.), or in a wearable device (e.g. jacket, shirt, t-shirt, sweater, bra etc.).

Selection Algorithm

[0063] Traditional ECG dictates electrode locations that are based on physiology of the patient whereby traditional contact electrodes are adhered to these locations, maintaining relative body position regardless of the patient's movement. For example, the V1 electrode should be placed on the 4th intercostal space to the right of the sternum, the RA electrode should be placed on the right arm, the LA electrode on the same location as the RA electrode but on the left arm the RL electrode should be placed on the right leg, lateral calf muscle and so on.... as exemplified in Fig.11. The importance of these electrodes and their locations lies in the fact that the difference in voltage between two specific locations represents a medically defined ECG lead (as discussed with respect to Fig.11 and 12), and the lead in electrocardiography represents a vector along which the heart's depolarization is measured and recorded to produce the electrocardiogram.

[0064] Therefore in order to produce an ECG signal that is compatible with traditional ECG standards it is necessary to follow the same principle although data is being collected in a contactless manner.

[0065] Fig.2 illustrates a non-limiting example of a sensor matrix 202 in accordance with an embodiment. As shown in Fig.2 the matrix 202 comprises n columns and m rows of sensors 10 arranged in a matrix configuration such that no matter how the patient is placed on the matrix 202, there would always be at least one sensor at a location on the patient's body that corresponds to the physical placement of a conventional ECG electrode. Using an adaptive algorithm embedded in the DPM 2, the matrix 202 may be used for obtaining a continuous ECG reading by selecting a given sensor 10 from the matrix 202 which corresponds to a defined ECG location on the patient's body.

[0066] Fig.3 is a flowchart illustrating the main steps performed by the array algorithm 204, in accordance with an embodiment. At step 210 the algorithm detects which sensors 10 are in close proximity to the patient's body, by measuring the impedance between each sensor 10 and the patient. This allows for detecting the sensors 10 that can be used to obtain data from. ECG signals output by these sensors 10 (the ones determined to be in close proximity of the body) are then analyzed to obtain a body outline of the patient.

[0067] In a non-limiting example of implementation, the embodiments may use different types of information to obtain the body outline. The first type is the coupling impedance which represents the distance between the body and the sensor. When the coupling impedance is too high, the sensor is too far from the body and cannot be used. The second type is the signal itself e.g. morphology of the signal and how the signal looks like to see whether the signal has the usual ECG pattern or not (PQRSTU waveforms). The third type of information relates to the geometrical locations of the ECG sensors providing good ECG signals. These sensors and their location provide an indication on the geometrical shape of the human body as exemplified in Figs.13a and 13b. in the example of Fig.13a, assuming that a user 250 is laying down on a mattress having the sensor pad 202 embedded therein, the sensors 10a that are in proximity of the patient's body will obtain a good ECG signals while the sensors 10b outside of the patient's body will not obtain a good signal. Based on this information and the location of each sensor on the pad 202, the DPM 2 may obtain an outline 252 of the patient's body from which the DPM may determine the shape, width and other dimensions of the patient's body as exemplified in Figure 13b. Using this information and a set of rules embedded in the DPM 2, the DPM 2 may then detect/determine locations of body parts and associate one or more sensors 10 with each body part/body location for ECG purposes as discussed below.

[0068] At step 212 the algorithm analyses the ECG signal received from the sensors and combines it with the body outline already detected to find the

position of the patient's body on the pad. At step 214 the algorithms performs a mapping of where on the body each sensor 10 is located using the information obtained from steps 210 and 212. Once groups of sensors are found to be near each major body part for ECG purposes (Right Arm, Left Arm, etc.), the signals from those adjacent sensors are compared and filtered at step 216 to select a single sensor with the best ECG signal to receive and record therefrom ECG data for that respective body part.

[0069] In an embodiment, the DPM 2 may be adapted to run the algorithm 204 continuously and dynamically in order to re-examine the readings obtained from the sensors 10 in real time to re-verify the selection of the sensor 10 having the best ECG reading to constantly take into consideration the patient's movement whereby a new sensor 10 may be selected which provides a better reading than the one previously selected before the movement.

[0070] In another embodiment, the system may detect when a patient moves and determines when it is necessary to run the algorithm again to recalculate whether or not a new selection needs to be made. For example, the system may monitor the signal's strength/quality and determine to re-run the selection algorithm 204 when the signal quality drops below a given threshold.

Detection of PQRSTU waveforms

[0071] As discussed above, the system may be configured to record cardiac electrophysiological activity and ECG. Specifically, the system may be designed to acquire the full PQRSTU spectrum constituent ECG waveforms as exemplified in Fig.4 which illustrates an example of a full PQRSTU waveform obtained for a patient using a system in accordance with an embodiment. The PQRSTU waveforms illustrated in Fig.4 are generated by the heart and captured by the system to be viewed by doctors for diagnosis. In an embodiment, the system captures the ECG readings and processes them to produce ECG signals that may be read and viewed using existing medical equipment and produces

waveforms that are identical to those produced by standard contact ECG systems, and as such can be used in place of standard ECG systems for all applications.

[0072] Needless to say, the contactless sensors 10 do not produce an output that is compatible with existing medical equipment's (e.g. monitors and the like) and therefore cannot interface with these equipment, hence the need for further processing. In an embodiment, the DPM converts the acquired signal into a format that complies with the international standards for existing medical equipment. This allows for a seamless replacement of conventional contact ECG systems without the need to replace existing diagnostic medical devices or re-train doctors and medical professionals. Such conversion may be performed in the DPM 2 using a combination of digital signal processing and analog output circuitry in the Digital to Analog Converter stage (19).

Sensor Design

[0073] As discussed above, the embodiments obtain ECG readings of the patient using contactless ECG sensors 10. The sensors 10 are specifically designed to capture high quality ECG from a patient without requiring direct electrical contact with the patient's skin. This allows to place the sensors 10 at some distance from the patient and/or to be separated from the patient's skin by a fabric such as clothing, bedding, etc. as exemplified in Fig.5 which illustrates an example of how the sensor array captures ECG signals without direct contact with the patient's skin.

[0074] Fig.6 is a block diagram illustrating an exemplary sensor design in accordance with an embodiment. As shown in Fig.6 the sensor 10 may include a conductive electrode 33, an electrode shield 32, and an electrodynamic sensor including an amplifier 34 and a bias circuit 35 voltage. In the exemplary design of Fig.6, the gain / current buffering amplifier 34 may be used in a type of negative feedback topology, and the input bias network 35 is adapted to increase the

effective input impedance of the amplifier 34, to preserve the signal quality of the acquired ECG. The input of the electrodynamic sensor is connected to the conductive electrode 33. A shield driving circuitry (36) may be employed to generate a feedback signal to connect to the electrode shield (32) to further increase the signal to noise (SNR) ratio by reducing parasitic capacitance seen at the input of the electrodynamic sensor.

[0075] The electrode 33 may be capacitively coupled to the patient's body by being in proximity to, but not touching the skin/body. This can be accomplished by laying on a bed with an array of sensors 10 embedded in it (as non-limiting example of implementation), while clothed. The electric field near the surface of the patient's skin that is created from the electrical activity of the heart capacitively induces a charge on the conductive electrode 33 without direct electrical contact. This charge may then be collected and amplified by the electrodynamic sensor, which produces an electrical signal (voltage) that is representative of the electrical activity of the heart in that location (complete PQRSTU).

[0076] The electrode shield 32 is configured to reduce the amount of stray interference that the electrodynamic sensor receives and also decrease the effective capacitance of the input of the amplifier 34, which helps to preserve signal quality of the acquired ECG.

[0077] In a non-limiting example of implementation, both the electrode 33 and the electrode shield 32 may be made of an elastic/flexible material which allows the sensor 10 to better adapt to the geometry of the human body and obtain better ECG readings. At the same time this configuration allows the sensors 10 to be seamlessly provided in the fabric (or any of the following: gel/silicone/rubber type pad/mat etc.) in which the sensor array is to be placed.

[0078] Fig.7 illustrates an example of a physical design of the sensor 10. As exemplified in Fig.7, the physical design includes the conductive electrode 33

physically implemented as a layer 39, the shield 32 physically implemented as the layer 40, and the remaining of the circuitry embedded in the layer 41. The entire structure may be produced on a substrate 37 which may also be a printed circuit board, for example. In the design illustrated in Fig.7, the layers 39, 40 and 41 may be insulated from each other by dielectric layers 38 to provide electrical insulation.

[0079] Fig.8 illustrates an exemplary block diagram of an overall design of a system in accordance with an embodiment.

[0080] Referring to Fig.8, and as discussed above with respect to Fig.1, the system may include a sensor pad 7 comprising contactless ECG sensors (hereinafter CECG sensors 10) which may be provided in the form of an array 202 such as that shown in Fig.2. The sensor pad 7 may also include a grounding pad 15, a driving circuitry e.g. a right leg drive (RLD) generator 14 (discussed below), and an A/D converter 13. The sensor pad 7 outputs the digitized ECG readings of the sensors 10 to the DPM 2. The RLD generator 14 is configured to feed the grounding pad 15 with a high frequency signal that is outside of the ECG frequency band. This high frequency signal is then coupled through the patient's body to the CECG sensors, where the amplitude is recorded and analyzed by the DPM 2. This gives the system a metric of how well-coupled each sensor is to the patient, effectively an impedance measurement to determine what the signal quality is from each sensor.

[0081] In addition to the digitized CECG sensor data, the DPM 2 may also be configured to receive standard ECG data of conventional electrodes in an analog format. Such analog ECG data is optionally acquired through the use of standard contact electrodes and a trunk cable (5). The analog signals may be converted using an ADC 17. The signals may then be filtered using a digital signal processing unit 18, and output over a variety of wired and wireless interfaces (Wi-Fi (22) / Ethernet (23) to a mobile app (3) / cloud server (4) and

through the 'Analog CECG & ECG out' interface to existing medical equipment (6)).

[0082] The DPM 2 may include some sort of non-volatile memory e.g. flash memory 26 for storage of ECG data (if necessary). The DPM 2 may also be configured to perform diagnosis for acute issues, and send a warning over any one of the communication interfaces or an integrated sound alarm (24). The DPM 2 may also include a Bluetooth Low Energy interface (21) to enable configuration by the user through a mobile device. A Read Only Memory (25) may also be included to store a unique identifier. A Cryptographic processing module (27) may also be used to encrypt and decrypt data transmitted/received through the communication interfaces, and securely stores keys for this data encryption.

[0083] All sensor data (contactless and contact) can be sent over the wired and wireless interfaces. The array algorithm 204 (discussed above in Fig.3) decides which sensor information should be output over the analog interface 19 to existing medical equipment. A relay 20 may be provided to switch between the analog data received from the conventional electrodes and the contactless sensors 10 and to allow the DPM 2 to compare between the two. In DPM 2 can be configured to be turned off to act like a pass-through cable, without affecting the contact ECG signal if desired (controlled by the Processing Unit and Relays (20)). It can also be used in 'hybrid mode', during which a combination of CECG and ECG sensors can be output over the analog interface, if it improves the quality of the ECG signal.

Automatic gain correction

[0084] Due to the large, yet finite, input impedance of the electrophysiological sensors 10, variations in the capacitive coupling between each sensor 10 and the patient's body (e.g. changes in the distance between

each sensor and the body) can cause variations in the gain of each sensor channel. This has the effect of affecting the amplitude of ECG leads, in the same way that a dried out contact adhesive electrode produces a lower quality signal than a new one. To address the problem, a gain control mechanism is provided which allows the system to control relative impedance differences between different contactless ECG sensors, and an absolute impedance between each contactless ECG sensor and the human body due to a difference in distance between each contactless ECG sensor and the human body. As shown in Fig.9, a programmable gain amplifier 43 (either in the analog or digital domains) may be provided on each sensor channel 42 to offset the change in gain caused by differences in coupling between the sensors 10 and the patient. Fig.9 is a block diagram illustrating an exemplary gain control mechanism in accordance with an embodiment. As shown in Fig. 9, the gain control mechanism 220 may include a feedback loop including an ADC 44 coupled between the PGA 43 and a processor 45 which itself is connected to the PGA 43 to control its gain in real-time as the change is occurring.

[0085] The processor 45 may be a dedicated processor and may also be a processor module embedded into the processing unit 18 of the DPM 2.

Right Leg Drive

[0086] Referring back to Fig.8, a grounding pad 15 is shown which in operation should be placed near, but not in contact with (at a distance), the patient's body. This pad is driven with a feedback signal derived from the ECG signals to provide a capacitively coupled ground reference to the patient's body. The feedback signal is derived in such a way to increase the common mode rejection ratio (CMRR) of the system (by over 10dB, typically). This reduces interference from common mode signals and preserves the signal quality of the acquired ECG.

[0087] Fig.10 is an exemplary block diagram illustrating the function of the RLD generator 14, in accordance with an embodiment. As shown in Fig.10, data received from the sensors is selected (or discarded) using a switching matrix (29) which selects specific sensors 10 to obtain data from using an RLD algorithm implemented digitally in the processing unit (18). The signals are then summed (29), inverted and amplified (30). This constitutes the driving signal for the grounding pad 15.

[0088] The RLD algorithm is configured to monitor the common mode signal acquired from each sensor (and by extension, the ECG signals output from selection algorithm). The RLD algorithm may select the set of sensors that increases the common mode rejection ratio of the system after the RLD signal is applied to the patient in the feedback configuration.

Acquired Leads

[0089] As discussed above, the ability to compare a current ECG to an old one is of an immense medical value and this is not possible with existing systems which do not allow for long term monitoring. For example, an abnormal ECG does not prove acute cardiac disease, and a normal ECG does not exclude cardiac disease. It is therefore necessary to compare new ECG with ECG's made in the past. Hallmarks may include

- Is there a change in rhythm?
- Is there a change in frequency?
- Is there a change in conduction time?
- Is there a change in heart axis?
- Are there new pathological Q's?
- Is there a change in R wave size?
- Is there a change in ST?

- Is there a change in T wave?

[0090] The above changes immediately result in further investigations. Changes in the electrocardiogram can be further classified as acute and chronic, however, both require comparison electrocardiograms.

[0091] In general, as the number of electrodes used increases, the monitoring time that is possible decreases. Currently, one major limitation of the current standards is the difficulty in obtaining long term monitoring with multiple electrodes due to the inherent limitation of placing multiple electrodes and maintaining them on the body.

[0092] The system described above allows for serial comparison of electrocardiograms for the first time. The system has proven to acquire posterior ECG leads. According to a modified Mason-Likar lead system, a 16 lead ECG can be acquired from the patient laying on the matrix of sensors, embedded in a mattress, chair, etc,. The acquired leads include: Leads I, II, III, aVr, aVl, aVf, V1, V1R, V2, V2R, V3, V3R, V4, V4R, V5, V5R as exemplified in Fig.11 and Fig.12. Fig.11 shows medically recognized ECG locations for obtaining standard ECG leads, and Fig.12 illustrates an example of standard ECG leads, each lead being shown as a vector between two locations on the human body.

[0093] The pad including the sensors 10 can be placed, unperceivably under a mattress so that ECG data can be acquired from posterior leads; e.g. the prone position. The system may be based on the Mason-Likar sensor placement used for the acquisition of the ECG during stress testing. Standard 12 lead ECG placement is not used because of myopotentials, motion, artifacts, etc. and is limited to the 10 second 12 lead ECG printout and is not practical for short to long term monitoring.

[0094] Posterior placed electrodes are an accepted method of ECG acquisition, and indeed are used as an adjunct in certain situations to the more commonly used method of anterior lead placements. Anterior lead placement is

currently the only type of lead placement used because of convenience. However, prone position ECG leads are performed in certain situations with standard electrodes, but because of the inherent difficulties, is not a standard.

[0095] Fig.14 is a flowchart of a method for providing electrocardiogram (ECG) signals for a human body using contactless ECG sensors. As shown in Fig.14, the method 260 begins at step 262 by receiving contactless ECG signals from an array of contactless ECG sensors. Step 264 comprises detecting body parts located in proximity of the array of contactless ECG sensors. Step 266 comprises selecting from each group a contactless ECG sensor having a highest signal quality. Step 268 comprises producing a standard ECG signal based on the contactless ECG signal of each selected contactless ECG sensor.

[0096] While preferred embodiments have been described above and illustrated in the accompanying drawings, it will be evident to those skilled in the art that modifications may be made without departing from this disclosure. Such modifications are considered as possible variants comprised in the scope of the disclosure.

CLAIMS:

1. A medical apparatus for providing electrocardiogram (ECG) signals for a human body using contactless ECG sensors, the medical apparatus comprising:
 - an input adapted to receive contactless ECG signals from an array of contactless ECG sensors;
 - a processor adapted to perform a selection process including:
 - o detecting body parts located in proximity of the array of contactless ECG sensors;
 - o associating a group of contactless ECG sensors with each detected body part;
 - o selecting from each group a contactless ECG sensor having a highest signal quality;the processor being adapted to produce a standard ECG signal based on the received contactless ECG signal of each selected contactless ECG sensor; and
 - an output for sending the standard ECG signal for viewing/storage.

2. The medical apparatus of claim 1, wherein the selection process further comprises the steps of:
 - a. obtaining a body outline of the human body using the contactless ECG signals associated with the contactless ECG sensors located in proximity of the human body;
 - b. determining a position of the human body on the array of contactless ECG sensors;
 - c. dividing the contactless ECG sensors into groups and associating each group to a body part using the body outline and the position of the human body;

- d. from each group, selecting the contactless ECG sensor providing the contactless ECG signal having the highest quality.
3. The medical apparatus of claim 2, wherein the processor identifies the contactless ECG sensors that are located in close proximity to the human body by measuring an impedance between each contactless ECG sensor and the human body.
4. The medical apparatus of claim 1, wherein the medical apparatus is adapted to select another contactless ECG sensor for a given body part following a movement of the human body with respect to the array of contactless ECG sensors.
5. The medical apparatus of claim 4, wherein the processor is adapted to re-run the selection process continuously to perform the selection of the other contactless ECG sensor.
6. The medical apparatus of claim 4, wherein the processor is adapted to continuously monitor a signal quality of the selected contactless ECG sensor associated with each body part to re-run the selection process when the signal quality drops beyond a given threshold.
7. The medical apparatus of claim 1, wherein the medical apparatus comprises different operation modes comprising:
 - a contactless mode which outputs a first standard ECG signal resulting from the contactless ECG signals;
 - a hybrid mode which outputs a second standard ECG signal resulting from the contactless ECG signals and conventional ECG signals received from conventional contact electrodes; and

- a bypass mode which outputs a third standard ECG signal resulting from conventional ECG signals received from conventional contact electrodes.

8. The medical apparatus of claim 1, further comprising an automatic gain control mechanism adapted to control relative impedance differences between different contactless ECG sensors, and an absolute impedance between each contactless ECG sensor and the human body due to a difference in distance or type of clothing material between each contactless ECG sensor and the human body.

9. The medical apparatus of claim 1, further comprising a wired/wireless data port for transmitting the standard ECG signal to a remote device over a data network.

10. A system for providing electrocardiogram (ECG) signals for a human body using contactless ECG sensors, the system comprising:

- a sensor pad comprising an array of contactless ECG sensors;
- a processor operatively connected to the sensor pad and adapted to receive contactless ECG signals from the contactless ECG sensors and perform a selection process including:
 - o detecting body parts located in proximity of the array of contactless ECG sensors;
 - o associating a group of contactless ECG sensors with each detected body part;
 - o selecting from each group a contactless ECG sensor having a highest signal quality;

the processor being adapted to produce a standard ECG signal based on the contactless ECG signal of each selected contactless ECG sensor; and

- an output for outputting the standard ECG signal for viewing/storage.

11. The system of claim 10, wherein the sensor pad comprises a grounding pad for placing in proximity of and at distance from the human body, the grounding pad being adapted to provide a capacitively coupled ground reference to the human body for reducing interference.

12. The system of claim 11, wherein the grounding pad is driven with a feedback signal derived from the contactless ECG signals.

13. The system of claim 11, further comprising a drive signal generator configured to feed the grounding pad with a high frequency signal that is outside of an ECG frequency band for determining the capacitively coupled ground reference for each contactless ECG sensor.

14. The system of claim 10, wherein the contactless ECG sensor comprises:

- a capacitive electrode adapted to be capacitively coupled to the human body for outputting an electrical charge which is representative of an electrical cardiac activity;
- an electrodynamic sensor configured to detect and amplify the electrical charge produced by the capacitive electrode; and
- an electrode shield physically provided in proximity of the electrode for reducing a stray interference at an input of the electrodynamic sensor.

15. The system of claim 14, wherein the contactless ECG sensor is made of a flexible material.

16. The system of claim 14, wherein the sensor pad is provided in a fabric with which the human body comes in contact or in one of: a gel, silicone, a rubber type pad, and a mat.

17. A method for providing electrocardiogram (ECG) signals for a human body using contactless ECG sensors, the method comprising:

- receiving contactless ECG signals from an array of contactless ECG sensors;
- detecting body parts located in proximity of the array of contactless ECG sensors;
- associating a group of contactless ECG sensors with each detected body part;
- selecting from each group a contactless ECG sensor having a highest signal quality;
- producing and outputting a standard ECG signal based on the contactless ECG signal of each selected contactless ECG sensor.

18. The method of claim 17, further comprising:

- obtaining a body outline of the human body using the contactless ECG signals associated with the contactless ECG sensors located in proximity of the human body;
- determining a position of the human body on the array of contactless ECG sensors;
- dividing the contactless ECG sensors into groups and associate each group to a body part using the body outline and the position of the human body;
- from each group, selecting the contactless ECG sensor providing the contactless ECG signal having the highest quality.

19. The method of claim 18, further comprising identifying the contactless ECG sensors that are located in close proximity to the human body by measuring an impedance between each contactless ECG sensor and the human body.

20. The method of claim 17, further comprising: repeating the steps of detecting to selecting continuously for selecting another contactless ECG sensor for a given body part following a movement of the human body with respect to the array of contactless ECG sensors.

21. The method of claim 17, further comprising continuously monitoring a signal quality of the selected contactless ECG sensor associated with each body part and repeating the steps of detecting to selecting for selecting another contactless ECG sensor for a given body part when the signal quality drops beyond a given threshold following a movement of the human body with respect to the array of contactless ECG sensors.

22. The method of claim 17, further comprising controlling relative impedance differences between different contactless ECG sensors, and an absolute impedance between each contactless ECG sensor and the human body due to a difference in distance or a type of clothing material between each contactless ECG sensor and the human body.

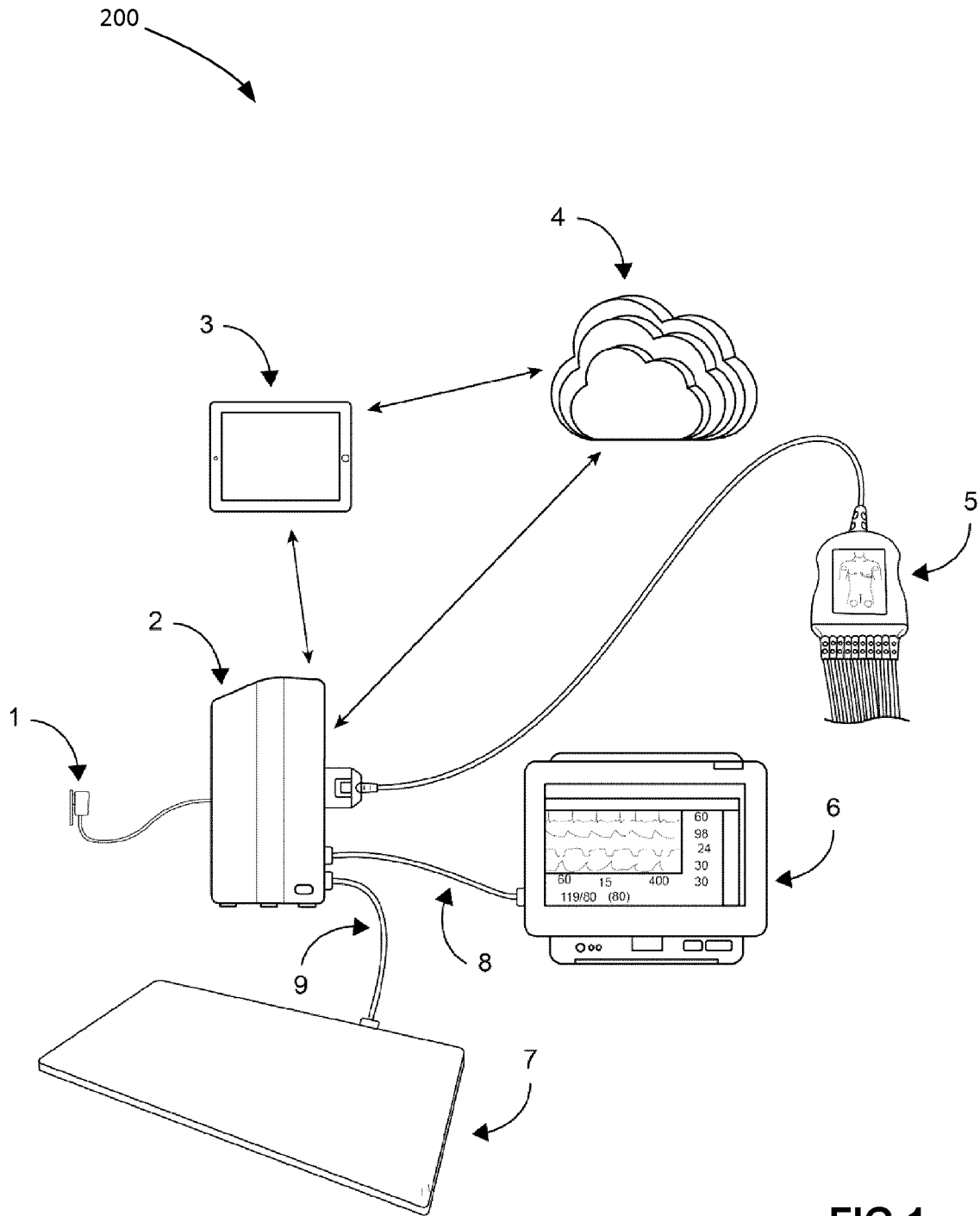

FIG.1

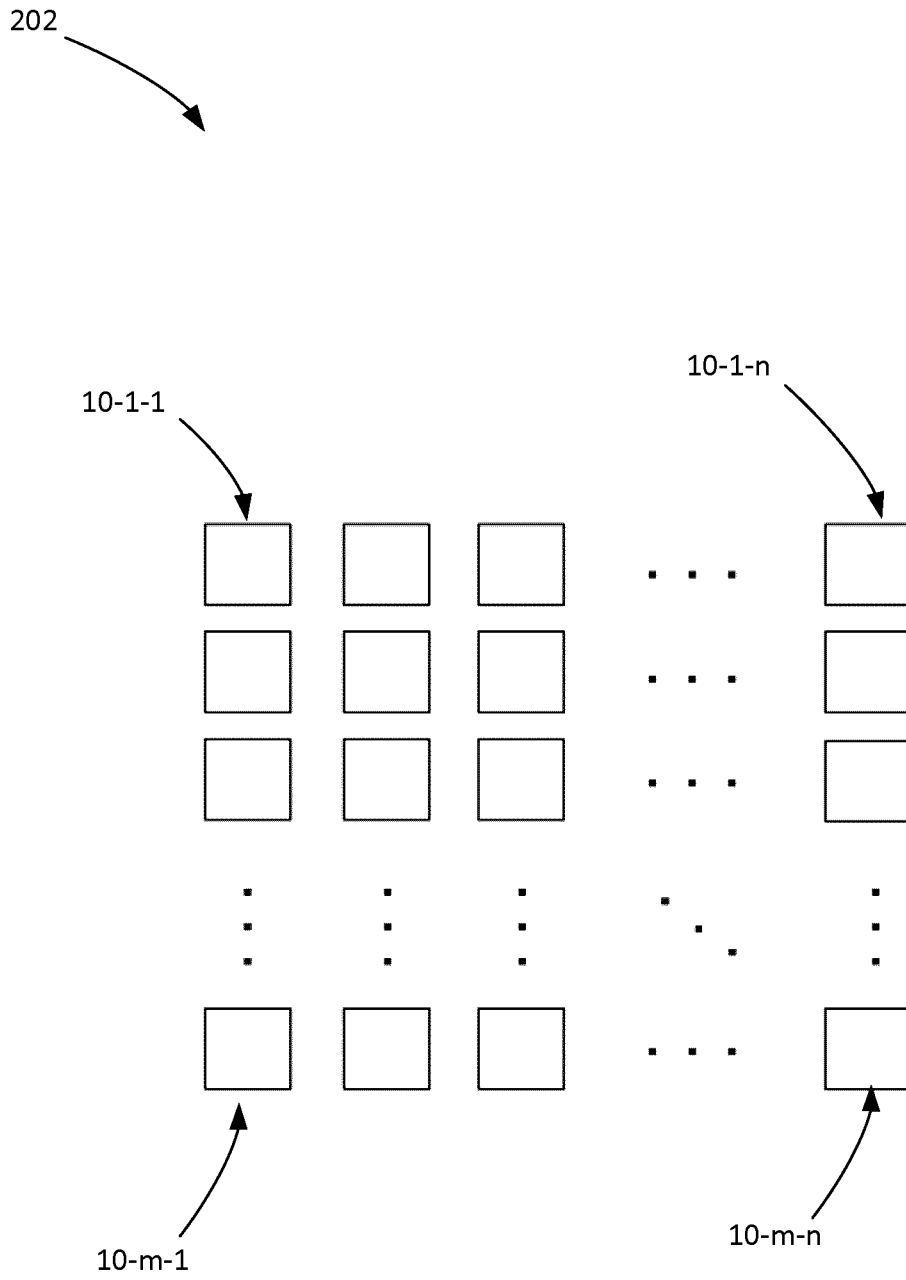

FIG.2

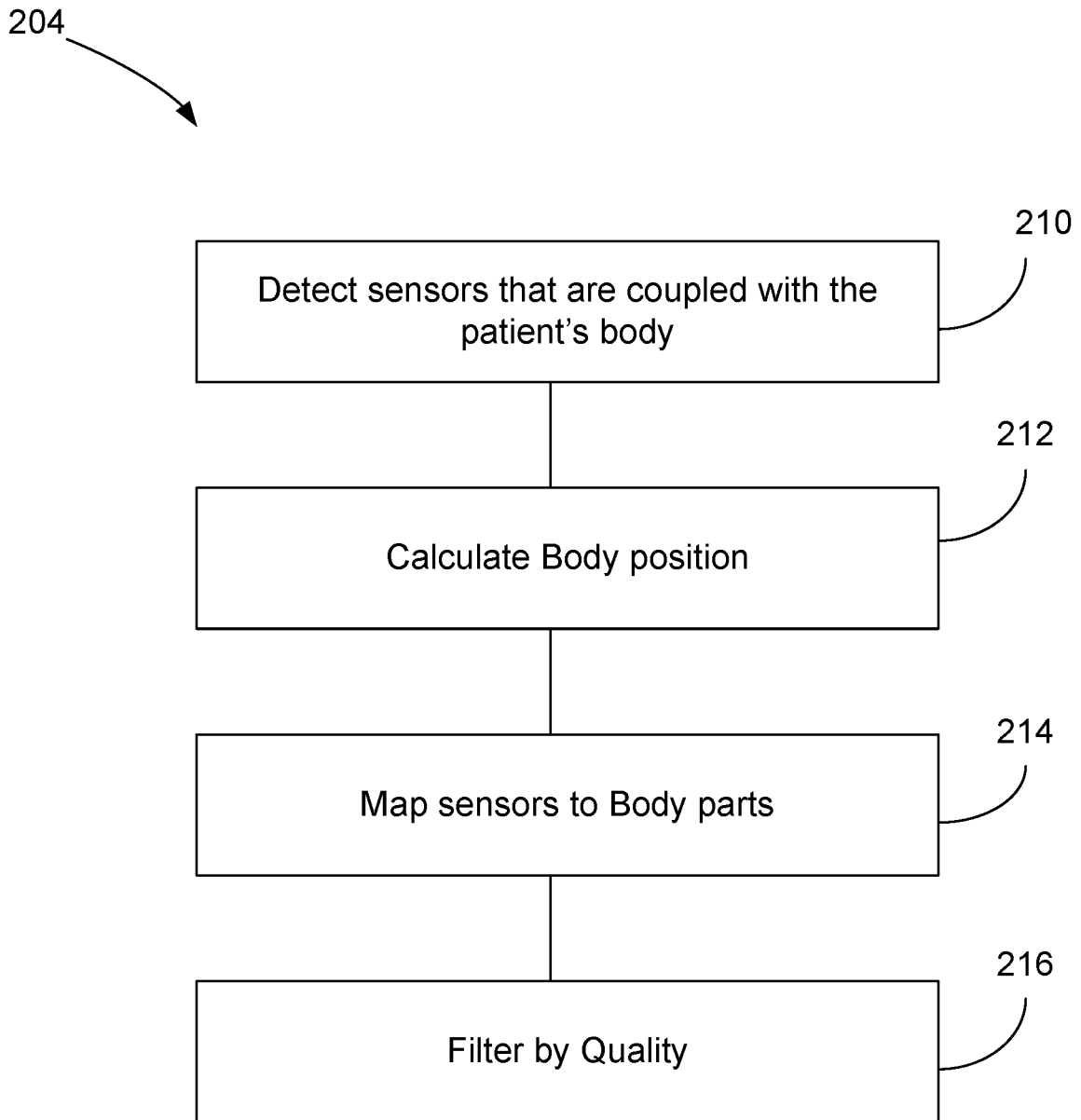

FIG.3

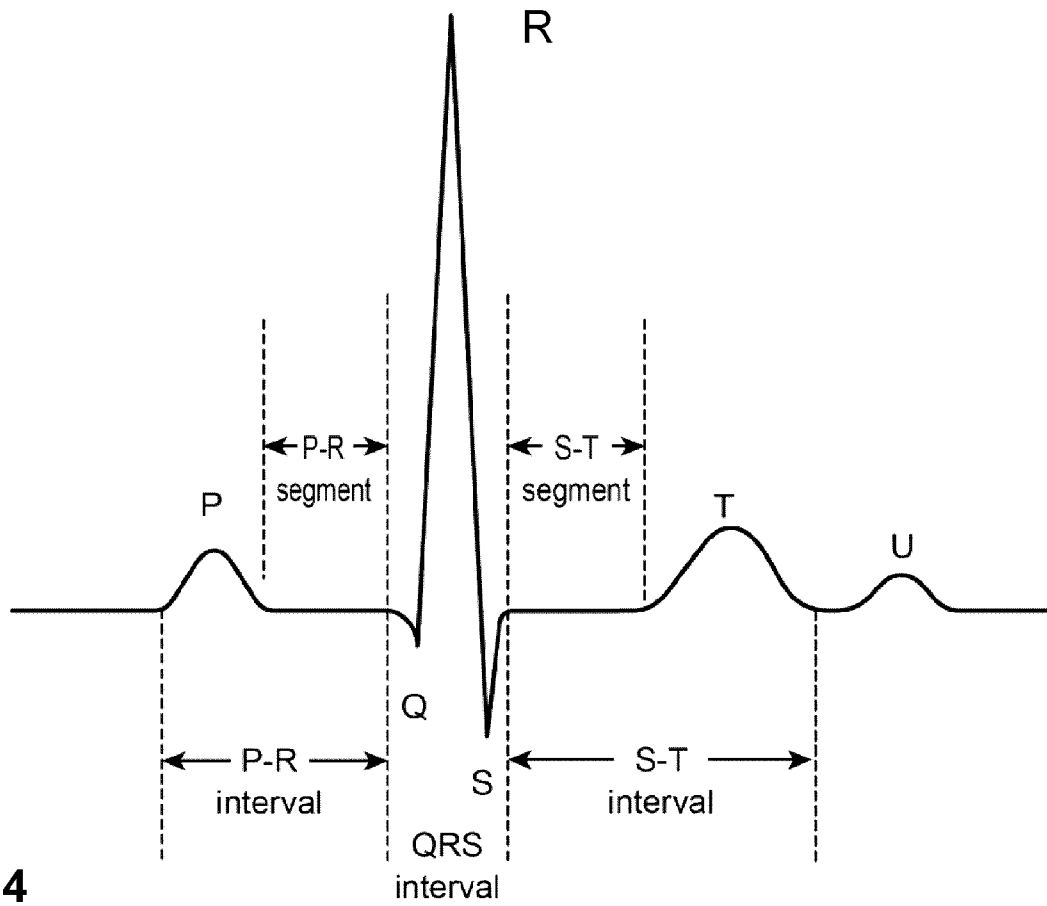

FIG.4

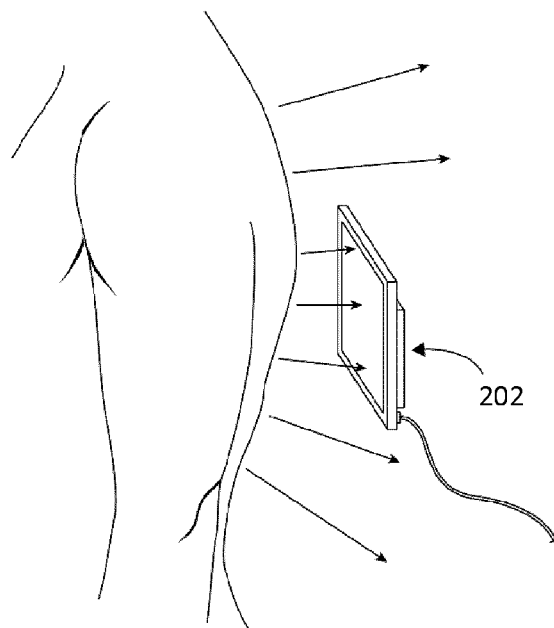

FIG.5

10

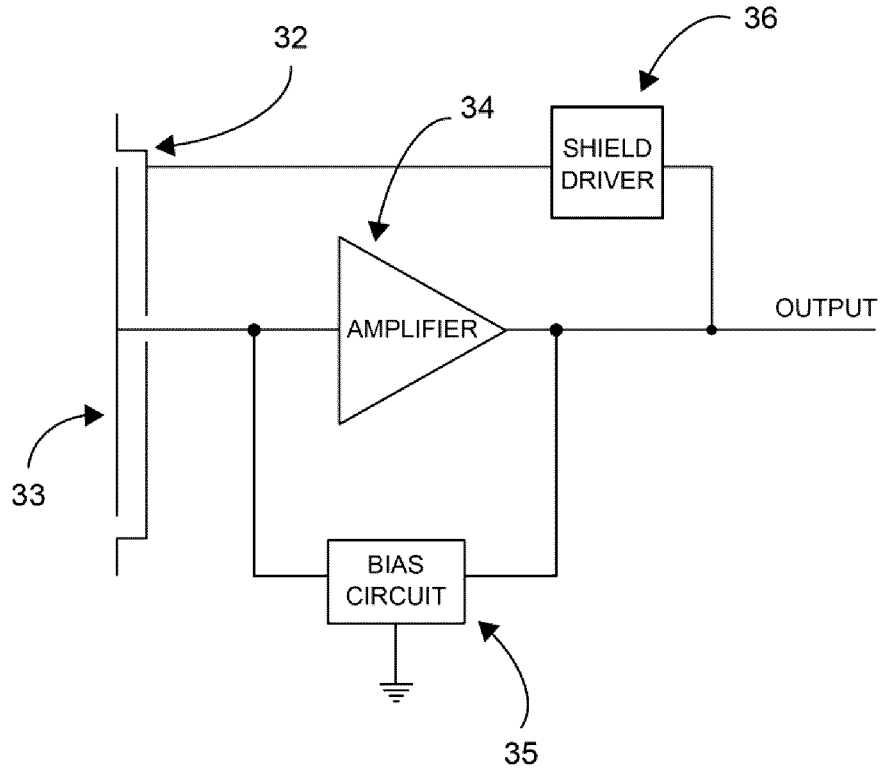

FIG.6

10

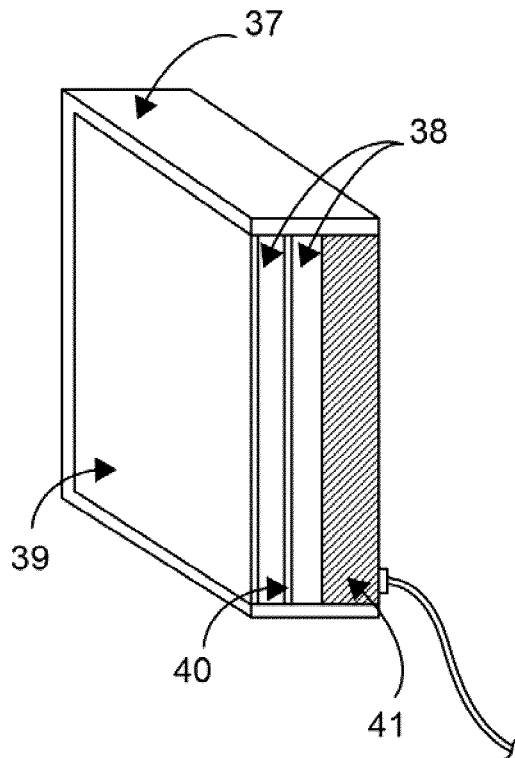

FIG.7

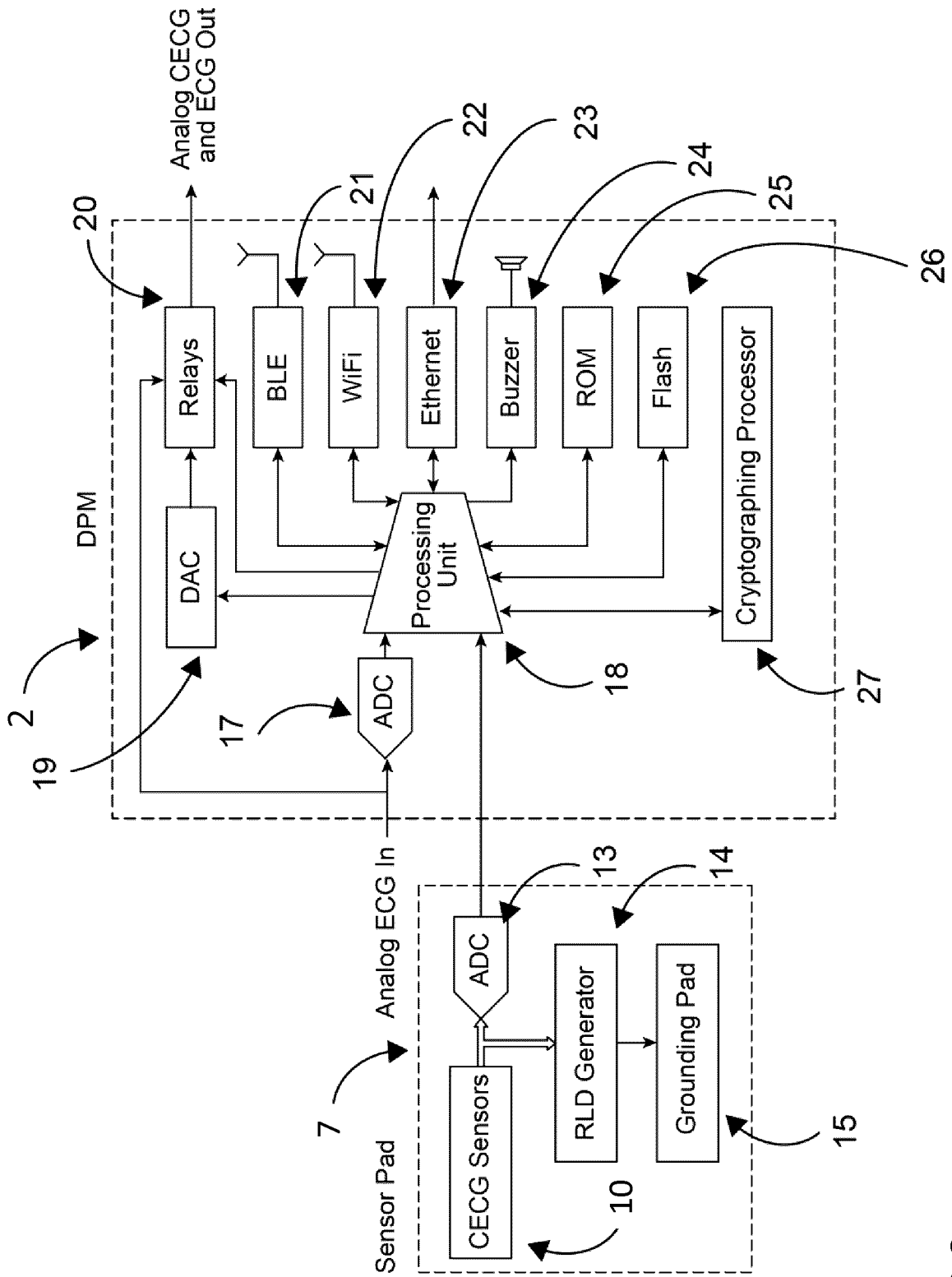

FIG.8

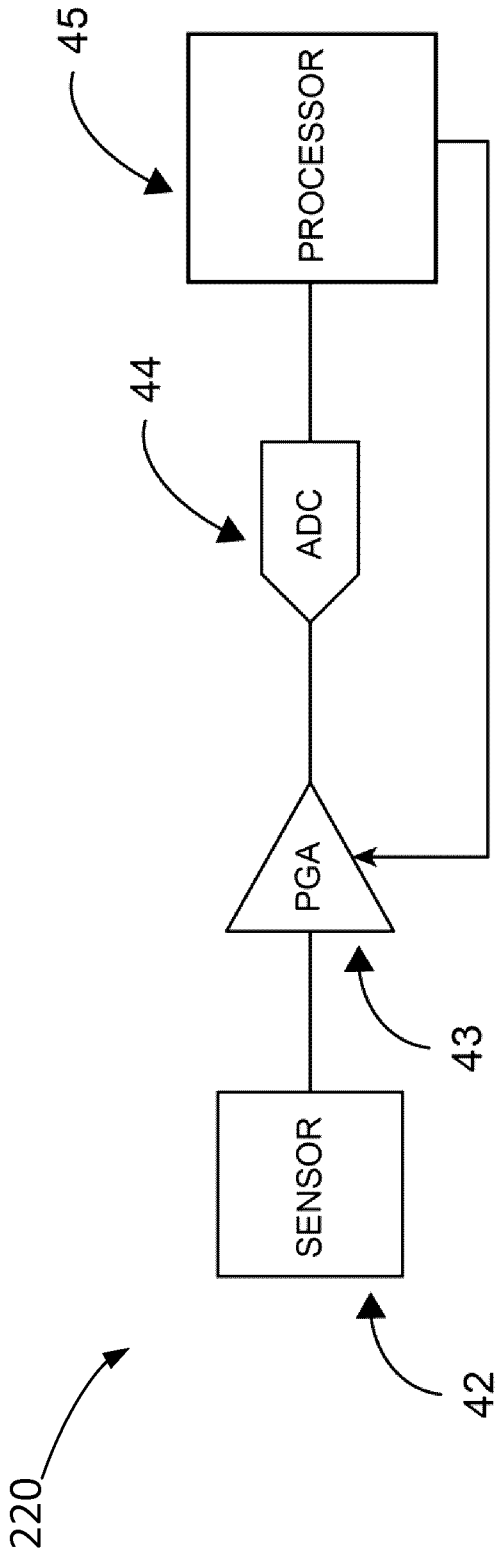

FIG.9

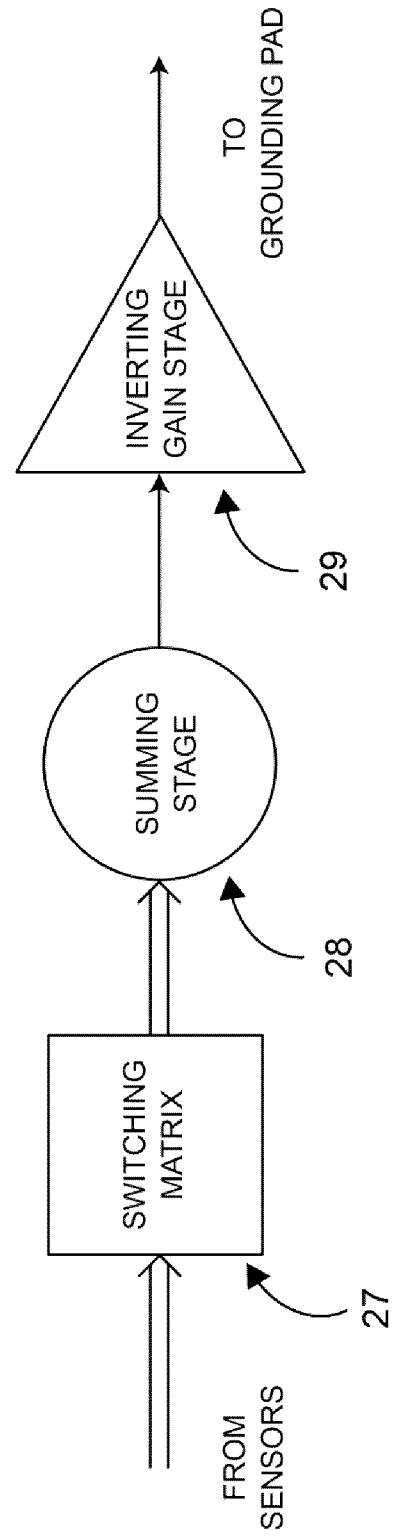

FIG.10

FIG.11

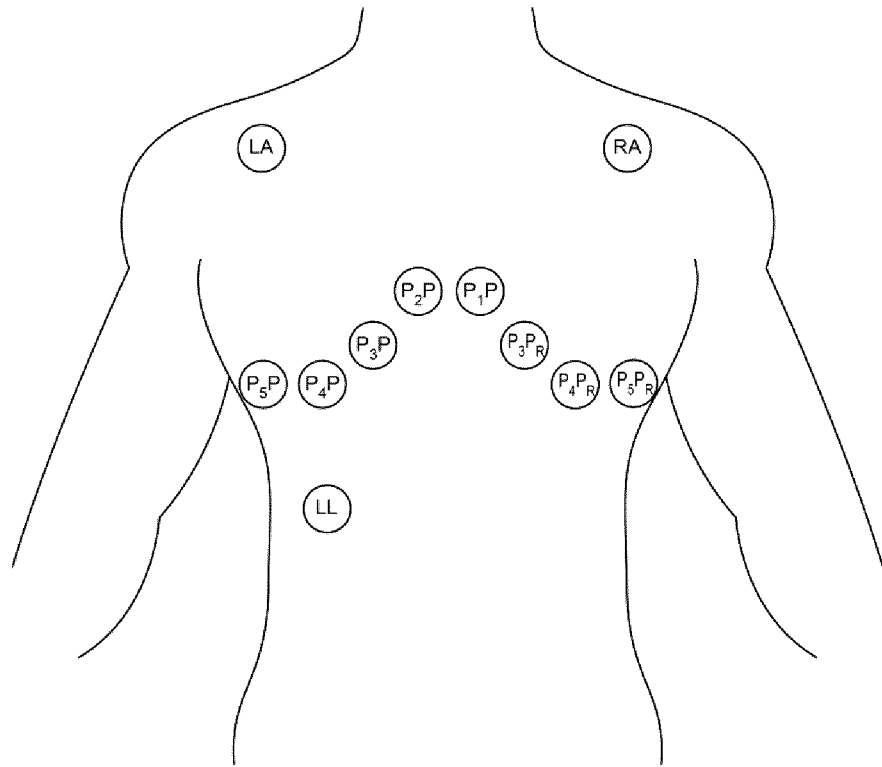
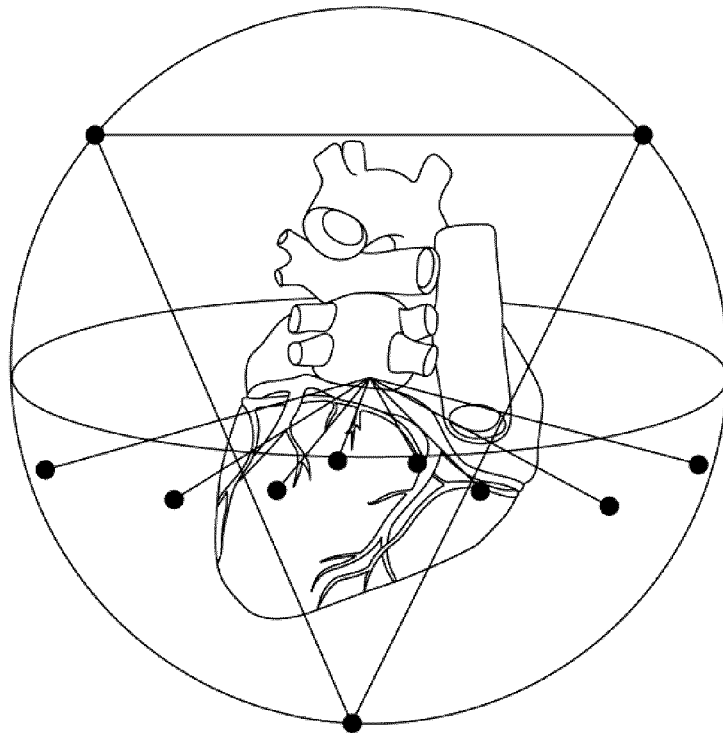

FIG.12



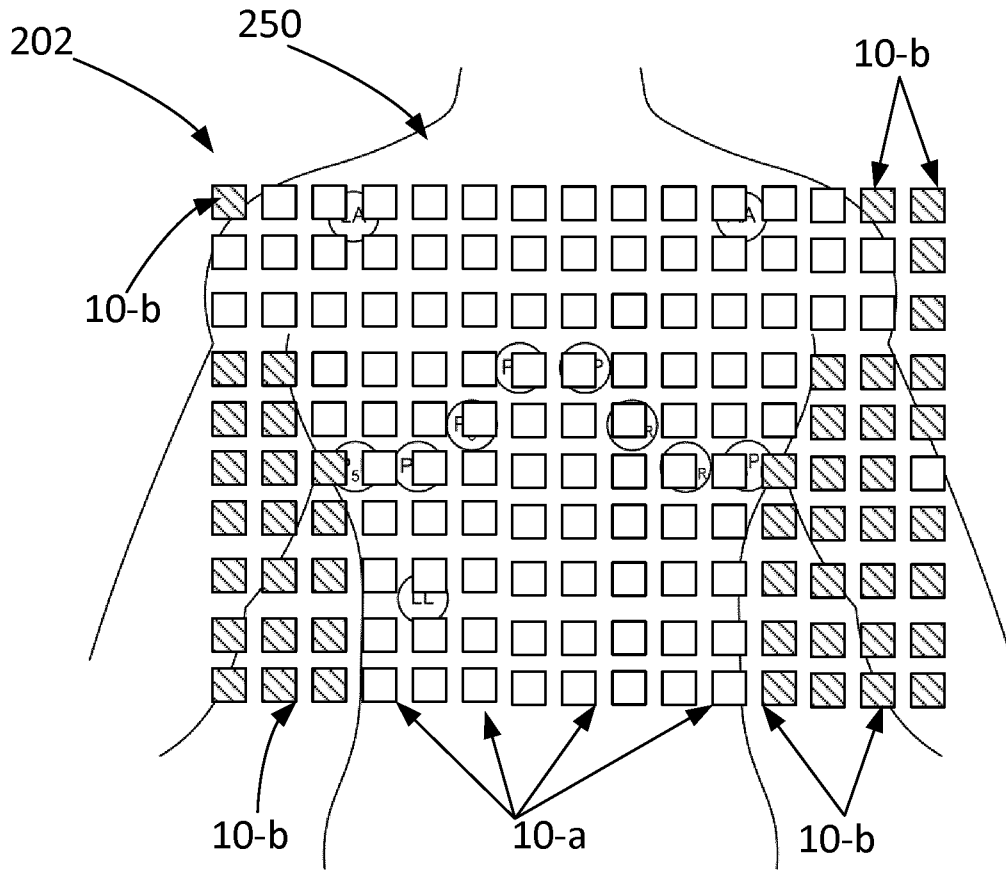

FIG.13a

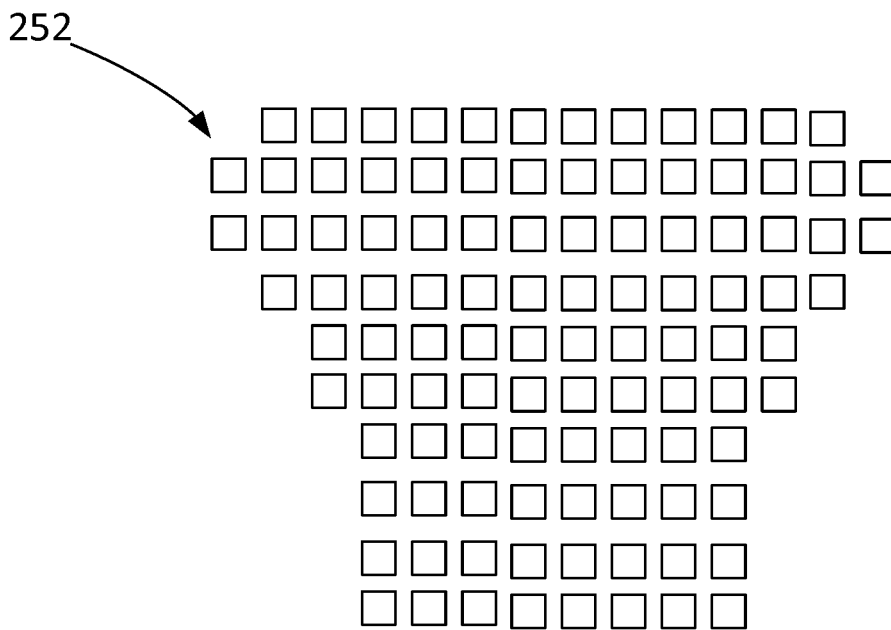

FIG.13b

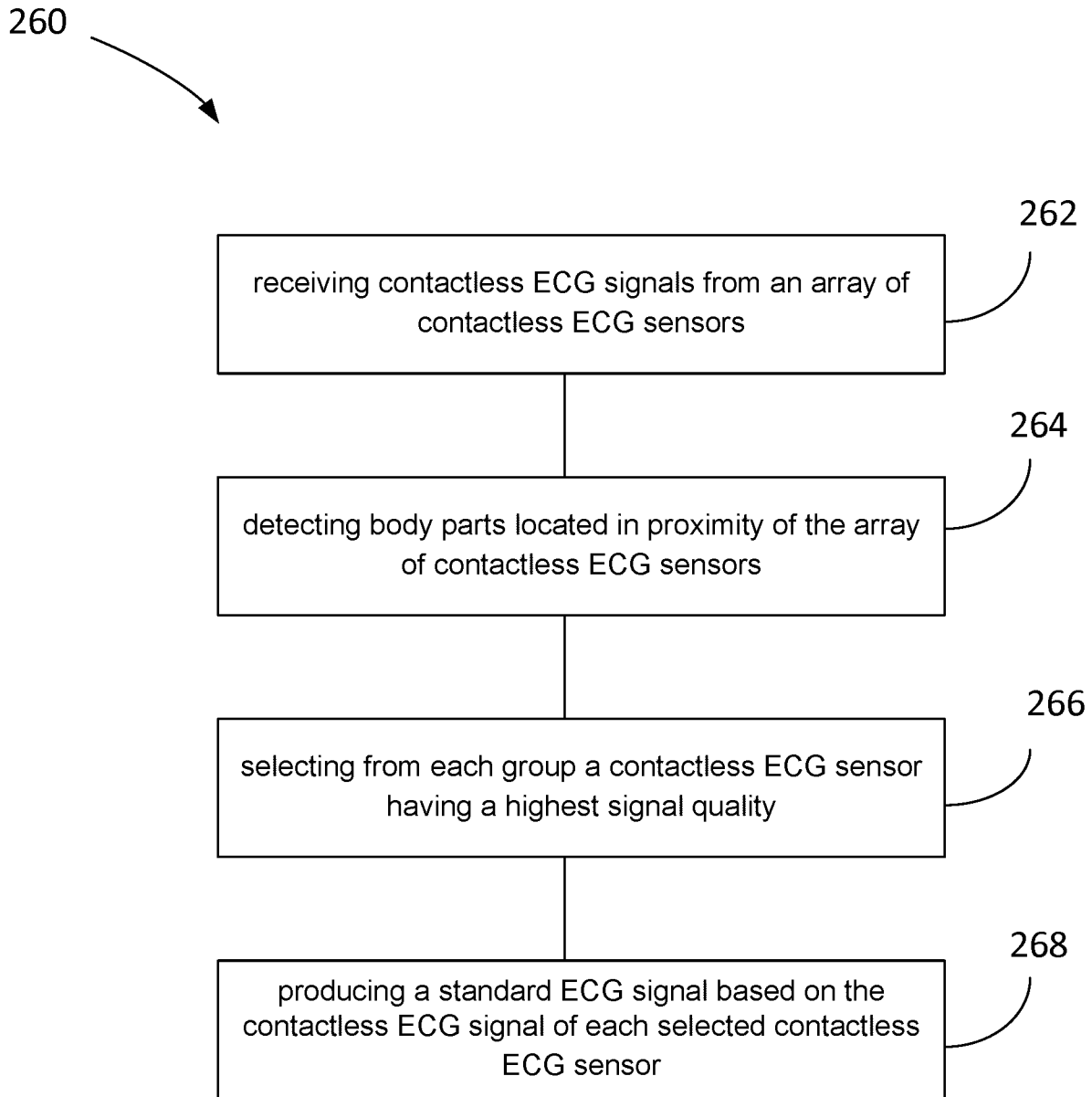

FIG.14

INTERNATIONAL SEARCH REPORT

International application No.

PCT/CA2015/050938

A. CLASSIFICATION OF SUBJECT MATTER

IPC: *A61B 5/0428* (2006.01), *A61B 5/0402* (2006.01)

According to International Patent Classification (IPC) or to both national classification and IPC

B. FIELDS SEARCHED

Minimum documentation searched (classification system followed by classification symbols)

IPCs/CPCs: A61B-05/0428 and A61B-05/0402

Documentation searched other than minimum documentation to the extent that such documents are included in the fields searched

Electronic database(s) consulted during the international search (name of database(s) and, where practicable, search terms used)

Canadian Patent Database and Questel Orbit.com (PlusPat - Biblio, FamPat - Biblio and Full Text, and/or Full Text Databases) - Search terms used: array of ECG sensor, array of contactless ECG sensor, array of sensor, electrocardiogram signal, electrocardiogram, ECG, contactless, sensor, array, signal, quality, human, body, bodies, part

C. DOCUMENTS CONSIDERED TO BE RELEVANT

Category*	Citation of document, with indication, where appropriate, of the relevant passages	Relevant to claim No.
P,Y	US 2015/0094603 A1 (EILEBRECHT) 02 April 2015 (02-04-2015) Whole document	1 to 22
P,Y	US 2015/0054495 A1 (LEM et al.) 26 February 2015 (26-02-2015) Whole document	1 to 22
A	US 8,792,957 B2 (GREENE et al.) 29 July 2014 (29-07-2014) Whole document	1 to 22
A	KR 10-1227413 B1 (KIM) 12 February 2013 (12-02-2013) Whole document	1 to 22

 Further documents are listed in the continuation of Box C. See patent family annex.

* Special categories of cited documents:	
"A" document defining the general state of the art which is not considered to be of particular relevance	"T" later document published after the international filing date or priority date and not in conflict with the application but cited to understand the principle or theory underlying the invention
"E" earlier application or patent but published on or after the international filing date	"X" document of particular relevance; the claimed invention cannot be considered novel or cannot be considered to involve an inventive step when the document is taken alone
"L" document which may throw doubts on priority claim(s) or which is cited to establish the publication date of another citation or other special reason (as specified)	"Y" document of particular relevance; the claimed invention cannot be considered to involve an inventive step when the document is combined with one or more other such documents, such combination being obvious to a person skilled in the art
"O" document referring to an oral disclosure, use, exhibition or other means	"&" document member of the same patent family
"P" document published prior to the international filing date but later than the priority date claimed	

Date of the actual completion of the international search
07 December 2015 (07-12-2015)Date of mailing of the international search report
22 December 2015 (22-12-2015)Name and mailing address of the ISA/CA
Canadian Intellectual Property Office
Place du Portage I, C114 - 1st Floor, Box PCT
50 Victoria Street
Gatineau, Quebec K1A 0C9
Facsimile No.: 001-819-953-2476Authorized officer

Donald Lefebvre (819) 639-8195

INTERNATIONAL SEARCH REPORT

International application No.

PCT/CA2015/050938

C (Continuation). DOCUMENTS CONSIDERED TO BE RELEVANT		
Category*	Citation of document, with indication, where appropriate, of the relevant passages	Relevant to claim No.
A	US 2009/0138059 A1 (OUWERKERK) 28 May 2009 (28-05-2009) Whole document	1 to 22
A	US 2005/0113703 A1 (FARRINGDON et al.) 26 May 2005 (26-05-2005) Whole document	1 to 22
A	US 6,584,343 B1 (RANSBURY et al.) 24 Jun2003 (24-06-2003) Whole document	1 to 22
A	US 6,553,246 B1 (WENGER) 22 April 2003 (22-04-2003) Whole document	1 to 22

INTERNATIONAL SEARCH REPORT
Information on patent family members

International application No.
PCT/CA2015/050938

Patent Document Cited in Search Report	Publication Date	Patent Family Member(s)	Publication Date
US2015094603A1	02 April 2015 (02-04-2015)	CN104510465A DE102013219513A1 EP2853195A1	15 April 2015 (15-04-2015) 02 April 2015 (02-04-2015) 01 April 2015 (01-04-2015)
US2015054495A1	26 February 2015 (26-02-2015)	CN104414633A DE102013216682A1	18 March 2015 (18-03-2015) 26 February 2015 (26-02-2015)
US8792957B2	29 July 2014 (29-07-2014)	US2010036230A1 AU2009279710A1 AU2009279710B2 CA2731697A1 CN102112572A CN102112572B CN104127178A EP2328989A2 EP2826829A1 JP2011530334A JP5689798B2 JP2015096236A KR20110036922A KR101563556B1 US2014296685A1 WO2010017276A2 WO2010017276A3	11 February 2010 (11-02-2010) 11 February 2010 (11-02-2010) 23 January 2014 (23-01-2014) 11 February 2010 (11-02-2010) 29 June 2011 (29-06-2011) 23 July 2014 (23-07-2014) 05 November 2014 (05-11-2014) 08 June 2011 (08-06-2011) 21 January 2015 (21-01-2015) 22 December 2011 (22-12-2011) 25 March 2015 (25-03-2015) 21 May 2015 (21-05-2015) 12 April 2011 (12-04-2011) 27 October 2015 (27-10-2015) 02 October 2014 (02-10-2014) 11 February 2010 (11-02-2010) 01 April 2010 (01-04-2010)
KR101227413B1	12 February 2013 (12-02-2013)	KR20120102201A	18 September 2012 (18-09-2012)
US2009138059A1	28 May 2009 (28-05-2009)	CN101072603A EP1827599A2 JP2008522701A RU2007125707A WO2006061762A2 WO2006061762A3	14 November 2007 (14-11-2007) 05 September 2007 (05-09-2007) 03 July 2008 (03-07-2008) 20 January 2009 (20-01-2009) 15 June 2006 (15-06-2006) 16 November 2006 (16-11-2006)
US2005113703A1	26 May 2005 (26-05-2005)	US7502643B2 AT310444T AT324066T AU6708301A AU7009201A AU2002330965A1 AU2003259983A1 AU2003259983A8 AU2003275491A1 AU2003275491A8 AU2003291637A1 AU2003291637A8 BR0111918A BR0111918B1 BR0111995A BR0111995B1 BR0211760A BR0315184A BR0315229A BRPI0414345A BRPI0414359A CA2413148A1 CA2413148C	10 March 2009 (10-03-2009) 15 December 2005 (15-12-2005) 15 May 2006 (15-05-2006) 24 December 2001 (24-12-2001) 08 January 2002 (08-01-2002) 24 February 2003 (24-02-2003) 11 March 2004 (11-03-2004) 11 March 2004 (11-03-2004) 04 May 2004 (04-05-2004) 04 May 2004 (04-05-2004) 04 May 2004 (04-05-2004) 04 May 2004 (04-05-2004) 13 May 2003 (13-05-2003) 30 November 2010 (30-11-2010) 28 June 2005 (28-06-2005) 28 December 2010 (28-12-2010) 13 October 2004 (13-10-2004) 30 August 2005 (30-08-2005) 30 August 2005 (30-08-2005) 07 November 2006 (07-11-2006) 14 November 2006 (14-11-2006) 03 January 2002 (03-01-2002) 24 August 2010 (24-08-2010)

INTERNATIONAL SEARCH REPORT

International application No.

PCT/CA2015/050938

Patent Document Cited in Search Report	Publication Date	Patent Family Member(s)	Publication Date
US2005113703A1 (continued)		CA2413220A1	20 December 2001 (20-12-2001)
		CA2413220C	13 November 2007 (13-11-2007)
		CA2454655A1	20 February 2003 (20-02-2003)
		CA2454655C	01 October 2013 (01-10-2013)
		CA2496579A1	04 March 2004 (04-03-2004)
		CA2501732A1	22 April 2004 (22-04-2004)
		CA2501732C	30 July 2013 (30-07-2013)
		CA2501899A1	22 April 2004 (22-04-2004)
		CA2501899C	01 June 2010 (01-06-2010)
		CA2519723A1	13 March 2006 (13-03-2006)
		CA2519723C	27 May 2014 (27-05-2014)
		CA2538710A1	31 March 2005 (31-03-2005)
		CA2538758A1	31 March 2005 (31-03-2005)
		CA2538758C	28 October 2014 (28-10-2014)
		CA2560323A1	06 October 2005 (06-10-2005)
		CA2560323C	07 January 2014 (07-01-2014)
		CA2817028A1	22 April 2004 (22-04-2004)
		DE60115234D1	29 December 2005 (29-12-2005)
		DE60115234T2	10 August 2006 (10-08-2006)
		DE60119100D1	01 June 2006 (01-06-2006)
		DE60119100T2	31 August 2006 (31-08-2006)
		DK1414340T3	14 October 2013 (14-10-2013)
		DK1639939T3	28 October 2013 (28-10-2013)
		DK1662989T3	08 December 2014 (08-12-2014)
		DK1702560T3	23 February 2015 (23-02-2015)
		DK1734858T3	20 October 2014 (20-10-2014)
		EP1292217A2	19 March 2003 (19-03-2003)
		EP1292217B1	23 November 2005 (23-11-2005)
		EP1292218A1	19 March 2003 (19-03-2003)
		EP1292218B1	26 April 2006 (26-04-2006)
		EP1414340A2	06 May 2004 (06-05-2004)
		EP1414340B1	03 July 2013 (03-07-2013)
		EP1534126A2	01 June 2005 (01-06-2005)
		EP1534126A4	04 June 2008 (04-06-2008)
		EP1551281A2	13 July 2005 (13-07-2005)
		EP1551281A4	21 November 2007 (21-11-2007)
		EP1551282A2	13 July 2005 (13-07-2005)
		EP1551282A4	14 November 2007 (14-11-2007)
		EP1551282B1	18 November 2015 (18-11-2015)
		EP1639939A1	29 March 2006 (29-03-2006)
		EP1639939B1	24 July 2013 (24-07-2013)
		EP1662989A2	07 June 2006 (07-06-2006)
		EP1662989A4	28 May 2008 (28-05-2008)
		EP1662989B1	03 September 2014 (03-09-2014)
		EP1667579A2	14 June 2006 (14-06-2006)
		EP1667579A4	11 June 2008 (11-06-2008)
		EP1702560A1	20 September 2006 (20-09-2006)
		EP1702560B1	19 November 2014 (19-11-2014)
		EP1734858A1	27 December 2006 (27-12-2006)
		EP1734858A4	17 December 2008 (17-12-2008)
		EP1734858B1	09 July 2014 (09-07-2014)
		EP2319410A1	11 May 2011 (11-05-2011)
		EP2363061A1	07 September 2011 (07-09-2011)
		EP2491857A2	29 August 2012 (29-08-2012)
		EP2491857A3	26 September 2012 (26-09-2012)
		EP2574275A2	03 April 2013 (03-04-2013)
		EP2574275A3	26 June 2013 (26-06-2013)
	ES2253393T3	01 June 2006 (01-06-2006)	
	ES2260245T3	01 November 2006 (01-11-2006)	
	ES2429364T3	14 November 2013 (14-11-2013)	
	ES2430549T3	21 November 2013 (21-11-2013)	
	ES2530878T3	06 March 2015 (06-03-2015)	
	HK1088804A1	01 November 2013 (01-11-2013)	
	HK1094761A1	28 November 2014 (28-11-2014)	
	HK1104772A1	24 October 2014 (24-10-2014)	

INTERNATIONAL SEARCH REPORT

International application No.

PCT/CA2015/050938

Patent Document Cited in Search Report	Publication Date	Patent Family Member(s)	Publication Date
US2005113703A1 (continued)		IL153478A	03 August 2009 (03-08-2009)
		IL153478D0	06 July 2003 (06-07-2003)
		IL153516D0	06 July 2003 (06-07-2003)
		IL153516A	24 July 2007 (24-07-2007)
		IL160079A	11 February 2009 (11-02-2009)
		IL160079D0	20 June 2004 (20-06-2004)
		IL167045A	29 April 2010 (29-04-2010)
		IL174267D0	01 August 2006 (01-08-2006)
		IL174267A	30 December 2010 (30-12-2010)
		IL174268D0	01 August 2006 (01-08-2006)
		IL178183D0	31 December 2006 (31-12-2006)
		IL178183A	31 December 2013 (31-12-2013)
		IL229600D0	30 January 2014 (30-01-2014)
		JP2004538066A	24 December 2004 (24-12-2004)
		JP4283672B2	24 June 2009 (24-06-2009)
		JP2006501965A	19 January 2006 (19-01-2006)
		JP4813058B2	09 November 2011 (09-11-2011)
		JP2006501961A	19 January 2006 (19-01-2006)
		JP4975249B2	11 July 2012 (11-07-2012)
		JP2007530154A	01 November 2007 (01-11-2007)
		JP5051767B2	17 October 2012 (17-10-2012)
		JP2007504917A	08 March 2007 (08-03-2007)
		JP5174348B2	03 April 2013 (03-04-2013)
		JP2004512061A	22 April 2004 (22-04-2004)
		JP5273893B2	28 August 2013 (28-08-2013)
		JP2011120917A	23 June 2011 (23-06-2011)
		JP5555398B2	23 July 2014 (23-07-2014)
		JP2004500949A	15 January 2004 (15-01-2004)
		JP2005536260A	02 December 2005 (02-12-2005)
		JP2007505412A	08 March 2007 (08-03-2007)
		KR20030011103A	06 February 2003 (06-02-2003)
		KR100821945B1	15 April 2008 (15-04-2008)
		KR20030015281A	20 February 2003 (20-02-2003)
		KR100831036B1	21 May 2008 (21-05-2008)
		KR20040019380A	05 March 2004 (05-03-2004)
		KR100956791B1	11 May 2010 (11-05-2010)
		KR20060129178A	15 December 2006 (15-12-2006)
		KR101084554B1	17 November 2011 (17-11-2011)
		KR20060122814A	30 November 2006 (30-11-2006)
		KR101107062B1	25 January 2012 (25-01-2012)
		KR20050032119A	06 April 2005 (06-04-2005)
		KR20050055072A	10 June 2005 (10-06-2005)
		KR20050062773A	27 June 2005 (27-06-2005)
		MXPA02012482A	10 September 2004 (10-09-2004)
		MXPA02012643A	10 September 2004 (10-09-2004)
		MXPA04001055A	20 May 2004 (20-05-2004)
		MXPA05002024A	03 June 2005 (03-06-2005)
		MXPA05003686A	17 June 2005 (17-06-2005)
		MXPA05003688A	30 September 2005 (30-09-2005)
		MXPA06002836A	14 June 2006 (14-06-2006)
		PT1292218E	29 September 2006 (29-09-2006)
		PT1414340E	09 October 2013 (09-10-2013)
		PT1639939E	22 October 2013 (22-10-2013)
		US6605038B1	12 August 2003 (12-08-2003)
		US2004039254A1	26 February 2004 (26-02-2004)
		US7020508B2	28 March 2006 (28-03-2006)
		US2002019586A1	14 February 2002 (14-02-2002)
		US7261690B2	28 August 2007 (28-08-2007)
		US2004152957A1	05 August 2004 (05-08-2004)
		US7285090B2	23 October 2007 (23-10-2007)
		US7689437B1	30 March 2010 (30-03-2010)
		US2008275309A1	06 November 2008 (06-11-2008)
		US7959567B2	14 June 2011 (14-06-2011)
		US2006031102A1	09 February 2006 (09-02-2006)
		US8073707B2	06 December 2011 (06-12-2011)

INTERNATIONAL SEARCH REPORT

International application No.

PCT/CA2015/050938

Patent Document Cited in Search Report	Publication Date	Patent Family Member(s)	Publication Date
US2005113703A1 (continued)		US2004133081A1	08 July 2004 (08-07-2004)
		US8157731B2	17 April 2012 (17-04-2012)
		US2010286532A1	11 November 2010 (11-11-2010)
		US8369936B2	05 February 2013 (05-02-2013)
		US2005113650A1	26 May 2005 (26-05-2005)
		US8398546B2	19 March 2013 (19-03-2013)
		US2006053712A1	16 March 2006 (16-03-2006)
		US8429864B2	30 April 2013 (30-04-2013)
		US2008161655A1	03 July 2008 (03-07-2008)
		US8641612B2	04 February 2014 (04-02-2014)
		US2005245839A1	03 November 2005 (03-11-2005)
		US8663106B2	04 March 2014 (04-03-2014)
		US2008171919A1	17 July 2008 (17-07-2008)
		US8708904B2	29 April 2014 (29-04-2014)
		US2013145706A1	13 June 2013 (13-06-2013)
		US8726592B2	20 May 2014 (20-05-2014)
		US2008171921A1	17 July 2008 (17-07-2008)
		US8852098B2	07 October 2014 (07-10-2014)
		US2012149996A1	14 June 2012 (14-06-2012)
		US8870766B2	28 October 2014 (28-10-2014)
		US2006224051A1	05 October 2006 (05-10-2006)
		US8961413B2	24 February 2015 (24-02-2015)
		US2007173705A1	26 July 2007 (26-07-2007)
		US8961414B2	24 February 2015 (24-02-2015)
		US2008171920A1	17 July 2008 (17-07-2008)
		US8968196B2	03 March 2015 (03-03-2015)
		US2014180021A1	26 June 2014 (26-06-2014)
		US8979763B2	17 March 2015 (17-03-2015)
		US2008183052A1	31 July 2008 (31-07-2008)
		US9033875B2	19 May 2015 (19-05-2015)
		US2008167538A1	10 July 2008 (10-07-2008)
		US9033876B2	19 May 2015 (19-05-2015)
		US2008161654A1	03 July 2008 (03-07-2008)
		US9165117B2	20 October 2015 (20-10-2015)
		US2014180023A1	26 June 2014 (26-06-2014)
		US9168001B2	27 October 2015 (27-10-2015)
		US2004034289A1	19 February 2004 (19-02-2004)
		US2006122474A1	08 June 2006 (08-06-2006)
		US2006264730A1	23 November 2006 (23-11-2006)
		US2007100666A1	03 May 2007 (03-05-2007)
		US2008161707A1	03 July 2008 (03-07-2008)
		US2008161715A1	03 July 2008 (03-07-2008)
		US2008167535A1	10 July 2008 (10-07-2008)
		US2008167536A1	10 July 2008 (10-07-2008)
		US2008167537A1	10 July 2008 (10-07-2008)
		US2008167539A1	10 July 2008 (10-07-2008)
		US2008167572A1	10 July 2008 (10-07-2008)
		US2008167573A1	10 July 2008 (10-07-2008)
		US2008171918A1	17 July 2008 (17-07-2008)
		US2008171922A1	17 July 2008 (17-07-2008)
		US2008171943A1	17 July 2008 (17-07-2008)
		US2008177158A1	24 July 2008 (24-07-2008)
		US2008177193A1	24 July 2008 (24-07-2008)
		US2008183051A1	31 July 2008 (31-07-2008)
		US2008183082A1	31 July 2008 (31-07-2008)
		US2008183090A1	31 July 2008 (31-07-2008)
		US2008214949A1	04 September 2008 (04-09-2008)
		US2008287751A1	20 November 2008 (20-11-2008)
		US2008287817A1	20 November 2008 (20-11-2008)
		US2009118590A1	07 May 2009 (07-05-2009)
		US2009177068A1	09 July 2009 (09-07-2009)
		US2012059230A1	08 March 2012 (08-03-2012)
		US2013158367A1	20 June 2013 (20-06-2013)
		US2013158368A1	20 June 2013 (20-06-2013)
		US2014081666A1	20 March 2014 (20-03-2014)
		US2014094707A1	03 April 2014 (03-04-2014)

INTERNATIONAL SEARCH REPORT

International application No.

PCT/CA2015/050938

Patent Document Cited in Search Report	Publication Date	Patent Family Member(s)	Publication Date
US2005113703A1 (continued)		US2014180020A1	26 June 2014 (26-06-2014)
		US2014180022A1	26 June 2014 (26-06-2014)
		US2014180137A1	26 June 2014 (26-06-2014)
		US2014203797A1	24 July 2014 (24-07-2014)
		US2014206955A1	24 July 2014 (24-07-2014)
		US2014213855A1	31 July 2014 (31-07-2014)
		US2014213856A1	31 July 2014 (31-07-2014)
		US2014213857A1	31 July 2014 (31-07-2014)
		US2014221769A1	07 August 2014 (07-08-2014)
		US2014221770A1	07 August 2014 (07-08-2014)
		US2014221774A1	07 August 2014 (07-08-2014)
		US2014221784A1	07 August 2014 (07-08-2014)
		US2014221785A1	07 August 2014 (07-08-2014)
		US2014221787A1	07 August 2014 (07-08-2014)
		US2014221788A1	07 August 2014 (07-08-2014)
		US2014221789A1	07 August 2014 (07-08-2014)
		US2014221790A1	07 August 2014 (07-08-2014)
		US2014221791A1	07 August 2014 (07-08-2014)
		US2014221849A1	07 August 2014 (07-08-2014)
		US2014221850A1	07 August 2014 (07-08-2014)
		US2014222174A1	07 August 2014 (07-08-2014)
		US2014223406A1	07 August 2014 (07-08-2014)
		US2014223407A1	07 August 2014 (07-08-2014)
		US2014232516A1	21 August 2014 (21-08-2014)
		US2014257055A1	11 September 2014 (11-09-2014)
		US2014257540A1	11 September 2014 (11-09-2014)
		US2014275812A1	18 September 2014 (18-09-2014)
		US2014275813A1	18 September 2014 (18-09-2014)
		US2014276192A1	18 September 2014 (18-09-2014)
		US2014330094A1	06 November 2014 (06-11-2014)
		US2014342328A1	20 November 2014 (20-11-2014)
		US2014343370A1	20 November 2014 (20-11-2014)
		US2015238097A1	27 August 2015 (27-08-2015)
		US2015245797A1	03 September 2015 (03-09-2015)
		US2015282767A1	08 October 2015 (08-10-2015)
		US2015289797A1	15 October 2015 (15-10-2015)
		US2015289798A1	15 October 2015 (15-10-2015)
		US2015289799A1	15 October 2015 (15-10-2015)
		US2015289800A1	15 October 2015 (15-10-2015)
		US2015289808A1	15 October 2015 (15-10-2015)
		US2015289809A1	15 October 2015 (15-10-2015)
		US2015289810A1	15 October 2015 (15-10-2015)
		US2015289811A1	15 October 2015 (15-10-2015)
		US2015289812A1	15 October 2015 (15-10-2015)
		US2015294574A1	15 October 2015 (15-10-2015)
		US2015294575A1	15 October 2015 (15-10-2015)
		US2015294576A1	15 October 2015 (15-10-2015)
		US2015294583A1	15 October 2015 (15-10-2015)
		US2015294594A1	15 October 2015 (15-10-2015)
		US2015339946A1	26 November 2015 (26-11-2015)
		WO0196986A2	20 December 2001 (20-12-2001)
		WO0196986A3	12 September 2002 (12-09-2002)
		WO0196986A8	24 October 2002 (24-10-2002)
		WO0200111A1	03 January 2002 (03-01-2002)
		WO03015005A2	20 February 2003 (20-02-2003)
		WO03015005A3	18 December 2003 (18-12-2003)
		WO2004019172A2	04 March 2004 (04-03-2004)
		WO2004019172A9	03 June 2004 (03-06-2004)
		WO2004019172A3	07 April 2005 (07-04-2005)
		WO2004032715A2	22 April 2004 (22-04-2004)
		WO2004032715A3	15 July 2004 (15-07-2004)
		WO2004034221A2	22 April 2004 (22-04-2004)
		WO2004034221A9	17 June 2004 (17-06-2004)
		WO2004034221A3	13 January 2005 (13-01-2005)

INTERNATIONAL SEARCH REPORT

International application No.

PCT/CA2015/050938

Patent Document Cited in Search Report	Publication Date	Patent Family Member(s)	Publication Date
US2005113703A1 (continued)		WO2005016124A2 WO2005016124A3 WO2005027720A2 WO2005027720A3 WO2005029242A2 WO2005029242A3 WO2005092177A1	24 February 2005 (24-02-2005) 17 November 2005 (17-11-2005) 31 March 2005 (31-03-2005) 18 August 2005 (18-08-2005) 31 March 2005 (31-03-2005) 09 June 2005 (09-06-2005) 06 October 2005 (06-10-2005)
US6584343B1	24 June 2003 (24-06-2003)	AU4576701A AU4744001A AU4920601A AU5386101A AU5705201A US6556860B1 US2001056245A1 US6615075B2 US2002038093A1 US6658285B2 US2001056289A1 US6760620B2 US2002026220A1 US6931273B2 US2004015194A1 US2005182336A1 WO0167950A1 WO0167952A1 WO0167953A1 WO0167954A1 WO0176461A2 WO0176461A3	24 September 2001 (24-09-2001) 24 September 2001 (24-09-2001) 24 September 2001 (24-09-2001) 24 September 2001 (24-09-2001) 23 October 2001 (23-10-2001) 29 April 2003 (29-04-2003) 27 December 2001 (27-12-2001) 02 September 2003 (02-09-2003) 28 March 2002 (28-03-2002) 02 December 2003 (02-12-2003) 27 December 2001 (27-12-2001) 06 July 2004 (06-07-2004) 28 February 2002 (28-02-2002) 16 August 2005 (16-08-2005) 22 January 2004 (22-01-2004) 18 August 2005 (18-08-2005) 20 September 2001 (20-09-2001) 20 September 2001 (20-09-2001) 20 September 2001 (20-09-2001) 20 September 2001 (20-09-2001) 18 October 2001 (18-10-2001) 10 January 2002 (10-01-2002)
US6553246B1	22 April 2003 (22-04-2003)	AT478601T AU755264B2 AU2671899A AU2002362129A1 CA2319605A1 CA2319605C CN1294504A CN1235542C DE69942700D1 EP1054621A1 EP1054621A4 EP1054621B1 HK1036571A1 JP2002502655A JP4554074B2 US6006125A US6400977B1 US2004210149A1 US6973343B2 WO9940844A1 WO03051195A1 WO2004093675A1	15 September 2010 (15-09-2010) 05 December 2002 (05-12-2002) 30 August 1999 (30-08-1999) 30 June 2003 (30-06-2003) 19 August 1999 (19-08-1999) 08 September 2009 (08-09-2009) 09 May 2001 (09-05-2001) 11 January 2006 (11-01-2006) 07 October 2010 (07-10-2010) 29 November 2000 (29-11-2000) 04 June 2003 (04-06-2003) 25 August 2010 (25-08-2010) 28 July 2006 (28-07-2006) 29 January 2002 (29-01-2002) 29 September 2010 (29-09-2010) 21 December 1999 (21-12-1999) 04 June 2002 (04-06-2002) 21 October 2004 (21-10-2004) 06 December 2005 (06-12-2005) 19 August 1999 (19-08-1999) 26 June 2003 (26-06-2003) 04 November 2004 (04-11-2004)

专利名称(译)	非接触式心电图系统		
公开(公告)号	EP3038523A1	公开(公告)日	2016-07-06
申请号	EP2015794450	申请日	2015-09-23
[标]申请(专利权)人(译)	RR序列		
申请(专利权)人(译)	RR序列INC.		
当前申请(专利权)人(译)	RR序列INC.		
[标]发明人	JAIN DEEPAK BOBBY WEEKS JOSHUA NADEZHDIN DAVID ASSELIN JEAN FRANCOIS		
发明人	JAIN, DEEPAK BOBBY WEEKS, JOSHUA NADEZHDIN, DAVID ASSELIN, JEAN-FRANÇOIS		
IPC分类号	A61B5/0428 A61B5/0402 A61B5/00 A61B5/04 A61B5/0408 A61B5/0424 A61B5/11		
CPC分类号	A61B5/0006 A61B5/04012 A61B5/0402 A61B5/04085 A61B5/0424 A61B5/04284 A61B5/1114 A61B5/6844 A61B5/7221 A61B2562/0214 A61B2562/046 A61B2562/164 A61B5/04028		
优先权	62/054189 2014-09-23 US 62/206542 2015-08-18 US		
其他公开文献	EP3038523A4		
外部链接	Espacenet		

摘要(译)

一种用于使用非接触式ECG传感器为人体提供标准心电图 (ECG) 信号的系统，用于输出到现有的医疗设备或用于在远程设备上存储或查看。该系统包括数字处理模块 (DPM)，其适于连接到织物等中提供的非接触式ECG传感器阵列。选择机制嵌入到DPM中，允许DPM使用不同ECG传感器的ECG信号识别身体部位，并为每个身体部位选择最佳传感器导联。然后，DPM可以使用所选择的ECG信号产生标准ECG信号，用于检测到的不同身体部位。该系统适于连续地重新检查选择，以确保在身体部位移动后为给定的身体部位选择最佳引线，从而允许对患者进行连续和不间断的ECG监测。