

(19)



(11)

**EP 2 854 627 B1**

(12)

**EUROPEAN PATENT SPECIFICATION**

(45) Date of publication and mention of the grant of the patent:  
**29.08.2018 Bulletin 2018/35**

(51) Int Cl.:  
**A61B 5/00** (2006.01)      **A61B 5/04** (2006.01)  
**A61B 5/0464** (2006.01)      **A61B 5/0402** (2006.01)  
**A61N 1/39** (2006.01)

(21) Application number: **13737858.4**

(86) International application number:  
**PCT/IB2013/054426**

(22) Date of filing: **29.05.2013**

(87) International publication number:  
**WO 2013/179234 (05.12.2013 Gazette 2013/49)**

**(54) APPARATUS FOR ANALYZING CARDIAC RHYTHM DURING CPR**

VORRICHTUNG ZUR ANALYSE DES HERZRHYTHMUS WÄHRENDE EINER KARDIOPULMONALEN REANIMATION

APPAREIL POUR ANALYSER LE RYTHME CARDIAQUE LORS D'UNE RCP

(84) Designated Contracting States:  
**AL AT BE BG CH CY CZ DE DK EE ES FI FR GB GR HR HU IE IS IT LI LT LU LV MC MK MT NL NO PL PT RO RS SE SI SK SM TR**

• **ZHOU, Sophia Huai**  
**5656 AE Eindhoven (NL)**

(30) Priority: **01.06.2012 US 201261654143 P**

(74) Representative: **Steffen, Thomas**  
**Philips Intellectual Property & Standards**  
**High Tech Campus 5**  
**5656 AE Eindhoven (NL)**

(43) Date of publication of application:  
**08.04.2015 Bulletin 2015/15**

(56) References cited:  
**GB-A- 2 370 880**      **US-A1- 2006 025 824**  
**US-A1- 2006 122 648**      **US-A1- 2011 105 930**  
**US-A1- 2011 202 100**

(73) Proprietor: **Koninklijke Philips N.V.**  
**5656 AE Eindhoven (NL)**

(72) Inventors:  
• **BABAEIZADEH, Saeed**  
**5656 AE Eindhoven (NL)**

**EP 2 854 627 B1**

Note: Within nine months of the publication of the mention of the grant of the European patent in the European Patent Bulletin, any person may give notice to the European Patent Office of opposition to that patent, in accordance with the Implementing Regulations. Notice of opposition shall not be deemed to have been filed until the opposition fee has been paid. (Art. 99(1) European Patent Convention).

**Description**

5 [0001] The disclosure relates generally an improved method for monitoring a subject cardiac rhythm during the application of cardio-pulmonary resuscitation (CPR). More particularly, the invention relates to a medical device which incorporates an improved diagnostic algorithm that analyzes patient physiological data during CPR and determines if an electrotherapy shock is indicated. If the device is a defibrillator, the diagnostic algorithm provides user guidance and/or controls the device electrotherapy circuit based on the determination. The invention is defined in claim 1. Further aspects and preferred embodiments are defined in the dependent claims. Aspects, embodiments and examples of the present disclosure which do not fall under the scope of the appended claims do not form part of the invention and are merely provided for illustrative purposes. Furthermore, the methods presented in the present description are provided for illustrative purposes only and do not form part of the present invention.

10 [0002] Sudden cardiac arrest (SCA) is a leading cause of death in the United States. In about 40% of sudden cardiac arrest (SCA) patients, the initial cardiac rhythm observed is ventricular fibrillation (VF). CPR is the protocol treatment for SCA, which consists of chest compressions and ventilations that provide circulation in the patient. Defibrillation is interposed between sessions of CPR in order to treat underlying VF. It is known that the probability of successful defibrillation diminishes as the interval between the end of CPR compressions and the delivery of a defibrillating shock increases. Conversely, shortening the interval between the last compression and the shock by even a few seconds can improve shock success (defibrillation and return of spontaneous circulation (ROSC)).

15 [0003] Furthermore, defibrillation does not terminate the underlying causes of VF even if it temporarily corrects the VF. Thus, the underlying causes may induce a recurrence of VF following defibrillation. This phenomenon is known as refrillation. The present recommendation is to immediately resume chest compressions after the shock delivery for 2 minutes before analyzing the cardiac rhythm again. Some resuscitation thought leaders, however, believe that it is more beneficial to deliberately interrupt CPR early to deliver a shock aimed at correcting refrillation.

20 [0004] Defibrillators deliver a high-voltage impulse to the heart in order to restore normal rhythm and contractile function in patients who are experiencing arrhythmia, such as VF or ventricular tachycardia (VT) that is not accompanied by spontaneous circulation. There are several classes of defibrillators, including manual defibrillators, implantable defibrillators, and automatic external defibrillators (AEDs). AEDs differ from manual defibrillators in that AEDs can automatically analyze the ECG rhythm to determine if defibrillation is necessary.

25 [0005] FIGURE 1 is an illustration of a prior defibrillator 10 being applied by a user 12 to resuscitate a patient 14 suffering from cardiac arrest. In sudden cardiac arrest, the patient is stricken with a life threatening interruption to the normal heart rhythm, typically in the form of VF or VT that is not accompanied by spontaneous circulation (i.e., shockable VT). In VF, the normal rhythmic ventricular contractions are replaced by rapid, irregular twitching that results in ineffective and severely reduced pumping by the heart. If normal rhythm is not restored within a time frame commonly understood to be approximately 8 to 10 minutes, the patient will die. Conversely, the quicker that circulation can be restored (via CPR and defibrillation) after the onset of VF, the better the chances that the patient 14 will survive the event. The defibrillator 10 may be in the form of an AED capable of being used by a first responder. The defibrillator 10 may also be in the form of a manual defibrillator for use by paramedics or other highly trained medical personnel.

30 [0006] Electrodes 16 are applied across the chest of the patient 14 by the user 12 in order to acquire an ECG signal from the patient's heart. The defibrillator 10 then analyzes the ECG signal for signs of arrhythmia. If VF is detected, the defibrillator 10 signals the user 12 that a shock is advised. After detecting VF or other shockable rhythm, the user 12 then presses a shock button on the defibrillator 10 to deliver defibrillation pulse to resuscitate the patient 14. Defibrillator 10 may also signal the user 12 via visual and audible prompts as to when to start and stop periods of CPR compressions.

35 [0007] In addition to detecting ECG voltages, defibrillator 10 independently measures the patient's transthoracic impedance via the patient electrodes 16 in order to adjust the parameters of the defibrillating shock accordingly. Variations in the impedance measurement can also be used to determine the extent of patient motion, such as that caused by CPR chest compressions. In other defibrillators (not shown), a separate CPR sensing device, such as an accelerometer or force sensor, may be used to provide an indication of ongoing CPR. An exemplary CPR sensing device is described in U.S. Patent 7,108,665, entitled "CPR Chest Compression Monitor." If the defibrillator is integrated to an automated CPR machine, a compressions status signal from the machine may provide a CPR indication.

40 [0008] In prior art AEDs, the ECG analysis must be conducted during a non-CPR hands-off period because the electrical artifact induced by CPR-related motion makes the analysis algorithm unreliable. If the AED erroneously makes a false "shock" determination because of the artifact, it may enable the delivery of a shock potentially fatal to the patient. Thus, an adverse seconds-long interval between the end of CPR and the delivery of the shock impulse is necessary to provide for a clean analysis. For the same reasons, existing AED shock analysis algorithms are unable to detect and allow treatment for early refrillation that occurs during CPR.

45 [0009] A number of methods have been developed in an attempt to determine an accurate ECG measurement during CPR compressions. U.S. Patent Publication 2011/0105930 A1 entitled "TRUE ECG MEASUREMENT DURING CARDIO PULMONARY RESUSCITATION BY ADAPTIVE PIECEWISE STITCHING ALGORITHM", for example, discloses using

a filter to remove CPR artifact from the ECG. Similarly, International Publication WO 2011/040929 A1, entitled "DECIDING ON PATIENT ELECTRIC SHOCK THERAPY", describes a method for removing CPR artifact from an ECG prior to deciding as to whether to administer a shock to the patient. Another example, U.S. Patent 7,567,837 entitled "ENHANCED RHYTHM IDENTIFICATION IN COMPRESSION CORRUPTED ECG" describes a method for identifying and removing CPR artifact by assuming that the artifact is a high amplitude signal, while the ECG is any low amplitude signal found between successive high amplitude signals. Finally, International Publication WO 2006/015348 A2 entitled "DETECTING ARTIFACT SIGNALS CAUSED BY CPR OR PATIENT MOTION" describes a method for detecting the presence of CPR artifact in an ECG signal, but no attempt is offered to obtain an accurate ECG from the contaminated signal. None of these prior art techniques provides a satisfactorily accurate ECG from which a shock decision could be made.

**[0010]** It is known that the fraction of patients who would benefit from a pause in CPR to confirm a shockable rhythm is small compared to the majority for whom continued CPR is beneficial. An algorithm that can determine a high likelihood of the presence of a shockable rhythm during CPR artifact (i.e. without pausing CPR) would allow distinguishing those who might benefit from an immediate shock without compromising resuscitation for the majority of patients.

**[0011]** US 2011/0105930 A1 discloses method and apparatus utilizing a piecewise stitching adaptive algorithm (PSAA) to filter signal artifacts, such as those induced by cardiopulmonary resuscitation (CPR) from sensed signals in real-time. PSAA is a method of estimating artifact component present in a first signal that is highly correlated with a second signal. The PSAA may utilize autocorrelation and cross-correlation calculations to determine signal sample windows in the first and second signals. The PSAA may estimate a signal artifact in a primary signal segment based on the determined correlations between the primary signal and an artifact signal. The PSAA may remove the estimated signal artifact from the primary signal. In the absence of an artifact signal, PSAA is able to estimate artifacts in the first signal utilizing filters. The PSAA may be implemented in Automated External Defibrillators, Monitor Defibrillators or other devices capable sensing highly correlated signals such as, for example, ECG and CPR signals.

**[0012]** What is needed therefore to address each of these deficiencies in the prior art is an improved method of analyzing an underlying cardiac rhythm in the presence of CPR.

**[0013]** In accordance with the principles of the present invention, a method for analyzing a cardiac rhythm in the presence of CPR artifact is described which accurately identifies the presence of an arrhythmia that is treatable by electrotherapy, as defined in claim 1.

**[0014]** It is yet another object of the invention to describe a medical device which incorporates an improved ECG analysis method that accurately analyzes ECG in the presence of CPR artifact, as defined in claim 7.

FIGURE 1 is an illustration of a defibrillator which is in use with a patient suffering from cardiac arrest.

FIGURE 2 illustrates a recording of a typical ECG, showing an ECG strip with CPR-induced artifact followed by an ECG strip without artifact.

FIGURE 3 is a basic flow diagram for a method of analyzing ECG during CPR.

FIGURE 4a illustrates a pair of time-sequenced ECG data sets according to a preferred embodiment of the invention.

FIGURE 4b illustrates a pair of time-sequenced CPR reference signal data sets, which also correspond in time to the FIGURE 4a ECG data sets, according to a preferred embodiment of the invention.

FIGURE 5 illustrates a logic diagram for one example method, showing the interaction of a shock advisory algorithm, classifying criteria, and comparing criteria leading to an output decision.

FIGURE 6 is a truth table for decision criteria, corresponding to the FIGURE 5 logic diagram.

FIGURE 7 illustrates a flow diagram according to an alternate example method, showing the interaction of a shock advisory algorithm, a reliability indicator, analyzing/classifying criteria, and comparing criteria leading to an output decision.

FIGURE 8 is a truth table for decision criteria, corresponding generally to the FIGURE 7 flow diagram.

FIGURE 9 is a block diagram of a medical device constructed in accordance with the principles of the present invention.

**[0015]** Now turning to the figures, FIGURE 2 illustrates an exemplary 23-second ECG strip from a subject patient whose underlying cardiac rhythm is VF. The first half (left hand side 50) of the waveform is recorded during CPR, and the second half (right hand side 60) is recorded after CPR has been paused, i.e. there is no chest compressions artifact on the ECG data. It can be seen that, during CPR at left hand side 50, the chest compression artifact induced on the ECG masks the underlying VF rhythm. A prior art shock advisory algorithm as applied to left hand side 50 might evaluate the CPR artifact as a regular ECG rhythm and erroneously determine that no shock is advised. This situation contrasts with an evaluation of the right hand side 60 waveform having no CPR artifact. There, a shock advisory algorithm can accurately detect the VF rhythm and properly advise a shock. Thus, FIGURE 2 illustrates the problem with obtaining accurate ECG readings during CPR compressions that are ongoing during the rescue. FIGURE 2 also illustrates that existing shock advisory algorithms would be unable to detect whether an ECG rhythm changes from a VF to a normal sinus rhythm or vice versa, i.e. defibrillation.

**[0016]** The basic solution to the problem is illustrated by the flow chart of FIGURE 3. The FIGURE 3 method improves upon prior art methods by providing a shock advisory during CPR chest compressions by use of a technique that enables the analysis of the underlying cardiac rhythm during CPR. The technique allows for minimizing CPR hands-off intervals and increasing the likelihood of resuscitation success.

5 **[0017]** Shown in FIGURE 3 are the steps to a novel method 100 for analyzing ECG during CPR. Method 100 combines a shock advisory algorithm at steps 142, 144 with an upstream filtering stage at step 130 and a downstream decision making stage at steps 150, 160. The basic method entails applying a shock advisory algorithm to sequences of both filtered and unfiltered ECG data. The resulting set of shock advisories, i.e. at least two pair, is compared to decision criteria to determine the proper output command guidance.

10 **[0018]** The FIGURE 3 method requires two types of data. The first is raw unfiltered ECG data, digitized and arranged into sets by segments of predetermined duration. FIGURE 4a illustrates a preferred arrangement of ECG data, wherein a first unfiltered ECG data set 202 is 4.5 seconds long, and a second unfiltered ECG data set 202' overlaps with the first ECG data set 202 by 0.5 seconds. FIGURE 3 illustrates the input of corresponding time-sequential ECG data sets 102, 102' into the method 100.

15 **[0019]** The second type of data consists of CPR reference signal data, which is also arranged into sets by segments of predetermined duration. FIGURE 4b illustrates a preferred arrangement of CPR data, wherein a first CPR reference signal data set 204 is 4.5 seconds long, and a second CPR reference signal data set 204' overlaps with the first CPR data set 204 by 0.5 seconds. Each CPR reference signal data set corresponds in time with the respective unfiltered ECG data set. FIGURE 3 illustrates the input of corresponding time-sequential CPR reference signal data sets 104, 104' into the method 100.

20 **[0020]** FIGURE 3 illustrates the required input of at least two time-sequential ECG data sets 102, 102' and at least two CPR reference signal data sets 104, 104' into the selective ECG filtering step 130 of method 100. A preliminary detecting chest compressions step 131 first determines if there is an indication of CPR artifact on either CPR reference signal data set. The output of step 131 is a Boolean indication of chest compression detection which is designed to be more sensitive than specific, and is based on evaluating variables in the CPR reference signal such as the range of amplitude and frequency, and the zero crossing rate.

25 **[0021]** If step 131 finds no indication of CPR on the reference signal, it may be preferable to analyze with a different shock advisory algorithm at step 164, thereby bypassing the balance of the inventive algorithm. An example alternate shock advisory algorithm is the PAS algorithm utilized in defibrillators manufactured by Koninklijke Philips, North America, Andover, Massachusetts. The PAS algorithm is described in co-assigned patent 6,108,578.

30 **[0022]** If step 131 indicates CPR on the reference signal, then a confirming step of detecting chest compressions is applied to each of the ECG and CPR data sets. Fundamental frequencies are calculated using known techniques for each of the CPR data sets 104, 104' at step 132, and for each of the ECG data sets 102, 102' at step 134. Known techniques include discrete Fourier transform and Cepstrum analyses. The respective CPR and ECG data set fundamental frequencies  $F_p$  and  $F_e$  are then compared at step 136. If the fundamental frequencies are not comparable within a predetermined amount, CPR artifact on the ECG is not indicated, and further analysis is conducted with a different shock advisory algorithm at step 164, thereby bypassing the inventive algorithm. If the ECG and CPR frequencies are approximately equal, CPR artifact on the ECG is confirmed and the method continues at the filtering step 138.

35 **[0023]** The final filtering of CPR artifact from an ECG signal at step 138 generally follows one of the techniques that are known in the art. One preferred technique utilizes two Comb filters centered at  $F_p$  and  $F_e$ . Alternatively, the technique could employ a notch filter or some other sort of filter which filters a certain frequency and its harmonics. In addition, before filtering each set of data, "padding data" may be added to the beginning and end of the set to damp down the filtering artifact on the main evaluation window. The output of the filtering step 130 is thus a pair of time-sequential filtered ECG data sets comprising a first and second filtered ECG data set.

40 **[0024]** After the ECG segments are filtered at step 130, both sets of filtered and unfiltered ECG segments are analyzed and classified at step 140. First, a shock advisory algorithm analyzes each of the filtered and unfiltered ECG data sets at steps 142, 144 respectively. Several existing shock algorithms are suitable for use at steps 142, 144. One is the aforementioned PAS algorithm. Another is described in co-assigned U.S. Patent 5,701,907 entitled "Electrocardiographic Waveform Monitoring Method and System."

45 **[0025]** The result of the analyzing steps 142, 144 is a set of four advices, each advice classifying each segment in each data set as either a shock advice or a no-shock advice. The shock advisory algorithms at steps 142, 144 may also classify an ECG data set as an "artifact" advice in the event that an ECG data set is too noisy for analysis.

50 **[0026]** Following the analyzing and classifying of the filtered and unfiltered ECG data sets, the set of advices are compared to decision criteria at step 150. The decision criteria are hereafter called SmartPause. Based on the particular combination of advices, SmartPause will output a decision of "arm", "continue CPR", or "pause CPR." If one or more of the advices is "artifact", SmartPause will preferably switch to an alternate method at step 162, which presumably would lead to a "do not touch the patient" prompt. Alternatively, SmartPause could directly issue a "pause CPR" decision, which would similarly lead to the same user prompt to discontinue touching the patient. In either case, the shock advisory

algorithm will then have access to artifact-free ECGs. This technique for treating "artifact" advices, therefore, may not eliminate the CPR interruptions completely, but it would reduce the instances in which chest compressions are interrupted for AED operation.

5 [0027] The final step of method 100 is to automatically issue an operational command to the medical device at step 166 based on the comparing step 150. The example of FIGURE 3 exemplifies the device as a defibrillator. The operational decision step 166 advises shock or no-shock as directed, which may further lead to automatically arming the defibrillator, issuing corresponding audible prompts such as verbal commands or beeps, and/or issuing corresponding visual prompts such as flashing lights or informational displays. In addition, the operational command may be to "pause CPR" in order to collect artifact-free ECGs, which would naturally lead to commands such as "do not touch the patient" and similar prompts. After CPR is discontinued, either as a result of a method 100 command or after the standard CPR pause period has timed-out, the shock advisory algorithm of the current practice, such as that indicated at step 164, would be used.

10 [0028] No device operational commands would be necessary in the event of a "continue CPR" decision. Alternatively, the device may issue informational status messages based on the decision in order to assure the user that the device is operating properly.

15 [0029] Now turning to FIGURE 5, a Boolean logic flow diagram for comparing advices and issuing an operational decision is illustrated. Similar to that discussed with reference to FIGURE 3, two segments of unfiltered ECG data 202, 202' are applied to shock advisory algorithm 540. The unfiltered ECG data 202, 202' are also processed by filter 530, after which the filtered ECG data sets are applied to shock advisory algorithm 540. The output of each shock advisory algorithm 540 is two shock advices. A shock advice is designated by the letter "S." A no-shock advice is designated by the letter "N." All possible permutations 542 of advices for the filtered ECG data sets and all possible permutations 544 for the unfiltered ECG data sets are shown as outputs. Each particular combination of filtered and unfiltered ECG data set pairs flow through the Boolean logic diagram at 550 to arrive at a particular decision at 560. In this SmartPause decision criteria example, possible output decisions are "continue CPR", "pause CPR", and "arm". Following each decision, the process loops and repeats via loop step 570 with a new unfiltered ECG data set and the later of the previous unfiltered ECG data set. ECG data sets that are identified as having artifact are essentially discarded at the shock advisory algorithm stage 540, and the process similarly loops and repeats via loop step 570 with new unfiltered ECG data sets. Alternatively, an artifact decision could be directed to a "pause CPR" decision in order to collect artifact-free ECG.

20 [0030] The order of the shock advices matters in just one case. Referring to FIGURE 5, it can be seen that an "NS" advice in a filtered ECG data set in combination with exactly one "S" advice in an unfiltered ECG data set results in "continue CPR." The result of an "SN" advice in a filtered ECG data set in combination with exactly one "S" advice in an unfiltered ECG data set results in "pause CPR." The reasoning for the different outcomes is as follows.

25 [0031] In the "NS" filtered ECG case, it is considered more prudent to merely await the results of the next unfiltered ECG advice pair than to issue an "arm" decision on just one shock advice. If the next filtered ECG segment advice is "Shock", then a "SS" advice pair results, leading to a proper "arm" decision. On the other hand, if the next filtered segment advice is "No-shock", then a "SN" advice pair results. The resulting decision to "pause CPR" enables the device to evaluate why the shock advisory algorithm advised shock and then changed the advice.

30 [0032] In the "SN" filtered ECG case, it is considered more prudent to immediately "pause CPR" in order to evaluate why the shock advisory algorithm changed an "S" advice to an "N" advice instead of waiting or proceeding to an "arm" decision. The "pause CPR" decision quickly leads to a hands-off situation having artifact-free ECG.

35 [0033] FIGURE 6 illustrates a truth table for the SmartPause decision criteria corresponding to the FIGURE 5 logic diagram. Each permutation of four advices 606, i.e. two time-sequential unfiltered ECG data set 604 advices and two corresponding time-sequential filtered ECG data set 602 advices, lead to one of a decision 608. In this case, the decisions are "arm", "pause CPR", or "continue CPR."

40 [0034] The inventors have discovered that the resulting SmartPause method output is more accurate in analyzing ECG during CPR than the prior art methods, which generally avoid analysis during CPR. SmartPause correctly issues "arm" operational commands to a sensitivity of 91% or higher and a specificity of 97% or higher. Sensitivity (Se) is the proportion of actual positives which are correctly identified as such (e.g. a correct arm decision based on the underlying ECG). Specificity (Sp) is the proportion of negatives which are correctly identified. In addition, the SmartPause method calls for an interruption of CPR (i.e. "pause CPR") only 10% of the time.

45 [0035] Another embodiment of the inventive method supplements the SmartPause decision criteria with a measure of confidence in the shock advisory advice. The measure of confidence is referred to as the reliability indicator. This alternative embodiment is dubbed SmartPause+.

50 [0036] FIGURE 7 illustrates a process flow diagram for the SmartPause+ method. The flow diagram uses many of the same major process steps as shown in FIGURE 3 and the SmartPause logic diagram of FIGURE 5. For example, similar inputs of first and second unfiltered ECG data sets 202, 202' and first and second CPR reference signal data sets 204, 204' are constructed in time-sequential segments as described in FIGURES 4a and 4b. Filter 730 processes the unfiltered ECG 202, 202' in the same manner as that described for filtering step 130 in FIGURE 3. Both filtered and

unfiltered ECG data sets are analyzed in analyzing step 740 by the shock advisory algorithm and classified in the classifying steps 742, 744 as "shock" advices or "no-shock" advices. The classified sets of advices are then compared to decision criteria logic in comparing step 750 to arrive at an operational decision step 760 that is issued to the subject medical device. Output decisions are "arm", "pause CPR", or "continue CPR."

**[0037]** The Smartpause+ method differs from the SmartPause method in two important ways. First, shock advisory algorithm 740 generates a reliability indicator 810 in addition to generating an advice. A preferred embodiment of reliability indicator 810 is a novel combination of a 'margin' to a shock advice and a measure of the 'shockability' of the underlying cardiac rhythm. Second, the reliability indicator 810 is used as an additional decision criterion in comparing step 750, which affects the output decision. Each of these differences is described below.

**[0038]** The 'margin' to a shock advice is an indication of how confident the shock advisory algorithm, such as the aforementioned PAS algorithm, is in its shock advice. 'Confidence' in this context means the margin between the measured characteristics of the ECG segment and the variables used in determining whether that ECG segment is shockable or not. One exemplary variable is heart rate. If PAS determines that the rhythm is shockable but the margin is relatively small, then PAS confidence is low. On the other hand if the margin is relatively large, then PAS confidence is high. Similarly, the margin indication can be applied to a non-shockable advice.

**[0039]** The measure of 'shockability' of a shockable VF ECG segment is determined in one of a number of ways. Techniques which have been used for VF wave analysis include measures based on VF amplitude and slope, VF frequency measures including wavelet decomposition, nonlinear dynamics methods, or a combination of these methods. One technique is described in detail in co-assigned U.S. Patent Publication Number 2008/0208070 A1. The preferred measure of 'shockability' is a function of the sum of absolute values of the second difference of the ECG signal in the segment.

**[0040]** Without undue experimentation, one of ordinary skill in the art can determine a desired weighting of the 'margin' and 'shockability' measures to arrive at the reliability indicator 810. The reliability measure is shown in FIGURE 7 as applied to a filtered ECG data segment at step 740,742, but may alternatively be applied to an unfiltered ECG data segment at step 740,744. Preferably, the reliability indicator 810 is a binary measure of either "reliable" or "unreliable."

**[0041]** Returning to FIGURE 7, a reliability assessment step 770 using the reliability indicator 810 determines how the SmartPause+ method will proceed. If the reliability indicator 810 is "reliable", SmartPause+ applies a comparing step 750 using the four advices obtained from the first and second filtered and unfiltered ECG data sets and the reliability indicator 810 as factors. If the reliability indicator 810 is 'unreliable', the SmartPause+ method bypasses comparing step 750 and proceeds directly to issuing an operational command of "pause CPR" at step 760. This ensures that at least one ECG data segment is reliable. Also, the bypassing saves computational time, and allows for the method to quickly obtain artifact-free ECG.

**[0042]** FIGURE 7 illustrates the logic associated with comparing step 750, where a filled-in diamond indicates a 'reliable' reliability indicator for at least one filtered ECG data set. It can be seen there that at least one 'reliable' reliability indicator 810 is necessary, but not in itself sufficient, to enable an "arm" command at issuing step 760. In other aspects, the decision flow of comparing step 750 mirrors that in the aforescribed logic diagram of FIGURE 5, wherein the order of the shock advices matters.

**[0043]** FIGURE 8 illustrates a truth table 800 for the SmartPause+ decision criteria corresponding to the FIGURE 7 decision flow diagram. Each permutation of four advices 806, i.e. two time-sequential unfiltered ECG data set 804 advices and two corresponding time-sequential filtered ECG data set 802 advices, lead to one of an operational command 808. In this case, the operational command decisions are "arm", "pause CPR", or "continue CPR." It can be seen in FIGURE 8 that a more restricted set of conditions are required in order to arrive at an "arm" operational command decision. In particular, at least one reliable shock indication 810 for a filtered ECG data set must exist in order to arm, regardless of the advices on the unfiltered ECG data sets.

**[0044]** The FIGURE 8 truth table does not include decisions for every possible permutation of the four shock advices and reliability indicator, except for the "arm" decisions. It is understood that the FIGURE 7 process flow diagram decisions take precedence over any discrepancy or omission in the FIGURE 8 table.

**[0045]** The inventors have discovered that the resulting SmartPause+ method output is marginally more accurate in analyzing ECG during CPR than the aforescribed SmartPause method. SmartPause+ correctly issues "arm" operational commands to a sensitivity of 92% or higher and a specificity of 99% or higher. The SmartPause method calls for an interruption of CPR (i.e. "pause CPR") only 14% of the time.

**[0046]** The inventive methods as described above are an improved clinical decision support tool intended for use in emergency care and resuscitation situations. The output of the tool can be used in several life-saving applications. First, by identifying a shockable rhythm prior to the end of the CPR protocol pause period, the analysis period following the pause period is unneeded. Quicker arming and shock delivery results, which improves the probability of resuscitation. The tool also enables the arming of a defibrillator during CPR protocol pause by interrupting chest compressions when a shockable rhythm is detected during CPR. Interrupting CPR for shock may be an effective treatment for the occurrence of refrillation during the CPR pause. Third, the tool may accurately prompt a rescuer to stop CPR when an organized

cardiac rhythm resumes during the CPR pause period. By discontinuing CPR chest compressions when they are no longer needed, the risk of CPR-induced injury is reduced. Finally, the tool may be used to monitor the quality and appropriateness of cardiopulmonary resuscitation in cardiac arrest events in both hospital and pre-hospital environments, i.e. the tool would act as a "CPR detector."

5 [0047] Now turning to FIGURE 9, a medical device 900 is illustrated which incorporates a clinical decision support tool intended for use in emergency care and resuscitation situations. Device 900 enables an improved and more accurate analysis of ECG during CPR than that attempted by prior art devices.

10 [0048] Medical device 900 requires at least two inputs. Electrodes 902 which are attached to a subject patient detect the patient's ECG signal. The detected ECG signal is passed to an ECG front end 904, where the ECG is processed and digitized into a time-varying data stream. Front end 904 further groups the ECG data stream into time-sequential ECG data sets. In a preferred embodiment, the ECG data sets are 4.5 second segments which sequentially overlap by 0.5 seconds. Each raw, i.e. unfiltered, ECG data set is then output from front end 904 to a filter 910 and to a classifier circuit 912.

15 [0049] In addition, device 900 requires an input indicative of CPR compressions activity. The input can be obtained from one of a number of sources. Shown in FIGURE 9 is a CPR sensor 908, which is typically a puck-like device that is placed between the patient's chest and the CPR-giver's hands. Sensors in the CPR sensor 908, such as force sensors and accelerometers, detect the CPR compressions and provide an input signal to device 900. Alternatively, CPR sensor 908 may be a compressions status signal that is obtained from an automated CPR machine, such as that currently sold as the AutoPulse™ Non-Invasive Cardiac Support Pump by Zoll Medical Corporation, Chelmsford, Massachusetts.

20 The automated CPR machine may provide an input indicative of the start of a CPR compression, for example.

[0050] A more preferred second input indicative of CPR is shown in FIGURE 9 by the impedance channel 906. Many devices which monitor ECG also develop an impedance measurement across electrodes 902, in order to assess noise on the ECG signal, to detect patient motion, or to optimize electrotherapy parameters. Here, the impedance measurement is obtained at impedance channel 906 in order to provide the CPR input. This source of CPR input is advantageous

25 because no additional hardware is required, saving rescue time and expense.

[0051] However it is detected, the input indicative of CPR compressions is provided to filter 910, where the input is initially digitized into a stream of time-varying CPR reference signals that indicate the frequency of chest compressions. Filter 910 further groups the digitized CPR signals into time-sequential CPR data sets. In a preferred embodiment, the CPR data sets are 4.5 second segments which sequentially overlap by 0.5 seconds. Each CPR data set corresponds

30 in time to an ECG data set.

[0052] Filter 910 generates a sequence of filtered ECG data sets by applying the CPR reference signal data sets to each respective unfiltered ECG data set. The preferred and alternative methods of generating the filtered ECG data sets at filter 910 are as described previously. Each filtered ECG data set is output from filter 910 to classifier circuit 912.

35 [0053] Classifier circuit 912 applies an analysis algorithm to each filtered and unfiltered ECG data set, and classifies each data set as a "shock" or a "no-shock" rhythm, or "advice." If the data set cannot be classified, the set may optionally be classified as "artifact." The analysis algorithm is as described in the foregoing method discussion.

[0054] Classifier circuit 912 optionally incorporates a reliability analyzer that generates an indication of the reliability of each of the data set classifications. The reliability analysis algorithm is as described in the foregoing method discussion.

40 [0055] A comparator circuit 914 applies the classifications and optionally the reliability indications as obtained from classifier 912 to a decision matrix to generate a decision output command. The decision matrix corresponds to the logic flow and/or truth table arrangements as discussed in the afore-described inventive methods. The preferred output command is one of "arm", "continue CPR", or "pause CPR", depending on the output of the decision matrix.

45 [0056] Output generator 916 converts the decision output command from comparator 914 into an actionable issued command. If, for example, the decision output command is "arm", output generator 916 controls the device 900 to automatically begin arming a high voltage electrotherapy circuit, such as HV delivery circuit 920 of a defibrillator. Output generator 916 can also generate appropriate audible and visual indicators at user interface 918 to alert the rescuer of the actionable command. Decision output commands of "pause CPR" may cause output generator 916 to issue audible and visual indications to the rescuer to stop CPR. A decision output command of "continue CPR" may cause the output generator to issue no command at all.

50 [0057] Device 900 may be disposed as a stand-alone device, or may be integrated into another medical device system. For example, medical device 900 can be incorporated into a patient monitoring system for alerting medical personnel to changes in cardiac rhythm during CPR. Device 900 could also be integrated with a CPR assistance device which uses CPR sensor 908. It is contemplated that device 900 could also be used with an automated CPR machine, wherein the input to filter 910 could also be a machine compressions status signal and the output from the output generator could

55 control changes in the machine operation. A preferred use for device 900 is of course as a component within a defibrillator or AED, wherein output generator 916 provides control for the arm function of a high voltage delivery circuit 920 based on the need to deliver a defibrillating shock, controls the user interface 918 to guide the user through a cardiac rescue, and optionally automatically delivers the shock through electrodes 902.

## EP 2 854 627 B1

**[0058]** Minor modifications to the device as described above are encompassed within the scope of the invention. For example, several of the individual circuits shown in FIGURE 9 may be integrated together into a single controller or processor in order to reduce complexity and space. Alternatively, some described function of the individual circuits may be performed by other of the circuits. A separate analog-digital conversion circuit, for example, could be dedicated to provide all of the pre-processing of ECG and CPR inputs. Variations in the nature and names of the outputs, which fulfill essentially the same user interface and device control objectives, also fall within the scope of the invention.

Table of Elements:

Element Nr	Name
10	Defibrillator
12	User
14	Patient
16	Electrodes
50	ECG recording left hand side, with CPR artifact
60	ECG recording right hand side, without CPR artifact
102, 102'	Obtaining first unfiltered ECG data set, second unfiltered ECG data set
104, 104'	Obtaining first CPR reference signal data set, second CPR reference signal data set
130	Filtering step
131	Preliminary detecting chest compressions
132	Calculate CPR reference signal data fundamental frequency fp
134	Calculate unfiltered ECG data set fundamental frequency fe
136	Compare fp and fe
138	Filtering ECG data set
140	Analyzing and Classifying ECG data sets
142	Analyzing filtered ECG data set
144	Analyzing unfiltered ECG data set
150	Comparing the classified ECG data sets
160	Issuing operational command to the medical device.
162	Screening for known ECG rhythm
164	Switching to standard analyzing method
166	Changing device status
202, 202'	first unfiltered ECG data set, second unfiltered ECG data set
204, 204'	First CPR reference signal data set, second CPR reference signal data set
530	Filtering step
540	Analyzing step
542	Filtered ECG data set classifying step
544	Unfiltered ECG data set classifying step
550	Comparing step
560	Issuing operational command step
570	Looping process step
600	SmartPause truth table
602	Filtered classified ECG data

(continued)

Element Nr	Name	
5	604	Unfiltered classified ECG data
	606	Comparison sets
	608	Operational Command
	730	Filtering step
10	740	Analyzing step
	742	Filtered ECG data set classifying step
	744	Unfiltered ECG data set classifying step
15	750	Comparing step
	760	Issuing operational command step
	770	Reliability assessment step
	800	SmartPausePlus truth table
20	802	Filtered classified ECG data
	804	Unfiltered classified ECG data
	806	Comparison sets
25	808	Operational Command
	810	Reliability indicator
	900	Medical device
	902	Electrodes
30	904	ECG front end
	906	Impedance channel
	908	CPR sensor
35	910	Filter
	912	Classifier
	914	Comparator
	916	Output generator
40	918	User Interface
	920	HV Delivery

#### 45 Claims

1. A medical device for diagnosing a cardiac rhythm during the performance of CPR comprising:

50 a front end (904) operable to obtain two or more time-sequential ECG data sets comprised of a first unfiltered ECG data set and a second unfiltered ECG data set;  
 an input (906, 908) operable to acquire two or more time-sequential CPR reference signal data sets which correspond in time to the time-sequential ECG data sets;  
 a filter (910) in communication with both of the front end and the input, operable to obtain a first filtered ECG data set and a second filtered ECG data set;  
 55 a shock classifier (912) operable to classify each of the filtered and unfiltered ECG data sets as a "shock" advice or a "no-shock" advice;  
 a comparator (914) operable to generate a decision based on the classified filtered and unfiltered ECG data sets by comparing the advices generated by the shock classifier for each of the filtered and unfiltered ECG data

sets; and  
an output generator (916) for issuing an operational command based on the decision.

- 5
2. The medical device of Claim 1, wherein the medical device is a defibrillator.
3. The medical device of Claim 1, wherein the input is an impedance sensed across a pair of electrodes.
- 10
4. The medical device of Claim 1, wherein the input is a CPR sensor consisting of one of an accelerometer, a force sensor, or a compressions status signal from an automated CPR machine.
- 15
5. The medical device of Claim 1, wherein the decision is one of the set consisting of an arm decision, a pause CPR decision, and a continue CPR decision.
6. The medical device of Claim 5, wherein the output generator issues a command comprising a user prompt to pause CPR based on the pause CPR decision.
7. The medical device of Claim 1, further comprising:
- 20
- a reliability analyzer operable to generate an indication of the reliability of each of the shock classifier advices based on the respective ECG data set;  
wherein the comparator is further operable to generate the decision based on the reliability analyzer indications.
8. The medical device of Claim 1, wherein the decision is accurate with a sensitivity of about 92% or higher and a specificity of about 99% or higher.
- 25

#### Patentansprüche

- 30
1. Medizinische Vorrichtung zum Diagnostizieren eines Herzrhythmus während der Durchführung von CPR, umfassend:
- ein vorderes Ende (904), das so betrieben werden kann, dass zwei oder mehr zeitsequentielle EKG-Datensätze, bestehend aus einem ersten ungefilterten EKG-Datensatz und einem zweiten ungefilterten EKG-Datensatz, erhalten werden;
- 35
- einen Eingang (906, 908), der so betrieben werden kann, dass zwei oder mehr zeitsequentielle CPR-Referenzsignal-Datensätze erhalten werden, die zeitlich den zeitsequentiellen EKG-Datensätzen entsprechen;
- einen Filter (910), der mit sowohl dem vorderen Ende als auch dem Eingang in Kommunikation steht, der so betrieben werden kann, dass ein erster gefilterter EKG-Datensatz und ein zweiter gefilterter EKG-Datensatz erhalten werden;
- 40
- einen Stromstoßklassifizierer (912), der so betrieben werden kann, dass er jeden der gefilterten und ungefilterten EKG-Datensätze als eine "Stromstoß"-Empfehlung oder eine "Kein Stromstoß"-Empfehlung klassifiziert;
- einen Vergleichler (914), der so betrieben werden kann, dass er basierend auf den klassifizierten gefilterten und ungefilterten EKG-Datensätzen durch Vergleichen der vom Stromstoßklassifizierer für jeden der gefilterten und ungefilterten EKG-Datensätze erzeugten Empfehlungen eine Entscheidung erzeugt; und
- 45
- einen Ausgangsgenerator (916) zum Ausgeben eines Betriebsbefehls, der auf der Entscheidung basiert.
2. Medizinische Vorrichtung nach Anspruch 1, wobei die medizinische Vorrichtung ein Defibrillator ist.
3. Medizinische Vorrichtung nach Anspruch 1, wobei der Eingang eine über einem Elektrodenpaar abgetastete Impedanz ist.
- 50
4. Medizinische Vorrichtung nach Anspruch 1, wobei der Eingang ein CPR-Sensor ist, der aus einem aus einem Beschleunigungsmesser, einem Kraftsensor, oder einem Kompressionsstatussignal aus einem CPR-Automaten besteht.
- 55
5. Medizinische Vorrichtung nach Anspruch 1, wobei die Entscheidung eine ist aus dem Satz bestehend aus einer Scharfschalten-Entscheidung, einer CPR-pausieren-Entscheidung, und einer CPR-fortsetzen-Entscheidung.

6. Medizinische Vorrichtung nach Anspruch 5, wobei der Ausgangsgenerator basierend auf der CPR-pausieren-Entscheidung einen Befehl ausgibt, der eine Benutzeraufforderung dazu umfasst, CPR zu pausieren.

7. Medizinische Vorrichtung nach Anspruch 1, weiter umfassend:

einen Zuverlässigkeitsanalysator, der so betrieben werden kann, dass basierend auf dem jeweiligen EKG-Datensatz eine Angabe bezüglich der Zuverlässigkeit jeder der Stromstoßklassifizierer-Empfehlungen erzeugt wird;

wobei der Vergleicher weiter so betrieben werden kann, dass die Entscheidung auf den Zuverlässigkeitsanalysator-Angaben basierend erzeugt wird.

8. Medizinische Vorrichtung nach Anspruch 1, wobei die Entscheidung mit einer Empfindlichkeit von etwa 92 % oder höher, und einer Spezifität von etwa 99 % oder höher genau ist.

## Revendications

1. Dispositif médical pour diagnostiquer un rythme cardiaque au cours de l'occurrence d'une RCP, comprenant :

un frontal (904) qui est à même d'obtenir deux ou plusieurs jeux de données ECG séquentiels dans le temps constitués d'un premier jeu de données ECG non filtrées et d'un second jeu de données ECG non filtrées ;  
une entrée (906, 908) qui est à même d'acquérir deux ou plusieurs jeux de données de signal de référence RCP séquentiels dans le temps, qui correspondent dans le temps aux jeux de données ECG séquentiels dans le temps ;

un filtre (910) en communication avec à la fois le frontal et l'entrée, qui est à même d'obtenir un premier jeu de données ECG filtrées et un second jeu de données ECG filtrées ;

un classificateur de choc (912) qui est à même de classifier chacun des jeux de données ECG filtrées et non filtrées par un conseil de « choc » ou un conseil de « pas de choc » ;

un comparateur (914) qui est à même de générer une décision basée sur les jeux de données ECG filtrées et non filtrées classifiées en comparant les conseils générés par le classificateur de choc pour chacun des jeux de données ECG filtrées et non filtrées ; et

un générateur de sortie (916) pour délivrer une instruction opérationnelle basée sur la décision.

2. Dispositif médical selon la revendication 1, dans lequel le dispositif médical est un défibrillateur.

3. Dispositif médical selon la revendication 1, dans lequel l'entrée est une impédance détectée aux bornes d'une paire d'électrodes.

4. Dispositif médical selon la revendication 1, dans lequel l'entrée est un capteur de RCP constitué d'un accéléromètre, d'un capteur de force ou d'un signal d'état de compression issu d'une machine RCP automatisée.

5. Dispositif médical selon la revendication 1, dans lequel la décision est l'une du jeu constitué d'une décision d'armement, d'une décision de pause de RCP et d'une décision de continuation de RCP.

6. Dispositif médical selon la revendication 5, dans lequel le générateur de sortie délivre une instruction comprenant un utilisateur invitant à une pause de RCP sur la base de la décision de pause de RCP.

7. Dispositif médical selon la revendication 1, comprenant en outre :

un analyseur de fiabilité qui est à même de générer une indication de la fiabilité de chacun des conseils du classificateur de choc sur la base du jeu de données ECG respectif ;

dans lequel le comparateur est en outre à même de générer la décision sur la base des indications de l'analyseur de fiabilité.

8. Dispositif médical selon la revendication 1, dans lequel la décision est précise avec une sensibilité d'environ 92 % ou plus et une spécificité d'environ 99 % ou plus.

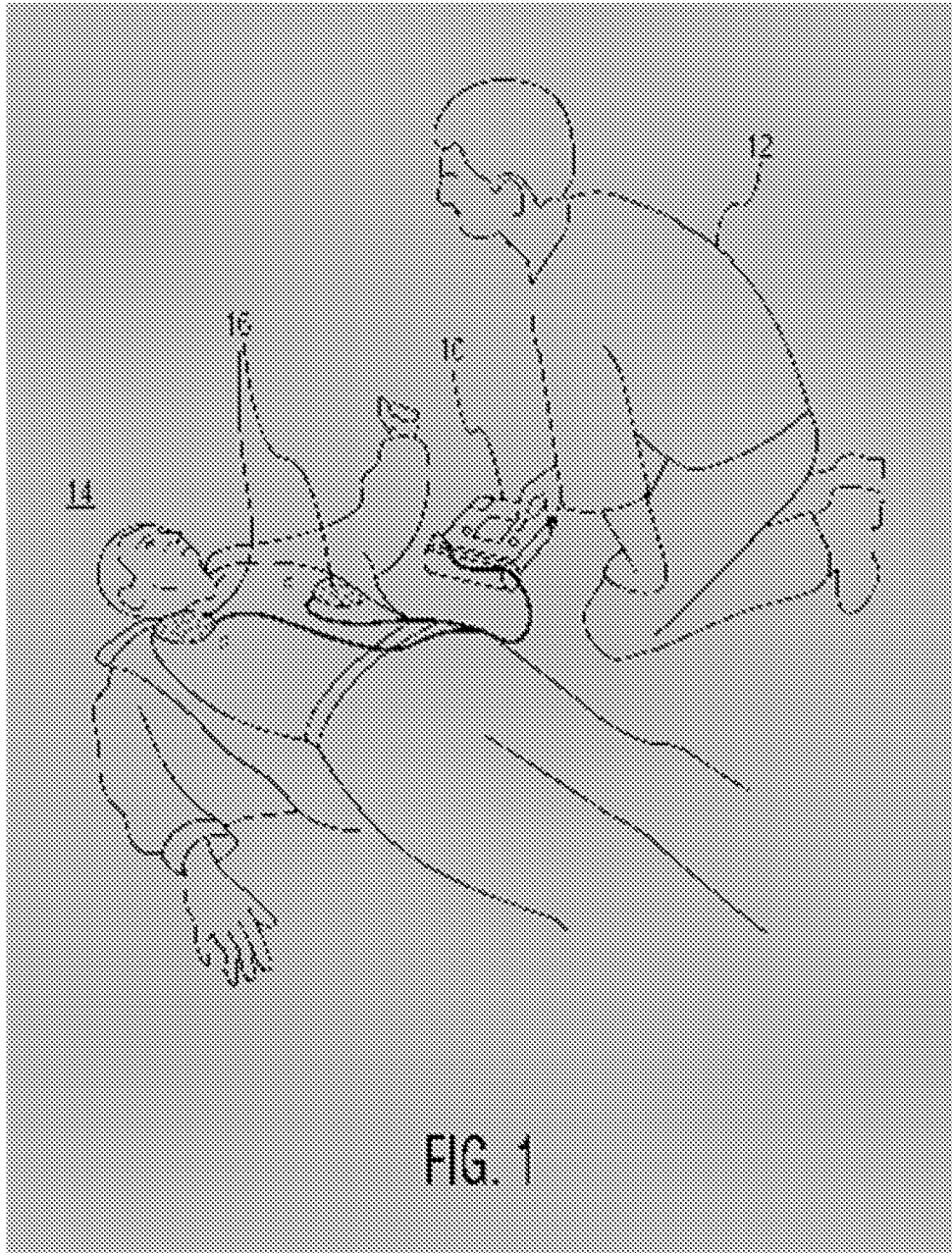

FIG. 2

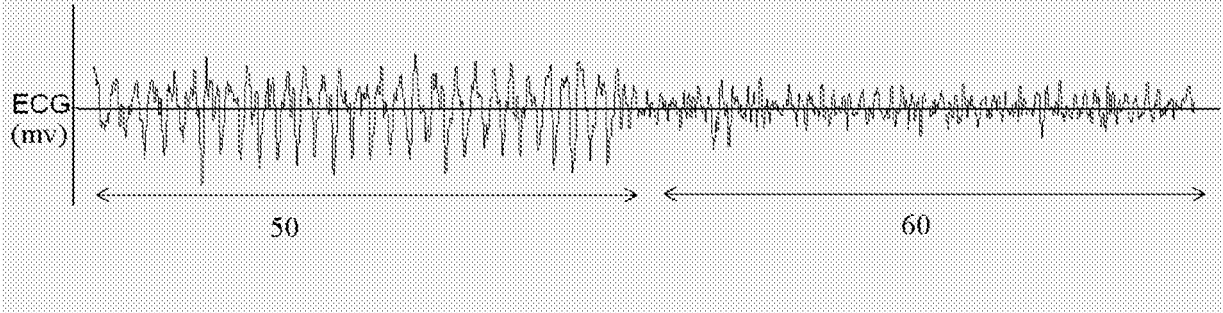

FIG. 4a

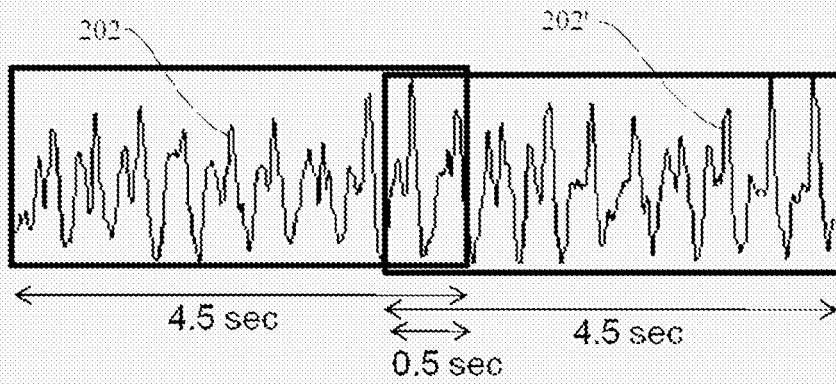

FIG. 4b

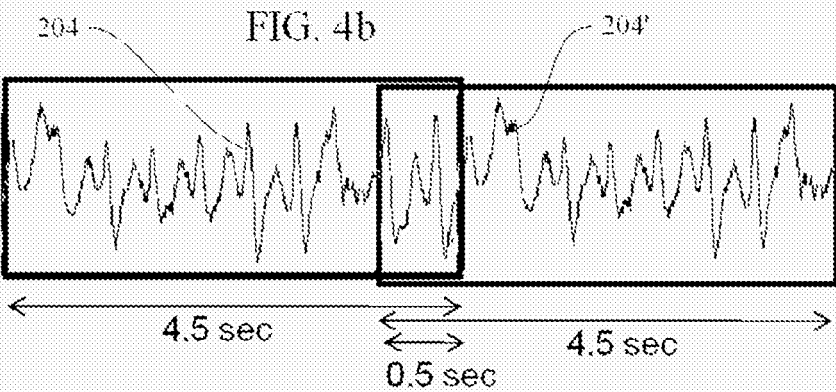

FIG. 3

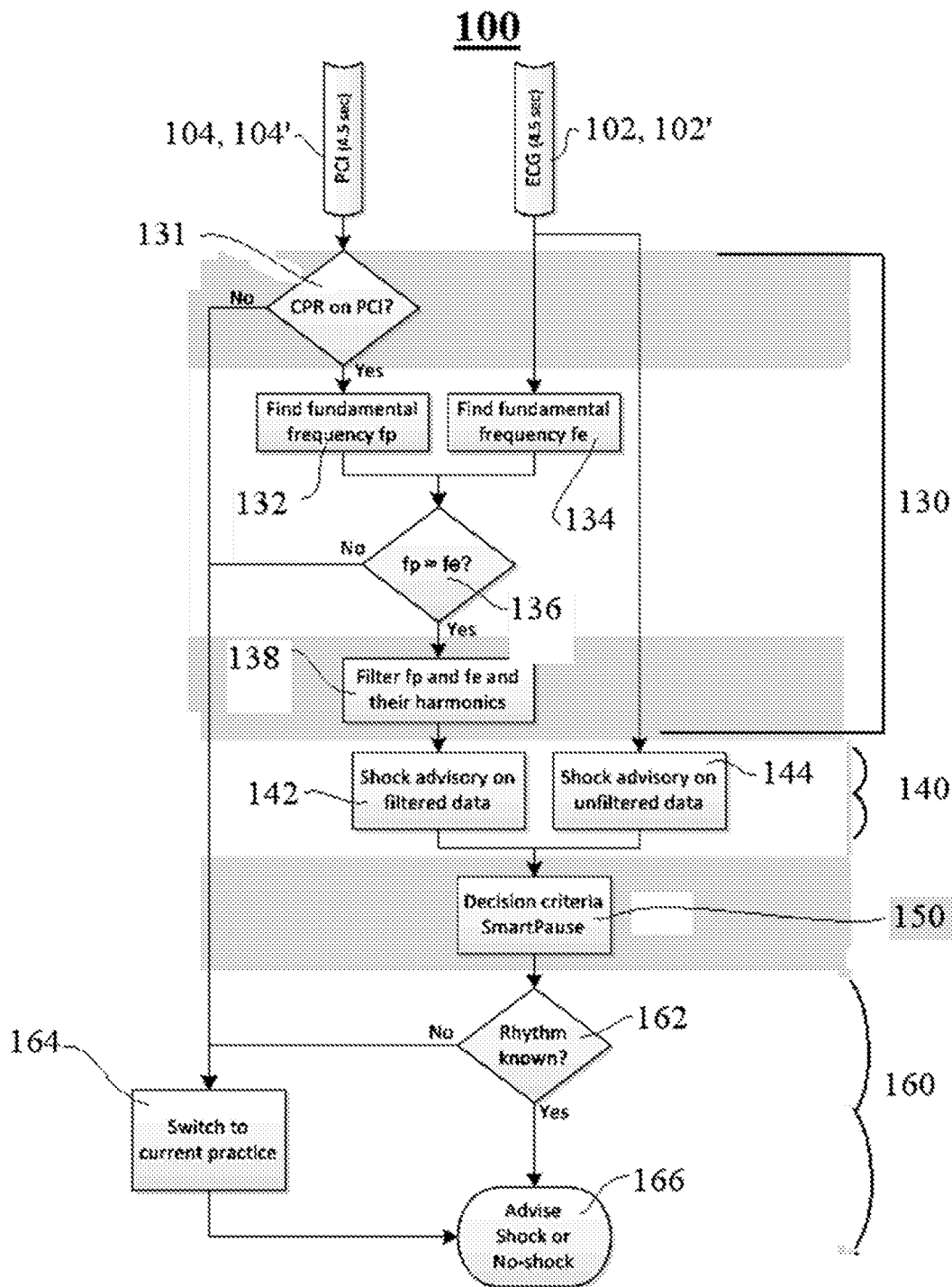

Fig. 5

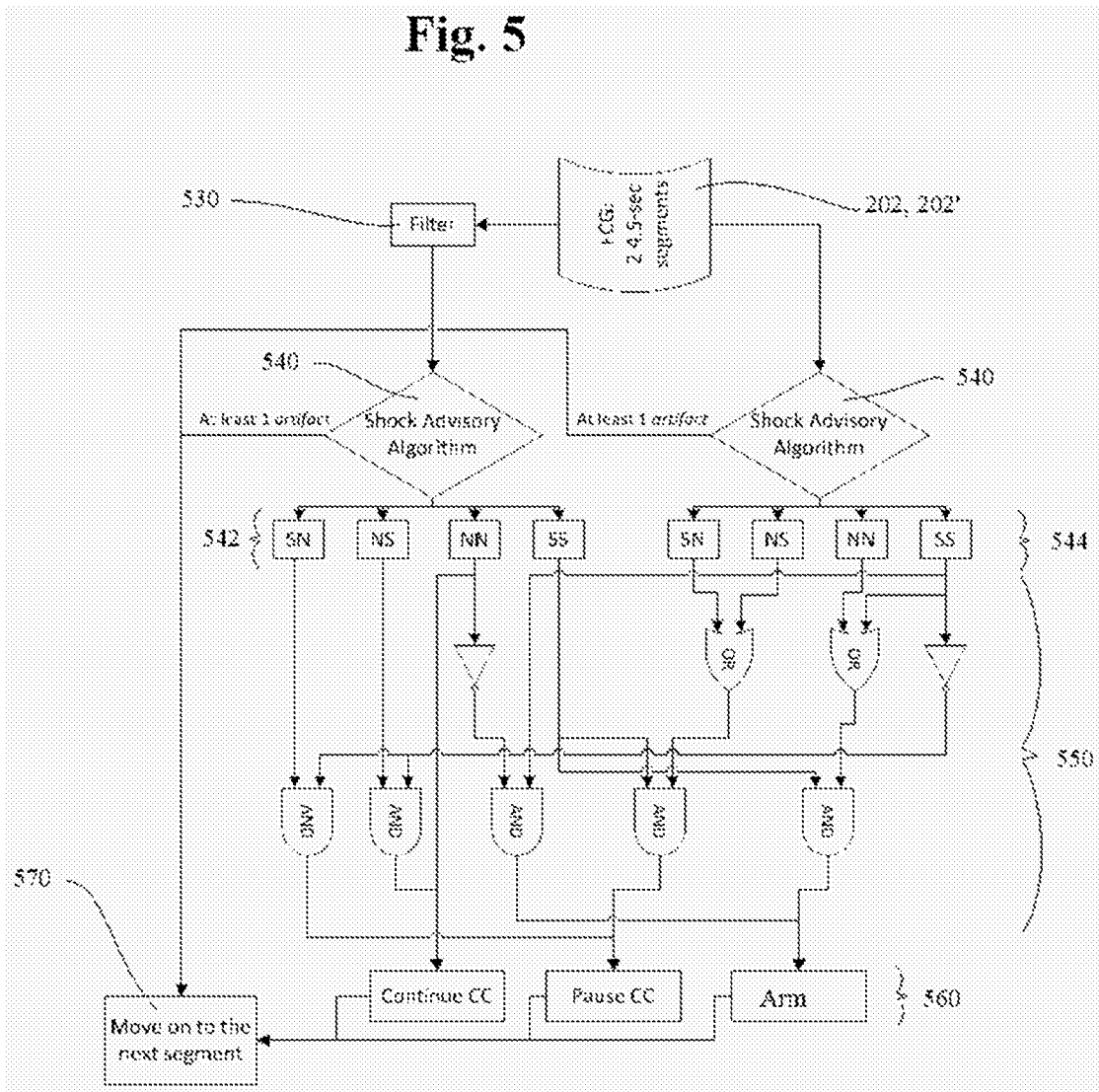

FIG. 6

		Shock Advisory Algorithm Advice		Final Decision
		1 <sup>st</sup> Segment	2 <sup>nd</sup> Segment	
Original data	→	Shock	Shock	Arm
	→	Shock	Shock	
Filtered data	→	Shock	Shock	Arm
	→	Shock	No-shock	
602	→	Shock	Shock	Arm
	→	No-shock	Shock	
604	→	No-Shock	No-Shock	Arm
	→	Shock	Shock	
602	→	No-shock	No-shock	Pause CPR
	→	Shock	No-shock	
604	→	Shock	No-shock	Pause CPR
	→	Shock	No-shock	
602	→	No-shock	Shock	Pause CPR
	→	Shock	No-shock	
604	→	Shock	No-Shock	Pause CPR
	→	Shock	Shock	
602	→	No-Shock	Shock	Pause CPR
	→	Shock	Shock	
		Any Other Combination		Continue CPR

FIG. 7

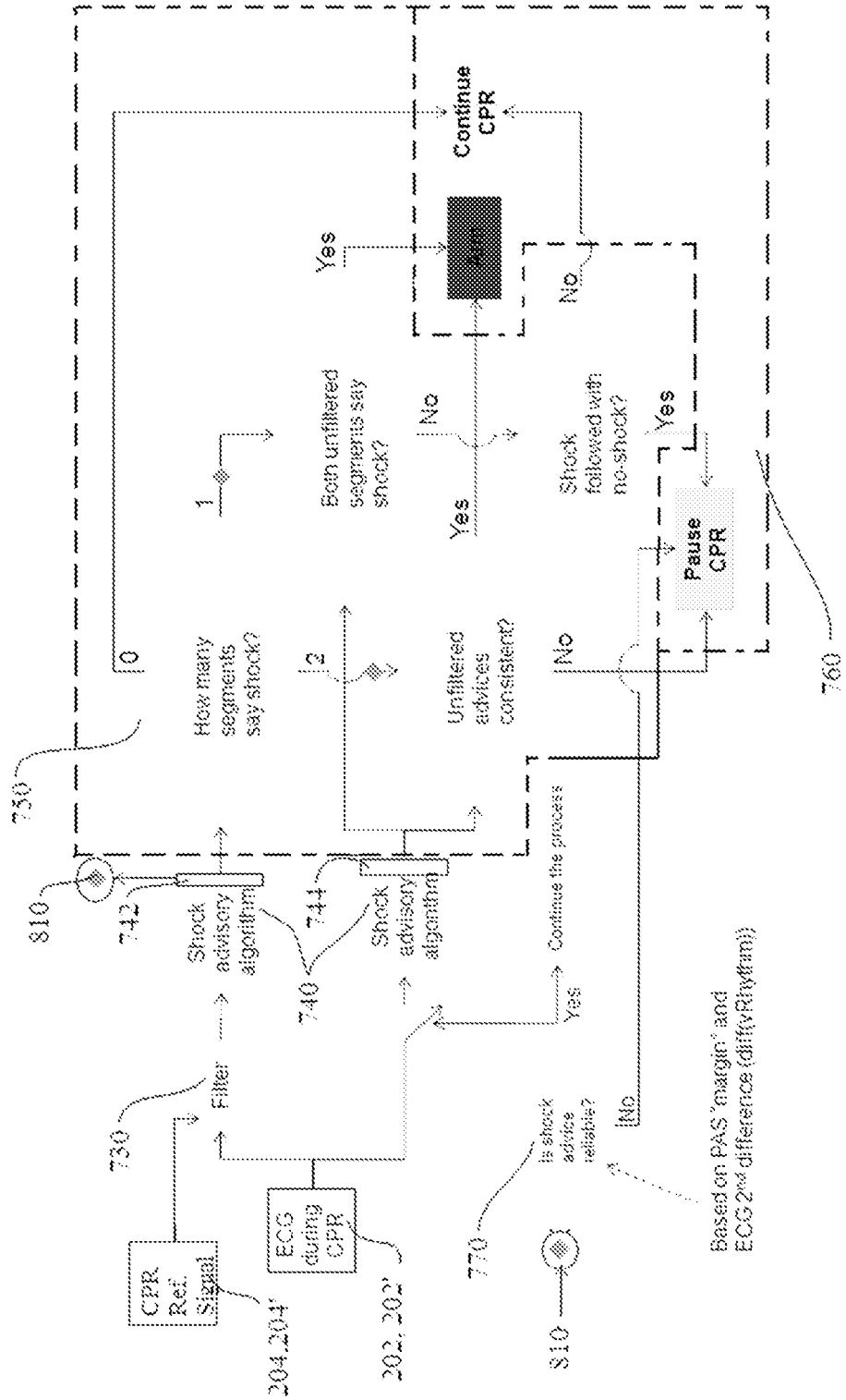

FIG. 8

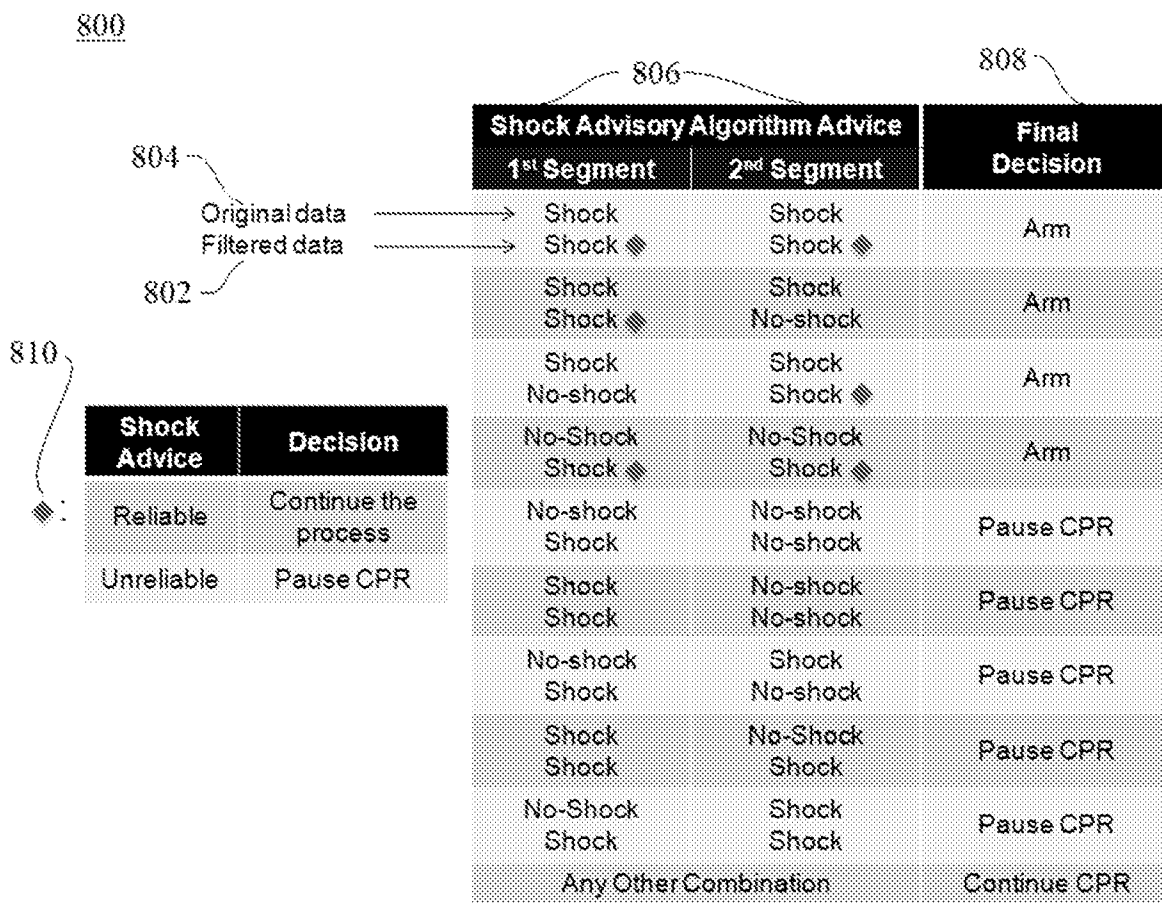
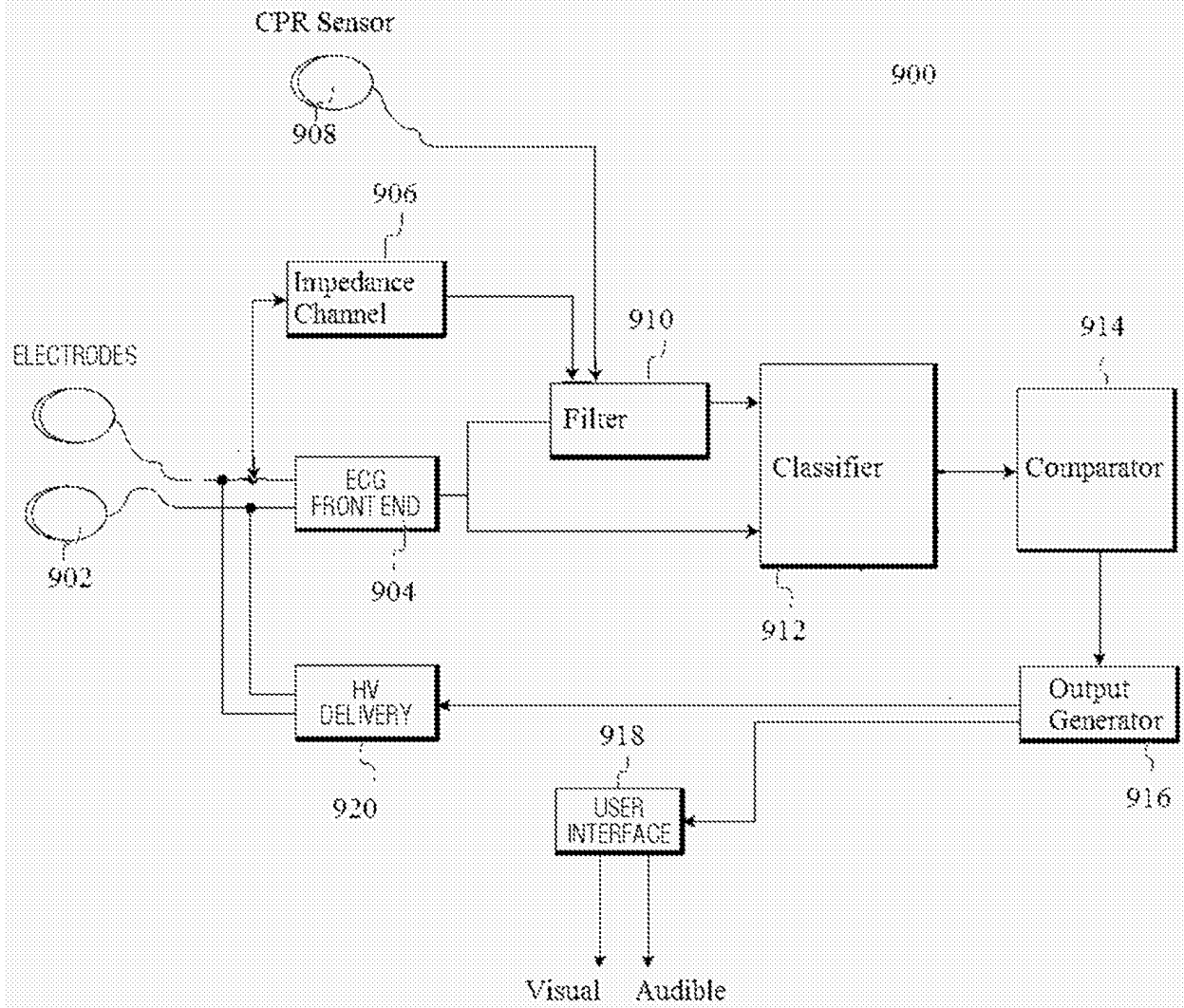

FIG. 9



**REFERENCES CITED IN THE DESCRIPTION**

*This list of references cited by the applicant is for the reader's convenience only. It does not form part of the European patent document. Even though great care has been taken in compiling the references, errors or omissions cannot be excluded and the EPO disclaims all liability in this regard.*

**Patent documents cited in the description**

- US 7108665 B [0007]
- US 20110105930 A1 [0009] [0011]
- WO 2011040929 A1 [0009]
- US 7567837 B [0009]
- WO 2006015348 A2 [0009]
- WO 6108578 A [0021]
- US 5701907 A [0024]
- US 20080208070 A1 [0039]

专利名称(译)	用于在cpr期间分析心律的装置		
公开(公告)号	<a href="#">EP2854627B1</a>	公开(公告)日	2018-08-29
申请号	EP2013737858	申请日	2013-05-29
[标]申请(专利权)人(译)	皇家飞利浦电子股份有限公司		
申请(专利权)人(译)	皇家飞利浦N.V.		
当前申请(专利权)人(译)	皇家飞利浦N.V.		
[标]发明人	BABAEIZADEH SAEED ZHOU SOPHIA HUAI		
发明人	BABAEIZADEH, SAEED ZHOU, SOPHIA HUAI		
IPC分类号	A61B5/00 A61B5/04 A61B5/0464 A61B5/0402 A61N1/39		
CPC分类号	A61B5/04012 A61B5/0464 A61B5/7217 A61N1/39 A61N1/3925 A61N1/39044 A61N1/3987		
代理机构(译)	STEFFEN , THOMAS		
优先权	61/654143 2012-06-01 US		
其他公开文献	EP2854627A1		
外部链接	<a href="#">Espacenet</a>		

摘要(译)

用于识别可通过除颤电击治疗的心律失常的诊断医疗设备包括用于过滤ECG数据集的除颤滤波器，分类器和电疗电路。分类器被配置为将经过滤和未经过滤的ECG数据集分类为“休克”建议或“无休克”建议。

