



(11) **EP 1 647 223 B1**

(12) **EUROPEAN PATENT SPECIFICATION**

(45) Date of publication and mention of the grant of the patent:  
**02.11.2016 Bulletin 2016/44**

(51) Int Cl.:  
**A61B 5/024** <sup>(2006.01)</sup> **A61B 5/00** <sup>(2006.01)</sup>  
**A61B 5/0245** <sup>(2006.01)</sup>

(21) Application number: **05109050.4**

(22) Date of filing: **30.09.2005**

(54) **Heart rate monitor, method and computer software product**

Herzfrequenzüberwachungsgerät sowie Methode und Software für dessen Gebrauch

Moniteur du rythme cardiaque ainsi qu'un procédé et un produit logiciel pour ledit moniteur

(84) Designated Contracting States:  
**AT BE BG CH CY CZ DE DK EE ES FI FR GB GR HU IE IS IT LI LT LU LV MC NL PL PT RO SE SI SK TR**

(30) Priority: **15.10.2004 FI 20045392**

(43) Date of publication of application:  
**19.04.2006 Bulletin 2006/16**

(73) Proprietor: **Polar Electro Oy**  
**90440 Kempele (FI)**

(72) Inventor: **Nissilä, Seppo**  
**90550, Oulu (FI)**

(74) Representative: **Kolster Oy Ab**  
**Iso Roobertinkatu 23**  
**PO Box 148**  
**00121 Helsinki (FI)**

(56) References cited:  
**WO-A-01/42809 WO-A-02/39363**  
**WO-A-02/067449 DE-A1- 19 952 164**  
**US-A- 5 840 039**

**EP 1 647 223 B1**

Note: Within nine months of the publication of the mention of the grant of the European patent in the European Patent Bulletin, any person may give notice to the European Patent Office of opposition to that patent, in accordance with the Implementing Regulations. Notice of opposition shall not be deemed to have been filed until the opposition fee has been paid. (Art. 99(1) European Patent Convention).

**Description**

## FIELD

**[0001]** The invention relates to a method for providing heart rate information, to a heart rate monitor and to a computer software product.

## BACKGROUND

**[0002]** As the geographical altitude increases, the atmospheric pressure decreases, which results in reduced air density. As the air density reduces, the oxygen content per volumetric unit decreases, which produces reactions in human physiological mechanisms, such as blood circulation, respiration and metabolism. At the same time the human aerobic performance declines. Moreover, pressure reduction has particular physiological effects on the human fluid balance, for instance.

**[0003]** Clearly detectable geographical-altitude-related effects on human physiology typically start above 1500 metres, which can be detected as changes in heart rate variables characterizing the heart rate, such as resting heart rate, heart rate during exercise and variations of heart rate. As the altitude increases the resting heart rate and the heart rate during exercise increase as the human body compensates for the oxygen deficit in muscles, whereas the variation of the heart rate and the maximum heart rate generally decrease instead.

**[0004]** In general, the reference values of the heart rate variables are determined at normal pressure. As altitude increases or air density otherwise decreases, the reference value determined at normal pressure does not correspond to pressure conditions, whereby the heart rate monitoring becomes more difficult and the user is not able to monitor his physiological condition on the basis of a variable value characterizing an instantaneous heart rate.

**[0005]** A use of an elevation sensor and a heart rate sensor is disclosed in WO 02/067449 in a modular personal network.

**[0006]** However, WO 02/067449 does not deal with reference values of the heart beat rate variables and the association of the reference values of the heart beat rate with environmental parameters values.

**[0007]** Thus it is useful to examine various manners to provide heart rate information.

## BRIEF DESCRIPTION

**[0008]** The object of the invention is to provide a heart rate monitor, a method and a computer software product so as to enable the user to take the prevailing pressure conditions into account while he or she monitors his/her physiological condition.

**[0009]** According to an aspect of the present invention, there is provided a user-specific heart rate monitor as specified in claim 1.

**[0010]** According to another aspect of the present invention, there is provided a method for generating heart rate information as specified in claim 8.

**[0011]** According to another aspect of the present invention, there is provided a computer software product as specified in claim 13.

**[0012]** The preferred embodiments of the invention are disclosed in the dependent claims.

**[0013]** The invention is based on the idea that by associating a reference value of a heart rate variable, such as resting heart rate, with an environmental parameter value and by recording said values in a register a stored logical data structure will be provided. The logical data structure can be used subsequently to generate heart rate reference information corresponding to prevailing environmental conditions while the heart rate is monitored.

**[0014]** Several advantages are achieved with the heart rate monitor, the method and the computer software product of the invention. One advantage of the invention is to enable calibration of the resting heart rate in the heart rate monitor as a function of pressure, the calibration being available to the user when the determination of the resting heart rate is not possible.

## LIST OF THE DRAWINGS

**[0015]** In the following the invention will be described in greater detail in connection with preferred embodiments with reference to the attached drawings, in which

Figure 1 is an example of the structure of a heart rate monitor;

Figure 2 is an example of a heart rate monitor in connection with a person;

Figure 3 shows part of an electrocardiogram;

Figure 4A shows curves including a reference value of a heart rate variable and an environmental parameter value;

Figure 4B shows a reference value of a heart rate variable as a function of an environmental parameter value;

Figure 5 shows as a flow chart an example of the structure of a heart rate monitor;

Figure 6 is an example of a display unit of the heart rate monitor;

Figure 7 shows a first example of a method in accordance with an embodiment; and

Figure 8 shows a second example of a method in accordance with an embodiment.

## DESCRIPTION OF THE EMBODIMENTS

**[0016]** Figure 1 shows an example of a structure of a user-specific heart rate monitor 100 based on the use of telemetry. The user-specific heart rate monitor 100 comprises electrodes 106A, 106B, an ECG (ElectroCardioGram) preamplifier 108 provided with differential feed

poles, a transmitter amplifier (TX AMP) 110, a transmitter coil (TX CL) 112, a receiver coil (RX CL) 116, a receiver amplifier (RX AMP) 118, a processing unit (PU) 120, a memory unit (MEM) 122 and a user interface (UI) 124.

**[0017]** Electrodes 106A, 106B sense the electric potential generated by the electric activity of the heart muscle and produce an ECG signal characterizing the electric activity of the heart muscle. The ECG signal is applied from the electrodes 106A, 106B to the ECG preamplifier 108.

**[0018]** The ECG preamplifier 108 pre-amplifies the ECG signal and feeds the pre-amplified ECG signal to the transmitter amplifier 110. The transmitter amplifier 110 may include a plurality of successive amplification stages, such as an AGC (Automatic Gain Control) amplifier and a power amplifier.

**[0019]** The amplified ECG signal is applied to the transmitter coil 112 that generates an electromagnetic field 114 transferring ECG data. The ECG data may include, for instance, the ECG as such, part of the ECG and/or heart rate timing information. The timing information may include a timing impulse that represents the timing of a predetermined ECG part.

**[0020]** In the given example a magnetic component of the electromagnetic field 114 serves as a transfer mechanism for a wireless connection. The solution presented is not restricted, however, to the use of the magnetic component of the electromagnetic field 114, but the ECG data transfer may use any form of telemetry.

**[0021]** The receiver coil 116 detects the electromagnetic field 114 generated by the transmitter coil 112 and produces an induced electric signal that is applied to the receiver amplifier 118.

**[0022]** The receiver amplifier 118 performs electric signal processing such as filtering and amplifying. In addition, the receiver amplifier may comprise a plurality of successive regulation stages.

**[0023]** The receiver amplifier 118 feeds the electric signal to the processing unit 120 that may perform analog signal modification of the electric signal, such as filtration and analog-to-digital conversions. In addition the processing unit 120 may perform digital processing such as digital filtering, signal shaping, ECG signal detecting, and ECG signal analysing.

**[0024]** In the processing unit 120 it is possible to determine a value for a heart rate variable characterizing the heart rate and/or a reference value for a heart rate variable. The heart rate variable may be a heart rate beat interval, a heart rate frequency, a variation of the heart rate interval and/or a variation of the heart rate frequency. The reference value for the heart rate variable may be a heart rate interval at rest, a heart rate frequency at rest, a reference value of the variation of the heart rate interval and/or a reference value of the variation of the heart rate frequency.

**[0025]** The processing unit 120 can be implemented using analog circuits, ASIC circuits (Application Specific Integrated Circuit), a digital processor, a memory and

computer software. The processing unit 120 may be part of the computer in the user-specific heart rate monitor 100.

**[0026]** Part of the data produced by the processing unit 120 can be stored in a memory unit 122 connected to the processing unit 120. In addition the memory unit 122 may include coded instructions for executing a computer process in the processing unit 120.

**[0027]** The user-specific heart rate monitor 100 further comprises a measurement module (MM) 130, which typically measures a value of a physical variable proportional to air density.

**[0028]** In one embodiment the measurement module 130 includes a pressure sensor that measures the ambient air pressure. The pressure sensor may generate a voltage level that is proportional to the pressure and that is converted into numeric format in the processing unit 120, for instance. Small pressure sensors employed in the user-specific heart rate monitor 100 can be implemented, for instance, by piezo resistive silicon components and they represent commercially available technology known per se. Miniature pressure sensors of MS54 series manufactured by Intersema can be given as an example.

**[0029]** In another embodiment the measurement module 130 includes a satellite navigator that determines the location coordinates of the heart rate monitor 100 including altitude data and optionally the time. For instance, the satellite navigator may record the altitude coordinate of the heart rate monitor 100 and optionally other determined coordinates into the processing unit 120. The satellite navigator may operate, for instance, in the GPS system (Global Positioning System), in the GLONASS (Global Navigation Satellite System) system or in another commonly used satellite positioning system. The implementation of the satellite navigator in the user-specific heart rate monitor system applications is technology known per se.

**[0030]** The user interface 124 typically includes a display unit 126 and a display controller. The display unit 126 may include, for instance, LCD components (Liquid Crystal Display). The display unit 126 may display graphically and/or numerically an instantaneous heart rate variable value, a reference value of the heart rate variable and/or measurement information produced by the measurement module 130, such as instantaneous air pressure and/or instantaneous location altitude.

**[0031]** The user interface 124 further includes a keypad 128 by means of which the user may record commands into the user-specific heart rate monitor 100.

**[0032]** The user-specific heart rate monitor 100 is characterized in that the user of the heart rate monitor monitors his or her own condition by means of the heart rate monitor.

**[0033]** The user-specific heart rate monitor 100 shown in Figure 1 can be divided into a transmitter part 102 and a receiver part 104. The transmitter part 102 typically includes device parts 106A to 112 and it performs the

ECG measurement and transmission of the ECG information to the receiver part 104. In some embodiments the transmitter part 102 may include a heart rate detector that detects a predetermined part of the ECG, generates a transmitter burst and/or bit stream representing the timing of the predetermined ECG part and transmits the transmitter burst to the receiver part 104.

**[0034]** The receiver part 104 typically includes device parts 116 to 128 that process the electric signal used in telemetry and the ECG information and provide a user interface. In addition the receiver part 104 typically includes a measurement module 130, but in some embodiments the measurement module 130 may also be located in the transmitter part 102. In that case the information generated by the measurement module 130 can be transmitted telemetrically to the receiver part 104.

**[0035]** With reference to the embodiment of Figure 2 the transmitter part 102 is placed in a transmitter belt 202 that is worn around the user's 200 chest. The ECG information is delivered telemetrically from the transmitter belt 202 to the receiver unit 204 that is typically a wrist-worn device. In some embodiments the receiver unit 204 is attachable to bicycle structures such as a handle bar. The placement of the receiver unit 204 is not restricted, however, to the wrist or the handle bar, but it can be placed anywhere with the proviso that a telemetric connection between the transmitter unit 202 and the receiver unit 204 is maintained and that the user is able to use the receiver unit 204.

**[0036]** In one embodiment the transmitter part 102 and the receiver part 104 are integrated in the same heart rate monitor, whereby a user-specific heart rate monitor worn on the wrist or held on the handle bar, for instance, is obtained. In that case some device parts of Figure 1, such as the coils 112, 116 and the amplifiers 110, 118, are not necessarily needed. In one embodiment the transmitter part 102 and part of the receiver part 104 are integrated in the transmitter belt 202, whereby the transmitter belt 202 may collect ECG data, process the ECG data and determine values of variables characterizing the heart rate. In that case the telemetric data transmission conveys processed data, such as variable values characterizing the heart rate and commands given by the user, from the transmitter belt 202 to the receiver unit 204. In that case the receiver unit 204 may also be telemetrically, optically or galvanically connected to the transmitter belt 202.

**[0037]** Figure 3 shows successive ECG pulses 304A, 304B in a time/voltage coordinate system 300, 302.

**[0038]** Each pulse 304A, 304B corresponds to one heartbeat with timing 316A, 316B. The interval between the pulses 304A, 304B is called a heart rate interval 318.

**[0039]** The pulse 304A, 304B has pre-detectable parts, such as P wave 306A, 306B, Q wave 308A, 308B, R wave 310A, 310B, S wave 312A, 312B and/or T wave 314A, 314B, which represent various phases of a heartbeat.

**[0040]** The generation mechanisms of P, Q, R, S and

T waves are known per se. The R wave 310A, 310B produces a strong and thus easily detectable structure in the pulse 304A, 304B, so the R wave 310A, 310B is generally used for detecting a QRS complex and for determining the pulse timing 316A, 316B.

**[0041]** The QRS complex can be detected with a pulse detector, for instance. The transmitter part 102 may generate, for instance, a burst corresponding to the timing of each pulse 304A, 304B, the burst being transmitted to the receiver part 104. The receiver part 104 receives the bursts and may determine, for instance, the heart rate interval 318 between the successive bursts. On the basis of the heart rate interval 318 it is possible to generate heart rate variables characterizing the heart rate, such as heart rate frequency, resting heart rate, variation in the heart rate interval and/or a reference value of the variation in the heart rate interval. Determination of the heart rate variables is known per se, and therefore it is not described in greater detail herein. The values of the heart rate variables can be recorded in the memory unit 122 for processing or for subsequent use.

**[0042]** Figure 4A shows an environmental parameter curve 406, 408 representing a value of an environmental parameter and a heart rate variable curve 414 representing a reference value of a heart rate variable. The horizontal axis 402 represents time dimension. It is assumed in Figure 4A that a change in the environmental parameter causes detectable changes in the value of the heart rate variable characterizing the heart rate and in the reference value of the heart rate variable.

**[0043]** The environmental parameter is typically a parameter characterizing air density in the ambient air of the heart rate monitor, so at the same time the environmental parameter characterizes the oxygen content in a volumetric unit. The environmental parameter may be the pressure prevailing in the vicinity of the heart rate monitor. In one embodiment the environmental parameter is the altitudinal location or the effective altitudinal location of the heart rate monitor. The effective altitudinal location corresponds to a free atmospheric altitude. The effective altitudinal location can be attained under controlled conditions such as in a pressure chamber or in an artificial, low-pressure "alpine hut". The effective altitudinal location can also be linked to the oxygen content of breathing air in a volumetric unit.

**[0044]** As an example of an environmental parameter curve is given an altitude curve 406 that represents the altitudinal location of the heart rate monitor, for instance, in kilometres. Thus the length variable unit such as kilometre appears on the vertical axis 404. The starting point 410 of the altitude curve 406 corresponds, for instance, to the altitude to which the user is acclimatized. The starting point 410 of the altitude curve is the sea level or the altitude of the user's domicile, for instance.

**[0045]** As another example of an environmental parameter is given a pressure curve 408 that is typically a function of the altitudinal location or the effective altitudinal location. Thus the pressure variable unit such as

millibar appears on the vertical axis 404. The starting point 412 of the pressure curve 408 is the normal atmospheric pressure (1013 mbar), for instance.

**[0046]** The heart rate variable curve 414 presents the reference value of the heart rate variable as the altitude/pressure conditions change. Thus the heart rate variable unit such as pulse per minute appears on the vertical axis 404. The starting point 416 of the heart rate variable reference value is the resting heart rate at normal atmospheric pressure, for instance.

**[0047]** At the altitude of 2000 metres the heart rate frequency typically increases 10 % as compared with the heart rate frequency at the sea level. When reaching the altitude of 4500 metres the heart rate frequency increases about 50 % as compared with that at sea level.

**[0048]** The situation in Figure 4A may represent, for instance, a take-off of an aircraft, whereby the time scale on the horizontal axis is a few minutes. The pressure curve 408 thus corresponds to the pressure inside the aircraft cabin, which does not correspond to the actual altitude of the plane due to the pressurization. Thus, the altitude curve 406 represents the effective altitudinal location. In this case there is no time for acclimatization, and the obtained reference values of the heart rate variable characterize the human's fast physiological response to changes in pressure.

**[0049]** The situation of Figure 4A may also represent a car drive or a cable car ride in the mountains.

**[0050]** When the environmental parameter varies on a relatively fast time scale, that is, in the order of less than 24 hours, the user's body has not time enough to adapt to the prevailing environmental conditions. Then, the reference value of the heart rate variable does not include the effect of acclimatization on the heart rate variable.

**[0051]** Figure 4A also shows a sampling point 418, 420 of the environmental parameter curve 406, 408 and a sampling point 422 of the heart rate variable curve 414. The sampling point 418, 420 of the environmental parameter curve 406, 408 is obtained from the determination of a physical variable proportional to air density, such as pressure and/or altitude, at the moment of determination  $t_m$ . The sampling point 422 of the heart rate variable 414 is obtained from the determination of the reference value of the heart rate variable at the moment of determination  $t_m$ .

**[0052]** The sampling point 418, 420 of the environmental parameter curve 406, 408 can be determined by measuring a plurality of physical variable values proportional to air density and by calculating the value of the sampling point 418, 420 of the environmental parameter curve 406, 408 corresponding to the moment of determination  $t_m$  from the average of the physical variable values proportional to air density. In that case the air pressure is measured, for instance, within a time interval  $t_1$  to  $t_2$ , during which the pressure varies within the pressure range  $p_1$  to  $p_2$ . The pressure value  $p_m$  corresponding to the moment of determination  $t_m$  will be  $p_m=(p_1+p_2)/2$ . The pressure value  $p_m$  may be as such the environmental

parameter value or the altitudinal location  $h_m$  can be generated therefrom. In the corresponding manner it is possible to determine the altitudinal location within the range of  $h_1$  to  $h_2$  by direct measurement, for instance, by means of a satellite navigation system, and to calculate the altitudinal location  $h_m$  corresponding to the moment of determination  $t_m$  from the expression  $h_m=(h_1+h_2)/2$ .

**[0053]** The sampling point 422 of the heart rate variable curve 414 can be determined by measuring the heart rate variable within the time interval  $t_1$  to  $t_2$ . The time interval  $t_1$  to  $t_2$  is typically the time interval used in the determination of the sampling point 418, 420 of the environmental parameter curve 406, 408. From the heart rate variable values determined within the time interval  $t_1$  to  $t_2$  it is possible to determine a reference value of the heart rate variable, for instance, as an average value. In one embodiment within the time interval  $t_1$  to  $t_2$  there is measured a heart rate average that corresponds to the resting heart rate.

**[0054]** The environmental parameter value and the reference value of the heart rate variable corresponding to the same moment of determination  $t_m$  constitute an associated pair, in which the reference value of the heart rate variable is associated with the environmental parameter value.

**[0055]** When a plurality of sampling points 418, 420 of the environmental parameter curve 406, 408 are measured as the value of the environmental parameter changes the presentation of Figure 4B is obtained. In Figure 4B the horizontal axis 424 represents pressure  $p$  and the vertical axis 426 represents the reference value  $HR_{ref}$  of the heart rate variable. Sampling points 430 and 432, which correspond to coordinates  $(p_{m1}, HR_{ref,m1})$  and  $(p_{m2}, HR_{ref,m2})$  in said order, are given as examples. Through the coordinates it is possible to form a heart rate variable curve 428.

**[0056]** Figure 5 is a block diagram of a heart rate monitor 500. The heart rate monitor 500 comprises a characterization unit (CU) 502 that determines a reference value 514 of a heart rate variable from the user's electrocardiogram. The characterization unit 502 may include, for instance, device parts 116 to 122 of a transmitter part 102 and a receiver part 104 shown in the figure.

**[0057]** The heart rate monitor 500 also comprises a determination unit (DU) 504 that determines an environmental parameter value 516.

**[0058]** The determination unit 504 comprises a measurement module 130 shown in Figure 1 and optionally parts of a processing unit 120.

**[0059]** In one aspect of the invention the measurement module 130 includes a pressure sensor. In that case the processing unit 120 receives pressure information generated by the pressure sensor and generates from the pressure information an air pressure and an altitudinal location.

**[0060]** In a second aspect of the invention the measurement module 130 includes means, such as a satellite navigator, for measuring the altitudinal location. In that

case the processing unit 120 receives from the measurement module 130 location information and generates from the location information an altitudinal location or an air pressure.

**[0061]** It is possible to use the air pressure and/or the altitudinal location as the environmental parameter value.

**[0062]** Conversions between the air pressure and the altitudinal location can be carried out in the processing unit 120 using the digital processor and the computer program of the processing unit 120.

**[0063]** The characterization unit 502 feeds the reference value 514 of the heart rate variable to an association unit (AU) 506. The determination unit 504 feeds the environmental parameter value 516 to the association unit 506.

**[0064]** The association unit 506 provides a logical link between the environmental parameter value 516 and the reference value 514 of the heart rate variable associated with the environmental parameter value 516. The logical link may be based, for instance, on indexing, by which the reference value 514 of the heart rate variable associated with the environmental parameter value 516 is indexed.

**[0065]** The association unit 506 can be implemented, for instance, in the processing unit 120 by means of a digital processor and a computer program.

**[0066]** The association unit 506 records a data element 518 comprised by the environmental parameter value 516 and the reference value 514 of the heart rate variable associated with the environmental parameter value 516 into a register (REG) 508. Thus the register 508 includes the environmental parameter 516 value and the reference value 514 of the heart rate variable associated with the environmental parameter value 516. The register 508 can be implemented, for instance, in the memory unit 122 of Figure 1. In addition the processing unit 120 may perform some register 508 functions such as indications to the memory of the register and restoration of data stored in the indicated memory locations.

**[0067]** In one embodiment the determination unit 504 determines a plurality of environmental parameter values 516 of different magnitudes and the characterization unit 502 determines a plurality of reference values 514 of the heart rate variable, for instance, by performing determinations of the sampling points 418, 420, 422 of Figure 4A for a plurality of successive determination moments  $t_m$ . Thus is obtained, for instance, the sampling points 430, 432 of the heart rate variable curve 428 shown in Figure 4B, which sampling points characterize the reference point of the heart rate variable as a function of air pressure.

**[0068]** The association unit 506 associates the reference values of the heart rate variable with the values of the environmental parameter such that each reference value 514 of the heart rate variable is associated with the environmental parameter value 516 determined at the moment of determination  $t_m$  of the heart rate variable

reference value 514.

**[0069]** The register 508 may comprise a logical data structure, such as a table, into which the environmental parameter values 516 and the reference values 514 of the heart rate variable associated therewith are recorded.

**[0070]** In one embodiment the heart rate monitor 500 comprises a controller 510 connected to the determination unit 504 and to the characterization unit 502. In one embodiment the controller starts the determination of the reference values 514 of the heart rate variable on the basis of the environmental parameter values 516. The controller 510 may include an algorithm that monitors, for instance, the environmental parameter values 516 as a function of time. In one embodiment the determination of the reference values 514 of the heart rate variable is started when a predetermined change rate is detected in the environmental parameter value 516. The predetermined change rate is typically defined to be so high that the user will not be able to attain by himself such a big change in pressure and/or effective altitude by walking or cycling, for instance. The selection of the predetermined change rate permits one to detect, for instance, that the user is aboard an aeroplane or in another environment that enables a fast change in pressure and/or effective altitude, whereby the effect of acclimatization on the reference value of the heart rate variable is minimized. The predetermined change rate of the environmental parameter may be in the order of 100 m/min or 10 mbar/min, for instance, but the presented solution is not restricted to those figures, however.

**[0071]** In one embodiment the controller 510 ends the determination of the reference values of the heart rate variable and the determination of the environmental parameter values 516 on the basis of the environmental parameter values. The controller may monitor and end the determination of the environmental parameter values and the reference values of the heart rate variable when the environmental parameter value reaches a threshold value. The threshold value may be a predetermined resting heart rate level or it may be a value generated from previous measurements of the environmental parameter values 516. Thus, for instance, as the pressure in the aircraft cabin is balanced, the controller detects the balancing of the pressure and ends the determination of the resting heart rate automatically.

**[0072]** The above-described determination, association and recording of the environmental parameter values 516 and the reference values 514 of the heart rate variables associated therewith enable calibration of the reference value of the heart rate variable with respect to the environmental parameter value. The logical data structure included in the register 508 and the environmental parameter values recorded therein and the reference values of the heart rate variable associated therewith can be utilized in a variety of ways.

**[0073]** In one embodiment the determination unit 504 determines an instantaneous value 522 of an environmental parameter while the user is experiencing a strain

for instance in the mountains. In that case the determination of the actual resting heart rate may be difficult due to a pre-measurement strain, possibly of long duration, and to the acclimatization.

**[0074]** The determination unit 504 records the instantaneous value 522 of the environmental parameter into the register 508.

**[0075]** The register 508 restores the reference value 520 of the heart rate variable to be associated with the instantaneous value 522 of the environmental parameter by using the environmental parameter values and the reference value of the heart rate variable associated with each environmental parameter value recorded in the register 508.

**[0076]** The register 508 does not necessarily include in advance the exact instantaneous value 522 of the environmental parameter and the reference value 520 of the heart rate variable to be associated therewith. So, the register 508 may determine the reference value 520 of the heart rate variable to be associated with the instantaneous value 522 of the environmental parameter, for instance, by using interpolation or optionally extrapolation. This can be performed, for instance, by forming a heart rate variable curve 428 as shown in Figure 4B and by searching a point 434 therein that corresponds to instantaneous pressure  $p_i$  and the reference value  $HR_{ref,i}$  of the heart rate variable corresponding to the instantaneous pressure.

**[0077]** In one embodiment the instantaneous value 522 of the environmental parameter is applied to a display unit (DISP) 512 that is configured to display the instantaneous value 522 of the environmental parameter and the reference value 520 of the heart rate variable to be associated with the instantaneous value 522 of the environmental parameter restored by the register. In that case the user may monitor the prevailing ambient pressure and the value of his resting heart rate corresponding to the pressure.

**[0078]** In one embodiment the characterization unit 502 determines an instantaneous value 524 of the heart rate variable characterizing the heart rate, such as the heart rate during exercise. The instantaneous value 524 of the heart rate variable can be fed into the display unit 512 and displayed in relation to the reference value 520 of the heart rate variable associated with the instantaneous value 522 of the environmental parameter. In that case the user may compare the instantaneous heart rate during exercise to the reference value of the heart rate corresponding to the prevailing pressure and/or altitude and adapt his physical strain in view of the prevailing pressure conditions.

**[0079]** The display unit 512 may be, for instance, a display unit 126 as shown in Figure 1.

**[0080]** With reference to Figure 6 the display unit may comprise a heart rate display segment (HR DISP) 602, a time display segment (D/T DISP) 604, an environmental parameter display segment (EP DISP) 606 and a control segment (C DISP) 608.

**[0081]** The heart rate display segment 602 typically shows an instantaneous numerical value of a heart rate variable, such as the instantaneous heart rate frequency or the instantaneous heart rate variation.

5 **[0082]** The time display segment 604 displays numerically a time variable such as the date, the time and/or a time variable relating to timing.

**[0083]** The environmental parameter display segment 606 displays numerically an instantaneous value 522 of an environmental parameter, such as pressure or altitude.

**[0084]** The control segment 608 typically displays menu elements and parameter values representing the operation of the heart rate monitor.

10 **[0085]** The display unit 512 may also include a graphic display (GD) 610 for graphical representation of the heart rate information and the environmental parameter information. The graphic display 610 may include a horizontal axis 618 and a scale 620A, 620B, 620C, 620D.

15 **[0086]** In one embodiment the display unit 610 displays the reference value 520 of the heart rate variable associated with the instantaneous value of the environmental parameter with a reference value indicator 614, the horizontal position of which indicates the resting heart rate corresponding to the prevailing air pressure. In addition the display unit 610 may display an instantaneous value 524 of the heart rate variable with a heart rate variable indicator 612, the horizontal position of which depends on the instantaneous value 524 of the heart rate variable.

20 **[0087]** The user may thus monitor the instantaneous value of the heart rate in relation to the resting heart rate corresponding to the prevailing air pressure by comparing the position of the heart rate variable indicator 612 to that of the reference value indicator 614.

25 **[0087]** The graphic display 610 may also include a maximum value indicator 616 that indicates a maximum value of a heart rate variable, such as the maximum heart rate or any other value of a variable characterizing the upper limit of the heart rate variable. The user may compare the position of the heart rate variable indicator 612 to that of the maximum value indicator 616 and adapt the strain suitably.

30 **[0088]** The graphic display 610 may also include a second reference value indicator 622. The second reference value indicator 622 may indicate the reference value of the heart rate variable stored in the register 510 in other than prevailing circumstances. In one embodiment the second reference value indicator 622 indicates the user's acclimatized resting heart rate. The acclimatized resting heart rate is a resting heart rate that is attained when the user has adapted to the ambient conditions. The acclimatized resting heart rate may be, for instance, the resting heart rate in the atmospheric normal pressure.

35 **[0089]** Figures 7 and 8 show methods in accordance with the presented solution.

**[0090]** In Figure 7 the method starts at 700.

**[0091]** At 702 a reference value 514 of a heart rate variable characterizing the heart rate is determined from

the user's electrocardiogram.

[0092] At 704 at least one value 516 of an environmental parameter obtainable from the air pressure is determined using air pressure measurement.

[0093] At 706 the reference value 514 of the heart rate variable is associated with at least one environmental parameter value 516.

[0094] At 708 at least one value 516 of the environmental parameter and the reference value 514 of the heart rate variable associated with the at least one environmental parameter value are recorded in the register.

[0095] At 710 an instantaneous value 522 of the environmental parameter is determined.

[0096] At 712 an instantaneous value 522 of the environmental parameter is recorded in the register 510.

[0097] At 714 an instantaneous value 524 of a heart rate variable characterizing an instantaneous heart rate is determined from the user's electrocardiogram.

[0098] At 716 the reference value 522 of the heart rate variable to be associated with the instantaneous value 522 of the environmental parameter is restored from the register 510 using the environmental parameter values recorded in the register 510 and the reference value 514 of the heart rate variable associated with each environmental parameter value.

[0099] At 718 the instantaneous value 522 of the environmental parameter and the reference value of the heart rate variable to be associated with the instantaneous environmental parameter value 522 are displayed.

[0100] At 720 there are displayed the reference value 520 of the heart rate variable to be associated with the instantaneous environmental parameter value 522 and the reference value 524 of the heart rate variable in relation to the reference value 520 of the heart rate variable to be associated with the instantaneous environmental parameter value 522.

[0101] The method ends at 722.

[0102] In Figure 8 the method starts at 800.

[0103] At 802 the determination of reference values 514 of a heart rate variable is started on the basis of environmental parameter values 516.

[0104] At 804 a plurality of reference values of the heart rate variable characterizing the heart rate are determined from the user's electrocardiogram.

[0105] At 806 a plurality of environmental parameter values 516 of different magnitudes are determined.

[0106] At 808 the reference values 514 of the heart rate variable are associated with the environmental parameter values 516 such that each reference value 514 of the heart rate variable is associated with the environmental parameter value 516 determined at the determination moment of the reference value 514 of the heart rate variable.

[0107] At 810 each environmental parameter value 516 and a reference value 514 of the heart rate variable associated with the environmental parameter value 516 are recorded in the register 510.

[0108] At 812 the determination of the reference values

514 of the heart rate variable and the determination of the environmental parameter values 516 on the basis of the environmental parameter values are finished.

[0109] At 814 the method ends.

[0110] One aspect of the invention is a computer software product that includes coded instructions for executing a computer process in the computer of the heart rate monitor. The embodiments of the computer process appear in Figures 7 and 8.

[0111] The computer software product can be stored on a distribution medium, such as a magnetic and/or optical storing medium, a hard disk or another means suitable for data storage and/or transfer. In addition the computer software product can be transferred using a computer-readable signal, such as a telecommunications signal.

[0112] Even though the invention is described above with reference to the accompanying drawings, it is obvious that the invention is not restricted thereto but it may be modified in a variety of ways within the scope of the attached claims.

## Claims

1. A user-specific heart rate monitor comprising:

characterizing means (502) for determining from the user's electrocardiogram a reference value of a heart rate variable characterizing the heart rate;

determining means (504) for determining at least one environmental parameter value proportional to air density using measurement of a physical variable proportional to air density;

associating means (506), connected to the characterizing means (502) and to the determining means (504), for associating the reference value of the heart rate variable with at least one environmental parameter value; and

a register (508), connected to the associating means (506), for recording in the register at least one environmental parameter value and the reference value of the heart rate variable associated with the at least one environmental parameter value;

### characterized in that:

the characterizing means (502) are arranged to determine from the user's electrocardiogram an instantaneous value of the heart rate variable characterizing an instantaneous heart rate;

the determining means (504) are configured to determine an instantaneous environmental parameter value;

the determining means (504) are configured to record the instantaneous environmental param-

- eter value into a register (508);  
the register (508) is configured to restore the reference value of the heart rate variable to be associated with the instantaneous environmental parameter value by using the environmental parameter values and the reference value of the heart rate variable associated with each environmental parameter value recorded in the register (508); and  
the heart rate monitor comprises first display means (514) that are configured to display the reference value of the heart rate variable to be associated with the instantaneous environmental parameter value and the instantaneous value of the heart rate variable in relation to the reference value of the heart rate variable associated with the instantaneous environmental parameter value.
2. The heart rate monitor of claim 1, **characterized in that**  
the characterizing means (502) are arranged to determine from the user's electrocardiogram a plurality of reference values of the heart rate variable characterizing the heart rate;  
the determining means (504) are configured to determine a plurality of environmental parameter values of different magnitudes;  
the associating means (506) are arranged to associate the reference values of the heart rate variable with the environmental parameter values such that each reference value of the heart rate variable is associated with the environmental parameter value determined at the determination moment of the reference value of the heart rate variable;  
the register (508) is arranged to record each environmental parameter value and the reference value of the heart rate variable associated with each environmental parameter value.
3. The heart rate monitor of claim 1, **characterized in that** the heart rate monitor further comprises starting means (510) that are connected to the characterizing means (502) and to the determining means (504), the starting means (510) being configured to start the determination of the reference values of the heart rate variable on the basis of the environmental parameter values.
4. The heart rate monitor of claim 1, **characterized in that** the heart rate monitor further comprises ending means (510) that are connected to the characterizing means (502) and to the determining means (504), the ending means (510) being configured to end the determination of the reference values of the heart rate variable and the determination of the environmental parameter values on the basis of the environmental parameter values.
5. The heart rate monitor of claim 1, **characterized in that**  
the determining means (504) are configured to determine an instantaneous environmental parameter value;  
the determining means (504) are configured to record the instantaneous environmental parameter value into the register (508);  
the register (508) is configured to restore the reference value of the heart rate variable associated with the instantaneous environmental parameter value by using the environmental parameter values and the reference value of the heart rate variable associated with each environmental parameter value recorded in the register (508); and  
the heart rate monitor further comprise second display means (512) that are configured to display the instantaneous environmental parameter value and the reference value of the heart rate variable to be associated with the instantaneous environmental parameter value.
6. The heart rate monitor of claim 1, **characterized in that** the reference value of the heart rate variable is at least one of the following: the user's resting heart rate, the reference value of the user's heart rate variation.
7. The heart rate monitor of claim 1, **characterized in that** the environmental parameter is at least one of the following: the measured air pressure, the altitudinal location of the heart rate monitor.
8. A method for providing heart rate information comprising:  
determining (702) from the user's electrocardiogram a reference value of a heart rate variable characterizing the heart rate;  
determining (704) at least one environmental parameter value proportional to air density using measurement of a physical variable proportional to air density;  
associating (706) the reference value of the heart rate variable with at least one environmental parameter value; and  
recording (708) in the register at least one environmental parameter value and a reference value of the heart rate variable associated with the at least one environmental parameter value;
- characterized in that** the method further comprises:  
determining (710) an instantaneous value of an environmental parameter;  
recording (712) the instantaneous value of the environmental parameter into a register;  
determining (714) from the user's electrocardi-

ogram an instantaneous value of the heart rate variable characterizing the heart rate; restoring (716) from the register the reference value of the heart rate variable to be associated with the instantaneous environmental parameter value using the environmental parameter values and the reference value of the heart rate variable associated with each environmental parameter value recorded in the register; and displaying (720) the reference value of the heart rate variable to be associated with the instantaneous environmental parameter value and the instantaneous value of the heart rate variable in relation to the reference value of the heart rate variable to be associated with the instantaneous environmental parameter value.

9. The method of claim 8, **characterized by** determining (804) from the user's electrocardiogram a plurality of reference values of the heart rate variable characterizing the heart rate; determining (806) a plurality of environmental parameter values of different magnitudes; associating (808) the reference values of the heart rate variable with the environmental parameter values such that each reference value of the heart rate variable is associated with the environmental parameter value determined at the determination moment of the reference value of the heart rate variable; and recording (810) in the register each environmental parameter value and the reference value of the heart rate variable associated with each environmental parameter.
10. The method of claim 8, **characterized by** starting (802) the determination of the reference values of the heart rate variable on the basis of the environmental parameter values.
11. The method of claim 8, **characterized by** ending (812) the determination of the reference values of the heart rate variable and the determination of the environmental parameter values on the basis of the environmental parameter values.
12. The method of claim 8, **characterized by** determining (710) an instantaneous value of an environmental parameter; recording (712) the instantaneous value of the environmental parameter into a register; restoring (716) from the register the reference value of the heart rate variable to be associated with the instantaneous environmental parameter value using the environmental parameter values and the reference value of the heart rate variable associated with each environmental parameter value recorded in the register; and displaying (718) the instantaneous environmental

parameter value and the reference value of the heart rate variable to be associated with each environmental parameter value.

- 5 13. A computer software product that includes coded instructions for executing a computer process in a computer of a heart rate monitor, the computer process comprising:
- 10 determining (702) from the user's electrocardiogram a reference value of a heart rate variable characterizing the heart rate; determining (704) at least one environmental parameter value proportional to air density using measurement of a physical variable proportional to air density;
- 15 associating (706) the reference value of the heart rate variable with the at least one environmental parameter value; and recording (708) in a register at least one environmental parameter value and the reference value of the heart rate variable associated with the at least one environmental parameter value

**characterized in that** the computer process further comprises:

- determining (710) an instantaneous value of an environmental parameter; recording (712) the instantaneous value of the environmental parameter into a register; determining (714) from the user's electrocardiogram an instantaneous value of the heart rate variable characterizing the heart rate; restoring (716) from the register the reference value of the heart rate variable to be associated with the instantaneous environmental parameter value using the environmental parameter values and the reference value of the heart rate variable associated with each environmental parameter value recorded in the register; and displaying (720) the reference value of the heart rate variable to be associated with the instantaneous environmental parameter value and the instantaneous value of the heart rate variable in relation to the reference value of the heart rate variable to be associated with the instantaneous environmental parameter value.

#### Patentansprüche

1. Ein Benutzer spezifischer Herzfrequenzmonitor, welcher aufweist:
- Charakterisierungsmittel (502) zum Bestimmen, basierend auf dem Elektrokardiogramm des Benutzers, eines Referenzwerts einer Va-

riable der Herzfrequenz, welche die Herzfrequenz charakterisiert;  
 Bestimmungsmittel (504) zum Bestimmen von mindestens einem Umgebungsparameterwert, welcher proportional zur Luftdichte ist, unter der Verwendung einer Messung einer physikalischen Variable, welche proportional zur Luftdichte ist;  
 Zuordnungsmittel (506), welche mit den Charakterisierungsmitteln (502) verbunden sind und welche mit den Bestimmungsmitteln (504) verbunden sind, zum Zuordnen des Referenzwerts der Variable der Herzfrequenz zu dem mindestens einem Umgebungsparameterwert; und ein Register (508), welches mit den Zuordnungsmitteln (506) gekoppelt ist, um den mindestens einen Umgebungsparameterwert und den Referenzwert der Variable der Herzfrequenz zugeordnet zu dem mindestens einen Umgebungsparameterwert in das Register aufzunehmen;

**dadurch gekennzeichnet, dass:**

die Charakterisierungsmittel (502) angeordnet sind, einen momentanen Wert der Variable der Herzfrequenz, welcher die Herzfrequenz momentan charakterisiert, basierend auf dem Elektrokardiogramm des Benutzers, zu bestimmen; die Bestimmungsmittel (504) konfiguriert sind, einen momentanen Umgebungsparameterwert zu bestimmen;  
 die Bestimmungsmittel (504) konfiguriert sind, den momentanen Umgebungsparameterwert in das Register (508) abzuspeichern;  
 das Register (508) konfiguriert ist, den Referenzwert der Variable der Herzfrequenz widerherzustellen, welcher dem momentanen Umgebungsparameterwert zu zuordnen ist, unter Verwendung der Umgebungsparameterwerte und des jeweiligen Referenzwertes der Variable der Herzfrequenz zugeordnet zu dem jeweiligen mindestens einem Umgebungsparameterwert abgespeichert in dem Register (508); und der Herzfrequenzmonitor umfasst erste Anzeigemittel (514), die konfiguriert sind, den Referenzwert der Variable der Herzfrequenz anzuzeigen, welcher dem momentanen Umgebungsparameterwert zuzuordnen ist, und den momentanen Wert der Variable der Herzfrequenz in Bezug auf den Referenzwert der Variable der Herzfrequenz anzuzeigen, welcher dem momentanen Umgebungsparameterwert zugeordnet ist.

2. Der Herzfrequenzmonitor nach Anspruch 1, **dadurch gekennzeichnet, dass** die Charakterisierungsmittel (502) angeordnet sind, basierend auf

dem Elektrokardiogramm des Benutzers, eine Vielzahl von Referenzwerten der Variable der Herzfrequenz zu bestimmen, welche die Herzfrequenz charakterisieren;

die Bestimmungsmittel (504) sind konfiguriert, eine Mehrzahl von Umgebungsparameterwerten verschiedener Größen zu bestimmen;

die Zuordnungsmittel (506) sind angeordnet, die Referenzwerte der Variable der Herzfrequenz den Umgebungsparameterwerten zuzuordnen, so dass jeder Referenzwert der Variable der Herzfrequenz mit einem Umgebungsparameterwerte zugeordnet ist, welcher zu einem Zeitpunkt der Bestimmung des Referenzwertes der Variablen der Herzfrequenz bestimmt wurde;

das Register (508) angeordnet ist, jeden Umgebungsparameterwert und den Referenzwert der Variablen der Herzfrequenz, welcher zu dem jeweiligen Referenzwert der Variable der Herzfrequenz zugeordnet ist, abzuspeichern.

3. Der Herzfrequenzmonitor nach Anspruch 1, **dadurch gekennzeichnet, dass** der Herzfrequenzmonitor ferner Startmittel (510) umfasst, welche mit den mit den Charakterisierungsmitteln (502) und welche mit den Bestimmungsmitteln (504) verbunden sind, wobei die Startmittel (510) konfiguriert sind, die Bestimmung der Referenzwerte der Variablen der Herzfrequenz auf der Grundlage der Umgebungsparameterwerte zu starten.
4. Der Herzfrequenzmonitor nach Anspruch 1, **dadurch gekennzeichnet, dass** der Herzfrequenzmonitor ferner Terminierungsmittel (510) umfasst, welche mit den mit den Charakterisierungsmitteln (502) und welche mit den Bestimmungsmitteln (504) verbunden sind, die Terminierungsmittel (510) sind konfiguriert, die Bestimmung der Referenzwerte der Variablen der Herzfrequenz auf der Grundlage der Umgebungsparameterwerte zu beenden.
5. Der Herzfrequenzmonitor nach Anspruch 1, **dadurch gekennzeichnet, dass** die Bestimmungsmittel (504) konfiguriert sind, einen momentanen Umgebungsparameterwert zu bestimmen; die Bestimmungsmittel (504) konfiguriert sind, den momentanen Umgebungsparameterwert in das Register (508) abzuspeichern; das Register (508) konfiguriert ist, den Referenzwert der Variable der Herzfrequenz widerherzustellen, zugeordnet zu dem momentanen Umgebungsparameterwert, unter Verwendung der Umgebungsparameterwerte und des jeweiligen Referenzwertes der Variable der Herzfrequenz zugeordnet zu dem jeweiligen mindestens einem Umgebungsparameterwert, abgespeichert in dem Register (508); und der Herzfrequenzmonitor umfasst zweite Anzeige-

mittel (512), die konfiguriert sind, den momentanen Referenzwert der Variable der Herzfrequenz anzuzeigen, und den Referenzwert der Variable der Herzfrequenz anzuzeigen, welcher dem momentanen Umgebungsparameterwert zugeordnet ist.

6. Der Herzfrequenzmonitor nach Anspruch 1, **dadurch gekennzeichnet, dass** der Referenzwert der Variable der Herzfrequenz mindestens einer der folgenden ist: die Herzfrequenz, des Benutzers in Ruhe, der Referenzwert der Variation der Herzfrequenz des Benutzers.
7. Der Herzfrequenzmonitor nach Anspruch 1, **dadurch gekennzeichnet, dass** die Umgebungsparameter mindestens eines der folgenden: der gemessene Luftdruck, die Höhenlage des Ortes des Herzfrequenzmonitors.
8. Verfahren zur Bereitstellung von Informationen über die Herzfrequenz, das Verfahren umfassend:

Bestimmen (702) aus dem Elektrokardiogramm des Benutzers eines Referenzwertes von einer Variable der Herzfrequenz, die die Herzfrequenz charakterisiert;

Bestimmen (704) mindestens eines Umgebungsparameterwertes proportional zur Luftdichte unter Verwendung einer Messung einer physikalischen Größe proportional zur Luftdichte;

Zuordnen (706) des Referenzwertes der Variable der Herzfrequenz zu dem mindestens einen Umgebungsparameterwert; und

Abspeichern (708) von mindestens einem Umgebungsparameterwert und dem Referenzwert der Variable der Herzfrequenz zugeordnet zu dem mindestens einen Umgebungsparameterwert in das Register;

**dadurch gekennzeichnet, dass** das Verfahren ferner umfasst:

Bestimmen (710) eines momentanen Umgebungsparameterwertes;

Abspeichern (712) des momentanen Umgebungsparameterwertes in ein Register; Bestimmen (714) eines momentanen Wertes der Variable der Herzfrequenz aus dem Elektrokardiogramm des Benutzers, welcher die Herzfrequenz charakterisiert;

Wiederherstellen (716), aus dem Register, des Referenzwertes der Variable der Herzfrequenz, welcher dem momentanen Umgebungsparameterwert zuzuordnen ist, unter Verwendung der Umgebungsparameterwerte und des jeweiligen Referenzwertes der Variable der Herzfrequenz zugeordnet zu dem jeweiligen mindes-

tens einem Umgebungsparameterwert; und Anzeigen (720) des Referenzwertes der Variable der Herzfrequenz, welcher dem momentanen Umgebungsparameterwert zugeordnet ist, und des momentanen Wertes der Variable der Herzfrequenz in Bezug auf den Referenzwert der Variable der Herzfrequenz, welcher dem momentanen Umgebungsparameterwert zugeordnet ist.

9. Das Verfahren nach Anspruch 8, **gekennzeichnet durch**

Bestimmen (804) aus dem Elektrokardiogramm des Benutzers einer Vielzahl von Referenzwerten der Variablen der Herzfrequenz, welche die Herzfrequenz charakterisieren;

Bestimmen (806) einer Vielzahl von Umgebungsparameterwerten unterschiedliche Größen;

Zuordnen (808) der Referenzwerten der Variablen der Herzfrequenz zu den Umgebungsparameterwerte, so dass jeder Referenzwert der Variable der Herzfrequenz mit einem Umgebungsparameterwerte zugeordnet ist, welcher zu einem Zeitpunkt der Bestimmung des Referenzwertes der Variablen der Herzfrequenz bestimmt wurde; und Abspeichern (810), in dem Register, von jeden Umgebungsparameterwert und den Referenzwert der Variablen der Herzfrequenz mit dem jeweils zugehörigen Umgebungsparameterwert.

10. Das Verfahren nach Anspruch 8, **gekennzeichnet durch**

ein Starten (802) der Bestimmung der Referenzwerte der Variablen der Herzfrequenz auf der Basis von den Umgebungsparameterwerten.

11. Das Verfahren nach Anspruch 8, **gekennzeichnet durch**

ein Beenden (812) der Bestimmung der Referenzwerte der Variablen der Herzfrequenz und ein Beenden der Bestimmung der Umgebungsparameterwerte auf der Basis von den Umgebungsparameterwerte.

12. Das Verfahren nach Anspruch 8, **gekennzeichnet durch**

Bestimmen (710) eines momentanen Wertes eines Umgebungsparameters; Abspeichern (712) des momentanen Wertes des Umgebungsparameters in ein Register;

Wiederherstellen (716), aus dem Register, des Referenzwertes der Variable der Herzfrequenz, welcher dem momentanen Umgebungsparameterwert zu zuordnen ist, unter Verwendung der Umgebungsparameterwerte und des jeweiligen Referenzwertes der Variable der Herzfrequenz zugeordnet zu jedem Umgebungsparameterwert abgespeichert in dem Register; und

Anzeigen (718) des momentan Wertes des Umgebungsparameters und des Referenzwertes der Variable der Herzfrequenz, welcher zu jedem momentanen Umgebungsparameterwert zuzuordnen ist.

13. Ein Computersoftwareprodukt, das kodierte Befehle zum Ausführen eines Computerprogramms in einem Computer eines Herzfrequenzmonitors enthält, das Computerprogramm umfasst:

Bestimmen (702) aus dem Elektrokardiogramm des Benutzers eines Referenzwerts von einer Variable der Herzfrequenz, die die Herzfrequenz charakterisiert;

Bestimmen (704) von mindestens einem Umgebungsparameterwert proportional zur Luftdichte unter Verwendung einer Messung einer physikalischen Größe proportional zur Luftdichte; Zuordnen (706) des Referenzwert der Variable der Herzfrequenz zu dem mindestens einen Umgebungsparameterwert; und

Aufzeichnen (708) von mindestens einem Umgebungsparameterwert und dem Referenzwert der Variable der Herzfrequenz zugeordnet zu dem mindestens einen Umgebungsparameterwert in das Register;

**dadurch gekennzeichnet, dass** das Verfahren ferner umfasst:

Bestimmen (710) eines momentanen Umgebungsparameterwertes;

Abspeichern (712) des momentanen Umgebungsparameterwertes in ein Register;

Bestimmen (714) eines momentanen Wertes der Variable der Herzfrequenz aus dem Elektrokardiogramm des Benutzers, welcher die Herzfrequenz charakterisiert;

Wiederherstellen (716), aus dem Register, des Referenzwertes der Variable der Herzfrequenz widerherzustellen, zugeordnet zu dem momentanen Umgebungsparameterwert, unter Verwendung der Umgebungsparameterwerte und des jeweiligen Referenzwertes der Variable der Herzfrequenz zugeordnet zu dem jeweiligen mindestens einem Umgebungsparameterwert; und

Anzeigen (720) des Referenzwertes der Variable der Herzfrequenz, welcher dem momentanen Umgebungsparameterwert zugeordnet ist, und des momentanen Wertes der Variable der Herzfrequenz in Bezug auf den Referenzwert der Variable der Herzfrequenz, welcher dem momentanen Umgebungsparameterwert zugeordnet ist.

## Revendications

1. Moniteur de fréquence cardiaque spécifique à un utilisateur comprenant :

des moyens de caractérisation (502) permettant de déterminer, à partir de l'électrocardiogramme de l'utilisateur, une valeur de référence d'une variable de fréquence cardiaque caractérisant la fréquence cardiaque ;

des moyens de détermination (504) permettant de déterminer au moins une valeur de paramètre environnemental proportionnelle à la densité de l'air à l'aide d'une mesure d'une variable physique proportionnelle à la densité de l'air ;

des moyens d'association (506), connectés aux moyens de caractérisation (502) et aux moyens de détermination (504), permettant d'associer la valeur de référence de la variable de fréquence cardiaque avec au moins une valeur de paramètre environnemental ; et

un registre (508), connecté aux moyens d'association (506), permettant d'enregistrer, dans le registre, au moins une valeur de paramètre environnemental et la valeur de référence de la variable de fréquence cardiaque associée avec l'au moins une valeur de paramètre environnemental ;

**caractérisé en ce que :**

les moyens de caractérisation (502) sont conçus pour déterminer, à partir de l'électrocardiogramme d'un utilisateur, une valeur instantanée de la variable de fréquence cardiaque caractérisant une fréquence cardiaque instantanée ;

les moyens de détermination (504) sont conçus pour déterminer une valeur de paramètre environnemental instantanée ;

les moyens de détermination (504) sont conçus pour enregistrer la valeur de paramètre environnemental instantanée dans un registre (508) ;

le registre (508) est conçu pour restaurer la valeur de référence de la variable de fréquence cardiaque à associer avec la valeur de paramètre environnemental instantanée à l'aide des valeurs de paramètres environnementaux et de la valeur de référence de la variable de fréquence cardiaque associée à chaque valeur de paramètre environnemental enregistrée dans le registre (508) ; et

le moniteur de fréquence cardiaque comprend des premiers moyens d'affichage (514) qui sont conçus pour afficher la valeur de référence de la variable de fréquence cardiaque à associer avec la valeur de paramètre environnemental instantanée et la valeur instantanée de la variable de fréquence cardiaque en relation avec la

- valeur de référence de la variable de fréquence cardiaque associée à la valeur de paramètre environnemental instantanée.
2. Moniteur de fréquence cardiaque selon la revendication 1, **caractérisé en ce que** les moyens de caractérisation (502) sont conçus pour déterminer, à partir de l'électrocardiogramme d'un utilisateur, une pluralité de valeurs de référence de la variable de fréquence cardiaque caractérisant la fréquence cardiaque ;  
 les moyens de détermination (504) sont conçus pour déterminer une pluralité de valeurs de paramètres environnementaux de différentes amplitudes ;  
 les moyens d'association (506) sont conçus pour associer les valeurs de référence de la variable de fréquence cardiaque avec les valeurs de paramètres environnementaux de façon à ce que chaque valeur de référence de la variable de fréquence cardiaque soit associée à la valeur de paramètre environnemental déterminé au moment de la détermination de la valeur de référence de la variable de fréquence cardiaque ;  
 le registre (508) est conçu pour enregistrer chaque valeur de paramètre environnemental et la valeur de référence de la variable de fréquence cardiaque associée à chaque valeur de paramètre environnemental.
    3. Moniteur de fréquence cardiaque selon la revendication 1, **caractérisé en ce que** le moniteur de fréquence cardiaque comprend en outre des moyens de démarrage (510) qui sont connectés aux moyens de caractérisation (502) et aux moyens de détermination (504), les moyens de démarrage (510) étant conçus pour démarrer la détermination des valeurs de référence de la variable de fréquence cardiaque sur la base des valeurs des paramètres environnementaux.
    4. Moniteur de fréquence cardiaque selon la revendication 1, **caractérisé en ce que** le moniteur de fréquence cardiaque comprend des moyens de terminaison (510) qui sont connectés aux moyens de caractérisation (502) et aux moyens de détermination (504), les moyens de terminaison (510) étant conçus pour terminer la détermination des valeurs de référence de la variable de fréquence cardiaque et la détermination des valeurs des paramètres environnementaux sur la base des valeurs des paramètres environnementaux.
    5. Moniteur de fréquence cardiaque selon la revendication 1, **caractérisé en ce que** les moyens de détermination (504) sont conçus pour déterminer une valeur de paramètre environnemental instantanée ;  
 les moyens de détermination (504) sont conçus pour enregistrer la valeur de paramètre environnemental instantanée dans le registre (508) ;  
 le registre (508) est conçu pour restaurer la valeur de référence de la variable de fréquence cardiaque associée à la valeur de paramètre environnemental instantanée et la valeur de référence de la variable de fréquence cardiaque associée à chaque valeur de paramètre environnemental enregistrée dans le registre (508) ; et  
 le moniteur de fréquence cardiaque comprend en outre des deuxièmes moyens d'affichage (512) qui sont conçus pour afficher la valeur de paramètre environnemental instantanée et la valeur de référence de la variable de fréquence cardiaque à associer avec la valeur de paramètre environnemental instantanée.
    6. Moniteur de fréquence cardiaque selon la revendication 1, **caractérisé en ce que** la valeur de référence de la variable de fréquence cardiaque est au moins une des valeurs suivantes : la fréquence cardiaque au repos de l'utilisateur, la valeur de référence de la variation de la fréquence cardiaque de l'utilisateur.
    7. Moniteur de fréquence cardiaque selon la revendication 1, **caractérisé en ce que** le paramètre environnemental est au moins un des paramètres suivants : la pression d'air mesurée, la position en altitude du moniteur de fréquence cardiaque.
    8. Procédé de fourniture d'informations concernant une fréquence cardiaque comprenant :  
 la détermination (702), à partir de l'électrocardiogramme d'un utilisateur, d'une valeur de référence d'une variable de fréquence cardiaque caractérisant la fréquence cardiaque ;  
 la détermination (704) d'au moins une valeur de paramètre environnemental proportionnelle à la densité de l'air à l'aide d'une mesure d'une variable physique proportionnelle à la densité de l'air ;  
 l'association (706) de la valeur de référence de la variable de fréquence cardiaque à au moins une valeur de paramètre environnemental ; et  
 l'enregistrement (708), dans le registre, d'au moins une valeur de paramètre environnemental et d'une valeur de référence de la variable de fréquence cardiaque associée à l'au moins une valeur de paramètre environnemental ;  
**caractérisé en ce que** le procédé comprend en outre :  
 la détermination (710) d'une valeur instantanée d'un paramètre environnemental ;  
 l'enregistrement (712) de la valeur instantanée

- du paramètre environnemental dans un registre ;  
la détermination (714), à partir de l'électrocardiogramme d'un utilisateur, d'une valeur instantanée de la variable de fréquence cardiaque caractérisant la fréquence cardiaque ;  
la restauration (716), à partir du registre, de la valeur de référence de la variable de fréquence cardiaque à associer avec la valeur de paramètre environnemental instantanée à l'aide des valeurs de paramètres environnementaux et de la valeur de référence de la variable de fréquence cardiaque associée à chaque valeur de paramètre environnemental enregistrée dans le registre ; et  
affichage (720) de la valeur de référence de la variable de fréquence cardiaque à associer avec la valeur de paramètre environnemental instantanée et la valeur instantanée de la variable de fréquence cardiaque en relation avec la valeur de référence de la variable de fréquence cardiaque à associer avec la valeur de paramètre environnemental instantanée.
9. Procédé selon la revendication 8, **caractérisé par** la détermination (804), à partir de l'électrocardiogramme d'un utilisateur, d'une pluralité de valeurs de référence de la variable de fréquence cardiaque caractérisant la fréquence cardiaque ;  
la détermination (806) d'une pluralité de valeurs de paramètres environnementaux de différentes amplitudes ;  
l'association (808) des valeurs de référence de la variable de fréquence cardiaque avec les valeurs de paramètres environnementaux de façon à ce que chaque valeur de référence de la variable de fréquence cardiaque soit associée avec la valeur de paramètre environnemental déterminée au moment de la détermination de la valeur de référence de la variable de fréquence cardiaque ; et  
l'enregistrement (810), dans le registre, de chaque valeur de paramètre environnemental et de la valeur de référence de la variable de fréquence cardiaque associée à chaque paramètre environnemental.
10. Procédé selon la revendication 8, **caractérisé par** le démarrage (802) de la détermination des valeurs de référence de la variable de fréquence cardiaque sur la base des valeurs de paramètres environnementaux.
11. Procédé selon la revendication 8, **caractérisé par** la terminaison (812) de la détermination des valeurs de référence de la variable de fréquence cardiaque et de la détermination des valeurs de paramètres environnementaux sur la base des valeurs de paramètres environnementaux.
12. Procédé selon la revendication 8, **caractérisé par** la détermination (710) d'une valeur instantanée d'un paramètre environnemental ;  
l'enregistrement (712) de la valeur instantanée du paramètre environnemental dans un registre ;  
la restauration (716), à partir du registre, de la valeur de référence de la variable de fréquence cardiaque à associer avec la valeur de paramètre environnemental instantanée à l'aide des valeurs de paramètres environnementaux et de la valeur de référence de la variable de fréquence cardiaque associée avec chaque valeur de paramètre environnemental enregistrées dans le registre ; et  
l'affichage (718) de la valeur de paramètre environnemental instantanée et de la valeur de référence de la variable de fréquence cardiaque à associer avec chaque valeur de paramètre environnemental.
13. Produit de logiciel informatique qui comprend des instructions codées permettant d'exécuter un processus informatique dans un ordinateur d'un moniteur de fréquence cardiaque, le processus informatique comprenant :
- la détermination (702), à partir de l'électrocardiogramme d'un utilisateur, d'une valeur de référence d'une variable de fréquence cardiaque caractérisant la fréquence cardiaque ;  
la détermination (704) d'au moins une valeur de paramètre environnemental proportionnelle à la densité de l'air à l'aide d'une mesure d'une variable physique proportionnelle à la densité de l'air ;  
l'association (706) de la valeur de référence de la variable de fréquence cardiaque avec l'au moins une valeur de paramètre environnemental ; et  
l'enregistrement (708), dans un registre, d'au moins une valeur de paramètre environnemental et de la valeur de référence de la variable de fréquence cardiaque associée avec l'au moins une valeur de paramètre environnemental,
- caractérisé en ce que** le processus informatique comprend en outre :
- la détermination (710) d'une valeur instantanée d'un paramètre environnemental ;  
l'enregistrement (712) de la valeur instantanée du paramètre environnemental dans un registre ;  
la détermination (714), à partir de l'électrocardiogramme d'un utilisateur, d'une valeur instantanée de la variable de fréquence cardiaque caractérisant la fréquence cardiaque ;  
la restauration (716), à partir du registre, de la valeur de référence de la variable de fréquence cardiaque à associer avec la valeur de paramètre

tre environnemental instantanée à l'aide des valeurs de paramètres environnementaux et de la valeur de référence de la variable de fréquence cardiaque associée avec chaque valeur de paramètre environnemental enregistrée dans le registre ; et

l'affichage (720) de la valeur de référence de la variable de fréquence cardiaque à associer avec la valeur de paramètre environnemental instantanée et la valeur instantanée de la variable de fréquence cardiaque en relation avec la valeur de référence de la variable de fréquence cardiaque à associer avec la valeur de paramètre environnemental instantanée.

5

10

15

20

25

30

35

40

45

50

55

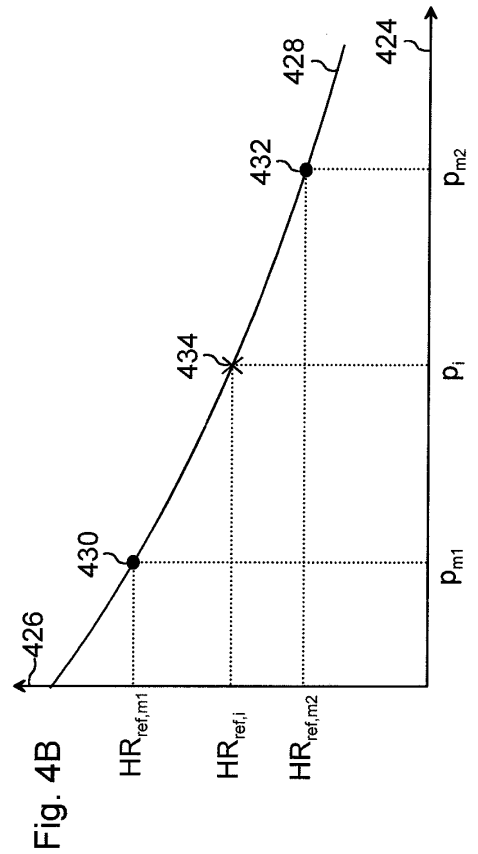
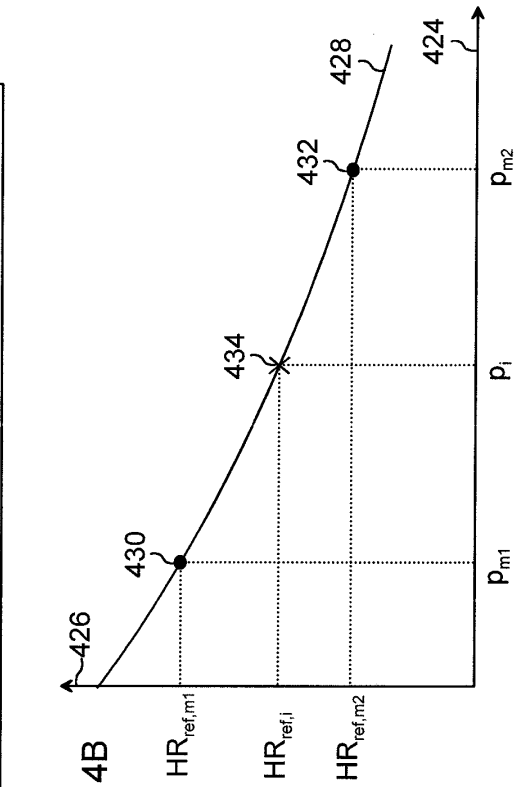
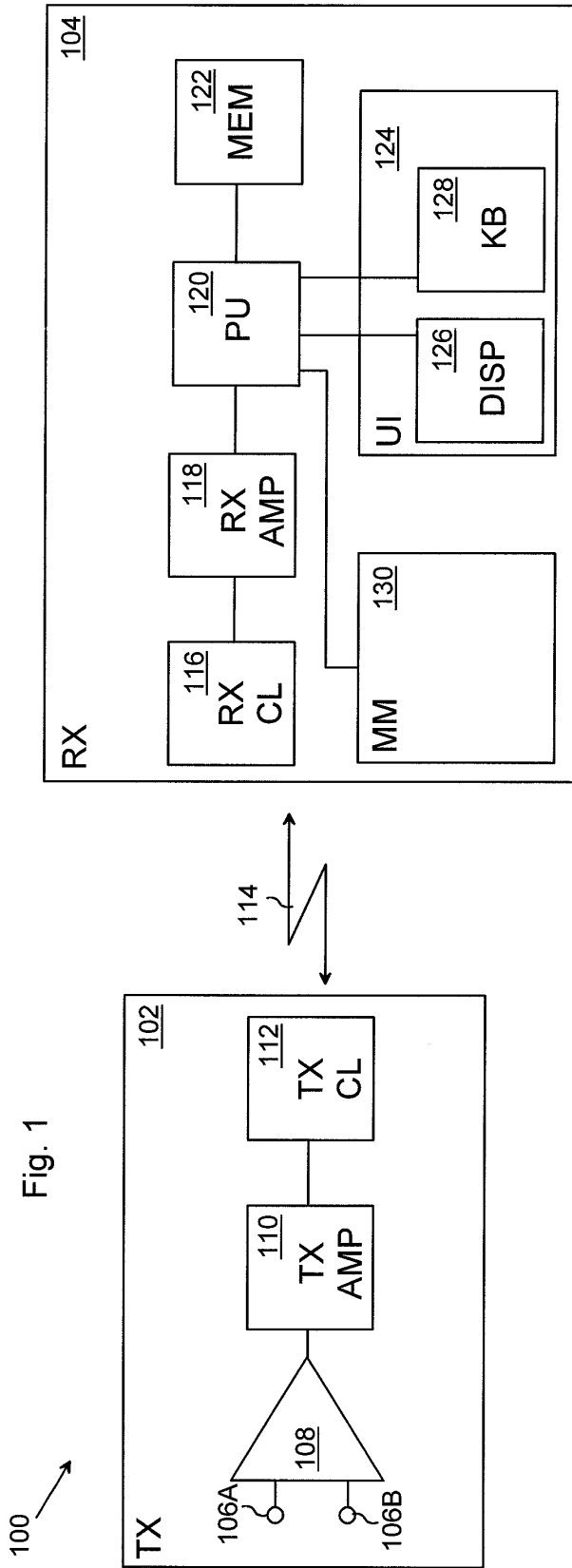

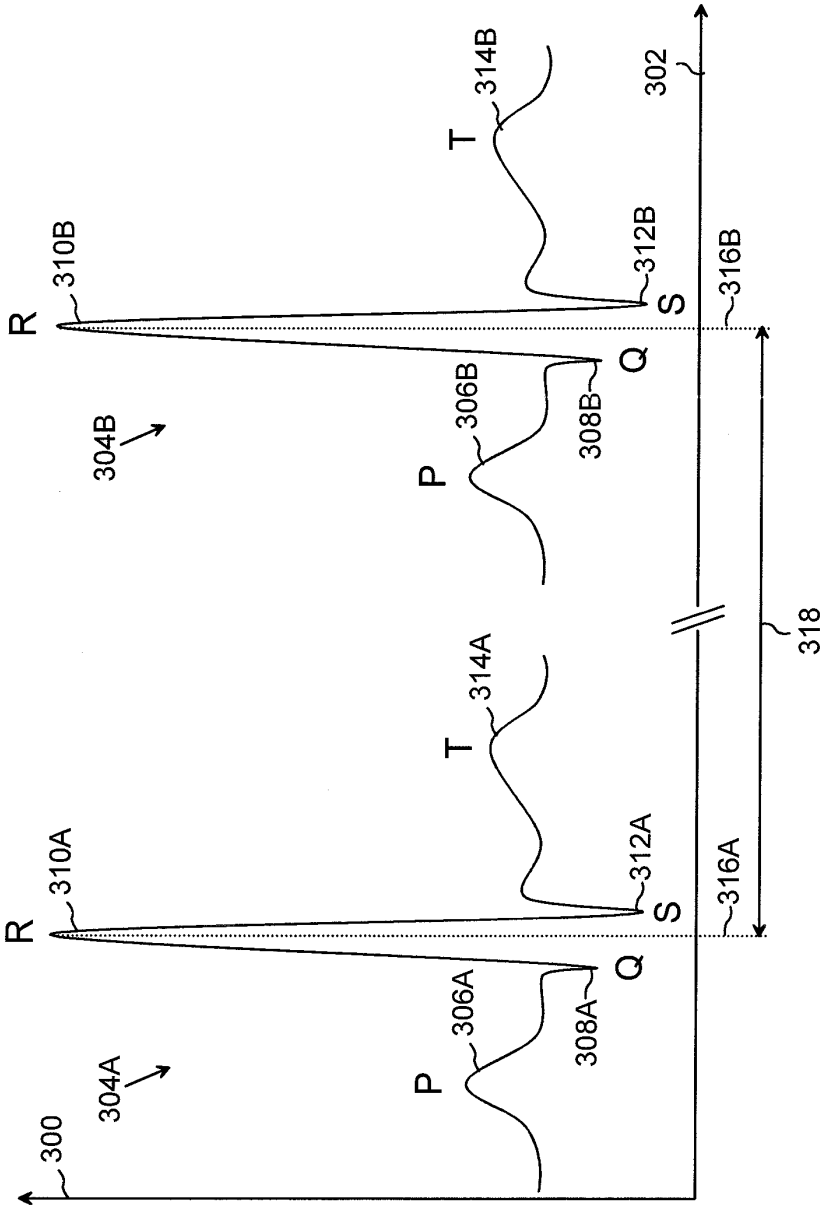

Fig. 3

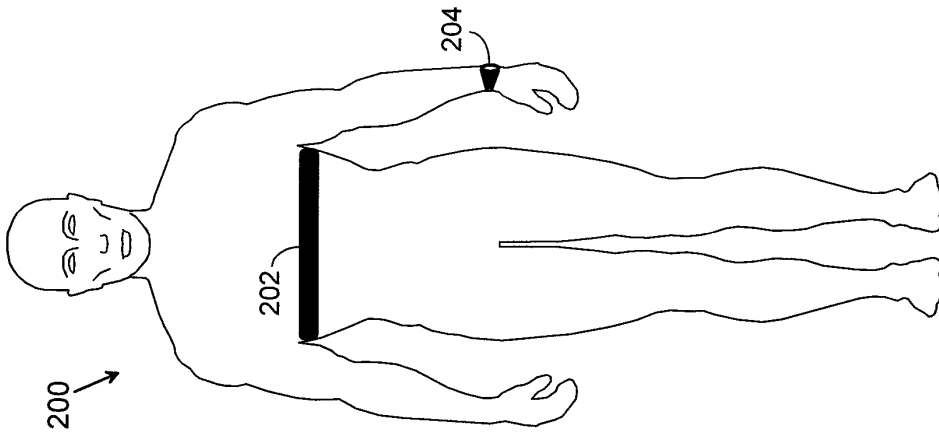

Fig. 2

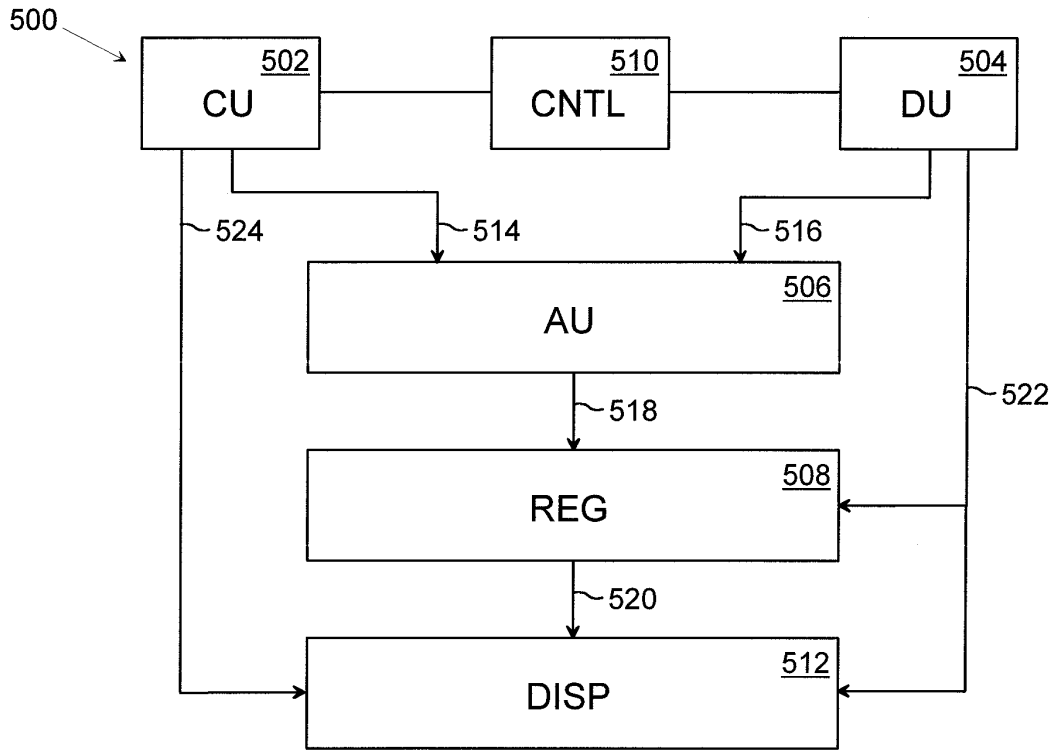

Fig. 5

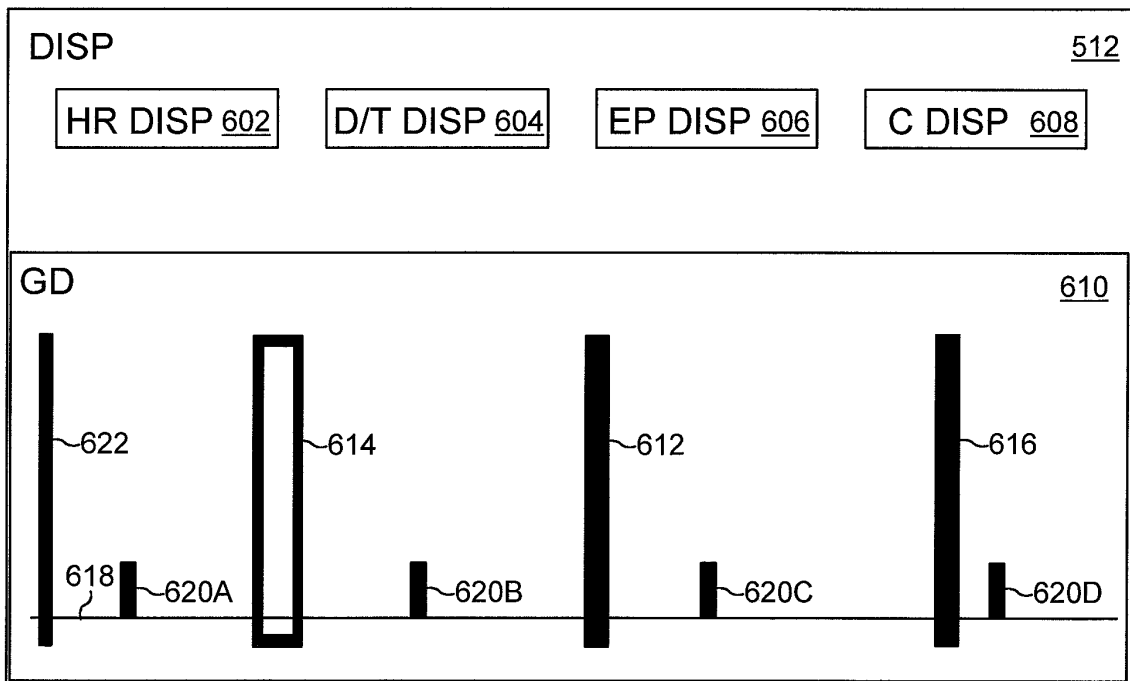

Fig. 6

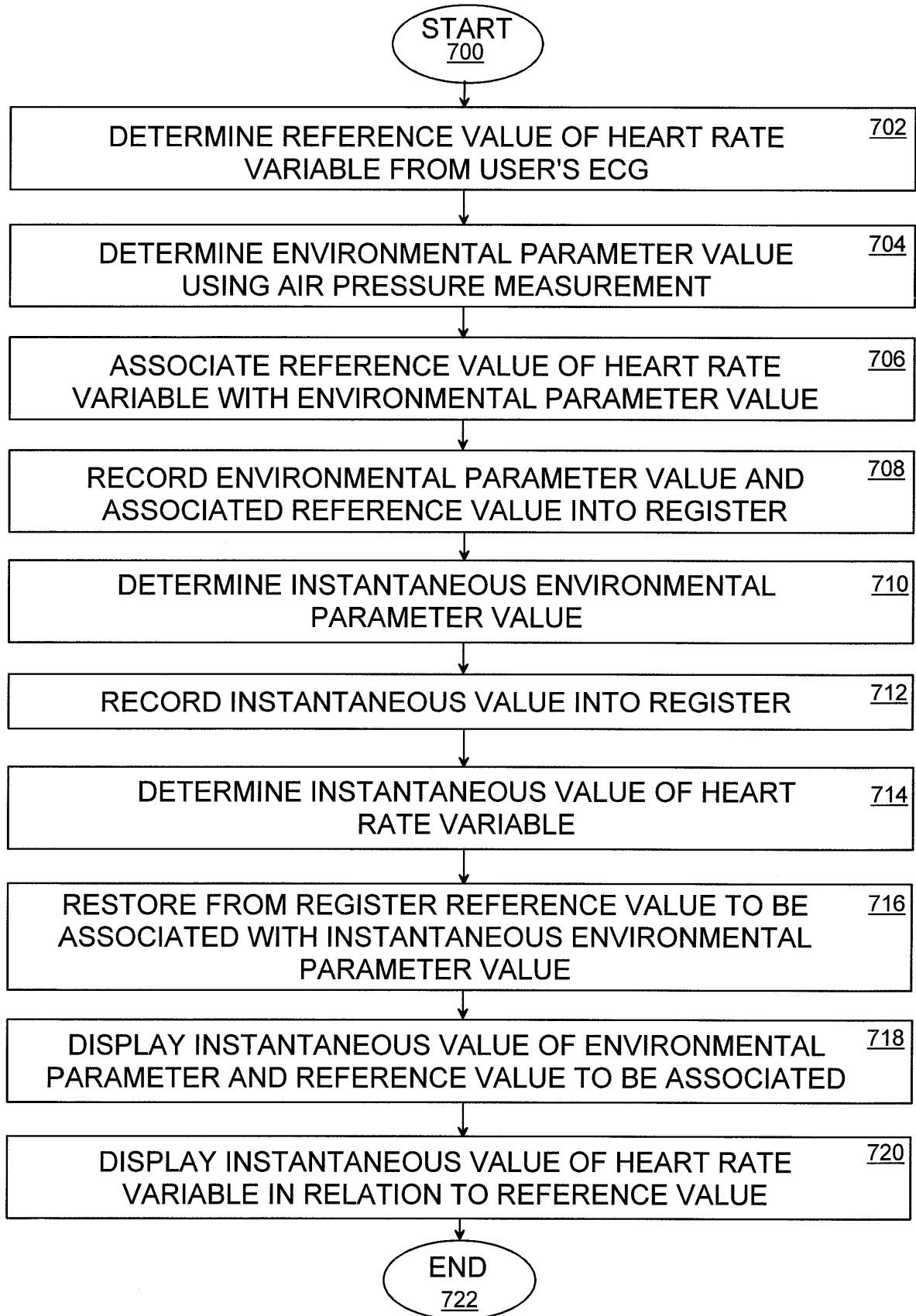

Fig. 7

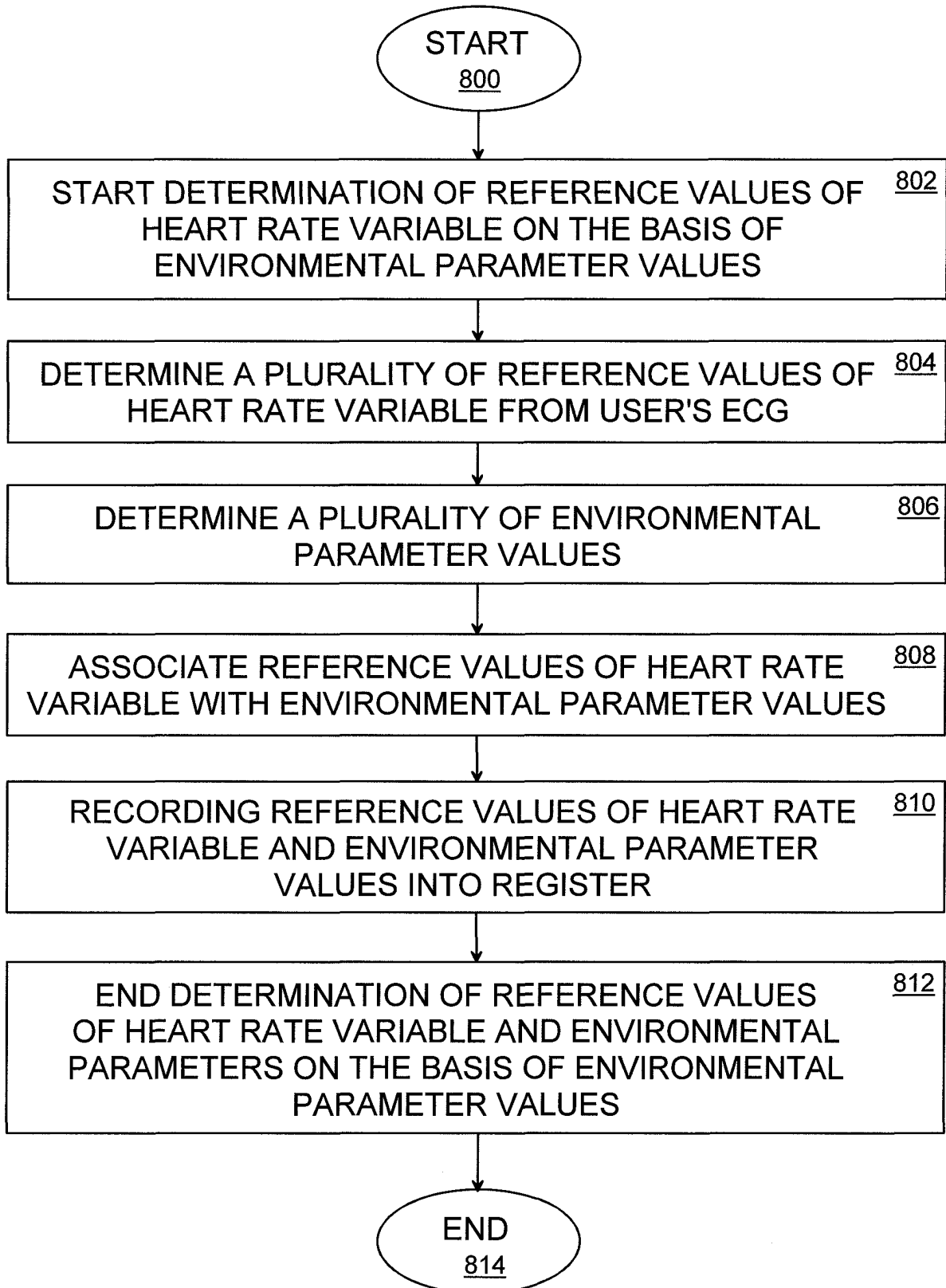

Fig. 8

**REFERENCES CITED IN THE DESCRIPTION**

*This list of references cited by the applicant is for the reader's convenience only. It does not form part of the European patent document. Even though great care has been taken in compiling the references, errors or omissions cannot be excluded and the EPO disclaims all liability in this regard.*

**Patent documents cited in the description**

- WO 02067449 A [0005] [0006]

专利名称(译)	心率监测器，方法和计算机软件产品		
公开(公告)号	<a href="#">EP1647223B1</a>	公开(公告)日	2016-11-02
申请号	EP2005109050	申请日	2005-09-30
[标]申请(专利权)人(译)	博能电子公司		
申请(专利权)人(译)	Polar Electro Oy公司		
当前申请(专利权)人(译)	Polar Electro Oy公司		
[标]发明人	NISSILA SEPPO		
发明人	NISSILÄ, SEPPO		
IPC分类号	A61B5/024 A61B5/00 A61B5/0245 A61B		
CPC分类号	A61B5/02438 A61B5/0002 A61B5/0245 A61B2560/0242		
代理机构(译)	KOLSTER OY AB		
优先权	2004005392 2004-10-15 FI		
其他公开文献	EP1647223A3 EP1647223A2		
外部链接	<a href="#">Espacenet</a>		

摘要(译)

本发明提供一种心率监测器，方法及计算机软件产品。该方法确定

