



(11) **EP 3 536 300 A1**

(12) **EUROPEAN PATENT APPLICATION**  
published in accordance with Art. 153(4) EPC

(43) Date of publication:  
**11.09.2019 Bulletin 2019/37**

(51) Int Cl.:  
**A61J 7/04<sup>(2006.01)</sup> A61B 5/00<sup>(2006.01)</sup>**

(21) Application number: **17866942.0**

(86) International application number:  
**PCT/BR2017/050219**

(22) Date of filing: **03.08.2017**

(87) International publication number:  
**WO 2018/081884 (11.05.2018 Gazette 2018/19)**

(84) Designated Contracting States:  
**AL AT BE BG CH CY CZ DE DK EE ES FI FR GB GR HR HU IE IS IT LI LT LU LV MC MK MT NL NO PL PT RO RS SE SI SK SM TR**  
Designated Extension States:  
**BA ME**  
Designated Validation States:  
**MA MD**

(72) Inventors:  
• **CASTAGNA, Ilene Maria Guimarães de Siqueira**  
**35460-000 Brumadinho (BR)**  
• **CASTAGNA, Marco Túlio Vilaça**  
**35460-000 Brumadinho (BR)**

(30) Priority: **07.11.2016 BR 102016025939**

(74) Representative: **BSB Patentanwälte**  
**Schütte & Engelen Partnerschaft mbB**  
**Am Markt 10**  
**59302 Oelde (DE)**

(71) Applicant: **Lótus Medicina Avançada**  
**39550-000 Belo Horizonte (BR)**

(54) **WEARABLE ELECTROCARDIOGRAPHY (ECG) MONITORING TECHNOLOGY WITH SEALED TANK FOR MEDICATION AND INTEGRATED MEDICAL MONITORING SYSTEM**

(57) The present invention refers to a wearable, individual, customized and different sized technology for men and women, composed of electrodes, conductive track and airtight container for medicines, coupled to one another, and a mini electrocardiogram (ECG) apparatus containing a GSM (Global System Mobile) modem and a GPS (Global Positioning System) or a Bluetooth system which, through a wireless network specification within a personal scope (Wireless Personal Area Networks - PANs) deemed as PAN-type or even WPAN, the electrical signal acquisition begins when the user press the button down. It is in the field of medical, recreational and/or sport applications, aiming at monitoring patients at high cardiovascular risk, being possible to diagnose it as soon as possible, aiming at shortening time to definite treatment of those who present acute coronary syndrome (ACS), acute myocardial infarction (AMI), acute atrial fibrillation-type (AAF) cardiac arrhythmias, and other cardiac arrhythmias or other cardiac pathologies capable to be detected by the electrocardiographic trace. Moreover the invention has tools to analyze a bunch of data - big data analytics and deeplearning - by utilizing artificial intelligence. Finally, the invention also has a module to proper administer the drug contained into the airtight container.

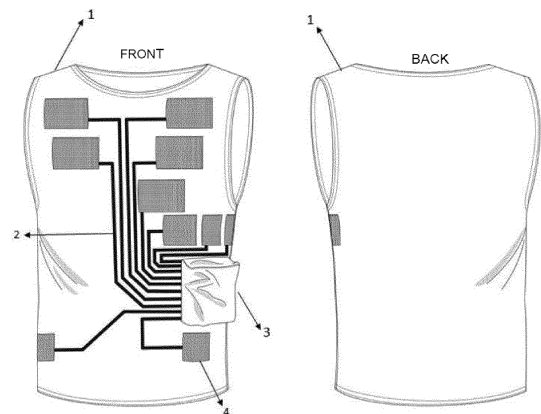

Fig. 4

## Description

**[0001]** The present invention refers to a wearable, individual, customized and different sized technology for men and women, composed of electrodes, electronic circuit and airtight container for medicines, coupled to one another, and a mini electrocardiogram (ECG) apparatus containing a GSM (Global System Mobile) modem and a GPS (Global Positioning System) or a Bluetooth system which, through a wireless network specification within a personal scope (Wireless Personal Area Networks - PANs) deemed as PAN-type or even WPAN, provides a way to connect to and exchange information between the device with the system and the mobile phones (smartphones) utilizing a specific application (app). The acquisition of electrical signals begins when the user presses the button down.

**[0002]** The present invention is in the field of the medical applications, aiming at monitoring patients at high cardiovascular risk, being possible to diagnose it as soon as possible, aiming at shortening time to definite treatment of those who present acute coronary syndrome (ACS), acute myocardial infarction (AMI), acute atrial fibrillation-type (AAF) cardiac arrhythmias, and other cardiac arrhythmias or other cardiac pathologies detectable by electrocardiographic trace, by analyzing a bunch of data - big data analytics and deep learning - by utilizing artificial intelligence, utilizing the internet of things, as well as for recreational and/or sport applications, aiming at monitoring individuals who desire their electrocardiographical trace to be followed up during their physical, recreational or sport activities, being possible to evaluate their performance in a single or evolutionary manner, or even to have their electrocardiogram recorded and written.

**[0003]** The ECG apparatus captures electronic signals by the electrodes, allowing for a remote electrocardiogram monitoring. The data collected by the ECG vest and the location by the GPS are transferred online via GSM or Bluetooth to a user's mobile phone (smartphone), which has an app, and from this app to a data-center having an Integrated Monitoring System (IMS) in a secure and reliable manner, with a 24 x 7 x 365 coverage. The GPS of the ECG apparatus or of the smartphone itself, in the case of transmission via Bluetooth to the smartphone, enables to locate the individual who is wearing electrocardiographical vest. The compartments for medicines are integrated to the electronic circuit of the ECG apparatus, and remotely controlled.

**[0004]** This wearable hardware- and software-integrating device allows for the transmission of low voltage electronic signals through Internet of Things to an integrated monitoring center, as well as create an interface which enables to shorten time since early symptoms that may be a sign of an ACS, or an AMI, or an AAF, or another cardiac arrhythmia, even the definite treatment, which may also anticipate the beginning of treatment, from remote dispensation of the medicines available in the plas-

tic box of medicines coupled to the box of mini ECG.

**[0005]** The coronary artery disease (CAD) is the main cause of death worldwide. The acute myocardial infarction (AMI) is the complete occlusion of coronary artery, vessel that irrigates the cardiac muscle. The best option of treatment is the primary angioplasty: unclogging of the coronary artery through balloon catheter. The earlier the coronary is opened the best will be the result of the treatment, therefore reducing the morbidity and mortality rates. The maximum optimal time among entry of the individual to emergency (door), diagnose and treatment is up to 90 min. The main metric in the treatment of AMI is Door to Balloon time: "D2B", which is the time from patient arrival at emergency to his or her coronary opening by primary angioplasty with a balloon catheter or stent.

**[0006]** It is perceivable the need for the patient to be more autonomous, have information and be capable of using resources such as telehealth, for obtaining analysis, diagnoses and even to begin his or her treatment regardless the location. By means of continuous technological advance and computing and mobile communication facilities, it is proposed to widen the limits of this paradigm D2B in the AMI, the ACS and in the AAF approach, in addition to other cardiac arrhythmias.

**[0007]** All data generated by the technology coupled to the cloth claimed in the present invention is based on monitoring center, hospital network and expert doctor. Through an electronic signal sent by the monitoring center, the doctor responsible for the electrocardiographic trace analysis provides the diagnose and remotely triggers, if necessary, the medicine compartment opening, thereby getting early start the treatment and also reducing time since early symptoms in patient with clogged coronary artery until effective and definite time that is the coronary artery opening by primary angioplasty. The same process may be carried out with regard to cardiac arrhythmia, such as AAF, the symptoms having got started less than 24 to 48 hours, providing a definite treatment with proper medicine dispensing by remote opening of the compartments with medicines as soon as the patient is diagnosed.

**[0008]** Individuals having CAD are instructed to monitor themselves having a support of telemedicine to speed up finding their symptoms. Thus, significantly reducing time from the beginning of symptoms to the coronary opening will occur through a combination of a remote monitoring network that generates reports and supports patients at AMI and ACS risk, getting popular the use of the wearable device. It may also occur with patients presenting AAF-type arrhythmia, from the moment they feel a cardiac rhythm change beginning in a period of time up to 48 hours.

**[0009]** The development of wearable technologies and Internet of Things provide several possibilities of application in healthcare, such as remote monitoring of individuals at cardiovascular risk and seniors. With the available technology, in addition to preventing programs

through educational initiatives, healthcare opportunities may be provided.

**[0010]** Data collected by the ECG vest and its location by the GPS (Global Positioning System) are transferred online via GSM (Global System Mobile) or via Bluetooth coupled to the electrocardiogram apparatus to the smartphone containing an app, and from this one to a data-center with an Integrated Monitoring System (IMS). This IMS will assign the received ECG data to a doctor, who will remotely provide the ECG report by electronic means.

**[0011]** The hospital network and the doctors capable to provide reports of the monitored patients will previously be entered the IMS. When identified AMI or ACS, the team acting on IMS will assist the patient, indicating first procedures and forward names and addresses of nearby hospitals able to take care of the patient. When identified AAF or other cardiac arrhythmias, by the registered doctor, the patient will be instructed to take the specific medicine for this pathology after remote opening of the plastic box containing proper drug by means of an electronic signal.

**[0012]** It was found out documents presenting technologies regarding to clothes with coupled ECG or GSM or GPS or Bluetooth technologies, however, without specific functionality of utilization of the complex monitoring system integrated to the patient, as well as access to the airtight plastic box containing medicines for quick use with remote opening through encrypted digital signature of an expert doctor.

**[0013]** The document Elastic garment for positioning and fixing ECG electrodes (US20160066809) only describes a cloth having position marks and electrodes fixation, and does not describe a fabric providing a tensile strength over body, such that the electrodes are close and tight to the skin. They are horizontally and vertically embroidered by crossing one another, with stainless steel yarns isolated or associated to the silver- or carbon-based dyes or pastes or conductive stretchable textiles over the cloth fabric, so as to form a mesh to widen the surface contacting the underlying skin. Referring to any device containing airtight container for medicines which enables remote dispensing of medicines, in case of specific needs such as ACS, AMI, AAF and other cardiac arrhythmias, for early treatment to these pathologies to get started, is not made.

**[0014]** The document Wearable remote electrophysiological monitoring system (US201302818150) consists of an electrophysiological monitoring system that record ECG data which is coupled to a cloth. It presents a wireless transmitter and controller configured to collect data generated by the ECG, and in the case of a warning issued to a receiver due to any abnormality. The document Multilayered sensor apparatus (WO2012088398) describes only a cloth formed by an interconnected sensor array without, however, demonstrating that these sensors are part of an ECG apparatus for continuous or intermittent monitoring, and no document describes the functionality of remote ECG monitoring in real time, and

does not also make reference to any device containing airtight container for medicines enabling remote dispensing of medicines.

**[0015]** The document Wearable medical treatment device (EP2590710) makes reference to a wearable technology including a cardiac detection electrode, a treatment electrode, an user interface configured to receive information and a sensor configured to sense some abnormal physiological activity. But it neither demonstrates a complete ECG apparatus nor makes reference to any type of a monitoring intermittent or integrated to some system, remote or not. It does not make reference to any remote control device for opening the airtight plastic box containing proper medicines for getting start quick use by means of an encrypted digital signature.

**[0016]** The document ECG method and system for optimal cardiac disease detection (US20070219454) describes a cardiac disease indicator method through electrocardiogram signals from a set of leads fixed to the patient body for detecting and mapping cardiac diseases in the body of an individual, and the document Wireless transmitted electrocardiogram monitoring device (US7412281) only refers to a wireless electrocardiogram monitoring system for monitoring of long-term physical state. Any of the documents makes no reference to a wearable technology with complex functionalities of remote data mapping and transmission to a monitoring center, as well as access to a treatment of cardiac disease, when necessary, by means of opening of an airtight plastic box containing medicines as previously describes.

**[0017]** The documents Apparatus for, and method of, determining the condition of a patient's heart (EP1673010), and Ambulatory physiological evaluation system including cardiac monitoring (WO8902246) describe a vest adapted to be used over the patient upper body, and a system of ambulatory evaluation to monitor the cardiac activities of a patient, but not comprising the whole data intermittent and remote reading integrated monitoring system of the patients having possibility of immediate service and immediate treatment.

**[0018]** In turn, the document Independent non-interfering wearable health monitoring and alert system (CA2839954) describes a cloth with a system including a multi-ECG metering device having alert markers from changes and detection of health abnormality, the yellow level serving as an indicator for a medical check, and the red level serving as an alert to seek for immediately medical help. However, it does not present a specific functionality of utilization of complex monitoring system integrated to the patient, by which warnings are issued to a specific center that trigger a complete remote service, identifying the service location by the apparatus GPS coupled to the cloth, then the responsible doctor will, by remote access and encrypted digital signature, open a airtight plastic box containing medicines for the treatment to immediately get started until an ambulance arrives and the patient is at a properly assisted at a hospital or other

suitable location.

**[0019]** Any documents found out in the state of art describes or alludes similar technology or one that presents performance, efficiency and integration of equipments similar to those of the present invention, as well as complex functionalities of mapping and transmission of remote data to a monitoring center, utilizing artificial intelligence, "deep learning" and big data analytics, as well as access to early treatment of the coronary artery disease, either AMI or ACS, AAF, in a period of time less than 48 hours, or other cardiac arrhythmias, when necessary, by means of opening of the airtight plastic box containing medicines as previously described, by remote transmission of electronic signal, authorized and carried out by the doctor who provides the ECG report.

#### BRIEF DESCRIPTION OF FIGURES

**[0020]** For better understanding on how the "WEARABLE TECHNOLOGY OF ELECTROCARDIOGRAPHIC (ECG) MONITORING WITH AIRTIGHT CONTAINER FOR MEDICINES AND INTEGRATED MEDICAL MONITORING SYSTEM", herein claimed, is constituted, the appended drawings are presented, wherein:

Figure 1 - analog Front-end, responsible for scanning biometric data.

Figure 2 - GPS, responsible for acquiring geographical coordinates.

Figure 3 - CPU and GRPS Module, responsible for processing and transmitting data.

Figure 4 - wearable individual, customized and different sized technology (1), for men and women, composed of conductive track (2) and airtight container for medicines (3), and electrodes (4), coupled to one another, and an electrocardiogram (ECG) apparatus.

Figure 5 - airtight container for medicines, (5) the lower compartment being to fit electronic pieces, (6) the upper compartment being to fit electronic pieces, and (7) medicine compartment.

#### DETAILED DESCRIPTION OF THE TECHNOLOGY

##### DESCRIPTION OF THE CLOTH QUALITY

**[0021]** The cloth (1) is composed of a fabric of polyamide textile yarns 6.6, providing great comfort, lightness, softness, care easiness and functionality. Specifically, yarns are made which may i) offer protection to the skin against harmful effects of sun, ii) have bacteriostatic action, preventing body odor, iii) be biodegradable, allowing the clothes made therefrom to be decomposed less than 3 years, when correctly discarded on landfills.

**[0022]** These fabrics provide a tensile strength over body, such that the electrodes (4) are close and tight to the skin. The cloth electrodes (4) are composed of a conductive track (2) composed of horizontally and vertically

embroidered stainless steel yarns crossing one another over the cloth fabric, in a single manner or associated to silver- and/or carbon-based dye or paste or fabric, so as to form a mesh to widen the surface contacting the underlying skin in a rectangle or square shape about 5 x 5 cm<sup>2</sup> or 5 x 4 cm<sup>2</sup> or 4 x 4 cm<sup>2</sup> or 5 x 6 cm<sup>2</sup> or 6 x 6 cm<sup>2</sup> or 6 x 5 cm<sup>2</sup> or 6 x 4 cm<sup>2</sup>. The electrodes (4) of the cloth composed of stainless steel yarn embroidered in a single manner or associated to a silver- and/or carbon-based dye or paste or fabric has a property of electrical signals conductivity. The "trace" conducting the electrical signal sensed by the embroidered electrodes contacting the skin comprises different yarns resulting from the stainless steel yarns embroidered, associated or not to the silver- and/or carbon-based dye or paste or fabric conducting electrical signal from the embroidered electrode to the connection to the electrocardiographic device. The electrodes (4) of the fabric are composed of stretchable silver- and/or carbon-based conductive pastes, dyes or fabrics to print low voltage electric circuits over elastic films and textile substrates, having excellent stretchability, gripping capability and conductivity. These conductive textiles, dyes or pastes contain an encapsulating stretchable component which is used to protect the low voltage circuit printed onto the elastic film and the substrate textile, since they have an excellent thin and stretchable protection, gripping property and abrasion resistance. This system may be designed to wearable electronic applications that may require repeatedly washing.

**[0023]** The device encompasses the variation of electric potentials generated by electrical activity of the heart. 8 channels are read out, and other 4 channels are generated by means of mathematical calculations. The acquisition of electrical signals get started when the patient presses the button down, 256 points per second being acquired during a span of 15 seconds. Having about more than 8 seconds to set the impedance of each type of skin. The read out values are stored in a NOR memory, until they can be sent to a server by means of a GPRS connection, meanwhile the GPS is get started to synchronize satellites and identify patient location, until coordinates are received or the limit of time is exceeded.

**[0024]** The wearable ECG monitoring technology (1) is individual, customized, is differently sized, and for men and women, in addition to be composed of a hardware, having 12 bypasses and an encompassed software with a feature of GPS access with interface for SIM card for GSM communication or through Bluetooth coupled to the ECG. This system will transmit the electronic signal of the ECG to an Analysis Software Module, generating graphics, thus allowing for a remote electrocardiogram monitoring, with optional function of automatic interpretation, coupled to a high technology of analysis of a bunch of data and utilizing artificial intelligence, big data analytics and deep learning. All data generated by the technology coupled to the cloth claimed in the present invention are based on monitoring center, hospital network and expert doctor.

**[0025]** The capture of the electronic signals by the electrodes allows for a remote monitoring of electrocardiogram, with optional function of automatic interpretation, supported by an expert system, a software of Integrated Monitoring System online that are the interfaces with doctors, hospitals and clients integrating with SMS Broker.

**[0026]** After reading out the signals, the exam is sent to the server along with the coordinates of the place where the device was at the time of sending. If the file is not successfully sent, an error log is stored, and a new attempt is made after a time x, this is repeated until the exam can be submitted to the server. The log will be sent to the remote monitoring center along with the next valid exam. The equipment contains two LEDs and a buzzer to notice the patient the stage of the exam process.

**[0027]** The data collected by the ECG vest and its location by the GPS will be transferred online via GSM or via Bluetooth to the smartphone and from this one to a datacenter with an Integrated Monitoring System (SMI) having a safe and reliable 24 x 7 x 365 coverage. This SMI will assign the received ECG data to a doctor who will immediately provide the ECG report in an electronic manner.

**[0028]** The device is coupled to an airtight compartment (3) containing specific medicines which are essential at the immediate beginning of the treatment of pathologies, such as ACS, AMI, AAF and other cardiac arrhythmias, integrated into the electronic circuit of the ECG apparatus controlled by a solenoid. The patient, the victim of ACS, AMI, FAA and other cardiac arrhythmias, may get the treatment started as soon as the symptom starts and his ECG is remotely done by self-monitoring.

**[0029]** The expert doctor, through an encrypted digital signature, will remotely trigger the opening of the compartment doors containing medicines for proper remote dispensing, according to the diagnosis of the electrocardiographic trace. The server will identify the problem during the analysis, and remotely release access to the drug. The patient will receive a call informing that the drug has been released and, then, can press the button down for 5 seconds. The device, on the other hand, finds out the release file on the server and releases access to the medicine so it can be ingested. The server will have in its database all contacts of registered clients and doctors.

#### FUNCTIONAL DESCRIPTION OF THE CIRCUIT

##### ANALOG FRONT-END (FIGURE 1)

**[0030]** The biometric (analog) data are read out through the input connector J1, the signals pass through a high frequency filter formed by the components: R9, R5, R7, R11, R13, R15, R17, R19, R21, R25, R26, R22, R20, R18, R16, R14, R12, R8, R6, R23, C51, C52, C23, C24, C25, C26, C28, C29, C32, C33, C34, C35, C36, C37, C38, C3, C49, C50, C54, and C55.

**[0031]** The protection against electrostatic discharges at the input of the signals is made by the diodes D1 to

D9, responsible for keeping the levels within the levels accepted by the A/D converter. Signal acquisition is performed by the U4 analog front-end, which consists of 8 24-bit delta-sigma A/D converters. The +2.5-Volt and -2.5-Volt symmetric voltage levels, required for the analog front-end signal levels to be suitable, are generated by the electronic circuits U1, U2 e U3.

##### GPS COORDINATE ACQUISITION MODULE, SIGNALING AND TRIGGERING BUTTON (FIGURE 2)

**[0032]** For the acquisition of geographical coordinate data, a GPS module formed for electronic circuit U1, delivering data to the processing unit in the NMEA 0183 format, having latitude and longitude data, is used. The LED1 and LED2 components are responsible for the operational signaling of the equipment and the key S1 to start up operating.

##### PROCESSING UNIT AND MODULO GPRS MODULE (FIGURE 3)

**[0033]** The circuit is powered by a rechargeable LI-ION battery whose management is the responsibility of the U1 electronic circuit, front-end dedicated battery charger. The electronic circuit U2 aims at regulating the voltage levels to + 3.3 V required for the operation of the other electronic circuits.

**[0034]** Data storage is performed by the electronic circuit U3, non-volatile memory, responsible for recording acquired data for later transmission. The circuit U8 is composed of a solid state relay responsible for the electromagnet triggering in order to release the compartment for medicines, according to the application request. For USB input, there is a protection against outbreaks and electrostatic discharges formed by the circuit U7, a solid-state TVS protection.

**[0035]** The communication via GPRS is carried out by the electronic circuit U6, Quad-Band GSM modem, responsible for sending data to the FTP server. The circuit U5 is composed of a solid state relay, responsible for disconnecting the GPRS Modem when it is not operating.

**[0036]** The connector J6 is a receptacle for GSM SIM-CARD which has its own protection against electrostatic outbreaks carried out by the electronic circuit TVS1. The data processing and treatment are responsibility of the electronic circuit U4, a microcontroller of the ARM family, responsible for executing the application software.

##### INTEGRATION OF MINI ECG-BLUETOOTH AND SMARTPHONE

**[0037]** The device acquires the variation of electrical potentials generated by the electrical activity of the heart. 8 channels are read out, and other 4 channels are generated by means of mathematical calculations. The acquisition of the electrical signals is get started when the user presses the button down. 256 points per second are

acquired, in at most 24 h. About 8 seconds being required to set the impedance of each type of skin. The read out values are stored in a NOR memory until they are sent to a smartphone via Bluetooth communication. There is an application installed on the smartphone to add the timestamp and the acquired GPS coordinate, and submit the exam to the FTP server. It is possible both to see the recorded exam and monitor cardiac signals in real time. If the file is not successfully sent, an error log is stored, and a new attempt is made after a time x, this is repeated until the exam is submitted to the server. The log is sent to the server along with the next valid exam. The hardware is powered by a rechargeable battery of LI-ION. Containing three LEDs and a buzzer to notice the individual on the stage of the exam process and the battery status, a Bluetooth module 4.1 with an antenna, an USB input for programming and configuring the equipment.

**[0038]** The present invention, among all the technological benefits described above, contributes to the immediate diagnosis of symptoms in ACS, AMI, AAF and other cardiac arrhythmias, and allows to dramatically reduce the time between onset of symptoms and the primary angioplasty, definitive treatment of AMI, early initiation of treatment in ACS and AMI and definitive treatment of AAF and other cardiac arrhythmias by proper administration of the drug contained in the airtight compartment (3). The medical and hospital network will have access to the IMS to update data, register new care teams and obtain patient information that is directed to their service. This allows for unbu-reaucracy, agility and avoids time loss in attending to these cardiovascular emergencies, since time is a prime factor in reducing the aggravation of these pathologies, especially when undiagnosed or delayed at the beginning of treatment.

### Claims

1. Wearable electrocardiographic monitoring technology (ecg) with an airtight container for medicines and integrated medical monitoring system **characterized** for being a wearable, washable, recreation, sport and medical use technology (1), composed of electrodes (4), electronic circuit and conductive track (2), and airtight container (3) for specific medicines essential to the treatment of pathologies such as acute coronary syndrome (ACS), acute myocardial infarction (AMI), acute atrial fibrillation (AAF) and other cardiac arrhythmias, coupled to one another, and a mini electrocardiogram apparatus (ECG) containing a GSM (Global System Mobile) modem and GPS (Global Positioning System) or Bluetooth system for connection and information exchange among the devices integrated to a datacenter and a remote monitoring center which monitors patients with increased cardiovascular risk, seniors, amateur and professional athletes, and common individuals, being possible to diagnose and treat it as soon as possible, aiming at shortening time of definite treatment of those who present ACS, AMI, AAF, and other cardiac arrhythmias, and the acquisition of the electrical signals from the ECG automatically starts when the user presses the button down in the box containing the ECG apparatus.
2. Wearable electrocardiographic monitoring technology (ecg) with airtight container for medicines, and integrated medical monitoring system **characterized in that** the airtight container (3) containing specific medicines essential to the beginning of the treatment of pathologies such as ACS, AMI, AF, and other arrhythmias, coupled to the electronic circuit of the ECG apparatus with GSM, GPS or Bluetooth, is controlled by a solenoid and electromechanical system through which the doctor, having an encrypted digital signature, will remotely trigger the door opening of the airtight container containing medicines for proper dispensing after diagnostic confirmation.
3. Wearable electrocardiographic monitoring technology (ecg) with airtight container for medicines, and integrated medical monitoring system **characterized in that** the remote electrocardiogram monitoring with optional feature of automated interpretation of trace is performed by ECG analysis softwares, supported by a doctor and an expert system, an on-line software of Integrated Monitoring System, and a software integrated to the smartphone receiving electronic signals which enable i) that the electronic signals sensed by the electrocardiogram to transmit the trace and to be visible in the smartphone in real time (online), which is enabled by the transmission from the Bluetooth coupled to the electrocardiogram for this smartphone, and ii) the record of this trace over 24 hours.
4. Wearable electrocardiographic monitoring technology (ecg) with airtight container for medicines, and integrated medical monitoring system, according to claims 1, 2, and 3, **characterized** for allowing for self-monitoring of symptoms by the patients with acute coronary syndrome (ACS), acute myocardial infarction (AMI), acute atrial fibrillation (AAF), and other cardiac arrhythmias, and beginning their treatment soon after symptom appears, and their ECG is remotely done.
5. Wearable electrocardiographic monitoring technology (ecg) with airtight container for medicines, and integrated medical monitoring system **characterized in that** the wearable technology (1) is composed of fabric of polyamide textile yarns or any other fabrics like synthetic and expansible rubbers that may i) offer protection to skin against harmful effects of sun, ii) have antibacterial agents for preventing body odor, iii) be biodegradable, allowing the clothes

made therefrom to be decomposed when discarded.

6. Wearable electrocardiographic monitoring technology (ecg) with airtight container for medicines, and integrated medical monitoring system, according to the claim 5, **characterized in that** the electrodes (4) are composed of stainless steel yarns horizontally and/or vertically embroidered one another in a crossed or meshed manner, so as to form a rectangle- or square-shaped mesh to widen the surface of contact with the underlying skin, having conductive properties of electronic signals, or are composed of silver- or carbon-based pastes, dyes or conductive stretchable textiles, regardless or singly associated to the mesh of stainless steel yarns or associated to the silver- or carbon-based dye, pastes or conductive stretchable textiles, in addition to serve to print low voltage electronic circuits over elastic films and textile substrates due to contain an encapsulating stretchable component which is used to protect the low voltage circuit printed onto the elastic film and the substrate textile.
7. Wearable electrocardiographic monitoring technology (ecg) with airtight container for medicines, and integrated medical monitoring system **characterized in that** the data collected by the ECG vest and its location made by GPS will be transferred online via GSM or by integrating Bluetooth with a smartphone having a specific software or application (app) to a datacenter with an Integrated Monitoring System (IMS) in a secure and reliable manner having 24 x 7 x 365 coverage, and this IMS will assign the received ECG data to a doctor, who will immediately provide the users with the ECG report in an electronic or remote manner, indicating the first procedures, allowing for an immediate integration to an emergency hospital service and forwarding to users names and addresses of nearby specialized hospitals.
8. Wearable electrocardiographic monitoring technology (ecg) with airtight container for medicines, and integrated medical monitoring system **characterized in that** the biometric (analog) data are read out through the input connector J1, the signals pass through a high frequency filter formed by the components: R9, R5, R7, R11, R13, R15, R17, R19, R21, R25, R26, R22, R20, R18, R16, R14, R12, R8, R6, R23, C51, C52, C23, C24, C25, C26, C28, C29, C32, C33, C34, C35, C36, C37, C38, C3, C49, C50, C54, and C55.
9. Wearable electrocardiographic monitoring technology (ecg) with airtight container for medicines, and integrated medical monitoring system **characterized in that** the acquisition of the signals is performed by the analog front-end U4, which is composed of several 24-bit delta-sigma A/D converters, and that the +2.5-Volt and -2.5-Volt symmetric voltage levels, required for the analog front-end signal levels to be suitable, are generated by the electronic circuits U1, U2 e U3.
10. Wearable electrocardiographic monitoring technology (ecg) with airtight container for medicines, and integrated medical monitoring system **characterized in that**, for the acquisition of geographical coordinate data, a GPS module is utilized and formed for electronic circuit U1, which delivers data to the processing unit in the NMEA 0183 format having latitude and longitude data, and the components LED1 and LED2 are responsible for the operation signaling of the equipment and the key S1 to begin the operation.
11. Wearable electrocardiographic monitoring technology (ecg) with airtight container for medicines, and integrated medical monitoring system **characterized in that** data storage is performed by the electronic circuit U3, a non-volatile memory responsible for recording data acquired for later transmission, and the circuit U8 is composed of a solid state relay responsible for the electromagnet triggering on in order to release the compartment for medicines, according to the application request for USB input, where there is a protection against outbreaks and electrostatic discharges formed by the circuit U7, a solid-state TVS protection.
12. Wearable electrocardiographic monitoring technology (ecg) with airtight container for medicines, and integrated medical monitoring system **characterized in that** the communication via GPRS is carried out by the electronic circuit U6, Quad-Band GSM modem, responsible for sending data to the FTP server, and the circuit U5 is composed of a solid state relay, responsible for disconnecting the GPRS Modem when it is not operating.
13. Wearable electrocardiographic monitoring technology (ecg) with airtight container for medicines, and integrated medical monitoring system **characterized in that** the connector J6 is the receptacle for GSM SIMCARD which has its own protection against electrostatic outbreaks carried out by the electronic circuit TVS1, and data processing and treatment are responsibility of the electronic circuit U4, a microcontroller of the ARM family, responsible for executing the application software.
14. Wearable electrocardiographic monitoring technology (ecg) with airtight container for medicines, and integrated medical monitoring system **characterized in that** a device acquires 256 points per second and the variation of the electrical potentials generated by the electrical activity in the heart by reading 8

channels, and other 4 by means of mathematical calculations, in a period of time of at most 24 hours, 8 seconds being required to set the impedance for each type of skin.

5

15. Wearable electrocardiographic monitoring technology (ecg) with airtight container for medicines, and integrated medical monitoring system **characterized in that** the smartphone has an application (app) installed to add time stamp and the coordinate acquired from the GPS, and an exam is passed through the FTP server, and it is possible both to see recorded exams and monitor in real time cardiac signals, and if the file is not successfully sent, it is stored into an error log, and a new attempt will be repeatedly carried out until the exam is passed through the server that is sent to the host together with the next valid exam.

10

15

16. Wearable electrocardiographic monitoring technology (ecg) with airtight container for medicines, and integrated medical monitoring system **characterized in that** the hardware is powered by a rechargeable LI-ION battery containing LEDs and a buzzer to notice the patient the stage the exam process is and the battery status, a 4.1 Bluetooth module with the antenna, an USB input for programming and setting the equipment.

20

25

30

35

40

45

50

55

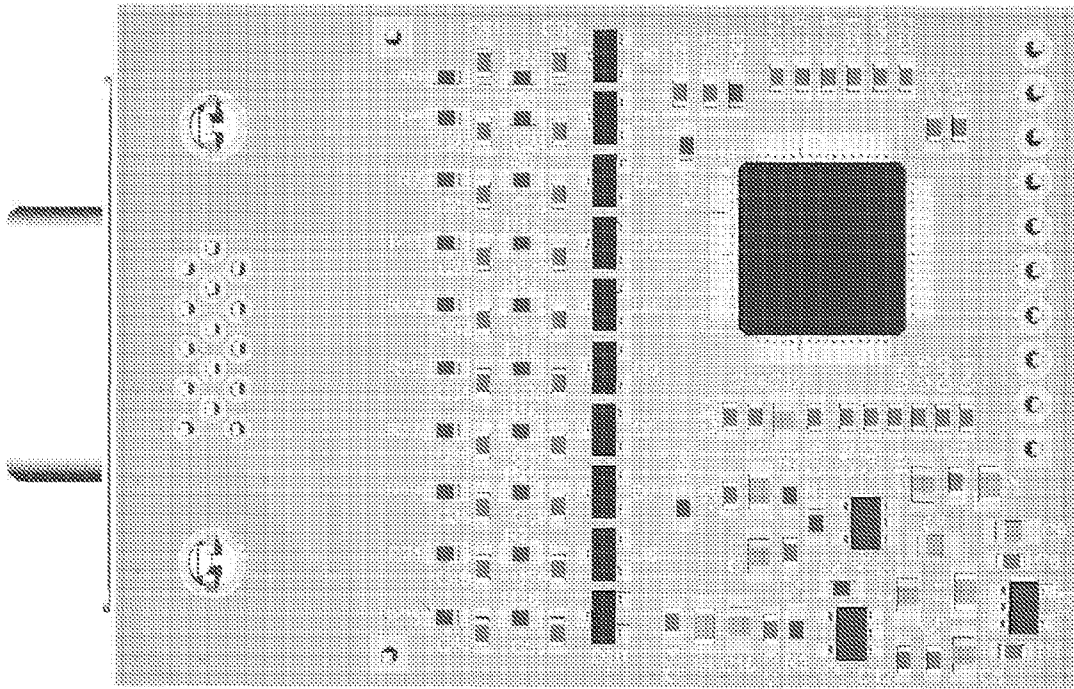

Fig. 1

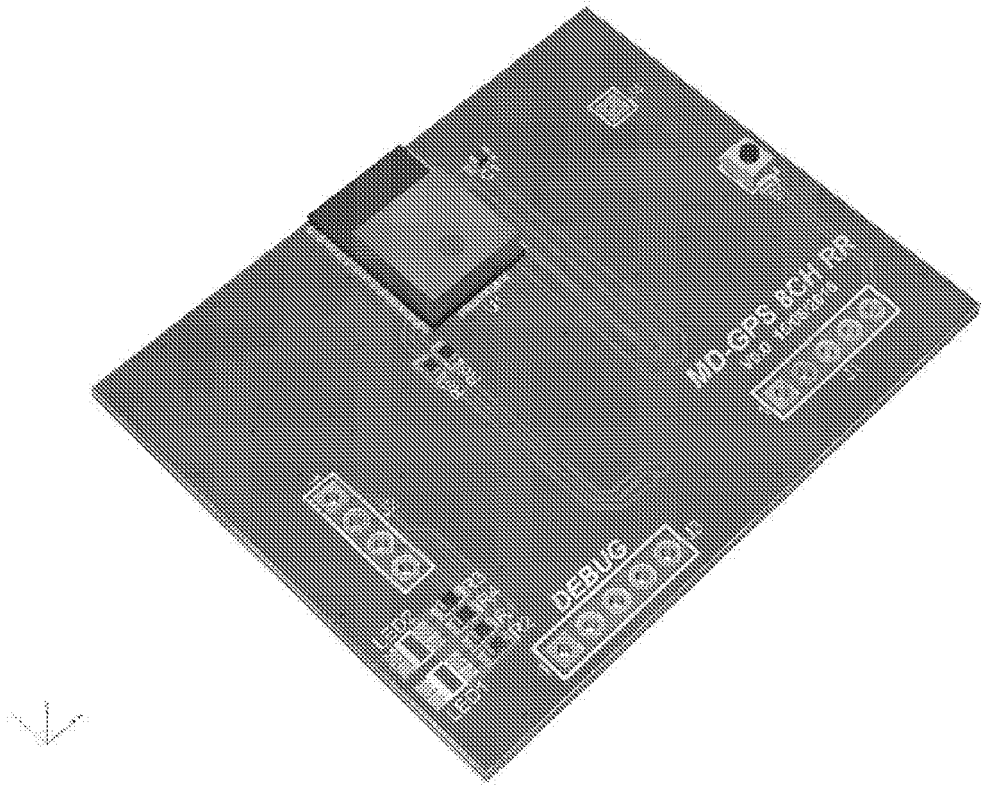

Fig. 2

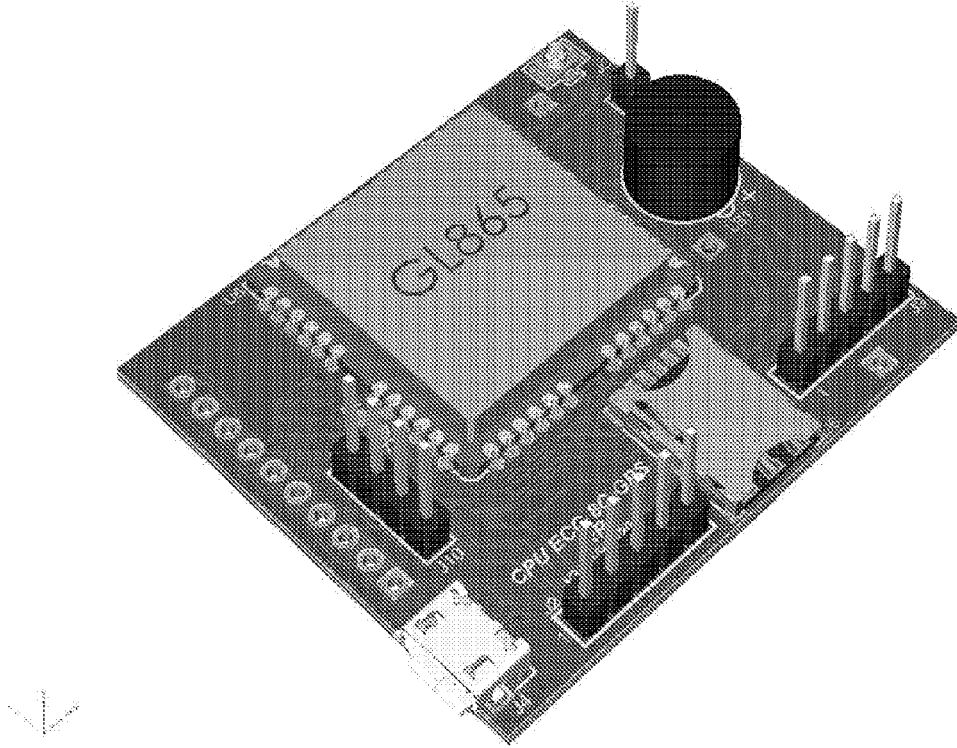

Fig. 3

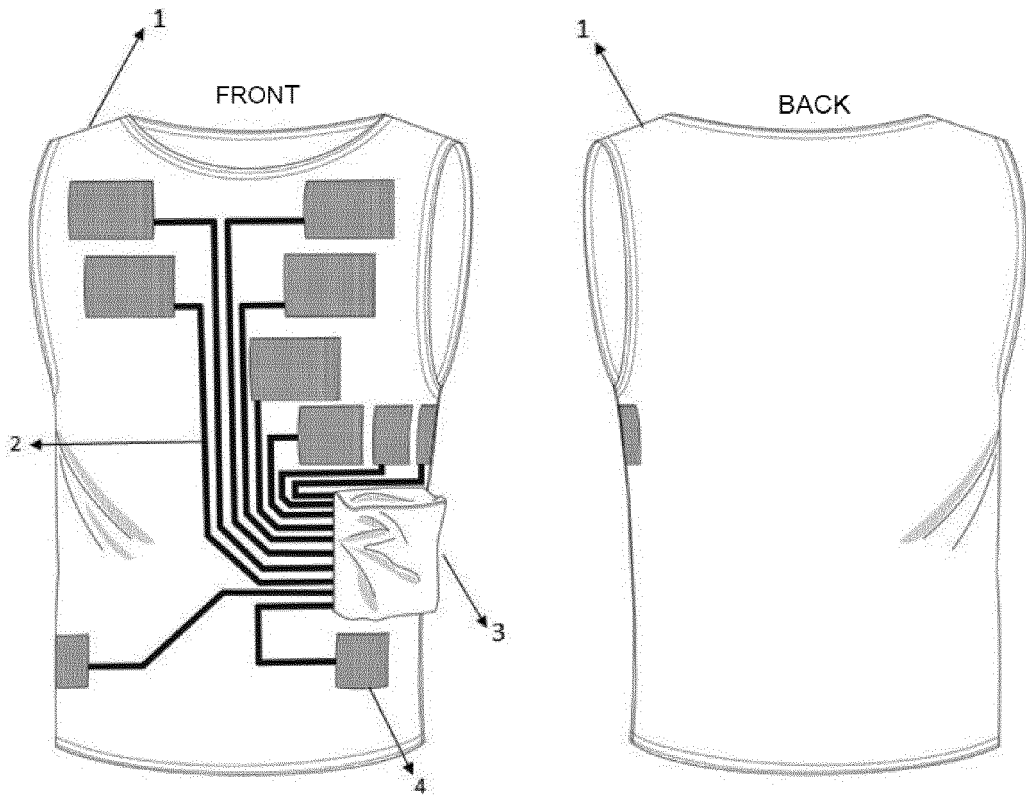

Fig. 4

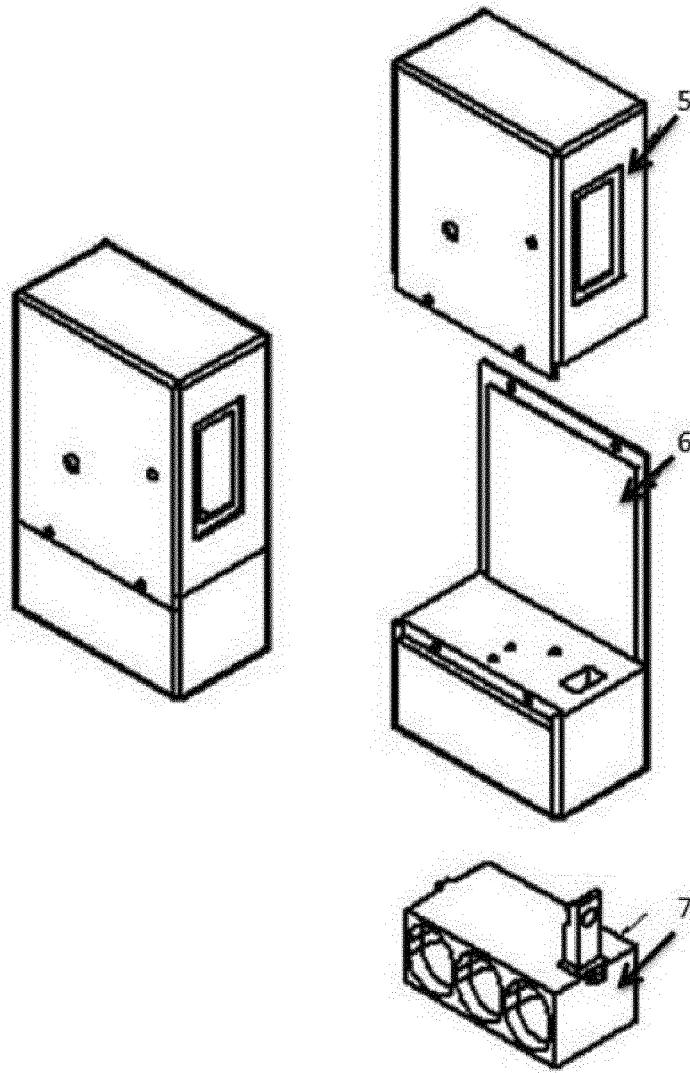

Fig. 5

INTERNATIONAL SEARCH REPORT

International application No.

PCT/BR2017/050219

5

A. CLASSIFICATION OF SUBJECT MATTER  
**A61J7/04 (2006.01), A61B5/00 (2006.01)**  
 According to International Patent Classification (IPC) or to both national classification and IPC

10

B. FIELDS SEARCHED  
 Minimum documentation searched (classification system followed by classification symbols)  
**IPC A61J7/04; A61B5/00**

15

Documentation searched other than minimum documentation to the extent that such documents are included in the fields searched  
 Electronic data base consulted during the international search (name of data base and, where practicable, search terms used)  
**EPODOC (ECG; ADS1298; drug; door; open; compartment; solenoid)**

20

C. DOCUMENTS CONSIDERED TO BE RELEVANT

25

Category*	Citation of document, with indication, where appropriate, of the relevant passages	Relevant to claim No.
Y X	US 2015272464 A1 (GEN HOSPITAL CORP [US]) 01 October 2015 (2015-10-01) (the whole document)	1, 4 3, 7, 12 to 15
Y X	WO 2015179015 A1 (MYLAN INC [US]) 26 November 2015 (2015-11-26) (abstract, par.0083)	1, 4 2
X Y	US 2013281815 A1 (UNIV ARKANSAS [US]) 24 October 2013 (2013-10-24) (abstract, par.0052) (cited by the applicant)	5 6
Y	US 6970731 B1 (GEORGIA TECH RES INST [US]) 29 November 2005 (2005-11-29) (abstract, fig.1,col.3)	6

40

Further documents are listed in the continuation of Box C.  See patent family annex.

45

\* Special categories of cited documents:  
 "A" document defining the general state of the art which is not considered to be of particular relevance  
 "E" earlier application or patent but published on or after the international filing date  
 "L" document which may throw doubts on priority claim(s) or which is cited to establish the publication date of another citation or other special reason (as specified)  
 "O" document referring to an oral disclosure, use, exhibition or other means  
 "P" document published prior to the international filing date but later than the priority date claimed  
 "T" later document published after the international filing date or priority date and not in conflict with the application but cited to understand the principle or theory underlying the invention  
 "X" document of particular relevance; the claimed invention cannot be considered novel or cannot be considered to involve an inventive step when the document is taken alone  
 "Y" document of particular relevance; the claimed invention cannot be considered to involve an inventive step when the document is combined with one or more other such documents, such combination being obvious to a person skilled in the art  
 "&" document member of the same patent family

50

Date of the actual completion of the international search <b>06/Dec/2017</b>	Date of mailing of the international search report <b>07/12/2017</b>
---	---

55

Name and mailing address of the ISA/BR  INSTITUTO NACIONAL DA PROPRIEDADE INDUSTRIAL Rua Sao Bento nº 1, 17º andar cep: 20090-010, Centro - Rio de Janeiro/RJ Facsimile No. <b>+55 21 3037-3663</b>	Authorized officer  <b>Ricardo Affonso Grings Herbert</b> Telephone No. <b>+55 21 3037-3493/3742</b>
--	---

INTERNATIONAL SEARCH REPORT

International application No.  
PCT/BR2017/050219

5

**Box No. II Observations where certain claims were found unsearchable (Continuation of item 2 of first sheet)**

This international search report has not been established in respect of certain claims under Article 17(2)(a) for the following reasons:

10

1.  Claims Nos.:  
because they relate to subject matter not required to be searched by this Authority, namely:

15

2.  Claims Nos.:  
because they relate to parts of the international application that do not comply with the prescribed requirements to such an extent that no meaningful international search can be carried out, specifically:

20

3.  Claims Nos.:  
because they are dependent claims and are not drafted in accordance with the second and third sentences of Rule 6.4(a).

25

**Box No. III Observations where unity of invention is lacking (Continuation of item 3 of first sheet)**

This International Searching Authority found multiple inventions in this international application, as follows:

30

35

1.  As all required additional search fees were timely paid by the applicant, this international search report covers all searchable claims.

2.  As all searchable claims could be searched without effort justifying additional fees, this Authority did not invite payment of additional fees.

40

3.  As only some of the required additional search fees were timely paid by the applicant, this international search report covers only those claims for which fees were paid, specifically claims Nos.:

45

4.  No required additional search fees were timely paid by the applicant. Consequently, this international search report is restricted to the invention first mentioned in the claims; it is covered by claims Nos.:

50

**Remark on Protest**

The additional search fees were accompanied by the applicant's protest and, where applicable, the payment of a protest fee.

The additional search fees were accompanied by the applicant's protest but the applicable protest fee was not paid within the time limit specified in the invitation.

No protest accompanied the payment of additional search fees.

55

INTERNATIONAL SEARCH REPORT

International application No.

PCT/BR2017/050219

5  
10  
15  
20  
25  
30  
35  
40  
45  
50  
55

C (Continuation). DOCUMENTS CONSIDERED TO BE RELEVANT		
Category*	Citation of document, with indication, where appropriate, of the relevant passages	Relevant to claim No.
Y	WO 2012088398 A2 (ARLESS STEVEN G [CA]) 28 June 2012 (2012-06-28) (abstract, par.0031, par.0052, par.0063 e par.0067) (cited by the applicant)	6
Y	US 2016066809 A1 (SUN YONGXIN [US]) 10 March 2016 (2016-03-10) (cited by the applicant)	1
Y	US 6304797 B1 (RAPID PATIENT MONITORING L L C [US]) 16 October 2001 (2001-10-16)	1

Form PCT/ISA/210 (continuation of second sheet) (January 2015)

EP 3 536 300 A1

INTERNATIONAL SEARCH REPORT  
Information on patent family members

International application No.  
PCT/BR2017/050219

5  
10  
15  
20  
25  
30  
35  
40  
45  
50  
55

US 2015272464 A1	2015-10-01	None	
WO 2015179015 A1	2015-11-26	None	
US 2013281815 A1	2013-10-24	US 2013281795 A1 US 2016183835 A1	2013-10-24 2016-06-30
US 6970731 B1	2005-11-29	None	
WO 2012088398 A2	2012-06-28	WO 2012088398 A3 EP 2654556 A2 JP 2014505529 A JP 5740484 B2 US 2013281814 A1 US 9655561 B2	2012-10-11 2013-10-30 2014-03-06 2015-06-24 2013-10-24 2017-05-23
US 2016066809 A1	2016-03-10	None	
US 6304797 B1	2001-10-16	AU 5228799 A CA 2338528 A1 US 6471087 B1 US 2003023146 A1 US 7122005 B2 WO 0006018 A1	2000-02-21 2000-02-10 2002-10-29 2003-01-30 2006-10-17 2000-02-10

**REFERENCES CITED IN THE DESCRIPTION**

*This list of references cited by the applicant is for the reader's convenience only. It does not form part of the European patent document. Even though great care has been taken in compiling the references, errors or omissions cannot be excluded and the EPO disclaims all liability in this regard.*

**Patent documents cited in the description**

- US 20160066809 A [0013]
- US 201302818150 A [0014]
- WO 2012088398 A [0014]
- EP 2590710 A [0015]
- US 20070219454 A [0016]
- US 7412281 B [0016]
- EP 1673010 A [0017]
- WO 8902246 A [0017]
- CA 2839954 [0018]

专利名称(译)	可穿戴式心电图 ( ECG ) 监测技术 , 用于药物密封罐和集成医疗监控系统		
公开(公告)号	<a href="#">EP3536300A1</a>	公开(公告)日	2019-09-11
申请号	EP2017866942	申请日	2017-08-03
[标]发明人	CASTAGNA ILENE MARIA GUIMARAES DE SIQUEIRA CASTAGNA MARCO TULIO VILACA		
发明人	CASTAGNA, ILENE MARIA GUIMARÃES DE SIQUEIRA CASTAGNA, MARCO TÚLIO VILAÇA		
IPC分类号	A61J7/04 A61B5/00		
CPC分类号	A41D13/1281 A61B5/0006 A61B5/02438 A61B5/0245 A61B5/0402 A61J1/03 B65D83/04 G01S19/01 A61B5/0022 A61B5/0024 A61B5/04085 A61B5/04286 A61B5/046 A61B5/4839 A61B5/6805 G16H40 /67 A41D1/005 A41D13/1245 A41D2400/32 A61B5/7465 A61B2562/0209 A61J7/04 G01S19/13		
优先权	102016025939 2016-11-07 BR		
外部链接	<a href="#">Espacenet</a>		

摘要(译)

本发明涉及一种可穿戴的，个性化的，定制的和不同尺寸的男女技术，由电极，导电轨道和用于药物的气密容器组成，彼此耦合，以及包含GSM的全局微型心电图 ( ECG ) 设备。系统移动 ) 调制解调器和GPS ( 全球定位系统 ) 或蓝牙系统，通过个人范围内的无线网络规范 ( 无线个人区域网络 - PAN ) 被视为PAN类型甚至WPAN，电信号采集开始于用户按下按钮。它是在医疗，娱乐和/或运动应用领域，旨在监测高心血管风险的患者，可以尽快诊断它，旨在缩短确定治疗急性冠状动脉综合征患者的时间 ( ACS )，急性心肌梗塞 ( AMI )，急性心房颤动型 ( AAF ) 心律失常，以及能够通过心电图迹线检测的其他心律失常或其他心脏病。此外，本发明具有利用人工智能分析大量数据 - 大数据分析 and 深度学习 - 的工具。最后，本发明还具有适当地管理容纳在气密容器中的药物的模块。

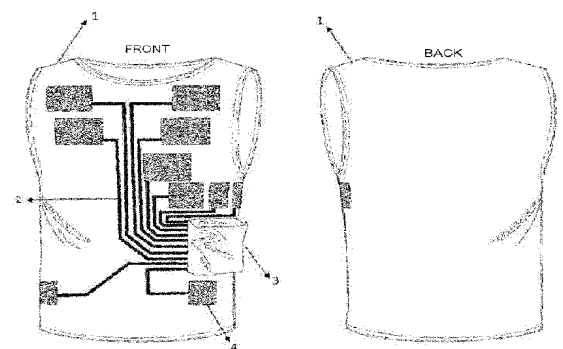

Fig. 4